

Backtracking algorithms for constructing the Hamiltonian decomposition of a 4-regular multigraph *

A. V. Korostil, A. V. Nikolaev

P.G. Demidov Yaroslavl State University

av.korostil@gmail.com, andrei.v.nikolaev@gmail.com

Abstract

We consider a Hamiltonian decomposition problem of partitioning a regular graph into edge-disjoint Hamiltonian cycles. It is known that verifying vertex non-adjacency in the 1-skeleton of the symmetric and asymmetric traveling salesperson polytopes is NP-complete. On the other hand, a sufficient condition for two vertices to be non-adjacent can be formulated as a combinatorial problem of finding a second Hamiltonian decomposition of a 4-regular multigraph. We present two backtracking algorithms for constructing a second Hamiltonian decomposition and verifying vertex non-adjacency: an algorithm based on a simple path extension and an algorithm based on the chain edge fixing procedure.

Based on the results of computational experiments for undirected multigraphs, both backtracking algorithms lost to the known general variable neighborhood search heuristics. However, for directed multigraphs, the algorithm based on chain fixing of edges showed results comparable to heuristics on instances with an existing solution and better results on infeasible instances where the Hamiltonian decomposition does not exist.

Introduction

Hamiltonian decomposition of a regular multigraph is a partition of its edge set into Hamiltonian cycles. The problem of finding edge-disjoint Hamiltonian cycles in a given regular graph finds applications in combinatorial optimization [23], coding theory [5, 6], algorithms for distributed data mining [12], analysis of interconnected networks [18] and other areas. See also theoretical results on estimating the number of Hamiltonian decompositions of regular graphs [16]. In this paper, the problem of constructing a Hamiltonian decomposition arises from the field of polyhedral combinatorics.

1 Traveling salesperson polytope

We consider the classic formulation of the traveling salesperson problem: given a complete weighted graph (or digraph) $K_n = (V, E)$, find a Hamiltonian cycle of minimum weight. Denote by HC_n the set of all Hamiltonian cycles in the graph K_n and assign to each Hamiltonian cycle $x \in HC_n$ the characteristic vector $x^v \in \mathbb{R}^E$ according to the following rule:

$$x_e^v = \begin{cases} 1, & \text{if the cycle } x \text{ contains an edge } e, \\ 0, & \text{otherwise.} \end{cases}$$

*The research is supported by the P.G. Demidov Yaroslavl State University Project VIP-016

Polytope

$$\text{STSP}(n) = \text{conv}\{x^v \mid x \in HC_n\}$$

is called *the symmetric traveling salesperson polytope*.

The asymmetric traveling salesperson polytope $\text{ATSP}(n)$ is defined similarly as the convex hull of the characteristic vectors of all possible Hamiltonian cycles in the complete digraph K_n .

The integer linear programming approach for the traveling salesperson problem was introduced by Dantzig, Fulkerson, and Johnson in their classical work for 49 US cities [14]. State-of-the-art exact algorithms for the traveling salesperson problem are based on a partial description of the facets of the traveling salesperson polytope and the branch and cut method for integer linear programming [2].

The *1-skeleton* of a polytope is a graph whose vertices are the vertices of the polytope and edges are geometric edges (one-dimensional faces). The study of 1-skeleton is of interest, since, on the one hand, some combinatorial algorithms for such problems as perfect matching, set covering, independent set, object ranking, problems with fuzzy measures, and some others are based on the adjacency relation in a 1-skeleton and the local search technique (when we move from the current solution to the «best solution» among adjacent ones) [1, 7, 11, 13, 15]. On the other hand, some characteristics of the 1-skeleton of the problem, such as the diameter and the clique number (the number of vertices in the largest clique), estimate time complexity for various computational models and classes of algorithms [9, 8, 17].

Unfortunately, the classical result by Papadimitriou prevents the study of the 1-skeleton of the traveling salesperson polytope.

Theorem 1 (Papadimitriou [26]). *The question of whether two vertices of the polytopes $\text{STSP}(n)$ or $\text{ATSP}(n)$ are non-adjacent is NP-complete.*

Note that the complementary problem of finding whether two vertices of the 1-skeleton of the traveling salesperson polytope are adjacent is co-NP-complete.

2 Hamiltonian decomposition and sufficient condition for vertex non-adjacency

As a result of Papadimitriou's theorem on the NP-completeness of verifying the vertex non-adjacency in the 1-skeleton of the traveling salesperson polytope, sufficient conditions for non-adjacency are of interest. In particular, polynomial sufficient conditions are known for pyramidal tours [10], pyramidal tours with step-backs [24], and pedigrees [3, 4]. In this paper, we consider the most general of the known – sufficient condition by Rao [28].

Let $x = (V, E_x)$ and $y = (V, E_y)$ be two Hamiltonian cycles on the vertex set V . We denote by $x \cup y$ a *union multigraph* $(V, E_x \cup E_y)$ that contains a copy of each edge of x and y . Note that if two cycles contain the same edge e , then both copies of the edge are added to the multigraph $x \cup y$.

Lemma 2 (Rao [28]). *Given two Hamiltonian cycles x and y , if the union multigraph $x \cup y$ contains two edge-disjoint Hamiltonian cycles z and w different from x and y , then the corresponding vertices x^v and y^v of the traveling salesperson polytope $\text{STSP}(n)$ (or $\text{ATSP}(n)$) are not adjacent.*

From a geometric point of view, the sufficient condition by Rao means that the segment connecting two vertices x^v and y^v intersects the segment connecting two other vertices z^v and w^v of the traveling salesperson polytope, therefore, they cannot be adjacent. An example of a satisfied sufficient condition is shown in Fig. 1.

Thus, verifying the vertex non-adjacency in the 1-skeleton of the traveling salesperson polytope can be reduced to finding a Hamiltonian decomposition of the union multigraph $x \cup y$ that is different from the

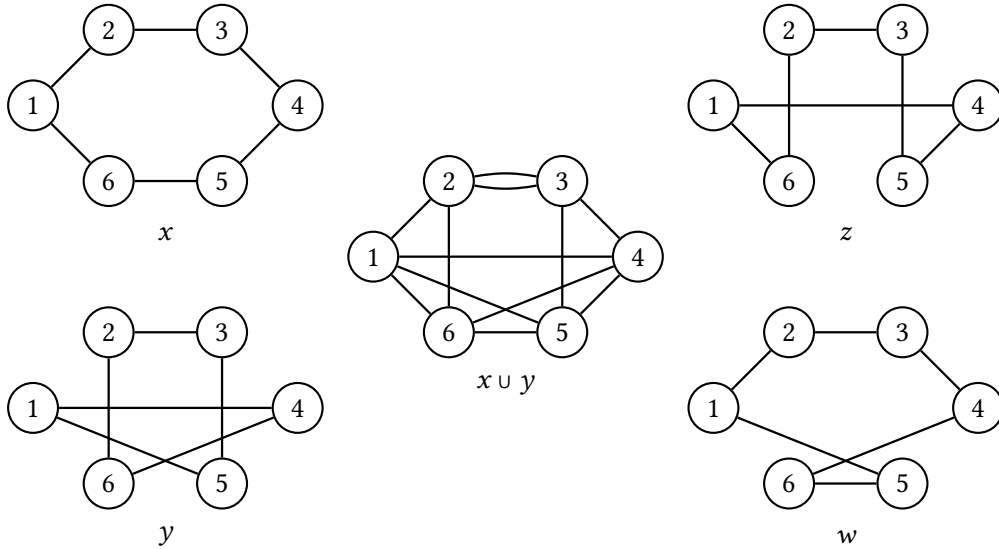

Figure 1: An example of a satisfied sufficient condition for non-adjacency

given one. Let us formulate a sufficient condition for vertex non-adjacency in the form of a combinatorial problem.

Second Hamiltonian decomposition problem.

Instance: let x and y be two Hamiltonian cycles.

Question: does the union multigraph $x \cup y$ contain a pair of edge-disjoint Hamiltonian cycles z and w different from x and y ?

Note that checking whether an arbitrary graph contains a Hamiltonian decomposition is an NP-complete problem already for 4-regular undirected multigraphs and 2-regular directed multigraphs [27].

Previously, the second Hamiltonian decomposition problem and its application to verifying the vertex non-adjacency in the 1-skeletons of the polytopes $STSP(n)$ and $ATSP(n)$ were considered in [22, 25], where several heuristic algorithms were proposed based on constructing vertex-disjoint cycle covers of a graph: simulated annealing and general variable neighborhood search. Heuristic algorithms have proven to be very efficient on instances that have a solution, especially on undirected graphs. However, in instances that do not have a solution, heuristics face significant difficulties. In this paper, we consider two exact backtracking algorithms for constructing the second Hamiltonian decomposition of a 4-regular multigraph.

3 Backtracking algorithm based on simple path extension

Recall that *backtracking* is one of the general methods for finding a solution to a problem by exhaustive search. The procedure consists of a successive extension of a partial solution. If at the next step such an extension fails, then we backtrack to a shorter partial solution and continue the search further [29].

In [21], a backtracking algorithm was presented for the problem of finding a second Hamiltonian decomposition of a 4-regular multigraph based on extending a simple path. Below is a modified version of this algorithm.

Let here and below the partial solution consist of two components z and w . The idea of the algorithm is to sequentially construct a simple path in the component z . Whereas edges not included in z are sent to the component w .

Consider the example of the $x \cup y$ multigraph shown in Fig. 1. Let us construct a partial solution for it, corresponding to the simple path $2 - 3 - 5 - 6$ (Fig. 2). Here, the edges of the z component are solid, and the edges of the w component are dashed. Since the degree of each vertex in the multigraph $x \cup y$ is equal to 4, then we can continue a simple path in z from the vertex 6 in no more than three ways: $(6, 1)$, $(6, 2)$ and $(6, 4)$. Moreover, whichever edge we choose to continue the path, since two edges incident to the vertex 6 have already been added to z , the other two edges can only fall into the component w .

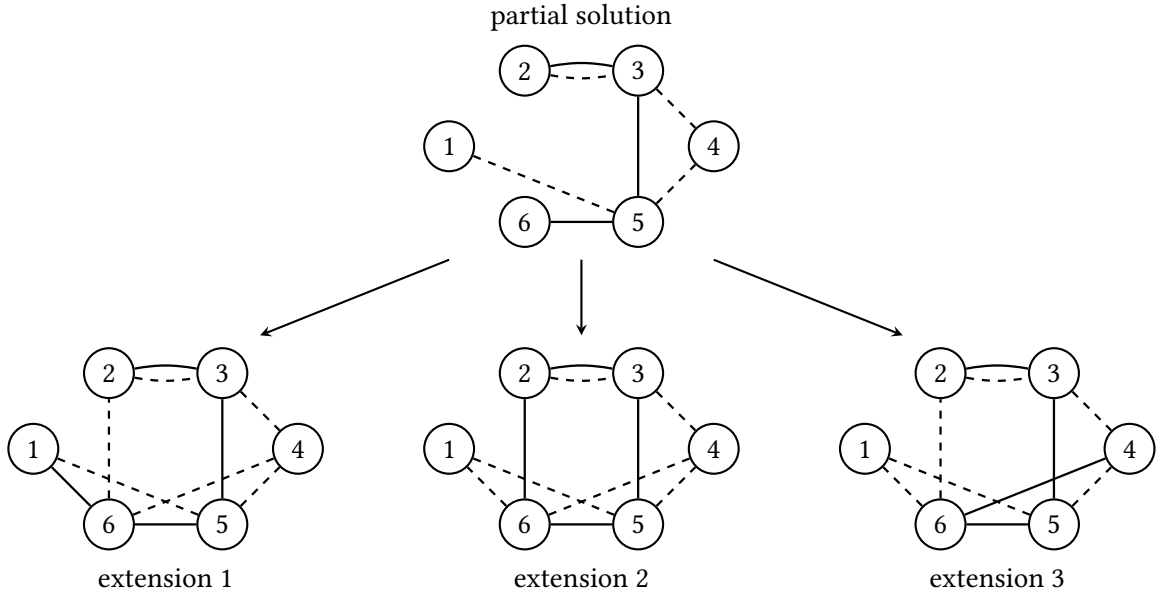

Figure 2: Backtracking based on simple path extension

We sequentially consider all three options and for each we check the correctness of the partial solution:

- extension 1 is invalid because it contains a cycle at vertices 2, 3, 4, 6 in the component w ;
- extension 2 is invalid because it contains a cycle at vertices 2, 3, 5, 6 in the component z ;
- extension 3 is correct.

In the general case, the correctness conditions for a partial solution have the following form:

- z contains a simple path (by construction) or a Hamiltonian cycle;
- w contains a forest (a graph without cycles) with vertex degrees at most 2 or a Hamiltonian cycle.

If the extension of the partial solution turned out to be incorrect, then we backtrack and consider the next option. If all three extensions are invalid, then this partial solution cannot be extended, and we backtrack to a shorter partial solution.

The general scheme for undirected graphs is presented in the Algorithm 1.

The only difference for directed graphs is that the outdegree of each vertex of the multigraph $x \cup y$ is equal to two, hence there are at most two options for extending a simple path in z . All other steps are completely similar.

Algorithm 1 Backtracking based on simple path extension

```
1: procedure Backtracking_Simple_Path( $z, w, (i, j), x \cup y$ )
2:   Add the edge  $(i, j)$  to  $z$ 
3:   if Vertex  $i$  in  $z$  has 2 incident edges then
4:     | Add free edges incident to  $i$  to the component  $w$ 
5:   end if
6:   if partial solution  $z, w$  is not correct then
7:     | return ▷ Backtrack to the previous step
8:   end if
9:   if  $z$  and  $w$  are Hamiltonian cycles (different from  $x$  and  $y$ ) then
10:    | return Hamiltonian decomposition of  $z$  and  $w$  ▷ Solution found
11:  end if
12:  Sort edges  $(j, k)$  from  $j$  in ascending order of free degrees of vertices  $k$ 
13:  for each free edge  $(j, k)$  from the vertex  $j$  do
14:    |  $z, w \leftarrow$  Backtracking_Simple_Path( $z, w, (j, k), x \cup y$ )
15:    | if Hamiltonian decomposition is found then
16:      | return Hamiltonian decomposition of  $z$  and  $w$ 
17:    | end if
18:  end for
19: end procedure

20: procedure Algorithm_Simple_Path( $x \cup y$ )
21:    $z, w \leftarrow \emptyset$ 
22:   Choose an initial edge  $(i, j)$  of the multigraph  $x \cup y$ 
23:    $z, w \leftarrow$  Backtracking_Simple_Path( $z, w, (i, j), x \cup y$ )
24:   if  $z$  and  $w$  are found then
25:     | return The Hamiltonian decomposition  $z$  and  $w$  is found (vertices are not adjacent)
26:   end if
27:   return Hamiltonian decomposition not found (vertices are probably adjacent)
28: end procedure
```

4 Backtracking algorithm based on chain edge fixing

The second backtracking algorithm is based on the chain fixation of edges in the components z and w . Algorithms for directed and undirected graphs are slightly different, so we describe them separately.

4.1 Directed multigraphs

We consider a directed 2-regular multigraph $x \cup y$ for which the indegrees and outdegrees of each vertex are equal to two. Let us choose some edge (i, j) and fix it in the component z , then the second edge (i, k) outgoing from i and the second edge (h, j) incoming into j cannot get into z . We will fix these edges in w (Fig. 3).

The main idea of the algorithm is that the edges (i, k) and (h, j) fixed in w , in turn, start recursive chains of fixing edges in z , and so on.

As an example, consider the directed 2-regular multigraph shown in Fig. 4. Note that the multigraph contains two copies of the edge $(2, 3)$. Multiple edges cannot get into the same Hamiltonian cycle, so we fix one copy each in z and w . Let's choose some edge, for example $(1, 2)$, and fix it in the z component (solid edges), then:

1. edge $(1, 2)$ is fixed in z , hence edges $(1, 4)$ and $(6, 2)$ go to w (dashed edges);

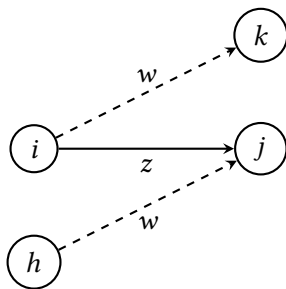

Figure 3: Fixing the edge (i, j) to z

2. edge $(1, 4)$ is fixed in w , hence edge $(3, 4)$ goes to z , edge $(6, 2)$ is fixed in w , hence edge $(6, 1)$ goes to z ;
3. edge $(3, 4)$ is fixed in z , hence edge $(3, 5)$ goes to w , edge $(6, 1)$ is fixed in z , hence edge $(5, 1)$ goes to w ;
4. edge $(3, 5)$ is fixed in w , hence edge $(4, 5)$ goes to z , edge $(5, 1)$ is fixed in w , hence edge $(5, 6)$ goes to z .

At the output, given only one edge $(1, 2)$ fixed in z , we obtain unique Hamiltonian cycles z and w (Fig. 4). Considering that the edge $(1, 2)$ must belong to at least one Hamiltonian cycle, this 2-regular directed multigraph contains a unique Hamiltonian decomposition, which was found.

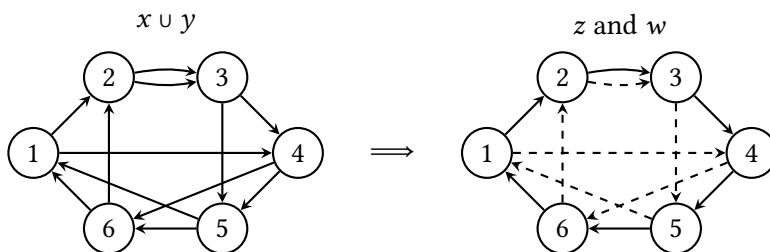

Figure 4: The result of fixing the edge $(1, 2)$ in z

The general backtracking scheme for directed multigraphs is given in the pseudocode of the Algorithm 2.

At the data preprocessing step (line 28, Algorithm 2), we find all multiple edges in the multigraph $x \cup y$ and fix one copy in z and w , since these edges cannot get into the same Hamiltonian cycle.

A partial solution is considered correct if the components z and w are directed acyclic graphs with indegrees and outdegrees at most one or directed Hamiltonian cycles. By construction, the indegrees and outdegrees of vertices in z and w cannot be equal to two, so to check the correctness it suffices to verify that there are no non-Hamiltonian cycles.

In contrast to the backtracking algorithm based on the simple path extension (Algorithm 1), we choose the vertex i' to extend the partial solution (line 18, Algorithm 2) in such a way that the chain edge fixing starts from both head and tail of the edge (i', j') . The more edges are fixed at one step, the smaller the recursion depth will be.

Note that we do not branch when choosing and fixing the first free edge (i, j) (line 29, Algorithm 2), since this edge must get into one of the solution components. Let's call the component z the one that contains the edge (i, j) .

It should also be noted that although the procedure `Chain_Edge_Fixing_Directed` (lines 1-9, Algorithm 2) at each step calls up to two of its subroutines, the total complexity is linear ($O(V)$) since each edge can be fixed at most once, and $|E| = 2|V|$.

Algorithm 2 Backtracking based on chain edge fixing for directed graphs

```
1: procedure Chain_Edge_Fixing_Directed( $((i, j)$  in  $z$ ) ▷ Recursive edge fixing
2:   Fix the edge  $(i, j)$  in  $z$ 
3:   if edge  $(i, k)$  is not fixed then
4:     | Chain_Edge_Fixing_Directed( $((i, k)$  in  $w$ )
5:   end if
6:   if edge  $(h, j)$  is not fixed then
7:     | Chain_Edge_Fixing_Directed( $((h, j)$  in  $w$ )
8:   end if
9: end procedure

10: procedure Backtracking_Chain_Edge_Fixing_Directed( $z, w, (i, j), x \cup y$ )
11:   Chain_Edge_Fixing_Directed( $((i, j)$  in  $z$ )
12:   if  $z$  and  $w$  are Hamiltonian cycles (different from  $x$  and  $y$ ) then
13:     | return  $z$  and  $w$  ▷ Solution is found
14:   end if
15:   if  $z$  or  $w$  contains a non-Hamiltonian cycle then ▷ Partial solution is incorrect
16:     | return ▷ Backtrack to the previous step
17:   end if
18:   Select vertex  $i'$  with free outgoing edges
19:   for each free edge  $(i', j')$  outgoing from the vertex  $i'$  do
20:     |  $z, w \leftarrow$  Backtracking_Chain_Edge_Fixing_Directed( $z, w, (i', j'), x \cup y$ )
21:     | if Hamiltonian decomposition is found then
22:       | return Hamiltonian decomposition  $z$  and  $w$ 
23:     | end if
24:   end for
25: end procedure

26: procedure Algorithm_Chain_Edge_Fixing_Directed( $x \cup y$ )
27:    $z, w \leftarrow \emptyset$ 
28:   Find multiple edges in  $x \cup y$  and fix one copy in  $z$  and  $w$ 
29:   Choose a free edge  $(i, j)$  of the multigraph  $x \cup y$ 
30:    $z, w \leftarrow$  Backtracking_Chain_Edge_Fixing_Directed( $z, w, (i, j), x \cup y$ )
31:   if  $z$  and  $w$  are found then
32:     | return The Hamiltonian decomposition of  $z$  and  $w$  is found (vertices are not adjacent)
33:   end if
34:   return Hamiltonian decomposition not found (vertices are probably adjacent)
35: end procedure
```

4.2 Undirected multigraphs

The pseudo-code of the algorithm for undirected multigraphs is presented in Algorithm 3.

Algorithm 3 Backtracking based on chained edge fixing for undirected graphs

```

1: procedure Chain_Edge_Fixing_Undirected( $(i, j)$  in  $z$ )
2:   Fix the edge  $(i, j)$  in  $z$ 
3:   if vertex  $i$  in  $z$  is incident with 2 fixed edges then
4:     | Chain_Edge_Fixing_Undirected( $(i, k)$  in  $w$ )           ▷ Fix two other edges in  $w$ 
5:     | Chain_Edge_Fixing_Undirected( $(i, h)$  in  $w$ )
6:   end if
7:   if vertex  $j$  in  $z$  is incident with 2 fixed edges then
8:     | Chain_Edge_Fixing_Undirected( $(j, k)$  in  $w$ )           ▷ Fix two other edges in  $w$ 
9:     | Chain_Edge_Fixing_Undirected( $(j, h)$  in  $w$ )
10:  end if
11: end procedure

12: procedure Backtracking_Chain_Edge_Fixing_Undirected( $z, w, (i, j), x \cup y$ )
13:   Chain_Edge_Fixing_Undirected( $(i, j)$  in  $z$ )
14:   if  $z$  and  $w$  are Hamiltonian cycles (different from  $x$  and  $y$ ) then
15:     | return  $z$  and  $w$                                        ▷ Solution is found
16:   end if
17:   if  $z$  or  $w$  contains a non-Hamiltonian cycle then           ▷ Partial solution is incorrect
18:     | return                                                 ▷ Backtrack to the previous step
19:   end if
20:   Choose a vertex  $i$  with the minimum degree  $d$  of free edges
21:   Sort edges  $(i, j_k)$  incident to  $i$  in ascending order of free powers  $j_k$ 
22:   for  $k \leftarrow 1$  to  $d$  do
23:     |  $z, w \leftarrow$  Backtracking_Chain_Edge_Fixing_Undirected( $z, w, (i, j_k), x \cup y$ )
24:     | if Hamiltonian decomposition is found then
25:       | return Hamiltonian decomposition  $z$  and  $w$ 
26:     | end if
27:   end for
28: end procedure

```

The chain edge fixing procedure is triggered as soon as 2 edges are incident to a vertex in one of the partial solutions, then the other two edges are sent to another partial solution (lines 3-10, Algorithm 3).

A partial solution is considered correct if the components z and w are forests with vertex degrees at most two or Hamiltonian cycles. By construction, we add to z and w one edge at a time. Moreover, as soon as the degree of some vertex in one of the components becomes equal to two, then the two remaining edges are sent to another component. Thus, to check the correctness of a partial solution, it suffices to verify that z and w do not contain non-Hamiltonian cycles.

Note that at each step, to expand the partial solution, we choose a vertex i with the minimum degree over free edges in order to reduce the branching factor of the recursion. Edges incident to i are considered in ascending order of degrees of adjacent vertices along free edges (lines 20-27, Algorithm 3).

4.3 Vertex adjacency and data preprocessing

Let's note that the algorithms considered in this paper were developed for the problem of constructing a Hamiltonian decomposition of a 4-regular multigraph $x \cup y$. The algorithms refer directly to the cycles x and y only when checking that the second decomposition z and w is different from the original one. If we omit

this check, then we get algorithms for constructing a Hamiltonian decomposition without any reference to polyhedral combinatorics. Otherwise, if we are interested in exactly the adjacency of vertices in the 1-skeleton of the traveling salesperson polytope, then we can strengthen the considered algorithms by adding a data preprocessing step and checking the known polynomial sufficient conditions for non-adjacency: pyramidal tours [10], pyramidal tours with step-backs [24], pedigrees [3, 4], etc.

5 Computational experiments

The algorithms were tested on random directed and undirected 4-regular multigraphs. For each graph size, 100 pairs of random permutations with a uniform probability distribution were generated using the Fisher-Yates shuffle algorithm [20].

For comparison, we chose 3 algorithms:

- backtracking based on simple path extension (BSP);
- backtracking based on chain edge fixing (BCEF);
- general variable neighborhood search (GVNS) heuristic algorithm from [25], which is a modification of the simulated annealing algorithm [22] and is based on constructing a vertex-disjoint cycle covers by reduction to perfect matching and several cycle merging operations.

Backtracking algorithms are implemented in Python, for the general variable neighborhood search heuristics, a ready-made implementation in Node.js [25] is taken. Computational experiments were carried out on an Intel(R) Core(TM) i5-4460 machine with a 3.20GHz CPU and 16GB RAM.

The results of computational experiments for undirected graphs are presented in the Table 1 and in Fig. 5. Results for directed graphs are presented in Table 2 and in Fig. 6 and Fig. 7.

For each set of 100 tests, the average running time of the algorithms in seconds is given separately for feasible and infeasible instances. For two backtracking algorithms (BSP and BCEF), a time limit of 2 hours was set for each set of 100 test problems. Accordingly, the tables indicate how many instances out of 100 the algorithm managed to solve in 2 hours. The general variable neighborhood search heuristics (GVNS) was set to a limit of 1 minute per instance. This is because the heuristic algorithm has a one-sided error. If the algorithm finds a solution, then the instance is feasible. However, the heuristic algorithm cannot guarantee that the problem is infeasible, only that the solution is not found in a given time or number of iterations.

It is known that random undirected regular graphs have a Hamiltonian decomposition with a very high probability [19]. Indeed, for all test problems on undirected multigraphs (Table 1), there was a second Hamiltonian decomposition into cycles different from the original ones, and the vertices of the traveling salesperson polytope were not adjacent. From a geometric point of view, this means that the degrees of vertices in a 1-skeleton are much less than the total number of vertices, so two random vertices are not adjacent with a high probability.

According to the computational results for undirected Hamiltonian cycles, both backtracking algorithms lost out to the general variable neighborhood search heuristics (GVNS). In the allotted time, the algorithm based on simple path extension (BSP) solved 709 instances, the algorithm based on chain edge fixing (BCEF) solved 1486 instances, and the general variable neighborhood search (GVNS) solved all 1500 out of 1500 instances. GVNS was on average 13 times faster than BCEF and 640 times faster than BSP. Among the two backtracking algorithms, the chain edge fixing (BCEF) algorithm proved to be significantly more efficient, solving all test instances up to 3072 vertices and showing the running time on the solved problems on average 48 times faster than the simple path construction (BSP).

The computational results for directed multigraphs (Table 2, Fig. 6 and 7) turned out to be fundamentally different. Only about 20% of random instances were feasible. Note that this does not mean that the

Table 1: Computational results for 100 random undirected Hamiltonian cycles

V	BSP				BCEF				GVNS			
	Feasible		Infeasible		Feasible		Infeasible		Feasible		«Infeasible»	
	N	time (s)	N	times (s)	N	time (s)	N	time (s)	N	time (s)	N	time (s)
32	100	0.030	-	-	100	0.015	-	-	100	0.001	-	-
48	100	0.151	-	-	100	0.032	-	-	100	0.002	-	-
64	100	0.154	-	-	100	0.052	-	-	100	0.003	-	-
96	100	0.908	-	-	100	0.09	-	-	100	0.007	-	-
128	100	3.045	-	-	100	0.157	-	-	100	0.012	-	-
192	100	4.257	-	-	100	0.22	-	-	100	0.023	-	-
256	100	19.625	-	-	100	0.487	-	-	100	0.033	-	-
384	9	80.037	-	-	100	1.278	-	-	100	0.079	-	-
512	0	-	-	-	100	2.447	-	-	100	0.121	-	-
768	0	-	-	-	100	3.591	-	-	100	0.272	-	-
1024	0	-	-	-	100	6.305	-	-	100	0.468	-	-
1536	0	-	-	-	100	8.799	-	-	100	1.011	-	-
2048	0	-	-	-	100	18.499	-	-	100	1.821	-	-
3072	0	-	-	-	100	45.542	-	-	100	3.852	-	-
4096	0	-	-	-	86	82.973	-	-	100	7.768	-	-

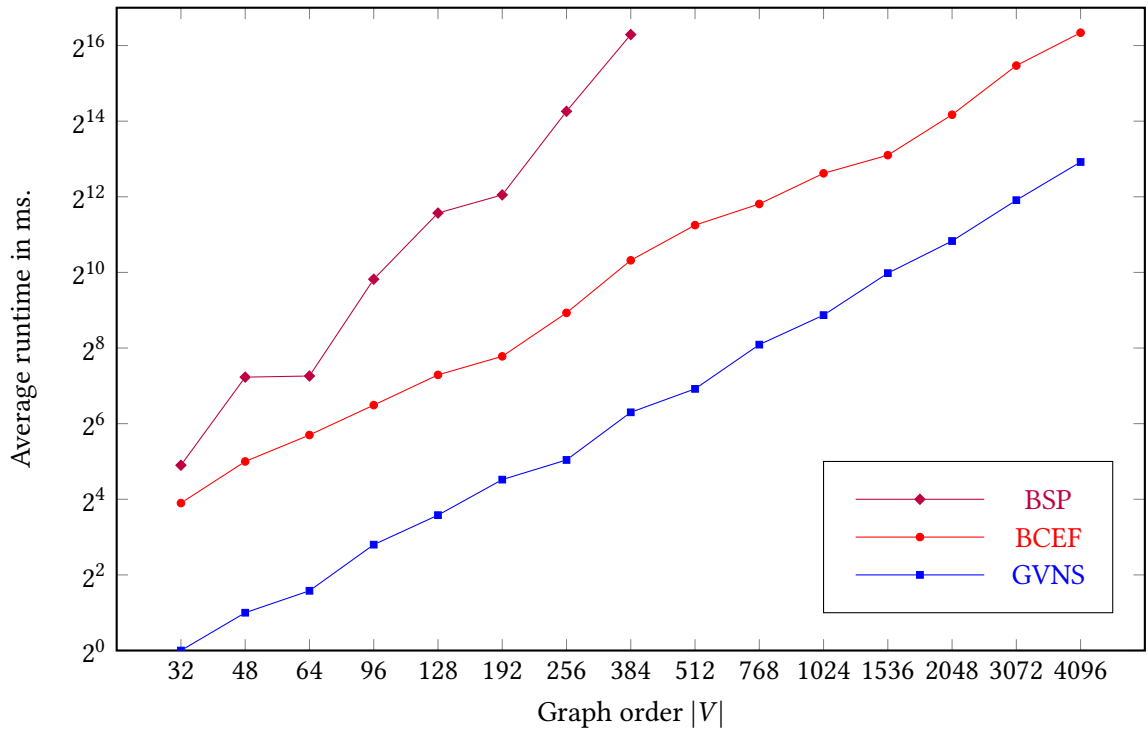

Figure 5: Computational results for undirected graphs

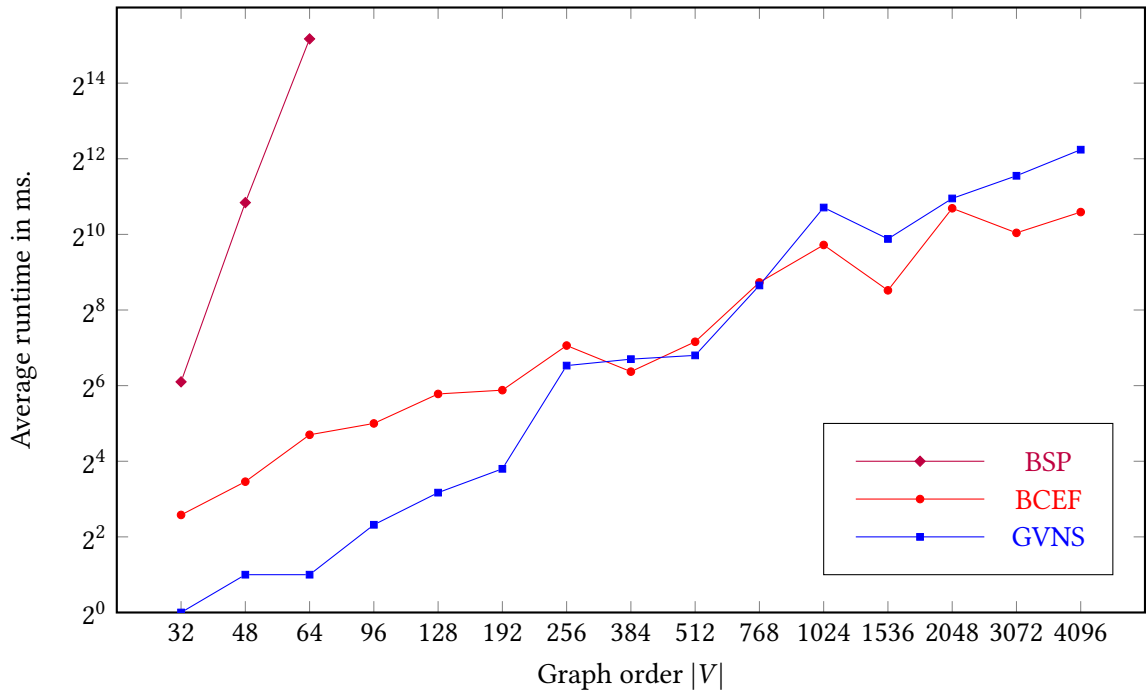

Figure 6: Computational results for feasible directed graphs

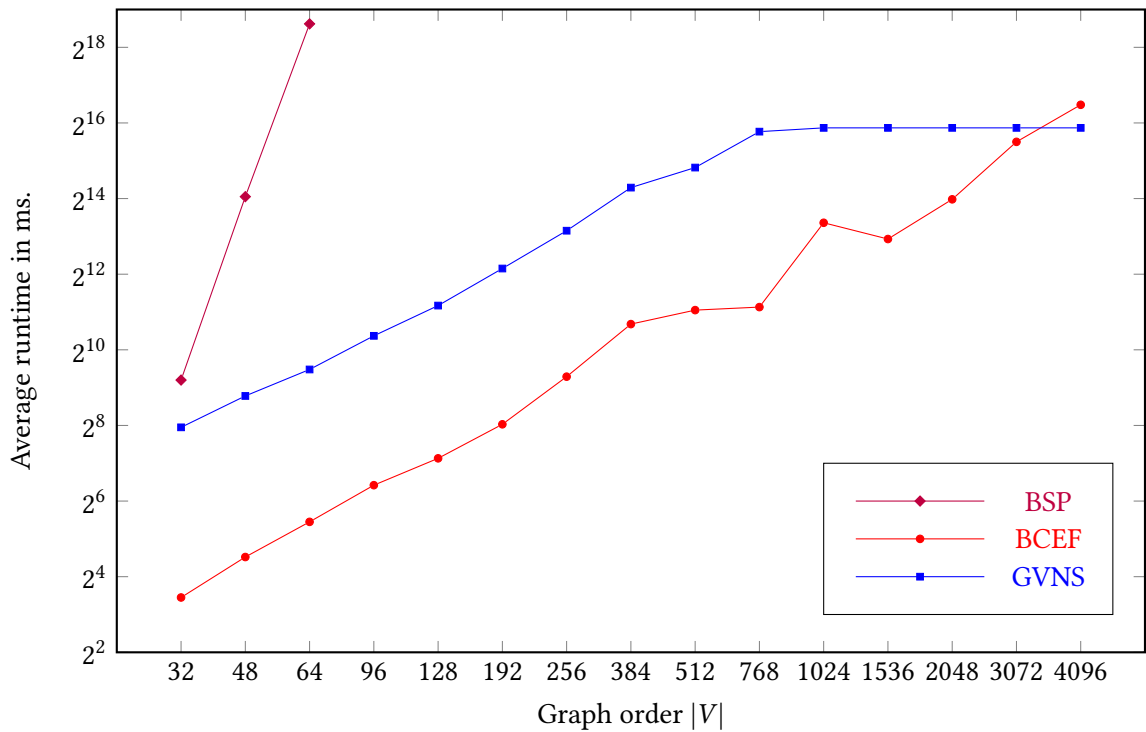

Figure 7: Computational results for infeasible directed graphs

Table 2: Computational results for 100 random directed Hamiltonian cycles

	BSP				BCEF				GVNS			
	Feasible		Infeasible		Feasible		Infeasible		Feasible		«Infeasible»	
V	N	times (s)	N	time (s)	N	time (s)	N	time (s)	N	time (s)	N	time (s)
32	30	0.069	70	0.592	30	0.006	70	0.011	30	0.001	70	0.248
48	20	1.838	80	17.005	20	0.011	80	0.023	20	0.002	80	0.440
64	8	36.850	17	403.016	20	0.026	80	0.044	20	0.002	80	0.714
96	0	–	0	–	19	0.032	81	0.086	19	0.005	81	1.330
128	–	–	–	–	18	0.055	82	0.141	18	0.009	82	2.312
192	–	–	–	–	21	0.059	79	0.262	21	0.014	79	4.569
256	–	–	–	–	25	0.134	75	0.628	25	0.093	75	9.120
384	–	–	–	–	20	0.083	80	1.646	20	0.104	80	19.215
512	–	–	–	–	22	0.143	78	2.131	22	0.112	78	29.048
768	–	–	–	–	19	0.426	81	2.241	19	0.404	81	55.991
1024	–	–	–	–	17	0.847	83	10.545	17	1.679	83	60.000
1536	–	–	–	–	16	0.369	84	7.844	16	0.943	84	60.000
2048	–	–	–	–	15	1.651	85	16.179	14	1.987	86	60.000
3072	–	–	–	–	21	1.059	79	46.589	21	2.999	79	60.000
4096	–	–	–	–	17	1.551	78	91.963	18	4.846	82	60.000

corresponding vertices of the traveling salesperson polytope are adjacent since the second Hamiltonian decomposition problem only verifies a sufficient condition for the non-adjacency in a 1-skeleton.

The worst results of the three considered algorithms were shown by backtracking based on simple path extension (BSP). In the allotted time, the algorithm solved only 225 instances out of 1500, without solving a single problem for graphs with more than 64 vertices. While chain edge fixing (BCEF) solved 1495 instances, and the general variable neighborhood search (GVNS) solved all instances. In terms of running time on feasible problems, the GVNS heuristic algorithm showed an advantage over BCEF on small graphs up to 512 vertices by an average of 6 times. However, on graphs with more than 512 vertices, BCEF turned out to be on average 2 times faster than GVNS. In general, for feasible problems, the BCEF and GVNS algorithms showed comparable results. Some variations in performance may be due to different implementations of the algorithms. However, we note that with an increase in the graph order, the advantage of BCEF over GVNS also increased. On the other hand, the general variable neighborhood search heuristics (GVNS) has encountered significant difficulties in infeasible instances. The algorithm cannot determine this scenario and exits only when the limit on running time or number of iterations is reached. On such problems, the algorithm based on chain fixing of edges (BCEF) turned out to be on average 16 times faster than GVNS. In part, this means that the iteration threshold for the heuristic algorithm could be lowered. However, in this case, there would be a danger of losing existing solutions.

Conclusion

In this paper, two backtracking algorithms were considered for the problem of constructing a second Hamiltonian decomposition of a 4-regular multigraph. According to the results of computational experiments on random directed and undirected multigraphs, the backtracking algorithm based on chain edge fixing turned out to be much more efficient than backtracking based on simple path extension. In addition, on directed multigraphs, the chain edge fixing showed comparable results with the previously known general variable neighborhood search heuristics on feasible instances and significantly outperformed the heuristics on infeasible problems.

The considered backtracking algorithms were developed for the problem of verifying the vertex non-adjacency in a 1-skeleton of a traveling salesperson polytope. However, they can also be applied directly to the problem of constructing the Hamiltonian decomposition of a regular multigraph and many of its applications.

References

- [1] N. E. Aguilera, R. D. Katz, and P. B. Tolomei. “Vertex adjacencies in the set covering polyhedron”. In: *Discrete Applied Mathematics* 218 (2017), pp. 40–56. doi: 10.1016/j.dam.2016.10.024.
- [2] D. L. Applegate et al. *The Traveling Salesman Problem: A Computational Study*. Princeton University Press, 2006. isbn: 9780691129938.
- [3] T. S. Arthanari. “On pedigree polytopes and Hamiltonian cycles”. In: *Discrete Mathematics* 306.14 (2006), pp. 1474–1492. doi: 10.1016/j.disc.2005.11.030.
- [4] T. S. Arthanari. “Study of the pedigree polytope and a sufficiency condition for nonadjacency in the tour polytope”. In: *Discrete Optimization* 10.3 (2013), pp. 224–232. doi: 10.1016/j.disopt.2013.07.001.
- [5] M. M. Bae and B Bose. “Edge disjoint Hamiltonian cycles in k -ary n -cubes and hypercubes”. In: *IEEE Transactions on Computers* 52.10 (2003), pp. 1271–1284. doi: 10.1109/TC.2003.1234525.
- [6] R. F. Bailey. “Error-correcting codes from permutation groups”. In: *Discrete Mathematics* 309.13 (2009), pp. 4253–4265. doi: 10.1016/j.disc.2008.12.027.
- [7] M. L. Balinski. “Signature Methods for the Assignment Problem”. In: *Operations Research* 33.3 (1985), pp. 527–536. doi: 10.1287/opre.33.3.527.
- [8] V. Bondarenko and A. Nikolaev. “On Graphs of the Cone Decompositions for the Min-Cut and Max-Cut Problems”. In: *International Journal of Mathematics and Mathematical Sciences* 2016 (2016), p. 7863650. doi: 10.1155/2016/7863650.
- [9] V. A. Bondarenko. “Nonpolynomial lower bounds for the complexity of the traveling salesman problem in a class of algorithms”. In: *Automation and Remote Control* 44.9 (1983), pp. 1137–1142.
- [10] V. A. Bondarenko and A. V. Nikolaev. “On the Skeleton of the Polytope of Pyramidal Tours”. In: *Journal of Applied and Industrial Mathematics* 12.1 (2018), pp. 9–18. doi: 10.1134/S1990478918010027.
- [11] C. R. Chegireddy and H. W. Hamacher. “Algorithms for finding K -best perfect matchings”. In: *Discrete Applied Mathematics* 18.2 (1987), pp. 155–165. doi: 10.1016/0166-218X(87)90017-5.
- [12] C. Clifton et al. “Tools for Privacy Preserving Distributed Data Mining”. In: *SIGKDD Explor. Newsl.* 4.2 (2002), pp. 28–34. doi: 10.1145/772862.772867.

- [13] E. F. Combarro and P. Miranda. “Adjacency on the order polytope with applications to the theory of fuzzy measures”. In: *Fuzzy Sets and Systems* 161.5 (2010), pp. 619–641. doi: 10.1016/j.fss.2009.05.004.
- [14] G. Dantzig, R. Fulkerson, and S. Johnson. “Solution of a Large-Scale Traveling-Salesman Problem”. In: *Journal of the Operations Research Society of America* 2.4 (1954), pp. 393–410. doi: 10.2307/166695.
- [15] H. N. Gabow. “Two Algorithms for Generating Weighted Spanning Trees in Order”. In: *SIAM Journal on Computing* 6.1 (1977), pp. 139–150. doi: 10.1137/0206011.
- [16] R. Glebov, Z. Luria, and B. Sudakov. “The number of Hamiltonian decompositions of regular graphs”. In: *Israel Journal of Mathematics* 222.1 (2017), pp. 91–108. doi: 10.1007/s11856-017-1583-y.
- [17] M. Grötschel and M. Padberg. “Polyhedral theory”. In: *The Traveling Salesman Problem: A Guided Tour of Combinatorial Optimization*. John Wiley, Chichester, 1985, pp. 251–305.
- [18] R. W. Hung. “Embedding two edge-disjoint Hamiltonian cycles into locally twisted cubes”. In: *Theoretical Computer Science* 412.35 (2011), pp. 4747–4753. doi: 10.1016/j.tcs.2011.05.004.
- [19] J. H. Kim and N. C. Wormald. “Random Matchings Which Induce Hamilton Cycles and Hamiltonian Decompositions of Random Regular Graphs”. In: *Journal of Combinatorial Theory, Series B* 81.1 (2001), pp. 20–44. doi: 10.1006/jctb.2000.1991.
- [20] D. E. Knuth. *The Art of Computer Programming, Volume 2 (3rd Ed.): Seminumerical Algorithms*. USA: Addison-Wesley Longman Publishing Co., Inc., 1997. isbn: 0201896842. doi: 10.5555/270146.
- [21] A. V. Korostil and A. V. Nikolaev. “Algoritm poiska s vozvratom dlya postroeniya gamil’tonova razlozheniya 4-regulyarnogo mul’tigrafa (Backtracking algorithm to construct the Hamiltonian decomposition of a 4-regular multigraph)”. In: *Zametki po informatike i matematike (Notes on Computer Science and Mathematics)*. Vol. 12. P.G. Demidov Yaroslavl State University, 2020, pp. 91–97.
- [22] A. Kozlova and A. Nikolaev. “Simulated annealing approach to verify vertex adjacencies in the traveling salesperson polytope”. In: *Mathematical Optimization Theory and Operations Research. MOTOR 2019*. Vol. 11548. LNCS. Springer, 2019, pp. 374–389. doi: 10.1007/978-3-030-22629-9_26.
- [23] J. Krarup. “The peripatetic salesman and some related unsolved problems”. In: *Combinatorial Programming: Methods and Applications*. Vol. 19. Springer Netherlands, 1995, pp. 173–178. doi: 10.1007/978-94-011-7557-9_8.
- [24] A. Nikolaev. “On vertex adjacencies in the polytope of pyramidal tours with step-backs”. In: *Mathematical Optimization Theory and Operations Research. MOTOR 2019*. Vol. 11548. LNCS. Springer, 2019, pp. 247–263. doi: 10.1007/978-3-030-22629-9_18.
- [25] A. Nikolaev and A. Kozlova. “Hamiltonian decomposition and verifying vertex adjacency in 1-skeleton of the traveling salesperson polytope by variable neighborhood search”. In: *Journal of Combinatorial Optimization* 42 (2 2021), pp. 212–230. doi: 10.1007/s10878-020-00652-7.
- [26] C. H. Papadimitriou. “The adjacency relation on the traveling salesman polytope is NP-Complete”. In: *Mathematical Programming* 14.1 (1978), pp. 312–324. doi: 10.1007/BF01588973.
- [27] B. Péroche. “NP-completeness of some problems of partitioning and covering in graphs”. In: *Discrete Applied Mathematics* 8.2 (1984), pp. 195–208. doi: 10.1016/0166-218X(84)90101-X.
- [28] M. R. Rao. “Adjacency of the Traveling Salesman Tours and $\$0 - \1 Vertices”. In: *SIAM Journal on Applied Mathematics* 30.2 (1976), pp. 191–198. doi: 10.1137/0130021.
- [29] S. S. Skiena. *The Algorithm Design Manual*. Springer, 2008. doi: 10.1007/978-1-84800-070-4.