

# Introductory computations in the cohomology of arithmetic groups

Graham Ellis<sup>1</sup>

<sup>1</sup>School of Mathematics, NUI Galway, Ireland  
E-mail: [graham.ellis@nuigalway.ie](mailto:graham.ellis@nuigalway.ie)<sup>1</sup>

## Abstract

This paper describes an approach to computer aided calculations in the cohomology of arithmetic groups. It complements existing literature on the topic by emphasizing homotopies and perturbation techniques, rather than cellular subdivision, as the tools for implementing on a computer topological constructions that fail to preserve cellular structures. Furthermore, it focuses on calculating integral cohomology rather than just rational cohomology or cohomology at large primes. In particular, the paper describes and fully implements algorithms for computing Hecke operators on the integral cuspidal cohomology of congruence subgroups  $\Gamma$  of  $SL_2(\mathbb{Z})$ , and then partially implements versions of the algorithms for the special linear group  $SL_2(\mathcal{O}_d)$  over various rings of quadratic integers  $\mathcal{O}_d$ . The approach is also relevant for computations on congruence subgroups of  $SL_m(\mathcal{O}_d)$ ,  $m \geq 2$ .

*2000 Mathematics Subject Classification.* **11F75**. .

*Keywords.* cohomology of arithmetic groups, computational algebra.

## 1 Introduction

This paper aims to provide a self-contained introduction to computer aided calculations in the cohomology of arithmetic groups up to a description, and partial computer implementation, of algorithms for computing Hecke operators on the cuspidal cohomology of congruence subgroups  $\Gamma$  of the special linear group of  $2 \times 2$  matrices  $SL_2(\mathcal{O})$  over various rings of quadratic integers  $\mathcal{O} = \mathcal{O}_d$  as well as over the usual integers  $\mathcal{O} = \mathbb{Z}$ . The approach complements existing literature on the topic by emphasizing homotopies and perturbation techniques, rather than cellular subdivision, as the tools for machine implementation of topological constructions that fail to preserve cellular structures. Furthermore, we focus on calculating integral cohomology rather than just rational cohomology or cohomology at large primes. Implementations are available as part of the HAP package [11] for the GAP system for computational algebra [16].

Section 2 recalls some motivation for studying cohomology Hecke operators. Section 3 recalls some motivation for computing with integral, rather than rational, cohomology. Sections 4–8 provide a fully implemented account of how to compute Hecke operators on the integral cuspidal cohomology of congruence subgroups of  $SL_2(\mathbb{Z})$ . Sections 9–15 provide a partially implemented account for congruence subgroups of  $SL_2(\mathcal{O}_d)$  over various rings  $\mathcal{O}_d$  of quadratic integers. The approach is also relevant for computations on congruence subgroups of  $SL_m(\mathcal{O}_d)$ ,  $m \geq 2$ .

## 2 The Eichler-Shimura isomorphism

The Eichler-Shimura isomorphism [9][25]

$$\varepsilon: S_k(\Gamma) \oplus \overline{S_k(\Gamma)} \oplus E_k(\Gamma) \xrightarrow{\cong} H^1(\Gamma, P_{\mathbb{C}}(k-2)) \quad (2.1)$$

relates the cohomology of groups to the theory of modular forms associated to a finite index subgroup  $\Gamma$  of  $SL_2(\mathbb{Z})$ . In subsequent sections we explain how to compute with the right-hand side of the isomorphism. But first, for completeness and for motivation, we define the ingredients of the isomorphism.

Let  $N$  be a positive integer. A subgroup  $\Gamma$  of  $SL_2(\mathbb{Z})$  is said to be a *congruence subgroup* of level  $N$  if it contains the kernel of the canonical homomorphism  $\pi_N: SL_2(\mathbb{Z}) \rightarrow SL_2(\mathbb{Z}/N\mathbb{Z})$ . So any congruence subgroup is of finite index in  $SL_2(\mathbb{Z})$ . (To see that there exist finite index subgroups that are not congruence subgroups, one can use the presentation  $SL_2(\mathbb{Z}) \cong \langle S, U : S^4 = U^6 = 1, S^2 = U^3 \rangle$  to construct a surjective homomorphism  $\rho: SL_2(\mathbb{Z}) \rightarrow S_7$  onto the symmetric group of degree 7, mapping  $\rho(S) = (1, 2)(3, 5)(4, 6)$ ,  $\rho(U) = (2, 3, 4)(5, 6, 7)$ . The finite index subgroup  $\ker \rho$  is not a congruence subgroup since  $S_7$  is not a quotient of  $SL_2(\mathbb{Z}/m\mathbb{Z})$  for any  $m$ . This last assertion can be established using the fact that  $PSL_2(\mathbb{Z}/p)$  is simple for primes  $p > 2$ .) One congruence subgroup of particular interest is the kernel  $\Gamma(N) = \ker \pi_N$  itself, known as the *principal congruence subgroup* of level  $N$ . A second congruence subgroup of interest is the group  $\Gamma_1(N)$  consisting of those matrices that project to upper unitriangular matrices in  $SL_2(\mathbb{Z}/N\mathbb{Z})$ . Another congruence subgroup of particular interest is the group  $\Gamma_0(N)$  of those matrices that project to upper triangular matrices in  $SL_2(\mathbb{Z}/N\mathbb{Z})$ . Clearly  $\Gamma(N) \leq \Gamma_1(N) \leq \Gamma_0(N)$ .

Fix any finite index subgroup  $\Gamma \leq SL_2(\mathbb{Z})$ . A *modular form* of weight  $k$  and level  $\Gamma$  is a complex valued function on the upper-half plane

$$f: \mathfrak{h} = \{z \in \mathbb{C} : \operatorname{Re}(z) > 0\} \rightarrow \mathbb{C}$$

such that for any  $\begin{pmatrix} a & b \\ c & d \end{pmatrix} \in \Gamma$  the following hold:

1.  $f\left(\frac{az+b}{cz+d}\right) = (cz+d)^k f(z)$  for all  $z \in \mathfrak{h}$ ,
2. the function  $(cz+d)^{-k} f\left(\frac{az+b}{cz+d}\right)$  is bounded as  $\operatorname{Im}(z) \rightarrow \infty$ ,
3.  $f$  is holomorphic on  $\mathfrak{h}$ .

The collection of all weight  $k$  modular forms for  $\Gamma$  form a vector space  $M_k(\Gamma)$  over  $\mathbb{C}$ .

A modular form  $f$  is said to be a *cusp form* if it satisfies the following:

- 2'. the function  $(cz+d)^{-k} f\left(\frac{az+b}{cz+d}\right) \rightarrow 0$  as  $\operatorname{Im}(z) \rightarrow \infty$ .

The collection of all weight  $k$  cusp forms for  $\Gamma$  form a vector subspace  $S_k(\Gamma)$ . There is a decomposition

$$M_k(\Gamma) \cong S_k(\Gamma) \oplus E_k(\Gamma)$$

involving a summand  $E_k(\Gamma)$  known as the *Eisenstein space*.

A function  $f: \mathfrak{h} \rightarrow \mathbb{C}$ ,  $z \mapsto u + iv$  is said to be an *anti-holomorphic cusp form* of weight  $k$  if its complex conjugate  $\overline{f(z)} = u - iv$  is a cusp form of weight  $k$ . The collection of all anti-holomorphic cusp forms of weight  $k$  form a vector subspace  $\overline{S}_k(\Gamma)$ . See [27] for further introductory details on modular forms.

On the right-hand side of (2.1), the  $\mathbb{Z}\Gamma$ -module  $P_{\mathbb{C}}(k-2) \subset \mathbb{C}[x, y]$  denotes the space of homogeneous degree  $k-2$  polynomials with action of  $\Gamma$  given by

$$\begin{pmatrix} a & b \\ c & d \end{pmatrix} \cdot p(x, y) = p(dx - by, -cx + ay) .$$

In particular  $P_{\mathbb{C}}(0) = \mathbb{C}$  is the trivial module. (In subsequent sections we compute with the integral analogue  $P_{\mathbb{Z}}(k-2) \subset \mathbb{Z}[x, y]$ , to which the action of  $\Gamma$  restricts.)

Each cohomology class  $[c] \in H^1(\Gamma, P_{\mathbb{C}}(k-2))$  is represented by a function  $c: \Gamma \rightarrow P_{\mathbb{C}}(k-2)$  satisfying the cocycle condition

$$c(\gamma\gamma') = \gamma \cdot c(\gamma') + c(\gamma)$$

for all  $\gamma, \gamma' \in \Gamma$ . We let  $Z^1(\Gamma, P_{\mathbb{C}}(k-2))$  denote the vector space of all such cocycles.

For any finite index subgroup  $\Gamma \leq SL_2(\mathbb{Z})$  the Eichler-Shimura map (2.1) is an isomorphism of vector spaces induced by the mapping

$$\varepsilon: M_k(\Gamma) \times \overline{S_k(\Gamma)} \longrightarrow Z^1(\Gamma, P_{\mathbb{C}}(k-2)), \quad (f, \bar{g}) \mapsto (c: \gamma \mapsto I_f(\mathbf{i}, \gamma\mathbf{i}) + I_{\bar{g}}(\mathbf{i}, \gamma\mathbf{i}))$$

where

$$I_f(\mathbf{i}, \gamma\mathbf{i}) = \int_{\mathbf{i}}^{\gamma\mathbf{i}} f(z)(xz + y)^{k-2} dz ,$$

$$I_{\bar{g}}(\mathbf{i}, \gamma\mathbf{i}) = \int_{\mathbf{i}}^{\gamma\mathbf{i}} \overline{g(z)}(xz + y)^{k-2} d\bar{z} .$$

See [33] for a full account of the Eichler-Shimura isomorphism.

In fact, the mapping (2.1) is more than an isomorphism of vector spaces. It is an isomorphism of Hecke modules: both sides admit the notion of *Hecke operator*, and the isomorphism preserves these operators. For our purposes it suffices to describe the cohomology operator.

A finite index subgroup  $\Gamma \leq SL_2(\mathbb{Z})$  and element  $g \in SL_2(\mathbb{Q})$  determine the finite index subgroup  $\Gamma' = \Gamma \cap g\Gamma g^{-1} \leq SL_2(\mathbb{Z})$  and homomorphisms

$$\Gamma \leftrightarrow \Gamma' \xrightarrow{\gamma \mapsto g^{-1}\gamma g} g^{-1}\Gamma'g \hookrightarrow \Gamma . \quad (2.2)$$

These homomorphisms give rise to homomorphisms of cohomology groups

$$H^n(\Gamma, P_{\mathbb{C}}(k-2)) \xleftarrow{tr} H^n(\Gamma', P_{\mathbb{C}}(k-2)) \xleftarrow{\alpha} H^n(g^{-1}\Gamma'g, P_{\mathbb{C}}(k-2)) \xleftarrow{\beta} H^n(\Gamma, P_{\mathbb{C}}(k-2))$$

with  $\alpha, \beta$  functorial maps, and  $tr$  the transfer map. We define the composite

$$T_g = tr \circ \alpha \circ \beta: H^n(\Gamma, P_{\mathbb{C}}(k-2)) \rightarrow H^n(\Gamma, P_{\mathbb{C}}(k-2)) \quad (2.3)$$

to be the *Hecke operator* determined by  $g$ . The homomorphism (2.3) induces homomorphisms

$$T_g: M_k(\Gamma) \rightarrow M_k(\Gamma) , \quad T_g: S_k(\Gamma) \rightarrow S_k(\Gamma) , \quad T_g: E_k(\Gamma) \rightarrow E_k(\Gamma) . \quad (2.4)$$

For each  $n \geq 1$  we define

$$T_n := T_g \quad \text{with} \quad g = \begin{pmatrix} 1 & 0 \\ 0 & \frac{1}{n} \end{pmatrix} .$$

Further details on this description of Hecke operators can be found, for instance, in [27, Appendix by P. Gunnells].

Let  $f$  be a *modular form* of *weight*  $k$  and *level*  $\Gamma$ . Suppose that the identity  $f(z+1) = f(z)$  holds for all  $z \in \mathfrak{h}$ . This identity certainly holds, for example, if  $\Gamma = \Gamma_0(N)$  or  $\Gamma = \Gamma_1(N)$ . The identity can be used to establish the existence of a convergent power series

$$f(z) = \sum_{n=0}^{\infty} a_n (e^{2\pi iz})^n = \sum_{n=0}^{\infty} a_n q^n \quad (2.5)$$

valid for all  $z \in \mathfrak{h}$ , where  $a_n$  are fixed complex numbers and  $q = e^{2\pi iz}$ . The form  $f$  is a cusp form if and only if  $a_0 = 0$ . A non-zero cusp form  $f \in S_k(\Gamma)$  is an *eigenform* if it is simultaneously an eigenvector for the Hecke operators  $T_n$  for all  $n = 1, 2, 3, \dots$ . An eigenform is said to be *normalized* if it has coefficient  $a_1 = 1$ .

It turns out that if  $f$  is a normalized eigenform then the coefficient  $a_n$  is an eigenvalue for  $T_n$  (see for instance [27] for details). It can be shown [3] that  $S_k(\Gamma_0(N))$  admits a basis of eigenforms. This all implies that, in principle, one can construct an approximation to an explicit basis for the space  $S_k(\Gamma_0(N))$  of weight  $k$  cusp forms simply by computing eigenvalues for Hecke operators. An illustration is given in Example 8.3 below. This provides one motivation for computing Hecke operators on  $H^1(\Gamma_0(N), P_{\mathbb{C}}(k-2))$ .

The definition of Hecke operators given in (2.3) applies to the cohomology of any finite index subgroup  $\Gamma \leq SL_m(\mathbb{Z})$  where  $m \geq 2$ , with coefficients in any finitely generated  $\mathbb{Z}\Gamma$ -module  $\mathcal{P}$ . A theorem of Franke [15] asserts that: (i) for suitable  $\mathcal{P}$  the cohomology  $H^*(\Gamma, \mathcal{P})$  can be directly computed in terms of certain automorphic forms; and (ii) there is a decomposition  $H^*(\Gamma, \mathcal{P}) \cong H_{cusp}^*(\Gamma, \mathcal{P}) \oplus H_{eis}^*(\Gamma, \mathcal{P})$  involving a ‘cuspidal summand’ and an ‘Eisenstein summand’ analogous to the Eichler-Shimura isomorphism for  $m = 2$ . The computation of eigenvectors of Hecke operators, in this setting, conjecturally yields information on automorphic forms. The definition of Hecke operators applies even more generally to finite index subgroups  $\Gamma \leq SL_m(\mathcal{O})$  with  $\mathcal{O}$  the ring of integers of an algebraic number field, provided the corresponding intersection group  $\Gamma'$  is of finite index. The case  $m = 2$  and  $\mathcal{O}$  the ring of integers of a quadratic number field is considered in Sections 9–15, particularly the *Bianchi case* of imaginary quadratic number fields. In this Bianchi setting there is a Hecke equivariant isomorphism, analogous to the Eichler-Shimura isomorphism and due to Harder [17], between the space of ‘Bianchi modular forms’ and the first cohomology of  $\Gamma$  with ‘appropriate coefficients’.

### 3 Torsion

Let  $d$  be a square free integer, and let  $\mathcal{O}_d$  denote the ring of integers of the quadratic number field  $\mathbb{Q}(\sqrt{d})$ . Explicitly, we have  $\mathcal{O}_d = \{m + n\omega : m, n \in \mathbb{Z}\}$  where

$$\omega = \begin{cases} \sqrt{d} & \text{if } d \equiv 2, 3 \pmod{4}, \\ \frac{1+\sqrt{d}}{2} & \text{if } d \equiv 1 \pmod{4}. \end{cases}$$

Let  $\mathfrak{a} \triangleleft \mathcal{O}_d$  be a non-zero ideal. There is a canonical homomorphism  $\pi_{\mathfrak{a}}: SL_2(\mathcal{O}_d) \rightarrow SL_2(\mathcal{O}_d/\mathfrak{a})$ . A subgroup  $\Gamma \leq SL_2(\mathcal{O}_d)$  is said to be a *congruence subgroup* if it contains  $\ker \pi_{\mathfrak{a}}$ . Thus congruence subgroups are of finite index. As above, we define  $\Gamma(\mathfrak{a}) = \ker \pi_{\mathfrak{a}}$  to be the *principal congruence subgroup* of level  $\mathfrak{a}$ . The congruence subgroup  $\Gamma_1(\mathfrak{a})$  consists of those matrices that project to upper

unitriangular matrices in  $SL_2(\mathcal{O}_d/\mathfrak{a})$ . The congruence subgroup  $\Gamma_0(\mathfrak{a})$  consists of those matrices that project to upper triangular matrices in  $SL_2(\mathcal{O}_d/\mathfrak{a})$ .

For  $d > 0$  the group  $G = SL_2(\mathcal{O}_{-d})$  acts on the *upper-half space*

$$\mathfrak{h}^3 = \{(z, t) \in \mathbb{C} \times \mathbb{R} \mid t > 0\}$$

in such a way that any point  $(z, t) \in \mathfrak{h}^3$  has finite stabilizer group in  $G$ . The action is by isometries with respect to the hyperbolic metric on  $\mathfrak{h}^3$ . For this metric, geodesics are Euclidean semi-circles of radius  $0 < r \leq \infty$  that ‘meet’ the complex plane  $\mathbb{C}$  perpendicularly. Any finite index subgroup  $\Gamma \leq G$  gives rise to a compact quotient orbifold  $\mathfrak{h}^3/\Gamma$ .

Let  $\Gamma_{tors}^{ab}$  denote the maximal finite summand of the first integral homology group  $H_1(\Gamma, \mathbb{Z})$ . Bergeron and Venkatesh [4, 5] have conjectured relationships between the torsion in the integral homology of congruence subgroups  $\Gamma$  and the volume of their quotient orbifold  $\mathfrak{h}^3/\Gamma$ . For instance, for the Gaussian integers  $\mathcal{O}_{-1} = \mathcal{O}(\mathbb{Q}(\sqrt{-1}))$  they conjecture

$$\frac{\log |\Gamma_0(\mathfrak{a})_{tors}^{ab}|}{\text{Norm}(\mathfrak{a})} \rightarrow \frac{\lambda}{18\pi}, \quad \lambda = L(2, \chi_{\mathbb{Q}(\sqrt{-1})}) = 1 - \frac{1}{9} + \frac{1}{25} - \frac{1}{49} + \dots \quad (3.1)$$

as the norm of the prime ideal  $\mathfrak{a} \triangleleft \mathcal{O}_{-1}$  tends to  $\infty$ . Here the value of  $\lambda$  is given in terms of the  $L$ -function

$$L(s, \chi_{\mathbb{Q}(\sqrt{-1})}) = \sum_{n=1}^{\infty} \chi_{\mathbb{Q}(\sqrt{-1})}(s) n^{-s}$$

of the quadratic character  $\chi_{\mathbb{Q}(\sqrt{-1})}$  associated to the quadratic field  $\mathbb{Q}(\sqrt{-1})$ .

The link between conjecture (3.1) and volume is given by the Humbert volume formula

$$\text{Vol}(\mathfrak{h}^3/SL_2(\mathcal{O}_{-d})) = \frac{|D|^{3/2}}{24} \zeta_{\mathbb{Q}(\sqrt{-d})}(2)/\zeta_{\mathbb{Q}}(2)$$

valid for square-free  $d > 0$ , where  $D$  is the discriminant of  $\mathbb{Q}(\sqrt{-d})$ , and the quadratic reciprocity formula

$$\zeta_{\mathbb{Q}(\sqrt{-d})}(s) = L(s, \chi_{\mathbb{Q}(\sqrt{-d})})\zeta_{\mathbb{Q}}(s)$$

expressing the Dedekind zeta function as a product of an  $L$ -function and the Riemann zeta function. The volume of a finite index subgroup  $\Gamma$  is obtained by multiplying the right-hand side by the index  $|SL_2(\mathcal{O}_{-d}) : \Gamma|$ .

Sequence (2.2), adapted to the current context, induces a composite homology homomorphism  $T_g : H_1(\Gamma, \mathbb{Z}) \rightarrow H_1(\Gamma, \mathbb{Z})$  which we refer to as an homology *Hecke operator*. This restricts to a Hecke operator  $\Gamma_{tors}^{ab} \rightarrow \Gamma_{tors}^{ab}$  on the torsion part of  $\Gamma^{ab} = H_1(\Gamma, \mathbb{Z})$ . For simplicity, let us suppose that some prime  $p$  occurs with multiplicity 1 in the prime decomposition of the order  $|\Gamma_{tors}^{ab}|$ . A result of P. Scholze [23] implies, under the simplifying assumption, that any homology class  $\alpha \in H_1(\Gamma, \mathbb{Z})_p \cong \mathbb{Z}/p\mathbb{Z}$  in the  $p$ -part of the homology (which is necessarily a Hecke eigenclass) gives rise to a representation  $\rho : \text{Gal}(\overline{\mathbb{Q}}/\mathbb{Q}(\sqrt{d})) \rightarrow GL_2(\overline{\mathbb{F}}_p)$  with various nice properties. Conjectures of Ash [2] and others suggest a converse to Scholze’s theorem. See [4] for a more detailed discussion.

A computer investigation of the conjectures of Bergeron, Venkatesh, Ash and others is one reason for wanting algorithms to compute with integral homology and cohomology.

#### 4 Basic computations in $SL_2(\mathbb{Z})$

Let  $G = SL_2(\mathbb{Z})$ . The implementation of given elements of  $G$ , multiplication and division of elements of  $G$ , and the test for equality between elements of  $G$  is routine and available in all computer algebra packages. The test for whether a given  $2 \times 2$  integer matrix lies in  $G$  is a simple test of whether certain integer equations hold, and is routine to implement. The matrices

$$S = \begin{pmatrix} 0 & -1 \\ 1 & 0 \end{pmatrix} \quad \text{and} \quad T = \begin{pmatrix} 1 & 1 \\ 0 & 1 \end{pmatrix}$$

generate  $G$ . It is not difficult to devise an algorithm for expressing an arbitrary integer matrix  $A \in G$  as a word in  $S$  and  $T$ . An implementation of such an algorithm underlies the functions in HAP for computing Hecke operators on the cohomology of finite index subgroups of  $G$ , and so we describe it in some detail. We opt for a geometric description which has the merit of being readily adapted to yield a key ingredient in the computation of Hecke operators for Bianchi groups.

Consider the matrix

$$U = ST = \begin{pmatrix} 0 & -1 \\ 1 & 1 \end{pmatrix}.$$

The matrices  $S$  and  $U$  also generate  $G$ . In fact we have a free presentation  $G = \langle S, U \mid S^4 = U^6 = 1, S^2 = U^3 \rangle$ . The *cubic tree*  $\mathcal{T}$  is a tree (*i.e.* a 1-dimensional contractible regular CW-complex) with countably infinitely many edges in which each vertex has degree 3. We can realize the cubic tree  $\mathcal{T}$  by taking the left cosets of  $\mathcal{U} = \langle U \rangle$  in  $G$  as vertices, and joining cosets  $x\mathcal{U}$  and  $y\mathcal{U}$  by an edge if, and only if,  $x^{-1}y \in \mathcal{U}S\mathcal{U}$ . Thus the vertex  $\mathcal{U}$  is joined to  $S\mathcal{U} = T\mathcal{U}$ ,  $US\mathcal{U} = STS\mathcal{U}$  and  $U^2S\mathcal{U} = T^{-1}\mathcal{U}$ . The vertices of this tree are in one-to-one correspondence with all *reduced words* in  $S, U, U^2$  that, apart from the identity word, end in  $S$  and that don't contain the substrings  $S^2$  or  $U^3$ . From this algebraic realization of the cubic tree we see that  $G$  acts on  $\mathcal{T}$  in such a way that there is a single orbit of vertices, and a single orbit of edges; each vertex is stabilized by a cyclic subgroup conjugate to  $\mathcal{U} = \langle U \rangle$  and each edge is stabilized by a cyclic subgroup conjugate to  $\mathcal{S} = \langle S \rangle$ .

Given a matrix  $A \in G$  we want to describe an algorithm for producing a reduced word  $w_A$  in  $S, U$  and  $U^2$  that represents the vertex  $A\mathcal{U}$  of  $\mathcal{T}$ . The word  $w_A$  furnishes the desired representation of  $A$  in terms of  $S$  and  $T$ . For  $A \in \mathcal{U}$  we take  $w_A$  to be the empty word. The algorithm recursively applies a procedure for determining a factorization

$$A = BX \tag{4.1}$$

of  $A \notin \mathcal{U}$ , where  $X \in \{S, US, U^2S\}$  and where the length of the reduced word  $w_B$  is less than that of  $w_A$ . The procedure for factorization (4.1) involves the standard action

$$\begin{pmatrix} a & b \\ c & d \end{pmatrix} \cdot z = \frac{az + b}{cz + d} \tag{4.2}$$

of a matrix in  $G$  on a point  $z$  in the upper half plane  $\mathfrak{h}$ . A geometric interpretation of the cubic tree is obtained by considering the singleton set and open arc

$$e^0 = \{\exp(i2\pi/3)\} \quad \text{and} \quad e^1 = \{\exp(i\theta) : \frac{\pi}{3} < \theta < \frac{2\pi}{3}\}.$$

The union  $e^0 \cup e^1$  is an arc of a Euclidean unit circle, with one end closed and the other end open. The orbit of  $e^0 \cup e^1$  under the action of  $G$  is a connected 1-dimensional CW-complex, pictured in Figure 1. The images of  $e^0$  under the action are the 0-cells, and the images of  $e^1$  are the 1-cells. We denote this CW-complex by  $\mathcal{T}$  since it is isomorphic, as a graph, to the cubic tree constructed above. The matrix  $S$  acts on  $\mathfrak{h}$  as inversion in the unit circle centered at 0 followed by reflection

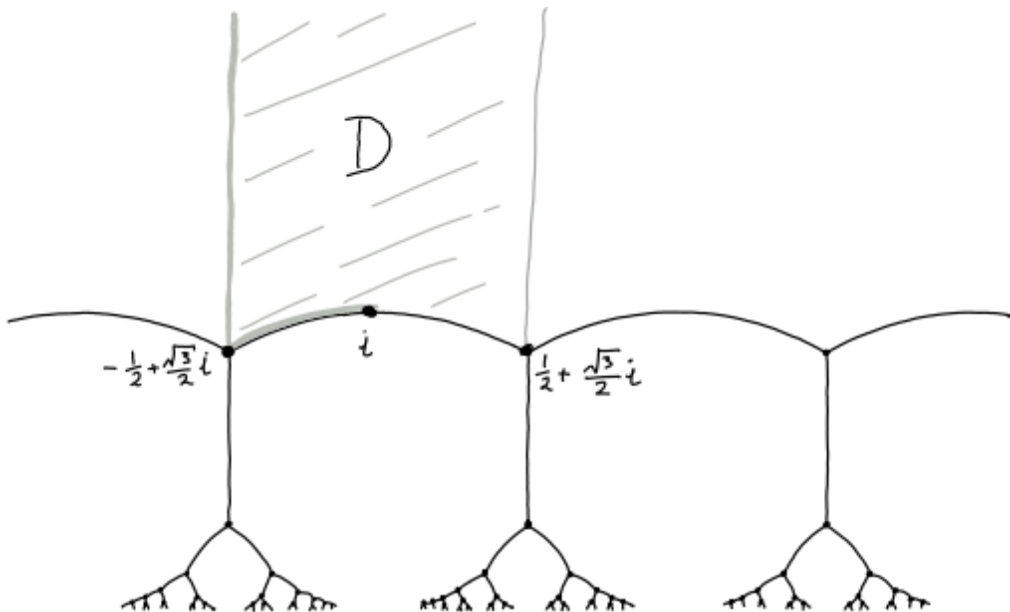

FIGURE 1. A portion of the cubic tree embedded in the upper-half plane  $\mathfrak{h}$ , together with a portion of a fundamental domain  $D$  for the action of  $SL_2(\mathbb{Z})$  on  $\mathfrak{h}$ .

in the imaginary axis,  $z \mapsto -1/z$ . The matrix  $T$  acts as a translation of one unit to the right,  $z \mapsto z + 1$ . The composite  $U = ST$  ‘rotates’ through one third of a clockwise turn the three edges of the cubic tree touching  $e^0$ .

To determine the factorization (4.1) we set  $z = \exp(i2\pi/3)$  and calculate the complex numbers  $A \cdot z$  and  $AX^{-1} \cdot z$  for  $X \in \{S, US, U^2S\}$ . If for one of these three choices for  $X$  we find that the imaginary part of  $AX^{-1} \cdot z$  is greater than the imaginary part of  $A \cdot z$  then we set  $B = AX^{-1}$ ; otherwise for some  $X$  the absolute value of the real part of  $AX^{-1} \cdot z$  is smaller than the absolute value of the real part of  $A \cdot z$ , in which case we again set  $B = AX^{-1}$ .

Let  $C_*\mathcal{T}$  denote the cellular chain complex of the CW-complex  $\mathcal{T}$ . So  $C_n\mathcal{T}$  is the free abelian group with generators the  $n$ -cells of  $\mathcal{T}$ ,  $n = 0, 1$ , and  $d_1: C_1\mathcal{T} \rightarrow C_0\mathcal{T}$  is the boundary homomorphism. Let  $S = \langle S \rangle$ . The action of  $G$  on  $\mathcal{T}$  induces  $\mathbb{Z}G$ -module structures  $C_0\mathcal{T} \cong \mathbb{Z}G \otimes_{\mathbb{Z}U} \mathbb{Z}$  and  $C_1\mathcal{T} \cong \mathbb{Z}G \otimes_{\mathbb{Z}S} \mathbb{Z}^\varepsilon$  where  $\mathbb{Z}^\varepsilon$  denotes the integers with non-trivial action of  $S$ , and where  $d_1$  is a homomorphism of  $\mathbb{Z}G$ -modules. The elements of  $C_0\mathcal{T}$  and  $C_1\mathcal{T}$  can be expressed as  $\gamma e^0$  and  $\gamma e^1$  respectively, with  $\gamma$  an element of the group ring  $\mathbb{Z}G$ . The boundary homomorphism is defined by  $d_1(\gamma e^1) = \gamma(1 - \gamma e^0)$ . The factorization (4.1) can be viewed as a homomorphism  $h_0: C_0\mathcal{T} \rightarrow C_1\mathcal{T}$  of free abelian groups defined on free generators by  $e^0 \mapsto 0$ , and  $Ae^0 \mapsto Be^1$  for each  $A \notin U$ . The

homomorphism  $h_0$  is a *contracting homotopy*  $C_*\mathcal{T} \simeq \mathbb{Z}$  in the sense that

$$d_1 h_0 = 1, \quad h_0 d_1 = 1. \quad (4.3)$$

The homomorphism  $h_0$  does not preserve the  $G$ -action. The above discussion is summarized in the following.

**Proposition 4.1.** The  $\mathbb{Z}G$ -chain complex

$$C_*\mathcal{T} = (\mathbb{Z}G \otimes_{\mathbb{Z}\mathcal{S}} \mathbb{Z}^\varepsilon \xrightarrow{d_1} \mathbb{Z}G \otimes_{\mathbb{Z}\mathcal{U}} \mathbb{Z})$$

and non-equivariant contracting homotopy  $h_*: C_*\mathcal{T} \simeq \mathbb{Z}$  can be implemented on a computer in such a way that arbitrary elements  $\gamma e^0 \in C_0\mathcal{T}$ ,  $\gamma e^1 \in C_1\mathcal{T}$  can be expressed and their images  $d_1(\gamma e^1)$ ,  $h_0(\gamma e^0)$  can be uniquely determined.  $\blacksquare$

## 5 Integral cohomology of $SL_2(\mathbb{Z})$

For any group  $Q$  let  $R_*^Q$  denote some free  $\mathbb{Z}Q$ -resolution of the trivial module  $\mathbb{Z}$ . In other words,  $R_*^Q$  is a chain complex of free  $\mathbb{Z}Q$ -modules with  $H_0(R_*^Q) \cong \mathbb{Z}$ ,  $H_n(R_*^Q) = 0$  for  $n > 0$ . The cohomology of  $Q$  with coefficients in the trivial  $Q$ -module  $\mathbb{Z}$  is defined as

$$H^n(Q, \mathbb{Z}) = H^n(\text{Hom}_{\mathbb{Z}Q}(R_*^H, \mathbb{Z})).$$

A free resolution  $R_*^Q$  always admits a contracting homotopy  $h_*: R_*^Q \simeq \mathbb{Z}$  consisting of a sequence of  $\mathbb{Z}$ -linear homomorphisms  $h_n: R_n^Q \rightarrow R_{n+1}^Q$  for  $n \geq 0$  satisfying  $d_{n+1}h_n + h_{n-1}d_n = 1$  where  $d_0 = h_{-1} = 0$ .

Many theoretical constructions in the cohomology of groups involve repeated use of the following element of choice.

**Element of choice:** Given  $x \in \ker(d_n: R_n^Q \rightarrow R_{n-1}^Q)$  choose an element  $\tilde{x} \in R_{n+1}^Q$  such that  $d_{n+1}(\tilde{x}) = x$ .

If an algorithmic formula for a contracting homotopy on  $R_*^Q$  is to hand then the choice can be made algorithmic: one simply chooses  $\tilde{x} = h_n(x)$ .

For a cyclic group  $Q = \langle x : x^q = 1 \rangle$  one can choose  $R_n^Q = \mathbb{Z}Q$  for  $n \geq 0$ , and  $d_{2n-1}(1) = (x-1)$ ,  $d_{2n}(1) = (1+x+x^2+\dots+x^{q-1})$  for  $n > 0$ . A contracting homotopy is given by  $h_{2n}(x^k) = 1+x+x^2+\dots+x^{k-1}$ ,  $h_{2n+1}(x^{q-1}) = 1$ ,  $h_{2n+1}(x^\ell) = 0$  for  $\ell \neq q-1$ .

For the group  $G = SL_2(\mathbb{Z})$ , and specific cyclic subgroups  $\mathcal{U} = \langle U \rangle$ ,  $\mathcal{S} = \langle S \rangle$  we have

$$H_0(R_*^{\mathcal{U}} \otimes_{\mathbb{Z}\mathcal{U}} \mathbb{Z}G) \cong \mathbb{Z}G \otimes_{\mathbb{Z}\mathcal{U}} \mathbb{Z} = C_0\mathcal{T} \quad \text{and} \quad H_0((R_*^{\mathcal{S}} \otimes_{\mathbb{Z}} \mathbb{Z}^\varepsilon) \otimes_{\mathbb{Z}\mathcal{S}} \mathbb{Z}G) \cong \mathbb{Z}G \otimes_{\mathbb{Z}\mathcal{S}} \mathbb{Z}^\varepsilon = C_1\mathcal{T}.$$

The boundary homomorphism  $d_1: C_1\mathcal{T} \rightarrow C_0\mathcal{T}$  thus induces a chain homomorphism

$$d_*^h: (R_*^{\mathcal{S}} \otimes_{\mathbb{Z}} \mathbb{Z}^\varepsilon) \otimes_{\mathbb{Z}\mathcal{S}} \mathbb{Z}G \longrightarrow R_*^{\mathcal{U}} \otimes_{\mathbb{Z}\mathcal{U}} \mathbb{Z}G \quad (5.1)$$

between free  $\mathbb{Z}G$ -chain complexes. The superscript on  $d_*^h$  stands for ‘horizontal’. We regard (5.1) as a double complex, and let  $R_*^G$  denote its total complex. Explicitly  $R_n^G = D_{1,n-1} \oplus D_{0,n}$  where

$$D_{0,n} = (R_n^{\mathcal{U}} \otimes_{\mathbb{Z}\mathcal{U}} \mathbb{Z}G) \cong \mathbb{Z}G, \quad D_{1,n-1} = ((R_{n-1}^{\mathcal{S}} \otimes_{\mathbb{Z}} \mathbb{Z}^\varepsilon) \otimes_{\mathbb{Z}\mathcal{S}} \mathbb{Z}G) \cong \mathbb{Z}G$$



with  $R_{-1}^S = 0$ . The boundary homomorphism on  $R_*^G$  is

$$d_n: D_{1,n-1} \oplus D_{0,n} \rightarrow D_{1,n-2} \oplus D_{0,n-1}, x \oplus y \mapsto d_{n-1}^v(x) + (-1)^n d_{n-1}^h(x) + d_n^v(y)$$

where the ‘vertical’ homomorphisms  $d_n^v$  are induced by the boundary maps on  $R_*^U$  and  $R_*^S$ . The spectral sequence of a double complex together with the exactness of the complexes  $(D_{1,*}, d_*^v)$  and  $(D_{0,*}, d_*^v)$  imply that the free  $\mathbb{Z}G$ -chain complex  $R_*^G$  is a resolution of  $\mathbb{Z}$ . A contracting homotopy  $h_*: R_*^G \rightarrow R_{*+1}^G$  can be constructed from contracting homotopies  $h_*^U: R_*^U \rightarrow R_{*+1}^U$ ,  $h_*^S: R_*^S \rightarrow R_{*+1}^S$ ,  $h_0^h: C_0\mathcal{T} \rightarrow C_1\mathcal{T}$  using the formula

$$h_n(x \oplus y) = h_{n-1}^v(x) \oplus \{(-1)^n h_n^v d_n^h h_{n-1}^v(x) + h_n^v(y)\},$$

$$h_0(y) = h_0^h(y) \oplus \{h_0^v(y) - h_0^v d_0^h h_0^h(y)\}.$$

In the formula  $h_n^v, h_0^h$  denote the maps induced by tensoring. In summary, we have established the following.

**Proposition 5.1.** Let  $G = SL_2(\mathbb{Z})$ . A free  $\mathbb{Z}G$ -resolution  $R_*^G$  of  $\mathbb{Z}$  and contracting homotopy  $h_*: R_*^G \simeq \mathbb{Z}$  can be implemented on a computer, with  $R_0^G = \mathbb{Z}G$ ,  $R_n^G = \mathbb{Z}G \oplus \mathbb{Z}G$  for  $n \geq 1$ . Arbitrary elements  $w \in R_n^G$  can be expressed and their images  $d_n(w)$ ,  $h_n(w)$  can be uniquely determined. ■

## 6 Integral cohomology of congruence subgroups of $SL_2(\mathbb{Z})$

Let  $G = SL_2(\mathbb{Z})$  and let  $\Gamma$  denote a congruence subgroup for which we can algorithmically test membership  $A \in \Gamma$  for any matrix  $A$  in  $G$ . For instance,  $\Gamma$  could be one of the congruence subgroups  $\Gamma(N), \Gamma_1(N), \Gamma_0(N)$  of level  $N$ .

Suppose that  $\gamma$  acts on a connected graph  $K$  such that each vertex of  $K$  has trivial stabilizer group in  $\Gamma$ . If  $\Gamma = \Gamma(N)$  is the principal congruence subgroup then we could take  $K = \mathcal{T}$  to be the cubic tree. In general we could take  $K = \text{Cay}(G)$  to be the Cayley graph of  $G$  with respect to the generators  $S, U$ . The vertices of  $\text{Cay}(G)$  are the elements of  $G$  and there is a single edge between vertices  $A, A' \in G$  if, and only if,  $A^{-1}A' \in \{S, U\}$  or  $A'^{-1}A \in \{S, U\}$ .

We can choose some vertex  $v_0$  in  $K$  and, using the membership test for  $\Gamma$ , perform a breadth first search of the graph  $K$  in order to construct some connected subgraph  $D$  of  $K$  that contains  $v_0$  and that is maximal with respect to the property that the vertices of  $D$  belong to distinct orbits under the action of  $\Gamma$ . An edge of  $K$  with precisely one boundary vertex in  $D$  corresponds to an element of  $\Gamma$ , and the collection of such edges determines a finite generating set for  $\Gamma$ . This generating set likely contains many redundant generators, and we can try to form a smaller generating set by searching for obvious redundancies. Figure 2 (left) shows a maximal subtree  $D$  for the action of the principal congruence subgroup  $\Gamma(6)$  on the cubic tree  $\mathcal{T}$ ; it has 24 vertices, indicating that  $\Gamma(6)$  is of index  $144 = 6 \times 24$  in  $G$ ; the subtree yields a generating set of 13 generators for  $\Gamma(6)$ . Figure 2 (right) shows a maximal subtree  $D$  for the action of  $\Gamma_0(39)$  on the Cayley graph  $\text{Cay}(G)$ ; it has 56 vertices, indicating that  $\Gamma_0(39)$  is of index 56 in  $G$ ; the subtree yields a generating set of 18 generators for  $\Gamma_0(39)$ .

Given a set of generators for  $\Gamma$  we can enumerate cosets to form a transversal of  $\Gamma$  in  $G$  consisting of  $|G : \Gamma|$  coset representatives. Any free  $\mathbb{Z}G$ -resolution  $R_*^G$  is also a free  $\mathbb{Z}\Gamma$ -resolution, where  $\text{rank}_{\mathbb{Z}\Gamma}(R_n^G) = |G : \Gamma| \times \text{rank}_{\mathbb{Z}G}(R_n^G)$ . In light of Proposition 14.1, and the use of contracting homotopies to make algorithmic the element of choice in constructing Hecke operators, we have established the following.

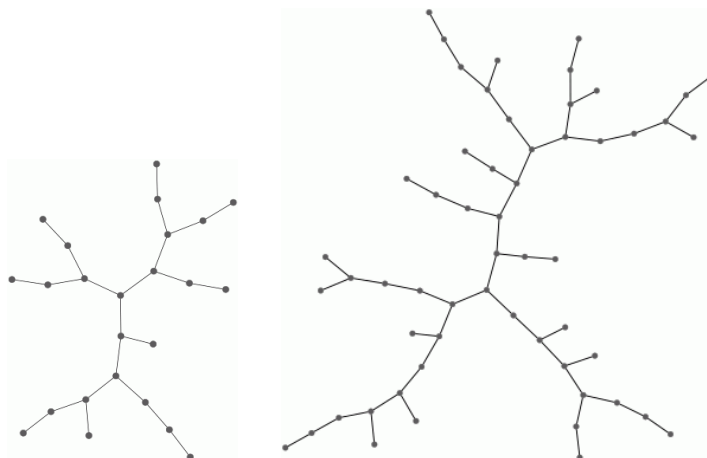

FIGURE 2. Connected subtrees  $D$  for the congruence subgroups  $\Gamma(6)$  (left) and  $\Gamma_0(39)$  (right).

**Proposition 6.1.** Let  $\Gamma$  be a congruence subgroup of  $G$  with an algorithmic membership test. We can implement the Hecke operator  $T_n: H^m(\Gamma, \mathbb{Z}) \rightarrow H^m(\Gamma, \mathbb{Z})$  on a computer. ■

**Example 6.2.** The following HAP commands compute the Hecke operators  $T_n: H^1(\Gamma(6), \mathbb{Z}) \rightarrow H^1(\Gamma(6), \mathbb{Z})$  on weight  $k = 2$  forms for  $n = 2, 5$  and confirm that  $T_2T_5 = T_5T_2$ .

```
gap> gamma:=HAP_PrincipalCongruenceSubgroup(6);;
gap> n:=2;;T2:=HeckeOperatorWeight2(gamma,n,1);;
gap> M2:=HomomorphismAsMatrix(T2);;Display(M2);
[ [ 1, 0, 0, 0, 0, 0, 0, 0, 0, 0, 0, 1, 0 ],
  [ 0, 0, 0, 0, 2, 0, 1, 0, 0, 0, -1, 0, 0 ],
  [ 0, 0, 0, 2, 0, 0, 0, 0, 0, 0, 0, 0, -1 ],
  [ 0, 0, 0, 0, 2, 0, 1, 0, 0, 0, -1, 0, 0 ],
  [ 0, 0, 0, 2, 0, 0, 0, 0, 0, 0, 0, 0, -1 ],
  [ 0, 1, 0, 0, 0, 0, 1, 1, 0, 0, -1, 0, 0 ],
  [ 0, 0, 0, 0, 0, 0, 1, 0, 0, 0, 1, 0, -1 ],
  [ 0, 0, 1, 0, 0, 1, 0, 0, 0, 0, 0, 0, -1 ],
  [ 0, 0, 0, 0, 0, 0, 0, 0, 1, 1, 0, 0, -1 ],
  [ 0, 0, 0, 0, 0, 0, 0, 0, 0, 0, 0, 0, 0 ],
  [ 0, 0, 0, 0, 0, 0, 1, 0, 0, 0, 1, 0, -1 ],
  [ 0, 0, 0, 0, 0, 0, 1, 0, 0, 0, 1, 0, -1 ],
  [ 0, 0, 0, 0, 0, 0, 0, 0, 0, 0, 0, 0, 0 ] ]
gap> n:=5;;T5:=HeckeOperatorWeight2(gamma,n,1);;
gap> M5:=HomomorphismAsMatrix(T5);;Display(M5);
[ [ 6, 0, 0, 0, 0, 0, 1, 0, 0, 0, -1, 0, -1 ],
  [ 0, 0, 6, 0, 0, 0, -1, 0, 0, 0, 1, 0, -2 ],
  [ 0, 6, 0, 0, 0, 0, 2, 0, 0, 0, -2, 0, 1 ],
  [ 0, 0, 0, 0, 6, 0, 3, 0, 0, 0, -3, 0, 0 ],
```

```

[ 0, 0, 0, 6, 0, 0, 0, 0, 0, 0, 0, 0, 0, -3 ],
[ 0, 0, 0, 0, 0, 0, 4, 6, 0, 0, -4, 0, -1 ],
[ 0, 0, 0, 0, 0, 0, 3, 0, 0, 0, 3, 0, -3 ],
[ 0, 0, 0, 0, 0, 6, 1, 0, 0, 0, -1, 0, -4 ],
[ 0, 0, 0, 0, 0, 0, -2, 0, 6, 0, 2, 0, -4 ],
[ 0, 0, 0, 0, 0, 0, 2, 0, 0, 6, -2, 0, -2 ],
[ 0, 0, 0, 0, 0, 0, 3, 0, 0, 0, 3, 0, -3 ],
[ 0, 0, 0, 0, 0, 0, -1, 0, 0, 0, 1, 6, 1 ],
[ 0, 0, 0, 0, 0, 0, 0, 0, 0, 0, 0, 0, 0 ] ]
gap> M2*M5=M5*M2;
true

```

## 7 Simple homotopy collapses

An obvious bottleneck in the above approach to cohomology calculations for congruence subgroups  $\Gamma \leq G = SL_2(\mathbb{Z})$  is the rank of the modules in the  $\mathbb{Z}G$ -resolution  $R_*^G$  when considered as free  $\mathbb{Z}\Gamma$ -modules.

**Example 7.1.** The congruence subgroup  $\Gamma = \Gamma_0(1000)$  is of index 1800 in  $G$ . Let  $S_*^\Gamma$  be the free  $\mathbb{Z}\Gamma$ -resolution of  $\mathbb{Z}$  obtained from the resolution  $R_*^G$  of Proposition 14.1 by considering each  $R_n^G$  as a  $\mathbb{Z}\Gamma$ -module. Then  $\text{rank}_{\mathbb{Z}\Gamma} S_0^\Gamma = 1800$  and  $\text{rank}_{\mathbb{Z}\Gamma} S_n^\Gamma = 3600$  for  $n \geq 1$ . To calculate, for example, the homology group  $H_5(\Gamma, \mathbb{Z}) = H_5(C_*)$  directly from the chain complex  $C_* = S_*^\Gamma \otimes_{\mathbb{Z}\Gamma} \mathbb{Z}$  would involve an application of the Smith Normal Form algorithm to a boundary matrix of dimensions  $3600 \times 3600$ , and such an application would challenge the efficient implementation of the SNF algorithm available in GAP. To avoid this challenge we could try to find a chain homotopy equivalence  $S_*^\Gamma \simeq T_*^\Gamma$  with  $T_*^\Gamma$  a smaller chain complex of free  $\mathbb{Z}\Gamma$ -modules and compute the required homology from the chain complex  $D_* = T_*^\Gamma \otimes_{\mathbb{Z}G} \mathbb{Z}$ ; alternatively we could try to compute a chain homotopy equivalence  $C_* \simeq D_*$  directly. The following HAP commands use the latter approach to compute  $H_5(\Gamma, \mathbb{Z}) = \mathbb{Z}_5$  in a way that involves an application of the SNF algorithm to a matrix of dimensions  $302 \times 302$ .

```

gap> gamma:=HAP_CongruenceSubgroupGamma0(1000);;
gap> R:=ResolutionSL2Z(1,6);;
gap> S:=ResolutionFiniteSubgroup(R,gamma);;
gap> C:=TensorWithIntegers(S);;
gap> List([0..5],C!.dimension);
[ 1800, 3600, 3600, 3600, 3600, 3600 ]
gap> D:=ContractedComplex(C);;
gap> List([0..5],D!.dimension);
[ 1, 302, 302, 302, 302, 302 ]
gap> Homology(D,5);
[ 2 ]

```

To explain how the homotopy equivalence  $C_* \simeq D_*$  was constructed in Example 7.1 let us consider an arbitrary chain complex  $C_*$  of free  $\Lambda$ -modules  $C_n$  where  $\Lambda$  is an associative (but not necessarily commutative) ring with identity. The examples we have in mind are  $\Lambda = \mathbb{Z}$  and  $\Lambda = \mathbb{Z}\Gamma$ . Let us denote the free generators of  $C_n$  by  $e_1^n, \dots, e_k^n$ ,  $k = \text{rank}_\Lambda C_n$ . The boundary homomorphism is given by  $d_n(e_i^n) = \lambda_{i1}e_1^{n-1} + \dots + \lambda_{i\ell}e_\ell^{n-1}$  with  $\ell = \text{rank}_\Lambda C_{n-1}$ . Suppose that for some particular

generator  $e_i^n$  one of the coefficients  $\lambda_{ij}$  is a unit in  $\Lambda$ . Let  $\langle e_i^n, d_n(e_i^n) \rangle$  denote the sub  $\Lambda$ -chain complex generated by  $e_i^n$  and  $d_n(e_i^n)$ . Since one of the coefficients is a unit, this sub chain complex has trivial homology, and the quotient chain complex  $C'_* = C_*/\langle e_i^n, d_n(e_i^n) \rangle$  is a chain complex of free  $\Lambda$ -modules. It follows from the exact homology sequence of a short exact sequence of chain complexes that the quotient chain map  $C_* \rightarrow C'_*$  is a quasi-isomorphism and thus homotopy equivalence of chain complexes. We say that  $C'_*$  is obtained from  $C_*$  by a *simple homotopy collapse* and write  $C_* \searrow C'_*$ . We can search, recursively, for a sequence of simple homotopy collapses  $C_* \searrow C'_* \searrow C''_* \searrow C'''_* \searrow \cdots \searrow D_*$  and use  $D_*$  in place of  $C_*$  in cohomology computations. Example 7.1 illustrates this technique for  $\Lambda = \mathbb{Z}$ . The next example illustrates the technique for  $\Lambda = \mathbb{Z}\Gamma$ .

**Example 7.2.** The congruence subgroup  $\Gamma = \Gamma_0(50)$  is of index 90 in  $G = SL_2(\mathbb{Z})$ . Let  $S_*^\Gamma$  be the free  $\mathbb{Z}\Gamma$ -resolution obtained from  $R_*^G$  by restricting the action. The following HAP commands construct a chain homotopy equivalence  $S_*^\Gamma \simeq T_*^\Gamma$  with  $\text{rank}_{\mathbb{Z}\Gamma} T_0^\Gamma = 1$ ,  $\text{rank}_{\mathbb{Z}\Gamma} T_n^\Gamma = 17$  for  $n \geq 1$  and use  $T_*^\Gamma$  to compute  $H^1(\Gamma, P_{\mathbb{C}}(4)) = \mathbb{Z}_2 \oplus \mathbb{Z}_4 \oplus \mathbb{Z}_{120} \oplus \mathbb{Z}^{174}$  and  $H^5(\Gamma, P_{\mathbb{C}}(4)) = \mathbb{Z}_2^{77}$ .

```
gap> gamma:=HAP_CongruenceSubgroupGamma0(50);;
gap> R:=ResolutionSL2Z(1,6);;
gap> S:=ResolutionFiniteSubgroup(R,gamma);;
gap> List([0..5],S!.dimension);
[ 90, 180, 180, 180, 180, 180 ]
gap> T:=ContractedComplex(S);;
gap> List([0..5],T!.dimension);
[ 1, 17, 17, 17, 17, 17 ]
gap> P:=HomogeneousPolynomials(gamma,4);;
gap> D:=HomToIntegralModule(T,P);;
gap> Cohomology(C,1);
[ 2, 4, 120, 0, 0, 0, 0, 0, 0, 0, 0, 0, 0, 0, 0, 0, 0, 0, 0, 0, 0, 0,
  0, 0, 0, 0, 0, 0, 0, 0, 0, 0, 0, 0, 0, 0, 0, 0, 0, 0, 0, 0, 0, 0,
  0, 0, 0, 0, 0, 0, 0, 0, 0, 0, 0, 0, 0, 0, 0, 0, 0, 0, 0, 0, 0, 0,
  0, 0, 0 ]
gap> Cohomology(D,5);
[ 2, 2, 2, 2, 2, 2, 2, 2, 2, 2, 2, 2, 2, 2, 2, 2, 2, 2, 2, 2, 2, 2, 2,
  2, 2, 2, 2, 2, 2, 2, 2, 2, 2, 2, 2, 2, 2, 2, 2, 2, 2, 2, 2, 2, 2,
  2, 2, 2, 2, 2, 2, 2, 2, 2, 2, 2, 2, 2, 2, 2, 2, 2, 2, 2, 2, 2 ]
```

## 8 Cuspidal cohomology of congruence subgroups of $SL_2(\mathbb{Z})$

The action (4.2) of  $G = SL_2(\mathbb{Z})$  on the upper-half plane  $\mathfrak{h}$  has a fundamental domain

$$D = \{z \in \mathfrak{h} : |z| > 1, |\text{Re}(z)| < \frac{1}{2}\} \cup \{z \in \mathfrak{h} : |z| \geq 1, |\text{Re}(z)| = -\frac{1}{2}\} \\ \cup \{z \in \mathfrak{h} : |z| = 1, -\frac{1}{2} \leq \text{Re}(z) \leq 0\}$$

shown in Figure 1. The action factors through an action of  $PSL_2(\mathbb{Z}) = SL_2(\mathbb{Z})/\langle \begin{pmatrix} -1 & 0 \\ 0 & -1 \end{pmatrix} \rangle$ .

The images of  $D$  under the action of  $PSL_2(\mathbb{Z})$  cover the upper-half plane, and any two images have at most a single point in common. The possible common points are in the orbit of the bottom

left-hand corner point  $-\frac{1}{2} + \mathbf{i}\frac{\sqrt{3}}{2}$  which is stabilized by  $\mathcal{U}$ , or in the orbit of the bottom middle point  $\mathbf{i}$  which is stabilized by  $\mathcal{S}$ .

A congruence subgroup  $\Gamma$  has a ‘fundamental domain’  $D_\Gamma$  equal to a union of finitely many copies of  $D$ , one copy for each coset in  $\Gamma \backslash SL_2(\mathbb{Z})$ . The quotient space  $X = \Gamma \backslash \mathfrak{h}$  is not compact, and can be compactified in several ways. We are interested in the Borel-Serre compactification. This is a space  $X^{BS}$  for which there is an inclusion  $X \hookrightarrow X^{BS}$  that is a homotopy equivalence. One defines the *boundary*  $\partial X^{BS} = X^{BS} - X$  and uses the inclusion  $\partial X^{BS} \hookrightarrow X^{BS} \simeq X$  to define the cuspidal cohomology group, over the ground ring  $\mathbb{C}$ , as

$$H_{cusp}^n(\Gamma, P_{\mathbb{C}}(k-2)) = \ker( H^n(X, P_{\mathbb{C}}(k-2)) \rightarrow H^n(\partial X^{BS}, P_{\mathbb{C}}(k-2)) ).$$

Strictly speaking, this is the definition of *interior cohomology*  $H_1^n(\Gamma, P_{\mathbb{C}}(k-2))$  which in general contains the cuspidal cohomology as a subgroup. However, for congruence subgroups of  $SL_2(\mathbb{Z})$  there is equality  $H_1^n(\Gamma, P_{\mathbb{C}}(k-2)) = H_{cusp}^n(\Gamma, P_{\mathbb{C}}(k-2))$ .

Working over  $\mathbb{C}$  has the advantage of avoiding the technical issue that  $\Gamma$  does not necessarily act freely on  $\mathfrak{h}$  since there may be points with finite cyclic stabilizer groups in  $SL_2(\mathbb{Z})$ . But it has the disadvantage of losing information about torsion in cohomology. We confront the issue by working with a contractible CW-complex  $\tilde{X}^{BS}$  on which  $\Gamma$  acts freely, and  $\Gamma$ -equivariant inclusion  $\partial \tilde{X}^{BS} \hookrightarrow \tilde{X}^{BS}$ . The definition of cuspidal cohomology that we use, which coincides with the above definition when working over  $\mathbb{C}$ , is

$$H_{cusp}^n(\Gamma, A) = \ker( H^n(\text{Hom}_{\mathbb{Z}\Gamma}(C_*(\tilde{X}^{BS}), A)) \rightarrow H^n(\text{Hom}_{\mathbb{Z}\Gamma}(C_*(\partial \tilde{X}^{BS}), A)) ). \quad (8.1)$$

The compact CW-complex  $X^{BS}$  is described by the CW-structure on the fundamental domain for its action of  $G$  shown in Figure 3 and the cell stabilizer groups  $Stab(e_1^0) = \mathcal{U} \cong C_6$ ,  $Stab(e_2^0) =$

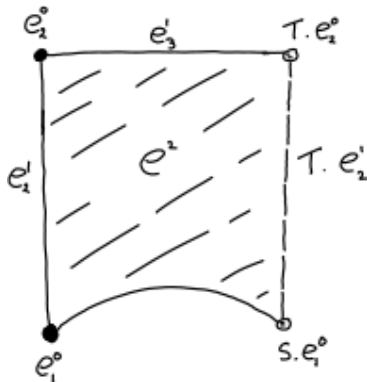

FIGURE 3. Fundamental domain for the action of  $PSL_2(\mathbb{Z})$  on  $X^{BS}$ .

$\langle U^3 \rangle \cong C_2$ ,  $Stab(e_1^1) = \mathcal{S} \cong C_4$ ,  $Stab(e_2^1) = \langle U^3 \rangle \cong C_2$ ,  $Stab(e_3^1) = \langle U^3 \rangle \cong C_2$ ,  $Stab(e^2) = \langle U^3 \rangle \cong C_2$ . The cellular chain complex  $C_* X^{BS}$  is a complex of  $\mathbb{Z}G$ -modules of the form

$$0 \longrightarrow \mathbb{Z}G \otimes_{C_2} \mathbb{Z} \longrightarrow \mathbb{Z}G \otimes_{C_4} \mathbb{Z}^\varepsilon \oplus \mathbb{Z}G \otimes_{C_2} \mathbb{Z} \oplus \mathbb{Z}G \otimes_{C_2} \mathbb{Z} \longrightarrow \mathbb{Z}G \otimes_{C_6} \mathbb{Z} \oplus \mathbb{Z}G \otimes_{C_2} \mathbb{Z} .$$

The process of using resolutions for cell stabilizer groups to convert the contractible  $\mathbb{Z}G$ -complex  $C_* \mathcal{T}$  into a free  $\mathbb{Z}G$ -resolution  $R_*^G$  can be adapted to the current setting. Resolutions for cell

stabilizers can be combined with the  $\mathbb{Z}G$ -complex  $C_*X^{BS}$  to produce a free  $\mathbb{Z}G$ -resolution  $C_*\tilde{X}^{BS}$ . The construction uses a perturbation technique of C.T.C. Wall [31] and explicit formulae for the construction in terms of contracting homotopies can be found in [12]. The following is a summary of the construction.

**Proposition 8.1.** [12] Let  $X$  be any contractible CW-complex on which some group  $G$  acts in a way that permutes cells. Suppose that for  $n \geq 0$  there are finitely many orbits of  $n$ -cells represented by  $e_1^n, e_2^n, \dots, e_{k_n}^n$ . Let  $G^{e_i^n}$  denote the subgroup of  $G$  stabilizing  $e_i^n$ . Suppose that we have free  $\mathbb{Z}G^{e_i^n}$ -resolutions  $R_*^{G^{e_i^n}}$  of  $\mathbb{Z}$ . Then there is a free  $\mathbb{Z}G$ -resolution  $R_*^G$  of  $\mathbb{Z}$  with

$$R_n^G = \bigoplus_{p+q=n, p, q \geq 0} (R_q^{G^{e_i^p}} \otimes_{\mathbb{Z}} \mathbb{Z}^{e_i^p}) \otimes_{\mathbb{Z}G^{e_i^p}} \mathbb{Z}G$$

where  $\mathbb{Z}^{e_i^p}$  denotes the integers with some action of  $G^{e_i^p}$ . An explicit formula for the boundary homomorphism  $d_n: R_n^G \rightarrow R_{n-1}^G$  can be given in terms of the boundary homomorphism on  $C_*X$  and the boundary homomorphisms and contracting homotopies for the resolutions of the stabilizer groups. An explicit formula for a contracting homotopy  $h_n: R_n^G \rightarrow R_{n+1}^G$  can also be given if, in addition, we have an explicit formula for a contracting homotopy  $h_*: C_*X \simeq \mathbb{Z}$ . ■

The free resolution  $C_*\tilde{X}^{BS}$  is of the form  $\text{rank}_{\mathbb{Z}G}(C_0\tilde{X}^{BS}) = 2$ ,  $\text{rank}_{\mathbb{Z}G}(C_1\tilde{X}^{BS}) = 5$ , and  $\text{rank}_{\mathbb{Z}G}(C_n\tilde{X}^{BS}) = 6$  for  $n \geq 2$ . Having constructed  $C_*\tilde{X}^{BS}$  it is routine to implement definition 8.1.

**Example 8.2.** The following HAP commands compute  $H_{cusp}^1(\Gamma_0(39), P_{\mathbb{Z}}(2)) \cong \mathbb{Z}^{24}$ .

```
gap> gamma:=HAP_CongruenceSubgroupGamma0(39);;
gap> k:=4;; deg:=1;; c:=CuspidalCohomologyHomomorphism(gamma,deg,k);;
gap> AbelianInvariants(Kernel(c));
[ 0, 0, 0, 0, 0, 0, 0, 0, 0, 0, 0, 0, 0, 0, 0, 0, 0, 0, 0, 0, 0, 0, 0, 0 ]
```

**Example 8.3.** The following HAP commands establish that  $S_2(\Gamma_0(11)) \cong \mathbb{C}$  is 1-dimensional with basis eigenform

$$f = q - 2q^2 - q^3 + q^4 + q^5 + 2q^6 - 2q^7 + 2q^8 - 3q^9 - 2q^{10} + \dots$$

```
gap> gamma:=HAP_CongruenceSubgroupGamma0(11);;
gap> AbelianInvariants(Kernel(CuspidalCohomologyHomomorphism(gamma,1,2)));
[ 0, 0 ]
gap> for n in [1..10] do
> Display(HomomorphismAsMatrix(HeckeOperatorWeight2(gamma,n,1)));;
> od;
[ [ 1, 0, 0 ], [ [ 3, -4, 4 ], [ [ 4, -4, 4 ], [ [ 6, -4, 4 ],
[ 0, 1, 0 ], [ 0, -2, 0 ], [ 0, -1, 0 ], [ 0, 1, 0 ],
[ 0, 0, 1 ] ] [ 0, 0, -2 ] ] [ 0, 0, -1 ] ] [ 0, 0, 1 ] ]
[ [ 6, -4, 4 ], [ [ 12, -8, 8 ], [ [ 8, -8, 8 ], [ [ 12, -8, 8 ],
[ 0, 1, 0 ], [ 0, 2, 0 ], [ 0, -2, 0 ], [ 0, 2, 0 ],
```

$$\begin{aligned}
& \left[ \begin{array}{ccc} 0 & 0 & 1 \end{array} \right] \left[ \begin{array}{ccc} 0 & 0 & 2 \end{array} \right] \left[ \begin{array}{ccc} 0 & 0 & -2 \end{array} \right] \left[ \begin{array}{ccc} 0 & 0 & 2 \end{array} \right] \\
& \left[ \begin{array}{ccc} 12 & -12 & 12 \end{array} \right], \left[ \begin{array}{ccc} 18 & -16 & 16 \end{array} \right], \\
& \left[ \begin{array}{ccc} 0 & -3 & 0 \end{array} \right], \left[ \begin{array}{ccc} 0 & -2 & 0 \end{array} \right], \\
& \left[ \begin{array}{ccc} 0 & 0 & -3 \end{array} \right] \left[ \begin{array}{ccc} 0 & 0 & -2 \end{array} \right]
\end{aligned}$$

For a normalized eigenform  $f = 1 + \sum_{s=2}^{\infty} a_s q^s$  the coefficients  $a_s$  with  $s$  a composite integer can be expressed in terms of the coefficients  $a_p$  for prime  $p$ . If  $r, s$  are coprime then  $a_{rs} = a_r a_s$ . If  $p$  is a prime that is not a divisor of the level  $N$  of  $\Gamma$  then  $a_{p^m} = a_{p^{m-1}} a_p - p a_{p^{m-2}}$ . If the prime  $p$  divides  $N$  then  $a_{p^m} = (a_p)^m$ . It thus suffices to compute the coefficients  $a_p$  for prime integers  $p$  only.

See Stein's paper [28] for other techniques for computing Fourier expansions of classical modular forms, in particular techniques using Manin symbols.

## 9 Arithmetic groups

Let  $m \geq 1$  be an integer and  $\mathbf{G}$  a subgroup of  $GL_m(\mathbb{C})$ . The group  $\mathbf{G}$  is said to be *linear algebraic over*  $\mathbb{Q}$  if there exist polynomials  $P_1, \dots, P_k$  with coefficients in  $\mathbb{Q}$  in the variables  $x_{ij}$ ,  $1 \leq i, j \leq m$  and  $y$  such that  $\mathbf{G}$  is the set of matrices  $g = (g_{ij}) \in GL_m(\mathbb{C})$  satisfying

$$P_1(g_{ij}, \det(g)^{-1}) = P_2(g_{ij}, \det(g)^{-1}) = \dots = P_k(g_{ij}, \det(g)^{-1}) = 0.$$

The group  $\mathbf{G}(\mathbb{Q}) = \mathbf{G} \cap GL_m(\mathbb{Q})$  is called the *group of rational points* of  $\mathbf{G}$ , and  $\mathbf{G}(\mathbb{Z}) = \mathbf{G} \cap GL_m(\mathbb{Z})$  is called the *group of integer points*.

Two groups  $\Gamma_1, \Gamma_2 \leq \mathbf{G}$  are said to be *comensurable* if the intersection  $\Gamma_1 \cap \Gamma_2$  is of finite index in both  $\Gamma_1$  and  $\Gamma_2$ .

Suppose that  $\mathbf{G}$  is linear algebraic over  $\mathbb{Q}$ . A subgroup  $\Gamma \leq \mathbf{G}(\mathbb{Q})$  is said to be an *arithmetic subgroup* of  $\mathbf{G}$  if it is comensurable with  $\mathbf{G}(\mathbb{Z})$ .

As an example,  $\mathbf{G} = SL_m(\mathbb{C})$  is linearly algebraic over  $\mathbb{Q}$  with  $\mathbf{G}(\mathbb{Q}) = SL_m(\mathbb{Q})$ ,  $\mathbf{G}(\mathbb{Z}) = SL_m(\mathbb{Z})$ . A subgroup  $\Gamma \leq SL_m(\mathbb{Q})$  is arithmetic if  $\Gamma \cap SL_m(\mathbb{Z})$  is of finite index in both  $\Gamma$  and  $SL_m(\mathbb{Z})$ . In particular, any finite index subgroup of  $SL_m(\mathbb{Z})$  is arithmetic. Throughout this example we could replace  $SL_m$  by  $PSL_m, GL_m, PGL_m, Sp_{2m}$ .

A more general example is that of a finite index subgroup  $\Gamma \leq SL_m(\mathcal{O})$  for  $\mathcal{O}$  the ring of integers of a number field  $F$  (a finite extension of  $\mathbb{Q}$ ). The group  $SL_m(F)$  can be viewed as  $\mathbf{G}(\mathbb{Q})$  where  $\mathbf{G} = Res_{F/\mathbb{Q}}(SL_2(F))$  is the restriction of scalars of  $SL_m(F)$  from  $F$  to  $\mathbb{Q}$  [26]. In subsequent sections of the paper we focus mainly on the case  $m = 2$  and  $F = \mathbb{Q}(\sqrt{d})$  for  $d \neq 1$  a square free integer, and discuss how the cohomology computations of the preceding sections could be extended to this setting.

## 10 Integral cohomology of $SL_2(\mathbb{Z}[\mathbf{i}])$

The group  $SL_2(\mathbb{C})$  acts on the *upper-half space*

$$\mathfrak{h}^3 = \{(z, t) \in \mathbb{C} \times \mathbb{R} \mid t > 0\}$$

in a well-known fashion. To describe the action we introduce the symbol  $\mathbf{j}$  satisfying  $\mathbf{j}^2 = -1$ ,  $\mathbf{i}\mathbf{j} = -\mathbf{j}\mathbf{i}$  where  $\mathbf{i} = \sqrt{-1}$ , and write  $z + t\mathbf{j}$  instead of  $(z, t)$ . The action is given by

$$\begin{pmatrix} a & b \\ c & d \end{pmatrix} \cdot (z + t\mathbf{j}) = \frac{a(z + t\mathbf{j}) + b}{c(z + t\mathbf{j}) + d}.$$

Alternatively, and more explicitly, the action is given by

$$\begin{pmatrix} a & b \\ c & d \end{pmatrix} \cdot (z + t\mathbf{j}) = \frac{(az + b)\overline{(cz + d)} + a\bar{c}t^2}{|cz + d|^2 + |c|^2t^2} + \frac{t}{|cz + d|^2 + |c|^2t^2} \mathbf{j}.$$

Let  $G = SL_2(\mathbb{Z}[\mathbf{i}]) = SL_2(\mathcal{O}_{-1})$ . A standard ‘fundamental domain’  $D$  for the restricted action of  $G$  on  $\mathfrak{h}^3$  is the region

$$D = \{z + t\mathbf{j} \in \mathfrak{h}^3 \mid 0 \leq |\operatorname{Re}(z)| \leq \frac{1}{2}, 0 \leq \operatorname{Im}(z) \leq \frac{1}{2}, z\bar{z} + t^2 \geq 1\} \quad (10.1)$$

shown in Figure 4 with some boundary points removed if one wants to minimize potential intersec-

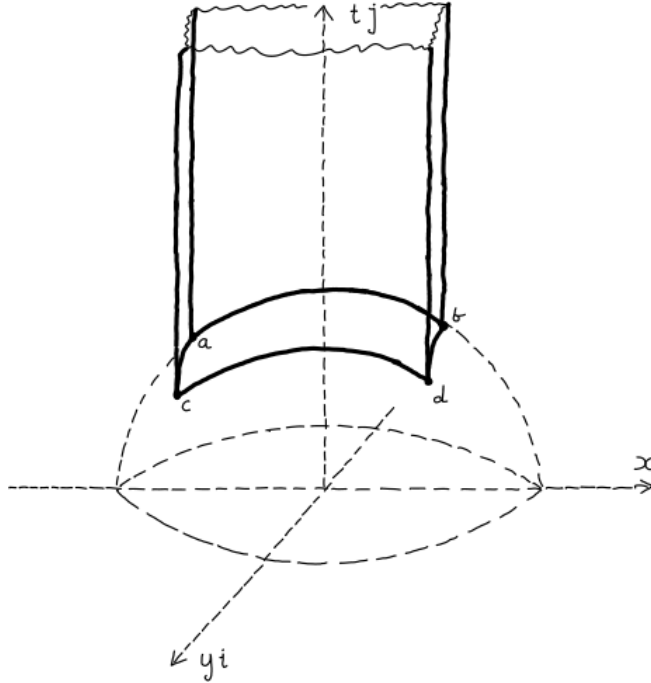

FIGURE 4. Portion of the non-compact fundamental domain for the action of  $SL_2(\mathcal{O}_{-1})$  on  $\mathfrak{h}^3$

tions  $D \cap gD$ ,  $g \in G$  of measure zero. The four bottom vertices of  $D$  are  $a = -\frac{1}{2} + \frac{\sqrt{3}}{2}\mathbf{j}$ ,  $b = \frac{1}{2} + \frac{\sqrt{3}}{2}\mathbf{j}$ ,  $c = -\frac{1}{2} + \frac{1}{2}\mathbf{i} + \frac{\sqrt{2}}{2}\mathbf{j}$ ,  $d = \frac{1}{2} + \frac{1}{2}\mathbf{i} + \frac{\sqrt{2}}{2}\mathbf{j}$ .

The upper-half space  $\mathfrak{h}^3$  can be retracted onto a 2-dimensional subspace  $\mathcal{T} \subset \mathfrak{h}^3$ , with  $\mathcal{T}$  a contractible 2-dimensional regular CW-complex, and where the action of  $G$  on  $\mathfrak{h}^3$  restricts to a cellular action of  $G$  on  $\mathcal{T}$ . Under the restricted action there is one orbit of 2-cells in  $\mathcal{T}$ , represented by the curvilinear square with vertices  $a$ ,  $b$ ,  $c$  and  $d$  in the picture. This 2-cell has stabilizer group isomorphic to the quaternion group  $Q_4$  of order 8. There are two orbits of 1-cells, both with stabilizer group isomorphic to a semi-direct product  $C_3 : C_4$ . There is one orbit of 0-cells, with stabilizer group isomorphic to  $SL(2, \mathbb{Z}_3)$ .





1.  $s, t$  are cells of  $X$  with  $\dim(t) = \dim(s) + 1$  and with  $s$  lying in the boundary of  $t$ . We say that  $s$  and  $t$  are *involved* in the arrow, that  $s$  is the *source* of the arrow, and that  $t$  is the *target* of the arrow.
2. any cell is involved in at most one arrow.

The term *discrete vector field* is due to [13]. In an earlier work [18] Jones calls this concept a *marking*. By a *chain* in a discrete vector field we mean a sequence of arrows

$$\dots, s_1 \rightarrow t_1, s_2 \rightarrow t_2, s_3 \rightarrow t_3, \dots$$

where the cell  $s_{i+1}$  lies in the boundary of  $t_i$  for each  $i$ . A chain is a *circuit* if it is of finite length with source  $s_1$  of the initial arrow  $s_1 \rightarrow t_1$  lying in the boundary of the target  $t_n$  of the final arrow  $s_n \rightarrow t_n$ . A discrete vector field is said to be *admissible* if it contains no circuits and no chains that extend infinitely to the right. We say that an admissible discrete vector field is *maximal* if it is not possible to add an arrow while retaining admissibility. A cell in  $X$  is said to be *critical* if it is not involved in any arrow. See Figure 5 for an example of a maximal discrete vector field on the cubic tree, involving just one critical cell.

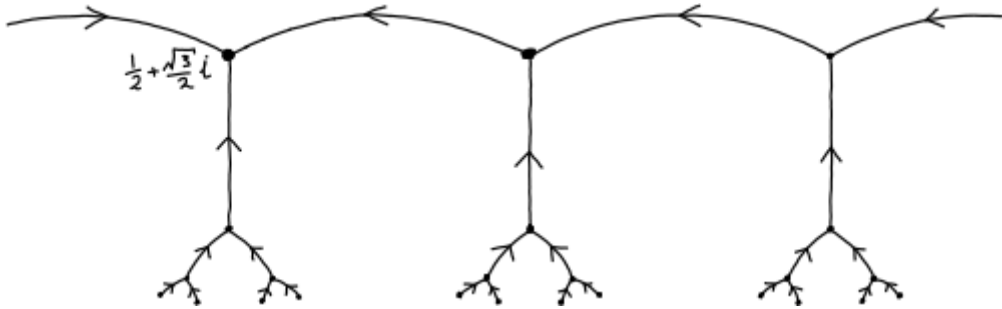

FIGURE 5. A portion of the cubic tree endowed with an admissible discrete vector field containing a single critical cell. Arrows  $e_i^0 \rightarrow e_{i'}^1$  are represented by arrow heads on the cell  $e_{i'}^1$ .

**Theorem 11.2.** [14, 13] If  $X$  is a regular CW-complex with admissible discrete vector field then there is a homotopy equivalence

$$X \simeq Y$$

where  $Y$  is a (possibly non-regular) CW-complex whose cells are in one-one correspondence with the critical cells of  $X$ .

An arrow on  $X$  can be viewed as representing a simple homotopy collapse, as introduced in [32]. The theorem just says that an admissible discrete vector field represents some sequence of simple homotopy collapses starting at  $X$  and ending at  $Y$ . At the level of cellular chain complexes, an admissible discrete vector field on  $X$  induces homomorphisms  $h_{n-1}: C_{n-1}X \rightarrow C_n X$  defined on generators by  $h_{n-1}(e_i^{n-1}) = e_{i'}^n$  if  $e_i^{n-1} \rightarrow e_{i'}^n$  is an arrow of the vector field, and  $h_{n-1}(e_i^{n-1}) = 0$  if  $e_i^{n-1}$  is not the source of any arrow. In the particular case where  $X$  has a single critical 0-cell and all other cells of  $X$  are involved in an arrow, the homomorphisms  $h_{n-1}$  constitute a contracting

chain homotopy  $H_*: C_*X \simeq \mathbb{Z}$ . The discrete vector field on the cubic tree pictured in Figure 5 corresponds to the contracting homotopy given in (4.3) and (4.1).

The group  $G = SL_2(\mathbb{Z}[\mathbf{i}])$  is generated by the matrices

$$S = \begin{pmatrix} 0 & -1 \\ 1 & 0 \end{pmatrix}, \quad T = \begin{pmatrix} 1 & 1 \\ 0 & 1 \end{pmatrix}, \quad A = \begin{pmatrix} -\mathbf{i} & 0 \\ 0 & \mathbf{i} \end{pmatrix}, \quad B = \begin{pmatrix} 1 & \mathbf{i} \\ 0 & 1 \end{pmatrix}, \quad -I = \begin{pmatrix} -1 & 0 \\ 0 & -1 \end{pmatrix}.$$

The matrix  $T$  acts on  $\mathfrak{h}^3$  as a unit translation along the real axis. The matrix  $B$  acts as a unit translation along the  $\mathbf{i}$  axis. The matrix  $S$  acts as  $(z + t\mathbf{j}) \mapsto -1/(z + t\mathbf{j})$ , and sends the edge  $ab$  of the fundamental domain  $D$  of Figure 4 onto itself. The matrix  $A$  acts as  $(z + t\mathbf{j}) \mapsto -z + t\mathbf{j}$  and interchanges points  $a$  and  $b$ . The matrix  $-I$  acts trivially.

Let  $\mathcal{T}$  denote the contractible 2-complex consisting of the images of the curvilinear square  $abcd$  under the action of  $G$ . The 2-complex  $\mathcal{T}$  is homeomorphic to the direct product of the cubic tree and the real line. A portion of  $\mathcal{T}$ , endowed with an admissible discrete vector field containing a single critical cell, is shown in Figure 6. Each cell of  $\mathcal{T}$  can be represented by its centre point

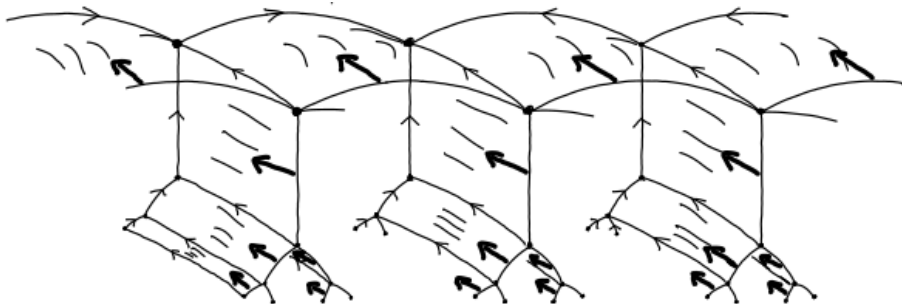

FIGURE 6. A portion of the 2-complex  $\mathcal{T}$  endowed with an admissible discrete vector field.

$A \cdot (z + t\mathbf{j})$  where  $A$  is a matrix in  $G$  and  $(z + t\mathbf{j})$  is the centre point of the orbit representative cell of the curvilinear fundamental region  $abcd$ . As in the case of the cubic tree, it is straightforward to encode the discrete vector field on  $\mathcal{T}$  as an algorithm using this representation of cells: each  $n$ -cell whose centre point has nontrivial  $\mathbf{i}$  component is the source of an arrow whose target is the centre point of an  $(n + 1)$ -cell whose centre has an  $\mathbf{i}$  component of smaller absolute value; the cubic tree is embedded in the plane with zero  $\mathbf{i}$  component and is endowed with the discrete vector field of Figure 5. The resulting contracting homotopy  $h_*: C_*X \simeq \mathbb{Z}$  can be used in accordance with Proposition 8.1 to implement a contracting homotopy on the free resolution  $R_*^G$ . Each cell of  $\mathcal{T}$  is stabilized by a finite subgroup of  $G$  with periodic cohomology, and for which we can thus construct an explicit periodic resolution. In summary, we have the following.

**Proposition 11.3.** Let  $G = SL_2(\mathbb{Z}[\mathbf{i}])$ . A free  $\mathbb{Z}G$ -resolution  $R_*^G$  of  $\mathbb{Z}$  and contracting homotopy  $h_*: R_*^G \simeq \mathbb{Z}$  can be implemented on a computer, with  $R_0^G = \mathbb{Z}G$ ,  $R_1^G = \mathbb{Z}G^4$ ,  $R_2^G = \mathbb{Z}G^7$ , and for  $n \geq 2$ ,  $R_{2n-1}^G = \mathbb{Z}G^7$ ,  $R_{2n}^G = \mathbb{Z}G^6$  ( $n$  even),  $R_{2n}^G = \mathbb{Z}G^8$  ( $n$  odd). Arbitrary elements  $w \in R_n^G$  can be expressed and their images  $d_n(w)$ ,  $h_n(w)$  can be uniquely determined. ■

This contracting homotopy on  $R_*^G$  has not yet been implemented in HAP.

## 12 Integral cohomology of $SL_2(\mathcal{O}_d)$ and other groups

To extend the above cohomological techniques to  $G = SL_2(\mathcal{O}_d)$  we require a contractible CW-complex  $\mathcal{T}$  in which  $G$  acts cellularly with cell stabilizers  $H$  for which we can compute a free  $\mathbb{Z}H$ -resolution  $R_*^H$ . There are two related approaches to computing such a  $\mathcal{T}$ , both of which are well-documented in the literature. One approach makes use of the fact that  $\mathfrak{h}^3$  is a metric space on which  $G$  acts discontinuously by isometries, and focuses on constructing a Dirichlet fundamental domain

$$D(v) = \{w \in \mathfrak{h}^3 : d(v, w) \leq d(gv, w) \text{ for all } g \in G\}$$

where  $v \in \mathfrak{h}^3$  is some suitable choice of point, and  $d(\cdot, \cdot)$  denotes the metric on  $\mathfrak{h}^3$ . The domain  $D(v)$  is defined as an intersection of half spaces  $\{w \in \mathfrak{h}^3 : d(v, w) \leq d(v, g \cdot v)\}$ , one half space for each  $g \in G$ . However, only finitely many of the half spaces are actually needed to determine  $D(v)$ ; using Poincaré's theorem (see [19]) this finite intersection can be implemented on a computer and used to determine the face lattice of  $D(v)$ . The required 2-dimensional regular CW-complex  $\mathcal{T}$  arises as the orbit of a homotopy retract of  $D(v)$ . For detailed accounts of the computation of  $D(v)$  the reader can consult papers of Swan [29], Riley [22] and the more recent theses of Aurel Page [20] and Alexander Rahm [21]. Details of  $\mathcal{T}$  for various groups  $SL_2(\mathcal{O}_d)$  have been computed by Rahm and stored as part of a library in HAP.

A second approach to computing  $\mathcal{T}$  uses Voronoi's theory of *perfect* quadratic forms. Let  $S_{>0}^m$  denote the space of positive definite symmetric  $m \times m$  matrices  $Q$ . Such a matrix  $Q$  corresponds to an  $m$ -dimensional quadratic form. The cone  $S_{>0}^m$  is contractible and  $A \in SL_2(\mathbb{Z})$  acts on  $S_{>0}^m$  via

$$(A, Q) \mapsto AQA^t$$

where  $Q^t$  denotes the transposed matrix. For a matrix  $Q \in S_{>0}^m$  and column vector  $v \in \mathbb{R}^m$  set

$$\begin{aligned} Q[v] &= v^t Q v, \\ \rho(v) &= v^t v \in S_{>0}^m, \\ \min(Q) &= \min_{0 \neq v \in \mathbb{Z}^m} Q[v], \\ \text{Min}(Q) &= \{v \in \mathbb{Z}^m : Q[v] = \min(Q)\}. \end{aligned}$$

A quadratic form  $Q[v]$  is said to be *perfect* if a quadratic form  $P[v]$  satisfies  $P[v] = \min(Q)$  for all  $v \in \text{Min}(Q)$  only if  $P = Q$ . For example, the quadratic form  $Q[x, y] = x^2 + xy + y^2$  has  $\min(Q) = 1$  and  $\text{Min}(Q) = \{(1, 0), (-1, 0), (0, 1), (0, -1), (1, -1), (-1, 1)\}$  and is perfect.

**Theorem 12.1** (Voronoi [30]). There are only finitely many perfect  $m$ -dimensional forms  $Q$  up to  $SL_m(\mathbb{Z})$ -equivalence, and the cells

$$\text{Dom}(Q) = \left\{ \sum_{v \in \text{Min}(Q)} \lambda_v \rho(v) : \lambda_v \geq 0 \right\}$$

tessellate (the rational closure of)  $S_{>0}^m$ .

**Theorem 12.2** (Ash [1]). There is an  $SL_m(\mathbb{Z})$ -equivariant  $\binom{m}{2}$ -dimensional CW-complex  $\mathcal{T}$  which is a homotopy retract of  $S_{=1}^m$ , where  $S_{=1}^m$  denotes the quotient of  $S_{>0}^m$  obtained by identifying scalar multiples.

Theorems 12.1, 12.2 can be extended to the case where  $\mathbb{Z}$  is replaced by  $\mathcal{O}_d$  and implemented on a computer as a method for determining the contractible CW-complex  $\mathcal{T}$ . A good account of this approach is given in [34, 6, 24]. Using this approach, Sebastian Schönnenbeck has computed a complex  $\mathcal{T}$  for various groups  $SL_2(\mathcal{O}_d)$  and stored its details as part of a library in HAP. Mathieu Dutour Sikrić [8] has also used the approach to compute, and store in HAP, higher-dimensional complexes  $\mathcal{T}$  for arithmetic groups such as  $SL_3(\mathbb{Z}[i])$ ,  $SL_4(\mathbb{Z})$ ,  $Sp_4(\mathbb{Z})$ .

**Example 12.3.** For a range of square-free values of  $d$  the HAP command

```
R:=ResolutionSL2QuadraticIntegers(d,n);;
```

returns  $n$  dimensions of a free  $\mathbb{Z}G$ -resolution  $R_*^G$  for  $G = SL_2(\mathcal{O}_d)$ . The HAP session of Example10.1 can be repeated with  $d = -2$  to establish:

$$\begin{aligned} H^1(SL_2(\mathcal{O}_{-2}), P_{\mathcal{O}_{-2}}(64)) &\cong \mathbb{Z}^2 \oplus \mathbb{Z}_2^5 \oplus \mathbb{Z}_6^6 \oplus \mathbb{Z}_{12} \oplus \mathbb{Z}_{24}^2 \oplus \mathbb{Z}_{48} \oplus \mathbb{Z}_{96} \oplus \mathbb{Z}_{192} , \\ H^2(SL_2(\mathcal{O}_{-2}), P_{\mathcal{O}_{-2}}(64)) &\cong \end{aligned}$$

$$\begin{aligned} &\mathbb{Z}^2 \oplus \mathbb{Z}_2^{34} \oplus \mathbb{Z}_6^3 \oplus \mathbb{Z}_{12}^9 \oplus \mathbb{Z}_{36}^3 \oplus \mathbb{Z}_{72}^6 \oplus \mathbb{Z}_{144} \oplus \mathbb{Z}_{4752}^4 \oplus \mathbb{Z}_{3792096}^2 \oplus \mathbb{Z}_{9347516640} \oplus \mathbb{Z}_{18695033280} \\ &\oplus \mathbb{Z}_{8223545796645304770924605527348196650673670016543148734143443796390563963212512724652966920933440} . \end{aligned}$$

The prime factorization of the largest torsion coefficient in the abelian invariant decomposition of  $H^2(SL_2(\mathcal{O}_{-2}), P_{\mathcal{O}_{-2}}(64))$  is

$$\begin{aligned} &2^6 \times 3^5 \times 5 \times 7 \times 11 \times 17 \times 19 \times 23 \times 29 \times 31 \times 37 \times 41 \times 43 \times 47 \times 53 \times 59 \times 61 \times 138493 \\ &\times 1367917218822877368259426449806293 \times 1856200299217477154598445936975567 . \end{aligned}$$

### 13 Integral cohomology of $PSL_2(\mathcal{O}_d)$ and $GL_2(\mathcal{O}_d)$

The contractible CW-complex  $\mathcal{T}$  used in the construction of a free resolution for  $SL_2(\mathcal{O}_d)$  can also be used, in a similar fashion, to construct a resolution for  $PSL_2(\mathcal{O}_d)$ . One just needs to quotient each of the finite stabilizer groups in  $SL_2(2, \mathcal{O}_d)$  by the group  $\langle -I \rangle$  with  $I$  the identity matrix. For instance, the HAP commands

```
gap> R:=ResolutionPSL2QuadraticIntegers(-11,3);;
gap> M:=HomogeneousPolynomials(R!.group,5,5);;
gap> C:=HomToIntegralModule(R,M);;
gap> Cohomology(C,2);
[ 2, 2, 2, 2, 2, 2, 2, 2, 2, 60, 660, 660, 660, 0, 0, 0, 0, 0, 0 ]
```

establish

$$H^2(PSL_2(\mathcal{O}_{-11}), P_{\mathcal{O}_{-11}}(5,5)) = (\mathbb{Z}_2)^8 \oplus \mathbb{Z}_{60} \oplus (\mathbb{Z}_{660})^3 \oplus \mathbb{Z}^6 \quad (13.1)$$

with coefficient module

$$P_{\mathcal{O}_{-d}}(k, \ell) = P_{\mathcal{O}_{-d}}(k) \otimes_{\mathcal{O}_{-d}} \overline{P_{\mathcal{O}_{-d}}(\ell)}$$

where the bar denotes a twist in the action obtained from complex conjugation. For an action of the projective linear group we must insist that  $k + \ell$  is even. The calculation (13.1) was first made

by Mehmet Haluk Sengun in [7] where he records many cohomology computations for Euclidean Bianchi groups  $PSL_2(\mathcal{O}_d)$ ,  $d = -1, -2, -3, -7, -11$ .

For an example involving a non-Euclidean Bianchi group, the above commands can be varied to calculate

$$H^2(PSL_2(\mathcal{O}_{-6}), P_{\mathcal{O}_{-6}}(64)) \cong \mathbb{Z}^4 \oplus A$$

where  $A$  is a finite abelian group of order equal to a 1429-digit integer; the invariant factor decomposition of  $A$  is a direct sum of 158 finite cyclic groups, the largest cyclic group having order equal to a 558-digit integer. GAP's standard integer factorization routines are unable to determine the prime decomposition of this 558-digit integer in reasonable time.

A free resolution for  $GL_2(\mathcal{O}_d)$  can be constructed using the short exact sequence

$$SL_2(\mathcal{O}_d) \twoheadrightarrow GL_2(\mathcal{O}_d) \xrightarrow{\det} U(\mathcal{O}_d) \quad (13.2)$$

in which  $U(\mathcal{O}_d)$  denotes the group of units of  $\mathcal{O}_d$ . When  $d$  is square-free negative the group  $U(\mathcal{O}_d)$  is finite of order 4 if  $d = -1$ , order 6 if  $d = -3$ , and order 2 otherwise. When  $d$  is square-free positive the group  $U(\mathcal{O}_d)$  is isomorphic to  $C_2 \times C_\infty$ . We can thus construct free resolutions  $R_*^{SL_2(\mathcal{O}_d)}$  and  $R_*^{U(\mathcal{O}_d)}$  for the kernel and image of the determinant homomorphism. The group  $GL_2(\mathcal{O}_d)$  acts on the chain complex  $R_*^{U(\mathcal{O}_d)}$  in a way that each element of  $R_*^{U(\mathcal{O}_d)}$  is stabilized by  $SL_2(\mathcal{O}_d)$ . Proposition 8.1 can be used to construct the required free resolution  $R_*^{GL_2(\mathcal{O}_d)}$ . This is implemented in HAP.

## 14 Contracting homotopies on contractible 2-complexes

Free  $\mathbb{Z}G$ -resolutions  $R_*^G$  for  $G = SL_2(\mathcal{O}_d)$  and  $G = PSL_2(\mathcal{O}_d)$  are implemented in HAP for various square-free integers  $d$  in both the real case  $d > 0$  (related to Hilbert modular forms) and imaginary case  $d < 0$  (related to Bianchi modular forms). However, currently no contracting homotopy is implemented on these resolutions. A contracting homotopy is required for the computation of Heck operators. The resolutions  $R_*^G$  are constructed from a contractible  $G$ -equivariant regular 2-dimensional CW-complex  $\mathcal{T}$ , and resolutions  $R_*^{G_i}$  for the finite stabilizer subgroups  $G_i$  of cells in  $\mathcal{T}$ , using Proposition 8.1. Contracting homotopies are currently implemented on the resolutions for stabilizer groups. From Proposition 8.1 a contracting chain homotopy  $h: C_*\mathcal{T} \simeq \mathbb{Z}$  is the only extra ingredient needed to implement a contracting homotopy on  $R_*^G$ . We shall explain how to construct such a contracting homotopy for square-free  $d < 0$  by showing how to construct an admissible discrete vector field on  $\mathcal{T}$  involving just one critical cell.

But first, it is worth noting there exist contractible regular 2-dimensional CW-complexes for which any admissible discrete vector field must have more than one critical cell. Figure 7 shows a famous example, *Bing's house*, arising as the union of finitely many closed unit squares in  $\mathbb{R}^3$ . The house is a 2-dimensional CW-complex involving two rooms, each room having a single entrance. The downstairs room is entered through an entrance on the roof of the house; the upstairs room is entered through an entrance on the bottom floor of the house. There exists no  $k$ -cell with a unique  $(k+1)$ -cell in its coboundary and so, because there are only finitely many cells, one requirement for admissibility is that some 2-cell needs to be critical in addition to any critical 0-cell.

Returning to the  $G$ -equivariant 2-complex  $\mathcal{T}$ , we first note that for any square-free  $d < 0$  this 2-complex is homeomorphic to the direct product of the cubic tree with the real line  $\mathbb{R}$ . The cellular

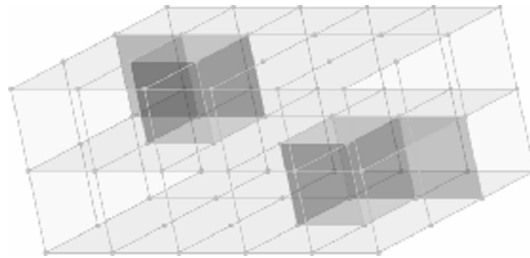

FIGURE 7. Bing’s house

structure on  $\mathcal{T}$  varies with  $d$ . Let us write  $\mathcal{T}_d$  to denote the 2-complex endowed with a  $G$ -equivariant cellular structure for  $G = SL_2(\mathcal{O}_d)$ . Let us write  $\mathcal{T}_0$  to denote the 1-dimensional  $SL_2(\mathbb{Z})$ -equivariant cubic tree with each vertex of degree three. Let  $\mathbb{R}$  denote the real line endowed with a CW-structure in which each integer  $n$  is a vertex and each open interval  $(n, n + 1)$  is an edge. We have seen in Figure 6 that for  $d = -1$  the CW-complex  $\mathcal{T}_{-1}$  is the direct product of CW-complexes  $\mathcal{T}_0 \times \mathbb{R}$ . For square-free  $d < 0$  the 2-complex  $\mathcal{T}_d$  is a cellular subdivision of  $\mathcal{T}_{-1}$  in which the cell structure on the copies of the cubic tree  $\mathcal{T}_0 \times n$  remains unchanged. Let the unit interval  $[0, 1]$  be given the CW-structure of two vertices and one edge. The closure of each 2-cell in  $\mathcal{T}_{-1}$  has the CW-structure of  $[0, 1] \times [0, 1]$ . In  $\mathcal{T}_d$  the cell structure on the closure of each 2-cell is some subdivision of this which restricts to the canonical CW-structure on  $[0, 1] \times 0$  and on  $[0, 1] \times 1$ . The subdivisions for  $\mathcal{T}_{-2}$  and  $\mathcal{T}_{-6}$  are shown in Figure 8.

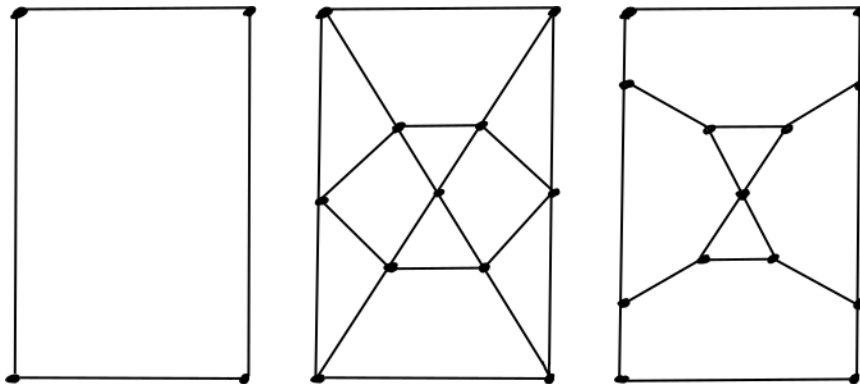

FIGURE 8. Cellular subdivision of  $[0, 1] \times [0, 1]$  for  $\mathcal{T}_{-1}$  (left),  $\mathcal{T}_{-2}$  (middle) and  $\mathcal{T}_{-6}$  (right)

The contracting discrete vector on  $\mathcal{T}_{-1}$  shown in Figure 6 can be modified to one for  $\mathcal{T}_d$ ,  $d < -1$ . The modification required is common to all subdivisions of  $[0, 1] \times [0, 1]$  and is shown in Figure 9 for  $\mathcal{T}_{-2}$  and  $\mathcal{T}_{-6}$ .

**Proposition 14.1.** Let  $G = SL_2(\mathcal{O}_d)$  for square-free  $d < 0$ . A free  $\mathbb{Z}G$ -resolution  $R_*^G$  of  $\mathbb{Z}$  and contracting homotopy  $h_* : R_*^G \simeq \mathbb{Z}$  can be implemented on a computer, with  $R_n^G$  finitely generated

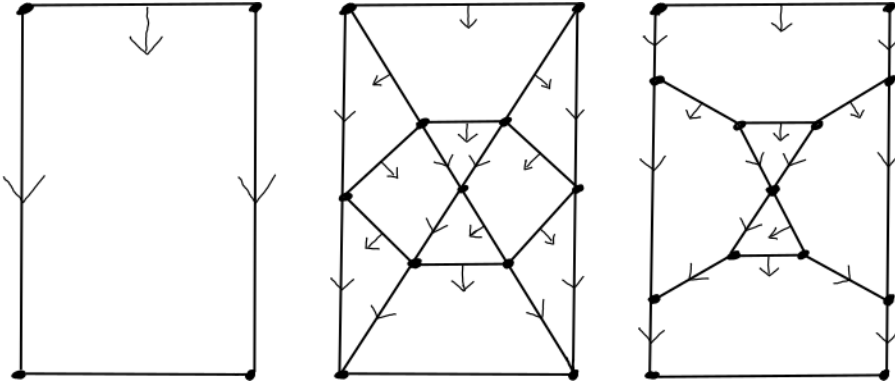

FIGURE 9. Portion of an admissible discrete vector field for  $\mathcal{T}_{-1}$  (left),  $\mathcal{T}_{-2}$  (middle) and  $\mathcal{T}_{-6}$  (right)

for all  $n \geq 0$ . Arbitrary elements  $w \in R_n^G$  can be expressed and their images  $d_n(w)$ ,  $h_n(w)$  can be uniquely determined. ■

## 15 Congruence subgroups of $SL_2(\mathcal{O}_d)$

For a square-free integer  $d$  the field  $K_d = \mathbb{Q}(\sqrt{d})$  can be constructed as a vector space of dimension 2 over  $\mathbb{Q}$  endowed with a multiplication. This construction, together with conjugation

$$K_d: \rightarrow K_d, a + b\sqrt{d} \mapsto a - b\sqrt{d},$$

the trace function

$$\text{tr}: K_d \rightarrow \mathbb{Q}, \alpha \mapsto \alpha + \bar{\alpha}$$

and norm

$$N: K_d^\times \rightarrow \mathbb{Q}^\times, \alpha \mapsto \alpha\bar{\alpha}$$

are readily implemented on a computer. An element of  $K$  is an *integer* if its minimal monic polynomial over  $\mathbb{Q}$  has coefficients in  $\mathbb{Z}$ . The ring of integers  $\mathcal{O}_d$  is readily implemented as a free abelian subgroup  $\mathcal{O}_d = \mathbb{Z} \oplus \omega\mathbb{Z} \subset K_d$  endowed with the same multiplication, where

$$\omega = \begin{cases} \sqrt{d} & \text{if } d \equiv 2, 3 \pmod{4}, \\ \frac{1+\sqrt{d}}{2} & \text{if } d \equiv 1 \pmod{4}. \end{cases}$$

An ideal  $\mathfrak{a} \triangleleft \mathcal{O}_d$  can be specified by giving any finite set that generates it as an ideal. The Smith Normal Form algorithm can be used to test whether an element  $\alpha \in \mathcal{O}_d$  belongs to  $\mathfrak{a}$ . It can also be used to implement addition and multiplication in the (finite) quotient ring  $\mathcal{O}_d/\mathfrak{a}$ . The norm of an ideal

$$N(\mathfrak{a}) = |\mathcal{O}_d/\mathfrak{a}|$$

can be defined as the number of elements in the quotient ring  $\mathcal{O}_d/\mathfrak{a}$  and can be determined from ideal generators using the Smith Normal Form algorithm. Since  $N(\mathfrak{a}\mathfrak{a}') = N(\mathfrak{a})N(\mathfrak{a}')$  an ideal is prime if its norm is a prime number. Conversely, an ideal is prime only if its norm is a prime  $p$  or



prime square  $p^2$ . Standard theory involving the quadratic character  $\chi_{K_d}$  can be used to determine whether an ideal of norm  $p^2$  is prime.

For any ideal  $\mathfrak{a} \triangleleft \mathcal{O}_d$  there is a canonical homomorphism  $\pi_{\mathfrak{a}}: SL_2(\mathcal{O}_d) \rightarrow SL_2(\mathcal{O}_d/\mathfrak{a})$ . A subgroup  $\Gamma \leq SL_2(\mathcal{O}_d)$  is said to be a *congruence subgroup* if it contains  $\ker \pi_{\mathfrak{a}}$ .

The 2-complex  $\mathcal{T}_d$  can be used to determine generators for  $G = SL_2(\mathcal{O}_d)$  in a fashion similar to how the cubic tree  $\mathcal{T}_0$  was used to determine generators for  $SL_2(\mathbb{Z})$ . Let  $\text{Cay}(G)$  denote the Cayley graph of  $G$  with respect to these generators. The action of  $G$  on  $\text{Cay}(G)$  restricts to an action of a congruence subgroup  $\Gamma \leq G$  of level  $\mathfrak{a}$  on  $\text{Cay}(G)$ . The ideal membership test for  $\mathfrak{a}$  can be used to implement a membership test for the group  $\Gamma$ , and this in turn can be used to compute a fundamental domain for the action of  $\Gamma$  on  $\text{Cay}(G)$ . The vertices of this fundamental domain correspond to the cosets of  $\Gamma$  in  $G$ . The fundamental domain for  $\Gamma$  can be used, for instance, to determine a generating set for  $\Gamma$ , the index of  $\Gamma$  in  $G$ , and representative for the cosets  $G/\Gamma$ .

**Example 15.1.** The following HAP commands construct the prime ideal  $\mathfrak{a} \triangleleft \mathcal{O}_{-1}$  in the Gaussian integers generated by the element  $41 + 56i$ , and then construct the congruence subgroup  $\Gamma_0(\mathfrak{a})$  of index 4818.

```
gap> K:=QuadraticNumberField(-1);
GaussianRationals
gap> OK:=RingOfIntegers(K);
O(GaussianRationals)
gap> a:=QuadraticIdeal(OK,41+56*Sqrt(-1));
ideal of norm 4817 in O(GaussianRationals)
gap> gamma:=HAP_CongruenceSubgroupGamma0(a);
<group of 2x2 matrices in characteristic 0>
gap> IndexInSL20(gamma);
4818
```

A maximal tree in the fundamental domain for the action of  $\Gamma_0(\mathfrak{a})$  on  $\text{Cay}(SL_2(\mathcal{O}_{-1}))$  is shown in Figure 10.



FIGURE 10. A maximal tree in a fundamental domain for  $\Gamma_0((41 + 56i))$ .

Our free  $\mathbb{Z}G$ -resolution  $R_*^G$  for  $G = SL_2(\mathcal{O}_d)$  can also be used as a free  $\mathbb{Z}\Gamma$ -resolution. Once the contracting homotopy of Section 14 is implemented on  $R_*^G$  ( $d < 0$ ), the resolution could be used to

compute Hecke operators on the integral cohomology of  $\Gamma$  using functions currently implemented in HAP.

If one is interested only in first integral homology then the explicit construction of a free  $\mathbb{Z}\Gamma$ -resolution can be avoided. One can work instead with a free presentation of  $\Gamma$  obtained by applying GAP's efficient implementation of the Reidemeister-Schreier algorithm to a presentation of  $G$ . The isomorphism  $\Gamma^{ab} = H_1(\Gamma, \mathbb{Z})$  yields the desired homology group.

**Example 15.2.** The following continuation of the HAP commands of Example 15.1 establish

$$H_1(\Gamma_0(\mathfrak{a}), \mathbb{Z}) \cong \mathbb{Z}_2^2 \oplus \mathbb{Z}_4 \oplus \mathbb{Z}_5 \oplus \mathbb{Z}_7 \oplus \mathbb{Z}_{16} \oplus \mathbb{Z}_{29} \oplus \mathbb{Z}_{43} \oplus \mathbb{Z}_{157} \oplus \mathbb{Z}_{179} \\ \oplus \mathbb{Z}_{1877} \oplus \mathbb{Z}_{7741} \oplus \mathbb{Z}_{22037} \oplus \mathbb{Z}_{292306033} \oplus \mathbb{Z}_{4078793513671}$$

for the ideal  $\mathfrak{a} \triangleleft \mathcal{O}_{-1}$  generated by  $41 + 56i$ .

```
gap> H1:=AbelianInvariants(gamma);
[ 2, 2, 4, 5, 7, 16, 29, 43, 157, 179, 1877, 7741, 22037, 292306033,
  4078793513671 ]
```

In relation to conjecture (3.1), the following commands approximate  $\lambda/18\pi = 0.0161957$  and  $\frac{\log |\Gamma_0(\mathfrak{a})_{tors}^{ab}|}{\text{Norm}(\mathfrak{a})} = 0.00913432$ .

```
gap> Lfunction(K,2)/(18*3.142);
0.0161957
gap> 1.0*Log(Product(H1),10)/Norm(a);
0.00913432
```

## References

- [1] Avner Ash. Deformation retracts with lowest possible dimension of arithmetic quotients of self-adjoint homogeneous cones. *Math. Ann.*, 225(1):69–76, 1977.
- [2] Avner Ash and Warren Sinnott. An analogue of Serre's conjecture for Galois representations and Hecke eigenclasses in the mod  $p$  cohomology of  $\text{GL}(n, \mathbb{Z})$ . *Duke Math. J.*, 105(1):1–24, 2000.
- [3] A. O. L. Atkin and J. Lehner. Hecke operators on  $\Gamma_0(m)$ . *Math. Ann.*, 185:134–160, 1970.
- [4] Nicolas Bergeron. Torsion homology growth in arithmetic groups. In *European Congress of Mathematics*, pages 263–287. Eur. Math. Soc., Zürich, 2018.
- [5] Nicolas Bergeron and Akshay Venkatesh. The asymptotic growth of torsion homology for arithmetic groups. *J. Inst. Math. Jussieu*, 12(2):391–447, 2013.
- [6] Oliver Braun, Renaud Coulangeon, Gabriele Nebe, and Sebastian Schönnenbeck. Computing in arithmetic groups with Voronoi's algorithm. *J. Algebra*, 435:263–285, 2015.

- [7] Mehmet Haluk Şengün. On the integral cohomology of Bianchi groups. *Exp. Math.*, 20(4):487–505, 2011.
- [8] M. Dutour-Sikrić. Data for complexes on which certain arithmetic groups act with nice stabilizer subgroups. *private communication*, 2011.
- [9] M. Eichler. Eine Verallgemeinerung der Abelschen Integrale. *Math. Z.*, 67:267–298, 1957.
- [10] G. Ellis. Computing group resolutions. *J. Symbolic Comput.*, 38(3):1077–1118, 2004.
- [11] G. Ellis. *HAP – Homological Algebra Programming, Version 1.21*, November 2019. (<http://www.gap-system.org/Packages/hap.html>).
- [12] G. Ellis, J. Harris, and E. Sköldberg. Polytopal resolutions for finite groups. *J. Reine Angew. Math.*, 598:131–137, 2006.
- [13] R. Forman. Morse theory for cell complexes. *Adv. Math.*, 134(1):90–145, 1998.
- [14] R. Forman. A user’s guide to discrete Morse theory. *Sém. Lothar. Combin.*, 48:Art. B48c, 35, 2002.
- [15] Jens Franke. Harmonic analysis in weighted  $L_2$ -spaces. *Ann. Sci. École Norm. Sup. (4)*, 31(2):181–279, 1998.
- [16] The GAP Group. *GAP – Groups, Algorithms, and Programming, Version 4.5.6*, 2013. (<http://www.gap-system.org>).
- [17] G. Harder. Eisenstein cohomology of arithmetic groups. The case  $GL_2$ . *Invent. Math.*, 89(1):37–118, 1987.
- [18] D.W. Jones. A general theory of polyhedral sets and the corresponding  $T$ -complexes. *Dissertationes Math. (Rozprawy Mat.)*, 266:110, 1988.
- [19] Bernard Maskit. On Poincaré’s theorem for fundamental polygons. *Advances in Math.*, 7:219–230, 1971.
- [20] A. Page. Computing fundamental domains for arithmetic kleinian groups. *Masters Thesis, Université Paris 7 –Diderot*, 2010.
- [21] A. Rahm. Cohomologies and  $k$ -theory of bianchi groups using computational geometric models. *Thesis, University of Grenoble*, 2010.
- [22] Robert Riley. Applications of a computer implementation of Poincaré’s theorem on fundamental polyhedra. *Math. Comp.*, 40(162):607–632, 1983.
- [23] Peter Scholze. On torsion in the cohomology of locally symmetric varieties. *Ann. of Math. (2)*, 182(3):945–1066, 2015.
- [24] Sebastian Schönneck. Resolutions for unit groups of orders. *J. Homotopy Relat. Struct.*, 12(4):837–852, 2017.

- [25] Goro Shimura. Sur les intégrales attachées aux formes automorphes. *J. Math. Soc. Japan*, 11:291–311, 1959.
- [26] Christophe Soulé. *An Introduction to Arithmetic Groups*, pages 247–276. Springer Berlin Heidelberg, Berlin, Heidelberg, 2007.
- [27] William Stein. *Modular forms, a computational approach*, volume 79 of *Graduate Studies in Mathematics*. American Mathematical Society, Providence, RI, 2007. With an appendix by Paul E. Gunnells.
- [28] William A. Stein. An introduction to computing modular forms using modular symbols. In *Algorithmic number theory: lattices, number fields, curves and cryptography*, volume 44 of *Math. Sci. Res. Inst. Publ.*, pages 641–652. Cambridge Univ. Press, Cambridge, 2008.
- [29] Richard G. Swan. Generators and relations for certain special linear groups. *Advances in Math.*, 6:1–77 (1971), 1971.
- [30] Georges Voronoi. Nouvelles applications des paramètres continus à la théorie des formes quadratiques. Premier mémoire. Sur quelques propriétés des formes quadratiques positives parfaites. *J. Reine Angew. Math.*, 133:97–102, 1908.
- [31] C. T. C. Wall. Resolutions for extensions of groups. *Proc. Cambridge Philos. Soc.*, 57:251–255, 1961.
- [32] J. H. C. Whitehead. Simple homotopy types. *Amer. J. Math.*, 72:1–57, 1950.
- [33] Gabor Wiese. *Computational arithmetic of modular forms*. Modulformen II, Wintersemester 2007/2008. Universität Duisburg-Essen, 2008.
- [34] Dan Yasaki. Hyperbolic tessellations associated to Bianchi groups. In *Algorithmic number theory*, volume 6197 of *Lecture Notes in Comput. Sci.*, pages 385–396. Springer, Berlin, 2010.