

# Introductory computations in the cohomology of arithmetic groups

Graham Ellis<sup>1</sup>

<sup>1</sup>School of Mathematics, NUI Galway, Ireland

E-mail: [graham.ellis@nuigalway.ie](mailto:graham.ellis@nuigalway.ie)<sup>1</sup>

## Abstract

This paper describes an approach to computer aided calculations in the cohomology of arithmetic groups. It complements existing literature on the topic by emphasizing homotopies and perturbation techniques, rather than cellular subdivision, as the tools for implementing on a computer topological constructions that fail to preserve cellular structures. Furthermore, it focuses on calculating integral cohomology rather than just rational cohomology or cohomology at large primes. In particular, the paper describes and fully implements algorithms for computing Hecke operators on the integral cuspidal cohomology of congruence subgroups  $\Gamma$  of  $SL_2(\mathbb{Z})$ , and then partially implements versions of the algorithms for the special linear group  $SL_2(\mathcal{O}_d)$  over various rings of quadratic integers  $\mathcal{O}_d$ . The approach is also relevant for computations on congruence subgroups of  $SL_m(\mathcal{O}_d)$ ,  $m \geq 2$ .

2000 *Mathematics Subject Classification.* **11F75.** .

*Keywords.* cohomology of arithmetic groups, computational algebra.

## 1 Introduction

This paper aims to provide an introduction to computer aided calculations in the cohomology of arithmetic groups up to a description, and partial computer implementation, of algorithms for computing Hecke operators on the cuspidal cohomology of congruence subgroups  $\Gamma$  of the special linear group of  $2 \times 2$  matrices  $SL_2(\mathcal{O})$  over various rings of quadratic integers  $\mathcal{O} = \mathcal{O}_d$  as well as over the usual integers  $\mathcal{O} = \mathbb{Z}$ . The approach complements existing literature on the topic by emphasizing homotopies and perturbation techniques, rather than cellular subdivision, as the tools for machine implementation of topological constructions that fail to preserve cellular structures. Furthermore, we focus on calculating integral cohomology rather than just rational cohomology or cohomology at large primes. Implementations are available as part of the HAP package [12] for the GAP system for computational algebra [18].

Section 2 recalls some well-known motivation for studying cohomology Hecke operators. Section 3 recalls some well-known motivation for computing with integral, rather than rational, cohomology. Sections 4–8 provide a fully implemented account of how to compute Hecke operators on the integral cuspidal cohomology of congruence subgroups of  $SL_2(\mathbb{Z})$ . Sections 9–13 provide a partially implemented account for congruence subgroups of  $SL_2(\mathcal{O}_d)$  over various rings  $\mathcal{O}_d$  of quadratic integers. The implementation is partial because the contracting homotopies of Section 13 are not yet implemented. The approach is also relevant for computations on congruence subgroups of  $SL_m(\mathcal{O}_d)$ ,  $m \geq 2$ , and this is touched on in Section 13.

## 2 The Eichler-Shimura isomorphism

The Eichler-Shimura isomorphism [10][34]

$$\varepsilon: S_k(\Gamma) \oplus \overline{S_k(\Gamma)} \oplus E_k(\Gamma) \xrightarrow{\cong} H^1(\Gamma, P_{\mathbb{C}}(k-2)) \quad (2.1)$$

relates the cohomology of groups to the theory of modular forms associated to a finite index subgroup  $\Gamma$  of  $SL_2(\mathbb{Z})$ . In subsequent sections we explain how to compute with the right-hand side of the isomorphism. But first, for completeness and for motivation, we define the ingredients of the isomorphism.

Let  $N$  be a positive integer. A subgroup  $\Gamma$  of  $SL_2(\mathbb{Z})$  is said to be a *congruence subgroup of level  $N$*  if it contains the kernel of the canonical homomorphism  $\pi_N: SL_2(\mathbb{Z}) \rightarrow SL_2(\mathbb{Z}_N)$  where  $\mathbb{Z}_N = \mathbb{Z}/N\mathbb{Z}$ . So any congruence subgroup is of finite index in  $SL_2(\mathbb{Z})$ . (To see that there exist finite index subgroups that are not congruence subgroups, one can use the presentation  $SL_2(\mathbb{Z}) \cong \langle S, U : S^4 = U^6 = 1, S^2 = U^3 \rangle$  to construct a surjective homomorphism  $\rho: SL_2(\mathbb{Z}) \twoheadrightarrow S_7$  onto the symmetric group of degree 7, mapping  $\rho(S) = (1, 2)(3, 5)(4, 6)$ ,  $\rho(U) = (2, 3, 4)(5, 6, 7)$ . The finite index subgroup  $\ker \rho$  is not a congruence subgroup since  $S_7$  is not a quotient of  $SL_2(\mathbb{Z}_m)$  for any  $m$ . This last assertion can be established using the fact that  $PSL_2(\mathbb{Z}_p)$  is simple for primes  $p > 2$ .) One congruence subgroup of particular interest is the kernel  $\Gamma(N) = \ker \pi_N$  itself, known as the *principal congruence subgroup* of level  $N$ . A second congruence subgroup of interest is the group  $\Gamma_1(N)$  consisting of those matrices that project to upper unitriangular matrices in  $SL_2(\mathbb{Z}_N)$ . Another congruence subgroup of particular interest is the group  $\Gamma_0(N)$  of those matrices that project to upper triangular matrices in  $SL_2(\mathbb{Z}_N)$ . Clearly  $\Gamma(N) \leq \Gamma_1(N) \leq \Gamma_0(N)$ .

Fix any finite index subgroup  $\Gamma \leq SL_2(\mathbb{Z})$ . A *modular form of weight  $k \geq 2$  and level  $\Gamma$*  is a complex valued function on the upper-half plane

$$f: \mathfrak{h} = \{z \in \mathbb{C} : \operatorname{Re}(z) > 0\} \rightarrow \mathbb{C}$$

such that for any  $\begin{pmatrix} a & b \\ c & d \end{pmatrix} \in \Gamma$  the following hold:

1.  $f\left(\frac{az+b}{cz+d}\right) = (cz+d)^k f(z)$  for all  $z \in \mathfrak{h}$ ,
2. the function  $(cz+d)^{-k} f\left(\frac{az+b}{cz+d}\right)$  is bounded as  $\operatorname{Im}(z) \rightarrow \infty$ ,
3.  $f$  is holomorphic on  $\mathfrak{h}$ .

The collection of all weight  $k$  modular forms for  $\Gamma$  form a vector space  $M_k(\Gamma)$  over  $\mathbb{C}$ .

A modular form  $f$  is said to be a *cuspidal form* if it satisfies the following:

- 2'. the function  $(cz+d)^{-k} f\left(\frac{az+b}{cz+d}\right) \rightarrow 0$  as  $\operatorname{Im}(z) \rightarrow \infty$ .

The collection of all weight  $k$  cuspidal forms for  $\Gamma$  form a vector space  $S_k(\Gamma)$ . There is a decomposition

$$M_k(\Gamma) \cong S_k(\Gamma) \oplus E_k(\Gamma)$$

involving a summand  $E_k(\Gamma)$  known as the *Eisenstein space*.

A function  $f: \mathfrak{h} \rightarrow \mathbb{C}$ ,  $z \mapsto u + \mathbf{i}v$  is said to be an *anti-holomorphic cusp form of weight  $k$*  if its complex conjugate  $\overline{f(z)} = u - \mathbf{i}v$  is a cusp form of weight  $k$ . The collection of all anti-holomorphic cusp forms of weight  $k$  form a vector subspace  $S_k(\Gamma)$ . See [36] for further introductory details on modular forms.

On the right-hand side of (2.1), the  $\mathbb{Z}\Gamma$ -module  $P_{\mathbb{C}}(k-2) \subset \mathbb{C}[x, y]$  denotes the space of homogeneous degree  $k-2$  polynomials over  $\mathbb{C}$  with action of  $\Gamma$  given by

$$\begin{pmatrix} a & b \\ c & d \end{pmatrix} \cdot p(x, y) = p(dx - by, -cx + ay) .$$

In particular  $P_{\mathbb{C}}(0) = \mathbb{C}$  is the trivial module. (In subsequent sections we compute with the integral analogue  $P_{\mathbb{Z}}(k-2) \subset \mathbb{Z}[x, y]$ , to which the action of  $\Gamma$  restricts.)

Each cohomology class  $[c] \in H^1(\Gamma, P_{\mathbb{C}}(k-2))$  is represented by a function  $c: \Gamma \rightarrow P_{\mathbb{C}}(k-2)$  satisfying the cocycle condition

$$c(\gamma\gamma') = \gamma \cdot c(\gamma') + c(\gamma)$$

for all  $\gamma, \gamma' \in \Gamma$ . We let  $Z^1(\Gamma, P_{\mathbb{C}}(k-2))$  denote the vector space of all such cocycles.

For any finite index subgroup  $\Gamma \leq SL_2(\mathbb{Z})$  the Eichler-Shimura map (2.1) is an isomorphism of vector spaces induced by the mapping

$$\varepsilon: M_k(\Gamma) \times \overline{S_k(\Gamma)} \longrightarrow Z^1(\Gamma, P_{\mathbb{C}}(k-2)), \quad (f, \bar{g}) \mapsto (c: \gamma \mapsto I_f(\mathbf{i}, \gamma\mathbf{i}) + I_{\bar{g}}(\mathbf{i}, \gamma\mathbf{i}))$$

where

$$I_f(\mathbf{i}, \gamma\mathbf{i}) = \int_{\mathbf{i}}^{\gamma\mathbf{i}} f(z)(xz + y)^{k-2} dz ,$$

$$I_{\bar{g}}(\mathbf{i}, \gamma\mathbf{i}) = \int_{\mathbf{i}}^{\gamma\mathbf{i}} \overline{g(z)}(xz + y)^{k-2} d\bar{z} .$$

See [42] for a full account of the Eichler-Shimura isomorphism.

In fact, the mapping (2.1) is more than an isomorphism of vector spaces. It is an isomorphism of Hecke modules: both sides admit the notion of *Hecke operator*, and the isomorphism preserves these operators. For our purposes it suffices to describe the cohomology operator.

A finite index subgroup  $\Gamma \leq SL_2(\mathbb{Z})$  and element  $g \in GL_2(\mathbb{Q})$  determine the finite index subgroup  $\Gamma' = \Gamma \cap g\Gamma g^{-1} \leq SL_2(\mathbb{Z})$  and homomorphisms

$$\Gamma \leftarrow \Gamma' \xrightarrow{\gamma \mapsto g^{-1}\gamma g} g^{-1}\Gamma'g \hookrightarrow \Gamma . \quad (2.2)$$

These homomorphisms give rise to homomorphisms of cohomology groups

$$H^n(\Gamma, P_{\mathbb{C}}(k-2)) \xleftarrow{tr} H^n(\Gamma', P_{\mathbb{C}}(k-2)) \xleftarrow{\alpha} H^n(g^{-1}\Gamma'g, P_{\mathbb{C}}(k-2)) \xleftarrow{\beta} H^n(\Gamma, P_{\mathbb{C}}(k-2))$$

with  $\alpha, \beta$  functorial maps, and  $tr$  the transfer map. We define the composite

$$T_g = tr \circ \alpha \circ \beta: H^n(\Gamma, P_{\mathbb{C}}(k-2)) \rightarrow H^n(\Gamma, P_{\mathbb{C}}(k-2)) \quad (2.3)$$

to be the *Hecke operator* determined by  $g$ . The homomorphism (2.3) induces homomorphisms

$$T_g: M_k(\Gamma) \rightarrow M_k(\Gamma) , \quad T_g: S_k(\Gamma) \rightarrow S_k(\Gamma) , \quad T_g: E_k(\Gamma) \rightarrow E_k(\Gamma) . \quad (2.4)$$

For  $\Gamma = \Gamma_0(N)$  and prime  $p \geq 1$  coprime to  $N$ , we define

$$T_p := T_g \quad \text{with} \quad g = \begin{pmatrix} 1 & 0 \\ 0 & \frac{1}{p} \end{pmatrix}.$$

This coincides with the classical Hecke operators  $T_n$  defined for  $n \geq 1$ . Further details on this description of Hecke operators can be found, for instance, in [36, Appendix by P. Gunnells].

Let  $f$  be a modular form of weight  $k \geq 2$  and level  $\Gamma$ . Suppose that the identity  $f(z+1) = f(z)$  holds for all  $z \in \mathfrak{h}$ . This identity certainly holds, for example, if  $\Gamma = \Gamma_0(N)$  or  $\Gamma = \Gamma_1(N)$ . The identity can be used to establish the existence of a convergent power series

$$f(z) = \sum_{n=0}^{\infty} a_n (e^{2\pi iz})^n = \sum_{n=0}^{\infty} a_n q^n \quad (2.5)$$

valid for all  $z \in \mathfrak{h}$ , where  $a_n$  are fixed complex numbers and  $q = e^{2\pi iz}$ . The form  $f$  is a cusp form if and only if  $a_0 = 0$ . A non-zero cusp form  $f \in S_k(\Gamma)$  is an *eigenform* if it is simultaneously an eigenvector for the Hecke operators  $T_n$  for all  $n = 1, 2, 3, \dots$ . An eigenform is said to be *normalized* if it has coefficient  $a_1 = 1$ . It turns out that if  $f$  is a normalized eigenform then the coefficient  $a_n$  is an eigenvalue for  $T_n$ .

For  $\Gamma = SL_2(\mathbb{Z})$  the vector space  $S_k(SL_2(\mathbb{Z}))$  admits a basis of eigenforms. Thus, in principle, one can construct an approximation to an explicit basis for the space  $S_k(SL_2(\mathbb{Z}))$  of weight  $k$  cusp forms simply by computing eigenvalues for Hecke operators.

For  $\Gamma = \Gamma_0(N)$  there again exist simultaneous eigenvectors for the Hecke operators  $T_n$  provided we let  $n$  range over only those integers coprime to  $N$ . This makes the computation of a basis for  $S_k(\Gamma_0(N))$  a little more involved. If  $M$  is a positive integer dividing  $N$ , and if  $d$  is a divisor of  $N/M$ , then there is a degeneracy map  $\beta_{M,d}: S_k(\Gamma_0(M)) \rightarrow S_k(\Gamma_0(N))$ . The *new subspace* of  $S_k(\Gamma_0(N))$  is denoted by  $S_k^{new}(\Gamma_0(N))$  and is defined to be the orthogonal complement, with respect to an inner product known as the *Petersson inner product*, of the images of all maps  $\beta_{M,d}$  for  $M|N$  and  $d|N/M$ . The elements of the new subspace are called *newforms*. Hecke operators restrict to the space of newforms. It was shown by Atkin and Lehner [3] that  $S_k^{new}(\Gamma_0(N))$  admits a basis of eigenforms, and that

$$S_k(\Gamma_0(N)) = \bigoplus_{M|N} \bigoplus_{d|N/M} \beta_{M,d}(S_k^{new}(\Gamma_0(M))).$$

Thus, in principle, one can construct an approximation to an explicit basis for the space  $S_k(\Gamma_0(N))$  of weight  $k$  cusp forms simply by computing eigenvalues for Hecke operators on the subspaces  $S_k^{new}(\Gamma_0(M))$  of newforms. (An illustration is given in Example 8.3 below for  $S_2(\Gamma_0(11))$ ). A formula for the dimension of the space of newforms [23] can be used to show that  $S_2(\Gamma_0(11)) = S_2^{new}(\Gamma_0(11))$ . Calculating bases of eigenforms is one motivation for computing Hecke operators on  $H^1(\Gamma_0(N), P_{\mathbb{C}}(k-2))$ .

The definition of Hecke operators given in (2.3) applies to the cohomology of any finite index subgroup  $\Gamma \leq SL_m(\mathbb{Z})$  where  $m \geq 2$ , with coefficients in any finitely generated  $\mathbb{Z}\Gamma$ -module  $\mathcal{P}$ . A theorem of Franke [17] asserts that: (i) for suitable  $\mathcal{P}$  the cohomology  $H^*(\Gamma, \mathcal{P})$  can be directly computed in terms of certain automorphic forms; and (ii) there is a decomposition  $H^*(\Gamma, \mathcal{P}) \cong H_{cusp}^*(\Gamma, \mathcal{P}) \oplus H_{eis}^*(\Gamma, \mathcal{P})$  involving a ‘cuspidal summand’ and an ‘Eisenstein summand’ analogous to the Eichler-Shimura isomorphism for  $m = 2$ . The computation of eigenvectors of Hecke operators,

in this setting, yields information on automorphic forms. The definition of Hecke operators applies even more generally to finite index subgroups of  $SL_m(\mathcal{O})$  with  $\mathcal{O}$  the ring of integers of an algebraic number field, using elements  $g \in GL_m(K)$  for the construction. The case  $m = 2$  and  $\mathcal{O}$  the ring of integers of a quadratic number field is considered in Sections 9–13, particularly the *Bianchi case* of imaginary quadratic number fields. In this Bianchi setting there is a Hecke equivariant isomorphism, analogous to the Eichler-Shimura isomorphism and due to Harder [20], between the space of ‘Bianchi modular forms’ and the first cohomology of  $\Gamma$  with ‘appropriate coefficients’.

### 3 Torsion

Let  $d$  be a square free integer, and let  $\mathcal{O}_d$  denote the ring of integers of the quadratic number field  $\mathbb{Q}(\sqrt{d})$ . Explicitly, we have  $\mathcal{O}_d = \{m + n\omega : m, n \in \mathbb{Z}\}$  where

$$\omega = \begin{cases} \sqrt{d} & \text{if } d \equiv 2, 3 \pmod{4}, \\ \frac{1+\sqrt{d}}{2} & \text{if } d \equiv 1 \pmod{4}. \end{cases}$$

Let  $\mathfrak{a} \triangleleft \mathcal{O}_d$  be a non-zero ideal. There is a canonical homomorphism  $\pi_{\mathfrak{a}}: SL_2(\mathcal{O}_d) \rightarrow SL_2(\mathcal{O}_d/\mathfrak{a})$ . A subgroup  $\Gamma \leq SL_2(\mathcal{O}_d)$  is said to be a *congruence subgroup of level  $\mathfrak{a}$*  if it contains  $\ker \pi_{\mathfrak{a}}$ . Thus congruence subgroups are of finite index. As above, we define  $\Gamma(\mathfrak{a}) = \ker \pi_{\mathfrak{a}}$  to be the *principal congruence subgroup* of level  $\mathfrak{a}$ . The congruence subgroup  $\Gamma_1(\mathfrak{a})$  consists of those matrices that project to upper unitriangular matrices in  $SL_2(\mathcal{O}_d/\mathfrak{a})$ . The congruence subgroup  $\Gamma_0(\mathfrak{a})$  consists of those matrices that project to upper triangular matrices in  $SL_2(\mathcal{O}_d/\mathfrak{a})$ .

For  $d > 0$  the group  $G = SL_2(\mathcal{O}_{-d})$  acts on the *upper-half space*

$$\mathfrak{h}^3 = \{(z, t) \in \mathbb{C} \times \mathbb{R} \mid t > 0\}$$

in such a way that any point  $(z, t) \in \mathfrak{h}^3$  has finite stabilizer group in  $G$ . The action is by isometries with respect to the hyperbolic metric on  $\mathfrak{h}^3$ . For this metric, geodesics are Euclidean semi-circles of radius  $0 < r \leq \infty$  that ‘meet’ the complex plane  $\mathbb{C}$  perpendicularly. Any finite index subgroup  $\Gamma \leq G$  gives rise to a non-compact quotient orbifold  $\mathfrak{h}^3/\Gamma$  of finite volume.

The first integral homology group  $H_1(\Gamma, \mathbb{Z})$  is finitely generated. Let  $\Gamma_{tors}^{ab}$  be its subgroup of finite order elements. Thus  $\Gamma_{tors}^{ab}$  denotes the maximal finite summand of  $H_1(\Gamma, \mathbb{Z})$ . Bergeron and Venkatesh [4, 5] have conjectured relationships between the torsion in the integral homology of congruence subgroups  $\Gamma$  and the volume of their quotient orbifold  $\mathfrak{h}^3/\Gamma$ . For instance, they conjecture

$$\frac{\log |\Gamma_0(\mathfrak{a})_{tors}^{ab}|}{\text{vol}(\mathfrak{h}^3/\Gamma_0(\mathfrak{a}))} \rightarrow \frac{1}{6\pi} \quad (3.1)$$

as the norm of the prime ideal  $\mathfrak{a} \triangleleft \mathcal{O}_{-d}$  tends to  $\infty$ .

Sequence (2.2), adapted to the current context, induces a composite homology homomorphism  $T_g: H_1(\Gamma, \mathbb{Z}) \rightarrow H_1(\Gamma, \mathbb{Z})$  associated to an element  $g \in SL_2(\mathbb{Q}(\sqrt{-d}))$  which we refer to as an homology *Hecke operator*. This restricts to a Hecke operator  $\Gamma_{tors}^{ab} \rightarrow \Gamma_{tors}^{ab}$  on the torsion part of  $\Gamma^{ab} = H_1(\Gamma, \mathbb{Z})$ . For simplicity, let us suppose that some prime  $p$  occurs with multiplicity 1 in the prime decomposition of the order  $|\Gamma_{tors}^{ab}|$ . A result of P. Scholze [31] implies, under the simplifying assumption, that any homology class  $\alpha \in H_1(\Gamma, \mathbb{Z})_p \cong \mathbb{Z}_p$  in the  $p$ -part of the homology (which is necessarily a Hecke eigenclass) gives rise to a representation  $\rho: \text{Gal}(\mathbb{Q}/\mathbb{Q}(\sqrt{-d})) \rightarrow GL_2(\mathbb{F}_p)$  with

various nice properties. Conjectures of Ash [2] and others suggest a converse to Scholze's theorem. See [4] for a more detailed discussion.

A computer investigation of the conjectures of Bergeron, Venkatesh, Ash and others is one reason for wanting algorithms to compute with integral homology and cohomology.

#### 4 Basic computations in $SL_2(\mathbb{Z})$

Let  $G = SL_2(\mathbb{Z})$ . The implementation of given elements of  $G$ , multiplication and division of elements of  $G$ , and the test for equality between elements of  $G$  is routine and available in all computer algebra packages. The test for whether a given  $2 \times 2$  integer matrix lies in  $G$  is an easy test of whether certain integer equations hold, and is routine to implement. The matrices

$$S = \begin{pmatrix} 0 & -1 \\ 1 & 0 \end{pmatrix} \quad \text{and} \quad T = \begin{pmatrix} 1 & 1 \\ 0 & 1 \end{pmatrix}$$

generate  $G$ . It is not difficult to devise an algorithm for expressing an arbitrary integer matrix  $A \in G$  as a word in  $S$  and  $T$ . An implementation of such an algorithm underlies the functions in HAP for computing Hecke operators on the cohomology of finite index subgroups of  $G$ , and so we describe it in some detail. We opt for a geometric description which has the merit of being readily adapted to form a key ingredient in the computation of Hecke operators for Bianchi groups.

Consider the matrix

$$U = ST = \begin{pmatrix} 0 & -1 \\ 1 & 1 \end{pmatrix}.$$

The matrices  $S$  and  $U$  also generate  $G$ . In fact we have a free presentation  $G = \langle S, U \mid S^4 = U^6 = 1, S^2 = U^3 \rangle$ . The *cubic tree*  $\mathcal{T}$  is a tree (*i.e.* a 1-dimensional contractible regular CW-complex) with countably infinitely many edges in which each vertex has degree 3. We can realize the cubic tree  $\mathcal{T}$  by taking the left cosets of  $\mathcal{U} = \langle U \rangle$  in  $G$  as vertices, and joining cosets  $x\mathcal{U}$  and  $y\mathcal{U}$  by an edge if, and only if,  $x^{-1}y \in \mathcal{U}S\mathcal{U}$ . Thus the vertex  $\mathcal{U}$  is joined to  $S\mathcal{U} = T\mathcal{U}$ ,  $US\mathcal{U} = STS\mathcal{U}$  and  $U^2S\mathcal{U} = T^{-1}\mathcal{U}$ . The vertices of this tree are in one-to-one correspondence with all *reduced words* in  $S, U, U^2$  that, apart from the identity word, end in  $S$  and that don't contain the substrings  $S^2$  or  $U^3$ . From this algebraic realization of the cubic tree we see that  $G$  acts on  $\mathcal{T}$  in such a way that there is a single orbit of vertices, and a single orbit of edges; each vertex is stabilized by a cyclic subgroup conjugate to  $\mathcal{U} = \langle U \rangle$  and each edge is stabilized by a cyclic subgroup conjugate to  $\mathcal{S} = \langle S \rangle$ .

Given a matrix  $A \in G$  we want to describe an algorithm for producing a reduced word  $w_A$  in  $S, U$  and  $U^2$  that represents the vertex  $A\mathcal{U}$  of  $\mathcal{T}$ . The word  $w_A$  furnishes the desired representation of  $A$  in terms of  $S$  and  $T$ . For  $A \in \mathcal{U}$  we take  $w_A$  to be the empty word. The algorithm recursively applies a procedure for determining a factorization

$$A = BX \tag{4.1}$$

of  $A \notin \mathcal{U}$ , where  $X \in \{S, US, U^2S\}$  and where the length of the reduced word  $w_B$  is less than that of  $w_A$ . One procedure for factorization (4.1) involves the standard action

$$\begin{pmatrix} a & b \\ c & d \end{pmatrix} \cdot z = \frac{az + b}{cz + d} \tag{4.2}$$

of a matrix in  $G$  on a point  $z$  in the upper half plane  $\mathfrak{h}$ . A geometric interpretation of the cubic tree is obtained by considering the singleton set and open arc

$$e^0 = \{\exp(i2\pi/3)\} \quad \text{and} \quad e^1 = \{\exp(i\theta) : \frac{\pi}{3} < \theta < \frac{2\pi}{3}\}.$$

The union  $e^0 \cup e^1$  is an arc of a Euclidean unit circle, with one end closed and the other end open. The orbit of  $e^0 \cup e^1$  under the action of  $G$  is a connected 1-dimensional CW-complex, illustrated in Figure 1. The images of  $e^0$  under the action are the 0-cells, and the images of  $e^1$  are the 1-cells. We denote this CW-complex by  $\mathcal{T}$  since it is isomorphic, as a graph, to the cubic tree constructed above. The matrix  $S$  acts on  $\mathfrak{h}$  as inversion in the unit circle centered at 0 followed by reflection

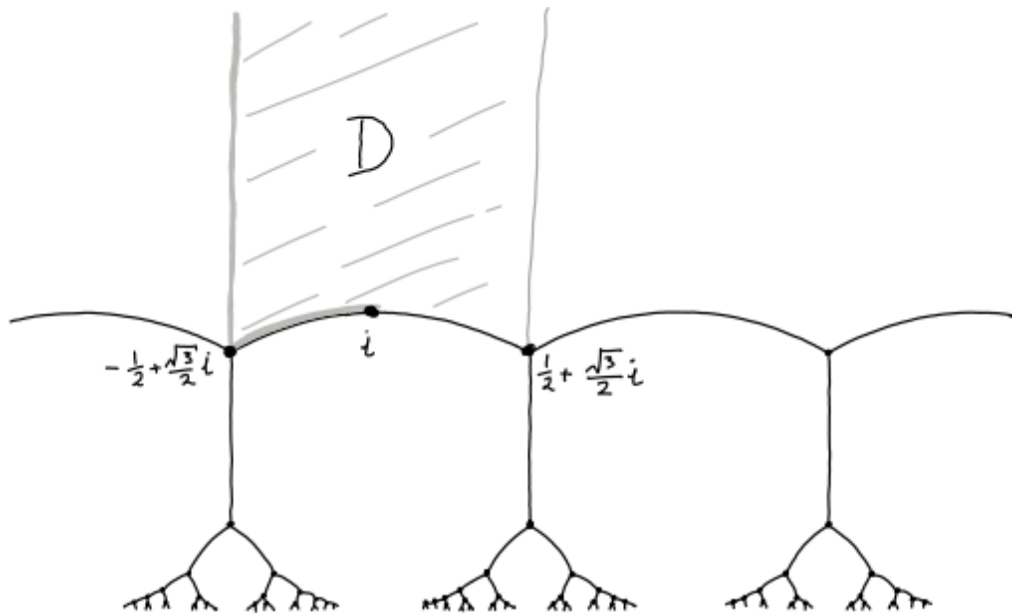

FIGURE 1. A portion of the cubic tree embedded in the upper-half plane  $\mathfrak{h}$ , together with a portion of a fundamental domain  $D$  for the action of  $SL_2(\mathbb{Z})$  on  $\mathfrak{h}$ .

in the imaginary axis,  $z \mapsto -1/z$ . The matrix  $T$  acts as a translation of one unit to the right,  $z \mapsto z + 1$ . The composite  $U = ST$  ‘rotates’ through one third of a clockwise turn the three edges of the cubic tree touching  $e^0$ .

To determine the factorization (4.1) we set  $z = \exp(i2\pi/3)$  and calculate the complex numbers  $A \cdot z$  and  $AX^{-1} \cdot z$  for  $X \in \{S, SU, SU^2\}$ . If for one of these three choices for  $X$  we find that the imaginary part of  $AX^{-1} \cdot z$  is greater than the imaginary part of  $A \cdot z$  then we set  $B = AX^{-1}$ ; otherwise for some  $X$  the absolute value of the real part of  $AX^{-1} \cdot z$  is smaller than the absolute value of the real part of  $A \cdot z$ , in which case we again set  $B = AX^{-1}$ .

Let  $C_*\mathcal{T}$  denote the cellular chain complex of the CW-complex  $\mathcal{T}$ . So  $C_n\mathcal{T}$  is the free abelian group with generators the  $n$ -cells of  $\mathcal{T}$ ,  $n = 0, 1$ , and  $d_1: C_1\mathcal{T} \rightarrow C_0\mathcal{T}$  is the boundary homomorphism. Let  $\mathcal{S} = \langle S \rangle$ . The action of  $G$  on  $\mathcal{T}$  induces  $\mathbb{Z}G$ -module structures  $C_0\mathcal{T} \cong \mathbb{Z}G \otimes_{\mathbb{Z}U} \mathbb{Z}$  and

$C_1\mathcal{T} \cong \mathbb{Z}G \otimes_{\mathbb{Z}\mathcal{S}} \mathbb{Z}^\varepsilon$  where  $\mathbb{Z}^\varepsilon$  denotes the integers with non-trivial action of  $\mathcal{S}$ , and where  $d_1$  is a homomorphism of  $\mathbb{Z}G$ -modules. The elements of  $C_0\mathcal{T}$  and  $C_1\mathcal{T}$  can be expressed as  $\gamma e^0$  and  $\gamma e^1$  respectively, with  $\gamma$  an element of the group ring  $\mathbb{Z}G$ . The boundary homomorphism is defined by  $d_1(\gamma e^1) = \gamma(1 - \gamma e^0)$ . The factorization (4.1) can be viewed as a homomorphism  $h_0: C_0\mathcal{T} \rightarrow C_1\mathcal{T}$  of free abelian groups, recursively defined on free generators by

$$h_0(Ae^0) = \begin{cases} 0, & \text{if } A \in \mathcal{U}, \\ Be^1 + h_0(Be^0), & \text{if } A \notin \mathcal{U}. \end{cases}$$

The homomorphism  $h_0$  is a *contracting homotopy*  $C_*\mathcal{T} \simeq \mathbb{Z}$  in the sense that

$$d_1 h_0 = 1 - \varepsilon, \quad h_0 d_1 = 1 \tag{4.3}$$

where  $\varepsilon: C_0 \rightarrow H_0(C_*\mathcal{T}) \cong \mathbb{Z} \hookrightarrow C_0\mathcal{T}$  is the canonical  $\mathbb{Z}$ -linear homomorphism onto the summand  $\mathbb{Z}e^0$  of  $C_0\mathcal{T}$ . The homomorphism  $h_0$  does not preserve the  $G$ -action. The above discussion is summarized in the following.

**Proposition 4.1.** The  $\mathbb{Z}G$ -chain complex

$$C_*\mathcal{T} = (\mathbb{Z}G \otimes_{\mathbb{Z}\mathcal{S}} \mathbb{Z}^\varepsilon \xrightarrow{d_1} \mathbb{Z}G \otimes_{\mathbb{Z}\mathcal{U}} \mathbb{Z})$$

and non-equivariant contracting homotopy  $h_*: C_*\mathcal{T} \simeq \mathbb{Z}$  can be implemented on a computer in such a way that arbitrary elements  $\gamma e^0 \in C_0\mathcal{T}$ ,  $\gamma e^1 \in C_1\mathcal{T}$  can be expressed and their images  $d_1(\gamma e^1)$ ,  $h_0(\gamma e^0)$  can be uniquely determined.  $\blacksquare$

## 5 Integral cohomology of $SL_2(\mathbb{Z})$

For any group  $Q$  let  $R_*^Q$  denote some free  $\mathbb{Z}Q$ -resolution of the trivial module  $\mathbb{Z}$ . In other words,  $R_*^Q$  is a chain complex of free  $\mathbb{Z}Q$ -modules with  $H_0(R_*^Q) \cong \mathbb{Z}$ ,  $H_n(R_*^Q) = 0$  for  $n > 0$ . The cohomology of  $Q$  with coefficients in the trivial  $Q$ -module  $\mathbb{Z}$  is defined as

$$H^n(Q, \mathbb{Z}) = H^n(\text{Hom}_{\mathbb{Z}Q}(R_*^Q, \mathbb{Z})) .$$

A free resolution  $R_*^Q$  always admits a contracting homotopy  $h_*: R_*^Q \simeq \mathbb{Z}$  consisting of a sequence of  $\mathbb{Z}$ -linear homomorphisms  $h_n: R_n^Q \rightarrow R_{n+1}^Q$  for  $n \geq 0$  satisfying  $d_{n+1}h_n + h_{n-1}d_n = 1$  ( $n > 0$ ),  $d_1 h^0 = 1 - \varepsilon$  where  $\varepsilon: R_0^Q \rightarrow H_0(R_*^Q) \cong \mathbb{Z} \hookrightarrow R_0^Q$  is the canonical  $\mathbb{Z}$ -linear homomorphism onto the summand  $\mathbb{Z}$  of  $R_0^Q$ .

Many theoretical constructions in the cohomology of groups involve repeated use of the following element of choice.

**Element of choice:** Given  $x \in \ker(d_n: R_n^Q \rightarrow R_{n-1}^Q)$  choose an element  $\tilde{x} \in R_{n+1}^Q$  such that  $d_{n+1}(\tilde{x}) = x$ .

If an algorithmic formula for a contracting homotopy on  $R_*^Q$  is to hand then the choice can be made algorithmic: one simply chooses  $\tilde{x} = h_n(x)$ .

For a cyclic group  $Q = \langle x : x^q = 1 \rangle$  one can choose  $R_n^Q = \mathbb{Z}Q$  for  $n \geq 0$ , and  $d_{2n-1}(1) = (x-1)$ ,  $d_{2n}(1) = (1+x+x^2+\dots+x^{q-1})$  for  $n > 0$ . A contracting homotopy is given by  $h_{2n}(x^k) = 1+x+x^2+\dots+x^{k-1}$ ,  $h_{2n+1}(x^{q-1}) = 1$ ,  $h_{2n+1}(x^\ell) = 0$  for  $\ell \neq q-1$ .



For the group  $G = SL_2(\mathbb{Z})$ , and specific cyclic subgroups  $\mathcal{U} = \langle U \rangle$ ,  $\mathcal{S} = \langle S \rangle$  we have

$$H_0(R_*^{\mathcal{U}} \otimes_{\mathbb{Z}\mathcal{U}} \mathbb{Z}G) \cong \mathbb{Z}G \otimes_{\mathbb{Z}\mathcal{U}} \mathbb{Z} = C_0\mathcal{T} \quad \text{and} \quad H_0((R_*^{\mathcal{S}} \otimes_{\mathbb{Z}} \mathbb{Z}^\varepsilon) \otimes_{\mathbb{Z}\mathcal{S}} \mathbb{Z}G) \cong \mathbb{Z}G \otimes_{\mathbb{Z}\mathcal{S}} \mathbb{Z}^\varepsilon = C_1\mathcal{T} .$$

The boundary homomorphism  $d_1: C_1\mathcal{T} \rightarrow C_0\mathcal{T}$  thus induces a chain homomorphism

$$d_*^h: (R_*^{\mathcal{S}} \otimes_{\mathbb{Z}} \mathbb{Z}^\varepsilon) \otimes_{\mathbb{Z}\mathcal{S}} \mathbb{Z}G \longrightarrow R_*^{\mathcal{U}} \otimes_{\mathbb{Z}\mathcal{U}} \mathbb{Z}G \quad (5.1)$$

between free  $\mathbb{Z}G$ -chain complexes. The superscript on  $d_*^h$  stands for ‘horizontal’. We regard (5.1) as a double complex, and let  $R_*^G$  denote its total complex. Explicitly  $R_n^G = D_{1,n-1} \oplus D_{0,n}$  where

$$D_{0,n} = (R_n^{\mathcal{U}} \otimes_{\mathbb{Z}\mathcal{U}} \mathbb{Z}G) \cong \mathbb{Z}G, \quad D_{1,n-1} = ((R_{n-1}^{\mathcal{S}} \otimes_{\mathbb{Z}} \mathbb{Z}^\varepsilon) \otimes_{\mathbb{Z}\mathcal{S}} \mathbb{Z}G) \cong \mathbb{Z}G$$

with  $R_{-1}^{\mathcal{S}} = 0$ . The boundary homomorphism on  $R_*^G$  is

$$d_n: D_{1,n-1} \oplus D_{0,n} \rightarrow D_{1,n-2} \oplus D_{0,n-1}, x \oplus y \mapsto d_{n-1}^v(x) + (-1)^n d_{n-1}^h(x) + d_n^v(y)$$

where the ‘vertical’ homomorphisms  $d_n^v$  are induced by the boundary maps on  $R_*^{\mathcal{U}}$  and  $R_*^{\mathcal{S}}$ . The spectral sequence of a double complex together with the exactness of the complexes  $(D_{1,*}, d_*^v)$  and  $(D_{0,*}, d_*^v)$  imply that the free  $\mathbb{Z}G$ -chain complex  $R_*^G$  is a resolution of  $\mathbb{Z}$ . A contracting homotopy  $h_*: R_*^G \rightarrow R_{*+1}^G$  can be constructed from contracting homotopies  $h_*^{\mathcal{U}}: R_*^{\mathcal{U}} \rightarrow R_{*+1}^{\mathcal{U}}$ ,  $h_*^{\mathcal{S}}: R_*^{\mathcal{S}} \rightarrow R_{*+1}^{\mathcal{S}}$ ,  $h_0^h: C_0\mathcal{T} \rightarrow C_1\mathcal{T}$  using the formula

$$h_n(x \oplus y) = h_{n-1}^v(x) \oplus \{(-1)^n h_n^v d_n^h h_{n-1}^v(x) + h_n^v(y)\},$$

$$h_0(y) = h_0^h(y) \oplus \{h_0^v(y) - h_0^v d_0^h h_0^h(y)\} .$$

In these formulas  $h_n^v, h_0^h$  denote the maps induced by tensoring. In summary, we have established the following.

**Proposition 5.1.** Let  $G = SL_2(\mathbb{Z})$ . A free  $\mathbb{Z}G$ -resolution  $R_*^G$  of  $\mathbb{Z}$  and contracting homotopy  $h_*: R_*^G \simeq \mathbb{Z}$  can be implemented on a computer, with  $R_0^G = \mathbb{Z}G$ ,  $R_n^G = \mathbb{Z}G \oplus \mathbb{Z}G$  for  $n \geq 1$ . Arbitrary elements  $w \in R_n^G$  can be expressed and their images  $d_n(w)$ ,  $h_n(w)$  can be uniquely determined. ■

## 6 Integral cohomology of congruence subgroups of $SL_2(\mathbb{Z})$

Let  $G = SL_2(\mathbb{Z})$  and let  $\Gamma$  denote a congruence subgroup for which we can algorithmically test membership  $A \in \Gamma$  for any matrix  $A$  in  $G$ . For instance,  $\Gamma$  could be one of the congruence subgroups  $\Gamma(N), \Gamma_1(N), \Gamma_0(N)$  of level  $N$ .

Let  $K = \text{Cay}(G)$  be the Cayley graph of  $G$  with respect to the generators  $S, U$ . The vertices of  $K$  are the elements of  $G$  and there is a single edge between vertices  $A, A' \in G$  if, and only if,  $A^{-1}A' \in \{S, U\}$  or  $A'^{-1}A \in \{S, U\}$ . We can choose some vertex  $v_0$  in  $K$  and, using the membership test for  $\Gamma$ , perform a breadth first search of the graph  $K$  in order to construct some connected subgraph  $D$  of  $K$  that contains  $v_0$  and that is maximal with respect to the property that the vertices of  $D$  belong to distinct orbits under the action of  $\Gamma$ . An edge of  $K$  with precisely one boundary vertex in  $D$  corresponds to an element of  $\Gamma$ , and the collection of such edges determines a finite generating set for  $\Gamma$ . This generating set likely contains many redundant generators, and we can try to form a smaller generating set by searching for obvious redundancies.

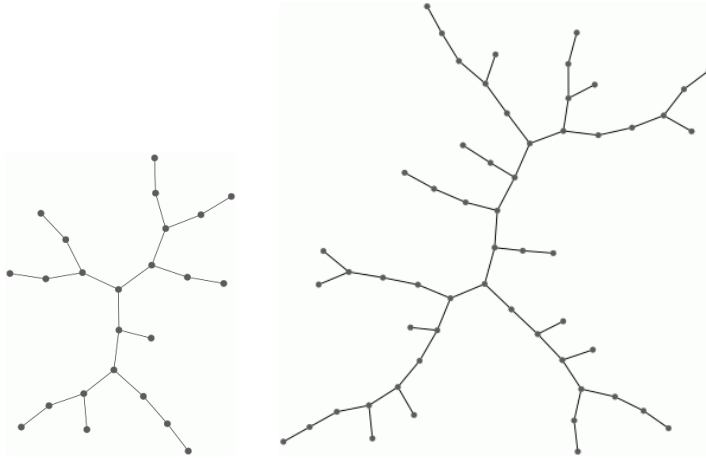

FIGURE 2. Connected subtrees  $D$  for the congruence subgroups  $\Gamma(6)$  (left) and  $\Gamma_0(39)$  (right).

Figure 2 (right) shows a maximal subtree  $D$  for the action of  $\Gamma_0(39)$  on the Cayley graph  $K = \text{Cay}(G)$ . It has 56 vertices, indicating that  $\Gamma_0(39)$  is of index 56 in  $G$ . The subtree yields a generating set for  $\Gamma_0(39)$  which, after elimination of obvious redundancies, consists of 18 generators. The vertices of  $D$  represent a transversal of  $\Gamma$  in  $G$  consisting of  $|G : \Gamma|$  coset representatives. In examples such as this, where  $D$  is fairly small, it is practical to determine the transversal element  $t$  representing an arbitrary element  $g \in G$  by naively iterating over the transversal until the transversal element  $t$  satisfying  $tg^{-1} \in \Gamma$  is found. This provides a permutation action  $G \rightarrow S_{|G:\Gamma|}$  of  $G$  on the transversal.

For larger index  $|G : \Gamma|$  it can be more efficient to work with a connected graph on which  $G$  acts so that the vertices have non-trivial stabilizer groups. In particular, for  $\Gamma = \Gamma_0(N)$  we can take  $K = \mathcal{T}$  to be the cubic tree so that each vertex has stabilizer group in  $G$  of order 6. The action of  $\Gamma$  on  $\mathcal{T}$  factors through an action of  $\bar{\Gamma} = \Gamma_0(N)/\langle S^2 \rangle \leq PSL_2(\mathbb{Z})$ . The group  $\bar{\Gamma}$  acts freely on the vertices of  $\mathcal{T}$ . We can thus use the above method to find a generating set for  $\bar{\Gamma}$  and lift it to a generating set for  $\Gamma$ . Figure 2 (left) shows a maximal subtree  $D$  for the action of the principal congruence subgroup  $\Gamma(6)$  on the cubic tree  $\mathcal{T}$ ; it has 24 vertices, indicating that  $\Gamma(6)$  is of index  $144 = 6 \times 24$  in  $G$ ; the subtree yields a generating set of 13 generators for  $\Gamma(6)$ .

Any free  $\mathbb{Z}G$ -resolution  $R_*^G$  is also a free  $\mathbb{Z}\Gamma$ -resolution, where  $\text{rank}_{\mathbb{Z}\Gamma}(R_n^G) = |G : \Gamma| \times \text{rank}_{\mathbb{Z}G}(R_n^G)$ . In light of Proposition 5.1, and the use of contracting homotopies to make algorithmic the element of choice in constructing Hecke operators, we have established the following.

**Proposition 6.1.** Let  $\Gamma$  be a congruence subgroup of  $G$  with an algorithmic membership test. We can implement the Hecke operator  $T_n : H^m(\Gamma, \mathbb{Z}) \rightarrow H^m(\Gamma, \mathbb{Z})$  on a computer.  $\blacksquare$

**Example 6.2.** The following HAP commands compute the Hecke operators  $T_n : H^1(\Gamma(6), \mathbb{Z}) \rightarrow H^1(\Gamma(6), \mathbb{Z})$  on weight  $k = 2$  forms for  $n = 2, 5$  and confirm that  $T_2T_5 = T_5T_2$ .

```
gap> gamma:=HAP_PrincipalCongruenceSubgroup(6);;
gap> n:=2;;T2:=HeckeOperatorWeight2(gamma,n,1);;
```

```

gap> M2:=HomomorphismAsMatrix(T2);;Display(M2);
[ [ 1, 0, 0, 0, 0, 0, 0, 0, 0, 0, 0, 0, 1, 0 ],
  [ 0, 0, 0, 0, 2, 0, 1, 0, 0, 0, 0, -1, 0, 0 ],
  [ 0, 0, 0, 2, 0, 0, 0, 0, 0, 0, 0, 0, 0, -1 ],
  [ 0, 0, 0, 0, 2, 0, 1, 0, 0, 0, 0, -1, 0, 0 ],
  [ 0, 0, 0, 2, 0, 0, 0, 0, 0, 0, 0, 0, 0, -1 ],
  [ 0, 1, 0, 0, 0, 0, 1, 1, 0, 0, 0, -1, 0, 0 ],
  [ 0, 0, 0, 0, 0, 0, 1, 0, 0, 0, 0, 1, 0, -1 ],
  [ 0, 0, 1, 0, 0, 1, 0, 0, 0, 0, 0, 0, 0, -1 ],
  [ 0, 0, 0, 0, 0, 0, 0, 0, 1, 1, 0, 0, 0, -1 ],
  [ 0, 0, 0, 0, 0, 0, 0, 0, 0, 0, 0, 0, 0, 0 ],
  [ 0, 0, 0, 0, 0, 0, 1, 0, 0, 0, 0, 1, 0, -1 ],
  [ 0, 0, 0, 0, 0, 0, 1, 0, 0, 0, 0, 1, 0, -1 ],
  [ 0, 0, 0, 0, 0, 0, 0, 0, 0, 0, 0, 0, 0, 0 ] ]
gap> n:=5;;T5:=HeckeOperatorWeight2(gamma,n,1);;
gap> M5:=HomomorphismAsMatrix(T5);;Display(M5);
[ [ 6, 0, 0, 0, 0, 0, 1, 0, 0, 0, -1, 0, -1 ],
  [ 0, 0, 6, 0, 0, 0, -1, 0, 0, 0, 1, 0, -2 ],
  [ 0, 6, 0, 0, 0, 0, 2, 0, 0, 0, -2, 0, 1 ],
  [ 0, 0, 0, 0, 6, 0, 3, 0, 0, 0, -3, 0, 0 ],
  [ 0, 0, 0, 6, 0, 0, 0, 0, 0, 0, 0, 0, -3 ],
  [ 0, 0, 0, 0, 0, 0, 4, 6, 0, 0, -4, 0, -1 ],
  [ 0, 0, 0, 0, 0, 0, 3, 0, 0, 0, 3, 0, -3 ],
  [ 0, 0, 0, 0, 0, 6, 1, 0, 0, 0, -1, 0, -4 ],
  [ 0, 0, 0, 0, 0, 0, -2, 0, 6, 0, 2, 0, -4 ],
  [ 0, 0, 0, 0, 0, 0, 2, 0, 0, 6, -2, 0, -2 ],
  [ 0, 0, 0, 0, 0, 0, 3, 0, 0, 0, 3, 0, -3 ],
  [ 0, 0, 0, 0, 0, 0, -1, 0, 0, 0, 1, 6, 1 ],
  [ 0, 0, 0, 0, 0, 0, 0, 0, 0, 0, 0, 0, 0 ] ]
gap> M2*M5=M5*M2;
true

```

For  $\Gamma = \Gamma_0(N)$  a permutation action  $G \rightarrow S_{|G:\Gamma_0(N)|}$  can be constructed more efficiently using the following well-known result which we recall from [37], particularly when  $N$  is prime. See [7, Proposition 2.2.2] for a proof.

Let

$$\mathbb{P}^1(\mathbb{Z}_N) = \{(a : b) \mid a, b \in \mathbb{Z}_N, \gcd(a, b, N) = 1\} / \sim$$

where  $(a : b) \sim (a' : b')$  if there is a unit  $u$  in  $\mathbb{Z}_N$  such that  $a = ua', b = ub'$ .

**Proposition 6.3.** There is an equivariant bijection between  $\mathbb{P}^1(\mathbb{Z}_N)$  and the right cosets of  $\Gamma_0(N)$  in  $SL_2(\mathbb{Z})$ , which sends a coset representative  $\begin{pmatrix} a & b \\ c & d \end{pmatrix}$  to the class of  $(c : d)$  in  $\mathbb{P}^1(\mathbb{Z}_N)$ .

## 7 Simple homotopy collapses

An obvious bottleneck in the above approach to cohomology calculations for congruence subgroups  $\Gamma \leq G = SL_2(\mathbb{Z})$  is the rank of the modules in the  $\mathbb{Z}G$ -resolution  $R_*^G$  when considered as free

$\mathbb{Z}\Gamma$ -modules.

**Example 7.1.** The congruence subgroup  $\Gamma = \Gamma_0(1000)$  is of index 1800 in  $G$ . Let  $S_*^\Gamma$  be the free  $\mathbb{Z}\Gamma$ -resolution of  $\mathbb{Z}$  obtained from the resolution  $R_*^G$  of Proposition 5.1 by considering each  $R_n^G$  as a  $\mathbb{Z}\Gamma$ -module. Then  $\text{rank}_{\mathbb{Z}\Gamma} S_0^\Gamma = 1800$  and  $\text{rank}_{\mathbb{Z}\Gamma} S_n^\Gamma = 3600$  for  $n \geq 1$ . To calculate, for example, the homology group  $H_5(\Gamma, \mathbb{Z}) = H_5(C_*)$  directly from the chain complex  $C_* = S_*^\Gamma \otimes_{\mathbb{Z}\Gamma} \mathbb{Z}$  would involve an application of the Smith Normal Form algorithm to a boundary matrix of dimensions  $3600 \times 3600$ , and such an application would challenge the efficient implementation of the SNF algorithm available in GAP. To avoid this challenge we could try to find a chain homotopy equivalence  $S_*^\Gamma \simeq T_*^\Gamma$  with  $T_*^\Gamma$  a smaller chain complex of free  $\mathbb{Z}\Gamma$ -modules and compute the required homology from the chain complex  $D_* = T_*^\Gamma \otimes_{\mathbb{Z}\Gamma} \mathbb{Z}$ ; alternatively we could try to compute a chain homotopy equivalence  $C_* \simeq D_*$  directly. The following HAP commands use the latter approach to compute  $H_5(\Gamma, \mathbb{Z}) = \mathbb{Z}_5$  in a way that involves an application of the SNF algorithm to a matrix of dimensions  $302 \times 302$ .

```
gap> gamma:=HAP_CongruenceSubgroupGamma0(1000);;
gap> R:=ResolutionSL2Z(1,6);;
gap> S:=ResolutionFiniteSubgroup(R,gamma);;
gap> C:=TensorWithIntegers(S);;
gap> List([0..5],C!.dimension);
[ 1800, 3600, 3600, 3600, 3600, 3600 ]
gap> D:=ContractedComplex(C);;
gap> List([0..5],D!.dimension);
[ 1, 302, 302, 302, 302, 302 ]
gap> Homology(D,5);
[ 2 ]
```

To explain how the homotopy equivalence  $C_* \simeq D_*$  was constructed in Example 7.1 let us consider an arbitrary chain complex  $C_*$  of free  $\Lambda$ -modules  $C_n$  where  $\Lambda$  is an associative (but not necessarily commutative) ring with identity. The examples we have in mind are  $\Lambda = \mathbb{Z}$  and  $\Lambda = \mathbb{Z}\Gamma$ . Let us denote the free generators of  $C_n$  by  $e_1^n, \dots, e_k^n$ ,  $k = \text{rank}_\Lambda C_n$ . The boundary homomorphism is given by  $d_n(e_i^n) = \lambda_{i1}e_1^{n-1} + \dots + \lambda_{i\ell}e_\ell^{n-1}$  with  $\ell = \text{rank}_\Lambda C_{n-1}$ . Suppose that for some particular generator  $e_i^n$  one of the coefficients  $\lambda_{ij}$  is a unit in  $\Lambda$ . Let  $\langle e_i^n, d_n(e_i^n) \rangle$  denote the sub  $\Lambda$ -chain complex generated by  $e_i^n$  and  $d_n(e_i^n)$ . Since one of the coefficients is a unit, this sub chain complex has trivial homology, and the quotient chain complex  $C'_* = C_* / \langle e_i^n, d_n(e_i^n) \rangle$  is a chain complex of free  $\Lambda$ -modules. It follows from the exact homology sequence of a short exact sequence of chain complexes that the quotient chain map  $C_* \rightarrow C'_*$  is a quasi-isomorphism and thus homotopy equivalence of chain complexes. We say that  $C'_*$  is obtained from  $C_*$  by a *simple homotopy collapse* and write  $C_* \searrow C'_*$ . We can search, recursively, for a sequence of simple homotopy collapses  $C_* \searrow C'_* \searrow C''_* \searrow C'''_* \searrow \dots \searrow D_*$  and use  $D_*$  in place of  $C_*$  in cohomology computations. Example 7.1 illustrates this technique for  $\Lambda = \mathbb{Z}$ . The next example illustrates the technique for  $\Lambda = \mathbb{Z}\Gamma$ .

**Example 7.2.** The congruence subgroup  $\Gamma = \Gamma_0(50)$  is of index 90 in  $G = SL_2(\mathbb{Z})$ . Let  $S_*^\Gamma$  be the free  $\mathbb{Z}\Gamma$ -resolution obtained from  $R_*^G$  by restricting the action. The following HAP commands construct a chain homotopy equivalence  $S_*^\Gamma \simeq T_*^\Gamma$  with  $\text{rank}_{\mathbb{Z}\Gamma} T_0^\Gamma = 1$ ,  $\text{rank}_{\mathbb{Z}\Gamma} T_n^\Gamma = 17$  for  $n \geq 1$  and use  $T_*^\Gamma$  to compute  $H^1(\Gamma, P_{\mathbb{Z}}(4)) = \mathbb{Z}_2 \oplus \mathbb{Z}_4 \oplus \mathbb{Z}_{120} \oplus \mathbb{Z}^{174}$  and  $H^5(\Gamma, P_{\mathbb{Z}}(4)) = \mathbb{Z}_2^{77}$ .

```

gap> gamma:=HAP_CongruenceSubgroupGamma0(50);;
gap> R:=ResolutionSL2Z(1,6);;
gap> S:=ResolutionFiniteSubgroup(R,gamma);;
gap> List([0..5],S!.dimension);
[ 90, 180, 180, 180, 180, 180 ]
gap> T:=ContractedComplex(S);;
gap> List([0..5],T!.dimension);
[ 1, 17, 17, 17, 17, 17 ]
gap> P:=HomogeneousPolynomials(gamma,4);;
gap> D:=HomToIntegralModule(T,P);;
gap> Cohomology(C,1);
[ 2, 4, 120, 0, 0, 0, 0, 0, 0, 0, 0, 0, 0, 0, 0, 0, 0, 0, 0, 0, 0, 0,
  0, 0, 0, 0, 0, 0, 0, 0, 0, 0, 0, 0, 0, 0, 0, 0, 0, 0, 0, 0, 0, 0,
  0, 0, 0, 0, 0, 0, 0, 0, 0, 0, 0, 0, 0, 0, 0, 0, 0, 0, 0, 0, 0, 0,
  0, 0, 0 ]
gap> Cohomology(D,5);
[ 2, 2, 2, 2, 2, 2, 2, 2, 2, 2, 2, 2, 2, 2, 2, 2, 2, 2, 2, 2, 2, 2, 2, 2,
  2, 2, 2, 2, 2, 2, 2, 2, 2, 2, 2, 2, 2, 2, 2, 2, 2, 2, 2, 2, 2, 2,
  2, 2, 2, 2, 2, 2, 2, 2, 2, 2, 2, 2, 2, 2, 2, 2, 2, 2, 2, 2, 2 ]

```

## 8 Cuspidal cohomology of congruence subgroups of $SL_2(\mathbb{Z})$

The action (4.2) of  $G = SL_2(\mathbb{Z})$  on the upper-half plane  $\mathfrak{h}$  has a fundamental domain

$$\begin{aligned}
D = & \{z \in \mathfrak{h} : |z| > 1, |\operatorname{Re}(z)| < \frac{1}{2}\} \cup \{z \in \mathfrak{h} : |z| \geq 1, \operatorname{Re}(z) = -\frac{1}{2}\} \\
& \cup \{z \in \mathfrak{h} : |z| = 1, -\frac{1}{2} \leq \operatorname{Re}(z) \leq 0\}
\end{aligned}$$

shown in Figure 1. The action factors through an action of  $PSL_2(\mathbb{Z}) = SL_2(\mathbb{Z}) / \langle \begin{pmatrix} -1 & 0 \\ 0 & -1 \end{pmatrix} \rangle$ .

The images of  $D$  under the action of  $PSL_2(\mathbb{Z})$  cover the upper-half plane, and any two images have at most a single point in common. The possible common points are in the orbit of the bottom left-hand corner point  $-\frac{1}{2} + \mathbf{i}\frac{\sqrt{3}}{2}$  which is stabilized by  $\mathcal{U}$ , or in the orbit of the bottom middle point  $\mathbf{i}$  which is stabilized by  $\mathcal{S}$ .

A congruence subgroup  $\Gamma$  has a ‘fundamental domain’  $D_\Gamma$  equal to a union of finitely many copies of  $D$ , one copy for each coset in  $\Gamma \backslash SL_2(\mathbb{Z})$ . The quotient space  $X = \Gamma \backslash \mathfrak{h}$  is not compact, and can be compactified in several ways. We are interested in the Borel-Serre compactification. This is a space  $X^{BS}$  for which there is an inclusion  $X \hookrightarrow X^{BS}$  that is a homotopy equivalence. One defines the *boundary*  $\partial X^{BS} = X^{BS} - X$  and uses the inclusion  $\partial X^{BS} \hookrightarrow X^{BS} \simeq X$  to define the cuspidal cohomology group, over the ground ring  $\mathbb{C}$ , as

$$H_{cusp}^n(\Gamma, P_{\mathbb{C}}(k-2)) = \ker( H^n(X, P_{\mathbb{C}}(k-2)) \rightarrow H^n(\partial X^{BS}, P_{\mathbb{C}}(k-2)) ).$$

Strictly speaking, this is the definition of *interior cohomology*  $H_!^n(\Gamma, P_{\mathbb{C}}(k-2))$  which in general contains the cuspidal cohomology as a subgroup. However, for congruence subgroups of  $SL_2(\mathbb{Z})$  there is equality  $H_!^n(\Gamma, P_{\mathbb{C}}(k-2)) = H_{cusp}^n(\Gamma, P_{\mathbb{C}}(k-2))$ .

Working over  $\mathbb{C}$  has the advantage of avoiding the technical issue that  $\Gamma$  does not necessarily act freely on  $\mathfrak{h}$  since there may be points with finite cyclic stabilizer groups in  $SL_2(\mathbb{Z})$ . But it

has the disadvantage of losing information about torsion in cohomology. We address the issue by working with a contractible CW-complex  $\tilde{X}^{BS}$  on which  $\Gamma$  acts freely, and  $\Gamma$ -equivariant inclusion  $\partial\tilde{X}^{BS} \hookrightarrow \tilde{X}^{BS}$ . The definition of cuspidal cohomology that we use, which coincides with the above definition when working over  $\mathbb{C}$ , is

$$H_{cusp}^n(\Gamma, A) = \ker( H^n(\text{Hom}_{\mathbb{Z}\Gamma}(C_*(\tilde{X}^{BS}), A)) \rightarrow H^n(\text{Hom}_{\mathbb{Z}\Gamma}(C_*(\partial\tilde{X}^{BS}), A)) ). \quad (8.1)$$

The compact CW-complex  $X^{BS}$  is described by the CW-structure on the fundamental domain for its action of  $G$  shown in Figure 3 and the cell stabilizer groups  $Stab(e_1^0) = \mathcal{U} \cong C_6$ ,  $Stab(e_2^0) =$

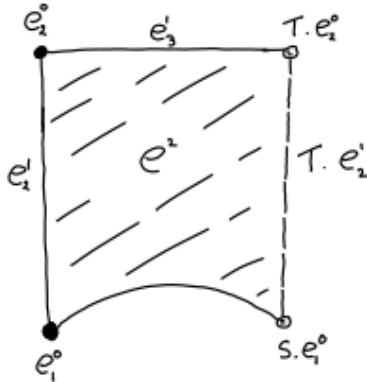

FIGURE 3. Fundamental domain for the action of  $PSL_2(\mathbb{Z})$  on  $X^{BS}$ .

$\langle U^3 \rangle \cong C_2$ ,  $Stab(e_1^1) = \mathcal{S} \cong C_4$ ,  $Stab(e_2^1) = \langle U^3 \rangle \cong C_2$ ,  $Stab(e_3^1) = \langle U^3 \rangle \cong C_2$ ,  $Stab(e^2) = \langle U^3 \rangle \cong C_2$ . The cellular chain complex  $C_*X^{BS}$  is a complex of  $\mathbb{Z}G$ -modules of the form

$$0 \longrightarrow \mathbb{Z}G \otimes_{C_2} \mathbb{Z} \longrightarrow \mathbb{Z}G \otimes_{C_4} \mathbb{Z}^\varepsilon \oplus \mathbb{Z}G \otimes_{C_2} \mathbb{Z} \oplus \mathbb{Z}G \otimes_{C_2} \mathbb{Z} \longrightarrow \mathbb{Z}G \otimes_{C_6} \mathbb{Z} \oplus \mathbb{Z}G \otimes_{C_2} \mathbb{Z} .$$

The process of using resolutions for cell stabilizer groups to convert the contractible  $\mathbb{Z}G$ -complex  $C_*\mathcal{T}$  into a free  $\mathbb{Z}G$ -resolution  $R_*^G$  can be adapted to the current setting. Resolutions for cell stabilizers can be combined with the  $\mathbb{Z}G$ -complex  $C_*X^{BS}$  to produce a free  $\mathbb{Z}G$ -resolution  $C_*\tilde{X}^{BS}$ . The construction uses a perturbation technique of C.T.C. Wall [40] and explicit formulas for the construction in terms of contracting homotopies can be found in [13]. The following is a summary of the construction.

**Proposition 8.1.** [13] Let  $X$  be any contractible CW-complex on which some group  $G$  acts in a way that permutes cells. Suppose that for  $n \geq 0$  there are finitely many orbits of  $n$ -cells represented by  $e_1^n, e_2^n, \dots, e_{k_n}^n$ . Let  $G^{e_i^n}$  denote the subgroup of  $G$  stabilizing  $e_i^n$ . Suppose that we have free  $\mathbb{Z}G^{e_i^n}$ -resolutions  $R_*^{G^{e_i^n}}$  of  $\mathbb{Z}$ . Then there is a free  $\mathbb{Z}G$ -resolution  $R_*^G$  of  $\mathbb{Z}$  with

$$R_n^G = \bigoplus_{p+q=n, p, q \geq 0} (R_q^{G^{e_i^p}} \otimes_{\mathbb{Z}} \mathbb{Z}^{\varepsilon_i^p}) \otimes_{\mathbb{Z}G^{e_i^p}} \mathbb{Z}G$$

where  $\mathbb{Z}^{\varepsilon_i^p}$  denotes the integers with some action of  $G^{e_i^p}$ . An explicit formula for the boundary homomorphism  $d_n: R_n^G \rightarrow R_{n-1}^G$  can be given in terms of the boundary homomorphism on  $C_*X$

and the boundary homomorphisms and contracting homotopies for the resolutions of the stabilizer groups. An explicit formula for a contracting homotopy  $h_n: R_n^G \rightarrow R_{n+1}^G$  can also be given if, in addition, we have an explicit formula for a contracting homotopy  $h_*: C_*X \simeq \mathbb{Z}$ .  $\blacksquare$

The free resolution  $C_*\tilde{X}^{BS}$  is of the form  $\text{rank}_{\mathbb{Z}G}(C_0\tilde{X}^{BS}) = 2$ ,  $\text{rank}_{\mathbb{Z}G}(C_1\tilde{X}^{BS}) = 5$ , and  $\text{rank}_{\mathbb{Z}G}(C_n\tilde{X}^{BS}) = 6$  for  $n \geq 2$ . Having constructed  $C_*\tilde{X}^{BS}$  it is routine to implement the definition 8.1 of cuspidal cohomology.

**Example 8.2.** The following HAP commands compute  $H_{cusp}^1(\Gamma_0(39), P_{\mathbb{Z}}(2)) \cong \mathbb{Z}^{24}$ .

```
gap> gamma:=HAP_CongruenceSubgroupGamma0(39);;
gap> k:=4;; deg:=1;; c:=CuspidalCohomologyHomomorphism(gamma,deg,k);;
gap> AbelianInvariants(Kernel(c));
[ 0, 0, 0, 0, 0, 0, 0, 0, 0, 0, 0, 0, 0, 0, 0, 0, 0, 0, 0, 0, 0, 0, 0, 0 ]
```

**Example 8.3.** The following HAP commands establish that  $S_2(\Gamma_0(11)) \cong \mathbb{C}$  is 1-dimensional with basis eigenform

$$f = q - 2q^2 - q^3 + 2q^4 + q^5 + 2q^6 - 2q^7 - 2q^9 - 2q^{10} + \dots$$

```
gap> gamma:=HAP_CongruenceSubgroupGamma0(11);;
gap> AbelianInvariants(Kernel(CuspidalCohomologyHomomorphism(gamma,1,2)));;
[ 0, 0 ]
gap> gamma:=HAP_CongruenceSubgroupGamma0(11);;
gap> for n in [1,2,3,5,7] do
> Display(HomomorphismAsMatrix(HeckeOperatorWeight2(gamma,n,1)));;
> od;
[ [ 1, 0, 0 ], [ [ 3, -4, 4 ], [ [ 4, -4, 4 ],
[ 0, 1, 0 ], [ 0, -2, 0 ], [ 0, -1, 0 ],
[ 0, 0, 1 ] ] [ 0, 0, -2 ] ] [ 0, 0, -1 ] ]
[ [ 6, -4, 4 ], [ [ 8, -8, 8 ],
[ 0, 1, 0 ], [ 0, -2, 0 ],
[ 0, 0, 1 ] ] [ 0, 0, -2 ] ]
```

As explained in [37], for a normalized eigenform  $f = 1 + \sum_{s=2}^{\infty} a_s q^s$  the coefficients  $a_s$  with  $s$  a composite integer can be expressed in terms of the coefficients  $a_p$  for prime  $p$ . If  $r, s$  are coprime then  $a_{rs} = a_r a_s$ . If  $p$  is a prime that is not a divisor of the level  $N$  of  $\Gamma$  then  $a_{p^m} = a_{p^{m-1}} a_p - p a_{p^{m-2}}$ . If the prime  $p$  divides  $N$  then  $a_{p^m} = (a_p)^m$ . It thus suffices to compute the coefficients  $a_p$  for prime integers  $p$  only.

See Stein's paper [37] for other techniques for computing Fourier expansions of classical modular forms, in particular techniques using Manin symbols.

## 9 Integral cohomology of $SL_2(\mathbb{Z}[\mathbf{i}])$

The group  $SL_2(\mathbb{C})$  acts on the *upper-half space*

$$\mathfrak{h}^3 = \{(z, t) \in \mathbb{C} \times \mathbb{R} \mid t > 0\}$$

in a well-known fashion. To describe the action we introduce the symbol  $\mathbf{j}$  satisfying  $\mathbf{j}^2 = -1$ ,  $\mathbf{i}\mathbf{j} = -\mathbf{j}\mathbf{i}$  where  $\mathbf{i} = \sqrt{-1}$ , and write  $z + t\mathbf{j}$  instead of  $(z, t)$ . The action is given by

$$\begin{pmatrix} a & b \\ c & d \end{pmatrix} \cdot (z + t\mathbf{j}) = (a(z + t\mathbf{j}) + b)(c(z + t\mathbf{j}) + d)^{-1}.$$

Alternatively, and more explicitly, the action is given by

$$\begin{pmatrix} a & b \\ c & d \end{pmatrix} \cdot (z + t\mathbf{j}) = \frac{(az + b)\overline{(cz + d)} + a\bar{c}t^2}{|cz + d|^2 + |c|^2t^2} + \frac{t}{|cz + d|^2 + |c|^2t^2}\mathbf{j}.$$

Let  $G = SL_2(\mathbb{Z}[\mathbf{i}]) = SL_2(\mathcal{O}_{-1})$ . A standard ‘fundamental domain’  $D$  for the restricted action of  $G$  on  $\mathfrak{h}^3$  is the region

$$D = \{z + t\mathbf{j} \in \mathfrak{h}^3 \mid 0 \leq |\operatorname{Re}(z)| \leq \frac{1}{2}, 0 \leq \operatorname{Im}(z) \leq \frac{1}{2}, z\bar{z} + t^2 \geq 1\} \quad (9.1)$$

shown in Figure 4 with some boundary points removed if one wants to minimize potential intersec-

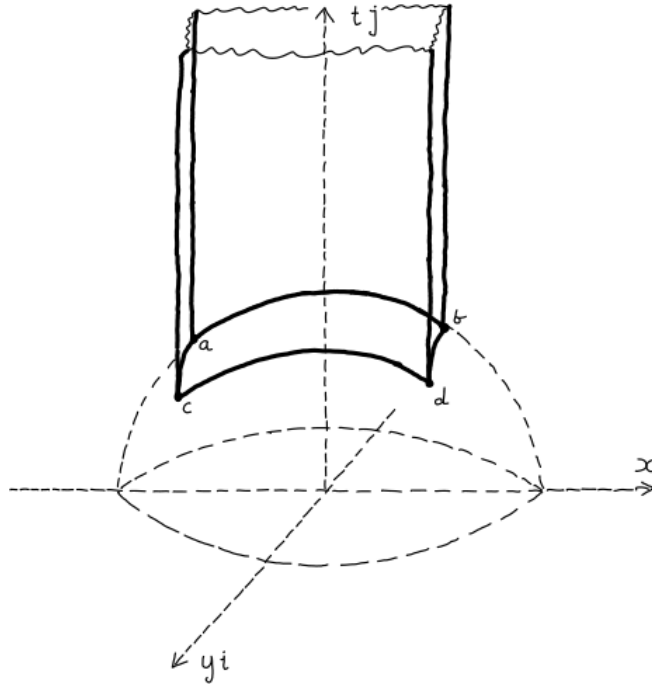

FIGURE 4. Portion of the non-compact fundamental domain for the action of  $SL_2(\mathcal{O}_{-1})$  on  $\mathfrak{h}^3$

tions  $D \cap gD$ ,  $g \in G$  of measure zero. The four bottom vertices of  $D$  are  $a = -\frac{1}{2} + \frac{\sqrt{3}}{2}\mathbf{j}$ ,  $b = \frac{1}{2} + \frac{\sqrt{3}}{2}\mathbf{j}$ ,  $c = -\frac{1}{2} + \frac{1}{2}\mathbf{i} + \frac{\sqrt{2}}{2}\mathbf{j}$ ,  $d = \frac{1}{2} + \frac{1}{2}\mathbf{i} + \frac{\sqrt{2}}{2}\mathbf{j}$ . See for instance [22, page 58].



The upper-half space  $\mathfrak{h}^3$  can be retracted onto a 2-dimensional subspace  $\mathcal{T} \subset \mathfrak{h}^3$ , with  $\mathcal{T}$  a contractible 2-dimensional regular CW-complex, and where the action of  $G$  on  $\mathfrak{h}^3$  restricts to a cellular action of  $G$  on  $\mathcal{T}$ . Under the restricted action there is one orbit of 2-cells in  $\mathcal{T}$ , represented by the curvilinear square with vertices  $a, b, c$  and  $d$  in the picture. This 2-cell has cyclic stabilizer group of order 4. There are three orbits of 1-cells: the edges  $ac$  and  $bd$  are in the same orbit with cyclic stabilizer group of order 6; edge  $ab$  has stabilizer group isomorphic to the quaternion group  $Q_4$  of order 8; edge  $cd$  has stabilizer group isomorphic to a semi-direct product  $C_3 : C_4$  of order 12. There are two orbits of 0-cells, each with stabilizer group isomorphic to a semi-direct product  $C_3 : C_4$  of order 12. Vertices  $a$  and  $b$  belong to the same orbit, and vertices  $c$  and  $d$  belong to the other orbit.

The first  $n$ -terms of free  $\mathbb{Z}H$ -resolutions  $R_*^H$  of  $\mathbb{Z}$  for each of the finite cell-stabilizer groups  $H$  can be computed using the algorithm in [11]. That algorithm produces an explicit contracting homotopy on  $R_*^H$ . Using Proposition 8.1, these stabilizer group resolutions can be combined with  $C_*\mathcal{T}$  to form a free  $\mathbb{Z}G$ -resolution  $R_*^G$  of  $\mathbb{Z}$ .

**Example 9.1.** The following HAP commands use an implementation of the resolution  $R_*^G$  for  $G = SL_2(\mathbb{Z}[i])$  to compute

$$\begin{aligned} H^1(G, P_{\mathcal{O}_{-1}}(64)) &\cong \mathbb{Z}_2^{11} \oplus \mathbb{Z}_4 \oplus \mathbb{Z}_8^2 \oplus \mathbb{Z}_{16} \oplus \mathbb{Z}_{160} \oplus \mathbb{Z}_{320}, \\ H^2(G, P_{\mathcal{O}_{-1}}(64)) &\cong \mathbb{Z}^2 \oplus \mathbb{Z}_2^{58} \oplus \mathbb{Z}_{10}^2 \oplus \mathbb{Z}_{30} \oplus \mathbb{Z}_{60}^3 \oplus \mathbb{Z}_{81900} \oplus \mathbb{Z}_{163800} \\ &\oplus \mathbb{Z}_{45298780162170032823378180868002600330993000} \\ &\oplus \mathbb{Z}_{90597560324340065646756361736005200661986000}. \end{aligned}$$

```
gap> R:=ResolutionSL2QuadraticIntegers(-1,3);;
gap> G:=R!.group;;
gap> M:=HomogeneousPolynomials(G,64);;
gap> C:=HomToIntegralModule(R,M);;
gap> D:=ContractedComplex(C);;
Cohomology(D,1);
Cohomology(D,2);
gap> Cohomology(D,1);
[ 2, 2, 2, 2, 2, 2, 2, 2, 2, 2, 2, 2, 4, 8, 8, 16, 160, 320 ]
gap> Cohomology(D,2);
[ 2, 2, 2, 2, 2, 2, 2, 2, 2, 2, 2, 2, 2, 2, 2, 2, 2, 2, 2, 2, 2, 2, 2, 2, 2, 2,
  2, 2, 2, 2, 2, 2, 2, 2, 2, 2, 2, 2, 2, 2, 2, 2, 2, 2, 2, 2, 2, 2, 2, 2,
  2, 2, 2, 2, 2, 2, 2, 2, 10, 10, 30, 60, 60, 60, 81900, 163800,
  45298780162170032823378180868002600330993000,
  90597560324340065646756361736005200661986000, 0, 0 ]
```

The prime factorization of the largest torsion coefficient in the abelian invariant decomposition of  $H^2(G, P_{\mathcal{O}_{-1}}(64))$  is

$$2^4 \times 3^2 \times 5^3 \times 7 \times 11 \times 13 \times 17 \times 19 \times 29 \times 37 \times 41 \times 43 \times 47 \times 53 \times 59 \times 61 \times 197 \times 103979 \times 44811339594403.$$

Cuspidal cohomology for  $G = SL_2(\mathbb{Z}[i])$  can be defined and implemented in a fashion directly analogous to that for  $SL_2(\mathbb{Z})$ . The basic idea is that the non-compact fundamental domain  $D$  of

(9.1) is homeomorphic to  $[0, 1] \times [0, 1] \times [0, 1)$  and can be compactified to  $\overline{D} = [0, 1] \times [0, 1] \times [0, 1]$  in analogy with Figure 3. Then  $\overline{D}$  becomes the fundamental domain for a CW-complex  $X^{BS}$  on which  $G$  acts (non-freely) by permuting cells. Proposition 8.1 is then used to construct the chain complex  $C_*(\tilde{X}^{BS})$  needed to apply Definition (8.1). This is not yet implemented in HAP.

## 10 Integral cohomology of $SL_2(\mathcal{O}_d)$ and other groups

To extend the above cohomological techniques to  $G = SL_2(\mathcal{O}_d)$  we require a contractible CW-complex  $\mathcal{T}$  in which  $G$  acts cellularly with cell stabilizers  $H$  for which we can compute a free  $\mathbb{Z}H$ -resolution  $R_*^H$ . There are two related approaches to computing such a  $\mathcal{T}$ , both of which are well-documented in the literature. One approach makes use of the fact that  $\mathfrak{h}^3$  is a metric space on which  $G$  acts discontinuously by isometries, and focuses on constructing a Dirichlet fundamental domain

$$D(v) = \{w \in \mathfrak{h}^3 : d(v, w) \leq d(gv, w) \text{ for all } g \in G\}$$

where  $v \in \mathfrak{h}^3$  is some suitable choice of point, and  $d(\cdot, \cdot)$  denotes the metric on  $\mathfrak{h}^3$ . The domain  $D(v)$  is defined as an intersection of half spaces  $\{w \in \mathfrak{h}^3 : d(v, w) \leq d(v, g \cdot v)\}$ , one half space for each  $g \in G$ . However, only finitely many of the half spaces are actually needed to determine  $D(v)$ ; using Poincaré's theorem (see [24]) this finite intersection can be implemented on a computer and used to determine the face lattice of  $D(v)$ . The required 2-dimensional regular CW-complex  $\mathcal{T}$  arises as the orbit of a deformation retract of  $D(v)$ . For detailed accounts of the computation of  $D(v)$  the reader can consult papers of Swan [38], Riley [30], Mendoza [25], Flöge [14] and the more recent work of Aurel Page [26, 27] and Alexander Rahm [28, 29]. Details of  $\mathcal{T}$  for various groups  $SL_2(\mathcal{O}_d)$  have been computed by Rahm and stored as part of a library in HAP.

A second approach to computing  $\mathcal{T}$  uses Voronoi's theory of *perfect* quadratic forms. Let  $S_{>0}^m$  denote the space of positive definite symmetric  $m \times m$  matrices  $Q$ . Such a matrix  $Q$  corresponds to an  $m$ -dimensional quadratic form. The cone  $S_{>0}^m$  is contractible and  $A \in GL_m(\mathbb{Z})$  acts on  $S_{>0}^m$  via

$$(A, Q) \mapsto AQA^t$$

where  $Q^t$  denotes the transposed matrix. For a matrix  $Q \in S_{>0}^m$  and column vector  $v \in \mathbb{R}^m$  set

$$\begin{aligned} Q[v] &= v^t Q v, \\ \rho(v) &= v^t v \in S_{>0}^m, \\ \min(Q) &= \min_{0 \neq v \in \mathbb{Z}^m} Q[v], \\ \text{Min}(Q) &= \{v \in \mathbb{Z}^m : Q[v] = \min(Q)\}. \end{aligned}$$

A quadratic form  $Q[v]$  is said to be *perfect* if a quadratic form  $P[v]$  satisfies  $P[v] = \min(Q)$  for all  $v \in \text{Min}(Q)$  only if  $P = Q$ . For example, the quadratic form  $Q[x, y] = x^2 + xy + y^2$  has  $\min(Q) = 1$  and  $\text{Min}(Q) = \{(1, 0), (-1, 0), (0, 1), (0, -1), (1, -1), (-1, 1)\}$  and is perfect.

**Theorem 10.1** (Voronoi [39]). There are only finitely many perfect  $m$ -dimensional forms  $Q$  up to  $GL_m(\mathbb{Z})$ -equivalence, and the polyhedral cells

$$\text{Dom}(Q) = \left\{ \sum_{v \in \text{Min}(Q)} \lambda_v \rho(v) : \lambda_v \geq 0 \right\}$$

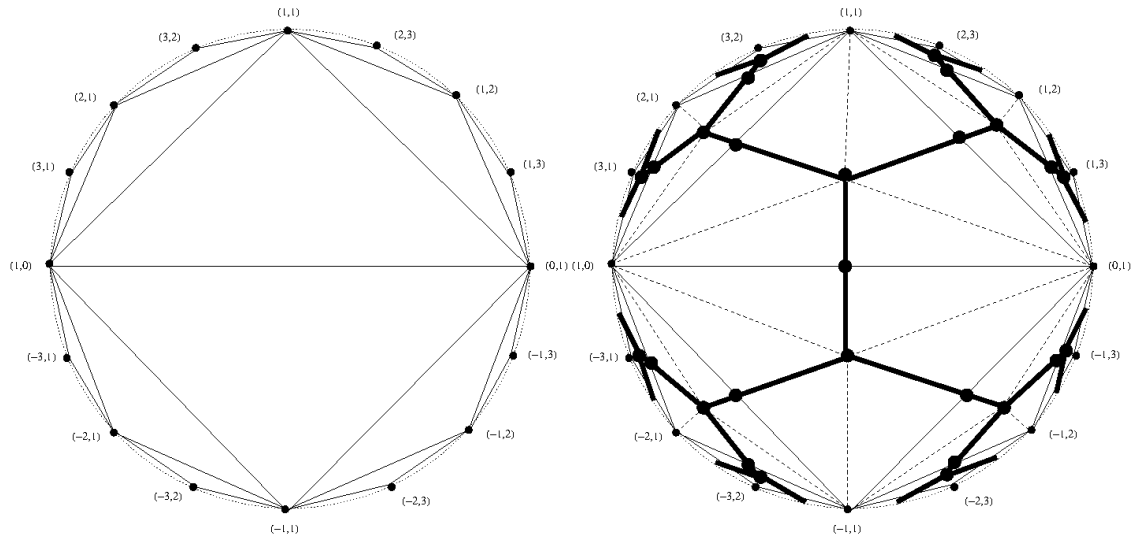

FIGURE 5. Partial Voronoi tessellation of  $S^2_{=1}$  (left) and its barycentric subdivision (right).

tessellate (the rational closure of)  $S^m_{>0}$ .

**Theorem 10.2** (Ash [1]). There is a  $GL_m(\mathbb{Z})$ -equivariant  $\binom{m}{2}$ -dimensional CW-complex  $\mathcal{T}$  which is a deformation retract of  $S^m_{=1}$ , where  $S^m_{=1}$  denotes the quotient of  $S^m_{>0}$  obtained by identifying scalar multiples.

It is easy to illustrate these theorems pictorially for  $m = 2$ . The cone  $S^2_{>0}$  is 3-dimensional, and the quotient  $S^2_{=1}$  is 2-dimensional regular CW-complex. We can view  $S^2_{=1}$  as the union of an open unit 2-disk with countably infinitely many points on the boundary of the 2-disk. The cellular structure of  $S^2_{=1}$  is that of a tessellation by triangles, with the triangle vertices being the points on the boundary of the disk. A triangle vertex represents a ray of quadratic forms  $\mathbb{R}_+\rho(v) = \{\lambda\rho(v) : \lambda > 0\}$  with  $v \in \text{Min}(Q)$  for some perfect form  $Q$ . The Voronoi tessellation of  $S^2_{=1}$  is partially pictured in Figure 5 (left), with rays  $\mathbb{R}_+\rho(v)$  labelled simply by  $v$ . The barycentric subdivision of this Voronoi tessellation is partially pictured in Figure 5 (right). Some vertices and edges of the barycentric subdivision are displayed in bold. These bold vertices and edges belong to the deformation retract of Theorem 10.2 which, in the case  $m = 2$ , is a subdivision of the cubic tree (each edge of the cubic tree is subdivided into two edges).

**Example 10.3.** The following HAP commands use a 3-dimensional CW-complex  $\mathcal{T}$  furnished by the theorems of Voronoi and Ash, together with Proposition 8.1, to construct a free  $\mathbb{Z}G$ -resolution  $R_*^G$ , for  $G = SL_3(\mathbb{Z})$ , in degrees  $\leq 5$ . Since functions specifically for congruence subgroups of  $SL_m(\mathbb{Z})$  have not yet been implemented in HAP for  $m > 2$ , the group  $G$  is represented as a finitely presented group so that GAP's functionality for finitely presented groups can be invoked. The commands use GAP's implementation of the low-index subgroup procedure to list representatives

of all conjugacy classes of subgroups  $\Gamma \leq G$  of index at most 50. Precisely one of these  $\Gamma$  has index 48. For this subgroup of index 48 the commands compute

$$H_n(\Gamma, \mathbb{Z}) = \begin{cases} \mathbb{Z}_{14}, & n = 1, \\ \mathbb{Z}_2, & n = 2, \\ \mathbb{Z} \oplus \mathbb{Z}, & n = 3, \\ \mathbb{Z}_2 \oplus \mathbb{Z}_2 \oplus \mathbb{Z}_2 \oplus \mathbb{Z}_2, & n = 4. \end{cases}$$

```
gap> C:=ContractibleGcomplex("SL(3,Z)");;
gap> R:=FreeGResolution(C,5);;
gap> ResolutionToResolutionOfFpGroup(R);;
gap> G:=R!.group;;
gap> index:=50;; L:=LowIndexSubgroupsFpGroup(G,index);;
gap> Length(L);
30
gap> gamma:=L[30];; Index(G,gamma);
48
gap> S:=ResolutionSubgroup(R,gamma);;
gap> C:=TensorWithIntegers(S);;
gap> D:=ContractedComplex(C);;
gap> Homology(D,1);
[ 14 ]
gap> Homology(D,2);
[ 2 ]
gap> Homology(D,3);
[ 0, 0 ]
gap> Homology(D,4);
[ 2, 2, 2, 2, 2 ]
```

No contracting homotopy is implemented on the resolution  $R_*^G$  and so this resolution can not yet be used to compute Hecke operators on the cohomology of  $\Gamma$ . The missing component is a contracting homotopy  $h_*: C_*\mathcal{T} \simeq \mathbb{Z}$ .

Theorems 10.1, 10.2 can be extended to the case where  $\mathbb{Z}$  is replaced by  $\mathcal{O}_d$  and implemented on a computer as a method for determining the contractible CW-complex  $\mathcal{T}$ . Good accounts of this approach can be found, for instance, in [33, 19, 43, 6, 32]. Using this approach, Sebastian Schönnebeck has computed a complex  $\mathcal{T}$  for various groups  $SL_2(\mathcal{O}_d)$  and stored its details as part of a library in HAP. Mathieu Dutour Sikríc [9] has also used the approach to compute, and store in HAP, higher-dimensional complexes  $\mathcal{T}$  for arithmetic groups such as  $SL_3(\mathbb{Z}[i])$ ,  $SL_4(\mathbb{Z})$ ,  $Sp_4(\mathbb{Z})$ .

**Example 10.4.** For a range of square-free values of  $d$  the HAP command

```
R:=ResolutionSL2QuadraticIntegers(d,n);;
```

returns  $n$  dimensions of a free  $\mathbb{Z}G$ -resolution  $R_*^G$  for  $G = SL_2(\mathcal{O}_d)$ . The HAP session of Example9.1 can be repeated with  $d = -2$  to establish:

$$\begin{aligned} H^1(SL_2(\mathcal{O}_{-2}), P_{\mathcal{O}_{-2}}(64)) &\cong \mathbb{Z}^2 \oplus \mathbb{Z}_2^5 \oplus \mathbb{Z}_6^6 \oplus \mathbb{Z}_{12} \oplus \mathbb{Z}_{24}^2 \oplus \mathbb{Z}_{48} \oplus \mathbb{Z}_{96} \oplus \mathbb{Z}_{192}, \\ H^2(SL_2(\mathcal{O}_{-2}), P_{\mathcal{O}_{-2}}(64)) &\cong \end{aligned}$$

$$\begin{aligned} & \mathbb{Z}^2 \oplus \mathbb{Z}_2^{34} \oplus \mathbb{Z}_6^3 \oplus \mathbb{Z}_{12}^9 \oplus \mathbb{Z}_{36}^3 \oplus \mathbb{Z}_{72}^6 \oplus \mathbb{Z}_{144} \oplus \mathbb{Z}_{4752}^4 \oplus \mathbb{Z}_{3792096}^2 \oplus \mathbb{Z}_{9347516640} \oplus \mathbb{Z}_{18695033280} \\ & \oplus \mathbb{Z}_{8223545796645304770924605527348196650673670016543148734143443796390563963212512724652966920933440} . \end{aligned}$$

The prime factorization of the largest torsion coefficient in the abelian invariant decomposition of  $H^2(SL_2(\mathcal{O}_{-2}), P_{\mathcal{O}_{-2}}(64))$  is

$$\begin{aligned} & 2^6 \times 3^5 \times 5 \times 7 \times 11 \times 17 \times 19 \times 23 \times 29 \times 31 \times 37 \times 41 \times 43 \times 47 \times 53 \times 59 \times 61 \times 138493 \\ & \times 1367917218822877368259426449806293 \times 1856200299217477154598445936975567 . \end{aligned}$$

## 11 Integral cohomology of $PSL_2(\mathcal{O}_d)$ and $GL_2(\mathcal{O}_d)$

The contractible CW-complex  $\mathcal{T}$  used in the construction of a free resolution for  $SL_2(\mathcal{O}_d)$  can also be used, in a similar fashion, to construct a resolution for  $PSL_2(\mathcal{O}_d)$ . One just needs to quotient each of the finite stabilizer groups in  $SL_2(2, \mathcal{O}_d)$  by the group  $\langle -I \rangle$  with  $I$  the identity matrix. For instance, the HAP commands

```
gap> R:=ResolutionPSL2QuadraticIntegers(-11,3);;
gap> M:=HomogeneousPolynomials(R!.group,5,5);;
gap> C:=HomToIntegralModule(R,M);;
gap> Cohomology(C,2);
[ 2, 2, 2, 2, 2, 2, 2, 2, 60, 660, 660, 660, 0, 0, 0, 0, 0 ]
```

establish

$$H^2(PSL_2(\mathcal{O}_{-11}), P_{\mathcal{O}_{-11}}(5,5)) = (\mathbb{Z}_2)^8 \oplus \mathbb{Z}_{60} \oplus (\mathbb{Z}_{660})^3 \oplus \mathbb{Z}^6 \quad (11.1)$$

with coefficient module

$$P_{\mathcal{O}_{-d}}(k, \ell) = P_{\mathcal{O}_{-d}}(k) \otimes_{\mathcal{O}_{-d}} \overline{P_{\mathcal{O}_{-d}}(\ell)}$$

where the bar denotes a twist in the action obtained from complex conjugation. For an action of the projective linear group we must insist that  $k + \ell$  is even. The calculation (11.1) was first made by Mehmet Haluk Sengun in [8] where he records many cohomology computations for Euclidean Bianchi groups  $PSL_2(\mathcal{O}_d)$ ,  $d = -1, -2, -3, -7, -11$ .

For an example involving a non-Euclidean Bianchi group, the above commands can be varied to calculate

$$H^2(PSL_2(\mathcal{O}_{-6}), P_{\mathcal{O}_{-6}}(64)) \cong \mathbb{Z}^4 \oplus A$$

where  $A$  is a finite abelian group of order equal to a 1429-digit integer; the invariant factor decomposition of  $A$  is a direct sum of 158 finite cyclic groups, the largest cyclic group having order equal to a 558-digit integer. GAP's standard integer factorization routines are unable to determine the prime decomposition of this 558-digit integer in reasonable time.

A free resolution for  $GL_2(\mathcal{O}_d)$  can be constructed using the short exact sequence

$$SL_2(\mathcal{O}_d) \hookrightarrow GL_2(\mathcal{O}_d) \xrightarrow{\det} U(\mathcal{O}_d) \quad (11.2)$$

in which  $U(\mathcal{O}_d)$  denotes the group of units of  $\mathcal{O}_d$ . When  $d$  is square-free negative the group  $U(\mathcal{O}_d)$  is finite of order 4 if  $d = -1$ , order 6 if  $d = -3$ , and order 2 otherwise. When  $d$  is square-free positive the group  $U(\mathcal{O}_d)$  is isomorphic to  $C_2 \times C_\infty$ . We can thus construct free resolutions

$R_*^{SL_2(\mathcal{O}_d)}$  and  $R_*^{U(\mathcal{O}_d)}$  for the kernel and image of the determinant homomorphism. The group  $GL_2(\mathcal{O}_d)$  acts on the chain complex  $R_*^{U(\mathcal{O}_d)}$  in a way that each element of  $R_*^{U(\mathcal{O}_d)}$  is stabilized by  $SL_2(\mathcal{O}_d)$ . Proposition 8.1 can be used to construct the required free resolution  $R_*^{GL_2(\mathcal{O}_d)}$ . This is implemented in HAP.

## 12 Congruence subgroups of $SL_2(\mathcal{O}_d)$

For a square-free integer  $d$  the field  $K_d = \mathbb{Q}(\sqrt{d})$  can be constructed as a vector space of dimension 2 over  $\mathbb{Q}$  endowed with a multiplication. This construction, together with conjugation

$$K_d: \rightarrow K_d, a + b\sqrt{d} \mapsto a - b\sqrt{d},$$

the trace function

$$\text{tr}: K_d \rightarrow \mathbb{Q}, \alpha \mapsto \alpha + \bar{\alpha}$$

and norm

$$N: K_d^\times \rightarrow \mathbb{Q}^\times, \alpha \mapsto \alpha\bar{\alpha}$$

are readily implemented on a computer. An element of  $K$  is an *integer* if its minimal monic polynomial over  $\mathbb{Q}$  has coefficients in  $\mathbb{Z}$ . The ring of integers  $\mathcal{O}_d$  is readily implemented as a free abelian subgroup  $\mathcal{O}_d = \mathbb{Z} \oplus \omega\mathbb{Z} \subset K_d$  endowed with the same multiplication, where

$$\omega = \begin{cases} \sqrt{d} & \text{if } d \equiv 2, 3 \pmod{4}, \\ \frac{1+\sqrt{d}}{2} & \text{if } d \equiv 1 \pmod{4}. \end{cases}$$

An ideal  $\mathfrak{a} \triangleleft \mathcal{O}_d$  can be specified by giving any finite set that generates it as an ideal. The Smith Normal Form algorithm can be used to test whether an element  $\alpha \in \mathcal{O}_d$  belongs to  $\mathfrak{a}$ . It can also be used to implement addition and multiplication in the (finite) quotient ring  $\mathcal{O}_d/\mathfrak{a}$ . The norm of an ideal

$$N(\mathfrak{a}) = |\mathcal{O}_d/\mathfrak{a}|$$

can be defined as the number of elements in the quotient ring  $\mathcal{O}_d/\mathfrak{a}$  and can be determined from ideal generators using the Smith Normal Form algorithm. Since  $N(\mathfrak{a}\mathfrak{a}') = N(\mathfrak{a})N(\mathfrak{a}')$  an ideal is prime if its norm is a prime number. Conversely, an ideal is prime only if its norm is a prime  $p$  or prime square  $p^2$ . Standard theory involving the quadratic character  $\chi_{K_d}$  can be used to determine whether an ideal of norm  $p^2$  is prime.

For any ideal  $\mathfrak{a} \triangleleft \mathcal{O}_d$  there is a canonical homomorphism  $\pi_{\mathfrak{a}}: SL_2(\mathcal{O}_d) \rightarrow SL_2(\mathcal{O}_d/\mathfrak{a})$ . A subgroup  $\Gamma \leq SL_2(\mathcal{O}_d)$  is said to be a *congruence subgroup* if it contains  $\ker \pi_{\mathfrak{a}}$ .

The 2-complex  $\mathcal{T}_d$  can be used to determine generators for  $G = SL_2(\mathcal{O}_d)$  in a fashion similar to how the cubic tree  $\mathcal{T}_0$  was used to determine generators for  $SL_2(\mathbb{Z})$ . Let  $\text{Cay}(G)$  denote the Cayley graph of  $G$  with respect to these generators. The action of  $G$  on  $\text{Cay}(G)$  restricts to an action of a congruence subgroup  $\Gamma \leq G$  of level  $\mathfrak{a}$  on  $\text{Cay}(G)$ . The ideal membership test for  $\mathfrak{a}$  can be used to implement a membership test for the group  $\Gamma$ , and this in turn can be used to compute a fundamental domain for the action of  $\Gamma$  on  $\text{Cay}(G)$ . The vertices of this fundamental domain correspond to the cosets of  $\Gamma$  in  $G$ . The fundamental domain for  $\Gamma$  can be used, for instance, to determine a generating set for  $\Gamma$ , the index of  $\Gamma$  in  $G$ , and a permutation action of  $G$  on the cosets of  $\Gamma$ . In the case when  $\Gamma = \Gamma_0(\mathfrak{a})$  with  $\mathfrak{a}$  prime, a version of Proposition 6.3 can be used to perform these tasks more efficiently.

**Example 12.1.** The following HAP commands construct the prime ideal  $\mathfrak{a} \triangleleft \mathcal{O}_{-1}$  in the Gaussian integers generated by the element  $41 + 56i$ , and then construct the congruence subgroup  $\Gamma_0(\mathfrak{a})$  of index 4818.

```
gap> K:=QuadraticNumberField(-1);
GaussianRationals
gap> OK:=RingOfIntegers(K);
O(GaussianRationals)
gap> a:=QuadraticIdeal(OK,41+56*sqrt(-1));
ideal of norm 4817 in O(GaussianRationals)
gap> gamma:=HAP_CongruenceSubgroupGamma0(a);
<group of 2x2 matrices in characteristic 0>
gap> IndexInSL20(gamma);
4818
```

A maximal tree in the fundamental domain for the action of  $\Gamma_0(\mathfrak{a})$  on  $\text{Cay}(SL_2(\mathcal{O}_{-1}))$  is shown in Figure 6.

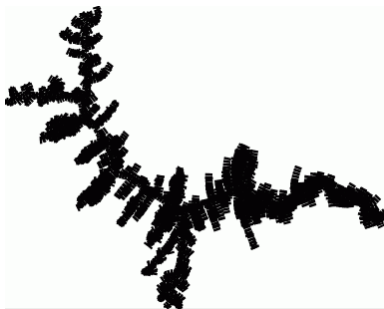

FIGURE 6. A maximal tree in a fundamental domain for  $\Gamma_0((41 + 56i))$ .

Our free  $\mathbb{Z}G$ -resolution  $R_*^G$  for  $G = SL_2(\mathcal{O}_d)$  can also be used as a free  $\mathbb{Z}\Gamma$ -resolution. Once the contracting homotopy of Section 13 is implemented on  $R_*^G$  ( $d < 0$ ), the resolution could be used to compute Hecke operators on the integral cohomology of  $\Gamma$  using functions currently implemented in HAP.

If one is interested only in first integral homology then the explicit construction of a free  $\mathbb{Z}\Gamma$ -resolution can be avoided. One can work instead with a free presentation of  $\Gamma$  obtained by applying GAP's efficient implementation of the Reidemeister-Schreier algorithm to a presentation of  $G$ . The isomorphism  $\Gamma^{ab} = H_1(\Gamma, \mathbb{Z})$  yields the desired homology group.

**Example 12.2.** The following continuation of the HAP commands of Example 12.1 establish

$$H_1(\Gamma_0(\mathfrak{a}), \mathbb{Z}) \cong \mathbb{Z}_2^2 \oplus \mathbb{Z}_4 \oplus \mathbb{Z}_5 \oplus \mathbb{Z}_7 \oplus \mathbb{Z}_{16} \oplus \mathbb{Z}_{29} \oplus \mathbb{Z}_{43} \oplus \mathbb{Z}_{157} \oplus \mathbb{Z}_{179} \\ \oplus \mathbb{Z}_{1877} \oplus \mathbb{Z}_{7741} \oplus \mathbb{Z}_{22037} \oplus \mathbb{Z}_{292306033} \oplus \mathbb{Z}_{4078793513671}$$

for the ideal  $\mathfrak{a} \triangleleft \mathcal{O}_{-1}$  generated by  $41 + 56i$ .

```
gap> H1:=AbelianInvariants(gamma);
[ 2, 2, 4, 5, 7, 16, 29, 43, 157, 179, 1877, 7741, 22037, 292306033,
  4078793513671 ]
```

The initial terms of a free  $\mathbb{Z}\Gamma_0(\mathfrak{a})$ -resolution can be used to compute

$$H_2(\Gamma_0(\mathfrak{a}), \mathbb{Z}) \cong \mathbb{Z}_2 \oplus \mathbb{Z}_2 \oplus \mathbb{Z}.$$

For the Gaussian integers  $\mathcal{O}_{-1}$  Conjecture (3.1) can be rewritten

$$\frac{\log |\Gamma_0(\mathfrak{a})_{tors}^{ab}|}{\text{Norm}(\mathfrak{a})} \rightarrow \frac{\lambda}{18\pi}, \quad \lambda = L(2, \chi_{\mathbb{Q}(\sqrt{-1})}) = 1 - \frac{1}{9} + \frac{1}{25} - \frac{1}{49} + \dots \quad (12.1)$$

as the norm of the prime ideal  $\mathfrak{a} \triangleleft \mathcal{O}_{-1}$  tends to  $\infty$ . Here the value of  $\lambda$  is given in terms of the  $L$ -function

$$L(s, \chi_{\mathbb{Q}(\sqrt{-1})}) = \sum_{n=1}^{\infty} \chi_{\mathbb{Q}(\sqrt{-1})}(s) n^{-s}$$

of the quadratic character  $\chi_{\mathbb{Q}(\sqrt{-1})}$  associated to the quadratic field  $\mathbb{Q}(\sqrt{-1})$ . The equivalence between (3.1) and (12.1) is obtained from the Humbert volume formula

$$\text{Vol}(\mathfrak{h}^3/SL_2(\mathcal{O}_{-d})) = \frac{|D|^{3/2}}{24} \zeta_{\mathbb{Q}(\sqrt{-d})}(2)/\zeta_{\mathbb{Q}}(2)$$

valid for square-free  $d > 0$ , where  $D$  is the discriminant of  $\mathbb{Q}(\sqrt{-d})$ , and the quadratic reciprocity formula

$$\zeta_{\mathbb{Q}(\sqrt{-d})}(s) = L(s, \chi_{\mathbb{Q}(\sqrt{-d})}) \zeta_{\mathbb{Q}}(s)$$

expressing the Dedekind zeta function as a product of an  $L$ -function and the Riemann zeta function.

The following commands approximate the quantities  $\lambda/18\pi = 0.0161957$  and  $\frac{\log |\Gamma_0(\mathfrak{a})_{tors}^{ab}|}{\text{Norm}(\mathfrak{a})} = 0.0210325$  in (12.1).

```
gap> Lfunction(K,2)/(18*3.142);
0.0161957
gap> Log_e10:=0.434294481903;; #Log_10(e)
gap> 1.0*Log(Product(H1),10)/(Norm(a)*Log_e10);
0.0210325
```

### 13 Contracting homotopies

The HAP package [12] contains functions for computing the Hecke operator  $T_g: H^n(\Gamma, A) \rightarrow H^n(\Gamma, A)$  arising from any group  $G$  with finite index subgroup  $\Gamma < G$  and element  $g \in G$  for which  $\Gamma' = G \cap g\Gamma g'$  is also of finite index in  $G$ , and any  $\mathbb{Z}G$ -module  $A$  that is finitely generated as an abelian group. These functions require  $n + 1$  terms of a free  $\mathbb{Z}G$ -resolution  $R_*^G$  of  $\mathbb{Z}$  endowed with a contracting chain homotopy. For the groups  $G = SL_2(\mathcal{O}_d), SL_m(\mathbb{Z})$  ( $m \leq 4$ ) the one ingredient that still needs to be implemented in HAP is a contracting homotopy on  $R_*^G$ . In this final section we describe an approach to implementing such a contracting homotopy.

It is convenient to recall the following notion.



**Definition 13.1.** A *discrete vector field* on a regular CW-complex  $X$  is a collection of pairs  $(s, t)$ , which we call *arrows* and denote by  $s \rightarrow t$ , satisfying

1.  $s, t$  are cells of  $X$  with  $\dim(t) = \dim(s) + 1$  and with  $s$  lying in the boundary of  $t$ . We say that  $s$  and  $t$  are *involved* in the arrow, that  $s$  is the *source* of the arrow, and that  $t$  is the *target* of the arrow.
2. any cell is involved in at most one arrow.

The term *discrete vector field* is due to [15]. In an earlier work [21] Jones calls this concept a *marking*. By a *chain* in a discrete vector field we mean a sequence of arrows

$$\dots, s_1 \rightarrow t_1, s_2 \rightarrow t_2, s_3 \rightarrow t_3, \dots$$

where the cell  $s_{i+1}$  lies in the boundary of  $t_i$  for each  $i$ . A chain is a *circuit* if it is of finite length with source  $s_1$  of the initial arrow  $s_1 \rightarrow t_1$  lying in the boundary of the target  $t_n$  of the final arrow  $s_n \rightarrow t_n$ . A discrete vector field is said to be *admissible* if it contains no circuits and no chains that extend infinitely to the right. We say that an admissible discrete vector field is *maximal* if it is not possible to add an arrow while retaining admissibility. A cell in  $X$  is said to be *critical* if it is not involved in any arrow. See Figure 7 for an example of a maximal discrete vector field on the cubic tree, involving just one critical cell.

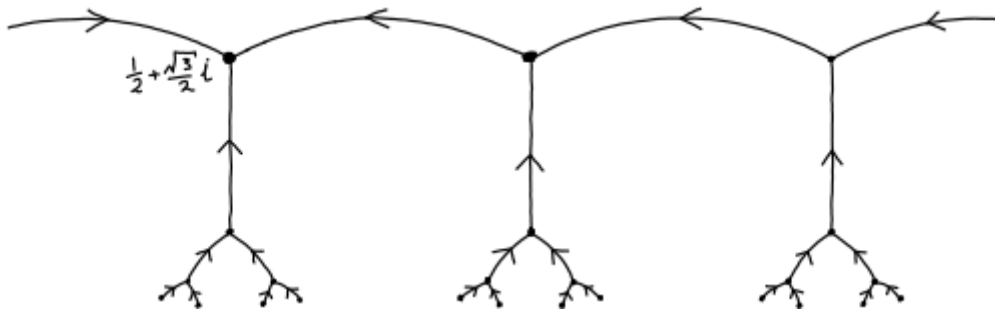

FIGURE 7. A portion of the cubic tree endowed with an admissible discrete vector field containing a single critical cell. Arrows  $e_i^0 \rightarrow e_i^1$  are represented by arrow heads on the cell  $e_i^1$ .

**Theorem 13.2.** [16, 15] If  $X$  is a regular CW-complex with admissible discrete vector field then there is a homotopy equivalence

$$X \simeq Y$$

where  $Y$  is a (possibly non-regular) CW-complex whose cells are in one-one correspondence with the critical cells of  $X$ .

An arrow on  $X$  can be viewed as representing a simple homotopy collapse, as introduced in [41]. The theorem just says that an admissible discrete vector field represents some sequence of simple homotopy collapses starting at  $X$  and ending at  $Y$ . At the level of cellular chain complexes, an

admissible discrete vector field on  $X$  induces homomorphisms  $h_{n-1}: C_{n-1}X \rightarrow C_nX$  of free abelian groups, defined recursively on free generators by

$$h_{n-1}(e_i^{n-1}) = \begin{cases} 0, & \text{if } e_i^{n-1} \text{ is not the source of any arrow,} \\ e_{i'}^n + h_{n-1}(\partial_n(e_{i'}^n) - e_i^{n-1}), & \text{if } e_i^{n-1} \rightarrow e_{i'}^n \text{ is an arrow of the vector field.} \end{cases}$$

In the particular case where  $X$  has a single critical 0-cell and all other cells of  $X$  are involved in an arrow, the homomorphisms  $h_{n-1}$  constitute a contracting chain homotopy  $H_*: C_*X \simeq \mathbb{Z}$ . The discrete vector field on the cubic tree pictured in Figure 7 corresponds to the contracting homotopy given in (4.3) and (4.1).

As explained above, Theorems 10.1 and 10.2 provide an approach to constructing a contractible  $\binom{m}{2}$ -dimensional contractible CW-complex  $\mathcal{T}$  on which  $G = SL_m(\mathbb{Z})$  acts with finite stabilizers, and from which one can attempt to calculate the cohomology of  $G$ . A mathematically inelegant, but perhaps not totally impractical, approach to working with a contracting homotopy  $h_*: C_*\mathcal{T} \simeq \mathbb{Z}$  is to note that in any given computation the values  $h(e_i^k)$  are needed on only finitely many free generators  $e_i^k$  of  $C_k\mathcal{T}$ . So we could construct a *suitably large* tree  $W^1$  in the 1-skeleton of  $\mathcal{T}$  and consider the finite CW-subcomplex  $W \subset \mathcal{T}$  consisting of all cells in  $\mathcal{T}$  whose closure contains a vertex in the tree  $W^1$ . It *may* be that  $W$  is contractible, and it *may* also happen that HAP's algorithm for constructing a maximal discrete vector field on a finite regular CW-complex would yield a discrete vector field on  $W$  involving precisely one critical cell. When these two hypotheses are met we obtain a contracting homotopy on the finite subcomplex  $C_*W \subset C_*\mathcal{T}$ ; if  $W$  is large enough then the vector field would suffice for the computation of Hecke operators.

**Example 13.3.** The 3-dimensional  $G$ -equivariant space  $\mathcal{T}$  for  $G = SL_3(\mathbb{Z})$  has one orbit of  $k$ -cells for  $k = 0, 1, 3$  and two orbits of 2-cells. A full description of  $\mathcal{T}$  can be found in [35]. Starting at the identity vertex  $e^0 \in \mathcal{T}$  of this particular  $\mathcal{T}$  and applying  $n = 15$  iterations of a breadth-first search, the author constructed a tree  $W^1$  with 15548 vertices; the corresponding 3-dimensional CW-complex  $W$  had a total of 72267 cells. HAP's algorithm for constructing maximal discrete vector fields produced one on  $W$  for which there was a single critical cell. This contracting discrete vector field on  $W$  can be viewed as a discrete vector field on  $\mathcal{T}$  which contracts the subspace  $W$ . The author has not yet tried to compute Hecke operators using such a discrete vector field.

There are alternative approaches to constructing discrete vector fields on contractible complexes  $\mathcal{T}$ . Before discussing one of these, it is worth recalling that there exist contractible regular CW-complexes that do not admit any admissible contracting discrete vector field. Figure 8 shows a famous example, *Bing's house*, arising as the union of finitely many closed unit squares in  $\mathbb{R}^3$ . The house is a 2-dimensional CW-complex  $Y$  involving two rooms, each room having a single entrance. The downstairs room is entered through an entrance on the roof of the house; the upstairs room is entered through an entrance on the bottom floor of the house. Suppose that Bing's house  $Y$  admitted an admissible discrete vector field with precisely one critical cell  $e^0$ . The arrows  $e_i^0 \rightarrow e_j^1$  would constitute a maximal tree in the 1-skeleton of  $Y$  rooted at the vertex  $e^0$ . The remaining arrows  $e_i^1 \rightarrow e_j^2$  would pair those edges not in the maximal tree with the 2-cells of  $Y$ . Every edge  $e_i^1$  is in the boundary of at least two 2-cells, say  $e_j^2$  and  $e_{j'}^2$ . Thus each edge  $e_i^1$  which is not in the maximal tree must be a non-initial edge in some chain  $\cdots, e_1^k \rightarrow e_{j'}^2, e_i^1 \rightarrow e_j^2, \cdots$  in the discrete vector field. Since the discrete vector field has only finitely many arrows it must contain a circuit.

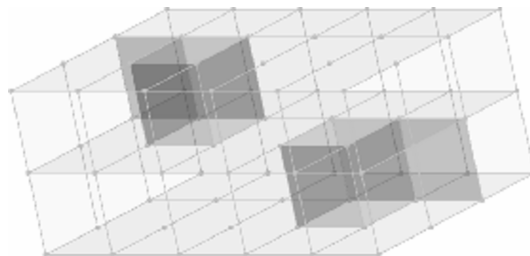

FIGURE 8. Bing's house

This contradicts the admissibility hypothesis. To establish that Bing's house  $Y$  is contractible one could use the following HAP commands to load  $Y$  as a regular CW-complex involving 72 0-cells, 154 1-cells, 83 2-cells, and then compute that it is acyclic with trivial fundamental group.

```
gap> dir:=Filename(DirectoriesPackageLibrary("HAP","tst/testall")[1],"bing.txt");;
gap> Read(dir);
gap> Y:=BingsHouse;
Regular CW-complex of dimension 2
gap> Y!.nrCells(0);
72
gap> Y!.nrCells(1);
154
gap> Y!.nrCells(2);
83
gap> F:=FundamentalGroup(Y);
<fp group on the generators [ ]>
gap> Homology(Y,0);
[ 0 ]
gap> Homology(Y,1);
[ ]
gap> Homology(Y,2);
[ ]
```

We now discuss an alternative approach to constructing discrete vector fields on contractible complexes. Suppose that  $X$  is a regular  $n$ -dimensional CW-complex,  $n \geq 1$ , satisfying each of the following hypotheses:

1.  $X$  is *pure*, by which we mean that every cell of dimension  $< n$  lies in the closure of at least one  $n$ -cell.
2.  $X$  is a subspace of some Euclidean space  $\mathbb{R}^n$ , with every  $n$ -cell of  $X$  convex.
3.  $X$  is *star-like*, by which we mean that there is some preferred 0-cell  $e^0 \in X$  such that for any point  $x \in X$  the line from  $x$  to  $e^0$  lies entirely in  $X$ .

For example, the CW-complex  $S_{n=1}^m$  of Theorem 10.2 can be viewed as a regular CW-complex  $X$  satisfying these hypotheses.

Let  $X$  be any space satisfying the hypotheses 1–3. For  $x \in X$  let  $[x, e^0]$  denote the closed line segment from  $x$  to the preferred 0-cell  $e^0$ . We denote the closure of a  $k$ -cell  $e^k$  by  $\overline{e^k}$ . We define the *shadow* of a  $k$ -cell  $e^k$  to be the set

$$\text{Sh}(e^k) = \{x \in \overline{e^k} : [x, e^0] \cap e^k = \emptyset\}.$$

The shadow  $\text{Sh}(e^k)$  is a sub CW-complex of the closure  $\overline{e^k}$ , and moreover a deformation retract of  $\overline{e^k}$ . Let us suppose that for each cell  $e^k$  an admissible discrete vector field can be constructed on  $\overline{e^k}$  for which the critical cells are precisely the cells in the shadow  $\text{Sh}(e^k)$ . The union of the discrete vector fields on the closures  $\overline{e^k}$  then constitute a contracting discrete vector field on the space  $X = \bigcup \overline{e^k}$ . As an illustration, Figure 9 shows part of an admissible contracting discrete vector field on  $X = S_{=1}^2$ . In the figure two 2-cells of  $S_{=1}^2$  are labelled as  $e$  and  $f$ ; the preferred 0-cell is labelled  $(1,0)$ , and with respect to this choice the shadow  $\text{Sh}(e)$  consists of one edge and two vertices, whereas the shadow  $\text{Sh}(f)$  consists of two edges and the single preferred 0-cell; the figure shows discrete vector fields on the closures of  $e$  and  $f$ ; these vector fields are restrictions of a contracting discrete vector field on  $S_{=1}^2$ .

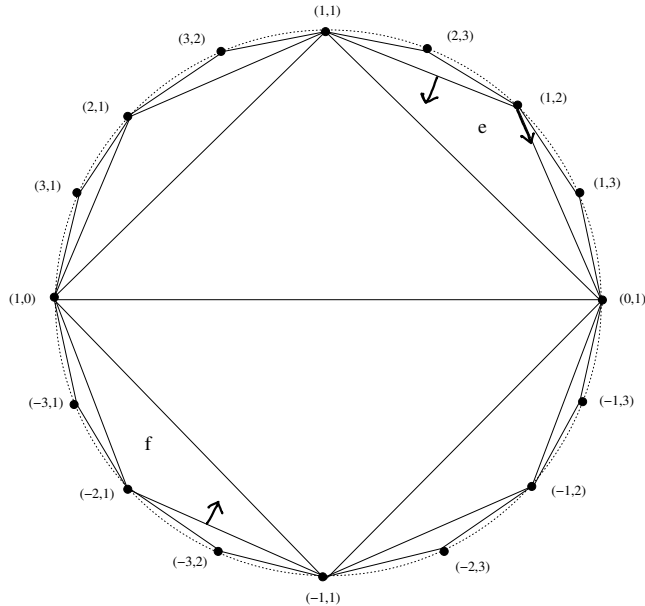

FIGURE 9. A portion of a contracting discrete vector field on  $S_{=1}^2$

It is an exercise to verify that for  $k = 1, 2, 3$  any homotopy equivalence  $\text{Sh}(e^k) \hookrightarrow \overline{e^k}$  can indeed be realized as an admissible discrete vector field on  $\overline{e^k}$ . We have thus established the following.

**Proposition 13.4.** Let  $G = SL_2(\mathcal{O}_d)$  for square-free  $d < 0$ . A free  $\mathbb{Z}G$ -resolution  $R_*^G$  of  $\mathbb{Z}$  and contracting homotopy  $h_*: R_*^G \simeq \mathbb{Z}$  can be implemented on a computer, with  $R_n^G$  finitely generated

for all  $n \geq 0$ . Arbitrary elements  $w \in R_n^G$  can be expressed and their images  $d_n(w)$ ,  $h_n(w)$  can be uniquely determined. ■

## 14 Acknowledgements

The author is very grateful to the referee for helpful comments and suggestions.

## References

- [1] Avner Ash. Deformation retracts with lowest possible dimension of arithmetic quotients of self-adjoint homogeneous cones. *Math. Ann.*, 225(1):69–76, 1977.
- [2] Avner Ash and Warren Sinnott. An analogue of Serre’s conjecture for Galois representations and Hecke eigenclasses in the mod  $p$  cohomology of  $\mathrm{GL}(n, \mathbf{Z})$ . *Duke Math. J.*, 105(1):1–24, 2000.
- [3] A. O. L. Atkin and J. Lehner. Hecke operators on  $\Gamma_0(m)$ . *Math. Ann.*, 185:134–160, 1970.
- [4] Nicolas Bergeron. Torsion homology growth in arithmetic groups. In *European Congress of Mathematics*, pages 263–287. Eur. Math. Soc., Zürich, 2018.
- [5] Nicolas Bergeron and Akshay Venkatesh. The asymptotic growth of torsion homology for arithmetic groups. *J. Inst. Math. Jussieu*, 12(2):391–447, 2013.
- [6] Oliver Braun, Renaud Coulangeon, Gabriele Nebe, and Sebastian Schönneck. Computing in arithmetic groups with Voronoï’s algorithm. *J. Algebra*, 435:263–285, 2015.
- [7] J. E. Cremona. *Algorithms for modular elliptic curves*. Cambridge University Press, Cambridge (<http://homepages.warwick.ac.uk/staff/J.E.Cremona//book/fulltext/>), second edition, 1997.
- [8] Mehmet Haluk Şengün. On the integral cohomology of Bianchi groups. *Exp. Math.*, 20(4):487–505, 2011.
- [9] M. Dutour-Sikrić. Data for complexes on which certain arithmetic groups act with nice stabilizer subgroups. *private communication*, 2011.
- [10] M. Eichler. Eine Verallgemeinerung der Abelschen Integrale. *Math. Z.*, 67:267–298, 1957.
- [11] G. Ellis. Computing group resolutions. *J. Symbolic Comput.*, 38(3):1077–1118, 2004.
- [12] G. Ellis. *HAP – Homological Algebra Programming, Version 1.21*, November 2019. (<http://www.gap-system.org/Packages/hap.html>).
- [13] G. Ellis, J. Harris, and E. Sköldbberg. Polytopal resolutions for finite groups. *J. Reine Angew. Math.*, 598:131–137, 2006.
- [14] Dieter Flöge. Zur Struktur der  $\mathrm{PSL}_2$  über einigen imaginär-quadratischen Zahlringen. *Math. Z.*, 183(2):255–279, 1983.

- [15] R. Forman. Morse theory for cell complexes. *Adv. Math.*, 134(1):90–145, 1998.
- [16] R. Forman. A user’s guide to discrete Morse theory. *Sém. Lothar. Combin.*, 48:Art. B48c, 35, 2002.
- [17] Jens Franke. Harmonic analysis in weighted  $L_2$ -spaces. *Ann. Sci. École Norm. Sup. (4)*, 31(2):181–279, 1998.
- [18] The GAP Group. *GAP – Groups, Algorithms, and Programming, Version 4.5.6*, 2013. (<http://www.gap-system.org>).
- [19] Paul E. Gunnells. Lectures on computing cohomology of arithmetic groups. In *Computations with modular forms*, volume 6 of *Contrib. Math. Comput. Sci.*, pages 3–45. Springer, Cham, 2014.
- [20] G. Harder. Eisenstein cohomology of arithmetic groups. The case  $GL_2$ . *Invent. Math.*, 89(1):37–118, 1987.
- [21] D.W. Jones. A general theory of polyhedral sets and the corresponding  $T$ -complexes. *Dissertationes Math. (Rozprawy Mat.)*, 266:110, 1988.
- [22] Colin Maclachlan and Alan W. Reid. *The arithmetic of hyperbolic 3-manifolds*, volume 219 of *Graduate Texts in Mathematics*. Springer-Verlag, New York, 2003.
- [23] Greg Martin. Dimensions of the spaces of cusp forms and newforms on  $\Gamma_0(N)$  and  $\Gamma_1(N)$ . *J. Number Theory*, 112(2):298–331, 2005.
- [24] Bernard Maskit. On Poincaré’s theorem for fundamental polygons. *Advances in Math.*, 7:219–230, 1971.
- [25] Eduardo R. Mendoza. *Cohomology of  $PGL_2$  over imaginary quadratic integers*. Bonner Mathematische Schriften [Bonn Mathematical Publications], 128. Universität Bonn, Mathematisches Institut, Bonn, 1979. Dissertation, Rheinische Friedrich-Wilhelms-Universität, Bonn, 1979.
- [26] A. Page. Computing fundamental domains for arithmetic kleinian groups. *Masters Thesis, Université Paris 7 –Diderot*, 2010.
- [27] Aurel Page. Computing arithmetic Kleinian groups. *Math. Comp.*, 84(295):2361–2390, 2015.
- [28] A. Rahm. Cohomologies and  $k$ -theory of bianchi groups using computational geometric models. *Thesis, University of Grenoble*, 2010.
- [29] A.D. Rahm and M. Fuchs. The integral homology of  $PSL_2$  of imaginary quadratic integers with nontrivial class group. *J. Pure Appl. Algebra*, 215(6):1443–1472, 2011.
- [30] Robert Riley. Applications of a computer implementation of Poincaré’s theorem on fundamental polyhedra. *Math. Comp.*, 40(162):607–632, 1983.
- [31] Peter Scholze. On torsion in the cohomology of locally symmetric varieties. *Ann. of Math. (2)*, 182(3):945–1066, 2015.

- [32] Sebastian Schönneck. Resolutions for unit groups of orders. *J. Homotopy Relat. Struct.*, 12(4):837–852, 2017.
- [33] Achill Schürmann. Enumerating perfect forms. In *Quadratic forms—algebra, arithmetic, and geometry*, volume 493 of *Contemp. Math.*, pages 359–377. Amer. Math. Soc., Providence, RI, 2009.
- [34] Goro Shimura. Sur les intégrales attachées aux formes automorphes. *J. Math. Soc. Japan*, 11:291–311, 1959.
- [35] C. Soulé. The cohomology of  $SL_3(\mathbf{Z})$ . *Topology*, 17(1):1–22, 1978.
- [36] William Stein. *Modular forms, a computational approach*, volume 79 of *Graduate Studies in Mathematics*. American Mathematical Society, Providence, RI, 2007. With an appendix by Paul E. Gunnells.
- [37] William A. Stein. An introduction to computing modular forms using modular symbols. In *Algorithmic number theory: lattices, number fields, curves and cryptography*, volume 44 of *Math. Sci. Res. Inst. Publ.*, pages 641–652. Cambridge Univ. Press, Cambridge, 2008.
- [38] Richard G. Swan. Generators and relations for certain special linear groups. *Advances in Math.*, 6:1–77 (1971), 1971.
- [39] Georges Voronoi. Nouvelles applications des paramètres continus à la théorie des formes quadratiques. Premier mémoire. Sur quelques propriétés des formes quadratiques positives parfaites. *J. Reine Angew. Math.*, 133:97–102, 1908.
- [40] C. T. C. Wall. Resolutions for extensions of groups. *Proc. Cambridge Philos. Soc.*, 57:251–255, 1961.
- [41] J. H. C. Whitehead. Simple homotopy types. *Amer. J. Math.*, 72:1–57, 1950.
- [42] Gabor Wiese. *Computational arithmetic of modular forms*. Modulformen II, Wintersemester 2007/2008. Universität Duisburg-Essen, 2008.
- [43] Dan Yasaki. Hyperbolic tessellations associated to Bianchi groups. In *Algorithmic number theory*, volume 6197 of *Lecture Notes in Comput. Sci.*, pages 385–396. Springer, Berlin, 2010.