



UNIVERSIDAD NACIONAL AUTÓNOMA DE MÉXICO
POSGRADO EN CIENCIAS FÍSICAS

Divisibility classes of qubit maps and singular Gaussian channels

TESIS

Que para obtener el grado de: Doctor en Ciencias (Física)
Presenta: David Dávalos González
Director de tesis: Dr. Carlos Francisco Pineda Zorrilla
Codirector: Dr. Mario Ziman

Miembros del Comité Tutorial:
Dr. Carlos Pineda, Dr. Luis Benet, y Dr. Thomas H. Seligman

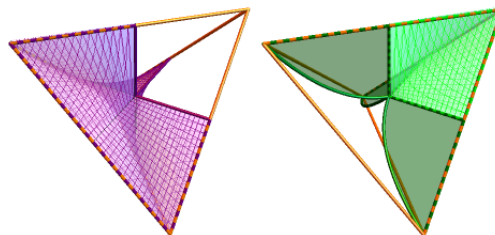

México D. F., 2019



UNIVERSIDAD NACIONAL AUTÓNOMA DE MÉXICO
POSGRADO EN CIENCIAS FÍSICAS

Divisibility classes of qubit maps and singular Gaussian channels

THESIS

To obtain the degree: Doctor en Ciencias (Física)
Presents: David Dávalos González
Director: Dr. Carlos Francisco Pineda Zorrilla
Co-director: Dr. Mario Ziman

Members of the Tutorial Committee:
Dr. Carlos Pineda, Dr. Luis Benet, and Dr. Thomas H. Seligman

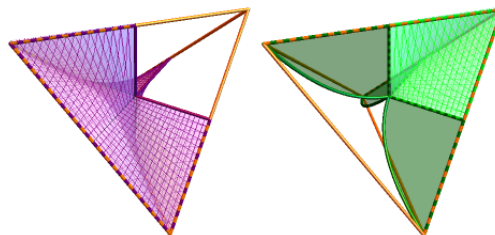

México D. F., 2019

*Truth is ever to be found in simplicity, and not in the multiplicity and confusion
of things.*

Isaac Newton

Gracias

La idea que nació cuando cursaba la secundaria, la de convertirme algún día en científico, no habría sido posible de no haber nacido en el seno de una familia estable, funcional y de sólidos valores. Por eso les agradezco infinitamente a mis queridos Padres. A mi Madre, Sara, por dedicarme tanto de su tiempo y energía, por ser una Madre muy amorosa, llena de valores y por ser la persona mas paciente del mundo. Le agradezco a mi Padre, Juan Manuel, por siempre estar atento a que fuera una persona de principios y un buen ciudadano, por ser un padre amoroso y por darme su confianza. Le agradezco que siempre se haya preocupado por tener una computadora en casa y por ser un entusiasta de la tecnología, eso aportó fundamentalmente a quien soy hoy. A mis hermanas y hermanos por preocuparse por mi y por regalarme tantas veces su tiempo. A mi compañera de vida, a mi esposa Lorena, gracias por tenerme tanta paciencia, por creer en mi y por quererme tanto. A mi tutor y amigo, Carlos, le agradezco su paciencia, sus valiosas enseñanzas, su gran apoyo y su amistad. A Thomas Seligman y Luis Benet por siempre apoyarme. Le agradezco a mis amigos Luis Juárez, Arturo Carranza, Thomas Gorin, Mario Ziman, Mauricio Torres, Roberto León, François Leyvraz, Pablo Barberis, Diego Wisniacki, Ignacio García, Juan Diego Urbina, Peter Rapčan, Tomáš Rybár, Edgar Aguilar, David Amaro, Alvaro Díaz, Miguel Cardona, Chayo Camarena, Antonio Rosado, Sergio Sánchez, Nephtalí Garrido, Sergio Pallaleo, Samuel Rosalio, Alejandro Reyes, Afra Montero y Daniel Garibay. A mis gatitos Lola y Dalí por hacerme feliz el poco tiempo que estuvieron en este mundo. A mi querida gatita Lulú por hacer de mi hogar siempre un lugar feliz. Les agradezco a todos los seres queridos que hicieron de esta parte de mi trayectoria algo memorable.

Agradezco el apoyo brindado por los proyectos PAPIIT número IG100518 y CONACYT CB-285754.

SYNOPSIS

We present two projects concerning the main part of my PhD work. In the first one we study quantum channels, which are the most general operations mapping quantum states into quantum states, from the point of view of their divisibility properties. We introduced tools to test if a given quantum channel can be implemented by a process described by a Lindblad master equation. This in turn defines channels that can be divided in such a way that they form a one-parameter semigroup, thus introducing the most restricted studied divisibility type of this work. Using our results, together with the study of other types of divisibility that can be found in the literature, we characterized the space of qubit quantum channels. We found interesting results connecting the concept of entanglement-breaking channel and infinitesimal divisibility. Additionally we proved that infinitely divisible channels are equivalent to the ones that are implementable by one-parameter semigroups, opening this question for more general channel spaces. In the second project we study the functional forms of one-mode Gaussian quantum channels in the position state representation, beyond Gaussian functional forms. We perform a *black-box* characterization using complete positivity and trace preserving conditions, and report the existence of two subsets that do not have a functional Gaussian form. The study covers as particular limit the case of singular channels, thus connecting our results with the known classification scheme based on canonical forms. Our full characterization of Gaussian channels without Gaussian functional form is completed by showing how Gaussian states are transformed under these operations, and by deriving the conditions for the existence of master equations for the non-singular cases.

Keywords: divisibility, qubit channels, open quantum systems.

RESUMEN

En esta tesis se presentan dos proyectos realizados durante mis estudios de doctorado. En el primero se estudian los canales cuánticos, que son las operaciones más generales que transforman estados cuánticos en estados cuánticos, desde el punto de vista de sus propiedades de divisibilidad. Introducimos herramientas para probar si un canal cuántico dado puede ser implementado por un proceso descrito por una ecuación maestra de Lindblad. Ésto a su vez define a los canales que pueden ser divididos de tal manera que ellos forman semigrupos de un parámetro, introduciendo entonces el tipo más restringido de divisibilidad estudiado de este trabajo. Usando nuestros resultados, junto con el estudio de otros tipos de divisibilidad que pueden ser encontrados en la literatura, caracterizamos el espacio de canales cuánticos de un qubit. Encontramos resultados interesantes que conectan el concepto de canales que rompen el entrelazamiento (del sistema con cualquier sistema auxiliar) y el de divisibilidad infinitesimal. Además probamos que el conjunto de canales infinitamente divisibles es equivalente al de los canales implementables por semigrupos de un parámetro. Ésto abre la pregunta sobre si esto sucede para espacios de canales más generales. En el segundo proyecto estudiamos las formas funcionales de canales Gaussianos de un solo modo, más allá de la forma funcional Gaussiana. Se hace una caracterización de *caja negra* utilizando las condiciones de completa positividad y preservación de la traza, y se reporta la existencia de dos subconjuntos que no poseen forma funcional Gaussiana. El estudio cubre en particular el límite de los canales singulares, conectando entonces nuestros resultados con la clasificación basada en formas canónicas. Nuestra caracterización de canales Gaussianos sin forma funcional Gaussiana es completada mostrando como los estados Gaussianos se transforman bajo esas operaciones, así como al derivar las condiciones para la existencia de ecuaciones maestras para los casos no singulares.

Contents

1	Introduction	1
2	Open quantum systems and quantum channels	5
2.1	Introduction to the scheme of open quantum systems	5
2.2	Quantum channels	15
2.3	Quantum channels of continuous variable systems	23
3	Representations of quantum channels	27
3.1	Kraus representation	27
3.2	Choi-Jamiołkowski representation	29
3.3	Operational representations	30
3.4	Qubit channels	34
3.5	Representation of Gaussian quantum channels	40
4	Divisibility of quantum channels and dynamical maps	47
4.1	Divisibility of quantum maps	47
4.2	Characterization of L-divisibility	56
4.3	Divisibility of unital qubit channels	57
4.4	Non-unital qubit channels	68
4.5	Divisibility transitions and examples with dynamical processes . .	72
5	Singular Gaussian quantum channels	79
5.1	Allowed singular forms	79
5.2	Existence of master equations	84
6	Summary and conclusions	89
7	Appendices	93
A	Exact dynamics with Lindblad master equation	95

B On Lorentz normal forms of Choi-Jamiolkowski state	97
Bibliography	99

Chapter 1

Introduction

In questions of science, the authority of a thousand is not worth the humble reasoning of a single individual.
Galileo Galilei

The advent of quantum technologies opens questions aiming for deeper understanding of the fundamental physics beyond the idealized case of isolated quantum systems. Also the well established Born-Markov approximation used to describe open quantum systems (e.g. relaxation process such as spontaneous decay and decoherence) is of limited use and a more general framework of open system dynamics is required. Recent efforts in this area have given rise to relatively novel research subjects - non-markovianity and divisibility.

A central object of study in quantum information theory and open quantum systems are quantum channels, also called quantum operations. They describe, for instance, the noisy communication between Alice and Bob or the changes that an open quantum system undergoes at some fixed time. They can also be seen as the basic building blocks of time-dependent quantum processes (also called quantum dynamical maps). Conversely, families of quantum channels arise naturally given a quantum dynamical map.

Given a quantum channel, for instance a spin flip or the approximation of the universal NOT gate, one can wonder about how it can be implemented. The latter in the sense of, being quantum channels discrete operations, can we find a continuous time-dependent process that at some time it implements the given channel?; or is there a process such that we “just wait for a relaxation of the physical system” to implement such channel? It turns out that this question is related with the

one of finding simpler operations such that their concatenation equals the given quantum channel [WC08]. Such operations are simpler in the sense that they are closer to the subset of unitary operations, or even “smaller” in the sense that they are closer to the identity channel.

This thesis encompasses the results of two works developed during my PhD.

The first and the most extended one was devoted to study the divisibility properties of quantum channels (discrete evolutions of quantum systems), for the particular case of qubits. We revise the divisibility types introduced in the seminal paper by Wolf et al. [WC08] and derived several useful relations to decide each type of divisibility. In particular, we characterize channels that can be divided in such a way that they belong to one-parameter semigroups (dynamics described by Lindblad master equations), and extended the analysis of [WECC08] for channels with negative eigenvalues. We did this using the results by Evans et al. [EL77] and Culver [Cul66].

Beyond the mentioned characterization tools, the principal aim of the work was to understand the forms of non-markovianity standing behind the observed quantum channels. The non-markovianity character describes the back-action of the system’s environment on the system’s future time evolution. Such phenomena is identified as emergence of memory effects [ARHP14, VSL⁺11, PGD⁺16]. On the other side, divisibility questions the possibility of splitting a given quantum channel into a concatenation of other quantum channels. In this work we will investigate the relation between these two notions. Thus, we related features of continuous time evolutions of quantum systems, and the concept of divisibility of quantum maps, which are discrete evolutions. A very first example of this is the well known identification of one-parameter semigroups with Lindbladian dynamics [Lin76].

The second project is devoted to representation theory of continuous-variable quantum systems, which is a central topic of study given its role in the description of physical systems like the electromagnetic field [CLP07], solids and nanomechanical systems [AKM14] and atomic ensembles [HSP10]. In this theory the simplest states, both from a theoretical and experimental point of view, are the so-called Gaussian states. An operation that transforms such family of states into itself is called a Gaussian quantum channel (GQC). Even though Gaussian states and channels form small subsets among general states and channels, they have proven to be useful in a variate of tasks such as quantum communication [GVAW⁺03], quantum computation [LB99] and the study of quantum entanglement in simple [BvL05] and complicated scenarios [LRW⁺18]. In this project we study the possible functional forms that one-mode Gaussian quantum channels can have

in the position state representation, and characterize the particular case of singular channels. Although they are already characterized by their action on the first and second moments of Gaussian states [Hol07, WPGP⁺12], we connect our framework to such known results. Additionally we give an insight of the possible functional forms of, for instance, Gaussian unitaries.

The thesis is organized as follows: In chapter 2 we discuss the most widely adopted scheme to study open quantum systems, introducing the formalism of bipartite systems and useful tools for it. Later on we present the general setting for system plus reservoir dynamics and its formal solution. As a paradigmatic example of open system dynamics, we present briefly the microscopic derivation of the Lindblad master equation using the well known Born-Markov approximation, and discuss the properties of the generator of the dynamics. Subsequently we introduce the formalism of quantum channels, being the most general operations over quantum systems (excluding post-selection), by introducing some useful mathematical definitions and contrasting with its classical analog. Additionally we discuss briefly the concept of *local operations and classical communications* (LOCC), also known as filtering operations. Finally we give a very brief introduction to continuous variable systems, giving special attention to Gaussian states and channels.

In chapter 3 we discuss the different available representations for quantum channels and their relation with the concept of complete positivity. In particular we introduce the well known Kraus representation and discuss the Choi-Jamiołkowski theorem which in turn defines a very useful representation to study quantum channels and their divisibility properties. Later on we introduce various matrix representations of quantum channels, paying special attention to hermitian and traceless bases types (without taking into account the component proportional to identity). Furthermore we introduce useful decompositions of qubit channels into unitary conjugations and one-way stochastic local operations, and classical communication, both being analogous to the well known singular value decomposition. Finally we give an introduction to representations of Gaussian channels and a detailed derivation of the position-state representations for Gaussian channels without Gaussian functional form.

In chapter 4 we give the definition of divisible quantum channel, as well as the definition of various subclasses of divisible channels concerning additional properties. In particular we discuss the concepts of infinitesimal and infinitely divisible channels and some relations and inclusions between them. Among infinitesimal divisible channels we identify two subclasses, being the set of infinitesimal divisible channels in complete positive and positive (but not complete positive) maps.

Later on we introduce the concept of L-divisible channels, defining the set of channels which are members of one-parameter semigroups. We show that the set of infinitely divisible channels is the same of the L-divisible Pauli channels.

In chapter 5 we study one-mode Gaussian quantum channels in continuous-variable systems by performing a *black-box* characterization using complete positivity and trace preserving conditions, and report the existence of two subsets that do not have a functional Gaussian form. Our study covers as particular limit the case of singular channels, thus connecting our results with their known classification scheme based on canonical forms. Our full characterization of Gaussian channels without Gaussian functional form is completed by showing how Gaussian states are transformed under these operations, and by deriving the conditions for the existence of master equations for the non-singular cases.

In chapter 6 we give a summary of the two projects introduced in this work and conclusions.

Finally, in the appendix A we prove that the exact reduced dynamics of an open quantum system never follow a Lindblad master equation unless they are unitary, given a bounded global Hamiltonian. In appendix B we give an example that shows that the set of Lorentz normal forms introduced in the literature, is incomplete.

Chapter 2

Open quantum systems and quantum channels

When we talk mathematics, we may be discussing a secondary language built on the primary language of the nervous system.

John Von Neumann

In this chapter we introduce the usual scheme to study open quantum systems, the widely known Born-Markov approximation and the concept of CP-divisibility. Later on and based on the idea of (*classical*) *stochastic map*, we discuss the axiomatic formulation of quantum channels and its connection with the usual construction of open quantum systems. Finally, for continuous variable systems, we discuss the paradigmatic example of Gaussian channels.

2.1 Introduction to the scheme of open quantum systems

The most widely used scheme to study open quantum systems is based on the idea of study a closed system composed by the *central system* and its *environment*, see fig. 2.1 for an schematic explanation. Thus, concepts as bipartite Hilbert spaces, density matrix and partial trace are useful tools to study open systems. In what follows we give a brief review of them.

Bipartite Hilbert space. Consider a bipartite closed quantum system described by a Hilbert space with the structure $\mathcal{H} = \mathcal{H}_S \otimes \mathcal{H}_E$, where \mathcal{H}_S is the Hilbert

space of the open system and \mathcal{H}_E is the Hilbert space of the *environment*. If $\{|\phi_i^S\rangle\}_{i=1}^{\dim(\mathcal{H}_S)}$ and $\{|\phi_i^E\rangle\}_{i=1}^{\dim(\mathcal{H}_E)}$ are basis for the spaces \mathcal{H}_S and \mathcal{H}_E , respectively, a basis for \mathcal{H} is simply $\{|\phi_i^S\rangle \otimes |\phi_j^E\rangle\}_{i=1, j=1}^{\dim(\mathcal{H}_S), \dim(\mathcal{H}_E)}$. It is typical that for finite dimensional systems one has that $\dim(\mathcal{H}_E) \gg \dim(\mathcal{H}_S)$ as the environment is usually “bigger” than the central system.

To describe the states of open quantum systems it is necessary to model the *ignorance* that the observer has with respect to the open system. Since the experimentalist cannot access the degrees of freedom of the environment, they are simply ignored. To do this we need the two following concepts.

Density matrix. Let a quantum system that has probability p_i to be in the state $|\phi_i\rangle$, and let the operator A an observable over such system. Using the average formula $\langle A \rangle = \sum_i p_i \langle \phi_i | A | \phi_i \rangle$ it is straightforward to show that $\langle A \rangle = \text{tr}(A\rho)$ with

$$\rho = \sum_i p_i |\phi_i\rangle \langle \phi_i|, \quad (2.1)$$

and $\sum_i p_i = 1$. ρ is called *density operator* or *density matrix*. Note that ρ is a positive-semidefinite operator given that $p_i \geq 0$, and the states $|\phi_i\rangle$ do not need to be orthogonal. Also note that since ρ is hermitian, together with the positive-semidefiniteness, implies that we can always write any density matrix as a convex combination of orthogonal pure states. Thus, every operator ρ acting on a Hilbert space \mathcal{H} , fulfilling $\rho \geq 0$, $\rho = \rho^\dagger$ and $\text{tr}(\rho) = 1$ is a density matrix. The set of density matrices will be denoted along this work as $\mathcal{S}(\mathcal{H})$.

Comparing the notion of density matrices with the notion of state vectors in the Hilbert space $|\psi\rangle \in \mathcal{H}$, density matrices describe physical systems where the observer has an *incomplete* knowledge of the system’s state. Thus, while state vectors are naturally equipped with *intrinsic* or *quantum* probabilities, density operators are additionally equipped with *classical* probabilities. The density matrices enjoying the form $\rho = |\psi\rangle \langle \psi|$, or equivalently $\rho^2 = \rho$, i.e. projectors, are *pure states*. It is clear that in this case the system is prepared in the state $|\psi\rangle$ with probability one.

A useful quantity to characterize quantum states is the *purity*, defined as

$$P(\rho) = \text{tr}(\rho^2). \quad (2.2)$$

It ranges from $\dim(\mathcal{H})^{-1}$ to 1; 1 is obtained for pure states and $\dim(\mathcal{H})^{-1}$ for the complete mixture $\mathbb{1}/\dim(\mathcal{H})$.

Additionally the set \mathcal{S} is convex, i.e. any convex combination of density matrices is another density matrix, in the same way as classical distributions do. In fact, mixed states ($P(\rho) < 1$) can be written always as convex combinations of pure states, see eq. (2.1). Furthermore the set $\mathcal{S}(\mathcal{H})$ is a subset of the bigger set of *trace-class* operators, $\mathcal{T}(\mathcal{H})$, defined as the ones containing operators with finite trace norm. The latter is defined as $|\Delta|_{\text{tr}} = \text{tr} \sqrt{A^\dagger A}$. This set is in turn a subset of the set of bounded operators $\mathcal{B}(\mathcal{H})$, containing operators with finite *operator norm*, defined as $|A|_{\text{op}} = \sup_{|\psi\rangle} |A|\psi\rangle|$, where $|A|\psi\rangle| = \sqrt{\langle A\psi|A\psi\rangle}$, i.e. the standard Hilbert space norm, with normalized vectors $|\psi\rangle$.

It is worth to note that for the finite dimensional case, bounded operators always have finite trace norm and vice versa, thus $\mathcal{T}(\mathcal{H}) = \mathcal{B}(\mathcal{H})$. But the identification of such sets is relevant for infinite dimensional systems, where counter-examples of the non-equivalence of such sets exist [HZ12]. Additionally $\mathcal{B}(\mathcal{H})$ is the dual space of $\mathcal{T}(\mathcal{H})$ under the Hilbert-Schmidt product, defined as $\langle A, B \rangle = \text{tr}(A^\dagger B)$ [Hol01].

Now, to ignore the degrees of freedom of the unaccessible part of the system, we have to perform an operation in a very analogous way as computing marginal distributions in classical probability theory. For density operators this introduces the concept of partial trace.

Partial trace. Let $\rho \in \mathcal{S}(\mathcal{H}_A \otimes \mathcal{H}_B)$ and $\mathcal{H}_{A,B}$ the Hilbert spaces of systems A and B . Thus, ρ describes a state of a bipartite system composed by A and B . If we want to know the state of the system A alone, one performs a partial trace over B defined as

$$\rho_A = \text{tr}_B(\rho_{AB}) = \sum_{i=1}^{d_B} (\mathbb{1} \otimes \langle \phi_i^B |) \rho_{AB} (\mathbb{1} \otimes |\phi_i^B\rangle),$$

where $\{|\phi_i^B\rangle\}_{i=1}^{d_B}$ is a complete orthonormal basis on \mathcal{H}_B . The resulting operator ρ_A is a density matrix describing the state of the system A alone. It is trivial to show that it is a density operator. A similar formula holds for ρ_B . An alternative definition is $\text{tr}_B(A \otimes B) = A \text{tr}(B)$ plus linearity.

In general for composite systems, in a pure state, knowing the reduced states (for instance for bipartite systems, ρ_A and ρ_B) is in general not enough to know the whole state of a system. This captures the *non-local* nature of quantum correlations, demanding simultaneous measurements on both parts of the system. In such case we say that the subsystems A and B are entangled. To see this, consider the example of the Bell state $|\Omega\rangle = 1/\sqrt{2}(|00\rangle + |11\rangle)$, where $\{|0\rangle, |1\rangle\}$ is an orthogonal basis of a qubit system. It is trivial to show that $|\Omega\rangle$ cannot be written

as $|\phi\rangle \otimes |\psi\rangle$, a factorizable state, prohibiting the observer to know the state of the whole system only by non-simultaneous measurements on A and B (described by reduced density matrices). In fact it is easy to show that $\rho_{A,B} = \mathbb{1}/2$ are the reduced density matrices, appearing also when the total state is $\rho_{AB} = \mathbb{1}/4$. For composite systems in mixed states the situation is quite different. In this case simultaneous measurements are needed to access classical correlations. To see this consider the state

$$\rho_{AB} = \sum_i p_i \rho_A^i \otimes \rho_B^i, \quad (2.3)$$

being a convex combination of factorizable mixed states. This state is a mixed separable state [HHHH09], i.e. subsystems A and B are not entangled. Notice now that performing only local non-simultaneous measurements, the accessible reduced states are $\rho'_{A,B} = \sum p_i \rho_{A,B}^i$. This state also arises when the total system is in the factorizable state $\rho'_A \otimes \rho'_B$. Therefore local simultaneous measurements are needed.

2.1.1 System plus reservoir dynamics

The most widely used scheme to study open quantum systems is to consider a bipartite system, where the central system S , is interacting with its environment, E . The full system $S + E$ undergoes a closed system evolution, i.e. Hamiltonian dynamics, see fig. 2.1. The *total Hamiltonian* H , describing the whole system, has the following general structure

$$H = H_S + H_E + V, \quad (2.4)$$

where $H_{S,E}$ are the free Hamiltonians of the central system and the environment, respectively, and V is the interaction Hamiltonian among them. Now let $\rho_{SE}(0)$ be the state of the total system at the time $t = 0$. Thus, the state of the system S at the time t is simply:

$$\rho_S(t) = \text{tr}_E (U(t) \rho_{SE}(0) U^\dagger(t)), \quad (2.5)$$

where $U(t) = e^{-iHt}$ (taking $\hbar = 1$) and tr_E is the partial trace over the environmental degrees of freedom. Note that for a general initial state $\rho_{SE}(0)$, where one allows classical and quantum correlations, $\rho_{SE}(t)$ depends in general on initial information about the environment and its correlations with the central system S . Thus, to compute the dynamics of the central system such that we end up to universal reduced dynamics, i.e. the same for every initial state and independent of the initial information in the environment, we take a factorized initial

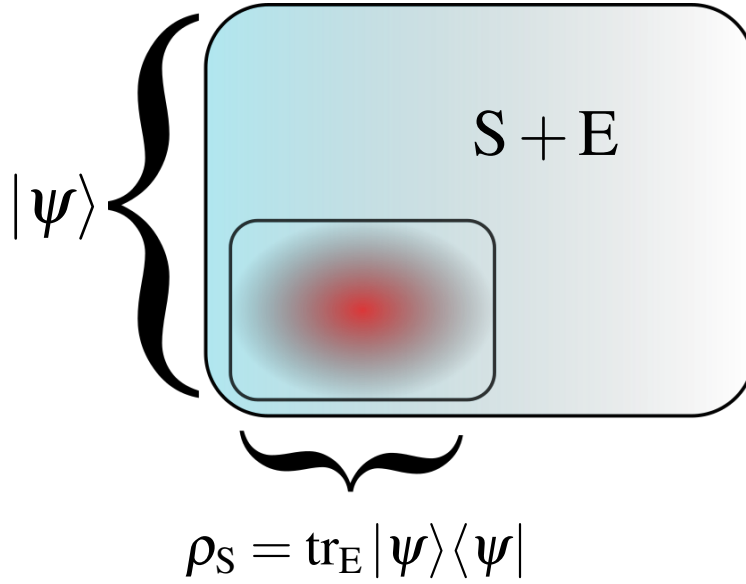

Figure 2.1: Diagram of the scheme to study open quantum systems. The letters S and E state for the *open (or central) system* and *environment* parts of the total closed system, S + E. The latter is described (typically) by a pure state $|\psi\rangle \in \mathcal{H}_S \otimes \mathcal{H}_E$ and the central system is described by the reduced state computed using the partial trace over the environmental degrees of freedom, see main text.

state $\rho_{SE}(0) = \rho_S(0) \otimes \rho_E$ [BP07, RH12]. We do not write explicitly the time-dependence of the environmental state since one is not usually interested on its evolution. With the choice of a factorizable total initial state and using equation eq. (2.5), we have the following expression for the evolution of the central system,

$$\rho_S(t) = \text{tr}_E [U(t) (\rho_S(0) \otimes \rho_E) U^\dagger(t)]. \quad (2.6)$$

Therefore we have that the dynamics over S only depends on the total Hamiltonian H and the environmental initial state ρ_E , whereas $\rho_S(t)$ depends only on its initial condition.

Hence the equation eq. (2.6) defines a dynamical map, \mathcal{E}_t , parametrized by t . Thus, we have

$$\mathcal{E}_t[\rho(0)] = \text{tr}_E [U(t) (\rho_S(0) \otimes \rho_E) U^\dagger(t)]. \quad (2.7)$$

Such map possesses all the information concerning the dynamics of the system S, thus knowing \mathcal{E}_t one can know entirely the evolution of the system S. The map

$$\begin{array}{ccc}
\rho_S(0) \otimes \rho_E & \xrightarrow{U(t) \cdot U^\dagger(t)} & \rho_{SE}(t) \\
\downarrow \text{tr}_E(\cdot) & & \downarrow \text{tr}_E(\cdot) \\
\rho_S(0) & \xrightarrow{\mathcal{E}_t} & \rho_S(t)
\end{array}$$

Figure 2.2: Scheme of the equivalences between the concept of dynamical map and the theory of open quantum systems.

\mathcal{E}_t can be obtained numerically or experimentally (depending on the context) by measuring only the system S by *quantum process tomography* [NC11]. In fig. 2.2 we present a schematic description of the two equivalent schemes under which the system S evolves, and their connection throughout tr_E .

Eq. (2.7) can be reduced, by writing $\rho_E = \sum_j p_j^E |\phi_j^E\rangle\langle\phi_j^E|$, in the following way,

$$\mathcal{E}_t[\rho_S(0)] = \sum_{i,j} K(t)_{i,j} \rho_S(0) K(t)_{i,j}^\dagger, \quad (2.8)$$

where the operators $K(t)_{ij} = \sqrt{p_j^E} \langle\phi_i^E|U(t)|\phi_j^E\rangle$ are called Kraus operators and act upon the system S alone [RH12]. The expression of eq. (2.8) is called *sum representation*, also called Kraus representation of the map \mathcal{E}_t , this will be retaken on chapter 3.

Now let us discuss the differential equation for the density matrix of an open quantum system. The total state of the system evolves according to the *Von Neumann equation* [BP07],

$$\frac{d\rho_{SE}}{dt} = -i[H, \rho_{SE}], \quad (2.9)$$

which is the analog of the Liouville equation describing the evolution of a classical distribution in the phase space.

Taking the partial trace on both sides of eq. (2.9) one arrives to the following:

$$\begin{aligned}
\frac{d\rho_S}{dt} &= -i \text{tr}_E[H, \rho_{SE}] \\
&= L_t[\rho_S],
\end{aligned} \quad (2.10)$$

where L_t is the generator of the master equation of the system S. Integrating time in both sides from $\tau = 0$ to $\tau = t$, we arrive to the equivalent integral equation:

$$\rho_S(t) = \rho_S(0) + \int_0^t d\tau L_\tau[\rho_S(t)]. \quad (2.11)$$

To compute the formal solution of this equation, we use the method of successive approximations. This consists on substituting the whole expression for $\rho_S(t)$ defined by the right hand side of eq. (2.11). A first iteration leads to

$$\rho_S(t) = \rho_S(0) + \int_0^t d\tau_1 L_{\tau_1}[\rho_S(0)] + \int_0^t d\tau_1 \int_0^{\tau_1} d\tau_2 L_{\tau_1}[L_{\tau_2}[\rho_S(t)]]. \quad (2.12)$$

Repeating this procedure infinite times, i.e. substituting $\rho_S(t)$ defined by the right hand side of the last equation in its second integrand several times, we arrive to a power series solution for $\rho_S(t)$ (powers of L_t). This leads to the well known Dyson series for L_t . Compactly,

$$\rho(t) = \vec{T} \exp \left(\int_0^t ds L_s \right) \rho(0) \quad (2.13)$$

with \vec{T} the time-ordering operator, defined as

$$\vec{T}[H(\tau_1)H(\tau_2)] = \theta(\tau_1 - \tau_2)H(\tau_1)H(\tau_2) + \theta(\tau_2 - \tau_1)H(\tau_2)H(\tau_1),$$

with $\theta(x)$ the Heaviside step function. Eq. (2.13) constitutes the formal solution to the Von Neumann equation with generator L_t , and we can easily identify $\mathcal{E}_t = \vec{T} \exp \left(\int_0^t ds L_s \right)$.

2.1.2 Born-Markov approach: microscopic derivation

In general the form of the generator L_t , given a global Hamiltonian, can be quite involved [BP07], but in the limit of *weak coupling* and *short memory* we can perform the very well known *Born-Markov approximation*. A brief discussion is presented in this subsection.

The Born-Markov approximation leads to the *Lindblad master equation*. We will briefly overview its usual textbook derivation. The first step is to use the interaction picture, hence the total Hamiltonian becomes $H_I(t) = e^{iH_0 t} H e^{-iH_0 t}$, where $H_0 = H_S + H_E$ is the *free* Hamiltonian. Assuming that the dimension of \mathcal{H}_E is big compared with the dimension of \mathcal{H}_S , the weak coupling limit leads to negligible changes in the environmental state. Thus, at time t we can approximate

$$\rho_{SE}(t) \approx \rho_S(t) \otimes \rho_E.$$

In other words, the state of the total system is left always approximately uncorrelated, while the state of the environment is never updated. Therefore the environment *forgets* any information about the central system, while the state of the

latter undergoes a non-trivial evolution. Additionally to simplify the derivation we choose ρ_E a stationary state of H_E , i.e. $[H_E, \rho_E] = 0$ [RH12]. ρ_E is typically chosen as a thermal state of the environmental Hamiltonian, $\rho_E \propto \exp(-\beta H_E)$, with $\beta = 1/(k_B T)$, k_B the Boltzmann constant and T the environment temperature.

Now, in the interaction picture the Von Neumann equation becomes

$$\frac{d\rho_S}{dt} = -i \text{tr}_E[V_I(t), \rho_S], \quad (2.14)$$

where $V_I(t) = e^{iH_0 t} V e^{-iH_0 t}$ and the state $\rho_S(t)$ are now written in the interaction picture. Inserting $\rho_S(t)$ from its integral equation eq. (2.11) in the differential equation (2.14) and assuming $\text{tr}_E[V_I(t), \rho_S \otimes \rho_E] = 0$ [BP07], we obtain

$$\frac{d\rho_S}{dt} = - \int_0^t d\tau \text{tr}_E[V_I(t), [V_I(\tau), \rho_S(\tau) \otimes \rho_E]]. \quad (2.15)$$

If we assume that the dynamics of the state of the central system does not depend on its past, we can change $\rho_S(\tau)$ to $\rho_S(t)$, this is called the *Markovian approximation*. Additionally doing the variable change $\tau' = t - \tau$, we arrive to

$$\frac{d\rho_S}{dt} = - \int_0^t d\tau' \text{tr}_E[V_I(t), [V_I(t - \tau'), \rho_S(t) \otimes \rho_E]], \quad (2.16)$$

this equation is known as Redfield equation [Red65] and it is local in time [BP07]. Assuming that the time scale on which the central system varies appreciably is much larger than the time on which the correlations of the environment decay (say τ_E), the integrand decays to zero rapidly for $\tau' \gg \tau_E$. Then we can safely replace t by ∞ in the integrand limits, obtaining

$$\frac{d\rho_S}{dt} = - \int_0^\infty d\tau' \text{tr}_E[V_I(t), [V_I(t - \tau'), \rho_S(t) \otimes \rho_E]]. \quad (2.17)$$

Up to this point, eq. (2.17) has in general fast oscillating terms coming from the explicit dependence on $V_I(t)$, this in turn can bring a generator that leads to a quantum process that violates complete positivity [ARHP14, RH12]. In order to get rid of such fast oscillations, one uses the aforementioned assumption that the environment is initialized in a stationary state, and perform the so called *secular approximation* [ARHP14]. A detailed derivation is outside of the scope of this thesis, but it can be consulted on references [BP07, RH12]. After performing the Markov, Born and secular approximations and changing back to the Schrödinger

picture, the resulting master equation can be written in the following forms

$$\frac{d\rho_S}{dt} = i[\rho_S, \tilde{H}_S] + \sum_{i,j=1}^{d_S^2-1} G_{ij} \left(F_i \rho_S F_j^\dagger - \frac{1}{2} \{F_j^\dagger F_i, \rho_S\} \right), \quad (2.18)$$

$$= i[\rho_S, \tilde{H}_S] + \sum_{j=1}^{d_S^2-1} \gamma_j \left(A_j \rho_S A_j^\dagger - \frac{1}{2} \{A_j^\dagger A_j, \rho_S\} \right), \quad (2.19)$$

$$= L[\rho_S]. \quad (2.20)$$

F_j ($j = 0, \dots, d_S^2 - 1$) are operators acting on the central system that additionally form an orthonormal basis under Hilbert-Schmidt inner product, such that $F_0 = \mathbb{1}/\sqrt{d_S}$ and $\text{tr} F_j = 0 \ \forall j > 0$ (this will be revised in subsection 3.3.1); the matrix G is called dissipator matrix. In the second inequality we have used the singular value decomposition of matrix G , thus operators A_i are linear combinations of F_i . The scalars $\gamma_j > 0$ are called *relaxation rates* and the operator \tilde{H}_S is the shifted free Hamiltonian of the central system. The first term on both equations, the commutator, is called *Hamiltonian part*, while the second, the superoperator defined with the summations, is called *dissipator*. Note that if $\gamma_j = 0 \ \forall j$ (uncoupled limit), one recovers the Hamiltonian dynamics over the system S. The operator L is called *Lindblad generator* or *Lindbladian* and eq. (2.20) is called *Lindblad master equation*. We will use along the work the notation L for Lindblad operators.

Note that L is independent of time, hence the formal solution of the master equation eq. (2.20) equation is simply the exponentiation of L [see eq. (2.13)], i.e.

$$\rho_S(t) = e^{Lt} \rho_S(0). \quad (2.21)$$

Therefore the dynamics is homogeneous in time and, together with the fact that $\mathcal{E}_t = \exp(Lt)$, we have $\mathcal{E}_{t+s} = \mathcal{E}_t \mathcal{E}_s$, i.e. the quantum process \mathcal{E}_t resulting from a Lindblad master equation forms a one-parameter semigroup. In fact, Lindblad has proven the converse for norm continuous semigroups [Lin76]. Here we write the theorem for the finite dimensional case that is trivially norm continuous,

Theorem 1 (One-parameter quantum semigroups). *Let \mathcal{E}_t with $\mathcal{E}_0 = id$ and $t \geq 0$ a finite dimensional quantum process, it is a one-parameter quantum semigroup if and only if it has a generator with the form presented in eq. (2.20).*

A proof is given in Ref. [AL07]. It is worth to point out that starting from global dynamics governed by a finite dimensional Hamiltonian, the reduced dynamics are never of Lindblad form. This can be stated as the following,

Theorem 2 (Exact dynamics with Lindblad master equation). *Let $\mathcal{E}_t = e^{tL}$ a quantum process generated by a Lindblad operator L . The equation*

$$\mathcal{E}_t[\rho] = \text{tr}_E \left[e^{-iHt} (\rho \otimes \rho_E) e^{iHt} \right],$$

where H has finite dimension, holds if and only if \mathcal{E}_t is an unitary conjugation for every t .

A proof made jointly with Sergey Filippov is given in the appendix A. It was made using an specific matrix representation for operators that will be introduced in the next chapter. But a more general proof can be found in [Exn85].

Let us point out that this is not the case for Hamiltonians with continuum spectrum, they can lead to Lindblad master equations for the reduced dynamics. This is shown below together other illustrative examples.

Examples. To illustrate Lindblad dynamics we present several examples. The first one, depolarizing dynamics, is constructed via a continuous and monotonic contraction of the Bloch sphere. The second one corresponds to a system for which the exact reduced dynamics have Lindblad generator.

Example 1 (Dephasing dynamics). *Let $\rho(0) = \begin{pmatrix} \rho_{00} & \rho_{01} \\ \rho_{01}^* & \rho_{11} \end{pmatrix}$ be the initial state, written in a basis called decoherence basis, of a system that undergoes depolarizing dynamics. This is, only coherence terms (in this basis) are modified in the following way:*

$$\mathcal{E}_t : \rho(0) \mapsto \begin{pmatrix} \rho_{00} & \rho_{01} e^{-\gamma t} \\ \rho_{01}^* e^{-\gamma t} & \rho_{11} \end{pmatrix} =: \rho(t),$$

with $\gamma > 0$. It is trivial to check that \mathcal{E}_t is a one-parameter semigroup with $\mathcal{E}_0 = \text{id}$. For $t \rightarrow \infty$, we get $\rho(t) \rightarrow \text{diag}(\rho_{00}, \rho_{11})$. For this process it is easy to prove, by taking $0 < t \ll 1$, that its generator is $L[\rho] = \gamma/2 (\sigma_z \rho \sigma_z - \rho)$, which has Lindblad form. It has null Hamiltonian part and only one operator $A_0 = \sigma_z$ and one relaxation ration, $\gamma/2$.

Example 2 (Dynamics from global Hamiltonian with continuous spectrum). *Consider a bipartite system composed by a qubit interacting with a particle in a line, with global Hamiltonian $H = \sigma_z \otimes \hat{x}$, where \hat{x} is position operator. Notice that H is unbounded since the configuration space of the particle is the entire real line. Initializing the environment in the state $|\psi\rangle$ with*

$$\langle x | \psi \rangle = \sqrt{\frac{\gamma}{\pi}} \frac{1}{x + i\gamma},$$

it can be shown that the exact reduced dynamics for the qubit, without any approximation, is $L[\rho] = \gamma/2 (\sigma_z \rho \sigma_z - \rho)$ [AHFB15]. The same generator as in the first example.

2.2 Quantum channels

In this section we give a brief introduction to classical stochastic processes, this motivates the definition of quantum channel. We first give an overview of stochastic processes; based on this we review the construction steps of quantum channels and discuss several of their properties. Additionally we introduce the simplest example of local operations and classical communication. Later on one we discuss the definition of CP-divisible processes based on the definition of classical Markovianity. Finally we give a brief revision of Gaussian quantum states and channels.

2.2.1 A classical analog

The classical analog of quantum channels are the widely known *stochastic matrices* or *stochastic maps* which propagate classical probability distributions. To introduce them consider, for sake of simplicity, a finite dimensional stochastic system whose state x_t (at time t) is described by the probability distribution (or probability vector) $\vec{p}(t)$, i.e. $x_t \sim \vec{p}(t)$ [with $\sum_i p_i(t) = 1$ and $p_i(t) \geq 0$]. Note that probability vectors form a convex space in the very same way that density matrices do. The distribution $\vec{p}(t)$ is the classical analogous object to density matrices. They serve as the tool to model the accessible information of the observer about the state of the classical stochastic system.

Consider now the most general linear transformation on probability vectors that takes, for instance $\vec{p}(0)$ to $\vec{p}(t)$ and let us write it explicitly as a matrix multiplication, $\vec{p}(t) = \Lambda_{(t,0)} \vec{p}(0)$. We have to impose further constrictions over $\Lambda_{(t,0)}$ in order to preserve the normalization of $\vec{p}(t)$ and the non-negativity of its elements. Since $p_i(t) = \sum_j (\Lambda_{(t,0)})_{ij} \vec{p}_j(0)$, simple algebra leads us to note that $\sum_i (\Lambda_{(t,0)})_{ij} = 1 \quad \forall j$ and $(\Lambda_{(t,0)})_{ij} \geq 0$. Matrices that fulfill these conditions are widely known as *stochastic matrices*, and form a convex set following the convexity of the space of probability distributions.

A remarkable property of stochastic maps is that they are contractive with respect to the Kolmogorov distance.

Theorem 3 (Contractivity of stochastic maps). *The matrix Λ is a stochastic matrix if and only if*

$$\mathcal{D}_K(\Lambda\vec{p}, \Lambda\vec{q}) \leq \mathcal{D}_K(\vec{p}, \vec{q}), \quad (2.22)$$

where $\mathcal{D}_K(\vec{p}, \vec{q}) = \sum_k |p_k - q_k|$ is the Kolmogorov distance.

It is worth to note Kolmogorov distance is a measure of distinguishability between classical distributions. A detailed proof of this theorem can be found in Ref. [ARHP14].

A particular and interesting class of stochastic matrices are *bistochastic matrices*. They are defined as the transformations that leave invariant the probability distribution with maximum entropy, given by $\vec{m} = (1/N, \dots, 1/N)^T$, where N is the number that the system can have. Therefore a bistochastic matrix fulfills $\vec{m} = \Lambda_{(t,0)}\vec{m}$. Doing simple algebra leads us to note that bistochastic matrices additionally fulfill $\sum_j (\Lambda_{(t,0)})_{ij} = 1 \quad \forall i$. This implies that they are also stochastic matrices *acting from the right*, i.e. mapping row probability vectors. This is also the origin of the name bistochastic.

In the previous section we have introduced the concept of Markovianity in the context of open quantum systems, the so called Markovian approximation. It consisted on assuming that the system 'forgets the information about its previous states'. This concept comes from the theory of classical stochastic processes. Let us introduce the following definition [BP07, ARHP14],

Definition 1 (Classical Markovian process). *Let x_t be the state of a stochastic system where $t \in [0, \tau]$, and $\chi = \{t_0, \dots, t_n\}$ any ordered set of times such that $0 < t_0 < t_1 < \dots < t_n < \tau$, the process is Markovian if*

$$P(x_{t_n}, t_n | x_{t_{n-1}}, t_{n-1}; \dots; x_{t_0}, t_0) = P(x_{t_n}, t_n | x_{t_{n-1}}, t_{n-1}) \quad \forall n > 0, \quad (2.23)$$

where $P(\cdot|\cdot)$ denotes conditional probability.

According to this definition, the conditional probability of the system to be at the state x_{t_n} at the time t_n , given the history of events $\{x_{t_{n-1}}, t_{n-1}; \dots; x_{t_0}, t_0\}$, depends only on the previous state. This definition captures the memoryless character of Markovian processes.

Consider now a stochastic process and $\{\Lambda_{(t,0)}\}_{t \in \chi}$ a set of stochastic matrices given some ordered set of times χ . If the process is Markovian then the matrices $\Lambda_{(t_m, t_n)}$ are stochastic matrices for any χ , where $t_m > t_n \in \chi$. The converse is not true [ARHP14, BP07]. This condition implies that the map $\Lambda_{(t,0)}$ is divisible in

the sense that it can always be written as

$$\Lambda_{(t_1, t_0)} = \Lambda_{(t_1, s)} \Lambda_{(s, t_0)} \quad \forall t_1 > s > t_0, \quad (2.24)$$

with $\Lambda_{(t_1, s)}$, $\Lambda_{(s, t_0)}$ and $\Lambda_{(t_1, t_0)}$ stochastic matrices, the latter two by definition. Intermediate maps can be constructed as $\Lambda_{(t_1, s)} = \Lambda_{(t_1, t_0)} \Lambda_{(s, t_0)}^{-1}$ if $\Lambda_{(s, t_0)}^{-1}$ exists. Note that theorem 3 implies that Markovian stochastic processes do not increase the Kolmogorov distance.

2.2.2 Construction of quantum channels

The concept of quantum channel, also known as quantum operation, captures the idea of stochastic map in the quantum setting. Thus, being the density matrices the analogous objects to probability vectors, we seek for linear operations that transform density matrices into density matrices. The operations that do such job are defined as follows:

Definition 2 (Positive and trace preserving linear operations (PTP)). *A linear operation $\mathcal{E} : \mathcal{T}(\mathcal{H}) \rightarrow \mathcal{T}(\mathcal{H})$ is positive and trace preserving if, for all $\Delta \in \mathcal{H}$, we have the following*

- $\mathcal{E}[\Delta] \geq 0 \quad \forall \Delta \geq 0$,
- $\text{tr}(\mathcal{E}[\Delta]) = \text{tr}(\Delta)$.

A remarkable property of linear positive maps is that they are contractive respect to the trace norm [ARHP14]. This leads to a decrease of the distinguishability of quantum states, similar to the classical case.

Theorem 4 (Contractivity of positive maps). *A linear map \mathcal{E} is PTP if and only if $|\mathcal{E}[\Delta]|_{\text{tr}} \leq |\Delta|_{\text{tr}} \quad \forall \Delta^\dagger = \Delta \in \mathcal{B}(\mathcal{H})$.*

A simple proof for the finite dimensional case can be found in Ref. [ARHP14].

Now, given that any hermitian operator can be written as

$$\begin{aligned} \Delta &= (\text{tr} \Delta) H_p, \text{ for } \text{tr} \Delta \neq 0, \\ \Delta &= \text{tr} \Delta^+ (\rho_1 - \rho_2), \text{ for } \text{tr} \Delta = 0, \end{aligned}$$

where $H_p = p\rho_1 - (1-p)\rho_2$ a Helstrom matrix and $p \in [0, 1]$, by theorem 4 the generalized trace distance defined as $\mathcal{D}_p(\rho_1, \rho_2) = |p\rho_1 - (1-p)\rho_2|_{\text{tr}}$ decreases after the application of a positive map \mathcal{E} , i.e.

$$\mathcal{D}_p(\mathcal{E}[\rho_1], \mathcal{E}[\rho_2]) \leq \mathcal{D}_p(\rho_1, \rho_2).$$

It is worth to point out that this is directly related to the two-state discrimination problem where we have, for instance, probability p of erroneously identify ρ_1 with ρ_2 [NC11, ARHP14]. In this setting the probability of failing with such identification is

$$P_{\text{err}} = \frac{1 - \mathcal{D}_p(\rho_1, \rho_2)}{2}.$$

Therefore if the distance is zero, the probability of correctly identify ρ_1 is the same as choosing randomly between ρ_1 and ρ_2 , but if it is 1, we identify ρ_1 from ρ_2 with certainty. For $p = 1/2$ we recover the standard unbiased trace distance.

It is well known that any quantum system can be entangled with another, for instance a central system can be entangled with its environment. Thus, in the context of quantum operations we must handle this fact carefully. Let us define the following:

Definition 3 (*k*-positive operations). *A linear map \mathcal{E} is k-positive if*

$$id_k \otimes \mathcal{E}[\tilde{\Delta}] \geq 0 \quad \forall \tilde{\Delta} \geq 0 \in \mathcal{B}(\mathcal{H}_k \otimes \mathcal{H}),$$

with k a positive integer, being the dimension of \mathcal{H}_k and id_k the identity map in that space.

Therefore a positive map is *k*-positive if the expended map $id_k \otimes \mathcal{E}$ is positive, the trace preserving of *k*-positive maps follows immediately from the trace preserving of \mathcal{E} . Such maps transform properly density matrices of the extended system (with ancilla of dimension k) into density matrices, apart from the fact that they transform properly the density matrices of the system, hence handling quantum entanglement correctly for this ancilla.

Since the dimension of any other quantum system is arbitrary, being for example the rest of the universe, one must have that quantum maps must transform quantum states for every positive integer k . Therefore one defines *complete positive* and trace preserving linear maps as the following,

Definition 4 (Complete positive and trace preserving operations (CPTP)). *A trace preserving linear operation $\mathcal{E} : \mathcal{T}(\mathcal{H}) \rightarrow \mathcal{T}(\mathcal{H})$ is complete positive if*

$$id_k \otimes \mathcal{E}[\tilde{\Delta}] \geq 0 \quad \forall \tilde{\Delta} \geq 0 \in \mathcal{B}(\mathcal{H}_k \otimes \mathcal{H}), \forall k \in \mathbb{Z}_0^+,$$

where \mathbb{Z}^+ is the set of the positive integers.

It will be shown later in chapter 3, that deciding complete positivity is straightforward using the so called Choi matrix.

It is trivial to check that unitary operations, $\mathcal{U}[\rho] = U\rho U^\dagger$, are CPTP maps as expected. Additionally they leave invariant the maximally mixed state, $\mathbb{1}/\dim(\mathcal{H})$. In fact, unitary operations belong to a wider class of CPTP maps called *unital quantum maps*, similar to its classical counterpart. The set of unital channels is defined simply as the one containing CPTP maps \mathcal{E} that additionally fulfill $\mathcal{E}[\mathbb{1}] = \mathbb{1}$.

Additionally notice that due to the trace preserving property the adjoint operator of \mathcal{E} is always unital. The adjoint is defined in the usual way,

$$\langle A, \mathcal{E}[B] \rangle = \langle \mathcal{E}^*[A], B \rangle, \quad (2.25)$$

where the inner product is the Hilbert-Schmidt product and $A \in \mathcal{T}(\mathcal{H})$ and $B \in \mathcal{B}(\mathcal{H})$ [Hol01, HZ12]. Now, $\forall \Delta \in \mathcal{T}(\mathcal{H})$ we write the trace preserving condition as $\text{tr} \Delta = \text{tr} \mathcal{E}[\Delta] = \langle \mathbb{1}, \mathcal{E}[\Delta] \rangle = \langle \mathcal{E}^*[\mathbb{1}], \Delta \rangle$, therefore $\mathcal{E}^*[\mathbb{1}] = \mathbb{1}$.

Let us now illustrate the connection of the concept of quantum channel with the scheme of open quantum systems introduced above. Consider the following theorem [Sti06]:

Theorem 5 (Stinespring dilation theorem). *Let \mathcal{E} a CPTP map, there exist an environmental Hilbert space \mathcal{H}_E and $\rho_E \in \mathcal{S}(\mathcal{H}_E)$ such that*

$$\mathcal{E}[\rho] = \text{tr}_E [U(\rho \otimes \rho_E)U^\dagger],$$

with the unitary matrix $U : \mathcal{H} \otimes \mathcal{H}_E \rightarrow \mathcal{H} \otimes \mathcal{H}_E$.

The unitary U and the state ρ_E are not unique [HZ12]. Stinespring theorem is an important result given that one can always understand a CPTP operation as a Hamiltonian evolution in a bigger space, such that we recover the given operation at some fixed time and by performing a partial trace over the environmental degrees of freedom. Later in this chapter we will discuss an important implication of this theorem for Markovian processes.

Along the work we will also denote the set of CPTP linear maps simply as \mathcal{C} .

A remarkable property of \mathcal{C} is its convexity. To show this consider the following convex combination of CPTP maps: $\mathcal{E} = p\mathcal{E}_1 + (1-p)\mathcal{E}_2$, acting upon the density matrix ρ_0 . By linearity we have $\mathcal{E}[\rho_0] = p\mathcal{E}_1[\rho_0] + (1-p)\mathcal{E}_2[\rho_0]$. Defining the density matrices $\rho_i = \mathcal{E}_i[\rho_0] \in \mathcal{S}(\mathcal{H})$, it follows from the convexity of $\mathcal{S}(\mathcal{H})$ that \mathcal{E} is another CPTP map. Therefore the set \mathcal{C} is convex.

Unitary maps are extremal channels of \mathcal{C} i.e. they cannot be written as convex combinations of other channels, but they can be used to construct other maps,

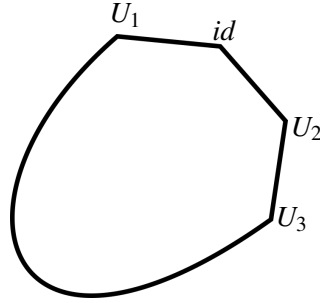

Figure 2.3: The figure shows a schematic slice of CPTP maps, one can see the identity map and other extremal channels. The straight lines are convex combinations of those channels, the curve contains channels in the boundary that cannot be written as convex combinations of unitary channels.

see fig.2.3. For instance consider a simple convex combination of unitary maps $\mathcal{E}[\rho] = \sum_i p_i U \rho U^\dagger$, with $\sum_i p_i = 1$ and $p_i \geq 0$. This channel is a more general example of a unital channel, in fact it turns out that every unital qubit channel has such form. This can be shown easily using the Ruskai's decomposition that will be introduced in the next chapter. Convex combinations of unitary channels can be implemented in the laboratory, for instance choosing unitaries randomly by tossing a die.

Regarding the algebraic properties of the set \mathcal{C} , it enjoys the structure of a semi-group. It is closed under the composition operation, i.e. $\mathcal{E}_1 \mathcal{E}_2 \in \mathcal{C}$, $\forall \mathcal{E}_1, \mathcal{E}_2 \in \mathcal{C}$, and is associative, $(\mathcal{E}_1 \mathcal{E}_2) \mathcal{E}_3 = \mathcal{E}_1 (\mathcal{E}_2 \mathcal{E}_3)$. Additionally it contains an identity element. \mathcal{C} does not contain the inverse elements, this captures the irreversible character of general quantum operations, being only the unitaries the ones their inverse elements in \mathcal{C} . Furthermore, \mathcal{C} contains another remarkable convex structure,

Definition 5 (Entanglement-breaking channels). *A map $\mathcal{E} \in \mathcal{C}$ is entanglement-breaking if it breaks the entanglement of the system with any ancilla, i.e. $\forall k \in \mathbb{Z}^+$ and $\forall \sigma \in \mathcal{S}(\mathcal{H}_k \otimes \mathcal{H})$, the state $(id_k \otimes \mathcal{E})[\sigma]$ is separable.*

This set is convex given that convex combinations of separable states is separable [HHHH09].

Quantum channels can be seen as the basic building of time-dependent quantum processes, also called quantum dynamical maps.

Definition 6 (Quantum dynamical maps). *A continuous family of channels $\{\mathcal{E}_t \in \mathcal{C} : t \geq 0, \mathcal{E}_0 = id\}$ is called quantum dynamical map.*

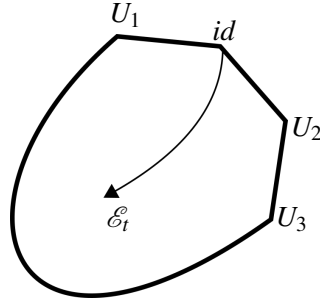

Figure 2.4: Scheme of a smooth dynamical map inside a slice of the set C .

Given some interval \mathcal{I} , if the family is smooth respect to $t \in \mathcal{I}$ and invertible, it admits a master equation

$$\dot{\rho}(t) = A_t[\rho(t)] \quad \text{with } A_t = \dot{\mathcal{E}}_t \mathcal{E}_t^{-1}.$$

An schematic description is shown in fig. 2.4. Note that the standard scheme open quantum systems, introduced at the beginning of this chapter, leads to quantum dynamical maps.

2.2.3 Non-Linear CPTP operations

Notice that the set C does not contain everything that can be performed on a quantum system; it contains only linear operations. Therefore C does not contain *post-selection* procedures, i.e. updating the state once a measurement is done and the result is known. For instance, let ρ the state of some system and $\{M_i\}$ a collection of *measurement operators* over it, where the index i refers to the measurement outcome. The probability of measuring i is $p(i) = \text{tr}(M_i \rho M_i^\dagger)$, while the operation performed over the state is

$$\rho \mapsto \frac{M_i \rho M_i^\dagger}{\text{tr}(M_i \rho M_i^\dagger)}.$$

This operation is explicitly non-linear but it is trivially complete positive and trace preserving. Note that if the action of the measurement apparatus is performed but the experimentalist does not read the outcome, or it is simply forgotten, the resulting map belongs to C [NC11]. This is shown by noting that the operation $M_i \rho M_i^\dagger$ is applied with probability $p(i)$, then the performed operation is $\sum_i p(i) M_i \rho M_i^\dagger$ and it is linear and CPTP by construction. Complete positivity follows immediately

from the complete positivity of $\rho \mapsto M_i \rho M_i^\dagger$ and the trace preserving property from the weighted summation.

A more general set of operations including measurements, postselection and exchange of classical information will be introduced in the next subsection.

2.2.4 Local operations and classical communication

Several types of quantum operations can be found and studied, in particular in Ref. [HZ12] there is a classification mainly based on its *locality*. A paradigmatic and widely studied type are the so called *local operations and classical communication* [HHHH09]. A surprising feature of these operations is that they can increase the entanglement of entangled states of a system (at the cost of throwing away some members of the ensemble), but cannot create them from non-entangled ones [VDD01, HHHH09].

In this work we are particularly interested in *one-way stochastic local operations and classical communication* channels (1wSLOCC). Consider a bipartite system where one part is controlled by Alice and the other by Bob. Alice performs an operation which includes measurements with postselection, and then she communicates its outcome to Bob. Then Bob performs a local operation that can be again a measurement with postselection, finishing the protocol. The stochasticity comes from the fact that this operation, for each particular set of measurement outcomes, has a certain probability generally less than 1 of occurrence. And the one-way comes from the fact that no feedback is given to Alice and no more operations and classical communications are performed. These operations can be written in the following way:

$$\rho \mapsto \rho' = \frac{(X \otimes Y) \rho (X \otimes Y)^\dagger}{\text{tr} \left[(X \otimes Y) \rho (X \otimes Y)^\dagger \right]}. \quad (2.26)$$

Additionally we will consider $\det X \neq 0$ and $\det Y \neq 0$, this is the usual choice as projective measurements destroy entanglement [VDD01]. These operations are completely positive and trace preserving, but non-linear unless X and Y are unitaries. Additional notice that given ρ and ρ' , the matrices X and Y can always be chosen such that $\det X = \det Y = 1$ (for the invertible case). Therefore for two-level systems it is enough to consider $X, Y \in \text{SL}(2, \mathbb{C})$ [Tun85], where the latter is the *special linear group* of 2×2 matrices with complex entries. Furthermore notice that the operation

$$\rho \mapsto (X \otimes Y) \rho (X \otimes Y)^\dagger \quad (2.27)$$

preserves the determinant, i.e. $\det \rho = \det \rho'$. In the next chapter we will exploit this to show that there is a correspondence between 1wSLOCC and Lorentz transformations. We use this to introduce a decomposition analogous to the singular value decomposition, but using the Lorentz metric instead of the Euclidean, enjoying an useful physical meaning.

2.3 Quantum channels of continuous variable systems

Many of the definitions and tools introduced in the previous sections are also relevant for the infinite dimensional case. Although we can always choose countable basis for the Hilbert space as long it is separable [HZ12], it is often of interest to consider non-countable bases, typically phase-space variables. This introduces the theory of continuous variable systems. It is a central topic of study given that they appear naturally in the description of many physical systems. A few examples are the electromagnetic field [CLP07], solids and nano-mechanical systems [AKM14] and atomic ensembles [HSP10]. In particular, in this section we introduce and discuss a set of continuous variable channels called *Gaussian quantum channels*.

2.3.1 Gaussian quantum states

To introduce the definition of Gaussian quantum channel, consider first the simplest state type of quantum states in continuous variable, both from a theoretical and experimental point of view, the so-called *Gaussian states*. The operations that transform such family of states into itself are called Gaussian quantum channels (GQC). Even though Gaussian states and channels are small subsets of all possible states/channels, they have proven to be useful in a very wide variate of tasks such as quantum communication [GVAW⁺03], quantum computation [LB99] and the study of quantum entanglement in simple [BvL05] and complicated scenarios [LRW⁺18].

Gaussian states are defined as those having Gaussian Wigner function. In particular, for one-mode the Wigner function is

$$W(\vec{u}) = \frac{1}{2\pi\sqrt{\det \sigma}} e^{-\frac{1}{2}(\vec{u}-\vec{d})^T \sigma^{-1}(\vec{u}-\vec{d})}, \quad (2.28)$$

where $\vec{u} = (q, p)^T$ [EW07]. The *mean vector* \vec{d} and the *covariance matrix* σ are

the first and second moments, respectively. They are given by

$$\sigma = \begin{pmatrix} \langle \hat{q}^2 \rangle - \langle \hat{q} \rangle^2 & \frac{1}{2} \langle \hat{q} \hat{p} + \hat{p} \hat{q} \rangle - \langle \hat{q} \rangle \langle \hat{p} \rangle \\ \frac{1}{2} \langle \hat{q} \hat{p} + \hat{p} \hat{q} \rangle - \langle \hat{q} \rangle \langle \hat{p} \rangle & \langle \hat{p}^2 \rangle - \langle \hat{p} \rangle^2 \end{pmatrix},$$

$$\vec{d} = (\langle \hat{q} \rangle, \langle \hat{p} \rangle)^T.$$

The observables \hat{q} and \hat{p} are the standard canonical conjugate position and momentum variables. As for any other Gaussian variable, Gaussian quantum states are characterized completely by first and second probabilistic moments. Therefore a Gaussian state S can be denoted as $S = S(\sigma, \vec{d})$.

2.3.2 Gaussian quantum channels

To start with, we recall the following definition [WPGP⁺12]:

Definition 7 (Gaussian quantum channels). *A quantum channel is Gaussian (GQC) if it transforms Gaussian states into Gaussian states.*

This definition is strictly equivalent to the statement that any GQC, say \mathcal{A} , can be written as

$$\mathcal{A}[\rho] = \text{tr}_E [U (\rho \otimes \rho_E) U^\dagger] \quad (2.29)$$

where U is a unitary transformation, acting on a combined global state obtained from enlarging the system with an environment E , that is generated by a quadratic bosonic Hamiltonian (i.e. U is a *Gaussian unitary*) [WPGP⁺12]. The environmental initial state ρ_E is a Gaussian state and the trace is taken over the environmental degrees of freedom.

Following definition 7, a GQC is fully characterized by its action over Gaussian states, and this action is in turn defined by *affine transformations* [WPGP⁺12]. Specifically, $\mathcal{A} = \mathcal{A}(\mathbf{T}, \mathbf{N}, \vec{\tau})$ is given by a tuple $(\mathbf{T}, \mathbf{N}, \vec{\tau})$ where \mathbf{T} and \mathbf{N} are 2×2 real matrices with $\mathbf{N} = \mathbf{N}^T$ [WPGP⁺12] acting on Gaussian states according to

$$\mathcal{A}(\mathbf{T}, \mathbf{N}, \vec{\tau}) [S(\sigma, \vec{d})] = S(\mathbf{T}\sigma\mathbf{T}^T + \mathbf{N}, \mathbf{T}\vec{d} + \vec{\tau}).$$

In the particular case of closed systems we have $\mathbf{N} = \mathbf{0}$ and \mathbf{T} is a symplectic matrix. The particular form and properties of Gaussian quantum channels in the continuous variable representations, as well as their connection with the mentioned affine transformations, will be given in chapter 3.

In this work we explore GQCs without Gaussian functional form in the position state representation. In particular we study channels that can arise when singularities on the coefficients of Gaussian forms GF occur (they will be denoted by δ GQC). Such channels can lead immediately to singular Gaussian operations. Thus, we characterize which forms in δ GQC lead to valid quantum channels, and under which conditions singular operations lead to valid *singular Gaussian quantum channels* (SGQC).

Let us note that although channels with Gaussian form trivially transform Gaussian states into Gaussian states, the definition goes beyond GF. We will use the typical *difference* and *sum* coordinates, $x = q_2 - q_1$ and $r = (q_1 + q_2)/2$, respectively. Defining $\rho(x, r) = \langle r - \frac{x}{2} | \hat{\rho} | r + \frac{x}{2} \rangle$, a quantum channel in this representation is defined such that

$$\rho_f(x_f, r_f) = \int_{\mathbb{R}^2} dx_i dr_i J(x_f, x_i; r_f, r_i) \rho_i(x_i, r_i), \quad (2.30)$$

where $\hat{\rho}_i$ and $\hat{\rho}_f$ are the initial and final states, respectively, and $J(x_f, x_i; r_f, r_i)$ is the representation of the quantum channel in the aforementioned variables. An example of a channel without GF can be constructed from the general form of Gaussian quantum channel with GF [MP12]:

$$J_G(x_f, x_i; r_f, r_i) = \frac{b_3}{2\pi} \exp \left[i \left(b_1 x_f r_f + b_2 x_f r_i + b_3 x_i r_f + b_4 x_i r_i + c_1 x_f + c_2 x_i \right) - a_1 x_f^2 - a_2 x_f x_i - a_3 x_i^2 \right], \quad (2.31)$$

where all coefficients are real and no quadratic terms in $r_{i,f}$ are allowed. Choosing

$$a_n = \alpha_n \varepsilon^{-1} + \tilde{a}_n$$

and

$$b_n = \beta_n \varepsilon^{-1/2} + \tilde{b}_n,$$

with $\varepsilon > 0$, $\alpha_n, \beta_n, \tilde{a}_n, \tilde{b}_n \in \mathbb{R} \quad \forall n$ and $\tilde{b}_3 = 0$. Taking the limit $\varepsilon \rightarrow 0$ and using the formula

$$\delta(x) = \lim_{\varepsilon \rightarrow 0} \frac{1}{2\sqrt{\pi\varepsilon}} e^{-\frac{x^2}{4\varepsilon}}, \quad (2.32)$$

we arrive to

$$\lim_{\varepsilon \rightarrow 0} J_G(x_f, x_i; r_f, r_i) = \mathcal{N} \delta(\alpha x_f - \beta x_i) e^{\Sigma'(x_f, x_i; r_f, r_i)}, \quad (2.33)$$

where $\alpha, \beta \in \mathbb{R}$ and $\Sigma'(x_f, x_i; r_f, r_i)$ is a quadratic form that now admits quadratic terms in $r_{i,f}$, arising from the completion of the square of the exponent of eq. (2.31)

to take the limit of eq. (2.32). This is the first example of a δ GQC. This channel is still a GQC according to the definition. A physical, but complicated realization occurs in the system of one Brownian quantum particle with harmonic potential and linearly coupled to the bath. In such system, channels with the functional form of eq. (2.33) are realized at isolated points in time, see equations 6.71-75 of Ref. [GSI88].

Since the form of eq. (2.33) admits quadratic terms in $r_{i,f}$ in the exponent, it suggests that a form with two deltas exist and can be defined using the same limit, see eq. (2.32). In fact, the identity map is a particular case; it is realized setting $J(x_f, x_i; r_f, r_i) = \delta(x_f - x_i)\delta(r_f - r_i)$. In any case, to avoid working with such limits, it is convenient to perform a *black-box* characterization of general forms involving Dirac's deltas, which will be done in the next chapter. This will lead to explicit relations between position state representation and affine representations of Gaussian quantum channels without Gaussian functional form.

Chapter 3

Representations of quantum channels

Simplicity is the ultimate sophistication.
Leonardo da Vinci

In this chapter we introduce several and useful representations of quantum channels for the finite dimensional case. We start with the Kraus representation, already mentioned in the previous chapter, but additionally we will show that quantum channels always have this form. Later on we introduce Choi's theorem (and the so called Choi-Jamiołkowski representation) which is cornerstone tool to study many properties of quantum channels. We also discuss operational representations by introducing two types of basis. These representations are useful to prove several results in this work. Next, we apply the introduced tools to the qubit case. Additionally we discuss two decomposition of qubit channels, leading to two *normal forms* that are essential to study divisibility properties of quantum channels.

3.1 Kraus representation

In the previous chapter we have shown that starting from the usual scheme of open quantum systems, we arrive to the *Kraus representation*, see eq. (2.8). Later on, using the Stinespring dilation theorem, see Theorem 5, we showed that CPTP maps can always fit in the scheme of open quantum systems for some global

unitary evolution. Since the latter scheme always has a Kraus representation, one concludes that CPTP maps always have a Kraus representation. It turns out that the converse also holds [KBDW83].

Theorem 6 (Kraus). *A linear operation $\mathcal{E} : \mathcal{T}(\mathcal{H}) \rightarrow \mathcal{T}(\mathcal{H})$ belongs to \mathcal{C} if and only if there exist a set of bounded operators $\{K_i\}$ such that*

$$\mathcal{E}[\Delta] = \sum_i K_i \Delta K_i^\dagger \quad \forall \Delta \in \mathcal{T}(\mathcal{H}),$$

with $\sum_i K_i^\dagger K_i = \mathbb{1}$.

Proof. The 'only if' part is already commented in the main text and follows the logic: every $\mathcal{E} \in \mathcal{C}$ has a dilation such that it has the familiar form of the open quantum systems dynamics, i.e. there exists U and ρ_E such that $\mathcal{E}[\rho] = \text{tr}_E [U(\rho \otimes \rho_E)U^\dagger]$. We already showed that writing ρ_E in terms of its eigenbasis, the latter expression leads to the Kraus representation, see eq. (2.8). To prove the 'if' part, we only have to construct the extended map to test its complete positivity. Let $k > 0 \in \mathbb{Z}$ and $\tau_k = (\text{id}_k \otimes \mathcal{E})[\tilde{\Delta}_k]$, where $\tilde{\Delta}_k \in \mathcal{B}(\mathcal{H}_k \otimes \mathcal{H})$ and $\tilde{\Delta}_k \geq 0$, using Kraus decomposition and evaluating $\langle \phi | \tau_k | \phi \rangle$ with $|\phi\rangle \in \mathcal{H}_k \otimes \mathcal{H}$, one arrives to

$$\begin{aligned} \langle \phi | \tau_k | \phi \rangle &= \sum_i \langle \phi | (\mathbb{1}_k \otimes K_i) \tilde{\Delta}_k (\mathbb{1} \otimes K_i^\dagger) | \phi \rangle \\ &= \sum_i \langle \phi_i | \tilde{\Delta}_k | \phi_i \rangle \\ &\geq 0. \end{aligned}$$

The latter follows immediately from the positive-semidefiniteness of $\tilde{\Delta}_k$, i.e. $\langle \phi_i | \tilde{\Delta}_k | \phi_i \rangle \geq 0$. The condition $\sum_i K_i^\dagger K_i = \mathbb{1}$ comes from the trace-preserving of \mathcal{E} and the cyclic property of the trace,

$$\begin{aligned} \text{tr} \mathcal{E}[\Delta] &= \sum_i \text{tr} [K_i \Delta K_i^\dagger] \\ &= \sum_i \text{tr} [K_i^\dagger K_i \Delta] \\ &= \text{tr} \left[\left(\sum_i K_i^\dagger K_i \right) \Delta \right] \\ &= \text{tr} \Delta, \end{aligned}$$

□

Therefore $\sum_i K_i^\dagger K_i = \mathbb{1}$. It is worth to note that Kraus operators are not unique. Defining a new set of operators, $A_k = \sum_l u_{kl} K_l$, it is easy to show that $\sum_i K_i \Delta K_i^\dagger = \sum_k A_k \Delta A_k^\dagger$ if and only if u_{kl} are the components of a unitary matrix. Therefore different Kraus representations are related by unitary conjugations.

3.2 Choi-Jamiołkowski representation

The Choi-Jamiołkowski representation arises as part of a very useful theorem in quantum information theory, the so called Choi's theorem [Cho75, HZ12].

Theorem 7 (Choi). *Let $\mathcal{E} : \mathbb{C}^{n \times n} \rightarrow \mathbb{C}^{m \times m}$ be a linear map. The following statements are equivalent:*

- i) \mathcal{E} is n -positive.
- ii) The matrix

$$C_{\mathcal{E}} = \sum_{i,j=1}^n |\varphi_i\rangle\langle\varphi_j| \otimes \mathcal{E}[|\varphi_i\rangle\langle\varphi_j|] \in \mathbb{C}^{n \times m} \otimes \mathbb{C}^{n \times m}$$

- is positive-semidefinite with $\{|\varphi_i\rangle\}_{i=1}^n$ an orthonormal basis in \mathbb{C}^n .
- iii) \mathcal{E} is completely positive.

Proof. The proof of *iii) \rightarrow i)* is trivial, if \mathcal{E} is completely positive then it is n -positive. The implication *i) \rightarrow ii)* can be proved easily by noticing that normalizing $C_{\mathcal{E}} \rightarrow C_{\mathcal{E}}/n =: \tau_{\mathcal{E}}$, where $\tau_{\mathcal{E}}$ can be obtained as the application $\tau_{\mathcal{E}} = (\text{id}_n \otimes \mathcal{E})[\omega]$, where $\omega = |\Omega\rangle\langle\Omega|$ with $|\Omega\rangle = 1/\sqrt{n} \sum_i |\varphi_i\rangle \otimes |\varphi_i\rangle$ a Bell state between two copies of \mathbb{C}^n . Therefore, by the n -positivity of \mathcal{E} it follows that $\tau_{\mathcal{E}}$ is positive-semidefinite.

What remains to prove is *ii) \rightarrow iii)*. To do this observe that the space $\mathbb{C}^{n \times m}$ is isomorphic to the direct sum of n copies of \mathbb{C}^m , i.e. $\mathbb{C}^{n \times m} \cong \mathbb{C}_1^m \oplus \mathbb{C}_2^m \oplus \dots \oplus \mathbb{C}_n^m$, and define the projector into the k th copy as $P_k = \langle\varphi_k| \otimes \mathbb{1}$, such that $P_k C_{\mathcal{E}} P_l = \mathcal{E}[|\varphi_k\rangle\langle\varphi_l|]$. Now, given that $C_{\mathcal{E}}$ is positive-semidefinite, it can be written as $C_{\mathcal{E}} = \sum_i^{nm} |\Psi_i\rangle\langle\Psi_i|$, where $|\Psi_i\rangle \in \mathbb{C}^{n \times m}$ are generally unnormalized vectors. Thus, we have that $\mathcal{E}[|\varphi_k\rangle\langle\varphi_l|] = \sum_i P_k |\Psi_i\rangle\langle\Psi_i| P_l$, where $P_k |\Psi_i\rangle \in \mathbb{C}_k^m$. Defining the operators $\{K_i : \mathbb{C}^n \rightarrow \mathbb{C}^m\}_i$ via the equation $P_k |\Psi_i\rangle = K_i |\varphi_k\rangle$, where choosing for example $|\varphi_k\rangle$ as the canonical basis, the columns of K_i contain the n projections of $|\Psi_i\rangle$ into the copies of \mathbb{C}^m . Finally we arrive to $\mathcal{E}[|\varphi_k\rangle\langle\varphi_l|] = \sum_i K_i |\varphi_k\rangle\langle\varphi_l| K_i^\dagger \forall k, l = 1, \dots, n$. In conclusion, since $\{|\varphi_k\rangle\langle\varphi_l|\}_{k,l}$ is a complete basis of $\mathbb{C}^{n \times n}$, by linearity and by theorem 6, the map \mathcal{E} is completely positive. \square

The matrix $C_{\mathcal{E}}$ is commonly known as Choi matrix and $\tau_{\mathcal{E}}$ as Choi-Jamiołkowski state. Both define the Choi-Jamiołkowski representation, in this work labeled as $\tau_{\mathcal{E}}$ since it is normalized.

Choi's theorem provides a simple test of complete positivity, which I find beautiful. For instance, if we want to know if a given PTP map \mathcal{E} is a valid quantum map, we just have to consider two copies of our system in only one state, the Bell state, then apply \mathcal{E} to one of the copies and check if the result, $\tau_{\mathcal{E}} = (\text{id}_n \otimes \mathcal{E})[\omega]$, is a density matrix.

The Choi-Jamiołkowski representation enjoys other useful properties, if \mathcal{E} preserves the trace, the matrix

$$\tau_{\mathcal{E}} = \frac{1}{n} \begin{pmatrix} \mathcal{E}[|\varphi_1\rangle\langle\varphi_1|] & \dots & \mathcal{E}[|\varphi_1\rangle\langle\varphi_n|] \\ \vdots & \ddots & \vdots \\ \mathcal{E}[|\varphi_n\rangle\langle\varphi_1|] & \dots & \mathcal{E}[|\varphi_n\rangle\langle\varphi_n|] \end{pmatrix} \quad (3.1)$$

has blocks of trace $1/n$ and 0, since $\text{tr} \mathcal{E}[|\varphi_i\rangle\langle\varphi_j|] = \delta_{ij}$. This property additionally means that not every density matrix in $\mathbb{C}^{n \times m} \otimes \mathbb{C}^{n \times m}$ has a corresponding CPTP map.

The matrix rank of $\tau_{\mathcal{E}}$ coincides with the so called *Kraus rank*, i.e. the number of linearly independent Kraus operators required to write the channel. This can be shown easily noticing that computing $\tau_{\mathcal{E}}$ from the Kraus sum, one arrives to the equality $|\Psi_i\rangle = 1/\sqrt{n} \mathbb{1} \otimes K_i |\Omega\rangle$, therefore the linear independence of $\{|\Psi_i\rangle\}_i$ follows immediately from the linear independence of $\{K_i\}_i$. Therefore the maximum Kraus rank is mn and the minimum 1. Channels with Kraus rank equal to 1 are trivially unitary channels given that $\mathcal{E}[\Delta] = K\Delta K^\dagger$ with $K^\dagger K = \mathbb{1}$. Channels with the maximum rank are called *full Kraus rank channels*.

Another interesting property is that if $\tau_{\mathcal{E}}$ is separable (i.e. not entangled), then \mathcal{E} is entanglement-breaking, see definition 5. For qubit channels it is enough to test that the concurrence is zero [RFZB12].

3.3 Operational representations

It has been shown that the Choi-Jamiołkowski representation is useful to test several properties of quantum channels. In this section we will introduce other representations, this time with operational meanings. They are basically operator basis that give matrix and vector forms to channels and density matrices, respectively.

The vectorization of density matrices can be achieved simply “making them flat”, this is,

$$\begin{pmatrix} \rho_{11} & \cdots & \rho_{1d} \\ \vdots & \ddots & \vdots \\ \rho_{d1} & \cdots & \rho_{dd} \end{pmatrix} \mapsto \begin{pmatrix} \rho_{11} \\ \rho_{12} \\ \vdots \\ \rho_{dd} \end{pmatrix} =: \vec{\rho}.$$

Using this mapping, the matrix form of operators acting on $\mathcal{T}(\mathcal{H})$ is build using the simple rule [GTW09]

$$A\rho B \mapsto (A \otimes B^T) \vec{\rho}. \quad (3.2)$$

For instance applying this rule to a commutator, $[H, \rho] \mapsto (H \otimes \mathbb{1} - \mathbb{1} \otimes H^T) \vec{\rho}$. This representation is useful to prove various results involving operators acting on the space of density matrices, see for instance the appendix A. Additionally it is simple to prove that the Hilbert-Schmidt inner product is mapped to $\langle \gamma, \rho \rangle \mapsto \vec{\gamma}^\dagger \vec{\rho}$.

One can use other operator basis accordingly to our purposes. In general we have the following, consider $\{A_i\}_i$ an orthonormal operator basis in the space $\mathcal{T}(\mathcal{H})$, the components of the density matrix are

$$\alpha_i = \langle A_i, \rho \rangle = \text{tr} \left[A_i^\dagger \rho \right],$$

so

$$\rho = \sum_i \alpha_i A_i.$$

Correspondingly, the components of operators acting on $\mathcal{B}(\mathcal{H})$, for instance \mathcal{E} , are simply

$$\hat{\mathcal{E}}_{ij} = \langle A_i, \mathcal{E}[A_j] \rangle = \text{tr} \left[A_i^\dagger \mathcal{E}[A_j] \right].$$

Using this equation it is easy to prove that the representation of the adjoint operator of \mathcal{E} , see eq. (2.25), is simply $\hat{\mathcal{E}}^* = \hat{\mathcal{E}}^\dagger$.

3.3.1 Hermitian and traceless basis

Two types of basis are specially useful in this work, the first one are the hermitian basis. This is, every orthonormal basis $\{A_i\}_i$ that fulfills $A_i = A_i^\dagger$, $\forall i$. To show the utility of this kind of basis, let us introduce the following definition,

Definition 8 (Hermiticity preserving operators). *A linear operator $\mathcal{E} : \mathcal{B}(\mathcal{H}) \rightarrow \mathcal{B}(\mathcal{H})$ preserves hermiticity if*

$$\mathcal{E}[\Delta]^\dagger = \mathcal{E}[\Delta^\dagger], \quad \forall \Delta \in \mathcal{B}(\mathcal{H}).$$

Using the Kraus representation is trivial to prove that linear CPTP maps preserve hermiticity, using complete positivity. Furthermore, hermiticity preserving maps enjoy an hermitian Choi-Jamiołkowski representation, i.e. $\tau_{\mathcal{E}} = \tau_{\mathcal{E}}^\dagger$ [Wol11].

Using an hermitian basis it is straightforward to prove the following,

Proposition 1 (Representation with real entries). *Let \mathcal{E} be a linear and hermiticity preserving map. Its matrix representation using an hermitian basis $\{A_i\}$ has real entries.*

Proof. Let $\overline{\hat{\mathcal{E}}_{ij}} = \overline{\text{tr}[A_i \mathcal{E}[A_j]]}$, where the line over denotes complex conjugation. Distributing the latter inside the argument of the trace and using the hermiticity of A_i , we get $\overline{\hat{\mathcal{E}}_{ij}} = \text{tr}[A_i \mathcal{E}[A_j]^\dagger]$, finally stressing that $\mathcal{E}[A_j]^\dagger = \mathcal{E}[A_j^\dagger] = \mathcal{E}[A_j]$, we arrive to $\overline{\hat{\mathcal{E}}_{ij}} = \hat{\mathcal{E}}_{ij}$. \square

This simple property will be used later to prove the equivalence of the problem of finding channels that can be written as $\mathcal{E} = \exp(L)$, with L a Lindblad generator.

The second useful type of basis are the so called traceless bases. They are defined as follows. Let $\{F_i\}_{i=0}^{d^2-1}$ be an orthogonal basis, where we have indicated the dimension of the space $\mathcal{T}(\mathcal{H})$ as d^2 with $d = \dim(\mathcal{H})$, it is traceless if $F_0 = \mathbb{1}/\sqrt{n}$ and $\text{tr} F_i = 0 \ \forall i > 0$. The traceless property comes from the fact that only one element has non-zero trace, it is easy to prove that it must be proportional to the identity, given that one can write the identity matrix using such basis.

This basis is useful to prove that generators of quantum dynamical maps, L_t , defined with $\mathcal{E}_{(t+\varepsilon,t)}[\rho] = \rho + \varepsilon L_t[\rho] + \mathcal{O}(\varepsilon^2)$, have the following specific structure.

Theorem 8 (Specific form of generators of dynamical maps). *Let $L : \mathcal{T}(\mathcal{H}) \rightarrow \mathcal{T}(\mathcal{H})$ be a linear operator fulfilling $L[\Delta]^\dagger = L[\Delta^\dagger]$ and $\text{tr}[L[\Delta]] = 0$ (or equivalently $L^*[\mathbb{1}] = 0$), then it has the following form,*

$$L[\rho] = i[\rho, H] + \sum_{i,j=1}^{d^2-1} G_{ij} \left(F_i \rho F_j^\dagger - \frac{1}{2} \{F_j^\dagger F_i, \rho\} \right), \quad (3.3)$$

where $d = \dim(\mathcal{H})$, $H \in \mathbb{C}^{d \times d}$ and $G \in \mathbb{C}^{(d^2-1) \times (d^2-1)}$ are hermitian, and $\{F_i\}_{i=0}^{d^2-1}$ is an orthonormal traceless basis of $\mathcal{B}(\mathcal{H})$.

Notice that Lindblad generators enjoy such form with the additional condition that $G \geq 0$, see eq. (2.20). A proof of this is given in Ref. [EL77] for the infinite dimensional case using technicalities beyond this work. Here we will prove it for

the finite dimensional case, using the notation of an incomplete proof given in Ref. [WECC08].

Proof. Since L preserves hermiticity, it has an hermitian Choi-Jamiołkowski matrix, $\tau_L \in \mathbb{C}^{d^2 \times d^2}$. We can write such matrix always as

$$\tau_L = \tau_\phi - |\Psi\rangle\langle\Omega| - |\Omega\rangle\langle\Psi|, \quad (3.4)$$

where $|\Psi\rangle = -\omega_\perp \tau_L |\Omega\rangle - (\lambda/2) |\Omega\rangle$, $\lambda = \langle\Omega|\tau_L|\Omega\rangle$, $\omega_\perp \tau_L \omega_\perp = \omega_\perp \tau_\phi \omega_\perp = \tau_\phi$ and $\omega_\perp = \mathbb{1} - \omega$. Observe that choosing the traceless operator basis $\{F_i\}_{i=0}^{d^2-1}$, it is simple to prove that the matrix τ_ϕ can be understood also as the Choi-Jamiołkowski matrix of the following operator:

$$\phi[\rho] = \sum_{i,j=1}^{d^2-1} G_{ij} F_i \rho F_j^\dagger, \quad (3.5)$$

with G hermitian, i.e. $\tau_\phi = (\text{id}_{d^2} \otimes \phi)[\omega]$. This can be shown noticing that the summation $\sum_{i,j=1}^{d^2-1}$ goes over only traceless operators, therefore the projections into the one-dimensional space of $|\Omega\rangle$ of the Choi matrix of ϕ are null,

$$\omega \tau_\phi = \sum_{i,j=1}^{d^2-1} G_{ij} \frac{1}{d} \text{tr}(F_i) \omega \left(\mathbb{1} \otimes F_j^\dagger \right) = 0,$$

and similarly for

$$\tau_\phi \omega = 0.$$

For the second and third terms of Eq. 3.4, it is easy to show that the corresponding operator is simply $\rho \mapsto -\kappa\rho - \rho\kappa^\dagger$, where we identify $|\Psi\rangle = (\mathbb{1} \otimes \kappa)|\Omega\rangle$.

Up to now we have shown that hermiticity preserving generators have the form

$$L[\rho] = \phi[\rho] - \kappa\rho - \rho\kappa^\dagger. \quad (3.6)$$

Using the condition $L^*[\mathbb{1}] = 0$, we have that

$$\kappa + \kappa^\dagger = \phi^*[\mathbb{1}],$$

i.e. the hermitian part of κ is given by $\frac{1}{2} \sum_{i,j=1}^{d^2-1} G_{ij} F_j^\dagger F_i$. Simply writing the anti-hermitian part as iH we end up with

$$\kappa = iH + \frac{1}{2} \sum_{i,j=1}^{d^2-1} G_{ij} F_j^\dagger F_i.$$

Substituting this expression and eq. (3.5), in eq. (3.6), we arrive to the desired form, see 4.5. \square

Notice that the operator ϕ is completely positive if and only if $G \geq 0$ [HZ12], thus, $G \geq 0 \Leftrightarrow \tau_\phi \geq 0$. In such case L has exactly a Lindblad form. This condition will be introduced later as *conditional complete positivity* [EL77, WECC08].

The following is a central and useful result for our work.

Proposition 2 (Conditional complete positivity). *An hermiticity preserving linear operator $L : \mathcal{T}(\mathcal{H}) \rightarrow \mathcal{T}(\mathcal{H})$ fulfilling $\text{tr}[L^*[\mathbb{1}]] = 0$, has Lindblad form if and only if*

$$\omega_\perp \tau_L \omega_\perp \geq 0.$$

Additionally choosing an arbitrary basis of the Hilbert space to write operators $\{F_i\}_{i=1}^{d^2}$, it is easy to prove that G and $\omega_\perp \tau_L \omega_\perp$ are related by an unitary conjugation [CDG19].

3.4 Qubit channels

We shall devote some time to the most simple but non-trivial quantum system, the qubit. This case turns out to be rich enough to use and test the tools provided by the literature and the ones developed here, in the context of divisibility. We recall a particular representation and a couple of decomposition theorems for qubit channels.

3.4.1 Pauli representation and Ruskai's decomposition

In the case of qubit channels we can have at the same time an hermitian, traceless and unitary basis, it is the simple Pauli basis $\frac{1}{\sqrt{2}}\{\mathbf{1}, \sigma_x, \sigma_y, \sigma_z\}$. This induces a simple 4×4 representation with real entries given by

$$\hat{\mathcal{E}} = \begin{pmatrix} 1 & \vec{0}^T \\ \vec{t} & \Delta \end{pmatrix}, \quad (3.7)$$

where Δ is a 3×3 matrix with real entries and \vec{t} a column vector. This describes the action of the channel in the Bloch sphere picture in which the points \vec{r} are identified with density matrices $\rho_{\vec{r}} = \frac{1}{2}(\mathbb{1} + \vec{r} \cdot \vec{\sigma})$ [RSW02]. Therefore the action of the channel is described by $\mathcal{E}(\rho_{\vec{r}}) = \rho_{\Delta\vec{r} + \vec{t}}$.

In order to study qubit channels with simpler expressions, we will consider a decomposition in unitaries such that

$$\mathcal{E} = \mathcal{U}_1 \mathcal{D} \mathcal{U}_2. \quad (3.8)$$

This can be achieved using Ruskai's decomposition [RSW02], which can be performed by decomposing Δ in rotation matrices, i.e. $\Delta = R_1 D R_2$, where $D = \text{diag}(\lambda_1, \lambda_2, \lambda_3)$ is diagonal and the rotations $R_{1,2} \in \text{SO}(3)$ (of the Bloch sphere) correspond to the unitary channels $\mathcal{U}_{1,2}$. Notice that as D is not required to be positive-semidefinite, Ruskai's decomposition must not be confused with the singular value decomposition. The latter allows decompositions that include total reflections. Such operations do not correspond to unitaries over a qubit, in fact they are not CPTP. An example of this is the universal NOT gate defined by $\rho \mapsto \mathbb{1} - \rho$, it is PTP but not CPTP. The resulting form from Ruskai's decomposition is stated in the following theorem,

Theorem 9 (Special orthogonal normal form). *For any qubit channel \mathcal{E} , there exist two unitary conjugations, \mathcal{U}_1 and \mathcal{U}_2 , such that $\mathcal{E} = \mathcal{U}_1 \mathcal{D} \mathcal{U}_2$, where \mathcal{D} has the following form in the Pauli basis,*

$$\hat{\mathcal{D}} = \begin{pmatrix} 1 & \vec{0}^T \\ \vec{\gamma} & D \end{pmatrix}, \quad (3.9)$$

and is called special orthogonal normal form of \mathcal{E} .

Here, $R_1^T \Delta R_2^T = D$ and $\vec{\gamma} = R_1^T \vec{t}$. The latter describes the shift of the center of the Bloch sphere under the action of \mathcal{D} . The parameters $\vec{\lambda}$ determine the length of semi-axes of the Bloch ellipsoid, being the deformation of Bloch sphere under the action of \mathcal{E} . In particular $\det \hat{\mathcal{D}} = \det \hat{\mathcal{E}} = \lambda_1 \lambda_2 \lambda_3$.

To develop geometric intuition in the space determined by the possible values of the three parameters of $\vec{\lambda}$, consider the Choi-Jamiołkowski representation of the special orthogonal normal form of an arbitrary channel in the basis that diagonalises D ,

$$\tau_{\mathcal{D}} = \frac{1}{4} \begin{pmatrix} \gamma_3 + \lambda_3 + 1 & \gamma_1 - i\gamma_2 & 0 & \lambda_1 + \lambda_2 \\ \gamma_1 + i\gamma_2 & -\gamma_3 - \lambda_3 + 1 & \lambda_1 - \lambda_2 & 0 \\ 0 & \lambda_1 - \lambda_2 & \gamma_3 - \lambda_3 + 1 & \gamma_1 - i\gamma_2 \\ \lambda_1 + \lambda_2 & 0 & \gamma_1 + i\gamma_2 & -\gamma_3 + \lambda_3 + 1 \end{pmatrix}. \quad (3.10)$$

Complete positivity is determined by the non-negativity of its eigenvalues, given that it is hermitian, but it turns that for the general case they have complicated expressions. To overcome this problem we use the fact that if \mathcal{D} is a channel, then

its *unital part*, defined by taking $\vec{\gamma} = \vec{0}$, is a channel too [Wol11]. Therefore the set of the possible values of $\vec{\lambda}$ for the general case is contained in the set arising from the unital case. The complete positivity conditions for the latter are

$$1 + \lambda_i \pm (\lambda_j + \lambda_k) \geq 0, \quad (3.11)$$

with i, j and k all different, this implies that the possible set of lambdas lives inside the tetrahedron with corners $(1, 1, 1)$, $(1, -1, -1)$, $(-1, 1, -1)$ and $(-1, -1, 1)$, see fig. 3.1. For unital channels, all points in the tetrahedron are allowed. The corner $\vec{\lambda} = (1, 1, 1)$ corresponds to the identity channel, $\vec{\lambda} = (1, -1, -1)$ to σ_x , $\vec{\lambda} = (-1, 1, -1)$ to σ_y and $\vec{\lambda} = (-1, -1, 1)$ to σ_z (Kraus rank 1 operations). Points in the edges correspond to Kraus rank 2 operations, points in the faces to Kraus rank 3 operations and in the interior of the tetrahedron to Kraus rank 4 operations. In particular, this tetrahedron defines the set of *Pauli channels*, which are defined to have diagonal special orthogonal normal form.

Definition 9 (Pauli channels). *A qubit channel \mathcal{E} is a Pauli channel if*

$$\mathcal{E}[\rho] = \sum_{i=0}^3 p_i \sigma_i \rho \sigma_i, \quad (3.12)$$

with $\sigma_0 := \mathbb{1}$, $p_i \geq 0$ and $\sum_{i=0}^3 p_i = 1$.

For non-unital channels more restrictive conditions arise, an example will be given later.

3.4.2 1wSLOCC and singular value decomposition using the Lorentz metric

There is another parametrization for qubit channels called *Lorentz normal decomposition* [VDD01] which is specially useful to characterize infinitesimal divisibility \mathcal{C}^{Inf} . To introduce it, let us resort to chapter 2 where we discussed local operations and classical communication. For the two-qubit case, the operations that Alice and Bob apply for their reduced states are

$$\begin{aligned} \rho_A &\mapsto X \rho_A X^\dagger \\ \rho_B &\mapsto Y \rho_B Y^\dagger, \end{aligned} \quad (3.13)$$

where we have shown that it is enough to consider $X, Y \in \text{SL}(2, \mathbb{C})$ for X and Y invertible, see chapter 2 Now we are going to show that such operations can be

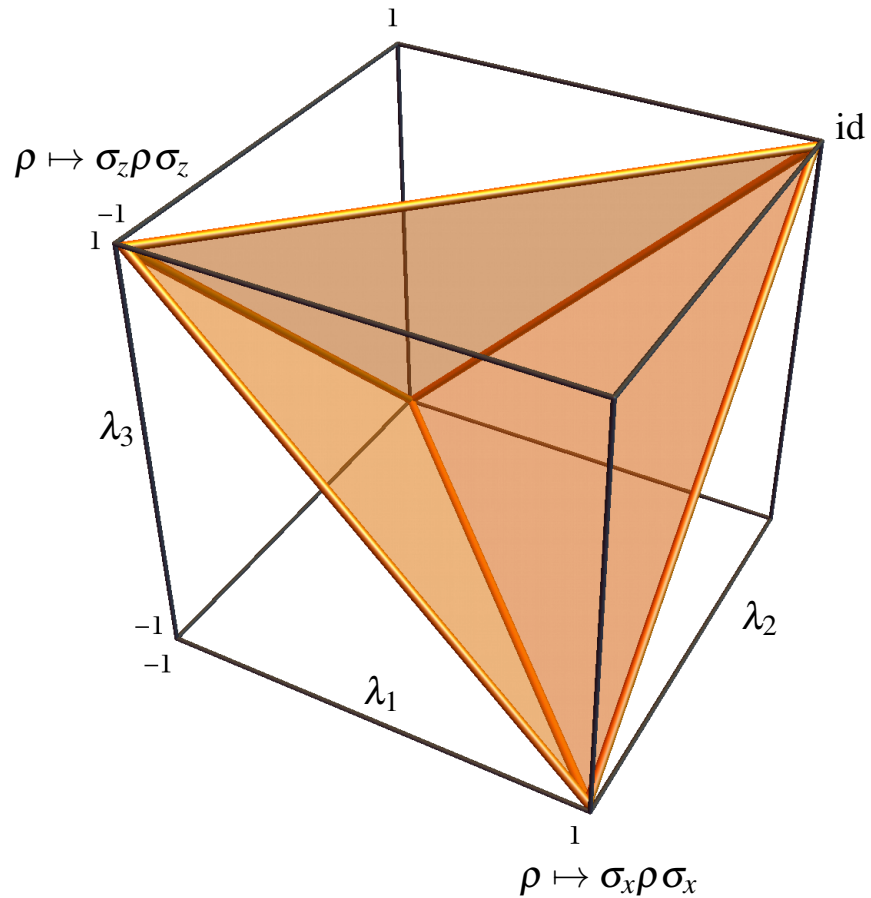

Figure 3.1: Set of the possible values of $\vec{\lambda}$. This set has the shape of a tetrahedron where the corners are the Pauli unitaries ($\mathbb{1}$, σ_x and σ_z are indicated in the figure, while σ_y lies behind). The rest of the body contains convex combinations of Pauli unitaries. Unital qubit channels can be obtained by concatenating Pauli channels with unitary conjugations, see theorem 9.

understood as proper orthochronous Lorentz transformations in the Pauli representation.

Consider an arbitrary hermitian operator Δ and its representation in the Pauli basis,

$$\Delta = (\mathbb{1} \operatorname{tr} \Delta + \vec{r}_\Delta \cdot \vec{\sigma}) / 2$$

with $\det \Delta = (\operatorname{tr} \Delta)^2 - |\vec{r}_\Delta|^2$. Now observe that $\det \Delta$ can be understood as the squared Lorentz norm of the four-vector $r_\Delta = (\operatorname{tr} \Delta, \vec{r}_\Delta)^T$, lying in the Minkowski vector space, denoted as (\mathbb{R}^4, η) , where $\eta = \operatorname{diag}(1, -1, -1, -1)$ is the *Lorentz metric*. Therefore we have

$$\det \Delta = |r_\Delta|_{\text{Lorentz}}^2 = \langle r_\Delta, \eta r_\Delta \rangle, \quad (3.14)$$

with $\langle \cdot \rangle$ the standard inner product. Then $\operatorname{tr} \Delta$ is a time-like component and \vec{r}_Δ space-like components.

Given that operations shown in eq. (3.13) preserve the determinant, they are isometries in the Minkowski space. That is, they preserve the norm shown in eq. (3.14) for any vector r_Δ (with Δ hermitian). Additionally, due to linearity of eq. (3.13), these operations belong to $\text{SO}(3,1)$ (the Lorentz group). In fact, due to the positivity of quantum operations, they do not change the sign of the trace (the time-like component); therefore the transformations are orthochronous. Also notice that $\text{SL}(2, \mathbb{C})$ contains the identity transformation, therefore the set of one-way stochastic local operations and classical communication is identified with the proper orthochronous Lorentz group, $\text{SO}^+(1,3)$ [Wol11, Tun85]. However, since $-X$ and X give the same result, see eq. (3.13), and both belong to $\text{SL}(2, \mathbb{C})$, one says that the latter is a double cover of $\text{SO}^+(1,3)$. This map is also called *spinor map*.

Given this map, it is expected that the operations mentioned in eq. (3.13) are explicitly Lorentz matrices, when writing them in the Pauli basis. Also notice that unitary conjugations are particular cases of them [RSW02], therefore one can think of a different decomposition using the Lorentz metric instead of the three dimensional Euclidean metric, used in Ruskai's decomposition.

The Lorentz normal form was introduced first for two-qubit states by writing them as

$$\tau = \frac{1}{4} \sum_{ij} R_{ij} \sigma_i \otimes \sigma_j, \quad (3.15)$$

where we have used the notation of Choi-Jamiołkowski states for convenience. This decomposition is derived from the theorem 3 of Ref. [VDD01], which essentially states that the matrix R can be decomposed as

$$R = L_1 \Sigma L_2^T. \quad (3.16)$$

Here $L_{1,2}$ are proper orthochronous Lorentz transformations and Σ is either $\Sigma = \text{diag}(s_0, s_1, s_2, s_3)$ with $s_0 \geq s_1 \geq s_2 \geq |s_3|$, or

$$\Sigma = \begin{pmatrix} a & 0 & 0 & b \\ 0 & d & 0 & 0 \\ 0 & 0 & -d & 0 \\ c & 0 & 0 & -b+c+a \end{pmatrix}. \quad (3.17)$$

Note that Σ corresponds to an unnormalized state, with trace $\text{tr}\Sigma = a$. Thus, the normalization constant is $\alpha = a^{-1}$.

To introduce the Lorentz normal decomposition of qubit channels, let us first introduce the following. Let \mathcal{E} a qubit channel and $\hat{\mathcal{E}}$ its matrix representation using the Pauli basis. The latter is related with the matrix R , which defines its Choi-Jamiołkowski state, see eq. (3.15),

$$\hat{\mathcal{E}}\Phi_{\text{T}} = R, \quad (3.18)$$

where $\Phi_{\text{T}} = \text{diag}(1, 1, -1, 1)$. This can be shown by defining a generic Pauli channel, computing its Choi matrix and extracting R using the Hilbert-Schmidt inner product with the basis $\{\sigma_i \otimes \sigma_j\}_{i,j}$. Now, defining the decomposition for channels throughout decomposing the Choi-Jamiołkowski state, we can easily compute the corresponding Lorentz transformations using equations (3.18) and (3.16):

$$R\Phi_{\text{T}} = \alpha L_1 \Sigma L_2^{\text{T}} \Phi_{\text{T}} \quad (3.19)$$

$$\hat{\mathcal{E}} = \alpha L_1 \Sigma L_2^{\text{T}} \Phi_{\text{T}} \quad (3.20)$$

$$= L_1 (\alpha \Sigma \Phi_{\text{T}}) \Phi_{\text{T}} L_2^{\text{T}} \Phi_{\text{T}} \quad (3.21)$$

$$= L_1 \hat{\mathcal{E}} \tilde{L}_2^{\text{T}},$$

where $\hat{\mathcal{E}} = \alpha \Sigma \Phi_{\text{T}}$ is the Lorentz normal form of $\hat{\mathcal{E}}$. Also notice that $\tilde{L}_2^{\text{T}} = \Phi_{\text{T}} L_2^{\text{T}} \Phi_{\text{T}}$ is proper and orthochronous, given that its determinant is positive and Φ_{T} is proper. Therefore the possible Lorentz normal forms for channels are $\hat{\mathcal{E}} = \text{diag}(s_0, s_1, -s_2, s_3)$ with $s_0 \geq s_1 \geq s_2 \geq |s_3|$, or

$$\hat{\mathcal{E}} = \begin{pmatrix} a & 0 & 0 & b \\ 0 & d & 0 & 0 \\ 0 & 0 & d & 0 \\ c & 0 & 0 & -b+c+a \end{pmatrix}. \quad (3.22)$$

Using this, the authors of Ref. [VV02] introduced a theorem (theorem 8 of the reference) defining the Lorentz normal form for channels by forcing $b = 0$, in order to have normal forms proportional to trace-preserving operations. The latter

is equivalent to say that the decomposition of Choi-Jamiołkowski states leads to states that are also Choi-Jamiołkowski. We didn't find a good argument to justify such assumption, and found a counterexample that shows that Lorentz normal forms with $b \neq 0$ exist (see appendix B). Therefore in general we can find a Σ with form of eq. (3.17) with $b \neq 0$. The consequence of this is that the theorem 8 of Ref. [VV02] is incomplete, but given that form of eq. (3.17) is Kraus rank deficient (it has rank three for $b \neq c$ and two for $b = c$), the full Kraus rank case is still useful. Thus, we propose a restricted version of their theorem:

Theorem 10 (Restricted Lorentz normal form for qubit quantum channels).

For any full Kraus rank qubit channel \mathcal{E} there exist rank-one completely positive maps $\mathcal{T}_1, \mathcal{T}_2$ such that $\mathcal{T} = \mathcal{T}_1 \mathcal{E} \mathcal{T}_2$ is proportional to

$$\begin{pmatrix} 1 & \vec{0}^T \\ \vec{0} & \Lambda \end{pmatrix}, \quad (3.23)$$

where $\Lambda = \text{diag}(s_1, s_2, s_3)$ with $1 \geq s_1 \geq s_2 \geq |s_3|$.

The channel \mathcal{T} is called the Lorentz normal form of the channel \mathcal{E} . For unital qubit channels D coincides with Λ .

3.5 Representation of Gaussian quantum channels

In this section we start from two ansätze, that put together with the Gaussian functional form considered in Ref. [MP12], lead to the complete set of functional forms in position state representation of one-mode Gaussian channels.

We will show that only two possible forms of δ GQC hold according to *trace preserving* (TP) and *hermiticity preserving* (HP) conditions. The one corresponding to eq. (2.33) is one of these, as expected. Later on we will impose *complete positivity* in order to have valid GQC, i.e. *complete positive and trace preserving* (C) Gaussian operations.

Following definition 7, those channels can be characterized by how they act over Gaussian states. It is well known that the action of GQCs on Gaussian states is described by *affine transformations* [WPGP⁺12]. Let \mathcal{A} be a GQC defined by a tuple such that $\mathcal{A} = \mathcal{A}(\mathbf{T}, \mathbf{N}, \vec{\tau})$, where \mathbf{T} and \mathbf{N} are 2×2 real matrices with $\mathbf{N} = \mathbf{N}^T$ [WPGP⁺12]. The transformation acts on Gaussian states according to

$$\mathcal{A}(\mathbf{T}, \mathbf{N}, \vec{\tau}) \left[S(\sigma, \vec{d}) \right] = S(\mathbf{T}\sigma\mathbf{T}^T + \mathbf{N}, \mathbf{T}\vec{d} + \vec{\tau}).$$

In the particular case of closed systems, where the system is governed by a Gaussian unitary, we have that $\mathbf{N} = \mathbf{0}$ and \mathbf{T} is a symplectic matrix.

3.5.1 Possible functional forms of δ GQC operations

Let us introduce the ansätze for the possible forms of GQC in the position representation, to perform the black-box characterization. Following eq. (2.29) and taking the continuous variable representation of difference and sum coordinates, the trace becomes an integral over position variables of the environment. Then we end up with a Fourier transform of a multivariate Gaussian. Since the Fourier transform of a Gaussian is again a Gaussian (unless there are singularities in the coefficients, as in the example of eq. (2.33)), the result of the Fourier transform for one mode can have the following structures: a Gaussian form [eq. (2.31)], a Gaussian form multiplied with one-dimensional delta or a Gaussian form multiplied by a two-dimensional delta. No more deltas are allowed given that there are only two integration variables when applying the channel, see eq. (2.30). Thus, in order to start with the black-box characterization, we shall propose the following general Gaussian operations with one and two deltas, respectively

$$J_{\text{I}}(x_f, r_f; x_i, r_i) = \mathcal{N}_{\text{I}} \delta(\vec{\alpha}^T \vec{v}_f + \vec{\beta}^T \vec{v}_i) e^{\Sigma(x_f, x_i; r_f, r_i)}, \quad (3.24)$$

$$J_{\text{II}}(x_f, r_f; x_i, r_i) = \mathcal{N}_{\text{II}} \delta(\mathbf{A} \vec{v}_f - \mathbf{B} \vec{v}_i) e^{\Sigma(x_f, x_i; r_f, r_i)}, \quad (3.25)$$

with $\vec{v}_{i,j} = (r_{i,j}, x_{i,j})$, and $\mathcal{N}_{\text{I,II}}$ are normalization constants. Coefficient arrays \mathbf{A} , \mathbf{B} , $\vec{\alpha}$, and $\vec{\beta}$ have real entries since initial and final coordinates must be real. Finally, the exponent reads:

$$\begin{aligned} \Sigma(x_f, x_i; r_f, r_i) = & i \left(b_1 x_f r_f + b_2 x_f r_i + b_3 x_i r_f + b_4 x_i r_i + c_1 x_f + c_2 x_i \right) \\ & - a_1 x_f^2 - a_2 x_f x_i - a_3 x_i^2 - e_1 r_f^2 - e_2 r_f r_i - e_3 r_i^2 - d_1 r_f - d_2 r_i. \end{aligned}$$

They provide, together with eq. (2.31) all possible ansätze for GQC.

3.5.2 Hermiticity and trace preserving conditions

Before studying CPTP conditions it is useful to simplify expressions of equations (3.24) and (3.25). To do this we use the fact that linear CPTP operations preserve hermiticity and trace. For channels of continuous variable systems in the position

state representation, $J(q_f, q'_f; q_i, q'_i)$, HP condition is derived as follows,

$$\begin{aligned}\rho_f(q'_f, q_f)^* &= \int_{\mathbb{R}^2} dq_i dq'_i J(q'_f, q_f; q_i, q'_i)^* \rho_i(q_i, q'_i)^* \\ &= \int_{\mathbb{R}^2} dq_i dq'_i J(q'_f, q_f; q'_i, q_i)^* \rho_i(q_i, q'_i) \\ &= \rho_f(q_f, q'_f),\end{aligned}\tag{3.26}$$

where the last equality holds if

$$J(q_f, q'_f; q_i, q'_i) = J(q'_f, q_f; q'_i, q_i)^*.$$

Using sum and difference coordinates, HP becomes

$$J(-x_f, r_f; -x_i, r_i) = J(x_f, r_f; x_i, r_i)^*.\tag{3.27}$$

Following this equation and comparing exponents of the both sides of the last equations, it is easy to note that the coefficients a_n , b_n , c_n , e_n and d_n must be real. Concerning the delta factors, in eq. (3.27) we end up with expressions like

$$\delta(\alpha_1 x_f + \alpha_2 x_i + \beta_1 r_f + \beta_2 r_i) = \delta(-\alpha_1 x_f - \alpha_2 x_i + \beta_1 r_f + \beta_2 r_i)$$

for both cases. Therefore the equality holds for eq. (3.24) only for two possible combinations of variables: i) $\delta(\alpha x_f - \beta x_i)$ and ii) $\delta(\alpha r_f - \beta r_i)$. For the case of eq. (3.25), equality holds only for iii) $\delta(\gamma r_f - \eta r_i) \delta(\alpha x_f - \beta x_i)$. Let us now analyze the trace preserving condition (TP), since the trace of ρ_f in sum and difference coordinates is

$$\begin{aligned}\text{tr } \rho_f &= \int_{\mathbb{R}} dr'_f \rho_f(x_f = 0, r'_f) \\ &= \int_{\mathbb{R}} dr'_f dr_i dx_i J(x_f = 0, r'_f; x_i, r_i) \rho_i(x_i, r_i) \\ &= \int_{\mathbb{R}} dr_i \rho_i(x_i = 0, r_i).\end{aligned}$$

To fulfill the last equality, the following must be accomplished

$$\int_{\mathbb{R}} dr'_f J(x_f = 0, r'_f; x_i, r_i) = \delta(x_i).\tag{3.28}$$

This condition immediately discards ii) from the above combinations of deltas, thus we end up with cases i) and iii). For case i) TP reads:

$$\mathcal{N}_1 \int dr_f \delta(-\beta x_i) e^{\Sigma} = \frac{\mathcal{N}_1}{|\beta|} \sqrt{\frac{\pi}{e_1}} \delta(x_i) e^{\left(\frac{e_2^2}{4e_1} - e_3\right) r_i^2},\tag{3.29}$$

thus, the relation between the coefficients assumes the form

$$\frac{e_2^2}{4e_1} - e_3 = 0, d_1 = 0, d_2 = 0, \quad (3.30)$$

and the normalization constant $\mathcal{N}_I = |\beta| \sqrt{\frac{e_1}{\pi}}$ with $\beta \neq 0$ and $e_1 > 0$. For case iii) the trace-preserving condition reads

$$\mathcal{N}_{II} \int dr_f \delta(\gamma r_f - \eta r_i) \delta(-\beta x_i) e^{\mathcal{L}} = \frac{\mathcal{N}_{II}}{|\beta\gamma|} \delta(x_i) e^{-\left(e_1\left(\frac{\eta}{\gamma}\right)^2 + e_2\frac{\eta}{\gamma} + e_3\right)r_i^2 - \left(d_1\frac{\eta}{\gamma} + d_2\right)r_i}.$$

Thus, the following relation between e_n and d_n coefficients must be fulfilled:

$$e_1 \left(\frac{\eta}{\gamma}\right)^2 + e_2 \frac{\eta}{\gamma} + e_3 = 0, \quad d_1 \frac{\eta}{\gamma} + d_2 = 0, \quad (3.31)$$

with $\gamma, \beta \neq 0$ and $\mathcal{N}_{II} = |\beta\gamma|$. In the particular case of $\eta = 0$, eq. (3.31) is reduced to $e_3 = d_2 = 0$. As expected from the analysis of limits above, we showed that δGQC 's admit quadratic terms in $r_{i,j}$.

3.5.3 Complete positivity conditions

Up to this point we have *hermitian and trace preserving Gaussian operations*; to derive the remaining CPTP conditions, it is useful to write its Wigner's function and Wigner's characteristic function. The representation of the Wigner's characteristic function reads

$$\chi(\vec{k}) = \exp \left[-\frac{1}{2} \vec{k}^T (\Omega \sigma \Omega^T) \vec{k} - i (\Omega \langle \hat{x} \rangle)^T \vec{k} \right] \quad (3.32)$$

and its relation with Wigner's function:

$$W(\mathbf{x}) = \int_{\mathbb{R}^2} d\vec{x} e^{-i\vec{x}^T \Omega \vec{k}} \chi(\vec{k}) \quad (3.33)$$

$$= \int_{\mathbb{R}} e^{ipx} dx \left\langle r - \frac{x}{2} \left| \hat{\rho} \left| r + \frac{x}{2} \right. \right. \right\rangle, \quad (3.34)$$

where $\vec{k} = (k_1, k_2)^T$, $\vec{x} = (r, p)^T$ and $\hbar = 1$ (we are using natural units). Using the previous equations to construct Wigner and Wigner's characteristic functions of the initial and final states, and substituting them in the equation 2.30, it is straightforward to get the propagator in the Wigner's characteristic function representation:

$$\tilde{J}(\vec{k}_f, \vec{k}_i) = \int_{\mathbb{R}^6} d\Gamma K(\vec{l}) J(\vec{v}_f, \vec{v}_i), \quad (3.35)$$

where the transformation kernel reads

$$K(\vec{l}) = \frac{1}{(2\pi)^3} e^{i(k_2^f r_f - k_1^f p_f - k_2^i r_i + k_1^i p_i - p_i x_i + p_f x_f)},$$

with $d\Gamma = dp_f dp_i dx_f dx_i dr_f dr_i$ and $\vec{l} = (p_f, p_i, x_f, x_i, r_f, r_i)^T$. By elementary integration of eq. (3.35) one can show that for both cases

$$\tilde{J}_{\text{I,III}}(\vec{k}_f, \vec{k}_i) = \delta\left(k_1^i - \frac{\alpha}{\beta} k_1^f\right) \delta\left(k_2^i - \vec{\phi}_{\text{I,III}}^T \vec{k}_f\right) e^{P_{\text{I,III}}(\vec{k}_f)}, \quad (3.36)$$

where $P_{\text{I,III}}(\vec{k}_f) = \sum_{i,j=1}^2 P_{ij}^{(\text{I,III})} k_i^f k_j^f + \sum_{i=1}^2 P_{0i}^{(\text{I,III})} k_i^f$ with $P_{ij}^{(\text{I,III})} = P_{ji}^{(\text{I,III})}$. For case i) we obtain

$$\begin{aligned} P_{11}^{(\text{I})} &= -\left(\left(\frac{\alpha}{\beta}\right)^2 \left(a_3 + \frac{b_3^2}{4e_1}\right) + \frac{\alpha}{\beta} \left(a_2 + \frac{1}{2} \frac{b_1 b_3}{e_1}\right) + a_1 + \frac{b_1^2}{4e_1}\right), \\ P_{12}^{(\text{I})} &= -\left(\frac{\alpha}{\beta} \frac{b_3}{2e_1} + \frac{b_1}{2e_1}\right), \\ P_{22}^{(\text{I})} &= -\frac{1}{4e_1}. \end{aligned} \quad (3.37)$$

For case iii) we have

$$\begin{aligned} P_{11}^{(\text{III})} &= -\left(\left(\frac{\alpha}{\beta}\right)^2 a_3 + \frac{\alpha}{\beta} a_2 + a_1\right), \\ P_{12}^{(\text{III})} &= P_{22}^{(\text{III})} = 0. \end{aligned} \quad (3.38)$$

And for both cases we have $P_{01}^{(\text{I,III})} = i\left(\frac{\alpha}{\beta} c_2 + c_1\right)$ and $P_{02}^{(\text{I,III})} = 0$. Vectors $\vec{\phi}$ are given by

$$\begin{aligned} \vec{\phi}_{\text{I}} &= \left(\frac{\alpha}{\beta} \left(b_4 - \frac{b_3 e_2}{2e_1}\right) - \frac{b_1 e_2}{2e_1} + b_2, -\frac{e_2}{2e_1}\right)^T, \\ \vec{\phi}_{\text{III}} &= \left(\frac{\alpha}{\beta} \frac{\eta}{\gamma} b_3 + \frac{\alpha}{\beta} b_4 + \frac{\eta}{\gamma} b_1 + b_2, \frac{\eta}{\gamma}\right)^T. \end{aligned} \quad (3.39)$$

We are now in position to write explicitly the conditions for complete positivity. Having a Gaussian operation characterized by $(\mathbf{T}, \mathbf{N}, \vec{\tau})$, the CP condition can be expressed in terms of the matrix

$$\mathbf{C} = \mathbf{N} + i\Omega - i\mathbf{T}\Omega\mathbf{T}^T, \quad (3.40)$$

where $\Omega = \begin{pmatrix} 0 & 1 \\ -1 & 0 \end{pmatrix}$ is the symplectic matrix. An operation $\mathcal{A}(\mathbf{T}, \mathbf{N}, \vec{\tau})$ is CP if and only if $\mathbf{C} \geq 0$ [Lin00, WPGP⁺12]. Applying the propagator on a test characteristic function, eq. (3.32), it is easy compute the corresponding tuples. For both cases we get:

$$\begin{aligned} \mathbf{N}_{\text{I,III}} &= 2 \begin{pmatrix} -P_{22} & P_{12} \\ P_{12} & -P_{11} \end{pmatrix}, \\ \vec{\tau}_{\text{I,III}} &= \left(0, iP_{01}^{(\text{I,III})} \right)^T, \end{aligned} \quad (3.41)$$

while for case i) matrix \mathbf{T} is given by

$$\mathbf{T}_{\text{I}} = \begin{pmatrix} \frac{e_2}{2e_1} & 0 \\ \vec{\phi}_{\text{I},1} & -\frac{\alpha}{\beta} \end{pmatrix}, \quad (3.42)$$

where $\vec{\phi}_{\text{I},1}$ denotes the first component of vector $\vec{\phi}_{\text{I}}$, see eq. (3.39). The complete positive condition is given by the inequalities raised from the eigenvalues of matrix eq. (3.40):

$$\pm \frac{\sqrt{\alpha^2 e_2^2 + 4\alpha\beta e_2 e_1 + 4\beta^2 e_1^2 \left(4P_{12}^{(\text{I})2} + \left(P_{11}^{(\text{I})} - P_{22}^{(\text{I})} \right)^2 + 1 \right)}}{2\beta e_1} \geq P_{11}^{(\text{I})} + P_{22}^{(\text{I})}. \quad (3.43)$$

For case iii) matrix \mathbf{T} is

$$\mathbf{T}_{\text{III}} = \begin{pmatrix} -\frac{\eta}{\gamma} & 0 \\ \vec{\phi}_{\text{III},1} & -\frac{\alpha}{\beta} \end{pmatrix}, \quad (3.44)$$

and complete positivity conditions read:

$$\pm \frac{\sqrt{(\beta\gamma - \alpha\eta)^2 + \beta^2\gamma^2 P_{11}^{(\text{III})2}}}{\beta\gamma} - P_{11}^{(\text{III})} \geq 0. \quad (3.45)$$

Note that in both cases the complete positivity conditions do not depend on $\vec{\phi}$.

Chapter 4

Divisibility of quantum channels and dynamical maps

Wine is sunlight, held together by water.
Galileo Galilei

In this chapter we introduce the formal definition of *divisibility of quantum channels*, inspired by questioning how can we implement a given quantum channel via the concatenation of simpler channels. Later on we define further types of divisibility by adding extra conditions, such as channels being infinitesimal divisible and channels belonging to one-parameter semigroups. These types are physically relevant since both lead to Markovian dynamical maps [ARHP14]. We additionally prove three theorems, which are the central contributions of this part of the work. Finally, a complete characterization of channels belonging to one-parameter semigroups that is given.

4.1 Divisibility of quantum maps

A quantum channel \mathcal{E} is said to be divisible if it can be expressed as the concatenation of two non-trivial channels,

Definition 10 (Divisibility). *A linear map $\mathcal{E} \in \mathcal{C}$ is divisible if there exists a decomposition,*

$$\mathcal{E} = \mathcal{E}_2 \mathcal{E}_1, \tag{4.1}$$

such that \mathcal{E}_1 and \mathcal{E}_2 are both unitary or non-unitary channels.

Notice that this definition ensures that unitary channels are divisible, and that non-unitary channels must be divisible in non-unitary channels. This prevents one to consider simple changes of basis as a “division” of a given quantum operation. This type of divisibility, which is the most general and less restrictive one, defines a set that will be denoted by \mathcal{C}^{div} . The set of indivisible channels is the complement of \mathcal{C}^{div} in \mathcal{C} , therefore it will be denoted as $\overline{\mathcal{C}^{\text{div}}}$. Notice that this definition is different to the one given in Ref. [WC08] where unitary channels are excluded to be divisible.

The concept of indivisible channels resembles the concept of prime numbers, unitary channels play the role of unity (which are not indivisible/prime), i.e. a composition of indivisible and a unitary channel results in an indivisible channel.

We now introduce three results from Ref. [WC08] that shall be used later. We only give the proof for the second for the sake of brevity.

Theorem 11 (Full Kraus rank channels). *Let $\mathcal{E} : \mathcal{T}(\mathcal{H}) \rightarrow \mathcal{T}(\mathcal{H})$ be a quantum channel. If it has full Kraus rank, i.e. d^2 with $d = \dim(\mathcal{H})$, then it is divisible.*

An example of full Kraus rank channel is the total depolarizing channel $\rho \mapsto \mathbb{1}/\dim(\mathcal{H})$, which maps every state into the maximal mixed one.

Theorem 12 (Indivisible channels). *Consider the set \mathcal{C}_d of channels acting on the space of density matrices of $d \times d$, i.e. $\mathcal{E} : \mathcal{T}(\mathcal{H}) \rightarrow \mathcal{T}(\mathcal{H})$ with $d = \dim(\mathcal{H})$. The channel with minimal determinant, $\mathcal{E}_0 \in \mathcal{C}_d$, is indivisible.*

Proof. To prove this we use the fact that channels with negative determinant exist [WC08] (two examples are given below), and the property of monotonicity of the determinant.

Let $\mathcal{E} \in \mathcal{C}$ with $\det \mathcal{E} < 0$ and $\mathcal{E} = \mathcal{E}_2 \mathcal{E}_1$ an arbitrary division of \mathcal{E} with $\mathcal{E}_1, \mathcal{E}_2 \in \mathcal{C}$. The monotonicity of the determinant implies the following,

$$|\det(\mathcal{E}_2 \mathcal{E}_1)| = |\det \mathcal{E}_2| |\det \mathcal{E}_1| \leq |\det \mathcal{E}_1|.$$

Assuming, without loss of generality that $\det \mathcal{E}_1 < 0$ and $\det \mathcal{E}_2 > 0$, we have that

$$\det \mathcal{E}_1 \det \mathcal{E}_2 \leq \det \mathcal{E}_1.$$

Multiplying both sides by -1 we arrive to

$$|\det \mathcal{E}_2| |\det \mathcal{E}_1| \geq |\det \mathcal{E}_1|.$$

Therefore, by monotonicity of the determinant, we have

$$|\det \mathcal{E}_2| |\det \mathcal{E}_1| = |\det \mathcal{E}_1|,$$

which implies that $\det \mathcal{E}_2 = 1$, i.e. \mathcal{E}_2 is an unitary conjugation [WC08] and \mathcal{E} has minimum determinant. By definition 10 \mathcal{E} is indivisible. \square

Two examples for the qubit case are the approximate NOT and the approximate transposition maps:

$$\begin{aligned} \rho &\mapsto \frac{\text{tr}(\rho)\mathbb{1} + \rho^T}{3} \text{ (approximate transposition),} \\ \rho &\mapsto \frac{\text{tr}(\rho)\mathbb{1} - \rho}{3} \text{ (approximate NOT gate),} \end{aligned} \quad (4.2)$$

both have minimal determinant corresponding to $-1/27$, which can be computed from their matrix representation.

Theorem 13 (Unital Kraus rank three channels). *A unital qubit channel is indivisible if and only if it has Kraus rank equal to three.*

This is a restricted version of theorem 23 of Ref. [WECC08], where authors proved the theorem for any qubit channel instead of only unital ones. Since their proof rely on the validity of the Lorentz normal decomposition for channels, we have written here a restricted version, where Lorentz normal form is equivalent to the special orthogonal normal form (see theorem 10 and its discussion).

These results can be used immediately to identify the divisibility character of unital qubit channels, see fig. 4.5. The faces of the tetrahedron (without edges) correspond to indivisible channels, in particular the center of every face corresponds to channels with minimal determinant. The body (full Kraus rank channels) contain divisible channels.

4.1.1 Subclasses of divisible maps

Divisibility of quantum dynamical maps

We motivate the extra conditions to define new types of divisibility on the concept of Markovian process. In subsection 2.2.1 we have introduced the definition of Markovian process and its consequences at the level of propagators of one-point probabilities, see eq. (2.24). Based on this, we introduce the concept of

CP-divisibility of quantum dynamical maps, which is often used as definition of Markovianity in the quantum realm [ARHP14].

Definition 11 (CP-divisible quantum dynamical maps). *Consider a quantum dynamical map $\mathcal{E}_{(t,0)} : \mathcal{T}(\mathcal{H}) \rightarrow \mathcal{T}(\mathcal{H})$ with $t \in \mathbb{R}^+$. It is CP-divisible in the interval $[0, t] \subset \mathbb{R}^+$ if for every decomposition of the form*

$$\mathcal{E}_{(t,0)} = \mathcal{E}_{(t,s)} \mathcal{E}_{(s,0)},$$

$\mathcal{E}_{(t,s)}$ is a quantum channel for every $s \in (0, t)$.

A remarkable theorem on CP-divisible maps is the following [Kos72b, Kos72a, Gor76, Lin76, ARHP14],

Theorem 14 (Gorini-Kossakowski-Susarshan-Lindblad). *An operator L_t is the generator of a CP-divisible process if and only if it can be written in the following form:*

$$L_t[\rho] = -i[H(t), \rho] + \sum_{i,j} G_{ij}(t) \left(F_i(t) \rho F_j^\dagger(t) - \frac{1}{2} \{F_j^\dagger(t) F_i(t), \rho\} \right), \quad (4.3)$$

where G is hermitian and positive semidefinite, $H(t), F_k(t) \in \mathbb{C}^{d \times d}$ are time-dependent operators acting on \mathcal{H} , with $H(t)$ hermitian for every $t \in \mathbb{R}^+$, and $d = \dim(\mathcal{H})$.

In Ref. [RH12] a proof is given starting from the Kraus representation of quantum dynamical maps and the definition of CP-divisibility. Here we will give a simpler proof resorting to theorem 8.

Proof. Notice that for each time t we can define the “instant” map $\mathcal{E}_{(t+\varepsilon,t)}[\rho] = \rho + \varepsilon L_t[\rho] + \mathcal{O}(\varepsilon^2)$, with $\varepsilon > 0$, therefore the hermiticity preserving of L_t follows from the hermiticity preserving of $\mathcal{E}_{(t,0)}$. Also note that we can always choose the same traceless basis, $\{F_i\}_{i=0}^{d^2-1}$, to write eq. (4.3), such that the time dependence is dropped only in $G(t) \in \mathbb{C}^{d^2 \times d^2}$ and $H(t)$. By theorem 8, L_t has the form stated in eq. (4.3), the only thing that remains to prove is that $G(t) \geq 0$ for every t . To do this we construct the Choi-Jamiołkowski matrix of the instant map, $\tau_{t,\varepsilon} = \omega + \varepsilon (\text{id}_{d^2} \otimes L_t) [\omega] + \mathcal{O}(\varepsilon^2)$. We remind the reader that $\omega = |\Omega\rangle\langle\Omega|$, where $|\Omega\rangle$ is the Bell state between two copies of \mathbb{C}^d . Now we test positive-semidefiniteness of $\tau_{t,\varepsilon}$,

$$\langle \varphi | \tau_{t,\varepsilon} | \varphi \rangle = \langle \varphi | \omega | \varphi \rangle + \varepsilon \langle \varphi | (\text{id}_{d^2} \otimes L_t) [|\Omega\rangle\langle\Omega|] | \varphi \rangle + \mathcal{O}(\varepsilon^2) \geq 0,$$

$\forall |\varphi\rangle \in \mathbb{C}^{d^2}$. The inequality always holds for any $\langle \varphi | \Omega \rangle \neq 0$ and $\varepsilon > 0$. For $\langle \varphi | \Omega \rangle = 0$ we have that for $\varepsilon > 0$ the inequality $\langle \varphi | (\text{id}_{d^2} \otimes L_t) [|\Omega\rangle\langle\Omega|] |\varphi\rangle \geq 0$ must be accomplished, i.e. $\omega_{\perp} \tau_L \omega_{\perp} \geq 0$ (conditional complete positivity). Therefore by proposition 2, one has that $G(t) \geq 0$. \square

Analogously to CP-divisible processes, if we relax the condition of the intermediate maps to be PTP (and not necessarily CPTP), we arrive to the following definition:

Definition 12 (P-divisible quantum dynamical maps). *Consider a quantum dynamical map $\mathcal{E}_{(t,0)} : \mathcal{T}(\mathcal{H}) \rightarrow \mathcal{T}(\mathcal{H})$ with $t \in \mathbb{R}^+$. It is P-divisible in the interval $[0, t] \subset \mathbb{R}^+$ if for every decomposition of the form*

$$\mathcal{E}_{(t,0)} = \mathcal{E}_{(t,s)} \mathcal{E}_{(s,0)},$$

$\mathcal{E}_{(t,s)}$ belongs to PTP for every $s \in (0, t)$.

Unfortunately, to the best of our knowledge, there doesn't exist a statement similar to theorem 14, nor a simple test of P-divisibility. But for certain types of generators of dynamical maps, conditions for P-divisibility were derived in Ref. [CDG19].

Divisibility of quantum channels

Let us discuss these two types of divisibility but now from a static point of view. First notice that instant operations $\mathcal{E}_{(t+\varepsilon,t)}$ are arbitrarily close to the identity map as $\varepsilon \rightarrow 0^+$, for both P-divisible and CP-divisible processes. In other words, they are infinitesimal. Consider now the idea of quantum channels divisible in infinitesimal parts, i.e. what is given this time is a quantum channel instead of a dynamical map. This idea motivates the following definition [WC08],

Definition 13 (Infinitesimal divisible channels in CPTP). *Let \mathcal{L}_{CP} be the set containing operations $\mathcal{E} \in \mathcal{C}$ with the property that $\forall \varepsilon > 0$ there exist a finite number of channels $\mathcal{E}_i \in \mathcal{C}$ such that $|\mathcal{E}_i - \text{id}| < \varepsilon$ and $\mathcal{E} = \prod_i \mathcal{E}_i$, see fig. 4.1. It is said that a channel is infinitesimal divisible if it belongs to the closure of \mathcal{L}_{CP} . This set is denoted as \mathcal{C}^{CP} .*

The necessity of the closure can be motivated using the following example. Consider the qubit channel defined as follows:

$$\mathcal{E}_{\infty} : \begin{pmatrix} \rho_{00} & \rho_{01} \\ \rho_{01}^* & \rho_{11} \end{pmatrix} \mapsto \begin{pmatrix} \rho_{00} & 0 \\ 0 & \rho_{11} \end{pmatrix}. \quad (4.4)$$

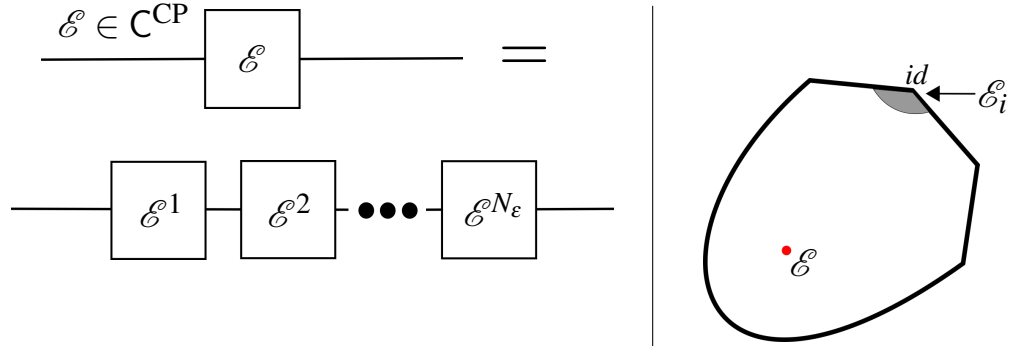

Figure 4.1: Diagrammatic decomposition of channels belonging to \mathcal{L}_{CP} whose closure is C^{CP} , see definition 13. We show the circuit representing the decomposition of \mathcal{E} into channels (left) arbitrarily close to the identity map (right).

This channel is singular, i.e. does not belong to \mathcal{L}_{CP} . Now observe that using the dynamical process, \mathcal{E}_t , given in example 1, one can get arbitrarily close to \mathcal{E}_∞ when $t \rightarrow \infty$, i.e. $\mathcal{E}_\infty = \lim_{t \rightarrow \infty} \mathcal{E}_t$. Note that $\mathcal{E}_t \in \mathcal{L}_{\text{CP}}$ for every $t \in \mathbb{R}^+$, see theorem 14, therefore \mathcal{E}_∞ is an accumulation point of \mathcal{L}_{CP} . Thus, the closure is taken to define infinitesimal divisible channels, to include channels such as \mathcal{E}_∞ .

Up to this point we have shown that CP-divisible processes are infinitesimal divisible, i.e. CP-divisible processes parametrize families of channels belonging to C^{CP} . In Ref. [WECC08], authors have shown that channels in C^{CP} can always be implemented with CP-divisible processes. This can be roughly shown as follows.

Since C is connected, we can understand infinitesimal channels as the ending point of an arbitrarily small curve parametrized by t , i.e. channels \mathcal{E}_i in definition 13 can be written approximately as $\mathcal{E}_i \approx \text{id} + L_i \approx \exp(L_i)$. We have shown that L_i has Lindblad form, see theorem 14. Therefore we have that if $\mathcal{E} \in C^{\text{CP}}$, it can be written as

$$\mathcal{E} = \prod_i e^{L_i}.$$

Therefore \mathcal{E} can be implemented using a CP-divisible dynamical processes. Bounds of the convergence ratio using channels of the form $\exp(L_i)$ instead of general infinitesimal channels, are computed in Ref. [WECC08].

Analogous to infinitesimal divisible channels in C and its relation with CP-divisible processes, one can also define the following set involving PTP maps.

Definition 14 (Infinitesimal divisible channels in PTP). *Let \mathcal{L}_P be the set con-*

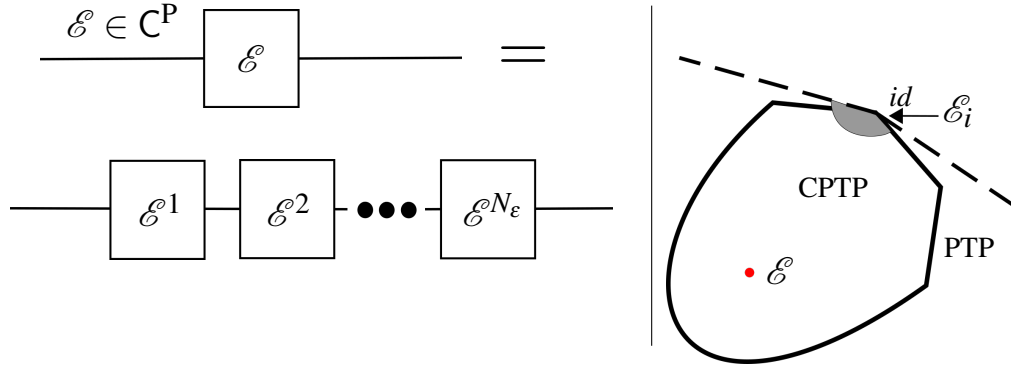

Figure 4.2: Diagrammatic decomposition of channels belonging to \mathcal{L}_P which closure is \mathcal{C}^P , see definition 14. At the left we show the circuit representing the decomposition of \mathcal{E} into channels arbitrarily close to the identity map, see figure at the right. In contrast to figure 4.1, note that infinitesimal channels can be outside the set of CPTP maps, but inside PTP.

taining operations $\mathcal{E} \in \mathcal{C}$ with the property that $\forall \epsilon > 0$ there exist a finite number of channels $\mathcal{E}_i \in PTP$ such that $|\mathcal{E}_i - id| < \epsilon$ and $\mathcal{E} = \prod_i \mathcal{E}_i$, see fig. 4.2. It is said that a channel is infinitesimal divisible in PTP if it belongs to the closure of \mathcal{L}_P . This set is denoted as \mathcal{C}^P .

Infinitesimal divisibility in PTP maps is interesting since this kind of maps can arise in settings where the system is initially correlated with its surroundings, or if the operation is correlated with the initial state [CTZ08].

Infinitesimal divisible (either in CPTP and PTP) channels have non-negative determinant due to its continuity [WECC08]. To see this note that channels arbitrarily close to the identity map have positive determinant; and by its multiplicative property, the channel resulting from the concatenation of infinitesimal channels has non-negative determinant.

Proposition 3 (Determinant of infinitesimal divisible channels). *If a quantum map \mathcal{E} belongs either to \mathcal{C}^P or \mathcal{C}^{CP} , then $\det \mathcal{E} \geq 0$.*

It turns out that a non-negative determinant is a sufficient condition for a channel to be infinitesimal divisible in PTP, see theorem 25 of Ref. [WECC08].

Other interesting type of divisibility that in turn forms a subset of \mathcal{C}^{CP} is the following [WECC08, Den89].

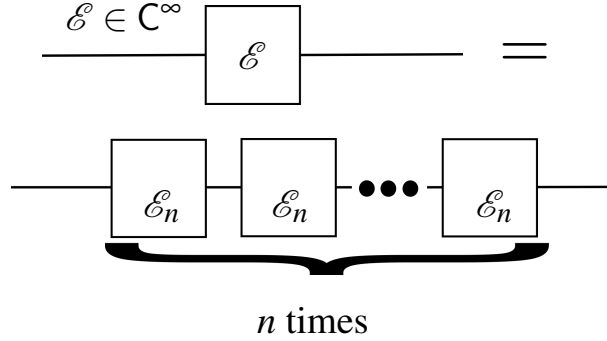

Figure 4.3: Diagrammatic decomposition of channels belonging to \mathbb{C}^∞ , see definition 15. This set contains channels for which every n -root exist and is a valid quantum channel, denoted in the circuit as \mathcal{E}_n .

Definition 15 (Infinitely divisible channels). *A quantum channel \mathcal{E} is infinitely divisible if $\forall n \in \mathbb{Z}^+ \exists \mathcal{E}_n \in \mathbb{C}$ such that $\mathcal{E} = (\mathcal{E}_n)^n$. This set is denoted as \mathbb{C}^∞ , see fig. 4.3.*

This set contains channels for which every n -root exists and is a valid quantum channel. Denisov has shown in [Den89] that infinitely divisible channels can be written as $\mathcal{E} = \mathcal{E}_0 \exp(L)$, with L a Lindblad generator, and an \mathcal{E}_0 idempotent operator that fulfills $\mathcal{E}_0 L \mathcal{E}_0 = \mathcal{E}_0 L$. In this work we will prove that every infinitely divisible Pauli channel has the simple form $\exp(L)$.

Let us now introduce the most restricted type of divisibility studied in this work,

Definition 16 (Channels belonging to one-parameter semigroups (L-divisibility)). *Let \mathcal{L}_L be the set containing non-singular operations $\mathcal{E} \in \mathbb{C}$, such that there exist at least one logarithm, denoted as $L = \log \mathcal{E}$, such that*

$$L[\rho] = i[\rho, H] + \sum_{i,j} G_{ij} \left(F_i \rho F_j^\dagger - \frac{1}{2} \{F_j^\dagger F_i, \rho\} \right), \quad (4.5)$$

where H and G are hermitian with $G \geq 0$, and $\{F_i\}_i$ are bounded operators acting on $\mathcal{T}(\mathcal{H})$. It is said that a channel is L-divisible if it belongs to the closure of \mathcal{L}_L . This set is denoted as \mathbb{C}^L .

Analogous to the relation of CP-divisible dynamical maps and its relations with \mathbb{C}^{CP} , time-independent Markovian processes form families of L-divisible channels. The converse is true by definition. One of the principal objectives of this work is to construct a test to check whether a given channel belongs to \mathbb{C}^L or not.

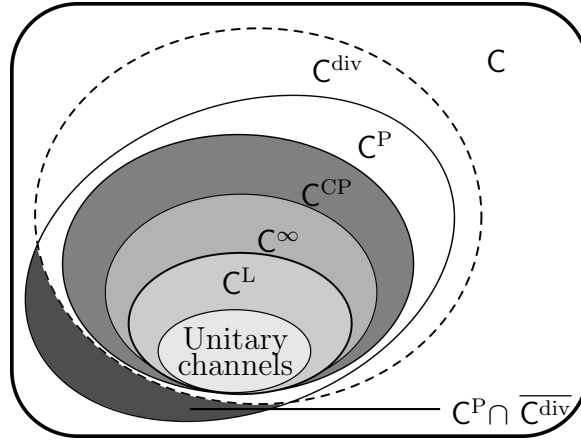

Figure 4.4: Scheme illustrating the different sets of quantum channels for a given dimension. In particular, the inclusion relations presented in eq. (4.6) are depicted. C is the set of completely positive trace preserving operations. The divisibility sets depicted are the ones containing channels infinitesimal divisible in CPTP (C^{CP}), infinitesimal divisible in PTP (C^P), infinite divisible (C^∞), implementable with Lindblad equations (C^L), and unitary channels.

4.1.2 Relation between channel divisibility classes

Let us summarize the introduced divisibility sets and the relations between them. Since channels belonging to C^{CP} can be implemented with time-dependent Lindblad master equations, and time-independent ones are a particular case of time dependent ones, we have $C^L \subset C^{CP}$. Now, since infinitely divisible channels have the form $\mathcal{E}_0 \exp(L)$, channels with form $\exp(L)$ are a particular case of C^∞ , therefore $C^L \subseteq C^\infty$. Also, given that CPTP maps are also PTP, then $C^{CP} \subset C^P$. Finally, every set except C^P is subset of C^{div} , given that an infinitesimal divisible channels in PTP is not necessarily divisible in CPTP channels. In summary we have [WC08],

$$\begin{array}{c} C^\infty \subset C^{CP} \subset C^{div} \\ \cup \\ C^L \subset C^{CP} \subset C^P \end{array} \quad (4.6)$$

The intersection of C^P and C^{div} is not empty since $C^{CP} \subset C^{div}$ and $C^{CP} \subset C^P$, later on we will investigate if $C^P \subseteq C^{div}$ or not. A scheme of the inclusions is given in fig. 4.4.

4.2 Characterization of L-divisibility

Deciding L-divisibility is equivalent to proving the existence of a hermiticity preserving generator, which additionally fulfills the ccp condition, see proposition 2. To prove hermiticity preserving we recall that every HP operator has a real matrix representation when choosing an hermitian basis, see subsection 3.3.1. Since quantum channels preserve hermiticity, the problem is reduced to find a real logarithm $\log \hat{\mathcal{E}}$ given a real matrix $\hat{\mathcal{E}}$, where the hat means that \mathcal{E} is written using an hermitian basis. This problem was already solved by Culver [Cul66] who characterized completely the existence of real logarithms of real matrices. In this work we restrict the analysis to diagonalizable channels. The results can be summarized as follows.

Theorem 15 (Existence of hermiticity preserving generator). *A non-singular matrix with real entries $\hat{\mathcal{E}}$ has a real generator (i.e. a $\log \hat{\mathcal{E}}$ with real entries) if and only if the spectrum fulfills the following conditions: i) negative eigenvalues are even-fold degenerate; ii) complex eigenvalues come in complex conjugate pairs.*

We now discuss the multiplicity of the solutions of $\log \hat{\mathcal{E}}$ and its parametrization, as finding an appropriate one is essential to test for the ccp condition. If $\hat{\mathcal{E}}$ has positive degenerate, negative, or complex eigenvalues, its real logarithms are not unique, and are spanned by *real logarithm branches* [Cul66]. The latter are defined using the real quaternion, which coincides with $i\sigma_y$, using the fact that $\mathbb{1} = \exp(i\sigma_y 2\pi k)$, with $k \in \mathbb{Z}$. In case of having negative eigenvalues, it turns out that real logarithms always have a continuous parametrization, in addition to real branches due to the freedom of the Jordan normal form transformation matrices [Cul66].

To compute the logarithm given a real representation of \mathcal{E} , i.e. $\hat{\mathcal{E}}$, we calculate its Jordan normal form, J , such that $\hat{\mathcal{E}} = wJw^{-1} = \tilde{w}J\tilde{w}^{-1}$, where $w = \tilde{w}K$ and K belongs to a continuum of matrices that commute with J [Cul66]. In the case of diagonalizable matrices, if there are no degeneracies, K commutes with $\log(J)$. In the case of having degeneracies, matrix K is responsible of the continuous parametrization of the logarithm. We compute explicitly the logarithms for the case of Pauli channels in section 4.3.4.

4.3 Divisibility of unital qubit channels

We will apply various of the results from the literature [WECC08] to decide if a given unital qubit channel belongs to C^L , C^{CP} and/or C^P . The non-unital case will be discussed later.

Before starting with the characterization let us point out the following. From the definition of divisibility, the concatenation of a given channel with unitary conjugations (which are infinitesimal divisible) do not change its divisibility character, except for L-divisibility. In addition to this, since unitary conjugations are infinitesimal divisible, they do not change the infinitesimal divisible character either. We can summarize this in the following,

Proposition 4 (Divisibility of special orthogonal normal forms). *Let \mathcal{E} a qubit quantum channel and \mathcal{D} its special orthogonal normal form, \mathcal{E} belongs to C^X if and only if \mathcal{D} does, where $X = \{\text{“Div”}, \text{“P”}, \text{“CP”}\}$.*

This proposition is in fact a consequence of theorem 17 of Ref. [WECC08]. Notice that this result does not apply for C^L since conjugating with unitaries breaks the implementability by means of time-independent Lindblad master equations. Thus, if a channel belongs to C^L , unitary conjugations can bring it to $C^{Inf} \setminus C^L$ and vice versa.

Therefore, by proposition 4 and the theorem 9, to study C^P and C^{CP} of unital qubit channels, it is enough to study Pauli channels.

4.3.1 Channels belonging to C^{div}

Divisibility in CPTP of unital qubit channels is completely characterized by means of theorem 13. Therefore the only indivisible channels lie in the faces of the tetrahedron (without the edges), see fig. 4.5.

4.3.2 Channels belonging to C^P

Recalling that all unital qubit channels belonging to C^P have non-negative determinant [WC08], and using special orthogonal normal forms, see theorem 9, the condition in terms of its parameters is given by

$$\lambda_1 \lambda_2 \lambda_3 \geq 0. \quad (4.7)$$

This set is the intersection of the tetrahedron with the octants where the product of all λ s is positive. In fact, it consists of four triangular bipyramids starting in each vertex of the tetrahedron and meeting in its center, see fig. 4.5. Let us study the intersection of this set with the set of unital entanglement-breaking (EB) channels [ZB05], see definition 5. In the case of unital qubit channels, the set entanglement-breaking channels is an octahedron that lie inside the tetrahedron of unital qubit channels, see fig. 4.6. The inequalities that define such octahedron are the following,

$$\lambda_i \pm (\lambda_j + \lambda_k) \leq 1, \quad (4.8)$$

with i, j and k all different [ZB05], together eq. (3.11). It follows that unital qubit channels that are not achieved by P-divisible dynamical maps are necessarily entanglement-breaking (see fig. 4.6 and fig. 4.9). In fact this holds for general qubit channels, see section 4.4.

4.3.3 Channels belonging to C^{CP}

To characterize CP-divisible channels it is useful to consider the Lorentz normal form for channels, see theorem 10. A remarkable property of the Lorentz normal decomposition is that it preserves the infinitesimal divisible character of \mathcal{E} , see Corollary 13 of [WC08]. To use it, we resort to theorem 24 of Ref. [WC08]. Due to the mentioned drawback of Lorentz normal forms, see appendix B, we must modify such to theorem to a restricted class of channels.

Theorem 16 (Restricted characterization of channels belonging to C^{CP}). *A qubit channel \mathcal{E} with diagonal Lorentz normal form belongs to C^{CP} if and only if*

- i) the rank of the form is smaller than three or*
- ii) $s_{\min}^2 \geq s_1 s_2 s_3 > 0$, where s_{\min} is the smallest of s_1, s_2 and s_3 , see theorem 10.*

For non-unital Kraus deficient channels, the pertinent theorems are based on non-diagonal Lorentz normal forms [VV02, WC08]. According to our appendix B such results should be reviewed and are out of the scope of this work.

Notice that the Lorentz normal form coincides with the special orthogonal normal form for unital qubit channels. Therefore, by theorem 16, unital channels belonging to C^{CP} are non-singular with

$$0 < \lambda_1 \lambda_2 \lambda_3 \leq \lambda_{\min}^2, \quad (4.9)$$

or singular with a matrix rank less than three. They determine a body that is symmetric with respect to permutation of Pauli unitary channels (i.e. in λ_j), hence,

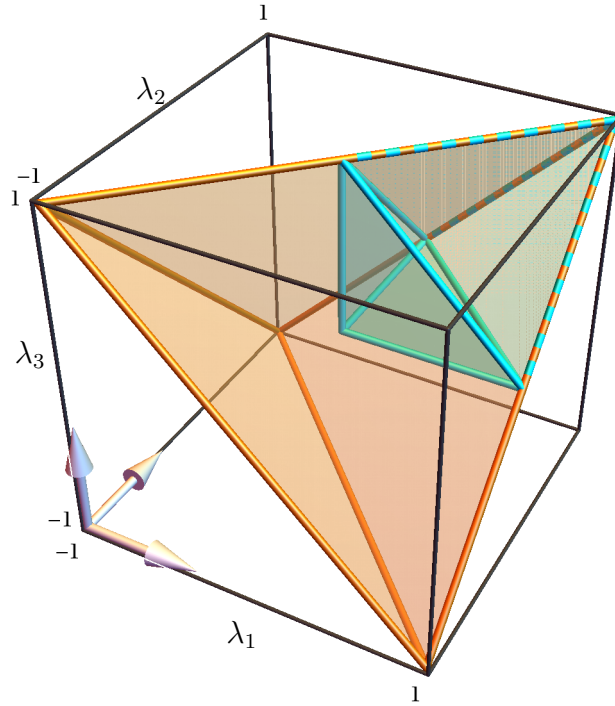

Figure 4.5: Tetrahedron of Pauli channels, see fig. 3.1. The bipyramid in blue correspond to channels with $\lambda_i > 0 \forall i$, i.e. channels of the positive octant belonging to C^P . The whole set C^P includes other three bipyramids corresponding to the other vertexes of tetrahedron. This implies that C^P enjoys the symmetries of the tetrahedron, see eq. (4.7). The faces of the bipyramids matching the corners of the tetrahedron are subsets of the faces of the tetrahedron, i.e. contain Kraus rank three channels. Such channels are both C^P and $\overline{C^{\text{div}}}$, showing that the intersection shown in fig. 4.4 is not empty.

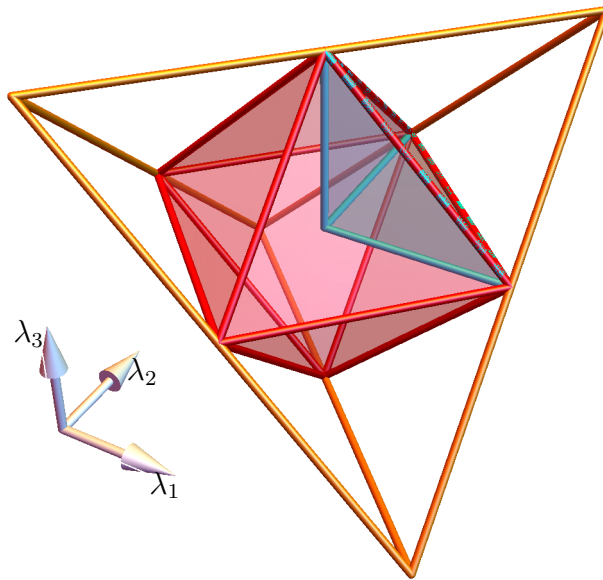

Figure 4.6: Tetrahedron of Pauli channels with the octahedron of entanglement breaking channels shown in red, see eq. (4.8). The blue pyramid inside the octahedron is the intersection of the bipyramid shown in 4.5, with the octahedron. The complement of the intersections of the four bipyramids forms the set of divisible but not infinitesimal divisible channels in PTP. Thus, a central feature of the figure is that the set $C^{\text{div}} \setminus C^{\text{P}}$ is always entanglement-breaking, but the converse is not true.

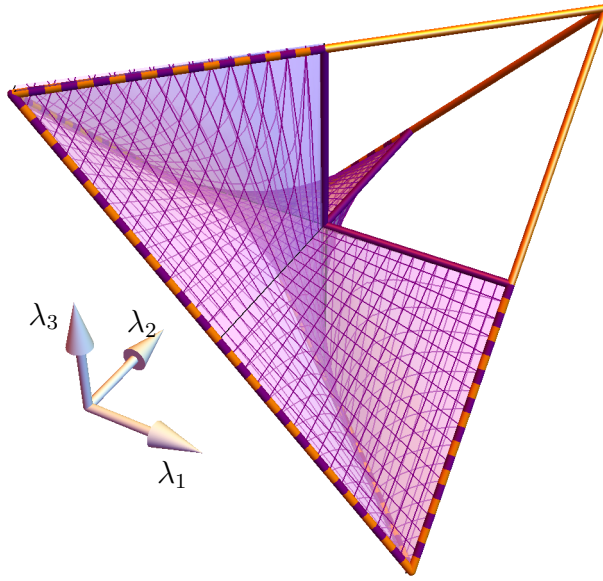

Figure 4.7: Tetrahedron of Pauli channels with part of the set of CP-divisible, see eq. (4.9), but not L-divisible channels ($C^{\text{CP}} \setminus C^{\text{L}}$) shown in purple. The whole set C^{CP} is obtained applying the symmetry transformations of the tetrahedron to the purple volume.

the set of C^{CP} of Pauli channels possesses the symmetries of the tetrahedron. The set $C^{\text{CP}} \setminus C^{\text{L}}$ is plotted in fig. 4.7.

4.3.4 L-divisible unital qubit channels

We restrict our analysis of L-divisibility for two particular sets of unital channels, Pauli channels and a family with complex eigenvalues that will be introduced later.

Pauli channels with non-degenerate positive eigenvalues

First let us now derive the conditions for L-divisibility of Pauli channels with positive eigenvalues $\lambda_1, \lambda_2, \lambda_3$ ($\lambda_0 = 1$). The logarithm of \mathcal{D} , induced by the principal logarithm of its eigenvalues is

$$L = K \text{diag}(0, \log \lambda_1, \log \lambda_2, \log \lambda_3) K^{-1}, \quad (4.10)$$

which is real (hermiticity preserving). In case of no-degeneration the dependency on K vanishes and L is unique. In such case the ccp conditions, see theorem 2, read

$$\log \lambda_i - \log \lambda_j - \log \lambda_k \geq 0 \Rightarrow \frac{\lambda_i}{\lambda_j \lambda_k} \geq 1 \quad (4.11)$$

for all combinations of mutually different i, j, k . This set (channels belonging to C^L with positive eigenvalues) forms a three dimensional manifold, see fig. 4.8.

Pauli channels with degenerate positive eigenvalues

In case of degeneration, let us label the eigenvalues η , λ and λ . In this case, the real solution for L is not unique and is parametrized by real branches in the degenerate subspace and by the continuous parameters of K [Cul66]. Let us study the principal branch with $K = \mathbb{1}$. Eq. (4.11) is then reduced to

$$\lambda^2 \leq \eta \leq 1. \quad (4.12)$$

Therefore, if this inequalities are fulfilled, the generator has Lindblad form. If not, then *a priori* other branches can fulfill ccp condition and consequently have a Lindblad form. Thus, Eq. (4.12) provides a sufficient condition for the channel to be in C^L . We will prove it is also necessary.

The complete positivity condition requires $\eta, \lambda \leq 1$, thus, it remains to verify only the condition $\lambda^2 \leq \eta$. It holds trivially for the case $\lambda \leq \eta$. If $\eta \leq \lambda$, then this condition coincides with the CP-divisibility condition from eq. (4.9). Since C^L implies C^{CP} the proof is completed. In conclusion, the condition in eq. (4.11) is a necessary and sufficient for a given Pauli channel with positive eigenvalues to belong to C^L .

Let us stress that the obtained subset of L-divisible channels does not possess the tetrahedron symmetries. In fact, composing \mathcal{D} with a σ_z rotation

$$\mathcal{U}_z = \text{diag}(1, -1, -1, 1)$$

results in the Pauli channel $\mathcal{D}' = \text{diag}(1, -\lambda_1, -\lambda_2, \lambda_3)$. Clearly, if λ_j are positive (\mathcal{D} is L-divisible), then \mathcal{D}' has non-positive eigenvalues. Moreover, if all λ_j are different, then \mathcal{D}' does not have any real logarithm, therefore, it cannot be L-divisible. In conclusion, the set of L-divisible unital qubit channel is not symmetric with respect to tetrahedron symmetries.

Pauli channels with negative eigenvalues

In what follows we will investigate the case of negative eigenvalues. Theorem 15 implies that that eigenvalues have the form (modulo permutations) $\eta, -\lambda, -\lambda$, where $\eta, \lambda > 0$. The corresponding Pauli channels are

$$\mathcal{D}_x = \text{diag}(1, \eta, -\lambda, -\lambda), \quad \mathcal{D}_y = \text{diag}(1, -\lambda, \eta, -\lambda), \quad \mathcal{D}_z = \text{diag}(1, -\lambda, -\lambda, \eta),$$

thus forming three two-dimensional regions inside the tetrahedron. Take, for instance, \mathcal{D}_z that specifies a plane (inside the tetrahedron) containing I, σ_z and completely depolarizing channel $\mathcal{N} = \text{diag}(1, 0, 0, 0)$. The real logarithms for this case are given by

$$L = K \begin{pmatrix} 0 & 0 & 0 & 0 \\ 0 & \log(\lambda) & (2k+1)\pi & 0 \\ 0 & -(2k+1)\pi & \log(\lambda) & 0 \\ 0 & 0 & 0 & \log(\eta) \end{pmatrix} K^{-1}, \quad (4.13)$$

where $k \in \mathbb{Z}$ and K , as mentioned above, belongs to a continuum of matrices that commute with \mathcal{D}_z . Note that L is always non-diagonal. For this case (similarly for \mathcal{D}_x and \mathcal{D}_y) the ccp condition reduces again to conditions specified in Eq. (4.12). Using the same arguments one arrives to more general conclusion:

Theorem 17 (L-divisibility of Pauli channels). *Let \mathcal{E} be a non-singular Pauli channel. It belongs to \mathcal{C}^L if and only if its non-trivial eigenvalues fulfill*

$$\frac{\lambda_i}{\lambda_j \lambda_k} \geq 0 \quad (4.14)$$

for i, j and k mutually different.

This is one of the central results of this work, and it implies that for testing L-divisibility of Pauli channels, it is enough to consider the principal real logarithm branch and $K = \mathbb{1}$. The singular cases are included in the closure of channels fulfilling eq. (4.14). The set of L-divisible Pauli channels is illustrated in fig. 4.8. To get a detailed picture of the position and inclusions of the divisibility sets, we illustrate in fig. 4.9 two slices of the tetrahedron where different types of divisibility are visualized. Notice the non-convexity of the considered divisibility sets.

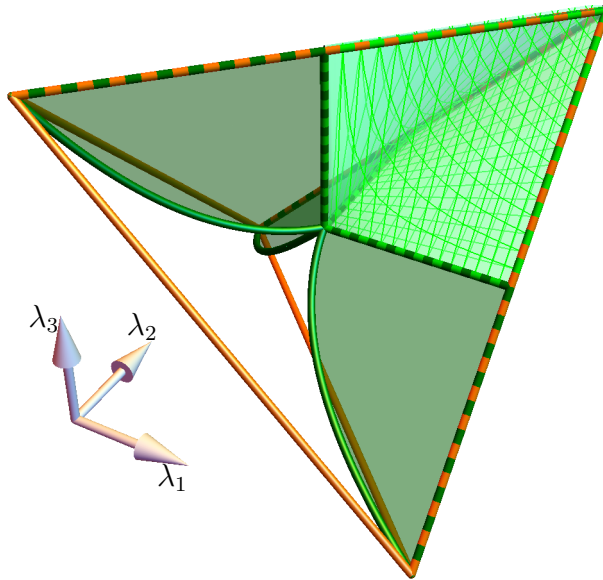

Figure 4.8: Tetrahedron of Pauli channels with the set of L-divisible channels (or equivalently infinitely divisible, see Theorem 19) shown in green, see equations (4.11) and (4.12). The solid set corresponds to channels with positive eigenvalues, and the 2D sets correspond to the negative eigenvalue case. The point where the four sets meet correspond to the *total depolarizing* channel. Notice that this set *does not* have the symmetries of the tetrahedron.

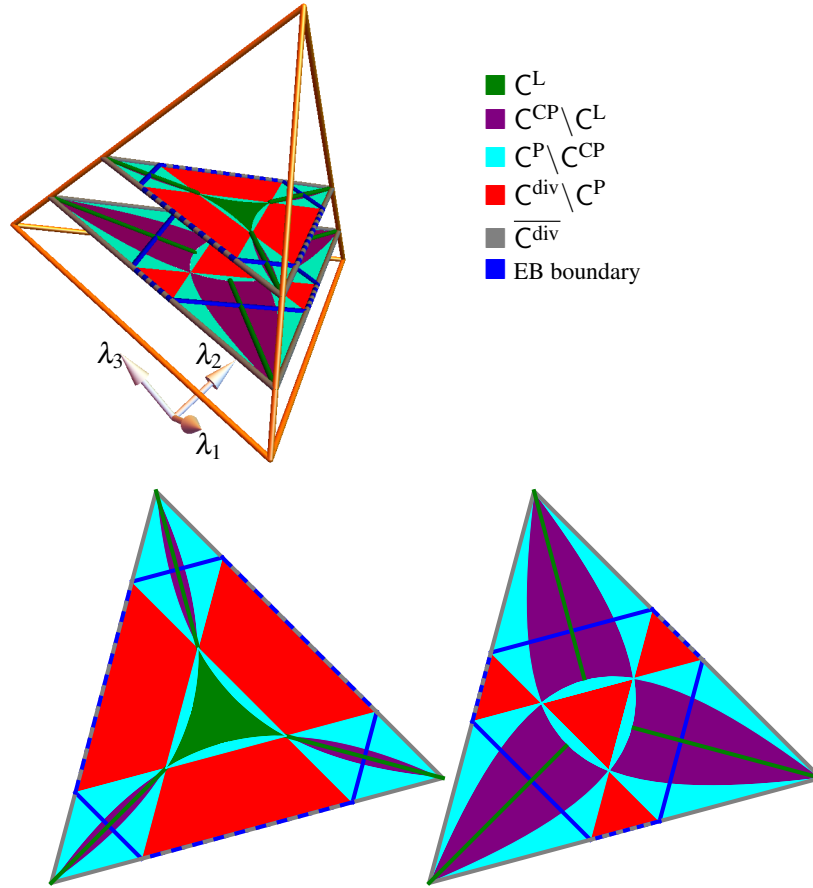

Figure 4.9: We show two slices of the unitary tetrahedron (figure in the left) determined by $\sum_i \lambda_i = 0.4$ (shown in the center) and $\sum_i \lambda_i = -0.4$ (shown in the right). The non-convexity of the divisibility sets can be seen, including the set of indivisible channels. The convexity of sets C and entanglement breaking channels can also be noticed in the slices. A central feature is that the set $C^{\text{div}} \setminus C^P$ is always inside the octahedron of entanglement breaking channels.

Family of unital channels with complex eigenvalues

To give an insight to the case of complex eigenvalues, consider the following family of channels with real logarithm, written in the Pauli basis,

$$\mathcal{E}_{\text{complex}} = \begin{pmatrix} 1 & 0 & 0 & 0 \\ 0 & c & 0 & 0 \\ 0 & 0 & a & -b \\ 0 & 0 & b & a \end{pmatrix}. \quad (4.15)$$

The latter has complex eigenvalues $a \pm ib$ and a real one $c > 0$, together with the trivial eigenvalue equal to 1. Its real logarithm is given by,

$$\begin{aligned} L &= K \log(\mathcal{E}_{\text{complex}})_k K^{-1} \\ &= K \begin{pmatrix} 0 & 0 & 0 & 0 \\ 0 & \log(c) & 0 & 0 \\ 0 & 0 & \log(|z|) & \arg(z) + 2\pi k \\ 0 & 0 & -\arg(z) - 2\pi k & \log(|z|) \end{pmatrix} K^{-1} \end{aligned}$$

with $z = a + ib$. The non-diagonal block of the logarithm has the same structure of $\mathcal{E}_{\text{complex}}$, so K also commutes with $\log(\mathcal{E}_{\text{complex}})_k$, leading to a countable parametric space of hermitian preserving generators. The ccp condition, see proposition 2, is reduced to

$$a^2 + b^2 \leq c \leq 1. \quad (4.16)$$

Note that it does not depend on k and the second inequality is always fulfilled for CPTP channels. The set containing them is shown in fig. 4.10.

4.3.5 Relation of L-divisibility with other divisibility classes

Consider a Pauli channel with $0 < \lambda_{\min} = \lambda_1 \leq \lambda_2 \leq \lambda_3 < 1$, thus the condition $\lambda_1 \lambda_2 \leq \lambda_3$ trivially holds. Since $\lambda_1 \lambda_2 \leq \lambda_1 \lambda_3 \leq \lambda_2 \lambda_3 \leq \lambda_2$, it follows that $\lambda_1 \lambda_3 \leq \lambda_2$, thus, two (out of three) L-divisibility conditions hold always for Pauli channels with positive eigenvalues. Moreover, one may observe that CP-divisibility condition eq. (4.9) reduces to one of L-divisibility conditions $\lambda_2 \lambda_3 \leq \lambda_1$. In conclusion, the conditions of CP-divisibility and L-divisibility for Pauli channels with positive eigenvalues coincide, thus, in this case C^{CP} implies C^{L} .

Concatenating (positive-eigenvalues) L-divisible Pauli channels with $\mathcal{D}_{x,y,z}$, one can generate the whole set of C^{CP} Pauli channels. In other words, $\mathcal{D}_{x,y,z}$ brings the body (with vertex in id) shown in fig. 4.8 to the bodies shown in fig. 4.7 (with vertexes x, y, z). Therefore we can formulate the following theorem:

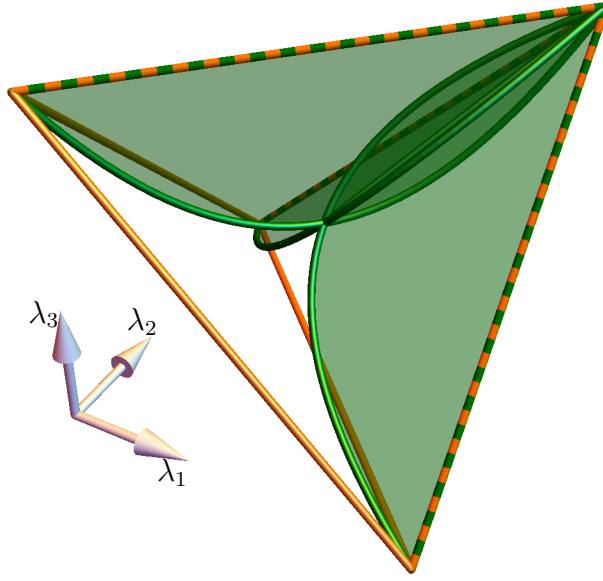

Figure 4.10: Tetrahedron of Pauli channels, with qubit unital L -divisible channels of the form $\hat{\mathcal{E}}_{\text{complex}}$ (see main text). Note that the set does not have the symmetries of the tetrahedron.

Theorem 18 (Infinitesimal divisible unital channels). *Let $\mathcal{E}_{\text{unital}}^{\text{CP}}$ be an arbitrary infinitesimal divisible unital qubit channel. There exists at least one L -divisible Pauli channel $\tilde{\mathcal{E}}$, and two unitary conjugations \mathcal{U}_1 and \mathcal{U}_2 , such that*

$$\mathcal{E}_{\text{unital}}^{\text{CP}} = \mathcal{U}_1 \tilde{\mathcal{E}} \mathcal{U}_2.$$

Notice that if $\mathcal{E}_{\text{unital}}^{\text{CP}}$ is invertible, $\tilde{\mathcal{E}} = e^L$.

Let us continue with another equivalence relation valid for Pauli channels. In general, $\mathcal{C}^L \subset \mathcal{C}^\infty$; however, for Pauli channels these two subsets coincide.

Theorem 19 (Infinitely divisible Pauli channels). *The set of L -divisible Pauli channels is equivalent to the set of infinitely divisible Pauli channels.*

Proof. A channel is infinitely divisible if and only if it can be written as $\mathcal{E}_0 e^L$, where \mathcal{E}_0 is an idempotent channel satisfying $\mathcal{E}_0 L \mathcal{E}_0 = \mathcal{E}_0 L$ and L has Lindblad form, see definition 15. The only idempotent qubit channels are contractions of the Bloch sphere into single points, diagonalization channels $\mathcal{E}_{\text{diag}}$ transforming Bloch sphere into a line connecting a pair of basis states, and the identity channel. Among the single-point contractions, the only one that is a Pauli channel is the

contraction of the Bloch sphere into the complete mixture; let us call it \mathcal{N} . Notice that $\mathcal{E} = \mathcal{N}e^L = \mathcal{N}$ for all L . The channel \mathcal{N} belongs to the closure of \mathbb{C}^L , because a sequence of channels e^{L_n} with $\hat{L}_n = \text{diag}(0, -n, -n, -n)$ converges to $\hat{\mathcal{N}}$ in the limit $n \rightarrow \infty$. For the case of \mathcal{E}_0 being the identity channel we have $\mathcal{E} = e^L$, thus, trivially such infinitely divisible channel \mathcal{E} is in \mathbb{C}^L too. It remains to analyze the case of diagonalization channels. First, let us note that the matrix of e^L is necessarily of full rank, since $\det \hat{\mathcal{E}} \neq 0$. It follows that the matrix $\hat{\mathcal{E}} = \hat{\mathcal{E}}_{\text{diag}} e^L$ has rank two as $\hat{\mathcal{E}}_{\text{diag}}$ is a rank two matrix, thus, it takes one of the following forms $\hat{\mathcal{E}}_x^\lambda = \text{diag}(1, \lambda, 0, 0)$, $\hat{\mathcal{E}}_y^\lambda = \text{diag}(1, 0, \lambda, 0)$, $\hat{\mathcal{E}}_z^\lambda = \text{diag}(1, 0, 0, \lambda)$. The infinite divisibility implies $\lambda > 0$ in order to keep the roots of λ real. In what follows we will show that $\hat{\mathcal{E}}_z$ belongs to (the closure of) \mathbb{C}^L . Let us define the channels $\hat{\mathcal{E}}_z^{\lambda, \varepsilon} = \text{diag}(1, \varepsilon, \varepsilon, \lambda)$ with $\varepsilon > 0$. The complete positivity and ccp conditions translate into the inequalities $\varepsilon \leq \frac{1+\lambda}{2}$ and $\varepsilon^2 \leq \lambda$, respectively; therefore one can always find an $\varepsilon > 0$ such that $\hat{\mathcal{E}}_z^{\lambda, \varepsilon}$ is a L -divisible channel. If we choose $\varepsilon = \sqrt{\lambda}/n$ with $n \in \mathbb{Z}^+$, the channels $\hat{\mathcal{E}}_{z,n}^\lambda = \text{diag}(1, \sqrt{\lambda}/n, \sqrt{\lambda}/n, \lambda)$ form a sequence of L -divisible channels converging to $\hat{\mathcal{E}}_z^\lambda$ when $n \rightarrow \infty$. The analogous reasoning implies that $\hat{\mathcal{E}}_x^\lambda, \hat{\mathcal{E}}_y^\lambda \in \mathbb{C}^L$ too. Let us note that one parameter family \mathcal{E}_z are convex combinations of the complete diagonalization channel $\hat{\mathcal{E}}_z^1 = \text{diag}(1, 0, 0, 1)$ and the complete mixture contraction $\hat{\mathcal{N}}$. This completes the proof. \square

Finally, let us remark that using the theorem 13 we conclude that the intersection $\mathbb{C}^P \cap \overline{\mathbb{C}^{\text{div}}}$ depicted in fig. 4.4 is not empty. To show this, notice that there are channels with positive determinant inside the faces (i.e. \mathbb{C}^P but not \mathbb{C}^{div}), for example $\text{diag}(1, \frac{4}{5}, \frac{4}{5}, \frac{3}{5})$. Therefore we conclude that up to unitaries, $\mathbb{C}^P \cap \overline{\mathbb{C}^{\text{div}}}$ corresponds to the union of the four faces of the tetrahedron minus the faces of the octahedron that intersect with the faces of the tetrahedron, see fig. 4.6. We have to remove such intersection since it corresponds to channels with negative determinant, and thus not in \mathbb{C}^P .

4.4 Non-unital qubit channels

Similar to unital channels, using theorem 4 we are able to characterize \mathbb{C}^{div} , \mathbb{C}^P and \mathbb{C}^{CP} by studying special orthogonal normal forms. Such channels are characterized by $\vec{\lambda}$ and $\vec{\tau}$, see eq. (3.9). Thus, we can study if a channel is \mathbb{C}^{div} by computing the rank of its Choi matrix, see theorem 11. For this case algebraic equations are in general fourth order polynomials. In fact, in Ref. [RPZ18] a condition in terms of the eigenvalues and $\vec{\tau}$ is given. For special cases, however, we

can obtain compact expressions, see fig. 4.11. The characterization of C^P is given by again by the condition $\lambda_1 \lambda_2 \lambda_3 \geq 0$. C^{CP} is tested, for full Kraus rank non-unital channels, using theorem 16, the calculation of s_i 's is done using the algorithm presented in Ref. [VDD01]. For the characterization of C^L we use theorem 15 and evaluate numerically the cpp condition.

We can plot illustrative pictures even though the whole space of qubit channels has 12 parameters. This can be done using special orthogonal normal forms and fixing $\vec{\tau}$, exactly in the same way as the unital case. Recall that unitaries only modify C^L , leaving the shape of other sets unchanged. CPTP channels are represented as a volume inside the tetrahedron presented in fig. 4.5, see fig. 4.11. In the later figure we show a slice corresponding to $\vec{\tau} = (1/2, 0, 0)^T$. Indeed, it has the same structure of the slices for the unital case, but deformed, see fig. 4.9. A difference with respect to the unital case is that L-divisible channels with negative eigenvalues (up to unitaries) are not completely inside CP-divisible channels. A part of them are inside the C^P channels.

A central feature of Figs. 4.9 and 4.11 is that the set $C^{\text{div}} \setminus C^P$ is inside the convex slice of the set of entanglement breaking channels (deformed octahedron). Indeed, we can proof the following theorem.

Theorem 20 (Entanglement-breaking channels and divisibility). *Consider a qubit channel \mathcal{E} . If $\det \tilde{\mathcal{E}} < 0$, then \mathcal{E} is entanglement-breaking, i.e. all qubit channels outside C^P are entanglement breaking.*

Before introducing the proof, let us first show that the proper orthochronous Lorentz transformations present in the Lorentz normal decomposition for channels, see sec. 3.4.2, correspond to 1wSLOCC at the level of their Choi-Jamiołkowski state. Consider a channel \mathcal{E} and its Lorentz normal form $\tilde{\mathcal{E}}$ given by

$$\tilde{\mathcal{E}} = \alpha \mathcal{F}_2 \mathcal{E} \mathcal{F}_1, \quad (4.17)$$

where

$$\mathcal{F}_i : \rho \mapsto X_i \rho X_i^\dagger, \text{ with } X_i \in \text{SL}(2, \mathbb{C}), \quad i = 1, 2,$$

and α is a constant that must be included for $\tilde{\mathcal{E}}$ to be trace preserving, We showed already that $\text{SL}(2, \mathbb{C})$ is a double cover of $\text{SO}^+(3, 1)$, i.e. \mathcal{F}_i 's correspond to the proper orthochronous Lorentz transformations of the decomposition.

Now let us compute the Choi-Jamiołkowski state of $\tilde{\mathcal{E}}$, $\tilde{\tau}$, using the Kraus decom-

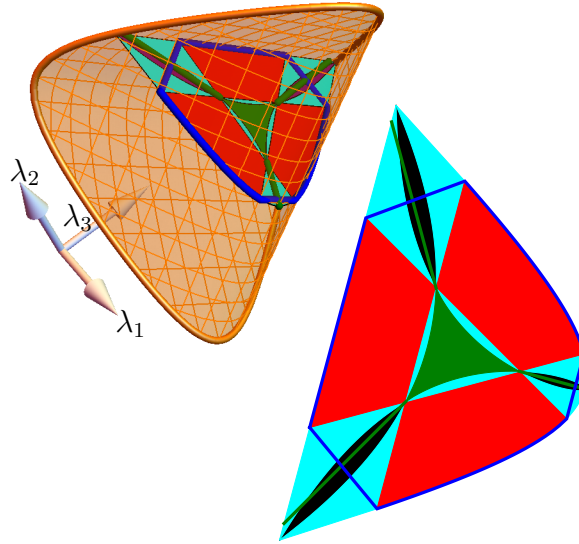

Figure 4.11: (left) Set of non-unital unital channels up to unitaries, defined by $\vec{\tau} = (1/2, 0, 0)$, see eq. (3.9). This set lies inside the tetrahedron. For this particular case the CP conditions reduce to the two inequalities $2 \pm 2\lambda_1 \geq \sqrt{1 + 4(\lambda_2 \pm \lambda_3)^2}$. A cut corresponding to $\sum_i \lambda_i = 0.3$ is presented inside and in the right, see fig. 4.9 for the color coding. The structure of divisibility sets presented here has basically the same structure as for the unital case except for C^L . A part of the channels with negative eigenvalues belonging to C^L lies outside $C^{CP} \setminus C^L$, see green lines. As for the unital case a central feature is that the channels in $C^{div} \setminus C^P$ are entanglement breaking channels. Channels in the boundary are not characterized due to the restricted character of Theorem 10.

position of \mathcal{E} [Wol11],

$$\begin{aligned}
\tilde{\tau} &= \alpha (\text{id}_2 \otimes \mathcal{F}_2 \mathcal{E} \mathcal{F}_1) [\omega] \\
&= \alpha \sum_i (\mathbb{1} \otimes X_2) (\mathbb{1} \otimes K_i) (\mathbb{1} \otimes X_1) |\Omega\rangle \langle \Omega| (\mathbb{1} \otimes X_1^\dagger) (\mathbb{1} \otimes K_i^\dagger) (\mathbb{1} \otimes X_2^\dagger) \\
&= \alpha \sum_i (X_1^T \otimes X_2) (\mathbb{1} \otimes K_i) |\Omega\rangle \langle \Omega| (\mathbb{1} \otimes K_i^\dagger) (\overline{X_1} \otimes X_2^\dagger) \\
&= \alpha (X_1^T \otimes X_2) \tau (X_1^T \otimes X_2)^\dagger,
\end{aligned} \tag{4.18}$$

where $\{K_i\}_i$ are a choice of Kraus operators of \mathcal{E} and

$$\tau = \sum_i (\mathbb{1} \otimes K_i) |\Omega\rangle \langle \Omega| (\mathbb{1} \otimes K_i^\dagger)$$

its Choi-Jamiołkowski matrix. Here, $|\Omega\rangle$ is the Bell state between two copies of the system, in this case a qubit, for which the identity $A \otimes \mathbb{1} |\Omega\rangle = \mathbb{1} \otimes A^T |\Omega\rangle$ holds. It can be observed that eq. (4.18) has exactly the form of the normalized 1wSLOCC scheme, where α turns to be the normalization constant, see eq. (2.27), i.e. $\text{tr} \tilde{\tau} = 1$. That's why we have introduced it at the first place. Now let us proceed with the proof of theorem 20,

Proof. Let \mathcal{E} be a qubit channel with negative determinant and $\hat{\mathcal{E}}$ its matrix representation using the Pauli basis, see eq. (3.7). Recall that the matrix R defining the Choi-Jamiołkowski state of \mathcal{E} ,

$$\tau_{\mathcal{E}} = \frac{1}{4} \sum_{jk} R_{jk} \sigma_j \otimes \sigma_k,$$

and $\hat{\mathcal{E}}$ are related by

$$R = \hat{\mathcal{E}} \Phi_T,$$

where $\Phi_T = \text{diag}(1, 1, -1, 1)$. It follows immediately that R has positive determinant,

$$\det R = -\det \hat{\mathcal{E}} > 0,$$

since $\det \Phi_T = -1$. Using the aforementioned Lorentz normal decomposition for matrix R , we have

$$R = L_1^T \tilde{R} L_2$$

where $\det L_{1,2} > 0$ and $\det \tilde{R} > 0$. Stressing that transformations $L_{1,2}$ correspond to 1wSLOCC (see eq. (4.18)), then \tilde{R} parametrizes an unnormalized two-qubit state.

Let us first discuss the case when \tilde{R} is diagonal. The channel corresponding to \tilde{R} (in the Pauli basis) is

$$\hat{\mathcal{G}} = \tilde{R}\Phi_T/\tilde{R}_{00},$$

where $R_{00} = \text{tr}\tilde{R} = \text{tr}\tau_{\mathcal{G}}$. Since \tilde{R} is diagonal, then \mathcal{G} is a Pauli channel with $\det\hat{\mathcal{G}} < 0$. A Pauli channel has a negative determinant, if either all λ_j are negative, or exactly one of them is negative. In Ref. [ZB05] it has been shown that the set of channels with $\lambda_j < 0 \quad \forall j$ are entanglement breaking channels. Now, using the symmetries of the tetrahedron, one can generate all channels with negative determinant by concatenating this set with the Pauli rotations. Therefore every Pauli channel with negative determinant is entanglement breaking, thus, $\tau_{\mathcal{G}}$ is separable. Given that LOCC operations can not create entanglement [HHHH09], we have that $\tau_{\mathcal{E}}$ is separable, therefore \mathcal{E} is entanglement breaking.

The case when \tilde{R} is non-diagonal corresponds to Kraus deficient channels (the matrix rank of 3.17 is at most 3). This case can be analyzed as follows. Since the neighborhood of any Kraus deficient channel with negative determinant contains full Kraus rank channels, by continuity of the determinant such channels have negative determinant too. The last ones are entanglement breaking since full Kraus rank channels have diagonal Lorentz normal form. Therefore, by continuity of the concurrence [ZB05], Kraus deficient channels with negative determinant are entanglement breaking. \square

4.5 Divisibility transitions and examples with dynamical processes

The aim of this section is to use illustrative examples of quantum dynamical processes to show transitions between divisibility types of the instantaneous channels. From the slices shown above (see figures 4.9 and 4.11) it can be noticed that every transition between the studied divisibility types is permitted. This is due to the existence of common borders between all combinations of divisibility sets; we can think of any continuous line inside the tetrahedron [FPMZ17] as describing some quantum dynamical map.

We analyze two examples. The first is an implementation of the approximate NOT gate, \mathcal{A}_{NOT} throughout a specific collision model [RFZB12]. The second is the well known setting of a two-level atom interacting with a quantized mode of an optical cavity [HR06]. We define a simple function that assigns a particular value

to a channel \mathcal{E}_t according to divisibility hierarchy, i.e.

$$\delta[\mathcal{E}] = \begin{cases} 1 & \text{if } \mathcal{E} \in \mathbb{C}^{\text{L}}, \\ 2/3 & \text{if } \mathcal{E} \in \mathbb{C}^{\text{CP}} \setminus \mathbb{C}^{\text{L}}, \\ 1/3 & \text{if } \mathcal{E} \in \mathbb{C}^{\text{P}} \setminus \mathbb{C}^{\text{CP}}, \\ 0 & \text{if } \mathcal{E} \in \mathbb{C} \setminus \mathbb{C}^{\text{P}}. \end{cases} \quad (4.19)$$

A similar function can be defined to study the transition to/from the set of entanglement-breaking channels, i.e.

$$\chi[\mathcal{E}] = \begin{cases} 1 & \text{if } \mathcal{E} \text{ is entanglement breaking,} \\ 0 & \text{if } \mathcal{E} \text{ if not.} \end{cases} \quad (4.20)$$

The quantum NOT gate is defined as $\text{NOT} : \rho \mapsto \mathbb{1} - \rho$, i.e. it maps pure qubit states to its orthogonal state. Although this map transforms the Bloch sphere into itself it is not a CPTP map, and the closest CPTP map is $\mathcal{A}_{\text{NOT}} : \rho \mapsto (\mathbb{1} - \rho)/3$. This is a rank-three qubit unital channel, thus, it is indivisible [WC08]. Moreover, $\det \mathcal{A}_{\text{NOT}} = -1/27$ implies that this channel is not achievable by a P-divisible dynamical map. It is worth noting that \mathcal{A}_{NOT} belongs to $\overline{\mathbb{C}^{\text{div}}}$.

A specific collision model was designed in Ref. [RFZB12] simulating stroboscopically a quantum dynamical map that implements the approximate quantum NOT gate, \mathcal{A}_{NOT} , in finite time. It is constructed in the following way, any stroboscopically simulable channel can be written as

$$\mathcal{E}_n = \text{tr}_{\text{E}} \left[(U_1 \dots U_n) \rho \otimes \omega_n (U_1 \dots U_n)^\dagger \right],$$

where $U_j = U \otimes \mathbb{1}_{\bar{j}}$ is the unitary corresponding to the bipartite collision with the j th particle, the identity $\mathbb{1}_{\bar{j}}$ is applied in all particles except particle j . The density matrix ω_n is the state of the particles that “collide” with the central system, they are thought as the environment. It can be shown that in the limit $n \rightarrow \infty$, the change of the central system from the j th to the $(j+1)$ th interaction can be made arbitrarily small [RFZB12]. Thus, substituting the integer index j by the continuous parameter t , we have,

$$\mathcal{E}_t[\rho] = \cos^2(t)\rho + \sin^2(t)\mathcal{A}_{\text{NOT}}[\rho] + \frac{1}{2}\sin(2t)\mathcal{F}[\rho], \quad (4.21)$$

where $\mathcal{F}[\rho] = i\frac{1}{3}\sum_j[\sigma_j, \rho]$. It achieves the desired gate \mathcal{A}_{NOT} at $t = \pi/2$.

Let us stress that this dynamical map is unital, i.e. $\mathcal{E}_t[\mathbb{1}] = \mathbb{1}$ for all t , thus, its special orthogonal normal form can be illustrated inside the tetrahedron of Pauli channels, see fig. 4.12. In fig. 4.13 we plot $\delta[\mathcal{E}_t]$, $\chi[\mathcal{E}_t]$ and the value of the $\det \mathcal{E}_t$.

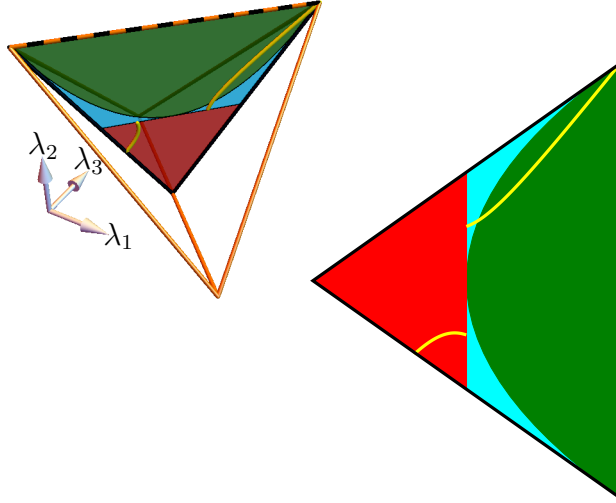

Figure 4.12: (top left) Tetrahedron of Pauli channels with the trajectory, up to rotations, of the quantum dynamical map eq. (4.21) leading to the \mathcal{A}_{NOT} gate, as a yellow curve. (right) Cut along the plane that contains the trajectory; there one can see the different regions where the channel passes. For this case, the characterization of the \mathcal{C}^L of the channels induced gives the same conclusions as for the corresponding Pauli channel, see eq. (3.9). The discontinuity in the trajectory is due to the reduced representation of the dynamical map, see eq. (4.21); the trajectory is continuous in the space of channels. See fig. 4.9 for the color coding.

We see the transitions $\mathcal{C}^L \rightarrow \mathcal{C}^P \setminus \mathcal{C}^{\text{CP}} \rightarrow \mathcal{C}^{\text{div}} \setminus \mathcal{C}^P \rightarrow \overline{\mathcal{C}^{\text{div}}}$ and back. Notice that in both plots the trajectory never goes through the $\mathcal{C}^{\text{CP}} \setminus \mathcal{C}^L$ region. This means that when the parametrized channels, up to rotations, belong to \mathcal{C}^L , so do the original ones. The transition between P-divisible and divisible channels, i.e. $\mathcal{C}^P \setminus \mathcal{C}^{\text{CP}}$ and $\mathcal{C}^{\text{div}} \setminus \mathcal{C}^P$, occurs at the discontinuity in the yellow curve in fig. 4.12. Let us note that this discontinuity only occurs in the space of $\vec{\lambda}$; it is a consequence of the special orthogonal normal decomposition, see eq. (3.9). The complete channel is continuous in the full convex space of qubit CPTP maps. The transition from $\mathcal{C}^P \setminus \mathcal{C}^{\text{div}}$ and back occurs at times $\pi/3$ and $2\pi/3$. It can also be noted that the transition to entanglement breaking channels occurs shortly before the channel enters in the $\mathcal{C}^{\text{div}} \setminus \mathcal{C}^P$ region; likewise, the channel stops being entanglement breaking shortly after it leaves the $\mathcal{C}^{\text{div}} \setminus \mathcal{C}^P$ region, see theorem 20.

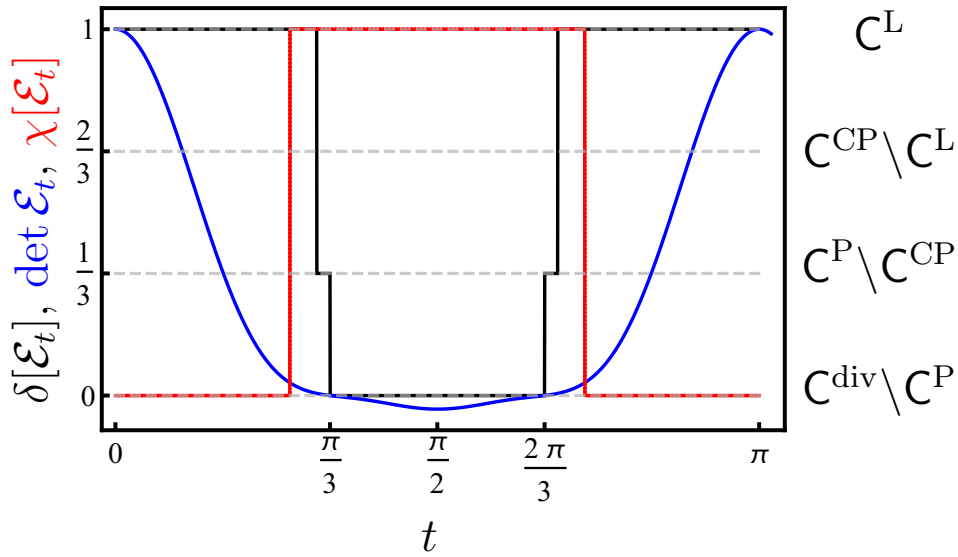

Figure 4.13: Evolution of divisibility, determinant, and entanglement breaking properties of the map induced by eq. (4.21), see eq. (4.19) and eq. (4.20). Notice that the channel \mathcal{A}_{NOT} , implemented at $t = \pi/2$, has minimum determinant. The horizontal gray dashed lines show the image of the function δ , with the divisibility types in the right side. It can be seen that the dynamical map explores the divisibility sets as $\mathbb{C}^L \rightarrow \mathbb{C}^{\text{P}} \setminus \mathbb{C}^{\text{CP}} \rightarrow \mathbb{C}^{\text{div}} \setminus \mathbb{C}^{\text{P}} \rightarrow \overline{\mathbb{C}^{\text{div}}}$ and back. The channels are entanglement breaking in the expected region.

Consider now the dynamical map induced by a two-level atom interacting with a mode of a boson field. This model serves as a workhorse to explore a great variety of phenomena in quantum optics [GKL13]. Using the well known *rotating wave approximation* one arrives to the Jaynes-Cummings model [JC63], whose Hamiltonian is

$$H = \frac{\omega_a}{2} \sigma_z + \omega_f \left(a^\dagger a + \frac{1}{2} \right) + g (\sigma_- a^\dagger + \sigma_+ a). \quad (4.22)$$

By initializing the environment in a coherent state $|\alpha\rangle$, one gets the familiar *collapse and revival* setting. Considering a particular set of parameters shown in fig. 4.14, we constructed the channels parametrized by time numerically, and studied their divisibility and entanglement-breaking properties. In the same figure we plot functions $\delta[\mathcal{E}_t]$ and $\chi[\mathcal{E}_t]$, together with the probability of finding the atom in its excited state $p_e(t)$, to study and compare the divisibility properties with the features of the collapses and revivals. The probability $p_e(t)$ is calculated choosing the ground state of the free Hamiltonian $\omega_a/2\sigma_z$ of the qubit, and it is given by [KC09]:

$$p_e(t) = \frac{\langle \sigma_z(t) \rangle + 1}{2}, \quad (4.23)$$

where

$$\langle \sigma_z(t) \rangle = - \sum_{n=0}^{\infty} P_n \left(\frac{\Delta^2}{4\Omega_n^2} + \left(1 - \frac{\Delta^2}{4\Omega_n^2} \right) \cos(2\Omega_n t) \right),$$

with $P_n = e^{-|\alpha|^2} |\alpha|^{2n} / n!$, $\Omega_n = \sqrt{\Delta^2/4 + g^2 n}$ and $\Delta = \omega_f - \omega_a$ the detuning.

The divisibility indicator function δ exhibits an oscillating behavior, roughly at the same frequency of $p_e(t)$, see inset in fig. 4.14. The figure shows fast periodic transitions between $C^P \setminus C^{CP}$ and $C^{CP} \setminus C^L$ occurring in the region of revivals. There are also few transitions among $C^{CP} \setminus C^P$ and C^L in the second revival. Respect to the entanglement breaking and the function χ , there are no fast transitions in the former, and during revivals, channels are not entanglement breaking. We also observe that channels belonging to $C^{\text{div}} \setminus C^P$ are entanglement breaking, which agrees with theorem 20 for the non-unital case.

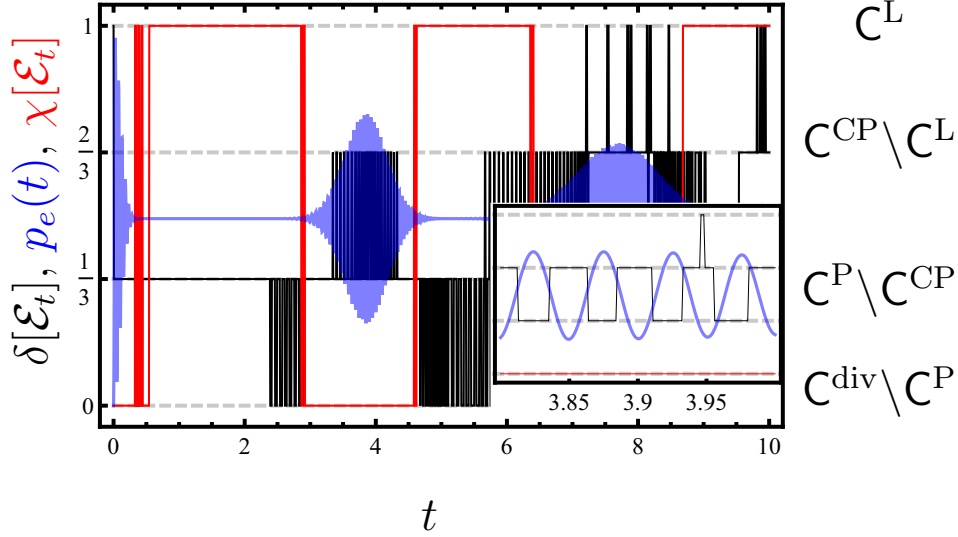

Figure 4.14: Black and red curves show functions δ and χ of the channels induced by the Jaynes-Cummings model over a two-level system, see eq. (4.22) with the environment initialized in a coherent state $|\alpha\rangle$. The blue curve shows the probability of finding the two-level atom in its excited state, $p_e(t)$. The figure shows that the fast oscillations in δ occur roughly at the same frequency as the ones of $p_e(t)$, see the inset. Notice that there are fast transitions between $C^P \setminus C^{CP}$ and $C^{CP} \setminus C^L$ occurring in the region of revivals, with a few transitions between $C^{CP} \setminus C^P$ and C^L in the second revival. The function χ shows that during revivals channels are not entanglement breaking, but we find that channels belonging to $C^{\text{div}} \setminus C^P$ are always entanglement breaking, in agreement with theorem 20. The particular chosen set of parameters are $\alpha = 6$, $g = 10$, $\omega_a = 5$, and $\omega_f = 20$.

Chapter 5

Singular Gaussian quantum channels

Self-education is, I firmly believe, the only kind of education there is.
Isaac Asimov

In this chapter we derive the conditions for δGQC to be singular, see sec. 3.5.1. In particular we will show that only the functional form involving one Dirac delta can be singular, together with the Gaussian form. Additionally we derive, for the non-singular cases, the conditions for the existence of master equations that parametrize channels that have always the same functional form. We do this by letting the channels parameters to depend on time.

5.1 Allowed singular forms

There are two classes of Gaussian singular channels. Since the inverse of a Gaussian channel $\mathcal{A}(\mathbf{T}, \mathbf{N}, \vec{\tau})$ is $\mathcal{A}(\mathbf{T}^{-1}, -\mathbf{T}^{-1}\mathbf{N}\mathbf{T}^{-T}, -\mathbf{T}^{-1}\vec{\tau})$, its existence rests on the invertibility of \mathbf{T} . Therefore, studying the rank of the latter we are able to explore singular forms. We are going to use the classification of one-mode channels developed by Holevo [Hol07]. For singular channels there are two classes characterized by its *canonical form* [Hol08], i.e. any channel can be obtained by applying Gaussian unitaries before and after the canonical form. The class called “ A_1 ” corresponds to singular channels with $\text{Rank}(\mathbf{T}) = 0$ and coincide with the family of *total depolarizing channels*. The class “ A_2 ” is characterized by $\text{Rank}(\mathbf{T}) = 1$.

Both channels are entanglement-breaking [Hol08].

Before analyzing the functional forms constructed in this work, let us study channels with GF. The tuple of the affine transformation, corresponding to the propagator J_G , eq. (2.31), were introduced in Ref. [MP12] up to some typos. Our calculation for this tuple, following eq. (3.35), is:

$$\begin{aligned} \mathbf{T}_G &= \begin{pmatrix} -\frac{b_4}{b_3} & \frac{1}{b_3} \\ \frac{b_1 b_4}{b_3} - b_2 & -\frac{b_1}{b_3} \end{pmatrix}, \\ \mathbf{N}_G &= \begin{pmatrix} \frac{2a_3}{b_3^2} & \frac{a_2}{b_3} - \frac{2a_3 b_1}{b_3^2} \\ \frac{a_2}{b_3} - \frac{2a_3 b_1}{b_3^2} & -2 \left(-\frac{a_3 b_1^2}{b_3^2} + \frac{a_2 b_1}{b_3} - a_1 \right) \end{pmatrix}, \\ \vec{\tau}_G &= \left(-\frac{c_2}{b_3}, \frac{b_1 c_2}{b_3} - c_1 \right)^T. \end{aligned} \quad (5.1)$$

It is straightforward to check that for $b_2 = 0$, \mathbf{T}_G is singular with $\text{Rank}(\mathbf{T}_G) = 1$, i.e. it belongs to class A_2 . Due to the full support of Gaussian functions, it was surprising that Gaussian channels with GF have singular limit. In this case the singular behavior arises from the lack of a Fourier factor for $x_f r_i$, see eq. (2.31). This is the only singular case for GF.

Now we analyze functional forms derived in sec. 3.5.1. The complete positivity conditions of the form \tilde{J}_{III} , presented in eq. (3.45), have no solution for $\alpha \rightarrow 0$ and/or $\gamma \rightarrow 0$, thus, this form cannot lead to singular channels. This is not the case for \tilde{J}_1 , eq. (3.36), which leads to singular operations belonging to class A_2 for

$$\alpha e_2 = 0, \quad (5.2)$$

and to class A_1 for

$$e_2 = \alpha = b_2 = 0. \quad (5.3)$$

For the latter, the complete positivity conditions, see eq. (3.40), read:

$$e_1 \leq a_1. \quad (5.4)$$

By using an initial state characterized by σ_i and \vec{d}_i we can compute the explicit dependence of the final states on the initial parameters. The final states for channels of class A_2 with the functional form involving one delta, see eq. (3.25), and

with $e_2 = 0$, are

$$\begin{aligned}
(\sigma_f)_{11} &= \frac{1}{2e_1}, \\
(\sigma_f)_{22} &= \left(\frac{\alpha}{\beta}\right)^2 \left(\frac{b_3^2}{2e_1} + 2a_3\right) + \frac{\alpha}{\beta} \left(2a_2 + \frac{b_1 b_3}{e_1}\right) + 2a_1 + \frac{b_1^2}{2e_1} + s_1, \\
(\sigma_f)_{12} &= -\frac{\alpha b_3}{\beta 2e_1} - \frac{b_1}{2e_1}, \\
\vec{d}_f(s_3) &= \left(0, -\frac{\alpha}{\beta} c_2 - c_1 + s_2\right)^T,
\end{aligned} \tag{5.5}$$

where

$$\begin{aligned}
s_1 &= \left(b_2^2 + 2\frac{\alpha}{\beta} b_2 b_4 + \left(\frac{\alpha}{\beta}\right)^2 b_4^2\right) (\sigma_i)_{11} - 2 \left(\frac{\alpha}{\beta} b_2 + \left(\frac{\alpha}{\beta}\right)^2 b_4\right) (\sigma_i)_{12} \\
&\quad + \left(\frac{\alpha}{\beta}\right)^2 (\sigma_i)_{22}, \\
s_2 &= \left(\frac{\alpha}{\beta} b_4 + b_2\right) (d_i)_1 - \frac{\alpha}{\beta} (d_i)_2.
\end{aligned} \tag{5.6}$$

For the same functional form but now with $\alpha = 0$, the final states are

$$\begin{aligned}
(\sigma_f)_{11} &= \frac{e_2^2}{4e_1^2} (\sigma_i)_{11} + \frac{1}{2e_1}, \\
(\sigma_f)_{12} &= \left(\frac{b_2 e_2}{2e_1} - \frac{b_1 e_2^2}{4e_1^2}\right) (\sigma_i)_{11} - \frac{b_1}{2e_1}, \\
(\sigma_f)_{22} &= 2a_1 + \left(b_2 - \frac{b_1 e_2}{2e_1}\right)^2 (\sigma_i)_{11} + \frac{b_1^2}{2e_1},
\end{aligned} \tag{5.7}$$

and

$$\vec{d}_f = \left(\frac{e_2}{2e_1} (\vec{d}_i)_1, \left(b_2 - \frac{b_1 e_2}{2e_1}\right) (\vec{d}_i)_1 - c_1\right)^T. \tag{5.8}$$

The explicit formulas of the final states for channels of class A_2 with Gaussian

form are

$$\begin{aligned}
(\sigma_f)_{11}(s_1) &= \frac{2a_3}{b_3^2} + s_1, \\
(\sigma_f)_{12}(s_1) &= \frac{a_2}{b_3} - \frac{2a_3b_1}{b_3^2} - b_1s_1, \\
(\sigma_f)_{22}(s_1) &= \frac{b_1(b_3(b_1b_3s_1 - 2a_2) + 2a_3b_1)}{b_3^2} + 2a_1, \\
\vec{d}_f(s_2) &= \left(s_2 - \frac{c_2}{b_3}, b_1 \left(\frac{c_2}{b_3} - s_2 \right) - c_1 \right)^T, \tag{5.9}
\end{aligned}$$

where

$$\begin{aligned}
s_1 &= \frac{b_4^2}{b_3^2} (\sigma_i)_{11} - \frac{2b_4}{b_3^2} (\sigma_i)_{12} + \frac{1}{b_3^2} (\sigma_i)_{22}, \\
s_2 &= \frac{1}{b_3} (d_i)_2 - \frac{b_4}{b_3} (d_i)_1. \tag{5.10}
\end{aligned}$$

See fig. 5.1 for an schematic description of the final states. From such combinations it is obvious that we cannot solve for the initial state parameters given a final state as expected; this is because the parametric space dimension is reduced from 5 to at most 3. The channel belonging to A_1 [see eq. (3.42) with $e_2 = \alpha = b_2 = 0$ and eq. (5.4)] maps every initial state to a single one characterized by $\sigma_f = \mathbf{N}$ and $\vec{d}_f = (0, -c_1)^T$, see fig. 5.2 for a schematic description.

According to our ansätze [see equations (3.24) and (3.25)], we conclude that one-mode SGQC can only have the functional forms given in eq. (2.31) and eq. (3.24). This is the central result of this chapter and can be stated as:

Theorem 21 (One-mode singular Gaussian channels). *A one-mode Gaussian quantum channel is singular if and only if it has one of the following functional forms in the position space representation:*

1. $\frac{b_3}{2\pi} \exp \left[\imath \left(b_1x_f r_f + b_3x_i r_f + b_4x_i r_i + c_1x_f + c_2x_i \right) - a_1x_f^2 - a_2x_f x_i - a_3x_i^2 \right],$
2. $|\beta| \sqrt{e_1/\pi} \delta(\alpha x_f - \beta x_i) \exp \left[-a_2x_f x_i - a_1x_f^2 - a_3x_i^2 \right. \\ \left. + \imath \left(b_2x_f r_i + b_3r_f x_i + b_1r_f x_f + b_4r_i x_i + c_1x_f + c_2x_i \right) - e_1r_f^2 - e_2r_f r_i - \frac{e_2^2 r_i^2}{4e_1} \right],$
with $e_2\alpha = 0$.

Corollary 1 (Singular classes). *A one-mode singular Gaussian channel belongs to class A_1 if and only if its position representation has the following form:*

$$\sqrt{e_1/\pi} \delta(x_i) \exp \left[-a_1x_f^2 + \imath \left(b_2x_f r_i + b_1r_f x_f + c_1x_f \right) - e_1r_f^2 \right].$$

Otherwise the channel belongs to class A_2 .

Since channels on each class are connected each other by unitary conjugations [Hol07], a consequence of the theorem and the subsequent corollary is that the set of allowed forms must remain invariant under unitary conjugations. To show this we must know the possible functional forms of Gaussian unitaries. They are given by the following lemma for one mode:

Lemma 1 (One-mode Gaussian unitaries). *Gaussian unitaries can have only GF or the one given by eq. (3.25).*

Proof. Recalling that for a unitary GQC, \mathbf{T} must be symplectic ($\mathbf{T}\Omega\mathbf{T}^T = \Omega$) and $\mathbf{N} = \mathbf{0}$. However, an inspection to eq. (3.37) lead us to note that $\mathbf{N} \neq \mathbf{0}$ unless e_1 diverges. Thus, Gaussian unitaries cannot have the form J_I [see eq. (3.24)]. An inspection of matrices \mathbf{T} and \mathbf{N} of GQC with GF [see eq. (5.1)] and the ones for J_{II} [see equations (3.38) and (3.44)] lead us to note the following two observations: (i) in both cases we have $\mathbf{N} = 0$ for $a_n = 0 \quad \forall n$; (ii) the matrix \mathbf{T} is symplectic for GF when $b_2 = b_3$, and when $\alpha\eta = \beta\gamma$ for J_{II} . In particular the identity map has the last form. This completes the proof. \square

One can now compute the concatenations of the SGQCs with Gaussian unitaries. This can be done straightforward using the well known formulas for Gaussian integrals and the Fourier transform of the Dirac delta. Given that the calculation is elementary, and for sake of brevity, we present only the resulting forms of each concatenation. To show this compactly we introduce the following abbreviations: Singular channels belonging to class A_2 with form J_I and with $\alpha = 0$, $e_2 = 0$ and $\alpha = e_2 = 0$, will be denoted as $\delta_{A_2}^\alpha$, $\delta_{A_2}^{e_2}$ and $\delta_{A_2}^{\alpha, e_2}$, respectively; singular channels belonging to the same class but with GF will be denoted as \mathcal{A}_{A_2} ; channels belonging to class A_1 will be denoted as δ_{A_1} ; finally Gaussian unitaries with GF will be denoted as $\mathcal{A}_{\mathcal{U}}$ and the ones with form J_{II} as $\delta_{\mathcal{U}}$. Writing the concatenation of two channels in the position representation as

$$J^{(f)}(x_f, r_f; x_i, r_i) = \int_{\mathbb{R}^2} dx' dr' J^{(1)}(x_f, r_f; x', r') J^{(2)}(x', r'; x_i, r_i), \quad (5.11)$$

the resulting functional forms for $J^{(f)}$ are given in table 5.1. As expected, the table shows that the integral has only the forms stated by our theorem. Additionally it shows the cases when unitaries change the functional form of class A_2 , while for class A_1 $J^{(f)}$ has always the unique form enunciated by the corollary.

$J^{(1)}$	$J^{(2)}$	$J^{(f)}$
$\delta_{A_2}^\alpha$	$\mathcal{A}_{\mathcal{U}}$	\mathcal{A}_{A_2}
$\mathcal{A}_{\mathcal{U}}$	$\delta_{A_2}^\alpha$	$\delta_{A_2}^\alpha$
$\delta_{A_2}^\alpha$	$\delta_{\mathcal{U}}$	$\delta_{A_2}^\alpha$
$\delta_{\mathcal{U}}$	$\delta_{A_2}^\alpha$	$\delta_{A_2}^\alpha$
$\delta_{A_2}^{e_2}$	$\mathcal{A}_{\mathcal{U}}$	$\delta_{A_2}^{e_2}$
$\mathcal{A}_{\mathcal{U}}$	$\delta_{A_2}^{e_2}$	\mathcal{A}_{A_2}
$\delta_{A_2}^{e_2}$	$\delta_{\mathcal{U}}$	$\delta_{A_2}^{e_2}$
$\delta_{\mathcal{U}}$	$\delta_{A_2}^{e_2}$	$\delta_{A_2}^{e_2}$
$\mathcal{A}_{\mathcal{U}}, \delta_{\mathcal{U}}$	$\delta_{A_2}^{\alpha, e_2}$	$\delta_{A_2}^{\alpha, e_2}$
$\delta_{A_2}^{\alpha, e_2}$	$\mathcal{A}_{\mathcal{U}}, \delta_{\mathcal{U}}$	$\delta_{A_2}^{\alpha, e_2}$
$\delta_{\mathcal{U}}, \mathcal{A}_{\mathcal{U}}$	δ_{A_1}	δ_{A_1}
δ_{A_1}	$\delta_{\mathcal{U}}, \mathcal{A}_{\mathcal{U}}$	δ_{A_1}

Table 5.1: The first and second columns show the functional forms of $J^{(1)}$ and $J^{(2)}$, respectively. The last column shows the resulting form of the concatenation of them, see eq. (5.11). See main text for symbol coding.

5.2 Existence of master equations

In this section we show the conditions under which master equations, associated with the channels derived in sec. 3.5.1, exist. To be more precise, we study if the functional forms derived above parametrize channels belonging to one-parameter differentiable families of GQCs. As a first step, we let the coefficients of forms presented in equations (3.24) and (3.25) to depend on time. Later we derive the conditions under which they bring any quantum state $\rho(x, r; t)$ to $\rho(x, r; t + \varepsilon)$ (with $\varepsilon > 0$ and $t \in [0, \infty)$) smoothly, while holding the specific functional form of the channel, i.e.

$$\rho(x, r; t + \varepsilon) = \rho(x, r; t) + \varepsilon \mathcal{L}_t[\rho(x, r; t)] + \mathcal{O}(\varepsilon^2), \quad (5.12)$$

where both $\rho(x, r; t)$ and $\rho(x, r; t + \varepsilon)$ are propagated from $t = 0$ with channels either with the form J_I or J_{II} , and \mathcal{L}_t is a bounded superoperator in the state subspace. This is basically the problem of *the existence of a master equation*

$$\partial_t \rho(x, r; t) = \mathcal{L}_t[\rho(x, r; t)], \quad (5.13)$$

for such functional forms. Thus, the problem is reduced to prove the existence of the linear generator \mathcal{L}_t , also known as *Liouvillian*.

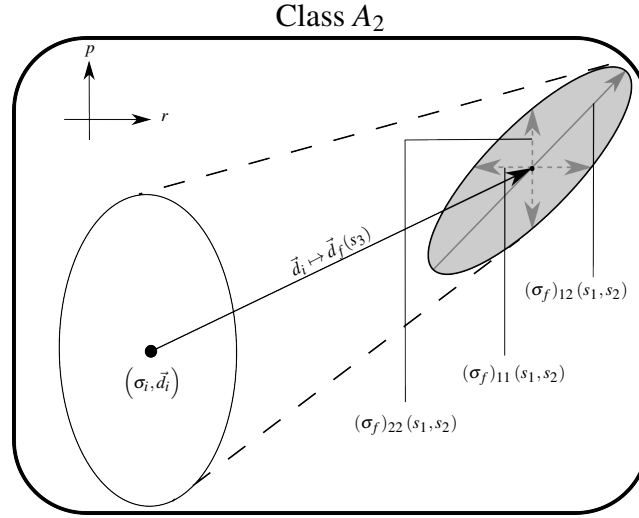

Figure 5.1: Schematic picture of the channels belonging to class A_2 . The explicit dependence of the final state in terms of the combinations s_1 , s_2 and s_3 are presented in the appendix. As well the formulas for s_i depending on the form of the channel.

To do this we use an ansatz proposed in Ref. [KG97] to investigate the existence and derive the master equation for GFs,

$$\mathcal{L} = \mathcal{L}_c(t) + (\partial_x, \partial_r)\mathbf{X}(t) \begin{pmatrix} \partial_x \\ \partial_r \end{pmatrix} + (x, r)\mathbf{Y}(t) \begin{pmatrix} \partial_x \\ \partial_r \end{pmatrix} + (x, r)\mathbf{Z}(t) \begin{pmatrix} x \\ r \end{pmatrix} \quad (5.14)$$

where $\mathcal{L}_c(t)$ is a complex function and

$$\mathbf{X}(t) = \begin{pmatrix} X_{xx}(t) & X_{xr}(t) \\ X_{rx}(t) & X_{rr}(t) \end{pmatrix} \quad (5.15)$$

is a complex matrix as well as $\mathbf{Y}(t)$ and $\mathbf{Z}(t)$, whose entries are defined in a similar way as in eq. (5.15). Note that $\mathbf{X}(t)$ and $\mathbf{Z}(t)$ can always be chosen symmetric, i.e. $X_{xr} = X_{rx}$ and $Z_{xr} = Z_{rx}$. Thus, we must determine 11 time-dependent functions from eq. (5.14). This ansatz is also appropriate to study the functional forms introduced in this work, given that the left hand side of eq. (5.13) only involves quadratic polynomials in x , r , $\partial/\partial x$ and $\partial/\partial r$, as in the GF case.

Notice that singular channels do not admit a master equation since its existence implies that channels with the functional form involved can be found arbitrarily

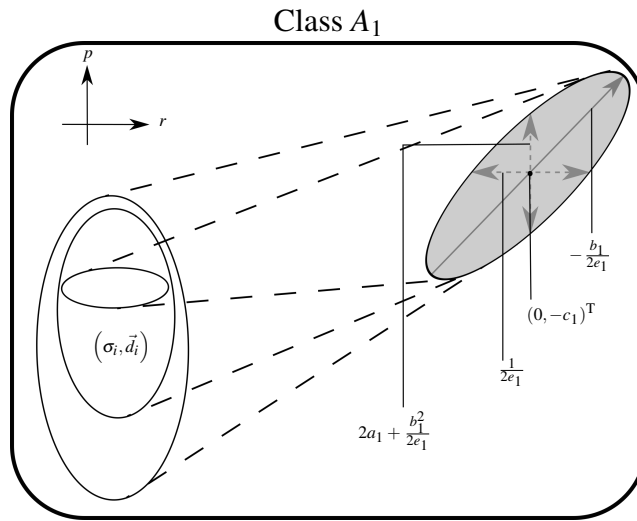

Figure 5.2: Schematic picture of the class A_1 . Every channel of this class maps every initial quantum state, in particular GSs characterized by (σ_i, \vec{d}_i) , to a Gaussian state that depends only on the channel parameters. We indicate in the figure the values of the corresponding components of the first and second moments of the final Gaussian state.

close from the identity channel. This is not possible for singular channels due to the continuity of the determinant of the matrix \mathbf{T} .

For the non-singular cases presented in equations (3.24) and (3.25), the condition for the existence of a master equation is obtained as follows. (i) Substitute the ansatz of eq. (5.14) in the right hand side of the eq. (5.13). (ii) Define $\rho(x, r; t)$ using eq. (2.30), given an initial condition $\rho(x, r; 0)$, for each functional form $J_{I,II}$. (iii) Take $\rho_f(x_f, r_f) \rightarrow \rho(x, r; t)$ and $\rho_i(x_i, r_i) \rightarrow \rho(x, r; 0)$. Finally, (iv) compare both sides of eq. (5.13). Defining $A(t) = \alpha(t)/\beta(t)$ and $B(t) = \gamma(t)/\eta(t)$, the conclusion is that for both J_I and J_{II} , a master equations exist if

$$c(t) \propto A(t) \quad (5.16)$$

holds, where $c(t) = c_1(t) + A(t)c_2(t)$. Additionally, for the form J_I the solutions for the matrices $\mathbf{X}(t)$, $\mathbf{Y}(t)$ and $\mathbf{Z}(t)$ are given by

$$\begin{aligned} X_{xx} &= X_{xr} = Y_{rx} = Z_{rr} = 0, \\ Y_{xx} &= \frac{\dot{A}}{A}, \\ \mathcal{L}_c &= Y_{rr} = \frac{\dot{e}_1}{e_1} - \frac{\dot{e}_2}{e_2}, \\ X_{rr} &= \frac{\dot{e}_1}{4e_1^2} - \frac{\dot{e}_2}{2e_1e_2}, \\ Y_{xr} &= i \left(\frac{\lambda_1 \dot{e}_2}{e_1 e_2} + \frac{\lambda_2 \dot{A}}{e_2 A} - \frac{\lambda_1 \dot{e}_1}{2e_1^2} - \frac{\dot{\lambda}_2}{e_2} \right), \\ Z_{xx} &= \frac{\lambda_1^2}{2} \left(\frac{\dot{e}_2}{e_1 e_2} - \frac{\dot{e}_1}{2e_1^2} \right) + \frac{\lambda_1}{e_2} \left(\frac{\lambda_2 \dot{A}}{A} - \dot{\lambda}_2 \right) + 2\lambda_3 \frac{\dot{A}}{A} - \dot{\lambda}_3, \\ Z_{xr} &= i \left(\frac{\dot{A}}{A} \left(\frac{e_1 \lambda_2}{e_2} - \frac{\lambda_1}{2} \right) + \frac{\dot{\lambda}_1}{2} - \frac{\dot{\lambda}_2 e_1}{e_2} + \frac{\lambda_2}{2} \left(\frac{\dot{e}_2}{e_2} - \frac{\dot{e}_1}{e_1} \right) \right), \end{aligned} \quad (5.17)$$

where we have defined the following coefficients: $\lambda_1 = b_1 + Ab_3$, $\lambda_2 = b_2 + Ab_4$ and $\lambda_3 = a_1 + Aa_2 + A^2a_3$.

For the form J_{II} the solutions are the following

$$\begin{aligned}
 \mathcal{L}_c &= X_{xx} = X_{xr} = X_{rr} = Z_{rr} = 0, \\
 Y_{rx} &= Y_{xr} = 0, \\
 Y_{xx} &= \frac{\dot{A}}{A}, Y_{rr} = \frac{\dot{B}}{B}. \\
 Z_{xx} &= a_2(t)\dot{A}(t) + \frac{2a_1(t)\dot{A}(t)}{A(t)} - A(t)^2 \\
 &\quad - \dot{a}_3(t) - A(t)\dot{a}_2(t) - \dot{a}_1(t), \\
 Z_{xr} &= \iota \left(\frac{1}{2}\dot{\lambda} - \frac{\lambda}{2} \left(\frac{\dot{A}}{A} + \frac{\dot{B}}{B} \right) \right),
 \end{aligned} \tag{5.18}$$

where $\lambda = b_1 + Ab_3 + B(b_2 + Ab_4)$.

Chapter 6

Summary and conclusions

Living is worthwhile if one can contribute in some small way to this endless chain of progress.

Paul A.M. Dirac

In this thesis we have introduced two works developed during my PhD. The first one was devoted to study quantum channels from the point of view of their divisibility properties. We made use of several results from the literature, specially from the seminal work by M. M. Wolf and J. I. Cirac [WECC08], and completed and fixed some results of Ref. [WC08]. This led to the construction of a tool to decide whether a quantum channel can be implemented using time-independent Markovian master equations or not, for the finite dimensional case. We additionally proved three theorems relating some of the studied divisibility types. Some of the tools introduced in chapter 3 are results from other paper developed during my PhD, where I am a secondary author, see Ref. [CDG19]. In the second work we have studied one-mode Gaussian channels without Gaussian functional form in the position state representation. We performed a characterization based on the universal properties that quantum channels must fulfill; in particular we studied the case of singular channels. We showed that the transition from unitarity to non-unitarity can correspond directly to a change in the functional form of the channel, in particular it turns out that functional form with one Dirac delta factor do not parametrize unitary channels. Additionally in this project we derived the conditions under which master equations for particular functional forms exist.

Let us summarize the results for the first project in more detail. We implemented the known conditions to decide the compatibility of channels with time-independent master equations (the so called L-divisibility) for the general diag-

onalizable case, and a discussion of the parametric space of Lindblad generators was given. We additionally clarified one of the results of the paper [WECC08]. There, the authors arrived to erroneous conclusions for the case of channels with negative eigenvalues. In our work we handled this case carefully. For unital qubit channels it was shown that every infinitesimal divisible map can be written as a concatenation of one L-divisible channel and two unitary conjugations. For the particular case of Pauli channels case, we have shown that the sets of infinitely divisible and L-divisible channels coincide. We made an interesting observation, connecting the concept of divisibility with the quantum information concept of entanglement-breaking channels: we found that divisible but not infinitesimal divisible qubit channels (in positive but not necessarily completely positive maps) are necessarily entanglement-breaking. We also noted that the intersection of indivisible and P-divisible channels is not empty. This allows us to implement indivisible channels with infinitesimal positive and trace preserving maps. Finally, we studied the possibility of dynamical transitions between different classes of divisibility channels. We argued that all the transitions are, in principle, possible, given that every divisibility set appears connected in our plots. We exploited two simple models of dynamical maps to demonstrate that these transitions exist. They clearly illustrate how the channels evolutions change from being implementable by Markovian dynamical maps (infinitesimal divisible in complete positive maps and/or L-divisible) to non-Markovian (divisible but not infinitesimal divisible or infinitesimal divisible in positive but not complete positive maps), and vice versa.

For the second project we have critically reviewed the deceptively natural idea that Gaussian quantum channels always admit a Gaussian functional form. To this end, we went beyond the pioneering characterization of Gaussian channels with Gaussian form presented in Ref. [MP12] in two new directions. First we have shown that, starting from their most general definition (a quantum operation that takes Gaussian states to Gaussian states), a more general parametrization of the coordinate representation of the one-mode case exists, that admits non-Gaussian functional forms. Second, we were able to provide a black-box characterization of such new forms by imposing complete positivity (not considered in Ref. [MP12]) and trace preserving conditions. While our parametrization connects with the analysis done by Holevo [Hol08] in the particular cases where besides having a non-Gaussian form the channel is also singular, it also allows the study of Gaussian unitaries, thus providing similar classification schemes. We completed the classification of the studied types of channels by deriving the form of the Liouillian Liouvillian superoperator that generates their time evolution in the form of a master equation. Surprisingly, Gaussian quantum channels without Gaussian form can be experimentally addressed by means of the celebrated Caldeira-Legget model for the quantum damped harmonic oscillator [GSI88], where the new types

of channels described here naturally appear in the sub-ohmic regime.

We are interested in several directions to continue the investigation. From the project of divisibility of quantum channels, an extension of this analysis to larger-dimensional systems could give a deeper sight to the structure of quantum channels. In particular we are interested on proving if the equivalence of infinitely divisible channels and L -divisible channels is present also in the general qubit case. Additionally a plethora of interesting questions are related to design of efficient verification procedures of the divisibility classes for channels and dynamical maps. For instance, *can we define an extension of the Lorentz normal decomposition to systems composed of many qubits?*, this would be useful to characterize infinitesimal divisibility of many particle systems; or *Is the non-countable parametrization of channels with negative eigenvalues relevant on deciding L -divisibility?*. Finally the area of channel divisibility contains several open structural questions, e.g. the existence of at most n -divisible channels. From the project concerning one-mode Gaussian channels, a natural direction to follow is to extend the analysis for other types of channels (or more modes) by following the classification introduced by Holevo, see Ref. [Hol07]. The latter is based on the form of a canonical form of one-mode Gaussian channels. Therefore a connection of this classification with ours could be useful to assess quantum information features, in particular for systems for which position state representation is advantageous.

Chapter 7

Appendices

Appendix A

Proof of theorem “Exact dynamics with Lindblad master equation”

The theorem announced in chapter 2 is,

Theorem 2 (Exact dynamics with Lindblad master equation) *Let $\mathcal{E}_t = e^{tL}$ a quantum process generated by a Lindblad operator L . The equation*

$$\mathcal{E}_t[\rho_S] = \text{tr}_E [e^{-iHt} (\rho_S \otimes \rho_E) e^{iHt}],$$

where H has finite dimension, holds if and only if \mathcal{E}_t is a unitary conjugation for every t .

Proof. To prove this theorem, we will compute $\rho_S(t)$ to first order in t , see eq. (2.12). Following the master equation of eq. (2.10) and taking $t = \varepsilon \ll 1$, we have

$$\begin{aligned} \rho_S(\varepsilon) &\approx \rho_S + \text{tr}_E \int_0^\varepsilon dt \{i[\rho_S \otimes \rho_E, H]\} \\ &= \rho_S + \text{tr}_E \{i[\rho_S \otimes \rho_E, H]\} \varepsilon \\ &= \rho_S + L_{\text{Exact}}[\rho_S] \varepsilon. \end{aligned}$$

where $L_{\text{Exact}} = \text{tr}_E \{i[\rho_S \otimes \rho_E, H]\}$. Since \mathcal{E}_t is generated by a Lindblad master equation, L_{Exact} must coincide with the Lindblad generator since the process is homogeneous in time, i.e. L_{Exact} is time-independent. Writing the global Hamiltonian as

$$H = \sum_{k,l=0} h_{kl} F_k^{(S)} \otimes F_l^{(E)},$$

where $h_{kl} \in \mathbb{R}$, and $\{F_k^{(S)}\}_k$ and $\{F_l^{(E)}\}_l$ are orthogonal hermitian bases of $\mathcal{B}(\mathcal{H}^{(S)})$ and $\mathcal{B}(\mathcal{H}^{(E)})$, respectively, with $\mathcal{H}^{(S)}$ and $\mathcal{H}^{(E)}$ are the Hilbert spaces of the central system S and the environment E. We have,

$$\begin{aligned}
L_{\text{Exact}}[\rho_S] &= i \text{tr}_E \left\{ \sum_{k,l} h_{kl} [\rho_S \otimes \rho_E, F_k^{(S)} \otimes F_l^{(E)}] \right\} \\
&= i \sum_{k,l} h_{kl} \left\{ \rho_S F_k^{(S)} \text{tr}[\rho_E F_l^{(E)}] - F_k^{(S)} \rho_S \text{tr}[F_l^{(E)} \rho_E] \right\} \\
&= i \sum_{k,l} h_{kl} \text{tr}[F_l^{(E)} \rho_E] \left\{ \rho_S F_k^{(S)} - F_k^{(S)} \rho_S \right\} \\
&= i[\rho_S, \tilde{H}],
\end{aligned}$$

where $\tilde{H} = \sum_{k,l} h_{kl} \text{tr}[F_l^{(E)} \rho_E] F_k^{(S)}$ is an hermitian operator. Therefore L_{Exact} is the generator of Hamiltonian dynamics with Hamiltonian \tilde{H} , thus \mathcal{E}_t is unitary for all t . \square

Appendix B

On Lorentz normal forms of Choi-Jamiolkowski state

In this appendix we compute the Lorentz normal decomposition of a channel for which one gets $b \neq 0$, supporting our observation that Lorentz normal decomposition does not take Choi-Jamiolkowski states to something proportional to a Choi-Jamiolkowski state. Consider the following Kraus rank three channel and its $R_{\mathcal{E}}$ matrix, both written in the Pauli basis:

$$\hat{\mathcal{E}} = \begin{pmatrix} 1 & 0 & 0 & 0 \\ 0 & -\frac{1}{3} & 0 & 0 \\ 0 & 0 & -\frac{1}{3} & 0 \\ \frac{2}{3} & 0 & 0 & \frac{1}{3} \end{pmatrix}, \quad (\text{B.1})$$

and

$$R_{\mathcal{E}} = \begin{pmatrix} 1 & 0 & 0 & 0 \\ 0 & -\frac{1}{3} & 0 & 0 \\ 0 & 0 & \frac{1}{3} & 0 \\ \frac{2}{3} & 0 & 0 & \frac{1}{3} \end{pmatrix}. \quad (\text{B.2})$$

Using the algorithm introduced in Ref. [VDD01] to calculate $R_{\mathcal{E}}$'s Lorentz decomposition into orthochronous proper Lorentz transformations we obtain

$$L_1 = \frac{1}{\gamma_1} \begin{pmatrix} 4 & 0 & 0 & 1 \\ 0 & -\gamma_1 & 0 & 0 \\ 0 & 0 & -\gamma_1 & 0 \\ 1 & 0 & 0 & 4 \end{pmatrix}, \quad (\text{B.3})$$

$$L_2 = \frac{1}{\gamma_2} \begin{pmatrix} 89 + 9\sqrt{97} & 0 & 0 & -8 \\ 0 & -\gamma_2 & 0 & 0 \\ 0 & 0 & -\gamma_2 & 0 \\ -8 & 0 & 0 & 89 + 9\sqrt{97} \end{pmatrix},$$

and

$$\Sigma_{\mathcal{E}} = \frac{1}{\gamma_3} \begin{pmatrix} \sqrt{11 + \frac{109}{\sqrt{97}}} & 0 & 0 & -\frac{\sqrt{97}+1}{\sqrt{89\sqrt{97}+873}} \\ 0 & -\frac{\gamma_3}{3} & 0 & 0 \\ 0 & 0 & \frac{\gamma_3}{3} & 0 \\ \sqrt{1 + \frac{49}{\sqrt{97}}} & 0 & 0 & \sqrt{-1 + \frac{49}{\sqrt{97}}} \end{pmatrix}$$

with $\gamma_1 = \sqrt{15}$, $\gamma_2 = 3\sqrt{178\sqrt{97} + 1746}$, and $\gamma_3 = \sqrt{30}$. Although the central matrix $\Sigma_{\mathcal{E}}$ is not exactly of the form eq. (3.17), it is equivalent. To see this notice that the derivation of the theorem 2 in [VDD01] considers only decompositions into proper orthochronous Lorentz transformations. But to obtain the desired form, the authors change signs until they get eq. (3.17); this cannot be done without changing Lorentz transformations. If we relax the condition over $L_{1,2}$ of being proper and orthochronous, we can bring $\Sigma_{\mathcal{E}}$ to the desired form by conjugating $\Sigma_{\mathcal{E}}$ with $G = \text{diag}(1, 1, 1, -1)$:

$$G^{-1}\Sigma_{\mathcal{E}}G = \frac{1}{\gamma_3} \begin{pmatrix} \sqrt{11 + \frac{109}{\sqrt{97}}} & 0 & 0 & \frac{\sqrt{97}+1}{\sqrt{89\sqrt{97}+873}} \\ 0 & -\frac{\gamma_3}{3} & 0 & 0 \\ 0 & 0 & \frac{\gamma_3}{3} & 0 \\ -\sqrt{1 + \frac{49}{\sqrt{97}}} & 0 & 0 & \sqrt{-1 + \frac{49}{\sqrt{97}}} \end{pmatrix}.$$

In both cases (taking $\Sigma_{\mathcal{E}}$ or $G^{-1}\Sigma_{\mathcal{E}}G$ as the normal form of $R_{\mathcal{E}}$), the corresponding channel is not proportional to a trace-preserving one since $b \neq 0$, see eq. (3.17). This completes the counterexample.

Bibliography

- [AHFB15] Christian Arenz, Robin Hillier, Martin Fraas, and Daniel Burgarth. Distinguishing decoherence from alternative quantum theories by dynamical decoupling. *Physical Review A - Atomic, Molecular, and Optical Physics*, 92(2):22102, 2015.
- [AKM14] Markus Aspelmeyer, Tobias J. Kippenberg, and Florian Marquardt. Cavity optomechanics. *Rev. Mod. Phys.*, 86:1391–1452, Dec 2014.
- [AL07] Robert Alicki and Karl Lendi. *Quantum Dynamical Semigroups and Applications*, volume 717 of *Lecture Notes in Physics*. Springer Berlin Heidelberg, Berlin, Heidelberg, 2007.
- [ARHP14] Ángel Rivas, Susana F Huelga, and Martin B Plenio. Quantum non-markovianity: characterization, quantification and detection. *Rep. Prog. Phys.*, 77(9):094001, 2014.
- [BP07] H.P. Breuer and F. Petruccione. *The Theory of Open Quantum Systems*. OUP Oxford, 2007.
- [BvL05] Samuel L. Braunstein and Peter van Loock. Quantum information with continuous variables. *Rev. Mod. Phys.*, 77:513–577, Jun 2005.
- [CDG19] Gustavo Montes Cabrera, David Davalos, and Thomas Gorin. Positivity and complete positivity of differentiable quantum processes. *Physics Letters A*, 383(23):2719–2728, 2019.
- [Cho75] Man-Duen Choi. Completely positive linear maps on complex matrices. *Linear Algebra and its Applications*, 10(3):285 – 290, 1975.
- [CLP07] N J Cerf, G Leuchs, and E S Polzik. *Quantum Information with Continuous Variables of Atoms and Light*. Imperial College Press, 2007.
- [CTZ08] Hilary A Carteret, Daniel R Terno, and Karol Zyczkowski. Dynam-

- ics beyond completely positive maps: Some properties and applications. *Physical Review A - Atomic, Molecular, and Optical Physics*, 77(4), 2008.
- [Cul66] W. J. Culver. On the Existence and Uniqueness of the Real Logarithm of a Matrix. *Proceedings of the American Mathematical Society*, 17(5):1146–1151, 1966.
- [Den89] L. V. Denisov. Infinitely Divisible Markov Mappings in Quantum Probability Theory. *Theory Prob. Appl.*, 33(2):392–395, 1989.
- [EL77] D. E. Evans and J. T. Lewis. *Dilations of Irreversible Evolutions in Algebraic Quantum Theory*, volume 24 of *Communications of the Dublin Institute for Advanced Studies: Theoretical physics*. Dublin Institute for Advanced Studies, 1977.
- [EW07] J. Eisert and M. M. Wolf. Gaussian Quantum Channels. In *Quantum Information with Continuous Variables of Atoms and Light*, pages 23–42. Imperial College Press, feb 2007.
- [Exn85] Pavel Exner. *Open Quantum Systems and Feynman Integrals*, volume 36. Springer Netherlands, Dordrecht, 1985.
- [FPMZ17] S. N. Filippov, J. Piilo, S. Maniscalco, and M. Ziman. Divisibility of quantum dynamical maps and collision models. *Phys. Rev. A*, 96(3):032111, 2017.
- [GKL13] A. D. Greentree, J. Koch, and J. Larson. Fifty years of Jaynes–Cummings physics. *J. Phy. B*, 46(22):220201, 2013.
- [Gor76] V. Gorini. Completely positive dynamical semigroups of N-level systems. *J. Math. Phys.*, 17(5):821, 1976.
- [GSI88] Hermann Grabert, Peter Schramm, and Gert-Ludwig Ingold. Quantum Brownian motion: The functional integral approach. *Physics Reports*, 168(3):115–207, oct 1988.
- [GTW09] Alexei Gilchrist, Daniel R. Terno, and Christopher Wood. Vectorization of quantum operations and its use. *arXiv*, page 12, 2009.
- [GVAW⁺03] Frédéric Grosshans, Gilles Van Assche, Jérôme Wenger, Rosa Brouri, Nicolas J. Cerf, and Philippe Grangier. Quantum key distribution using gaussian-modulated coherent states. *Nature*, 421:238, Jan 2003.
- [HHHH09] R. Horodecki, P. Horodecki, M. Horodecki, and K. Horodecki. Quantum entanglement. *Rev. Mod. Phys.*, 81(2):865–942, 2009.

- [Hol01] Alexander S Holevo. *Statistical Structure of Quantum Theory*, volume 67 of *Lecture Notes in Physics Monographs*. Springer Berlin Heidelberg, Berlin, Heidelberg, 2001.
- [Hol07] A S Holevo. One-mode quantum Gaussian channels: Structure and quantum capacity. *Problems of Information Transmission*, 43(1):1–11, mar 2007.
- [Hol08] A S Holevo. Entanglement-breaking channels in infinite dimensions. *Problems of Information Transmission*, 44(3):171–184, 2008.
- [HR06] S. Haroche and J.-M. Raimond. *Exploring the Quantum: Atoms, Cavities, and Photons*. Oxford University Press, USA, 2006.
- [HSP10] Klemens Hammerer, Anders S. Sørensen, and Eugene S. Polzik. Quantum interface between light and atomic ensembles. *Rev. Mod. Phys.*, 82:1041–1093, Apr 2010.
- [HZ12] T. Heinosaari and M. Ziman. *The Mathematical Language of Quantum Theory: From Uncertainty to Entanglement*. Cambridge University Press, 2012.
- [JC63] E. T. Jaynes and F. W. Cummings. Comparison of quantum and semiclassical radiation theories with application to the beam maser. *Proc. IEEE*, 51:89, 1963.
- [KBDW83] Karl Kraus, A. Böhm, J. D. Dollard, and W. H. Wootters. *States Effects Operators*, volume 190 of *Lecture Notes in Physics*. Springer Berlin Heidelberg, Berlin, Heidelberg, 1983.
- [KC09] A. B. Klimov and S. M. Chumakov. *A Group-Theoretical Approach to Quantum Optics: Models of Atom-Field Interactions*. Wiley-VCH, 2009.
- [KG97] Robert Karrlein and Hermann Grabert. Exact time evolution and master equations for the damped harmonic oscillator. *Physical Review E*, 55(1):153–164, 1997.
- [Kos72a] A. Kossakowski. On necessary and sufficient conditions for a generator of a quantum dynamical semigroup. *Bull. Acad. Pol. Sci.*, 20(12):1021, 1972.
- [Kos72b] A. Kossakowski. On quantum statistical mechanics of non-hamiltonian systems. *Rep. Math. Phys.*, 3(4):247 – 274, 1972.
- [LB99] Seth Lloyd and Samuel L. Braunstein. Quantum computation over

- continuous variables. *Phys. Rev. Lett.*, 82:1784–1787, Feb 1999.
- [Lin76] G. Lindblad. On the generators of quantum dynamical semigroups. *Comm. Math. Phys.*, 48(2):119–130, 1976.
- [Lin00] Göran Lindblad. Cloning the quantum oscillator. *Journal of Physics A: Mathematical and General*, 33(28):5059–5076, 2000.
- [LRW⁺18] Ludovico Lami, Bartosz Regula, Xin Wang, Rosanna Nichols, Andreas Winter, and Gerardo Adesso. Gaussian quantum resource theories. *Phys. Rev. A*, 98:022335, Aug 2018.
- [MP12] Esteban A Martinez and Juan Pablo Paz. Supplementary material for the paper ” Dynamics and thermodynamics for linear quantum open systems. *Phys. Rev. Lett.*, 2012.
- [NC11] Michael A. Nielsen and Isaac L. Chuang. *Quantum Computation and Quantum Information: 10th Anniversary Edition*. Cambridge University Press, New York, NY, USA, 10th edition, 2011.
- [PGD⁺16] C. Pineda, T. Gorin, D. Davalos, D. A. Wisniacki, and I. García-Mata. Measuring and using non-Markovianity. *Phys. Rev. A*, 93:022117, 2016.
- [Red65] A. G. Redfield. The Theory of Relaxation Processes. In *Advances in Magnetic and Optical Resonance*, volume 1, pages 1–32. Academic Press, Jan 1965.
- [RFZB12] T. Rybár, S. N. Filippov, M. Ziman, and V. Bužek. Simulation of indivisible qubit channels in collision models. *J. Phys. B*, 45(15):154006, 2012.
- [RH12] Ángel Rivas and Susana F. Huelga. *Open Quantum Systems*. SpringerBriefs in Physics. Springer Berlin Heidelberg, Berlin, Heidelberg, 2012.
- [RPZ18] Ł. Rudnicki, Z. Puchała, and K. Życzkowski. Gauge invariant information concerning quantum channels. *Quantum*, 2:60, April 2018.
- [RSW02] M. B. Ruskai, S. Szarek, and E. Werner. An analysis of completely-positive trace-preserving maps on M_2 . *Lin. Alg. Appl.*, 347(1):159 – 187, 2002.
- [Sti06] W. Forrest Stinespring. Positive Functions on C^* -Algebras. *Proceedings of the American Mathematical Society*, 6(2):211, Feb 2006.
- [Tun85] Wu-Ki. Tung. *Group theory in physics*. World Scientific, 1985.

- [VDD01] F. Verstraete, J. Dehaene, and B. DeMoor. Local filtering operations on two qubits. *Phys. Rev. A*, 64(1):010101, 2001.
- [VSL⁺11] B. Vacchini, A. Smirne, E.-M. Laine, J. Piilo, and H.-P. Breuer. Markovianity and non-markovianity in quantum and classical systems. *New J. Phys.*, 13(9):093004, 2011.
- [VV02] F. Verstraete and H. Verschelde. On quantum channels. *Unpublished*, 2002.
- [WC08] M. M. Wolf and J. I. Cirac. Dividing quantum channels. *Comm. Math. Phys.*, 279(1):147–168, 2008.
- [WECC08] M. M. Wolf, J. Eisert, T. S. Cubitt, and J. I. Cirac. Assessing non-Markovian quantum dynamics. *Phys. Rev. Lett.*, 101(15):150402, 2008.
- [Wol11] Mm Wolf. Quantum channels & operations: Guided tour. *Lecture notes available at <http://www-m5.ma.tum...>*, 2011.
- [WPGP⁺12] Christian Weedbrook, Stefano Pirandola, Raúl García-Patrón, Nicolas J. Cerf, Timothy C. Ralph, Jeffrey H. Shapiro, and Seth Lloyd. Gaussian quantum information. *Reviews of Modern Physics*, 84(2):621–669, may 2012.
- [ZB05] M. Ziman and V. Bužek. Concurrence versus purity: Influence of local channels on Bell states of two qubits. *Phys. Rev. A*, 72(5):052325, 2005.