

Temporal-Differential Learning in Continuous Environments

Tao Bian

*Bank of America
One Bryant Park
New York, NY 10036, USA*

TBIAN@NYU.EDU

Zhong-Ping Jiang

*Department of Electrical and Computer Engineering
New York University
6 Metrotech Center
Brooklyn, NY 11201, USA*

ZJIANG@NYU.EDU

Abstract

In this paper, a new reinforcement learning (RL) method known as the method of temporal differential is introduced. Compared to the traditional temporal-difference learning method, it plays a crucial role in developing novel RL techniques for continuous environments. In particular, the continuous-time least squares policy evaluation (CT-LSPE) and the continuous-time temporal-differential (CT-TD) learning methods are developed. Both theoretical and empirical evidences are provided to demonstrate the effectiveness of the proposed temporal-differential learning methodology.

Keywords: Reinforcement Learning, Markov Processes, Kernel Methods, Continuous Environment, Policy Evaluation

1. Introduction

Over the past decade, reinforcement learning (RL) has quickly become one of the most prominent technologies in the field of artificial intelligence (AI). The popularity of RL is mainly driven by its recent success in various application fields (Barto et al., 2017; Silver et al., 2017; Wang et al., 2018; Kolm and Ritter, 2019). Despite the rapid growth of RL in recent years, a common feature in most existing RL techniques, or broadly speaking most AI technologies, is that the learning task is performed in discrete learning environments (Russell and Norvig, 2010, Section 2.3.2), that is, either the time space or the state-action space or both are associated with the discrete topology. Although most practical physical environments are continuous in nature, in the sense that both the time space and the state-action spaces are continuous, RL and AI problems in continuous learning environments have rarely been touched upon in the past literature. In fact, the ability of learning in continuous learning environments has long been visioned as an important component of a futuristic AI system (Russell, 1997, Section 7). Admittedly, building AI and RL agents in continuous environments is a challenging task. One challenge is that most processes evolving in continuous environments are described by ordinary differential equations (ODEs), stochastic differential equations (SDEs), or other complex mathematical models. These models are still not fully-understood from the AI and RL perspective. This raises the question on how to develop a generic learning framework applicable to all these models. In addition, the state-action spaces encountered in practical RL problems often exhibit complex shapes

and structures. For example, the presence of singularity points in robot workspace (Merlet, 2006) is a notorious issue in robot control and learning. These irregularities create a serious challenge for the convergence and robustness analysis of learning algorithms. Besides its potential value in practical applications, understanding the continuous limits of RL and AI algorithms also provides us a unique insight into the dynamics and theoretical nature of these algorithms. In fact, dynamical systems and differential equation theories have gained great popularity recently in understanding ML, especially neural network (NN) models (E, 2017; Chaudhari et al., 2018; Chen et al., 2018; Ruthotto and Haber, 2020). In addition, the ODE method has already been used in stochastic approximation (Ljung, 1977) to study the convergence of RL algorithms (Kushner and Yin, 2003). Hence, in order to expand the application of RL to a broader range of problems, and to enrich our understanding of RL theory, it is necessary to investigate RL methods in general continuous learning environments.

The purpose of this paper is to extend the classical temporal difference (TD) error (Sutton, 1988) to the setting of continuous environments. To overcome the shortcomings of traditional RL in dealing with problems arising from continuous environments, we will introduce a new concept under the name of *temporal-differential* error. Similar to the TD in discrete environments, the temporal-differential error plays a key role in developing new RL methods in continuous environments. In particular, we introduce two continuous RL algorithms, namely, the continuous-time least squares policy evaluation (CT-LSPE) (Algorithm 1) and the continuous-time temporal-differential (CT-TD) learning (Algorithm 2). These algorithms are extensions of the LSPE (Nedić and Bertsekas, 2003) and the TD learning (Sutton and Barto, 2018, Chapter 6), respectively, to continuous environments. As a continuous RL methodology, our algorithms also possess several unique features that distinguish them from most traditional RL methods. First, instead of using NN approximation, kernel approximation is used in our design. The linkage between the kernel function and the Hilbert space theory allows our algorithms to achieve convergence over the entire state space. Second, systems and control theory will be applied to show the stability and robustness of the proposed learning algorithms. Finite-time error bounds are also obtained, without assuming the stationarity of the training data as in the past literature (Antos et al., 2008; Munos and Szepesvári, 2008).

2. Related Works

The study on RL in continuous environments can be traced back to the concept of advantage updating (Baird, III, 1993; Harmon et al., 1995). Shortly after Baird’s advantage updating, the continuous-time TD learning and actor-critic algorithms were developed by Doya (1996) and Doya (2000). In addition, Munos (2000) developed a continuous RL technique to solve viscosity solutions in order to tackle the case where the classical optimal solution does not exist. Continuous RL has also been applied in different fields including game theory (Börgers and Sarin, 1997) and neurobiology (Frémaux et al., 2013). A common feature of these early results is that the discrete-time sampling is performed to convert the continuous-time problem into the discrete-time setting. More recently, the research on deep RL opens possibilities for developing practical learning algorithms in continuous state-action spaces (van Hasselt and Wiering, 2007; van Hasselt, 2012; Lillicrap et al., 2016; Duan et al., 2016; Recht, 2019). Indeed, computer experiments from balancing inverted pendulums to learning the locomotion have shown very promising results.

Besides the above collective efforts, a learning-based control design methodology, usually under the name of adaptive (or approximate) dynamic programming (ADP) (Jiang and Jiang, 2012; Vrabie et al., 2013; Bian and Jiang, 2016; Kiumarsi et al., 2018), has been developed to solve optimal control problems for continuous-time dynamical systems. Instead of discretizing a continuous-time system into a discrete-time system, ADP algorithms solve directly the optimal control problem by utilizing the continuous-time data flow generated by dynamical systems. Exploiting explicitly systems and control techniques, the stability and optimality of the controlled system can be guaranteed. Finally, to perform the learning task in more complex environments, robust and decentralized extensions of ADP have also been proposed by Jiang and Jiang (2017); Bian and Jiang (2019).

3. Problem Formulation

Throughout this paper, \mathbb{R} denotes the set of reals. I denotes the identity matrix with appropriate dimension. $|\cdot|$ denotes the Euclidean norm for vectors, or the induced matrix norm for matrices. id denotes the identity mapping. Let $(\Omega, \mathcal{F}, \mathbb{P})$ be a probability space and $\{x_t\}_{t \geq 0}$ be a càdlàg and time-homogeneous strong Markov process with state space X . Here X is a locally compact Hausdorff space with a countable base, equipped with the Borel σ -algebra \mathcal{B} . Denote by \mathbb{E}_x the expectation conditionally on the initial state x and by \mathbb{E}_μ the expectation with respect to μ . The Hilbert space L_μ^2 and the norm $\|\cdot\|_\mu$ are induced from the inner product $\langle \cdot, \cdot \rangle_\mu$ defined via $\langle f, g \rangle_\mu = \mathbb{E}_\mu [fg]$ for all $f, g \in L_\mu^2$. Denote by \mathcal{A} the infinitesimal generator associated with $\{x_t\}_{t \geq 0}$. The domain of \mathcal{A} is written as $\mathcal{D}(\mathcal{A}) \subseteq L_\mu^2$. For more details on the notations used in this paper, see Appendix A and references therein.

Our goal in this paper is to estimate the following value function V^* that depends on the future path of $\{x_t\}_{t \geq 0}$:

$$V^*(x) = \mathbb{E}_x \left[\int_0^\infty e^{-\gamma t} r(x_t) dt \right], \quad \forall x \in X, \quad (1)$$

where $r \in L_\mu^2$ is the running-reward/cost function, and $\gamma > 0$ is a scalar representing the discounting effect. To be mathematically concrete, we assume $\mathbb{E}_x[r(x_t)]$ is measurable and locally essentially bounded.

To see why the classical discrete-time TD learning is no longer a good choice to solve V^* here, we write the discrete-time TD error for the discretized process (with sampling period Δt) as

$$e^{-\gamma \Delta t} V_k(x_{\Delta t}) - V_k(x) + \int_0^{\Delta t} e^{-\gamma s} r(x_s) ds, \quad \forall x \in X.$$

Obviously, when Δt is small, the discounting term $e^{-\gamma \Delta t}$ is close to 1, resulting in a poor convergence performance (see Tsitsiklis and Van Roy (1997) for convergence analysis). If Δt is too large, the updating frequency is reduced, which could also compromise the on-line learning performance. In light of the above difficulties, it is desirable to solve V^* without discretizing the performance index and the underlying Markov process in the first place. To proceed, note from Ito (1960, Chapter 1) that V^* satisfies the following linear functional equation:

$$0 = \mathcal{T}V^* + r, \quad (2)$$

where $\mathcal{T} = \mathcal{A} - \gamma$. The converse statement is also true by Dynkin's formula (Kushner, 1967a, Chapter 1).

In this paper, we will introduce two on-line learning methods to solve (2).

4. Value Approximation in Continuous Time

In this section, we consider the following approximated equation:

$$\partial_t V_t = \Pi(\mathcal{T}V_t + r), \quad (3)$$

where Π is defined by the following integral equation:

$$\Pi V(x) = \int_X V(z)K(z, x)d\mu(z), \quad \forall V \in L_\mu^2, x \in X.$$

Here K is a square-integrable continuous symmetric positive-definite kernel. Corresponding to each K , we can uniquely define a reproducing kernel Hilbert space (RKHS) $\mathcal{H} \subseteq L_\mu^2$ (Aronszajn, 1950, Section 2). In addition, Π is an orthogonal projection from L_μ^2 to \mathcal{H} (Aronszajn, 1950, Section 2). To fit into our learning framework, the reproducing kernel K is designed to ensure \mathcal{H} is a subspace of $\mathcal{D}(\mathcal{A})$. This requirement can be satisfied for many practical processes by selecting a sufficiently smooth K ; see Section 5 for details. Finally, we assume the initial value function $V_0 \in \mathcal{H}$.

From the perspective of systems and control theory, (3) can be viewed as a reduced-order model (Scarciotti and Astolfi, 2017) of the nominal system

$$\partial_t v_t = \mathcal{T}v_t + r. \quad (4)$$

As a result, we can rewrite (3) in the form of system (4) with an approximation error $(\Pi - \text{id})(\mathcal{T}V_t + r)$ added to its right-hand side.

The following theorem shows that V_t converges into a neighbourhood of V^* exponentially.

Theorem 1 *V_t is well-defined and is exponentially stable (at V_∞) in \mathcal{H} . In addition,*

$$\begin{aligned} \|V_t - V^*\|_\mu &\leq e^{-\gamma t} \|V_0 - V_\infty\|_\mu + \frac{1}{\gamma} \|\mathcal{T}V_\infty + r\|_\mu, \\ \|V_t - V^*\|_\mu &\leq e^{-\gamma t} \|V_0 - V^*\|_\mu + \frac{1 - e^{-\gamma t}}{\gamma} \sup_{s \in [0, t]} \|(\Pi - \text{id})(\mathcal{T}V_s + r)\|_\mu. \end{aligned}$$

In particular, $\|V_\infty - V^\|_\mu \leq \gamma^{-1} \|\mathcal{T}V_\infty + r\|_\mu$.*

See Appendix B.1 for the proof of Theorem 1.

The finite-time error bounds in Theorem 1 are composed with two parts. The first part represents the error induced from the initial guess V_0 . The second part is due to the approximation error introduced by the projection Π . If we can choose \mathcal{H} properly, such that for any $f \in \mathcal{H}$, $\mathcal{A}f \in \mathcal{H}$, then one can show that

$$\|V_t - V^*\|_\mu \leq e^{-\gamma t} \|V_0 - V^*\|_\mu + \frac{1 - e^{-\gamma t}}{\gamma} \|\Pi r - r\|_\mu.$$

The above inequality implies that in this case the error bound is purely controlled by the initial guess V_0 and the “observation error” in the running-reward/cost r .

Note that the first error bound in Theorem 1 is tighter for large t , and the second error bound is tighter for small t . From the perspective of robust control theory, the second error bound quantifies the impact of $(\Pi - \text{id})(\mathcal{T}V_t + r)$ on the approximation error between V_t and V^* . In addition, the discounting factor γ is linked to the robustness of (3), in the sense that a larger γ results in a smaller error bound and a faster convergence rate.

Finally, it is worth pointing out that the results in Theorem 1 can also be extended to evaluate the ergodic cost (Arapostathis et al., 2012). In this case, there is no discounting term in (1), and we have $\mathcal{T} = \mathcal{A}$ in (2) and (3). Note from Bhattacharya (1982, Proposition 2.2) that as long as $\{x_t\}_{t \geq 0}$ is ergodic, \mathcal{A} has a simple zero eigenvalue corresponding to the constant eigenfunction. Hence, by excluding the constant function from \mathcal{H} , we can ensure there still exists a $\gamma > 0$, such that $\langle V, \Pi \mathcal{T} V \rangle_\mu \leq -\gamma \|V\|_\mu$. As a result, the two inequalities in Theorem 1 still hold.

5. Model-free On-line Learning

The results presented in the last section provide an efficient way to approximate V^* through the linear functional equation (3). Unfortunately, in order to solve (3) directly, we must have access to the knowledge of μ , \mathcal{A} , and r . This is not an easy task in practice, since μ , \mathcal{A} , and r are associated with the mathematical model of the learning environment, which is usually not known.

In this section, we propose two on-line learning algorithms to estimate V^* using the data observed directly from the environment. The knowledge of μ , \mathcal{A} , and r is not required in our learning algorithm design. Throughout this section, we consider the following realization of K :

$$K(z, x) = \phi^T(z) (\mathbb{E}_\mu [\phi \phi^T])^{-1} \phi(x),$$

where $\phi = [\phi_1 \ \phi_2 \ \cdots \ \phi_N]^T$, and $\{\phi_j\}_{j=1}^N$ are N independent functions in $\mathcal{D}(\mathcal{A})$. The independence of $\{\phi_j\}_{j=1}^N$ guarantees the matrix inverse in K is well-defined. Obviously, K satisfies our definition of reproducing kernel in Section 4. In fact, the RKHS \mathcal{H} associated with K is the N -dimensional space spanned by $\{\phi_j\}_{j=1}^N$, and V_t in (3) can be parameterized as $V_t(x) = \phi^T(x) c_t$ for some $c_t \in \mathbb{R}^N$. Directly plugging the definitions of K and V_t in (3), we have the following ODE in c_t :

$$\dot{c}_t = (\mathbb{E}_\mu [\phi \phi^T])^{-1} (\mathbb{E}_\mu [\phi \mathcal{T} \phi^T] c_t + \mathbb{E}_\mu [\phi r]), \quad c_0 \in \mathbb{R}^N. \quad (5)$$

In the above equation, \mathcal{T} is applied element-wise to ϕ . By Theorem 1, (5) admits an equilibrium point c^* satisfying $\mathbb{E}_\mu [\phi \mathcal{T} \phi^T] c^* + \mathbb{E}_\mu [\phi r] = 0$.

In addition, by Dynkin’s formula, we can replace $\mathcal{A}\phi$ in (5) with

$$d\phi_t = \mathcal{A}\phi_t dt + dM_t, \quad (6)$$

where M_t is a vector-valued martingale, and $d\phi_t \triangleq \phi_{t+dt} - \phi_t$ represents the infinitesimal change in the value of ϕ_t . By abuse of notation we denote ϕ_t and r_t for $\phi(x_t)$ and $r(x_t)$, respectively, when there is no confusion.

Algorithm 1: Continuous-time least squares policy evaluation (CT-LSPE)

Choose N basis functions ϕ_j . Denote $\phi = [\phi_1 \ \phi_2 \ \cdots \ \phi_N]^T$. Select $\rho > 0$.
 Update c_t through the following ODEs:

$$\begin{aligned} \dot{c}_t &= R_t \int_0^t \phi_s (d\phi_s - \gamma \phi_s ds)^T c_t + R_t \int_0^t \phi_s r_s ds, \quad c_0 \in \mathbb{R}^N, \\ \dot{R}_t &= -R_t \phi_t \phi_t^T R_t, \quad R_0 = \rho^{-1} I. \end{aligned}$$

5.1 Continuous-time least squares policy evaluation

We first replace the integrations with respect to μ in (5) by their empirical estimations. This, together with (6), leads to the CT-LSPE algorithm in Algorithm 1.

The convergence of Algorithm 1 relies on the existence of three functions ψ_i , $i = 1, 2, 3$, defined as

$$\begin{aligned} \psi_1(x) &= \mathbb{E}_x \left[\int_0^\infty (\mathbb{E}_\mu [\phi \mathcal{A} \phi^T] - \phi_t \mathcal{A} \phi_t^T) dt \right], \quad \psi_2(x) = \mathbb{E}_x \left[\int_0^\infty (\mathbb{E}_\mu [\phi \phi^T] - \phi_t \phi_t^T) dt \right], \\ \psi_3(x) &= \mathbb{E}_x \left[\int_0^\infty (\mathbb{E}_\mu [\phi r] - \phi_t r_t) dt \right]. \end{aligned}$$

These functions quantify the differences between the expectations in (5) and their corresponding empirical estimations.

Now, we impose the following assumptions on x_t and ϕ .

Assumption 1 (Ergodicity) $\{x_t\}_{t \geq 0}$ is irreducible, aperiodic, and positive recurrent.

Assumption 2 (Poisson equation) $\psi_i \in \mathcal{D}(\mathcal{A})$, $i = 1, 2, 3$.

Assumption 3 (Ito isometry) $\sup_{t \geq 0} \frac{1}{t+1} \mathbb{E}_x \left[\left| \int_0^t \phi_j(x_s) dM_s \right|^2 \right] < \infty$ for $j = 1, 2, \dots, N$.

Assumption 1 ensures that x_t is an ergodic process. Assumption 2 requires that ψ_i , $i = 1, 2, 3$, exist and are solutions to certain Poisson equations; see Glynn and Meyn (1996) for conditions under which ψ_i exists. Note that the discrete-time versions of Assumptions 1 and 2 for MDPs have been widely used in ADP and RL literature (Tsitsiklis, 1994; Tsitsiklis and Van Roy, 1997). Assumption 3 essentially requires the second moment of the stochastic integral $\int_0^t \phi_j(x_s) dM_s$, $j = 1, 2, \dots, N$, does not grow too fast. Since we can always choose a sufficiently smooth ϕ (such as the softmax function, the Gaussian function, or the wavelets) to saturate the noise in the environment, it is possible to satisfy this assumption even for a very noisy process (such as a fat-tailed process).

The convergence of Algorithm 1 is guaranteed in the following theorem.

Theorem 2 Consider Algorithm 1. Under Assumptions 1, 2, and 3, c_t converges to c^* with probability one. In addition, there exist constants $C_i > 0$, $i = 0, 1, 2$, such that for a sufficiently large ϵ ,

$$|c_t - c^*|^2 \leq \frac{\lambda_M}{\lambda_m} e^{-2(\gamma/\lambda_M - \epsilon)t + C_1} |c_0 - c^*|^2 + \frac{\lambda_M C_2 e^{C_1}}{\epsilon \lambda_m} \int_0^t \frac{1}{s+1} e^{-2(\gamma/\lambda_M - \epsilon)(t-s)} ds \quad (7)$$

Algorithm 2: Continuous-time temporal-differential (CT-TD) learning

Choose N basis functions ϕ_j . Denote $\phi = [\phi_1 \ \phi_2 \ \cdots \ \phi_N]^T$. $\alpha_t > 0$ satisfies $\dot{\alpha}_t \leq 0$, $\int_0^\infty \alpha_t^2 dt < \infty$, and $\int_0^\infty \alpha_t dt = \infty$.

Update c_t through the following SDE:

$$dc_t = \alpha_t \phi_t (c_t^T d\phi_t - \gamma c_t^T \phi_t dt + r_t dt), \quad c_0 \in \mathbb{R}^N.$$

with probability at least $1 - C_0/\epsilon^2$, where λ_M and λ_m represent the largest and smallest eigenvalues of $\mathbb{E}_\mu[\phi\phi^T]$, respectively, and $\epsilon < \gamma/\lambda_M$ is an arbitrary positive constant. In particular, (7) implies that $|c_t - c^*| = O(t^{-0.5})$ with probability one.

See Appendix B.2 for the proof of Theorem 2 and the detailed formulation of the error bound.

The first term on the right-hand-side of (7) represents the error induced from the prior guess c_0 . The second term is driven by the estimation error induced from the empirical estimation of the expectations in (5). By the law of large numbers, this estimation error converges to 0 with rate $O(t^{-0.5})$. Since $t^{-0.5}$ decreases slower than the exponential rate, it dominates the error bound of $|c_t - c^*|$. Note that the obtained convergence rate is consistent with the result in Yu and Bertsekas (2009) for discrete-time LSPE.

5.2 Continuous-time temporal-differential learning

An alternative way to approximate (5) via on-line data is to use stochastic approximation (Benveniste et al., 1990). In this case, $\mathbb{E}_\mu[\phi\mathcal{T}\phi^T]c_t + \mathbb{E}_\mu[\phi r]$ is directly replaced by the on-line data $\phi_t c_t^T d\phi_t + \phi_t r_t$ at time t . This, together with (6), leads to the CT-TD learning algorithm in Algorithm 2. To accommodate the noise induced from stochastic approximation, the matrix inverse in (5) is replaced by a slowly decreasing step size α_t . In particular, we name

$$c_t^T \frac{d}{dt} \phi_t - \gamma c_t^T \phi_t + r_t$$

as the *temporal-differential* error.

Assumption 4 (Finite moments) *There exist $C > 0$ and real-valued function φ , such that $\mathbb{E}_\mu(|\varphi|^4) < C$, $\mathbb{E}_\mu(|\psi_i|^4) < C$, $\mathbb{E}_\mu(|\mathcal{A}\psi_i|^4) < C$, $(d\phi_j(x_t))^2 \leq \varphi(x_t)dt$, and $(d\psi_{i,j}(x_t))^2 \leq \varphi(x_t)dt$, for the j -th element in ϕ and ψ_i , and $i = 1, 2, 3$.*

A discrete-time version of the boundedness condition on the high-order moments of ψ_i and $\mathcal{A}\psi_i$ is also required in Tsitsiklis and Van Roy (1997) and Benveniste et al. (1990). The conditions on $(d\phi_j(x_t))^2$ and $(d\psi_{i,j}(x_t))^2$ are new in this paper and essentially require $\psi_i(x_t)$ and ϕ_t do not vary too fast.

Theorem 3 *Consider Algorithm 2. Under Assumptions 1, 2, and 4, c_t converges to c^* with probability one. In addition, there exist constants C_0 and C_1 , such that for sufficiently large ϵ and integer k ,*

$$|c_t - c^*|^2 < \epsilon \left(|c_0 - c^*|^2 + \sqrt{A_k C_0} (2^\epsilon - 1) e^{2C_1 k} \right) e^{-2\gamma \int_0^t \alpha_s ds} \quad (8)$$

with probability at least $1 - A_k C_0 - \frac{2}{\epsilon}$, where

$$A_k = \alpha_k^2 + \int_k^\infty \alpha_t^2 dt + \left(\int_k^\infty \alpha_t^2 dt \right)^2.$$

In particular, (8) implies that $|c_t - c^*| = O\left(e^{-\gamma \int_0^t \alpha_s ds}\right)$ with probability one.

See Appendix B.3 for the proof of Theorem 3 and the detailed formulation of the error bound.

Note that as k goes to the infinity, A_k converges to 0 by the conditions on α_t in Algorithm 2. In addition, the convergence rate of A_k is slower than the exponential rate, due to the slow decreasing rate of α_t . As a result, $\lim_{k \rightarrow \infty} \sqrt{A_k} e^{2C_1 k} = \infty$, and the error bound in (8) grows with k .

A key difference between Algorithms 1 and 2 is that the time integration of the whole time series is incorporated in Algorithm 1, while only the on-line data at current time is used in Algorithm 2. As a result, Algorithm 2 may produce a much noisier estimation on the value function, especially at the beginning of the learning process. Indeed, the experimental results in Section 6.1 have shown that the point estimations produced by Algorithm 1 have smaller standard errors. In fact, to ensure the convergence of Algorithm 2, a more restrictive condition (Assumption 4) is required. In contrast, the presence of decreasing step size α_t in Algorithm 2 provides more freedom to adjust the convergence rate of the CT-TD learning. For instance, if $\alpha_t = (a + bt^\beta)^{-1}$ with $a > 0$, $b > 0$ and $0.5 < \beta \leq 1$, then we have by Lemma 11 in Appendix C that $|c_t - c^*| = O(t^{-\gamma\beta})$ for sufficiently large t .

We can see from the proofs of Algorithms 1 and 2 that the constants in the error bounds in Theorem 2 and Theorem 3 are polynomials of N , that is, the number of bases. As a result, if N increases, the error bounds in Theorems 2 and 3, which represent the estimation errors, increase as well. On the other hand, a small N also leads to a large divergence from \mathcal{H} to L_μ^2 , which is quantified by $\|(\Pi - \text{id})(\mathcal{T}V_s + r)\|_\mu$ in Theorem 1. As a result, a small N causes a large approximation error. This trade-off between approximation error and estimation error, or better known as the bias-variance trade-off, is a well-known phenomenon in various machine learning methods.

Finally, note from Algorithms 1 and 2 that the state x_t of the environment does not appear explicitly in the updating equations. Instead, the updating equations only depend on $r(x_t)$ and $\phi(x_t)$. From the perspective of control theory, the pair $(\phi(x), r(x))$ can be viewed as the output of the environment at state x . Therefore, Algorithms 1 and 2 can also be applied to output-feedback control problems and partially observable Markov processes.

6. Computer-based Experiments

In this section, we present two computer-based experiments to illustrate the effectiveness of the two learning algorithms presented in the previous section.

6.1 Continuous-time ARMA(2,1) process

Consider $\{y_t\}_{t \geq 0}$ as a real-valued continuous-time ARMA(2,1) process governed by

$$\ddot{y}_t + \theta_2 \dot{y}_t + \theta_1 y_t = \dot{\xi}_{1,t} + \sigma_1 \xi_{1,t} + \sigma_2 \xi_{2,t} + \sigma_3 \xi_{3,t},$$

where $\theta_1, \theta_2, \sigma_1, \sigma_2,$ and σ_3 are positive reals, and $\xi_{i,t}, i = 1, 2, 3,$ are three independent white noises (Arnold, 1974, Section 3.2). Denote $x_t = (y_t, \dot{y}_t - \xi_{1,t})$. Then, we can derive the following two-dimensional Ornstein–Uhlenbeck (OU) process:

$$dx_t = Ax_t dt + \Sigma dw_t, \quad A = \begin{bmatrix} 0 & 1 \\ -\theta_1 & -\theta_2 \end{bmatrix}, \quad \Sigma = \begin{bmatrix} 1 & 0 & 0 \\ \sigma_1 - \theta_2 & \sigma_2 & \sigma_3 \end{bmatrix},$$

where $w_t = [w_{1,t} \ w_{2,t} \ w_{3,t}]^T$ is a vector of three independent Brownian motions defined with $\dot{w}_i = \xi_i, i = 1, 2, 3$ (Arnold, 1974, Eq. (3.2.3)).

We know from Kushner (1967b) that the discounted value function V^* defined by (1) solves the following partial differential equation:

$$0 = -\gamma V^*(x) + \partial_x V^*(x) Ax + \frac{1}{2} \sum_{i,j} \partial_{x_i x_j}^2 V^*(x) (\Sigma \Sigma^T)_{i,j} + r(x), \quad (9)$$

where $(\Sigma \Sigma^T)_{i,j}$ denotes the (i, j) -th element in $\Sigma \Sigma^T$.

In this example, we aim at using Algorithms 1 and 2 to estimate the discounted value functions with respect to three types of running-costs. First, a quadratic function $r(x) = 10 \sum_{i=1}^2 |x_i|^2$ is used, under which (9) reduces to a Lyapunov equation. Then, we select the L^1 vector norm $r(x) = 10 \sum_{i=1}^2 |x_i|$. Finally, we choose $r(x) = 10 \sum_{i=1}^2 \mathbb{1}_{|x_i| \geq 1}$, which is essentially the 0-1 loss. See Figure 1 for an illustration of different choices of r . In all three cases, the discounting factor is fixed at $\gamma = 1$, and the step size α_t in Algorithm 2 is chosen as $\alpha_t = 0.7/(1+t)$. Model parameters of the OU process are chosen as $\theta_1 = \theta_2 = \sigma_1 = \sigma_2 = \sigma_3 = 1$, and the initial state is chosen as $x_0 = (1, 0)$. Six basis functions are selected: $\phi(x) = [1 \ x_1 \ x_2 \ x_1^2 \ x_1 x_2 \ x_2^2]$, where $x = (x_1, x_2)$.

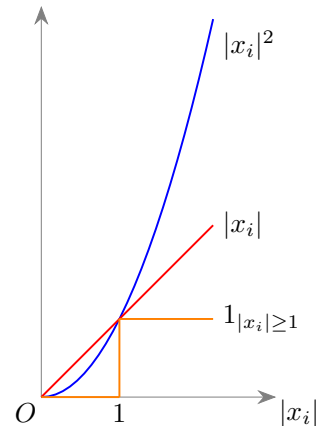
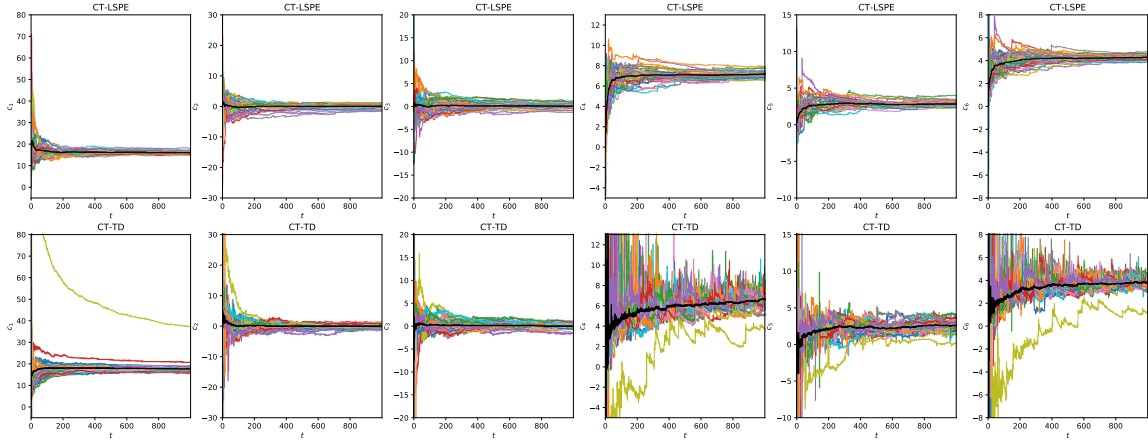
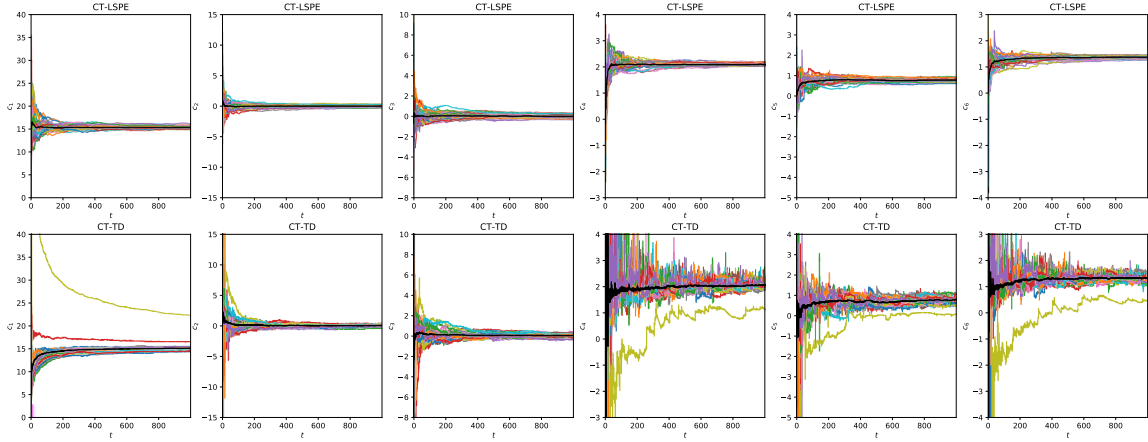

Figure 1: Comparison of different running-costs.

Figures 2 and 3 show the experimental results of our algorithms. To evaluate the performance of the algorithms, we conduct learning processes over 35 sample paths. Figure 2 illustrates the 35 paths of the weights $\{c_i\}_{i=1}^6$ corresponding to the six basis functions. Figures 3a, 3b, and 3c show the box plots of these weights at $t = 1000$. Overall, the weights obtained from both the CT-LSPE algorithm (Algorithm 1) and the CT-TD learning algorithm (Algorithm 2) converge to same values in all three cases. However, compared with the CT-LSPE, the CT-TD learning generates more dispersed samples, and the outliers are scattered further from the center of the clusters of samples. This is not surprising, as the time integration in the CT-LSPE tends to smooth out the noise in the learning process, especially at the beginning of the learning phase. Indeed, we can see from Figure 2 that CT-TD learning generates noisier paths of basis-function weights. To further illustrate the effectiveness of the proposed algorithms, we compare the value functions obtained from the two learning algorithms with that from Monte-Carlo (MC) simulations in Figures 3d, 3e, and 3f. The point estimations of value functions at $t = 1000$ with 95% confidence intervals are given in Figures 3g, 3h, and 3i. Note that in all three cases, these point estimations are approximately at the same level. In addition, compared with the CT-TD learning, the CT-LSPE produces



(a) $r(x) = 10 \sum_{i=1}^2 |x_i|^2$.



(b) $r(x) = 10 \sum_{i=1}^2 |x_i|$.

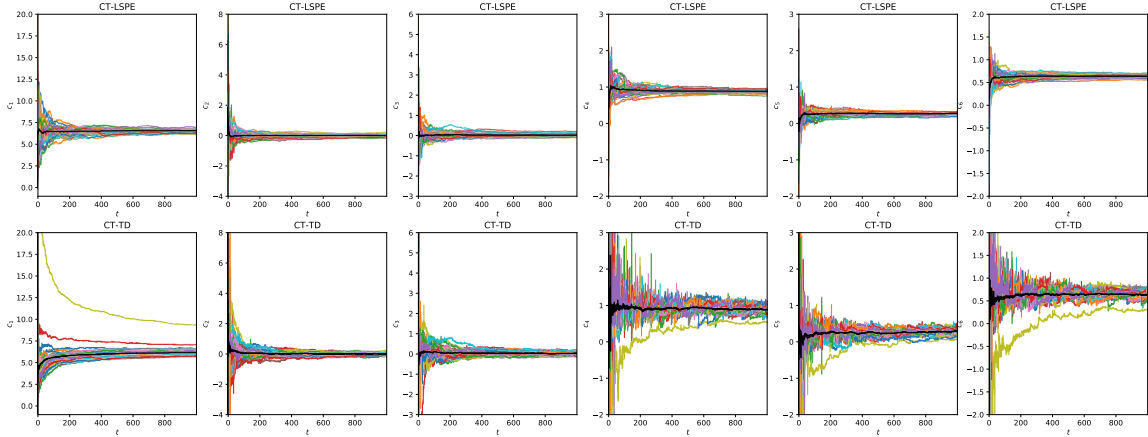

(c) $r(x) = 10 \sum_{i=1}^2 1_{|x_i| \geq 1}$.

Figure 2: Value estimation for a continuous-time ARMA(2,1) process. The weights of basis functions $(\{c_{i,t}\}_{t \geq 0}$ for $i = 1, 2, \dots, 6$) along the 35 sample paths are plotted for the three choices of r . Each color, except black, is corresponding to one sample path. The solid black lines represent the point estimations of $c_{i,t}$.

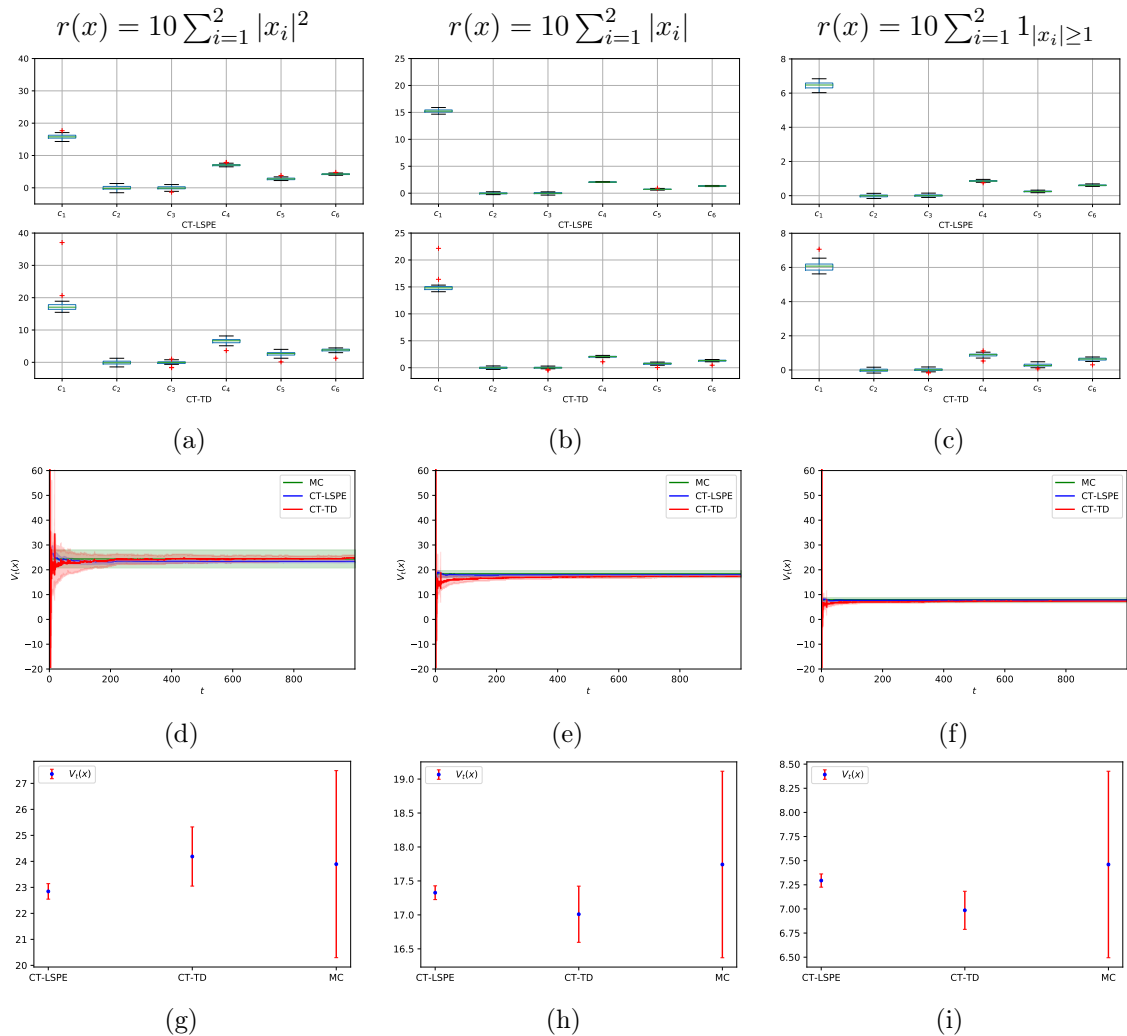

Figure 3: Value estimation for a continuous-time ARMA(2,1) process. Each one of the three columns in the figure is corresponding to one choice of r . Figures (a), (b), and (c) show the box plots of the basis-function weights $(\{c_{i,t}\}_{t \geq 0}$ for $i = 1, 2, \dots, 6$) at $t = 1000$ along the 35 sample paths. Figures (d), (e), and (f) show the estimations of the value functions $(V_t(x))$ at $x = (1, 0)$. The solid lines represent point estimations of the true values using different algorithms. The shaded areas represent 95% confidence intervals. Figures (g), (h), and (i) show the point estimations (blue dots) of $V_{1000}(x)$ at $x = (1, 0)$ with 95% confidence intervals (red bars) under different algorithms.

a smaller standard error. This result is also consistent with the observations in Figures 3a, 3b, and 3c. Finally, the MC simulation produces the largest standard error.

6.2 Control of the benchmark double inverted pendulum on a cart

In this example, we apply the CT-LSPE together with the actor-critic algorithm (Konda and Tsitsiklis, 2000) to improve the control performance of a double inverted pendulum on a cart

(DIPC) (Figure 4). It is well-known that the DIPC is a nonlinear under-actuated plant, and designing a controller for DIPC is a challenging task in the field of nonlinear control (Khalil, 2015).

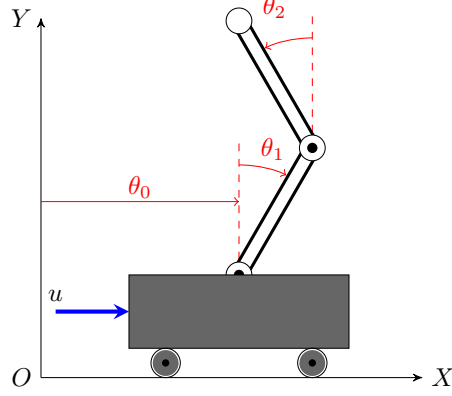

Figure 4: Double inverted-pendulum on a cart.

The mathematical model of the DIPC is given below (Moysis, 2016), which is derived from the Lagrange equations of the DIPC:

$$D(\theta)\ddot{\theta} + C(\theta, \dot{\theta})\dot{\theta} + G(\theta) = Hu,$$

where $\theta = [\theta_0 \ \theta_1 \ \theta_2]^T$, θ_0 denotes the horizontal displacement of the cart, θ_1 and θ_2 denote the angles of lower and upper pendulum links with respect to the vertical position, respectively, u is an input force applied to the cart, and

$$D(\theta) = \begin{bmatrix} C_1 & C_2 \cos \theta_1 & C_3 \cos \theta_2 \\ C_2 \cos \theta_1 & C_4 & C_5 \cos(\theta_1 - \theta_2) \\ C_3 \cos \theta_2 & C_5 \cos(\theta_1 - \theta_2) & C_6 \end{bmatrix}, \quad G(\theta) = \begin{bmatrix} 0 \\ -C_7 \sin \theta_1 \\ -C_8 \sin \theta_2 \end{bmatrix},$$

$$C(\theta, \dot{\theta}) = \begin{bmatrix} 0 & -C_2 \sin(\theta_1) \dot{\theta}_1 & -C_3 \sin(\theta_2) \dot{\theta}_2 \\ 0 & 0 & C_5 \sin(\theta_1 - \theta_2) \dot{\theta}_2 \\ 0 & -C_5 \sin(\theta_1 - \theta_2) \dot{\theta}_1 & 0 \end{bmatrix}, \quad H = \begin{bmatrix} 1 \\ 0 \\ 0 \end{bmatrix},$$

$$C_1 = m_0 + m_1 + m_2, \quad C_2 = \left(\frac{1}{2}m_1 + m_2\right)l_1, \quad C_3 = \frac{1}{2}m_2l_2, \quad C_4 = \left(\frac{1}{3}m_1 + m_2\right)l_1^2,$$

$$C_5 = \frac{1}{2}m_2l_1l_2, \quad C_6 = \frac{1}{3}m_2l_2^2, \quad C_7 = \left(\frac{1}{2}m_1 + m_2\right)l_1g, \quad C_8 = \frac{1}{2}m_2l_2g,$$

The model parameters are listed in Table 1.

Denote the state of the DIPC as $x = [\theta_0 \ \theta_1 \ \theta_2 \ \dot{\theta}_0 \ \dot{\theta}_1 \ \dot{\theta}_2]$. Now, we can rewrite the above model in the standard state-space form:

$$\dot{x} = \begin{bmatrix} 0 & I \\ 0 & -D^{-1}C \end{bmatrix} x + \begin{bmatrix} 0 \\ -D^{-1}G \end{bmatrix} + \begin{bmatrix} 0 \\ -D^{-1}H \end{bmatrix} u.$$

Note that D , C , and G are also nonlinear functions of x . Hence, the above system is an affine nonlinear system. In the learning task, at each state-action pair (x, u) , the following

Table 1: Parameters of the DIPC.

Parameters	Value	Definitions
m_0	1.5kg	Weight of the cart
m_1	0.5kg	Weight of the lower pendulum link
m_2	0.75kg	Weight of the upper pendulum link
l_1	0.5kg	Length of the lower pendulum link
l_2	0.75kg	Length of the upper pendulum link
g	9.81m/s ²	Gravity constant

quadratic running cost is used

$$r(x, u) = x^T Q x + u^2, \quad Q = \text{diag}\{100, 1000, 1000, 50, 10, 10\}.$$

We select basis functions as the 2nd order polynomials of θ_0 , θ_1 and θ_2 together with the constant function. Hence, there are totally 10 bases in our learning algorithm. The initial state of the DIPC is at $(\theta_0, \theta_1, \theta_2) = (0, 10^\circ, -10^\circ)$. Here, we only consider linear controllers. In another word, we can always write $u_t = K x_t$ for some real control gain matrix K .

The entire learning process is composed with 50 learning trials, indexed by $k = 1, 2, \dots, 50$. Each learning trial is performed over a fixed time interval $[0, t_f]$. The initial controller parameter K_1 is adopted from Moysis (2016):

$$K_1 = [-2.2361 \ 499.6181 \ -578.2160 \ -8.2155 \ 19.1832 \ -88.4892].$$

The CT-LSPE algorithm is employed in each learning trial to estimate the value function. To facilitate the learning process, we add exploration noises in the system input in each learning trial. As a result, the control action applied to the DIPC in the k -th learning trial is $u_t = K_k x_t + \text{noise}_t$, where noise_t is a stationary Gaussian process with fixed distribution $\mathcal{N}(0, \sigma)$ for all $t \in [0, t_f]$. Then, u_t has a distribution $\mathcal{N}(K_k x_t, \sigma) \triangleq \pi_k(a_t)$ in the k -th trial. Extending the actor-critic algorithm with eligibility trace in Konda (2002) to the continuous-time setting, we update the control gain matrix after finishing the k -th learning trial via

$$K_{k+1} = K_k - h z_{t_f} V_{t_f}(x_0),$$

where $h > 0$ is the step size, V_{t_f} is the value function learned in the k -th trial, and

$$z_t = \int_0^t \partial_{K_k} (\log(\pi_k(a_s))) ds \propto \int_0^t x_s^T (a_s - K_k x_s) ds$$

is the eligibility trace. Note that we only update the control gain matrix K_k at the end of each learning trial in order to increase computational efficiency.

The experimental results are given in Figures 5 and 6. We fix $h = 0.0005$ and $t_f = 800$ during the learning process. After 50 learning trials, the control gain matrix becomes

$$K_{50} = [-2.0547 \ 498.9838 \ -578.0119 \ -16.9386 \ 38.3267 \ -90.5340].$$

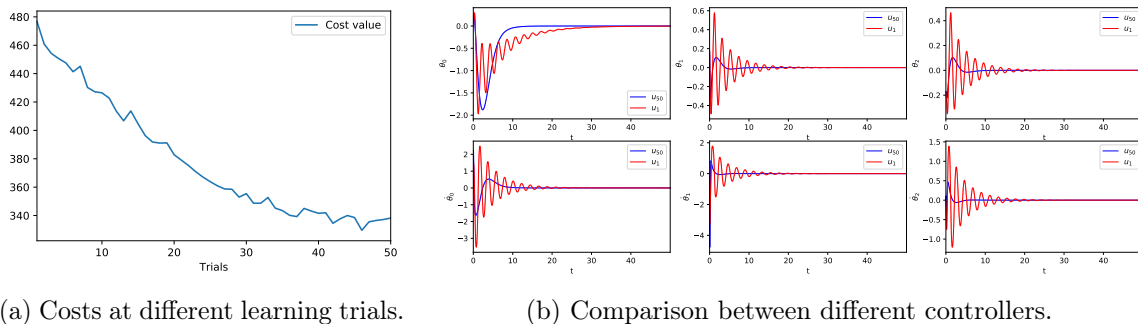

Figure 5: The value functions and system trajectories of DIPC, before and after conducting the learning process.

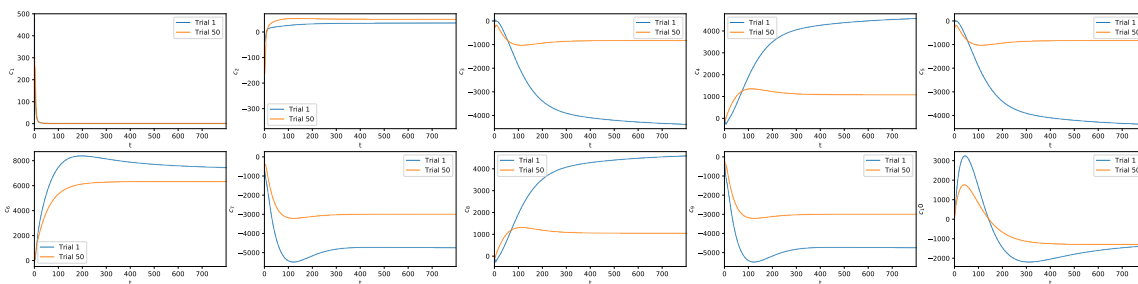

Figure 6: The weights of basis functions ($\{c_{i,t}\}_{t \geq 0}$ for $i = 1, 2, \dots, 10$) for the DIPC, in the first and the 50-th learning trials.

The cost values $V_{t_f}(x_0)$ estimated in each learning trial are plotted in Figure 5a. Clearly the cost values show a decreasing trend as the trial number increases. We also plot the system trajectories under controllers $u_1 = K_1x_t$ and $u_{50} = K_{50}x_t$ in Figure 5b, respectively. Obviously, u_{50} leads to a much better transient performance, in the sense that the DIPC shows less oscillations. Finally, the weights of basis functions ($\{c_{i,t}\}_{t \geq 0}$ for $i = 1, 2, \dots, 10$) before and after conducting the learning process are plotted in Figure 6.

7. Conclusions

This paper is motivated to provide a new RL framework for learning problems in continuous environments. A novel concept, known as the temporal-differential error, and a new class of temporal-differential learning methods, are proposed. In particular, two RL algorithms with detailed convergence analysis are designed for RL in continuous environments. Next, we point out several future research directions that deserve further investigations. First, the proposed algorithms are purely based on the temporal-differential error. It is interesting to see how to incorporate eligibility traces in RL algorithms driven by the temporal-differential error. Second, it is worth checking how to extend other existing discrete-time TD-learning-based RL algorithms to the continuous setting, by means of the techniques developed in this paper. Finally, besides the prediction problem which is the main focus of this paper, it is also important to investigate the off-policy learning problem in continuous environments.

Acknowledgments

The work of Z. P. Jiang has been supported partially by the National Science Foundation under Grants ECCS-1501044 and EPCN-1903781. The opinions expressed in this paper are those of the authors and do not necessarily reflect the views and policies of Bank of America.

Appendix A. Review of Continuous-time Markov Processes

Let $(\Omega, \mathcal{F}, \mathbb{P})$ be a probability space. Consider $\{x_t\}_{t \geq 0}$ as a homogeneous càdlàg (right continuous with left limits) strong Markov process on state space X , which is a locally compact Hausdorff space with a countable base and is equipped with the Borel σ -algebra \mathcal{B} . The definition of X covers most spaces that will be encountered in RL tasks, including Euclidean spaces, countable discrete spaces, and topological manifolds. Starting with $x_0 = x$, x_t admits a stationary probability measure μ on \mathcal{B} . Denote by \mathbb{E}_x the expectation conditionally on the initial state x and by \mathbb{E}_μ the expectation with respect to μ . $[M]_t$ denotes the quadratic variation of a real-valued stochastic process M_t defined on $(\Omega, \mathcal{F}, \mathbb{P})$.

Given the stationary distribution μ , we can define a Hilbert space L_μ^2 equipped with the inner product $\langle \cdot, \cdot \rangle_\mu$ and the norm $\| \cdot \|_\mu$:

$$\langle f, g \rangle_\mu = \int_X fg \, d\mu = \mathbb{E}_\mu [fg], \quad \|f\|_\mu = \sqrt{\langle f, f \rangle_\mu}, \quad \forall f, g \in L_\mu^2.$$

In addition, we can define an operator $P_t : L_\mu^2 \rightarrow L_\mu^2$ as

$$P_t f(x) = \mathbb{E}_x[f(x_t)], \quad \forall x \in X.$$

One can easily check that P_t is a contraction semigroup on L_μ^2 (see Lemma 4 in Section C). In addition, the infinitesimal generator \mathcal{A} associated with P_t is defined as

$$\mathcal{A}f = \lim_{t \rightarrow 0} \frac{P_t f - f}{t},$$

provided that the above limit exists. Denote the domain and the range of \mathcal{A} as $\mathcal{D}(\mathcal{A}) \subseteq L_\mu^2$ and $\mathcal{R}(\mathcal{A}) \subseteq L_\mu^2$, respectively. By Hille–Yosida theorem (Pazy, 1983), we know \mathcal{A} is closed, and $\mathcal{D}(\mathcal{A})$ is a dense subset of L_μ^2 . Since x_t is right continuous, its transition probability is stochastically continuous, and is uniquely determined by its infinitesimal generator. For additional properties on P_t and \mathcal{A} , see Nelson (1958); Pazy (1983); Hansen and Scheinkman (1995).

Appendix B. Proofs of Theorems

In this section, we present proofs of our three main theorems.

B.1 Proof of Theorem 1

We first show that V_t exists on \mathcal{H} . For any $V \in \mathcal{H}$, we have from the definition of K that

$$\begin{aligned} \langle V, \Pi \mathcal{A} V \rangle_\mu &= \int_X V(x) \int_X (\mathcal{A} V)(z) K(z, x) d\mu(z) d\mu(x) \\ &= \int_X (\mathcal{A} V)(z) \int_X V(x) K(x, z) d\mu(x) d\mu(z) \\ &= \langle V, \mathcal{A} V \rangle_\mu. \end{aligned}$$

Since \mathcal{A} generates a contraction semigroup P_t in L_μ^2 (Lemma 4), we know by Lumer–Phillips theorem (Lumer and Phillips, 1961) that \mathcal{A} is closed and dissipative. Hence, $\langle V, \mathcal{A} V \rangle_\mu \leq 0$. Thus, $\Pi \mathcal{A}$ is dissipative on \mathcal{H} , and $-\Pi \mathcal{A}$ is maximal monotone (Borwein, 2010, Proposition 1). Then, we have by Minty surjectivity theorem (Minty, 1962) that $\Pi \mathcal{A} - \text{id}$ is surjective. In addition, since \mathcal{A} is closed, we know by the definition of Π and the dominated convergence theorem that $\Pi \mathcal{A}$ is closed on \mathcal{H} . Hence, again by Lumer–Phillips theorem, $\Pi \mathcal{A}$ generates a contraction semigroup on \mathcal{H} . Then we have from Phillips (1954) that the abstract Cauchy problem (3) admits a unique solution V_t . In addition, by Hille–Yosida theorem, $(\Pi \mathcal{A} - \gamma)^{-1}$ is bounded, and hence

$$0 = \Pi(\mathcal{T} \hat{V}^* + r) = (\Pi \mathcal{A} - \gamma) \hat{V}^* + \Pi r$$

admits a unique solution \hat{V}^* on \mathcal{H} .

Denote $\tilde{V}_t = V_t - \hat{V}^*$. We next show that V_t converges to \hat{V}^* exponentially. Note from (3) and the above analysis that

$$\frac{d}{dt} \left\| \tilde{V}_t(x) \right\|_\mu^2 = 2 \int_X \tilde{V}_t(x) \int_X \left(\mathcal{A} \tilde{V}_t - \gamma \tilde{V}_t \right)(z) K(z, x) d\mu(z) d\mu(x) \leq -2\gamma \left\| \tilde{V}_t \right\|_\mu^2.$$

This implies that V_t is globally exponentially stable at \hat{V}^* .

Now, to derive the first finite-time error bound, we have

$$\|V_t - V^*\|_\mu \leq \|V_t - \hat{V}^*\|_\mu + \|\hat{V}^* - V^*\|_\mu \leq e^{-\gamma t} \|V_0 - \hat{V}^*\|_\mu + \|\hat{V}^* - V^*\|_\mu.$$

Denote $0 = \mathcal{T}(\hat{V}^*) + r + \varepsilon$, where ε is the approximation error due to Π . Using Dynkin's formula and the tower property, we have

$$\begin{aligned} \hat{V}^*(x) &= \mathbb{E}_x \left[e^{-\gamma t} \hat{V}^*(x_t) + \int_0^t e^{-\gamma s} (r(x_s) + \varepsilon(x_s)) ds \right], \\ V^*(x) &= \mathbb{E}_x \left[e^{-\gamma t} V^*(x_t) + \int_0^t e^{-\gamma s} r(x_s) ds \right]. \end{aligned}$$

Since μ is the stationary distribution, we have by Jensen's inequality and Fubini's theorem that

$$\begin{aligned} \gamma^2 \left\| \hat{V}^* - V^* \right\|_\mu^2 &= \mathbb{E}_\mu \left[\left| \mathbb{E}_x \left[\int_0^\infty \gamma e^{-\gamma s} \varepsilon(x_s) ds \right] \right|^2 \right] \leq \mathbb{E}_\mu \left[\int_0^\infty \gamma e^{-\gamma s} \varepsilon^2(x_s) ds \right] \\ &= \left\| \mathcal{T}(\hat{V}^*) + r \right\|_\mu^2. \end{aligned}$$

To derive the second finite-time error bound, we rewrite (3) as

$$\partial_t V_t(x) = \mathcal{T}V_t(x) + r(x) + \varepsilon_t(x),$$

where ε_t is the approximation error at time t . Using Dynkin's formula, we have

$$V_t(x) = \mathbb{E}_x \left[e^{-\gamma t} V_0(x_t) + \int_0^t e^{-\gamma s} (r(x_s) + \varepsilon_{t-s}(x_s)) ds \right],$$

and hence

$$V_t(x) - V^*(x) = \mathbb{E}_x \left[e^{-\gamma t} (V_0 - V^*)(x_t) + \int_0^t e^{-\gamma s} \varepsilon_{t-s}(x_s) ds \right].$$

Then,

$$\begin{aligned} & \frac{\gamma}{1 - e^{-\gamma t}} \|V_t - V^*\|_\mu \\ & \leq \frac{\gamma e^{-\gamma t}}{1 - e^{-\gamma t}} \|\mathbb{E}_x [(V_0 - V^*)(x_t)]\|_\mu + \left\| \mathbb{E}_x \left[\int_0^t \frac{\gamma e^{-\gamma s}}{1 - e^{-\gamma t}} \varepsilon_{t-s}(x_s) ds \right] \right\|_\mu \\ & = \frac{\gamma e^{-\gamma t}}{1 - e^{-\gamma t}} \sqrt{\mathbb{E}_\mu \left[|\mathbb{E}_x [(V_0 - V^*)(x_t)]|^2 \right]} + \sqrt{\mathbb{E}_\mu \left[\left| \mathbb{E}_x \left[\int_0^t \frac{\gamma e^{-\gamma s}}{1 - e^{-\gamma t}} \varepsilon_{t-s}(x_s) ds \right] \right|^2 \right]} \\ & \leq \frac{\gamma e^{-\gamma t}}{1 - e^{-\gamma t}} \sqrt{\mathbb{E}_\mu \left[|(V_0 - V^*)(x_t)|^2 \right]} + \sqrt{\mathbb{E}_\mu \left[\left| \int_0^t \frac{\gamma e^{-\gamma s}}{1 - e^{-\gamma t}} \varepsilon_{t-s}(x_s) ds \right|^2 \right]} \end{aligned} \quad (10)$$

$$\begin{aligned} & \leq \frac{\gamma e^{-\gamma t}}{1 - e^{-\gamma t}} \|V_0 - V^*\|_\mu + \sqrt{\int_0^t \frac{\gamma e^{-\gamma s}}{1 - e^{-\gamma t}} \|\varepsilon_{t-s}\|_\mu^2 ds} \\ & = \frac{\gamma e^{-\gamma t}}{1 - e^{-\gamma t}} \|V_0 - V^*\|_\mu + \sqrt{\int_0^t \frac{\gamma e^{-\gamma(t-s)}}{1 - e^{-\gamma t}} \|(\Pi - \text{id})(\mathcal{T}V_s + r)\|_\mu^2 ds} \\ & \leq \frac{\gamma e^{-\gamma t}}{1 - e^{-\gamma t}} \|V_0 - V^*\|_\mu + \sup_{s \in [0, t]} \|(\Pi - \text{id})(\mathcal{T}V_s + r)\|_\mu, \end{aligned} \quad (11)$$

where (10) and (11) above are due to Jensen's inequality. This completes the proof.

B.2 Proof of Theorem 2

We first show $R_t = \left(\int_0^t \phi_s \phi_s^T ds + \rho I \right)^{-1}$. Since

$$\frac{d}{dt} \left(R_t \left(\int_0^t \phi_s \phi_s^T ds + \rho I \right) \right) = \dot{R}_t \left(\int_0^t \phi_s \phi_s^T ds + \rho I \right) + R_t \phi_t \phi_t^T,$$

$R_t = \left(\int_0^t \phi_s \phi_s^T ds + \rho I \right)^{-1}$ solves the ODE of R_t in Algorithm 1. Since the right-hand-side of the ODE of R_t is locally Lipschitz, and $\left(\int_0^t \phi_s \phi_s^T ds + \rho I \right)^{-1}$ is bounded, we can select a sufficiently large subset S of the space of all symmetric positive definite matrices, such that

$R_t = \left(\int_0^t \phi_s \phi_s^T ds + \rho I \right)^{-1}$ is a unique solution of the ODE of R_t on S , and it also remains in S .

We next denote

$$\begin{aligned} A_t &\triangleq \frac{1}{t+1} \int_0^t \phi_s (\mathcal{A}\phi_s - \gamma\phi_s)^T ds, & b_t &\triangleq \frac{1}{t+1} \int_0^t \phi_s r_s ds, \\ \Sigma_t &\triangleq \frac{1}{t+1} \left(\int_0^t \phi_s \phi_s^T ds + \rho I \right), & \eta_t &\triangleq \frac{1}{t+1} \int_0^t \phi_s dM_s^T. \end{aligned}$$

Then, we can rewrite the updating equation of c_t in Algorithm 1 as

$$\dot{c}_t = \Sigma^{-1} A c_t + \Sigma^{-1} b + (\Sigma_t^{-1} A_t - \Sigma^{-1} A) c_t + \Sigma_t^{-1} b_t - \Sigma^{-1} b + \Sigma_t^{-1} \eta_t c_t, \quad (12)$$

where

$$A \triangleq \int_X \phi (\mathcal{A}\phi - \gamma\phi)^T d\mu, \quad b \triangleq \int_X \phi r d\mu, \quad \Sigma \triangleq \int_X \phi \phi^T d\mu.$$

Let $\tilde{c}_t = c_t - c^*$. Then,

$$\dot{\tilde{c}}_t = \Sigma^{-1} A \tilde{c}_t + (\Sigma_t^{-1} A_t - \Sigma^{-1} A + \Sigma_t^{-1} \eta_t) \tilde{c}_t + \Sigma_t^{-1} b_t - \Sigma^{-1} b + (\Sigma_t^{-1} A_t - \Sigma^{-1} A + \Sigma_t^{-1} \eta_t) c^*.$$

By Assumptions 2, we have

$$\mathcal{A}\psi_i(x_s) = \Delta_{i,s},$$

where $i = 2, 3, 4$, $\psi_4 = \psi_1 - \gamma\psi_3$, and

$$\Delta_{2,s} = \phi(x_s) \phi^T(x_s) - \Sigma, \quad \Delta_{3,s} = \phi(x_s) r(x_s) - b, \quad \Delta_{4,s} = \phi(x_s) (\mathcal{A}\phi^T(x_s) - \gamma\phi^T(x_s)) - A.$$

Then, we have by Lemma 6 (element-wise) that

$$\lim_{t \rightarrow \infty} \mathbb{E}_x [\psi_i(x_t)] = 0, \quad \sup_{t \geq 0} \frac{1}{t+1} \mathbb{E}_x \left[\left| \int_0^t \Delta_{i,s} ds \right|^2 \right] < \infty, \quad i = 2, 3, 4.$$

Now consider the boundedness of η_t . The quadratic variation of the j -th element in M_t is given below:

$$d[M_j]_t = (dM_{j,t})^2 = (d\phi_j(x_t))^2 + O(dt^2).$$

By Assumption 3 and Ito's isometry, we have

$$\sup_{t \geq 0} (t+1) \mathbb{E}_x \left[|\eta_t|^2 \right] < \infty.$$

Applying Lemma 5 with $\alpha_t = 1/\sqrt{t+1}$, we know with probability one that A_t , b_t , and Σ_t converge to A , b , and Σ , respectively. In addition, we know with a probability at least of $1 - C_0/\epsilon^2$ that

$$|A_t - A| \leq \frac{\epsilon}{\sqrt{t+1}}, \quad |b_t - b| \leq \frac{\epsilon}{\sqrt{t+1}}, \quad |\Sigma_t - \Sigma| \leq \frac{\epsilon}{\sqrt{t+1}}, \quad \text{and} \quad |\eta_t| \leq \frac{\epsilon}{\sqrt{t+1}},$$

for all $t \geq 0$, where

$$C_0 = \sup_{t \geq 0} \max \left\{ (t+1) \mathbb{E}_x \left[|\eta_t|^2 \right], \frac{1}{t+1} \mathbb{E}_x \left[\left| \int_0^t \Delta_{i,s} ds \right|^2 \right], i = 2, 3, 4 \right\}.$$

As a result, by the boundedness of A_t , b_t , Σ_t , and η_t , we have with a probability at least $1 - C_0/\epsilon^2$ that

$$\begin{aligned} |\Sigma_t^{-1}| &\leq \rho_0, \quad |I - \Sigma \Sigma_t^{-1}| \leq |\Sigma_t - \Sigma| |\Sigma_t^{-1}| \leq \frac{\epsilon \rho_0}{t+1}, \\ |\Sigma \Sigma_t^{-1}| &\leq 1 + \frac{\epsilon \rho_0}{t+1}, \quad |\Sigma \Sigma_t^{-1} \eta_t| \leq \frac{\epsilon(1 + \epsilon \rho_0)}{\sqrt{t+1}}, \\ |\Sigma \Sigma_t^{-1} A_t - A| &\leq |\Sigma \Sigma_t^{-1}| |A_t - A| + |\Sigma \Sigma_t^{-1} - I| |A| \leq \frac{\epsilon}{\sqrt{t+1}} (\epsilon \rho_0 + \rho_0 |A| + 1), \\ |\Sigma \Sigma_t^{-1} b_t - b| &\leq \frac{\epsilon}{\sqrt{t+1}} (\epsilon \rho_0 + \rho_0 |b| + 1), \end{aligned}$$

where

$$\rho_0 = \frac{\epsilon + |\Sigma|}{|\Sigma|^2} + \frac{(\epsilon + |\Sigma|)^2}{\rho |\Sigma|^2}.$$

Applying Lemma 7, we know c_t converges to c^* with probability one. In addition,

$$|c_t - c^*|^2 \leq \frac{\lambda_M}{\lambda_m} e^{\zeta(t,0)} |c_0 - c^*|^2 + \frac{\lambda_M}{\epsilon \lambda_m} \int_0^t \xi(s) e^{\zeta(t,s)} ds$$

with a probability at least $1 - C_0/\epsilon^2$, where λ_M and λ_m represent the largest and the smallest eigenvalues of Σ , respectively, $\epsilon < 2\gamma/\lambda_M$ is an arbitrary positive constant, and by Lemma 9,

$$\begin{aligned} \zeta(t, s) &= - \left(\frac{2\gamma}{\lambda_M} - \epsilon \right) (t - s) + 4\epsilon (2 + 2\epsilon \rho_0 + \rho_0 |A|) (\sqrt{t+1} - \sqrt{s+1}) \\ &\leq -2 \left(\frac{\gamma}{\lambda_M} - \epsilon \right) (t - s) + C_1, \\ \xi(s) &= \frac{C_2}{s+1}, \end{aligned}$$

where

$$C_1 = \epsilon + \frac{4\epsilon^2 (2 + 2\epsilon \rho_0 + \rho_0 |A|)^2}{\epsilon}, \quad C_2 = \epsilon^2 (\rho_0 (|b| + |A| |c^*|) + (1 + \epsilon \rho_0)(1 + 2|c^*|))^2.$$

In particular, we know by Lemma 10 that $|c_t - c^*|^2 = O(t^{-1})$. This completes the proof.

B.3 Proof of Theorem 3

First, we introduce the following auxillary system:

$$\dot{\hat{c}}_t = \alpha_t (A \hat{c}_t + b), \quad \hat{c}_0 = c_0,$$

where A and b follow the definitions in Appendix B.2.

We first show that \hat{c}_t converges to c^* . Indeed, a direct calculation shows that

$$\frac{d}{dt} |\hat{c}_t - c^*|^2 = 2\alpha_t(\hat{c}_t - c^*)^T A(\hat{c}_t - c^*) \leq -2\gamma\alpha_t |\hat{c}_t - c^*|^2.$$

By the comparison lemma (Sontag, 1998, Lemma C.3.1), we have

$$|\hat{c}_t - c^*|^2 \leq e^{-2\gamma \int_0^t \alpha_s ds} |\hat{c}_0 - c^*|^2.$$

Since $\int_0^\infty \alpha_t dt = \infty$, \hat{c}_t converges to c^* as t goes to the infinity.

Denote $\tilde{c} = c - \hat{c}$. We can rewrite the updating equation in Algorithm 2 as

$$d\tilde{c}_t = \alpha_t(A\tilde{c}_t + \Delta_{4,t}\tilde{c}_t + \Delta_{4,t}\hat{c}_t + \Delta_{3,t})dt + \alpha_t\phi(x_t)(\tilde{c}_t + \hat{c}_t)^T dM_t, \quad \tilde{c}_0 = 0,$$

where $\Delta_{3,t}$ and $\Delta_{4,t}$ follow the definitions in Appendix B.2.

Note that $c^T dM = \sum_j c_j dM_j$, where dM_j denotes the j -th element in dM . Now the proof is completed by applying Lemma 8.

Appendix C. Technical Lemmas

In this section, we present several supporting lemmas that have been used in the proofs of our main results.

Lemma 4 P_t is a contraction semigroup in L_μ^2 .

Proof We have by Jensen's inequality that

$$\|P_t f\|_\mu^2 = \int_X |P_t f(x)|^2 d\mu(x) \leq \int_X P_t(f^2)(x) d\mu(x) = \int_X f^2(x) d\mu(x) = \|f\|_\mu^2, \quad \forall f \in L_\mu^2.$$

This completes the proof. ■

Lemma 5 Suppose S_t is a time series satisfying

$$\alpha_t^2 \mathbb{E}[S_t^2] \leq C, \quad \forall t \geq 0,$$

for some $C < \infty$, where $\alpha_t > 0$ is deterministic and decreases monotonically to 0. Then, for any $\epsilon > \sqrt{C}$,

$$\mathbb{P}\left(\sup_{t \geq 0} |\alpha_t S_t| < \epsilon\right) > 1 - \frac{1}{\epsilon^2} C.$$

In particular, $\alpha_t^2 S_t = O(\alpha_t)$ with probability one.

Proof Denote events

$$E_T = \left\{ \max_{0 \leq t \leq T} |\alpha_t S_t| > \epsilon \right\}, \quad \forall T \geq 0.$$

By Markov's inequality, $\mathbb{P}(E_T) \leq C/\epsilon^2$. Since E_T is increasing, by monotone convergence theorem,

$$\lim_{T \rightarrow \infty} \mathbb{P}(E_T) = \mathbb{P}\left(\lim_{T \rightarrow \infty} E_T\right) = \mathbb{P}\left(\sup_{t \geq 0} |\alpha_t S_t| > \epsilon\right) \leq \frac{1}{\epsilon^2} C.$$

Letting ϵ go to the infinity, we have

$$\mathbb{P}\left(\sup_{t \geq 0} |\alpha_t S_t| < \infty\right) = 1.$$

This completes the proof. ■

Lemma 6 *Suppose Assumption 1 holds. Denote by ψ the solution to the following Poisson equation:*

$$\mathcal{A}\psi(x_t) = f(x_t) - \mathbb{E}_\mu[f].$$

Then,

$$\lim_{t \rightarrow \infty} \mathbb{E}_x[\psi(x_t)] = 0, \quad \limsup_{t \rightarrow \infty} \frac{1}{t} \mathbb{E}_x \left[\left| \int_0^t \mathcal{A}\psi(x_t) dt \right|^2 \right] < \infty.$$

Proof Since $\psi \in \mathcal{D}(\mathcal{A})$, $\mathbb{E}_\mu[\psi^2] < \infty$ and $\mathbb{E}_\mu[f^2] < \infty$. By Assumption 1 and the ergodic theorems (Kontoyiannis and Meyn, 2003, Theorem 2.2 and Corollary 2.3),

$$\lim_{t \rightarrow \infty} \mathbb{E}_x[\psi(x_t)] = \mathbb{E}_\mu[\psi] = 0, \quad \lim_{t \rightarrow \infty} \mathbb{E}_x[f^2(x_t)] = \mathbb{E}_\mu[f^2].$$

Denote

$$m_t = \psi(x_t) - \psi(x) + \int_0^t \mathcal{A}\psi(x_s) ds.$$

Then m is a martingale, and we have by the martingale property that

$$\mathbb{E}_x[m_t^2] = \mathbb{E}_x \left[\left(\sum_i \Delta m_{i,t} \right)^2 \right] = \sum_i \mathbb{E}_x[(\Delta m_{i,t})^2] = \sum_i \mathbb{E}_x \left[\left(\frac{\Delta m_{i,t}}{\sqrt{\Delta t_i}} \right)^2 \Delta t_i \right],$$

where $0 = t_1 < t_2 < \dots = t$ is a set of partition points on the interval $[0, t]$, $\Delta t_i = t_{i+1} - t_i$, and

$$\Delta m_{i,t} = \psi(x_{t_{i+1}}) - \psi(x_{t_i}) + \int_{t_i}^{t_{i+1}} \mathcal{A}\psi(x_s) ds.$$

We next quantify $\mathbb{E}_x[m_t^2]$ by inspecting $\mathbb{E}_x[\Delta m_{i,t}^2]$. By Hölder's inequality,

$$\mathbb{E}_x \left[\left(\frac{1}{\sqrt{\Delta t_i}} \int_{t_i}^{t_{i+1}} \mathcal{A}\psi(x_s) ds \right)^2 \right] \leq \int_{t_i}^{t_{i+1}} \mathbb{E}_x [(\mathcal{A}\psi(x_s))^2] ds = O(\Delta t_i),$$

where the last equality holds since the integrand is bounded. In addition,

$$\begin{aligned}
 & \mathbb{E}_x \left[(\psi(x_{t_{i+1}}) - \psi(x_{t_i}))^2 \right] \\
 &= \mathbb{E}_x \left[\psi^2(x_{t_{i+1}}) - 2\psi(x_{t_{i+1}})\psi(x_{t_i}) + \psi^2(x_{t_i}) \right] \\
 &= \mathbb{E}_x \left[\psi^2(x_{t_{i+1}}) \right] + \mathbb{E}_x \left[\psi^2(x_{t_i}) \right] - 2\mathbb{E}_x \left[P_{\Delta t_i} \psi(x_{t_i}) \psi(x_{t_i}) \right] \\
 &= \mathbb{E}_x \left[\psi^2(x_{t_{i+1}}) \right] - \mathbb{E}_x \left[\psi^2(x_{t_i}) \right] - 2\mathbb{E}_x \left[(P_{\Delta t_i} - \text{id}) \psi(x_{t_i}) \psi(x_{t_i}) \right] \\
 &= \mathbb{E}_x \left[\psi^2(x_{t_{i+1}}) \right] - \mathbb{E}_x \left[\psi^2(x_{t_i}) \right] - 2\Delta t_i \mathbb{E}_x \left[\frac{(P_{\Delta t_i} - \text{id}) \psi(x_{t_i})}{\Delta t_i} \psi(x_{t_i}) \right].
 \end{aligned}$$

Putting the above items back into the summation in $\mathbb{E}_x[m_t^2]$ and letting Δt_i go to 0, we have

$$\mathbb{E}_x[m_t^2] = \mathbb{E}_x \left[\psi^2(x_t) \right] - \psi^2(x) - 2 \int_0^t \mathbb{E}_x \left[\mathcal{A} \psi(x_s) \psi(x_s) \right] ds.$$

Since both ψ and f are square integrable, $\limsup_{t \rightarrow \infty} t^{-1} \mathbb{E}_x[m_t^2] < \infty$. This completes the proof. \blacksquare

Lemma 7 *Consider the following system:*

$$\dot{c}_t = (\Sigma^{-1}A + \Delta A_t)c_t + \Delta_t,$$

where Σ is a symmetric positive definite matrix, A is a negative definite real matrix, and ΔA_t and Δ_t are random variables bounded with probability one. Assume

$$\lim_{t \rightarrow \infty} \frac{1}{t} \int_0^t |\Delta A_s| ds = 0$$

for all $\omega \in E \in \mathcal{F}$. Then c is input-to-state stable (ISS) (Sontag, 2008) over E , from Δ_t to c_t .

Proof Consider the Lyapunov function $V(c) = c^T \Sigma c$. Given $\omega \in E$,

$$\begin{aligned}
 \dot{V}(c_t) &= -c_t^T (A + A^T) c_t + 2c_t^T \Sigma \Delta A_t c_t + 2c_t^T \Sigma \Delta_t \\
 &\leq -(\gamma - \varepsilon |\Sigma| - 2|\Sigma| |\Delta A_t|) |c_t|^2 + \frac{1}{\varepsilon} \Delta_t^T \Sigma \Delta_t \\
 &\leq -(\gamma |\Sigma|^{-1} - \varepsilon - 2|\Delta A_t|) V(c_t) + \frac{1}{\varepsilon} \Delta_t^T \Sigma \Delta_t,
 \end{aligned}$$

where $\gamma > 0$ satisfies $A^T + A \leq -\gamma I$, and $\varepsilon < \gamma |\Sigma|^{-1}$ is a positive constant. Reformulating the above inequality, we have

$$\frac{d}{dt} \left(V(c_t) e^{(\gamma |\Sigma|^{-1} - \varepsilon)t - 2 \int_0^t |\Delta A_s| ds} \right) \leq \frac{|\Sigma|}{\varepsilon} |\Delta_t|^2 e^{(\gamma |\Sigma|^{-1} - \varepsilon)t - 2 \int_0^t |\Delta A_s| ds}.$$

Hence,

$$|c_t|^2 \leq \frac{\lambda_M}{\lambda_m} e^{-(|\gamma/\lambda_M - \varepsilon)t + 2 \int_0^t |\Delta A_s| ds} |c_0|^2 + \frac{\lambda_M}{\varepsilon \lambda_m} \int_0^t e^{-(\gamma/\lambda_M - \varepsilon)(t-s) + 2 \int_s^t |\Delta A_\tau| d\tau} |\Delta_s|^2 ds.$$

where λ_M and λ_m represent the largest and the smallest eigenvalues of Σ , respectively. One can see from the above inequality and our assumption on ΔA that c_t is ISS, from Δ_t to c_t . This completes the proof. \blacksquare

Lemma 8 *Consider the following system:*

$$dc_t = \alpha_t(Ac_t + \Delta_{1,t}c_t + \Delta_{2,t})dt + \alpha_t \sum_{j=1}^N g_{j,t}(c_t)dM_{j,t}, \quad (13)$$

where A is a real matrix satisfying $A + A^T < -2\gamma I$ for some $\gamma > 0$, $\alpha_t > 0$ is continuously differentiable with $\dot{\alpha}_t \leq 0$, $\lim_{t \rightarrow \infty} \alpha_t = 0$ and $\int_0^\infty \alpha_t = \infty$, g_j is a vector-valued function, M_j is a real-valued martingale, and $\Delta_{1,t}$ and $\Delta_{2,t}$ are random variables that are bounded with probability one and satisfy

$$d\psi_{i,t} = \Delta_{i,t}dt + dm_{i,t}, \quad \mathbb{E}_\mu[\Delta_{i,t}] = 0,$$

for some martingales m_i , $i = 1, 2$. In addition, M_j and m_i are adapted to a filtration $\{\mathcal{F}_t\}_{t \geq 0}$, and there exist a function φ and a constant $C > 0$, such that $d[M_j]_t \leq \varphi_t dt$ and $d[m_{i,k}]_t \leq \varphi_t dt$ for the k -th elements in m_i , and

$$\mathbb{E}_0[|\Delta_{i,t}|^4] \leq C, \quad \mathbb{E}_0[|\psi_{i,t}|^4] \leq C, \quad \mathbb{E}_0[\varphi_t^4] \leq C, \quad \mathbb{E}_0\left[\left|\frac{g_{j,t}(c)}{1+|c|}\right|^8\right] \leq C,$$

for all c , where \mathbb{E}_0 denotes the expectation conditional on \mathcal{F}_0 .

Given the above conditions, we have

$$\mathbb{P}\left(|c_t|^2 < \epsilon \left(|c_0|^2 + \sqrt{A_n C_0} b^2 e^{2\lambda(n+1)}\right) e^{-2\gamma \int_0^t \alpha_s ds}\right) > 1 - A_n C_0 - \frac{2}{\epsilon},$$

where $b = \max\{1, |c_0|\}$,

$$A_n = \alpha_n^2 + \left(\int_n^\infty \alpha_t^2 dt\right)^2 + \int_n^\infty \alpha_t^2 dt,$$

$$\lambda = \frac{\alpha_0 (b^2 + 1)^{1/\epsilon}}{2(b^2 + 1)^{1/\epsilon} - 2} \left(2\sqrt[4]{C} + (2\alpha_0 N^2 + 1)\sqrt{C} + 1\right) + \frac{\log 2}{2},$$

C_0 is a positive constant, and n and ϵ are sufficiently large integers and reals, respectively.

Proof The proof contains three parts. First, we show $|c_t|$ cannot grow faster than the exponential rate. Second, we show $|c_t|$ is bounded. Finally, we show $|c_t|$ is asymptotically stable at the origin.

First, given $\lambda > 0$ and $b = \max\{1, |c_0|\}$, we define $B_b = \{\omega \in \Omega : |c_t(\omega)| < be^{\lambda t} \text{ for all } t\}$ and

$$\sigma_n(\omega) = \inf\left\{t : |c_t(\omega)| = be^{\lambda n}\right\}, \quad \tau_n(\omega) = \sup\left\{t < \sigma_{n+1}(\omega) : |c_t(\omega)| = be^{\lambda n}\right\}, \quad n \geq 1.$$

Then, $\sigma_n \leq \tau_n < \sigma_{n+1}$. Obviously, for any $\omega \in B_b$, we have $\sigma_n(\omega) \geq n$ for all n . Denote $E_n = \{\omega \in \Omega : \sigma_n(\omega) < \infty\}$, $E_{n,b} = \{\omega \in B_b : \sigma_n(\omega) < \infty\}$, and $\mathbb{E}_0^E[Y] = \mathbb{E}_0[Y \cdot 1_{\omega \in E}]$ for any $E \in \mathcal{F}$ and random variable Y . Note that for any measurable function $f \geq 0$, $\mathbb{E}_0^E[f] = \mathbb{E}_0[f \cdot 1_{\omega \in E}] \leq \mathbb{E}_0[f]$.

Denote $z_t = e^{-\lambda t} c_t$. Then,

$$dz_t = -\lambda z_t + \alpha_t(Az_t + \Delta_{1,t}z_t + e^{-\lambda t}\Delta_{2,t})dt + \alpha_t e^{-\lambda t} \sum_{j=1}^N g_{j,t}(c_t) dM_{j,t},$$

Define $V(z) = \log(|z|^2 + 1)$. Then the Hessian of V is

$$\frac{2(|z|^2 + 1)I - 4zz^T}{(|z|^2 + 1)^2} \leq \frac{2}{|z|^2 + 1}I \leq \frac{4}{(|z| + 1)^2}I,$$

and we have for any $|z_t| \geq \delta$, where $0 < \delta \leq b$, that

$$\mathcal{A}V(z_t) \leq -\frac{2\lambda\delta^2}{1 + \delta^2} + \bar{\Delta}_t.$$

where

$$\bar{\Delta}_t = \alpha_t(2|\Delta_{1,t}| + 1 + |\Delta_{2,t}|^2) + 2\alpha_t^2 N \sum_{j=1}^N \frac{|g_{j,t}(c_t)|^2 \varphi_t}{(|c_t| + 1)^2}.$$

By Dynkin's formula, whenever $|z_\sigma| \geq \delta$ for some $\sigma \geq 0$, one has

$$\mathbb{E}_\sigma[V(z_{\min(t, \tau_\sigma)})] \leq V(z_\sigma) + \mathbb{E}_\sigma \int_\sigma^{\min(t, \tau_\sigma)} \left(-\frac{2\lambda\delta^2}{1 + \delta^2} + \bar{\Delta}_s \right) ds,$$

where τ_σ is the first time after σ at which z_{τ_σ} exists $\{z : |z| \geq \delta\}$. By the definition of λ , $\sup_t \mathbb{E}_0[\bar{\Delta}_t] < 2\lambda\delta^2(1 + \delta^2)^{-1}$. Now, we have from the tower property that $\sup_t \mathbb{E}_0[V(z_t)] \leq V(z_0)$. Thus, by Markov's inequality, one has

$$\mathbb{P}(B_b) = \mathbb{P}(V(z_t) < \log(b^2 + 1)) > 1 - \frac{\log(\delta^2 + 1)}{\log(b^2 + 1)}, \quad \forall t \geq 0.$$

Hence, z_t is bounded with probability one.

Now, we show $|c_t|$ is bounded. On one hand, we have on E_{n+1} that

$$|c_{\sigma_{n+1}}|^2 - |c_{\tau_n}|^2 = b^2 e^{2\lambda(n+1)} - b^2 e^{2\lambda n} \geq b^2 e^{2\lambda n} > 0. \quad (14)$$

On the other hand, we can derive that

$$\begin{aligned}
 & d\left(\frac{1}{2}|c_t|^2 - \alpha_t c_t^T(\psi_{1,t}c_t + \psi_{2,t})\right) \\
 &= c_t^T dc_t + \frac{1}{2}dc_t^T dc_t - d\alpha_t c_t^T(\psi_{1,t}c_t + \psi_{2,t}) - \alpha_t dc_t^T(\psi_{1,t}c_t + \psi_{2,t}) \\
 &\quad - \alpha_t c_t^T(\psi_{1,t}dc_t + d\psi_{1,t}c_t + d\psi_{2,t}) - \alpha_t dc_t^T(\psi_{1,t}dc_t + d\psi_{1,t}c_t + d\psi_{2,t}) - \alpha_t c_t^T d\psi_{1,t}dc_t \\
 &\leq \alpha_t c_t^T (Ac_t + \Delta_{1,t}c_t + \Delta_{2,t})dt + \alpha_t c_t^T \sum_{j=1}^N g_{j,t}(c_t)dM_{j,t} + \alpha_t^2 \frac{N}{2} \sum_{j=1}^N |g_{j,t}(c_t)|^2 \varphi_t dt \\
 &\quad - \dot{\alpha}_t c_t^T(\psi_{1,t}c_t + \psi_{2,t})dt - \alpha_t c_t^T (d\psi_{1,t}c_t + d\psi_{2,t}) \\
 &\quad - \alpha_t (2(\psi_{1,t} + d\psi_{1,t})c_t + (\psi_{2,t} + d\psi_{2,t}))^T dc_t - \alpha_t dc_t^T \psi_{1,t}dc_t \\
 &\leq -\alpha_t c_t^T (dm_{1,t}c_t + dm_{2,t}) + \alpha_t c_t^T \sum_{j=1}^N g_{j,t}(c_t)dM_{j,t} + \alpha_t^2 \frac{N}{2} \sum_{j=1}^N |g_{j,t}(c_t)|^2 \varphi_t dt \\
 &\quad - \dot{\alpha}_t c_t^T(\psi_{1,t}c_t + \psi_{2,t})dt - \alpha_t^2 (2\psi_{1,t}c_t + \psi_{2,t})^T (Ac_t + \Delta_{1,t}c_t + \Delta_{2,t})dt \\
 &\quad - \alpha_t^2 (2\psi_{1,t}c_t + \psi_{2,t})^T \sum_{j=1}^N g_{j,t}(c_t)dM_{j,t} + \alpha_t^3 N |\psi_{1,t}| \sum_{j=1}^N |g_{j,t}(c_t)|^2 \varphi_t dt \\
 &\quad + \alpha_t^2 |c_t|^2 \sum_{k=1}^{N^2} (dm_{1,k,t})^2 + \alpha_t^2 \frac{3N}{2} \sum_{j=1}^N |g_{j,t}(c_t)|^2 \varphi_t dt + \frac{1}{2}\alpha_t^2 |d\psi_{2,t}|^2,
 \end{aligned}$$

where $m_{1,k}$ is the k -th element in m_1 . Taking integration on both sides of the above inequality, we have for any $\omega \in E_{n+1}$ that

$$\begin{aligned}
 0 &< \frac{1}{2} (|c_{\sigma_{n+1}}|^2 - |c_{\tau_n}|^2) \\
 &\leq \alpha_{\sigma_{n+1}} c_{\sigma_{n+1}}^T (\psi_{1,\sigma_{n+1}}c_{\sigma_{n+1}} + \psi_{2,\sigma_{n+1}}) - \alpha_{\tau_n} c_{\tau_n}^T (\psi_{1,\tau_n}c_{\tau_n} + \psi_{2,\tau_n}) - \int_{\tau_n}^{\sigma_{n+1}} \alpha_t c_t^T dm_{1,t}c_t \\
 &\quad - \int_{\tau_n}^{\sigma_{n+1}} \alpha_t c_t^T dm_{2,t} + N \sum_{j=1}^N \int_{\tau_n}^{\sigma_{n+1}} \alpha_t^2 (2 + \alpha_t |\psi_{1,t}|) |g_{j,t}(c_t)|^2 \varphi_t dt \\
 &\quad - \int_{\tau_n}^{\sigma_{n+1}} \dot{\alpha}_t c_t^T (\psi_{2,t} + \psi_{1,t}c_t) dt - 2 \int_{\tau_n}^{\sigma_{n+1}} \alpha_t^2 c_t^T \psi_{1,t}^T (A + \Delta_{1,t})c_t dt \\
 &\quad - \int_{\tau_n}^{\sigma_{n+1}} \alpha_t^2 c_t^T (2\psi_{1,t}^T \Delta_{2,t} + (A + \Delta_{1,t})^T \psi_{2,t}) dt - \int_{\tau_n}^{\sigma_{n+1}} \alpha_t^2 \psi_{2,t}^T \Delta_{2,t} dt \\
 &\quad + \sum_{j=1}^N \int_{\tau_n}^{\sigma_{n+1}} \alpha_t c_t^T (1 - 2\alpha_t \psi_{1,t}^T) g_{j,t}(c_t) dM_{j,t} - \sum_{j=1}^N \int_{\tau_n}^{\sigma_{n+1}} \alpha_t^2 \psi_{2,t}^T g_{j,t}(c_t) dM_{j,t} \\
 &\quad + \sum_{k=1}^{N^2} \int_{\tau_n}^{\sigma_{n+1}} \alpha_t^2 |c_t|^2 (dm_{1,k,t})^2 + \frac{1}{2} \sum_{k=1}^N \int_{\tau_n}^{\sigma_{n+1}} \alpha_t^2 (dm_{2,k,t})^2.
 \end{aligned}$$

Note that for all $\omega \in E_{n+1,b}$, $n \leq \tau_n < \sigma_{n+1} < \infty$ and $|c_t| < be^{\lambda(n+1)}$ for $\tau_n \leq t < \sigma_{n+1}$. Then, we have by Young's inequality, Hölder's inequality, and the definitions of α , σ_n , and

τ_n that

$$\begin{aligned}
 & \frac{1}{56} \left| |c_{\sigma_{n+1}}|^2 - |c_{\tau_n}|^2 \right|^2 \\
 \leq & \alpha_{\sigma_{n+1}}^2 \left| c_{\sigma_{n+1}}^T (\psi_{1,\sigma_{n+1}} c_{\sigma_{n+1}} + \psi_{2,\sigma_{n+1}}) \right|^2 + \alpha_{\tau_n}^2 \left| c_{\tau_n}^T (\psi_{1,\tau_n} c_{\tau_n} + \psi_{2,\tau_n}) \right|^2 \\
 & + \left| \int_{\tau_n}^{\sigma_{n+1}} \alpha_t c_t^T dm_{1,t} c_t \right|^2 + \left| \int_{\tau_n}^{\sigma_{n+1}} \alpha_t c_t^T dm_{2,t} \right|^2 \\
 & + N^3 \sum_{j=1}^N \left| \int_{\tau_n}^{\sigma_{n+1}} \alpha_t^2 (2 + \alpha_t |\psi_{1,t}|) |g_{j,t}(c_t)|^2 \varphi_t dt \right|^2 + \left| \int_{\tau_n}^{\sigma_{n+1}} \dot{\alpha}_t c_t^T \psi_{2,t} dt \right|^2 \\
 & + \left| \int_{\tau_n}^{\sigma_{n+1}} \dot{\alpha}_t c_t^T \psi_{1,t} c_t dt \right|^2 + 4 \left| \int_{\tau_n}^{\sigma_{n+1}} \alpha_t^2 c_t^T \psi_{1,t}^T (A + \Delta_{1,t}) c_t dt \right|^2 \\
 & + \left| \int_{\tau_n}^{\sigma_{n+1}} \alpha_t^2 c_t^T (2\psi_{1,t}^T \Delta_{2,t} + (A + \Delta_{1,t})^T \psi_{2,t}) dt \right|^2 + \left| \int_{\tau_n}^{\sigma_{n+1}} \alpha_t^2 \psi_{2,t}^T \Delta_{2,t} dt \right|^2 \\
 & + N \sum_{j=1}^N \left| \int_{\tau_n}^{\sigma_{n+1}} \alpha_t c_t^T (1 - 2\alpha_t \psi_{1,t}^T) g_{j,t}(c_t) dM_{j,t} \right|^2 + N \sum_{j=1}^N \left| \int_{\tau_n}^{\sigma_{n+1}} \alpha_t^2 \psi_{2,t}^T g_{j,t}(c_t) dM_{j,t} \right|^2 \\
 & + N^2 \sum_{k=1}^N \left| \int_{\tau_n}^{\sigma_{n+1}} \alpha_t^2 |c_t|^2 (dm_{1,k,t})^2 \right|^2 + \frac{N}{4} \sum_{k=1}^N \left| \int_{\tau_n}^{\sigma_{n+1}} \alpha_t^2 (dm_{2,k,t})^2 \right|^2 \\
 \leq & 2\alpha_{\sigma_{n+1}}^2 \left(|\psi_{1,\sigma_{n+1}}|^2 b^4 e^{4\lambda(n+1)} + |\psi_{2,\sigma_{n+1}}|^2 b^2 e^{2\lambda(n+1)} \right) \\
 & + 2\alpha_{\tau_n}^2 \left(|\psi_{1,\tau_n}|^2 b^4 e^{4\lambda(n+1)} + |\psi_{2,\tau_n}|^2 b^2 e^{2\lambda(n+1)} \right) + \left| \int_{\tau_n}^{\sigma_{n+1}} \alpha_t c_t^T dm_{1,t} c_t \right|^2 \\
 & + \left| \int_{\tau_n}^{\sigma_{n+1}} \alpha_t c_t^T dm_{2,t} \right|^2 + 2N^3 \sum_{j=1}^N \int_{\tau_n}^{\sigma_{n+1}} \alpha_t^2 dt \int_{\tau_n}^{\sigma_{n+1}} \alpha_t^2 (4 + \alpha_t^2 |\psi_{1,t}|^2) |g_{j,t}(c_t)|^4 \varphi_t^2 dt \\
 & + \int_{\tau_n}^{\sigma_{n+1}} \dot{\alpha}_t dt \int_{\tau_n}^{\sigma_{n+1}} \dot{\alpha}_t |\psi_{2,t}|^2 dt b^2 e^{2\lambda(n+1)} + \int_{\tau_n}^{\sigma_{n+1}} \dot{\alpha}_t dt \int_{\tau_n}^{\sigma_{n+1}} \dot{\alpha}_t |\psi_{1,t}|^2 dt b^4 e^{4\lambda(n+1)} \\
 & + 4 \int_{\tau_n}^{\sigma_{n+1}} \alpha_t^2 dt \int_{\tau_n}^{\sigma_{n+1}} \alpha_t^2 |\psi_{1,t}^T (A + \Delta_{1,t})|^2 dt b^4 e^{4\lambda(n+1)} \\
 & + \int_{\tau_n}^{\sigma_{n+1}} \alpha_t^2 dt \int_{\tau_n}^{\sigma_{n+1}} \alpha_t^2 |2\psi_{1,t}^T \Delta_{2,t} + (A + \Delta_{1,t})^T \psi_{2,t}|^2 dt b^2 e^{2\lambda(n+1)} \\
 & + \int_{\tau_n}^{\sigma_{n+1}} \alpha_t^2 dt \int_{\tau_n}^{\sigma_{n+1}} \alpha_t^2 |\psi_{2,t}^T \Delta_{2,t}|^2 dt + N \sum_{j=1}^N \left| \int_{\tau_n}^{\sigma_{n+1}} \alpha_t c_t^T (1 - 2\alpha_t \psi_{1,t}^T) g_{j,t}(c_t) dM_{j,t} \right|^2 \\
 & + N \sum_{j=1}^N \left| \int_{\tau_n}^{\sigma_{n+1}} \alpha_t^2 \psi_{2,t}^T g_{j,t}(c_t) dM_{j,t} \right|^2 + N^2 \sum_{k=1}^N \left| \int_{\tau_n}^{\sigma_{n+1}} \alpha_t^2 (dm_{1,k,t})^2 \right|^2 b^4 e^{4\lambda(n+1)} \\
 & + \frac{N}{4} \sum_{k=1}^N \left| \int_{\tau_n}^{\sigma_{n+1}} \alpha_t^2 (dm_{2,k,t})^2 \right|^2.
 \end{aligned}$$

Taking expectations on both sides of the above inequality, we have by Ito's isometry and Fubini's theorem that

$$\begin{aligned}
 & \frac{1}{56} \mathbb{E}_0^{E_{n+1,b}} \left[\left| |c_{\sigma_{n+1}}|^2 - |c_{\tau_n}|^2 \right|^2 \right] \\
 & \leq 2\alpha_n^2 \sup_{t \geq 0} \mathbb{E}_0 [|\psi_{1,t}|^2 + |\psi_{2,t}|^2] b^4 e^{4\lambda(n+1)} + 2\alpha_n^2 \sup_{t \geq 0} \mathbb{E}_0 [|\psi_{1,t}|^2 + |\psi_{2,t}|^2] b^4 e^{4\lambda(n+1)} \\
 & \quad + N^2 \int_n^\infty \alpha_t^2 dt \mathbb{E}_0 [\varphi_t^2] b^4 e^{4\lambda(n+1)} + N \int_n^\infty \alpha_t^2 dt \mathbb{E}_0 [\varphi_t^2] b^2 e^{2\lambda(n+1)} \\
 & \quad + 2N^4 \left(\int_n^\infty \alpha_t^2 dt \right)^2 \sup_{t \geq 0, j \geq 1} \mathbb{E}_0 \left[\left(4 + \alpha_n^2 |\psi_{1,t}|^2 \right) \frac{|g_{j,t}(c_t)|^4}{(1 + |c_t|)^4} \varphi_t^2 \right] \left(1 + b e^{\lambda(n+1)} \right)^4 \\
 & \quad + \alpha_n^2 \sup_{t \geq 0} \mathbb{E}_0 [|\psi_{2,t}|^2] b^2 e^{2\lambda(n+1)} + \alpha_n^2 \sup_{t \geq 0} \mathbb{E}_0 [|\psi_{1,t}|^2] b^4 e^{4\lambda(n+1)} \\
 & \quad + 4 \left(\int_n^\infty \alpha_t^2 dt \right)^2 \sup_{t \geq 0} \mathbb{E}_0 \left[|\psi_{1,t}^T (A + \Delta_{1,t})|^2 \right] b^4 e^{4\lambda(n+1)} \\
 & \quad + \left(\int_n^\infty \alpha_t^2 dt \right)^2 \sup_{t \geq 0} \mathbb{E}_0 \left[|2\psi_{1,t}^T \Delta_{2,t} + (A + \Delta_{1,t})^T \psi_{2,t}|^2 \right] b^2 e^{2\lambda(n+1)} \\
 & \quad + \left(\int_n^\infty \alpha_t^2 dt \right)^2 \sup_{t \geq 0} \mathbb{E}_0 \left[|\psi_{2,t}^T \Delta_{2,t}|^2 \right] \\
 & \quad + N^2 \int_n^\infty \alpha_t^2 dt \sup_{t \geq 0, j \geq 1} \mathbb{E}_0 \left[\left(1 - 2\alpha_t \psi_{1,t}^T \right)^2 \frac{|g_{j,t}(c_t)|^2}{(1 + |c_t|)^2} \varphi_t \right] \left(1 + b e^{\lambda(n+1)} \right)^2 b^2 e^{2\lambda(n+1)} \\
 & \quad + N^2 \int_n^\infty \alpha_t^4 dt \sup_{t \geq 0, j \geq 1} \mathbb{E}_0 \left[|\psi_{2,t}|^2 \frac{|g_{j,t}(c_t)|^2}{(1 + |c_t|)^2} \varphi_t \right] \left(1 + b e^{\lambda(n+1)} \right)^2 \\
 & \quad + N^4 \left(\int_n^\infty \alpha_t^2 dt \right)^2 \mathbb{E}_0 [\varphi_t^2] b^4 e^{4\lambda(n+1)} + \frac{N^2}{4} \left(\int_{\tau_n}^{\sigma_{n+1}} \alpha_t^2 dt \right)^2 \mathbb{E}_0 [\varphi_t^2]. \tag{15}
 \end{aligned}$$

Hence, we can deduce from (15) that there exists $C_0 > 0$, so that

$$\mathbb{E}_0^{E_{n+1,b}} \left[\left| |c_{\sigma_{n+1}}|^2 - |c_{\tau_n}|^2 \right|^2 \right] \leq C_0 A_n b^4 e^{4\lambda(n+1)}, \tag{16}$$

where

$$A_n = \alpha_n^2 + \left(\int_n^\infty \alpha_t^2 dt \right)^2 + \int_n^\infty \alpha_t^2 dt.$$

As a result, we have from (14) and (16) that

$$\mathbb{P}(E_{n+1,b}) \leq C_0 A_n e^{4\lambda}, \quad n \geq 1.$$

Thus, we have

$$\mathbb{P}(\bar{E}_{n+1}) \geq \mathbb{P}(B_b \setminus E_{n+1,b}) > 1 - \frac{\log(\delta^2 + 1)}{\log(b^2 + 1)} - C_0 A_n e^{4\lambda}.$$

In particular, this implies that $\mathbb{P}(\sup_{t \geq 0} |c_t| < \infty) = 1$.

Now we can write

$$\mathbb{E}_0^{\bar{E}_{n+1}} \left[|c_t|^2 \right] \leq |c_0|^2 - 2\gamma \int_0^t \alpha_s \mathbb{E}_0^{\bar{E}_{n+1}} \left[|c_s|^2 \right] ds + \sqrt{C_0 A_n} b^2 e^{2\lambda n}.$$

By the comparison lemma (Sontag, 1998, Lemma C.3.1), we have

$$\mathbb{E}_0^{\bar{E}_{n+1}} \left[|c_t|^2 \right] \leq \left(|c_0|^2 + \sqrt{C_0 A_n} b^2 e^{2\lambda n} \right) e^{-2\gamma \int_0^t \alpha_s ds}.$$

By Markov's inequality, one has for all $\epsilon > 1$ that

$$\mathbb{P} \left(\omega \in \bar{E}_{n+1} : |c_t(\omega)|^2 \geq \epsilon \left(|c_0|^2 + \sqrt{C_0 A_n} b^2 e^{2\lambda(n+1)} \right) e^{-2\gamma \int_0^t \alpha_s ds} \right) \leq \frac{1}{\epsilon}.$$

Hence,

$$\begin{aligned} & \mathbb{P} \left(\omega \in \Omega : |c_t(\omega)|^2 < \epsilon \left(|c_0|^2 + \sqrt{C_0 A_n} b^2 e^{2\lambda(n+1)} \right) e^{-2\gamma \int_0^t \alpha_s ds} \right) \\ & > \mathbb{P} \left(\omega \in \bar{E}_{n+1} : |c_t(\omega)|^2 < \epsilon \left(|c_0|^2 + \sqrt{C_0 A_n} b^2 e^{2\lambda(n+1)} \right) e^{-2\gamma \int_0^t \alpha_s ds} \right) \\ & > 1 - \frac{\log(\delta^2 + 1)}{\log(b^2 + 1)} - C_0 A_n e^{4\lambda} - \frac{1}{\epsilon}. \end{aligned}$$

Denote $\epsilon^{-1} = \frac{\log(\delta^2 + 1)}{\log(b^2 + 1)}$. Then,

$$\delta^2 = e^{\log(\delta^2 + 1)} - 1 = e^{\epsilon^{-1} \log(b^2 + 1)} - 1 = (b^2 + 1)^{1/\epsilon} - 1.$$

This completes the proof. ■

Lemma 9 For any $0 \leq s < t$, $a > 0$ and $b > 0$, we have

$$at - \sqrt{t+b} \geq as - \sqrt{s+b} - ab - \frac{1}{4a}.$$

Proof Denote $y_t = at - \sqrt{t+b}$. Then

$$\dot{y}_t = a - \frac{1}{2\sqrt{t+b}}.$$

If $a > (2\sqrt{b})^{-1}$, then $\dot{y}_t > 0$ for all t . As a result, $y_t > y_s$ for all $t > s$. If $a \leq (2\sqrt{b})^{-1}$, then $y_t - y_s \geq \min_t y_t - y_0$, where $\min_t y_t = -ab - (4a)^{-1}$. This completes the proof. ■

Lemma 10 Suppose a is a positive real. Then for any $t_0 > 0$,

$$\int_{t_0}^t \frac{1}{s} e^{as} ds \leq \frac{h}{t} e^{at}$$

for some $h > 0$.

Proof First, consider the following auxiliary dynamical system defined on $[t_0, \infty)$:

$$\begin{aligned} \dot{x}_t &= z_t & x_{t_0} &= 0, \\ \dot{z}_t &= -\frac{1}{t}z_t + az_t, & z_{t_0} &= \frac{1}{t_0}e^{at_0}. \end{aligned}$$

To complete the proof, we only need to show $x_t < hz_t$ for some $h > 0$. Denote $e = x - hz$, where $h > 0$ is a sufficiently large constant that will be determined later. Then $e_{t_0} < 0$, and we have

$$\dot{e} = \dot{x} - h\dot{z} = z_t + \frac{h}{t}z_t - ahz_t = z_t \left(1 + \frac{h}{t} - ah\right).$$

Now, if $a > t_0^{-1}$, we can choose $h > (a - t_0^{-1})^{-1}$, such that $1 + ht^{-1} - ah < 0$ for all $t \geq t_0$. Since $z_t > 0$, we have $\dot{e}_t < 0$, and as a result $x_t < hz_t$ for all $t \geq t_0$.

If $a \leq t_0^{-1}$, then $1 + ht^{-1} - ah = 0$ admits a solution $t = t' \triangleq \frac{h}{ah-1} > t_0$ for all $h > a^{-1}$. Hence, e_t reaches its maximum at $t = t'$. As a result, we can choose

$$h \geq \frac{1}{ae} \int_{t_0}^{t'} \frac{1}{s} e^{as} ds + \frac{2}{a},$$

which implies that

$$\int_{t_0}^{t'} \frac{1}{s} e^{as} ds \leq (ha - 1)e^{\frac{1}{ha-1}+1},$$

and hence $e_{t_0} \leq 0$. This completes the proof. \blacksquare

Lemma 11 Consider $\alpha_t > 0$ with $\dot{\alpha}_t \leq 0$. If there exist $h > 0$ and $t_0 \geq 0$, such that $\alpha_t^2 \geq -h\dot{\alpha}_t$ for all $t \geq t_0$, then

$$e^{-\int_{t_0}^t \alpha_s ds} \leq \left(\frac{\alpha_t}{\alpha_{t_0}}\right)^h.$$

Proof By definition,

$$\alpha_t \geq -h \frac{\dot{\alpha}_t}{\alpha_t} \geq 0, \quad \forall t \geq t_0.$$

Taking integration from t_0 to t , we have

$$\int_{t_0}^t \alpha_s ds \geq h \log(\alpha_{t_0}) - h \log(\alpha_t).$$

Hence,

$$e^{-\int_{t_0}^t \alpha_s ds} \leq \left(\frac{\alpha_t}{\alpha_{t_0}}\right)^h.$$

This completes the proof. \blacksquare

References

- A. Antos, C. Szepesvári, and R. Munos. Fitted Q-iteration in continuous action-space MDPs. In *Advances in Neural Information Processing Systems 20*, pages 9–16. Curran Associates, Inc., 2008.
- A. Arapostathis, V. S. Borkar, and M. K. Ghosh. *Ergodic Control of Diffusion Processes*. Cambridge University Press, New York, NY, 2012.
- L. Arnold. *Stochastic Differential Equations: Theory and Applications*. John Wiley & Sons, Inc., New York, 1974.
- N. Aronszajn. Theory of reproducing kernels. *Transactions of the American Mathematical Society*, 68(3):337–404, 1950.
- L. C. Baird, III. Advantage updating. Technical Report WL–TR-93-1146, Wright-Patterson Air Force Base Ohio: Wright Laboratory, Washington DC, 1993.
- A. G. Barto, P. S. Tomas, and R. S. Sutton. Some recent applications of reinforcement learning. In *Proceedings of the Eighteenth Yale Workshop on Adaptive and Learning Systems*, 2017.
- A. Benveniste, M. Métivier, and P. Priouret. *Adaptive algorithms and stochastic approximations*. Springer Berlin Heidelberg, 1990.
- R. N. Bhattacharya. On the functional central limit theorem and the law of the iterated logarithm for markov processes. *Zeitschrift für Wahrscheinlichkeitstheorie und Verwandte Gebiete*, 60(2):185–201, 1982.
- T. Bian and Z. P. Jiang. Value iteration and adaptive dynamic programming for data-driven adaptive optimal control design. *Automatica*, 71:348–360, 2016.
- T. Bian and Z. P. Jiang. Continuous-time robust dynamic programming. *SIAM Journal on Control and Optimization*, 57(6):4150–4174, 12 2019.
- T. Börgers and R. Sarin. Learning through reinforcement and replicator dynamics. *Journal of Economic Theory*, 77(1):1–14, 1997.
- J. M. Borwein. Fifty years of maximal monotonicity. *Optimization Letters*, 4(4):473–490, 2010.
- P. Chaudhari, A. Oberman, S. Osher, S. Soatto, and G. Carlier. Deep relaxation: partial differential equations for optimizing deep neural networks. *Research in the Mathematical Sciences*, 5(3):30, 2018.
- T. Q. Chen, Y. Rubanova, J. Bettencourt, and D. K. Duvenaud. Neural ordinary differential equations. In *Advances in Neural Information Processing Systems 31*, pages 6571–6583. Curran Associates, Inc., 2018.
- K. Doya. Temporal difference learning in continuous time and space. In *Advances in Neural Information Processing Systems 8*, pages 1073–1079. MIT Press, 1996.

- K. Doya. Reinforcement learning in continuous time and space. *Neural Computation*, 12(1): 219–245, Jan. 2000.
- Y. Duan, X. Chen, R. Houthoofd, J. Schulman, and P. Abbeel. Benchmarking deep reinforcement learning for continuous control. In *Proceedings of the 33rd International Conference on Machine Learning*, volume 38, pages 1329–1338, New York, NY, 2016.
- W. E. A proposal on machine learning via dynamical systems. *Communications in Mathematics and Statistics*, 5(1):1–11, 2017.
- N. Frémaux, H. Sprekeler, and W. Gerstner. Reinforcement learning using a continuous time actor-critic framework with spiking neurons. *PLOS Computational Biology*, 9(4):e1003024, 04 2013.
- P. W. Glynn and S. P. Meyn. A Liapounov bound for solutions of the Poisson equation. *Ann. Probab.*, 24(2):916–931, 1996.
- L. P. Hansen and J. A. Scheinkman. Back to the future: Generating moment implications for continuous-time markov processes. *Econometrica*, 63(4):767–804, July 1995.
- M. E. Harmon, L. C. Baird, III, and A. H. Klopf. Advantage updating applied to a differential game. In *Advances in Neural Information Processing Systems 7*, pages 353–360. MIT Press, 1995.
- K. Ito. Lectures on stochastic processes. Lecture Notes, Tata Institute of Fundamental Research, Bombay, 1960.
- Y. Jiang and Z. P. Jiang. Computational adaptive optimal control for continuous-time linear systems with completely unknown dynamics. *Automatica*, 48(10):2699 – 2704, 2012.
- Y. Jiang and Z. P. Jiang. *Robust Adaptive Dynamic Programming*. Wiley-IEEE Press, Hoboken, NJ, 2017.
- H. K. Khalil. *Nonlinear Control*. Pearson Education, Harlow, UK, 2015.
- B. Kiumarsi, K. G. Vamvoudakis, H. Modares, and F. L. Lewis. Optimal and autonomous control using reinforcement learning: A survey. *IEEE Transactions on Neural Networks and Learning Systems*, 29(6):2042–2062, 2018.
- P. N. Kolm and G. Ritter. Dynamic replication and hedging: A reinforcement learning approach. *The Journal of Financial Data Science*, 1(1):159–171, 2019.
- V. R. Konda. *Actor-Critic Algorithms*. PhD thesis, Massachusetts Institute of Technology. Dept. of Electrical Engineering and Computer Science., June 2002.
- V. R. Konda and J. N. Tsitsiklis. Actor-critic algorithms. In *Advances in Neural Information Processing Systems 12*, pages 1008–1014. MIT Press, 2000.
- I. Kontoyiannis and S. P. Meyn. Spectral theory and limit theorems for geometrically ergodic markov processes. *The Annals of Applied Probability*, 13(1):304–362, 02 2003.

- H. J. Kushner. *Stochastic Stability and Control*. Academic Press, London, UK, 1967a.
- H. J. Kushner. Optimal discounted stochastic control for diffusion processes. *SIAM Journal on Control*, 5(4):520–531, 1967b.
- H. J. Kushner and G. G. Yin. *Stochastic Approximation and Recursive Algorithms and Applications*. Springer New York, 2003.
- T. P. Lillicrap, J. J. Hunt, A. Pritzel, N. Heess, T. Erez, Y. Tassa, D. Silver, and D. Wierstra. Continuous control with deep reinforcement learning. In *Proceedings of the 4th International Conference on Learning Representations (ICLR 2016)*, 2016.
- L. Ljung. Analysis of recursive stochastic algorithms. *IEEE Transactions on Automatic Control*, 22(4):551–575, Aug 1977.
- G. Lumer and R. S. Phillips. Dissipative operators in a Banach space. *Pacific Journal of Mathematics*, 11(2):679–698, 1961.
- J.-P. Merlet. *Parallel Robots*. Springer, Dordrecht, 2nd edition, 2006.
- G. J. Minty. Monotone (nonlinear) operators in Hilbert space. *Duke Math. J.*, 29(3):341–346, 1962.
- L. Moysis. Balancing a double inverted pendulum using optimal control and laguerre functions. Technical report, Aristotle University of Thessaloniki, Greece, 54124, 2016.
- R. Munos. A study of reinforcement learning in the continuous case by the means of viscosity solutions. *Machine Learning*, 40(3):265–299, 2000.
- R. Munos and C. Szepesvári. Finite-time bounds for fitted value iteration. *Journal of Machine Learning Research*, 9:815–857, May 2008.
- A. Nedić and D. P. Bertsekas. Least squares policy evaluation algorithms with linear function approximation. *Discrete Event Dynamic Systems*, 13(1-2):79–110, 2003.
- E. Nelson. The adjoint Markoff process. *Duke Mathematical Journal*, 25(4):671–690, 1958.
- A. Pazy. *Semigroups of Linear Operators and Applications to Partial Differential Equations*. Springer-Verlag New York, 1983.
- R. S. Phillips. A note on the abstract cauchy problem. *Proceedings of the National Academy of Sciences of the United States of America*, 40(4):244–248, 04 1954.
- B. Recht. A tour of reinforcement learning: The view from continuous control. *Annual Review of Control, Robotics, and Autonomous Systems*, 2(1):253–279, 2019.
- S. J. Russell. Rationality and intelligence. *Artificial Intelligence*, 94(1):57–77, 1997.
- S. J. Russell and P. Norvig. *Artificial Intelligence: A Modern Approach*. Pearson Education, Upper Saddle River, NJ, 2010.

- L. Ruthotto and E. Haber. Deep neural networks motivated by partial differential equations. *Journal of Mathematical Imaging and Vision*, 62:352–364, 2020.
- G. Scarciotti and A. Astolfi. Nonlinear model reduction by moment matching. *Foundations and Trends® in Systems and Control*, 4(3-4):224–409, 2017.
- D. Silver, J. Schrittwieser, K. Simonyan, I. Antonoglou, A. Huang, A. Guez, T. Hubert, L. Baker, M. Lai, A. Bolton, Y. Chen, T. Lillicrap, F. Hui, L. Sifre, G. van den Driessche, T. Graepel, and D. Hassabis. Mastering the game of go without human knowledge. *Nature*, 550(7676):354–359, 10 2017.
- E. D. Sontag. *Mathematical Control Theory: Deterministic Finite Dimensional Systems*. Springer New York, 2nd edition, 1998.
- E. D. Sontag. Input to state stability: Basic concepts and results. In P. Nistri and G. Stefani, editors, *Nonlinear and Optimal Control Theory: Lectures given at the C.I.M.E. Summer School held in Cetraro, Italy June 19-29, 2004*, pages 163 – 220. Springer Berlin Heidelberg, 2008.
- R. S. Sutton. Learning to predict by the methods of temporal differences. *Machine Learning*, 3(1):9–44, 1988.
- R. S. Sutton and A. G. Barto. *Reinforcement Learning: An Introduction*. Adaptive computation and machine learning. The MIT Press, Cambridge, MA, 2nd edition, 2018.
- J. N. Tsitsiklis. Asynchronous stochastic approximation and Q-learning. *Machine Learning*, 16(3):185–202, 1994.
- J. N. Tsitsiklis and B. Van Roy. An analysis of temporal-difference learning with function approximation. *IEEE Transactions on Automatic Control*, 42(5):674–690, 1997.
- H. van Hasselt. Reinforcement learning in continuous state and action spaces. In M. Wiering and M. van Otterlo, editors, *Reinforcement Learning: State-of-the-Art*, chapter 7, pages 207–251. Springer Berlin Heidelberg, 2012.
- H. van Hasselt and M. A. Wiering. Reinforcement learning in continuous action spaces. In *IEEE International Symposium on Approximate Dynamic Programming and Reinforcement Learning*, pages 272–279, April 2007.
- D. Vrabie, K. G. Vamvoudakis, and F. L. Lewis. *Optimal Adaptive Control and Differential Games by Reinforcement Learning Principles*. Institution of Engineering and Technology, London, UK, 2013.
- J. X. Wang, Z. Kurth-Nelson, D. Kumaran, D. Tirumala, H. Soyer, J. Z. Leibo, D. Hassabis, and M. Botvinick. Prefrontal cortex as a meta-reinforcement learning system. *Nature Neuroscience*, 21(6):860–868, 2018.
- H. Yu and D. P. Bertsekas. Convergence results for some temporal difference methods based on least squares. *IEEE Transactions on Automatic Control*, 54(7):1515–1531, 2009.