

B-RIGIDITY OF THE PROPERTY TO BE AN ALMOST POGORELOV POLYTOPE

NIKOLAI EROKHOVETS

ABSTRACT. Toric topology assigns to each n -dimensional combinatorial simple convex polytope P with m facets an $(m+n)$ -dimensional moment-angle manifold \mathcal{Z}_P with an action of a compact torus T^m such that \mathcal{Z}_P/T^m is a convex polytope of combinatorial type P . We study the notion of B -rigidity. A property of a polytope P is called B -rigid, if any isomorphism of graded rings $H^*(\mathcal{Z}_P, \mathbb{Z}) = H^*(\mathcal{Z}_Q, \mathbb{Z})$ for a simple n -polytope Q implies that it also has this property. We study families of 3-dimensional polytopes defined by their cyclic k -edge-connectivity. These families include flag polytopes and Pogorelov polytopes, that is polytopes realizable as bounded right-angled polytopes in Lobachevsky space \mathbb{L}^3 . Pogorelov polytopes include fullerenes – simple polytopes with only pentagonal and hexagonal faces. It is known that the properties to be a flag 3-dimensional polytope or a Pogorelov polytope are B -rigid. We focus on almost Pogorelov polytopes, which are strongly cyclically 4-edge-connected polytopes. They correspond to right-angled polytopes of finite volume in \mathbb{L}^3 . There is a subfamily of ideal almost Pogorelov polytopes corresponding to ideal right-angled polytopes. We prove that the properties to be an almost Pogorelov polytope and an ideal almost Pogorelov polytope are B -rigid. As a corollary we obtain that 3-dimensional associahedron As^3 and permutohedron Pe^3 are B -rigid. We generalize methods known for Pogorelov polytopes. We obtain results on B -rigidity of subsets in $H^*(\mathcal{Z}_P, \mathbb{Z})$ and prove an analog of the so-called separable circuit condition (SCC). As an example we consider the ring $H^*(\mathcal{Z}_{As^3}, \mathbb{Z})$.

INTRODUCTION

Consider a unit circle $S^1 \subset \mathbb{C}$ and a unit disk $D^2 \subset \mathbb{C}$. Toric topology (see [BP15]) assigns to each simple convex n -polytope P with m faces F_1, \dots, F_m an $(m+n)$ -dimensional *moment-angle manifold* \mathcal{Z}_P with an action of a compact m -dimensional torus $T^m = (S^1)^m$ such that $\mathcal{Z}_P/T^m = P$. One of the ways to define the space \mathcal{Z}_P is

$$\mathcal{Z}_P = T^m \times P^n / \sim, \text{ where } (t_1, p_1) \sim (t_2, p_2) \text{ if and only if } p_1 = p_2, \text{ and } t_1 t_2^{-1} \in T^{G(p_1)},$$

where $T^{G(p)} = \{(t_1, \dots, t_m) \in T^m : t_i = 1 \text{ for } F_i \not\ni p\}$.

It can be shown that topological type of the space \mathcal{Z}_P depends only on combinatorial type of P and \mathcal{Z}_P has a smooth structure such that the action of T^m obtained from its action on the first factor, is smooth.

2010 *Mathematics Subject Classification.* 05C40, 05C75, 05C76, 13F55, 52B05, 52B10, 52B70, 57R19, 57R91

Key words and phrases. Three-dimensional polytope, toric topology, almost Pogorelov polytope, B -rigidity, cyclic k -edge-connectivity, fullerene, right-angled polytope.

The research was supported by the RFBR grant No 18-51-50005.

Definition 0.1. A simple n -polytope P is called *B-rigid*, if for any simple n -polytope Q any isomorphism of graded rings $H^*(\mathcal{Z}_P, \mathbb{Z}) \simeq H^*(\mathcal{Z}_Q, \mathbb{Z})$ implies that P and Q are combinatorially equivalent.

We study families of combinatorial simple 3-polytopes defined by the condition of a *cyclic edge k -connectivity* (*ck-connectivity* for short). For 3-polytopes by *faces* we mean facets. Two faces are *adjacent*, if they have a common edge.

Definition 0.2. A *k -belt* is a cyclic sequence of k faces with the property that faces are adjacent if and only if they follow each other, and no three faces have a common vertex. A *k -belt* is *trivial*, if it surrounds a face.

A simple 3-polytope different from the *simplex* Δ^3 is *ck-connected*, if it has no l -belts for $l < k$, and is *strongly ck-connected* (*c^*k -connected*), if in addition any its k -belt is trivial. By definition Δ^3 is *c^*3 -connected* but not *$c4$ -connected*.

All simple 3-polytopes (family \mathcal{P}_s) are *$c3$ -connected*. We obtain a chain of nested families:

$$\mathcal{P}_s \supset \mathcal{P}_{aflag} \supset \mathcal{P}_{flag} \supset \mathcal{P}_{aPog} \supset \mathcal{P}_{Pog} \supset \mathcal{P}_{Pog^*}$$

The family of *$c4$ -connected* polytopes coincides with the family \mathcal{P}_{flag} of *flag* 3-polytopes defined by the property that any set of pairwise adjacent faces has a nonempty intersection. Each face of a flag polytope is surrounded by a belt. The Euler formula implies that any simple polytope has a 3-, 4- or 5-gonal face. Hence it can not be more than *c^*5 -connected*.

The family of *c^*3 -connected* polytopes we call *almost flag* polytopes and denote \mathcal{P}_{aflag} .

Results by A.V. Pogorelov [P67] and E.M. Andreev [A70a] imply that *$c5$ -connected* polytopes (family \mathcal{P}_{Pog}) are exactly polytopes realizable in the Lobachevsky space \mathbb{L}^3 as bounded polytopes with right dihedral angles. Moreover, the realization is unique up to isometries. These polytopes were called *Pogorelov polytopes*, since the paper [P67] is devoted to exactly this class of polytopes. The paper [A70a] implies that flag polytopes are exactly polytopes realizable in \mathbb{L}^3 as polytopes with equal nonobtuse dihedral angles. Examples of Pogorelov polytopes are given by *k -barrels* B_k , $k \geq 5$, (*Löbell polytopes* in terminology of A.Yu. Vesnin [V17], or *truncated trapezohedra*), see Fig. 1a). Results by T. Döslić [D98, D03] imply that the family \mathcal{P}_{Pog} contains *fullerenes*, that is simple 3-polytopes with only pentagonal and hexagonal faces. Mathematical fullerenes model spherical carbon atoms. In 1996 R. Curl, H. Kroto, and R. Smalley obtained the Nobel Prize in chemistry “for their discovery of fullerenes”. They synthesized *Buckminsterfullerene* C_{60} (see Fig. 1b), which has the form of the truncated icosahedron (and also of a soccer ball). W.P. Thurston [T98] built a parametrisation of the fullerene family, which implies that the number of fullerenes with n carbon atoms grows like n^9 when n tends to infinity.

The family \mathcal{P}_{aPog} of *c^*4 -connected* polytopes we call *almost Pogorelov* polytopes, and the family \mathcal{P}_{Pog^*} of *c^*5 -connected* polytopes – *strongly Pogorelov* polytopes. In [FMW20, Section 6] the simplicial 3-polytopes dual to almost Pogorelov polytopes form the family \mathcal{Q} . G.D. Birkhoff [B1913] reduced the 4-colour problem to the task to colour in 4 colours faces of polytopes of the family, which turned out to be the family \mathcal{P}_{Pog^*} .

T.E. Panov remarked that results by E. M. Andreev [A70a, A70b] should imply that almost Pogorelov polytopes correspond to right-angled polytopes of finite volume in \mathbb{L}^3 . Such polytopes

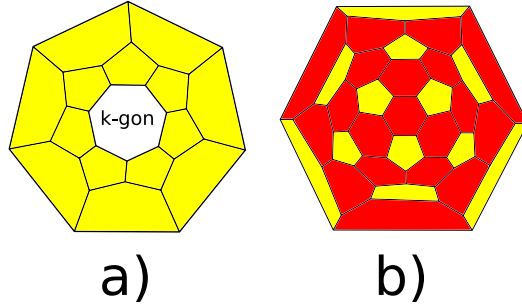

FIGURE 1. a) k -barrel B_k ; b) fullerene C_{60}

may have 4-valent vertices on the absolute, while all proper vertices have valency 3. It was proved in [E19] that cutting of 4-valent vertices defines a bijection between classes of congruence of right-angled polytopes of finite volume in \mathbb{L}^3 and almost Pogorelov polytopes different from the cube I^3 and the pentagonal prism $M_5 \times I$.

In the paper [V87] A.Yu. Vesnin introduced a construction of a 3-dimensional compact hyperbolic manifold $R(P, \Lambda_2)$ corresponding to a mapping Λ_2 of the set of faces of a polytope $P \in \mathcal{P}_{Pog}$ to $\mathbb{Z}_2^3 = (\mathbb{Z}/2\mathbb{Z})^3$ such that for any vertex the images of the faces containing it form a basis. The manifold is obtained by gluing 8 copies of the polytope along faces. The existence of a mapping follows from the 4 colour theorem. In toric topology (see [BP15, DJ91]) such manifolds are obtained as *small covers* over right-angled polytopes. For a simple n -polytope P and a mapping $\Lambda: \{F_1, \dots, F_m\} \rightarrow \mathbb{Z}^n$ such that for any vertex the images of facets containing it form a basis in \mathbb{Z}^n toric topology associates a $2n$ -dimensional smooth *quasitoric manifold* $M(P, \Lambda)$ with an action of T^n such that $M(P, \Lambda)/T^n = P$.

In [FMW15] F. Fan, J. Ma and X. Wang proved that any Pogorelov polytope is B -rigid. In [B17] F. Bosio presented a construction of flag 3-polytopes, which are not B -rigid.

In [BEMPP17] the following result was proved

Theorem 0.3 ([BEMPP17]). *For polytopes $P, P' \in \mathcal{P}_{Pog}$ with functions Λ_2, Λ , and Λ'_2, Λ' the manifolds $M(P, \Lambda)$ and $M(P', \Lambda')$ are diffeomorphic if and only if their cohomology rings over \mathbb{Z} are isomorphic as graded rings, and if and only if there is a combinatorial equivalence φ between P and P' and a change of coordinates $A \in Gl_3(\mathbb{Z})$ such that for any face F of P we have $\Lambda'(\varphi(F)) = \pm A\Lambda(F)$. The manifolds $R(P, \Lambda_2)$ and $R(P', \Lambda'_2)$ are diffeomorphic if and only if their cohomology rings over \mathbb{Z}_2 are isomorphic as graded rings, and if and only if there is a combinatorial equivalence φ between P and P' and a change of coordinates $A_2 \in Gl_3(\mathbb{Z}_2)$ such that for any face F of P we have $\Lambda'_2(\varphi(F)) = \pm A_2\Lambda_2(F)$.*

Recent results of this type in the context of toric varieties for n -dimensional cubes see in [CLMP20].

In this paper we develop methods from [FMW15] (see also [BE17S]) to almost Pogorelov polytopes.

The cube and the pentagonal prism belong to \mathcal{P}_{aPog} . All the other polytopes from \mathcal{P}_{aPog} have no adjacent quadrangles. The simplest polytope of this type is the 3-dimensional *Stasheff*

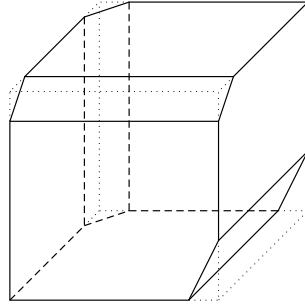

FIGURE 2. A 3-dimensional associahedron (Stasheff polytope) As^3 as a truncated cube

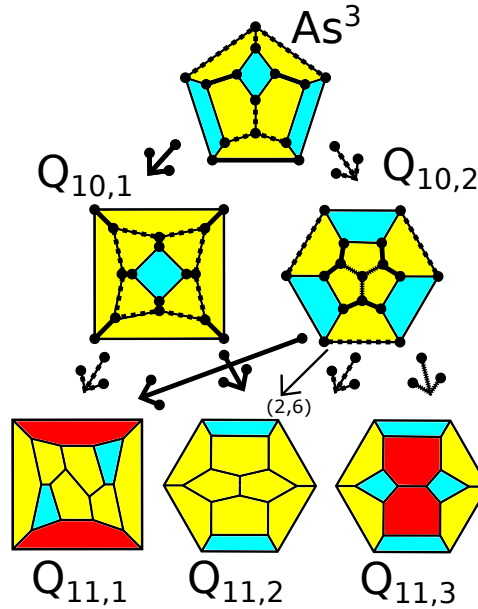

FIGURE 3. Almost Pogorelov polytopes with at most 11 faces

polytope (or *associahedron*) As^3 (see Fig. 2 and Fig. 16), which is the cube with three pairwise disjoint orthogonal edges cut. Result by D. Barnette [B74] imply that a simple polytope belongs to $\mathcal{P}_{aPog} \setminus \{I^3, M_5 \times I\}$ if and only if it can be obtained from As^3 by a sequence of operations of cutting off an edge not lying in quadrangles, and cutting off a pair of adjacent edges of at least hexagonal face by one plane. On Fig. 3 we draw all possible ways to construct almost Pogorelov polytopes with at most $m = 11$ faces. It should be mentioned that it follows from [K69] (see also [V15, BE15]) that a simple 3-polytope is flag if and only if it can be obtained from the cube I^3 by a sequence of operations of cutting off an edge and cutting off a pair of adjacent edges of at least hexagonal face.

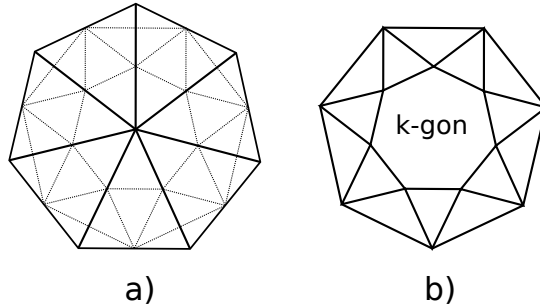

FIGURE 4. a) Medial graph of the k -gonal pyramid; b) The k -antiprism

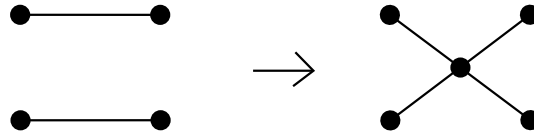
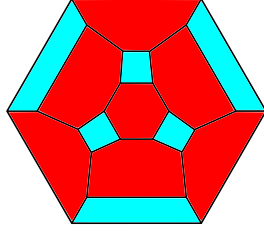

FIGURE 5. An edge-twist

A polytope in \mathbb{L}^3 is called *ideal*, if all its vertices lie on the absolute. An ideal polytope has a finite volume. Its congruence class is uniquely defined by the combinatorial type (see [R96]). We will call almost Pogorelov polytopes corresponding to ideal right-angled polytopes *ideal almost Pogorelov polytopes* and denote their family \mathcal{P}_{IPog} . It is known (see more details in [E19]) that graphs of ideal right-angled 3-polytopes are exactly *medial graphs* of 3-dimensional (not necessarily simple) polytopes. A medial graph of the k -pyramid is known as k -antiprism, see Fig. 4 b). The boundaries of polytopes dual to the polytopes in \mathcal{P}_{IPog} appeared in [FMW20, Example 6.3(2)] as examples of flag triangulations such that any 4-circuit full subcomplex is simple.

An operation of an *edge-twist* is drawn on Fig. 5. Two edges on the left lie in the same face and are disjoint. Let us call an edge-twist *restricted*, if both edges are adjacent to an edge of the same face. It follows from [V17, BGGMTW05, E19] that a polytope is realizable as an ideal right-angled polytope if and only if either it is a k -antiprism, $k \geq 3$, or it can be obtained from the 4-antiprism by a sequence of restricted edge-twists.

Thus, the simplest ideal right-angled polytope is a 3-antiprism, which coincides with the octahedron. The corresponding ideal almost Pogorelov polytope is known as 3-dimensional permutohedron Pe^3 , see Fig. 6. This is a unique ideal almost Pogorelov polytope with minimal number m of faces (14 faces). It is easy to see that for ideal almost Pogorelov polytopes $m = 2(p_4 + 1)$, where p_4 is the number of quadrangles. It follows from the above construction that for $m = 16$ there are no polytopes in \mathcal{P}_{IPog} , and for $m = 18$ and 20 there are unique polytopes. First of the them corresponds to the 4-antiprism, and the second corresponds to a polytope obtained from it by an edge-twist. Recent results on volumes of ideal right-angled polytopes see in [VE20].

FIGURE 6. Three-dimensional permutohedron Pe^3

Definition 0.4. A property of an n -polytope P is called *B-rigid*, if any isomorphism of graded rings $H^*(\mathcal{Z}_P, \mathbb{Z}) = H^*(\mathcal{Z}_Q, \mathbb{Z})$ for a simple n -polytope Q implies that it also has this property.

It follows from [FMW15] that the properties to be flag, Pogorelov, and strongly Pogorelov 3-polytope are *B-rigid*.

Main result of our paper is the fact that the properties to be an almost Pogorelov polytope and an ideal almost Pogorelov polytopes are *B-rigid* (Theorem 3.6 and Corollary 3.8). This implies that polytopes of these families with $m \leq 11$ and $m \leq 20$ respectively, in particular As^3 and Pe^3 , are *B-rigid* (Corollaries 3.7 and 3.9).

Below in the plan of the paper.

In Section 1 we give a brief description of the cohomology ring of the moment-angle manifold of a simple 3-polytope.

In Section 2 we give a scheme of the proof of *B-rigidity* of any Pogorelov polytope from [FMW15]. Also in Proposition 2.2 we simplify a criterion for a simple 3-polytope $P \neq \Delta^3$ to be flag, namely

$$\text{rk } H^4(\mathcal{Z}_P) = \frac{(m-2)(m-4)(m-6)}{3}.$$

In Section 3 we prove that the property to be an almost Pogorelov polytope and an ideal almost Pogorelov polytopes are *B-rigid* (Theorem 3.6 and Corollary 3.8). This implies that polytopes of these families with $m \leq 11$ and $m \leq 20$ respectively, in particular As^3 and Pe^3 , are *B-rigid* (Corollaries 3.7 and 3.9).

In Section 4 we give another characterization of almost Pogorelov and ideal almost Pogorelov polytopes in terms of the quotient ring of $H^*(\mathcal{Z}_P)$.

In Section 5 we prove an analog of the so-called *separable circuit condition* (SCC), which plays a crucial role in toric topology of Pogorelov polytopes. The same result in the dual setting for simplicial polytopes was earlier proved in [FMW20, Proposition F.1].

Denote by $|\mathcal{B}|$ the union of faces of the belt \mathcal{B} .

Lemma 0.5 (SCC, [FMW15]). *For any Pogorelov polytope P and any three pairwise different faces $\{F_i, F_j, F_k\}$ with $F_i \cap F_j = \emptyset$ there exist $l \geq 5$ and an l -belt \mathcal{B}_l such that $F_i, F_j \in \mathcal{B}_l$, $F_k \notin \mathcal{B}_l$, and F_k does not intersect at least one of the two connected components of $|\mathcal{B}_l| \setminus (F_i \cup F_j)$.*

We prove (Lemma 5.2) that for an almost Pogorelov polytope P for three pairwise different faces $\{F_i, F_j, F_k\}$ such that $F_i \cap F_j = \emptyset$ there exists an l -belt ($l \geq 4$) \mathcal{B}_l such that $F_i, F_j \in \mathcal{B}_l$,

$F_k \notin \mathcal{B}_l$, and F_k does not intersect at least one of the two connected components of $|\mathcal{B}_l| \setminus (F_i \cup F_j)$ if and only if F_k does not intersect quadrangles among the faces F_i and F_j . Moreover, we prove (Proposition 5.3) that this condition is characteristic for a flag 3-polytope to be an almost Pogorelov polytope or the polytope P_8 obtained from the cube by cutting off two nonadjacent orthogonal edges.

In Section 6 we prove (Lemma 6.1) an analog of the other crucial tool for Pogorelov polytopes – an *annihilator lemma* (which is not valid for almost Pogorelov polytopes, see Proposition 8.3), and analogs of its corollaries (Corollaries 6.7 and 6.8, see also Proposition 7.9), and study the arising notion of good and bad pairs of disjoint faces.

In Section 7 we prove B -rigidity in the class $\mathcal{P}_{aPog} \setminus \{I^3, M_5 \times I\}$ (see Definition 2.1) of

- the sets of elements corresponding to 4-belts (Lemma 7.2);
- the cosets corresponding to pairs of disjoint faces lying in 4-belts (Lemma 7.5);
- the sets of elements corresponding to pairs of adjacent quadrangles (Proposition 7.9),
- to $(2k)$ -belts containing k quadrangles (Lemma 7.12),
- and to trivial belts of this type (Lemma 7.13).

In Section 8 we consider the ring $H^*(\mathcal{Z}_P, \mathbb{Z})$ for $P = As^3$. In particular, we prove (Proposition 8.3) that the annihilator lemma is not valid for almost Pogorelov polytopes.

Remark 1. In paper [FMW20] the authors generalize Theorem 0.3 ([FMW20, Theorem 5.1]) and result on B -rigidity ([FMW20, Theorems 3.12 and 3.14]) for flag polytopes of dimension of higher than 3 satisfying a generalization of the SCC condition (see Lemma 0.5). In particular, products of Pogorelov polytopes satisfy these conditions. Namely, they prove that if P is a flag n -polytope satisfying generalized SCC condition, Q is a flag n -polytope, and there is an isomorphism of graded rings $H^*(\mathcal{Z}_P) \simeq H^*(\mathcal{Z}_Q)$, then P and Q are combinatorially equivalent. Note that at this moment for $n > 3$ it is not known if the property to be a flag n -polytope is determined by a graded ring $H^*(\mathcal{Z}_P)$. Also it is announced without any details, that in the next paper [FMW20b] the authors will prove B -rigidity of any almost Pogorelov polytope and an analog of Theorem 0.3 for them. But their Definition 2.16 of B -rigidity assumes isomorphism of bigraded rings, which is a more restrictive condition.

Remark 2. Results of our paper imply (see Remark 7) that any ideal almost Pogorelov is B -rigid. This gives cohomologically rigid families of 3-dimensional and 6-dimensional manifolds corresponding to a unique (up to a permutation of colours) colouring of faces of an ideal almost Pogorelov polytope into 3 colours. They are "pullbacks from the linear model" from [DJ91, Example 1.15(1)]. Details see in [E20b].

1. COHOMOLOGY RING OF A MOMENT-ANGLE MANIFOLD OF A SIMPLE 3-POLYTOPE

Details on cohomology of a moment-angle manifolds see in [BP15, BE17S]. If not specified, we study cohomology over \mathbb{Z} and omit the coefficient ring.

The ring $H^*(\mathcal{Z}_P)$ has a multigraded structure:

$$H^*(\mathcal{Z}_P) = \bigoplus_{i \geq 0, \omega \subset [m]} H^{-i, 2\omega}(\mathcal{Z}_P), \text{ where } H^{-i, 2\omega}(\mathcal{Z}_P) \subset H^{2|\omega| - i}(\mathcal{Z}_P),$$

and $[m] = \{1, \dots, m\}$. There is a canonical isomorphism $H^{-i, 2\omega}(\mathcal{Z}_P) \simeq \tilde{H}^{|\omega| - i - 1}(P_\omega)$, where $P_\omega = \bigcup_{i \in \omega} F_i$, and $\tilde{H}^{-1}(\emptyset) = \mathbb{Z}$.

The multiplication between components is nonzero, only if $\omega_1 \cap \omega_2 = \emptyset$. The mapping

$$H^{-i, 2\omega_1}(\mathcal{Z}_P) \otimes H^{-j, 2\omega_2}(\mathcal{Z}_P) \rightarrow H^{-(i+j), 2(\omega_1 \sqcup \omega_2)}(\mathcal{Z}_P)$$

via the Poincare-Lefschets duality $H^i(P_\omega) \simeq H_{n-1-i}(P_\omega, \partial P_\omega)$ up to signs is induced by intersection of faces of P . Denote by $\hat{H}_{n-i-1}(P_\omega, \partial P_\omega)$ the subgroup corresponding to $\tilde{H}^i(P_\omega)$.

For any simple 3-polytope P and $\omega \neq \emptyset$ the set P_ω is a 2-dimensional manifold, perhaps with a boundary. Each connected component of P_ω is a sphere with holes, and its boundary is a disjoint union of simple edge-cycles. Then $\tilde{H}^k(P_\omega)$ is nonzero only for $(k, \omega) \in \{(-1, \emptyset), (0, *), (1, *), (2, [m])\}$. In particular, P has no torsion. There is a multigraded Poincare duality, which means that the bilinear form

$$H^{-i, 2\omega}(\mathcal{Z}_P) \times H^{-(m-3-i), 2([m] \setminus \omega)}(\mathcal{Z}_P) \rightarrow H^{-(m-3), 2[m]}(\mathcal{Z}_P) = \mathbb{Z}$$

has in some basis matrix with determinant ± 1 . In particular, for a basis $\{e_\alpha\}$ in $H^{-i, 2\omega}(\mathcal{Z}_P)$ there is a dual basis $\{e_\beta^*\}$ in $H^{-(m-3-i), 2([m] \setminus \omega)}(\mathcal{Z}_P)$ such that $e_\alpha \cdot e_\beta^* = \delta_{\alpha, \beta} [\mathcal{Z}_P]$, where $[\mathcal{Z}_P]$ is a fundamental class in cohomology. We have

$$\begin{aligned} H^0(\mathcal{Z}_P) &= \tilde{H}^{-1}(\emptyset) = \mathbb{Z} = \tilde{H}^2(\partial P) = H^{m+3}(\mathcal{Z}_P); \\ H^1(\mathcal{Z}_P) &= H^2(\mathcal{Z}_P) = 0 = H^{m+1}(\mathcal{Z}_P) = H^{m+2}(\mathcal{Z}_P); \\ H^k(\mathcal{Z}_P) &= \bigoplus_{|\omega|=k-1} \tilde{H}^0(P_\omega) \oplus \bigoplus_{|\omega|=k-2} \tilde{H}^1(P_\omega), \quad 3 \leq k \leq m. \end{aligned}$$

Nontrivial multiplication occurs only for

- (1) $\tilde{H}^{-1}(P_\emptyset) \otimes \tilde{H}^k(P_\omega) \rightarrow \tilde{H}^k(P_\omega)$. This corresponds to multiplication by 1 in $H^*(\mathcal{Z}_P)$;
- (2) $\tilde{H}^0(P_\omega) \otimes \tilde{H}^1(P_{[m] \setminus \omega}) \rightarrow \tilde{H}^2(\partial P)$. This corresponds to the Poincare duality pairing.
- (3) $\tilde{H}^0(P_{\omega_1}) \otimes \tilde{H}^0(P_{\omega_2}) \rightarrow \tilde{H}^1(P_{\omega_1 \sqcup \omega_2})$. This corresponds to the mapping

$$\hat{H}_2(P_{\omega_1}, \partial P_{\omega_1}) \otimes \hat{H}_2(P_{\omega_2}, \partial P_{\omega_2}) \rightarrow H_1(P_{\omega_1 \sqcup \omega_2}, \partial P_{\omega_1 \sqcup \omega_2}).$$

Each group on the left has a basis with elements corresponding to consistently oriented connected components of P_{ω_i} with a unique relation that the sum of these elements is zero. For connected components in P_{ω_1} and P_{ω_2} the product up to a sign is the intersection of them, which is a sum of classes $[\gamma_1], \dots, [\gamma_r]$ of disjoint oriented edge paths on $P_{\omega_1 \sqcup \omega_2}$ connecting components of $\partial P_{\omega_1 \sqcup \omega_2}$ (if the intersection is not a boundary cycle of each component), see Fig. 7. Moreover, for the product to be nonzero at least one component of $\partial P_{\omega_1 \sqcup \omega_2}$ should have one common point with some path γ_i . For each connected component on the right a basis in the first homology group corresponds to any set of oriented edge paths connecting one boundary cycle to all the other.

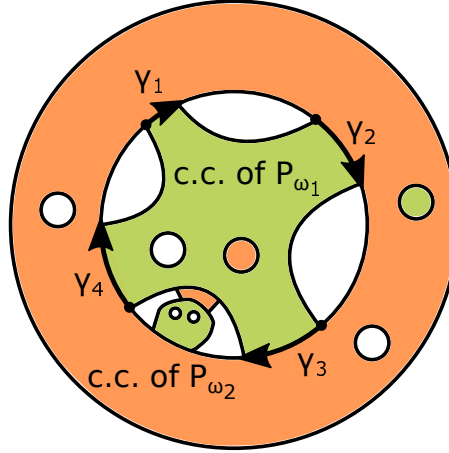

FIGURE 7. Intersection of two connected components of P_{ω_1} and P_{ω_2}

2. B-RIGIDITY OF ANY POGORELOV POLYTOPE

Definition 2.1. Let \mathfrak{P} be some set of 3-polytopes.

We call a number $n(P)$, a set $\mathfrak{S}_P \subset H^*(\mathcal{Z}_P)$ or a collection of such sets defined for any polytope $P \in \mathfrak{P}$ *B-rigid in the class \mathfrak{P}* if for any isomorphism φ of graded rings $H^*(\mathcal{Z}_P) \simeq H^*(\mathcal{Z}_Q)$, $P, Q \in \mathfrak{P}$, we have $n(P) = n(Q)$, $\varphi(\mathfrak{S}_P) = \mathfrak{S}_Q$, or each set from the collection for P is mapped bijectively to some set from the collection for Q respectively.

To be short, *B-rigidity* in the class of all simple 3-polytopes we call *B-rigidity*.

In [FW15] it was proved that the property to be a flag polytope is *B-rigid*. Namely, it is equivalent to the fact that the ring $\tilde{H}^*(\mathcal{Z}_P)/([\mathcal{Z}_P])$ is a (nonzero) indecomposable ring. Also it was proved that for flag 3-polytopes

$$\tilde{H}^1(P_\omega) = \bigoplus_{\omega_1 \perp \omega_2} \tilde{H}^0(P_{\omega_1}) \cdot \tilde{H}^0(P_{\omega_2}).$$

This result was based on the fact that for any flag 3-polytope and *any three pairwise different faces $\{F_i, F_j, F_k\}$ with $F_i \cap F_j = \emptyset$ there exist $l \geq 4$ and an l -belt \mathcal{B}_l such that $F_i, F_j \in \mathcal{B}_l$ and $F_k \notin \mathcal{B}_l$* . This fact is characteristic for a polytope $P \neq \Delta^3$ to be flag. Indeed, if P has a 3-belt, then for the faces F_i and F_j lying in different connected components of the complement to this belt there are no belts containing F_i and F_j .

On the base of these facts in [BE17S] and [BEMPP17] a simple characterization of flag polytopes was given: a simple 3-polytope $P \neq \Delta^3$ is flag if and only if

$$H^{m-2}(\mathcal{Z}_P) \subset (\tilde{H}^*(\mathcal{Z}_P))^2.$$

Moreover, it turned out that there is another criterion when a 3-simple polytope is flag.

Proposition 2.2. *A simple 3-polytope $P \neq \Delta^3$ with m faces is flag if and only if*

$$\operatorname{rk} H^4(\mathcal{Z}_P) = \frac{(m-2)(m-4)(m-6)}{3}.$$

Proof. Indeed, [BP15, Theorem 4.6.2] states that for a simple n -polytope

$$(1-t^2)^{m-n}(h_0 + h_1 t^2 + \cdots + h_n t^{2n}) = \sum_{-i, 2j} (-1)^i \beta^{-i, 2j} t^{2j},$$

where $h_0 + h_1 t + \cdots + h_n t^n = (t-1)^n + f_{n-1}(t-1)^{n-1} + \cdots + f_0$.

In particular, for 3-polytopes we have

$$\begin{aligned} (1-t^2)^h(1+ht^2+ht^4+t^6) = \\ 1 - \beta^{-1,4}t^4 + \sum_{j=3}^h (-1)^{j-1}(\beta^{-(j-1),2j} - \beta^{-(j-2),2j})t^{2j} + \\ (-1)^{h-1}\beta^{-(h-1),2(h+1)}t^{2(h+1)} + (-1)^h t^{2(h+3)}, \end{aligned}$$

where $h = m - 3$.

Then

$$\begin{aligned} (1 - ht^2 + \frac{h(h-1)}{2}t^4 - \frac{h(h-1)(h-2)}{6}t^6 + \dots)(1 + ht^2 + ht^4 + t^6) = \\ 1 - \beta^{-1,4}t^4 + (\beta^{-2,6} - \beta^{-1,6})t^6 + \dots \end{aligned}$$

For any simple 3-polytope P we have:

- $\operatorname{rk} H^3(\mathcal{Z}_P) = \beta^{-1,4} = |N_2(P)| = \frac{h(h-1)}{2}$;
- $\beta^{-1,6} = \#\{3\text{-belts}\}$;
- $\beta^{-2,6} - \beta^{-1,6} = \frac{(h^2-1)(h-3)}{3}$.

Then

$$\operatorname{rk} H^4(\mathcal{Z}_P) = \beta^4 = \beta^{-2,6} = \beta^{-1,6} + \frac{(h^2-1)(h-3)}{3} = \#\{3\text{-belts}\} + \frac{(h^2-1)(h-3)}{3}$$

□

It is easy to see that a polytope has no 4-belts if and only if the multiplication

$$H^3(\mathcal{Z}_P) \otimes H^3(\mathcal{Z}_P) \rightarrow H^6(\mathcal{Z}_P)$$

is trivial. Thus, the property to be a Pogorelov polytope is also B -rigid.

In [FMW15] (details see also in [BE17S]) it was proved that any Pogorelov polytope is B -rigid.

The proof consisted of several steps. Denote

$$N_2(P) = \{\{i, j\} \subset [m]: F_i \cap F_j = \emptyset\}.$$

For any $\omega \in N_2(P)$ we have $\tilde{H}^0(P_\omega) = \mathbb{Z}$. Denote by $\tilde{\omega}$ a generator of this group (it is defined up to a sign, we choose one of them arbitrarily). Then for any 3-polytope $H^3(\mathcal{Z}_P)$ is a free abelian group with the basis $\{\tilde{\omega} : \omega \in N_2(P)\}$.

First it was proved that the set of elements

$$\{\pm\tilde{\omega} : \omega \in N_2(P)\} \subset H^3(\mathcal{Z}_P)$$

corresponding to sets $\omega \in N_2(P)$ is B -rigid in the class of Pogorelov polytopes. The proof was based on the so-called *separable circuit condition* (SCC): *for any Pogorelov polytope P and any three different faces $\{F_i, F_j, F_k\}$ with $F_i \cap F_j = \emptyset$ there exist $l \geq 5$ and an l -belt \mathcal{B}_l such that $F_i, F_j \in \mathcal{B}_l$, $F_k \notin \mathcal{B}_l$, and F_k does not intersect at least one of the two connected components of $|\mathcal{B}_l| \setminus (F_i \cup F_j)$.* In fact, this condition is characteristic for a polytope $P \neq \Delta^3$ to be Pogorelov. Indeed, if P has a 4-belt, then for the faces F_i and F_j lying in different connected components of the complement to this belt and F_k lying on the belt any belt containing F_i and F_j intersects F_k by both components. Later, in Lemma 5.2 we will prove an analog of SCC for almost Pogorelov polytopes. It will be also characteristic to be an almost Pogorelov polytope with one exception, see Proposition 5.3.

Now let us give some details of the proof, which we will need in what follows.

Definition 2.3. An *annihilator* of an element r in a ring R is defined as

$$\text{Ann}_R(r) = \{s \in R : rs = 0\}$$

Since the group $H^*(\mathcal{Z}_P)$ has no torsion, we have the isomorphism $H^*(\mathcal{Z}_P, \mathbb{Q}) \simeq H^*(\mathcal{Z}_P) \otimes \mathbb{Q}$ and the embedding $H^*(\mathcal{Z}_P) \subset H^*(\mathcal{Z}_P) \otimes \mathbb{Q}$. For polytopes P and Q the isomorphism $H^*(\mathcal{Z}_P) \simeq H^*(\mathcal{Z}_Q)$ implies the isomorphism over \mathbb{Q} . For the cohomology over \mathbb{Q} all theorems about structure of $H^*(\mathcal{Z}_P, \mathbb{Q})$ are still valid.

It was proved that for a Pogorelov polytope P and an element α in $H = H^*(\mathcal{Z}_P, \mathbb{Q})$:

$$\alpha = \sum_{\omega \in N_2(P)} r_\omega \tilde{\omega} \quad \text{with } |\{\omega : r_\omega \neq 0\}| \geq 2$$

we have

$$\dim \text{Ann}_H(\alpha) < \dim \text{Ann}_H(\tilde{\omega}), \text{ if } r_\omega \neq 0.$$

We call this result the *annihilator lemma*.

For almost Pogorelov polytopes the annihilator lemma is not valid, see Proposition 8.3. In Lemma 6.1 we will modify it to be valid for all simple 3-polytopes. Corollary 6.7 shows how this lemma can be applied to almost Pogorelov polytopes. Namely, under any isomorphism of graded rings $H^*(\mathcal{Z}_P) \rightarrow H^*(\mathcal{Z}_Q)$ the element $\tilde{\omega}$ for $\omega \in N_2(P)$ is mapped to $\pm\tilde{\omega}'$ for $\omega' \in N_2(Q)$, if $\omega = \{p, q\}$, and both F_p and F_q are not adjacent to quadrangles. In Definition 6.3 for $\omega \in N_2(P)$ we introduce the notion of *good* and *bad* elements in $N_2(P)$, and in Corollary 6.5 we prove that for any simple 3-polytopes P and Q the element $\tilde{\omega}, \omega \in N_2(P)$ is mapped to a linear combination of an element $\tilde{\omega}', \omega' \in N_2(Q)$ and elements $\tilde{\omega}'', \omega'' \in N_2(Q)$, where ω'' are bad for ω' .

On the second step in [FMW15] it was proved that the set

$$\{\pm\tilde{\mathcal{B}}_k : \mathcal{B}_k - \text{ a } k\text{-belt}\} \subset H^{k+2}(\mathcal{Z}_P)$$

is B -rigid in the class of Pogorelov polytopes. Here $\widetilde{\mathcal{B}}_k$ is the element in $H^{k+2}(\mathcal{Z}_P)$ corresponding to a generator in $\widetilde{H}^1(P_{\omega(\mathcal{B}_k)}) \simeq \mathbb{Z}$, where $\omega(\mathcal{B}_k) = \{i \in [m]: F_i \in \mathcal{B}_k\}$. In Corollary 7.2 we will prove that the set of elements corresponding to 4-belts is B -rigid in the class of almost Pogorelov polytopes. Also in Corollary 6.8 we will prove that if $P \in \mathcal{P}_{aPog} \setminus \{I^3, M_5 \times I\}$ and all the faces of a k -belt \mathcal{B}_k do not have common points with quadrangles, then under any isomorphism of graded rings $H^*(\mathcal{Z}_P) \rightarrow H^*(\mathcal{Z}_Q)$ for a simple 3-polytope Q the element $\widetilde{\mathcal{B}}_k$ is mapped to $\pm \widetilde{\mathcal{B}}'_k$ for some k -belt \mathcal{B}'_k of Q .

Also from the arguments in [FMW15] it follows (see the detailed proof in [BE17S]) that for any simple 3-polytope P the subgroup $\mathbf{B}_k \subset H^{k+2}(\mathcal{Z}_P)$, $4 \leq k \leq m-2$, with the basis $\{\widetilde{\mathcal{B}}_k: \mathcal{B}_k - \text{ a } k\text{-belt}\}$ is B -rigid. In particular, the number of k -belts, $k \geq 4$, is B -rigid.

Then it was proved that the set of elements

$$\{\pm \widetilde{\mathcal{B}}_k: \mathcal{B}_k - \text{ a } k\text{-belt around a face}\} \subset H^{k+2}(\mathcal{Z}_P)$$

is B -rigid in the class of Pogorelov polytopes.

Corollary 2.4. *The property to be a strongly Pogorelov polytope is B -rigid.*

This induces a bijection between the sets of faces of polytopes.

Then it was proved that images of adjacent faces are adjacent. This finishes the proof of B -rigidity of any Pogorelov polytope.

3. B -RIGIDITY OF THE PROPERTY TO BE AN ALMOST POGORELOV POLYTOPE

Our aim is to prove that the property to be an almost Pogorelov polytope is B -rigid.

First the cube and the pentagonal prism are the only flag polytopes with $m = 6$ and $m = 7$ respectively. Hence, they are B -rigid.

Now consider all the other almost Pogorelov polytopes. They have no adjacent quadrangles, since a pair of adjacent quadrangles should be surrounded by a nontrivial 4-belt.

The image of the mapping $H^3(\mathcal{Z}_P) \otimes H^3(\mathcal{Z}_P) \rightarrow H^6(\mathcal{Z}_P)$ is the subgroup \mathbf{B}_4 generated by the elements $\widetilde{\mathcal{B}}_4$ corresponding to 4-belts.

There is a B -rigid subgroup $A_3 \subset H^3(\mathcal{Z}_P)$:

$$A_3 = \{x \in H^3(\mathcal{Z}_P): x \cdot y = 0 \text{ for all } y \in H^3(\mathcal{Z}_P)\}.$$

It is generated by elements $\widetilde{\omega}$ such that the set $\omega \in N_2(P)$ does not belong to $\omega(\mathcal{B}_4)$ for any 4-belt \mathcal{B}_4 . Denote this set $N_2^0(P)$.

The subgroup A_3 is a direct summand in $H^3(\mathcal{Z}_P)$, therefore the quotient group $\mathbf{H}_3 = H^3(\mathcal{Z}_P)/A_3$ is also a free abelian group. We have the mapping $\mathbf{H}_3 \otimes \mathbf{H}_3 \rightarrow H^6(\mathcal{Z}_P)$. Also $\mathbf{H}_3 \otimes \mathbb{Q} \simeq H^3(\mathcal{Z}_P, \mathbb{Q})/(A_3 \otimes \mathbb{Q})$ and there is an embedding $\mathbf{H}_3 \subset \mathbf{H}_3 \otimes \mathbb{Q}$.

Lemma 3.1. *We have $2 \text{ rk } \mathbf{B}_4 \geq \text{rk } \mathbf{H}_3$, and the equality holds if and only if each set $\omega \in N_2(P)$ can be included in at most one set $\omega(\mathcal{B}_4)$.*

Proof. Each element $\widetilde{\mathcal{B}}_4$ can be represented uniquely up to a change of order as a product of two elements $\widetilde{\omega}_1 \cdot \widetilde{\omega}_2$, $\omega_i \in N_2(P)$. On the other hand, an element $\widetilde{\omega}$ can be a factor of several

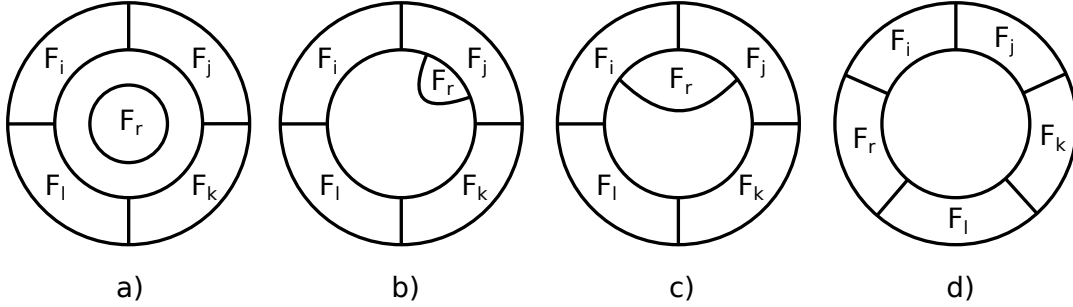

FIGURE 8. a) 4-belt (F_i, F_j, F_k, F_l) disjoint from F_r ; b) 4-belt (F_i, F_j, F_k, F_l) , and F_r intersects only F_j ; c) 4-belt (F_i, F_j, F_k, F_l) and F_r intersects only F_i and F_j ; d) 5-belt $(F_i, F_j, F_k, F_l, F_r)$

elements, corresponding to 4-belts, if the faces F_p, F_q can be included into several 4-belts, where $\omega = \{p, q\}$. Let us calculate the number of pairs (ω, \mathcal{B}_4) , where $\omega \in N_2(P)$ and $\omega \subset \omega(\mathcal{B}_4)$. On the one hand, it is equal to $2 \text{rk } \mathcal{B}_4$, on the other hand, it is at least the number of elements in $N_2(P)$ that can be included into a 4-belt, and the equality holds if and only if each this element can be included in exactly one set $\omega(\mathcal{B}_4)$. \square

Lemma 3.2. *Let P be a flag 3-polytope. If $2 \text{rk } \mathcal{B}_4 = \text{rk } \mathbf{H}_3$, then P has no adjacent quadrangles.*

Proof. If P is the cube I^3 , then $\text{rk } \mathcal{B}_4 = \text{rk } \mathbf{H}_3 = 3$. Else if P has two adjacent quadrangles, then these quadrangles are surrounded by a 4-belt such that the two faces intersecting both these quadrangles are included into two 4-belts surrounding the quadrangles. \square

Lemma 3.3. *Let P be a flag 3-polytope.*

If $\tilde{H}_1(P_\omega) \neq 0$, then $|\omega| \geq 4$. Moreover, if $|\omega| = 4$, then $\omega = \omega(\mathcal{B}_4)$ for some 4-belt.

If $2 \text{rk } \mathcal{B}_4 = \text{rk } \mathbf{H}_3$, and $|\omega| = 5$, then $\tilde{H}_1(P_\omega) \neq 0$ if and only if P_ω has one of the 4 types drawn on Fig. 8.

Proof. As we mentioned above, P_ω is a disjoint union of spheres with holes. If $\tilde{H}_1(P_\omega) \neq 0$, then one sphere $P_{\omega'}$, $\omega' \subset \omega$, has at least two holes. This is impossible for $|\omega'| = 1$ or 2 . Hence, $|\omega'| \geq 3$. Consider the boundary component γ of $P_{\omega'}$. Walking along this simple edge-cycle we obtain a cyclic sequence of faces $\mathcal{L} = (F_{i_1}, \dots, F_{i_p})$, where the index i_l lies in $\mathbb{Z}_p = \mathbb{Z}/p\mathbb{Z}$. If $p = 1$, then $P_{\omega'}$ consists of one face and is contractible. If $p = 2$, then $P_{\omega'}$ consists of two adjacent faces and also is contractible. If $p = 3$, then F_{i_1}, F_{i_2} and F_{i_3} are different pairwise adjacent faces. Since P has no 3-belts, they have a common vertex and $P_{\omega'}$ consists of these three faces and is contractible. Thus, $p \geq 4$.

We have $F_{i_l} \neq F_{i_{l+1}}$ for any l . If $F_{i_l} = F_{i_{l+2}}$ for some l , then we have the configuration on Fig. 9a), and $P_{\omega'}$ is homeomorphic to $P_{\omega' \setminus \{i_{l+1}\}}$. If $F_{i_l} \cap F_{i_{l+1}}$ is an edge, then we have the configuration on Fig. 9b), and $P_{\omega'}$ is homeomorphic to $P_{\omega' \setminus \{i_{l+1}\}}$. If $F_{i_l} = F_{i_{l+3}}$, then $F_{i_l}, F_{i_{l+1}}, F_{i_{l+2}}$ are three

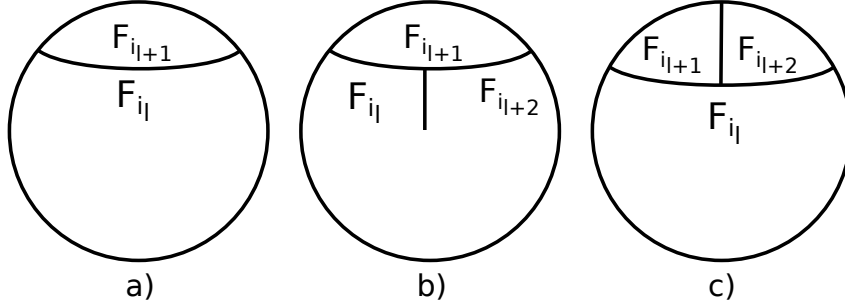

FIGURE 9. a) $F_{i_l} = F_{i_{l+2}}$; b) $F_{i_l} \cap F_{i_{l+2}}$ is an edge, c) $F_{i_l} = F_{i_{l+3}}$

different pairwise adjacent faces. Since P has no 3-belts, the edge $F_{i_{l+1}} \cap F_{i_{l+2}}$ intersects F_{i_l} , and we have the configuration on Fig. 9c). Then P_ω is homeomorphic to $P_{\omega \setminus \{i_{l+1}, i_{l+2}\}}$.

If $|\omega'| = 3$, then $F_{i_l} \neq F_{i_{l+1}}$, $F_{i_l} \neq F_{i_{l+2}}$, $F_{i_l} \neq F_{i_{l+3}}$ for all l by the previous argument. A contradiction. Hence, $|\omega| \geq |\omega'| \geq 4$.

If $|\omega'| = 4$, then $F_{i_l} \neq F_{i_{l+1}}$, $F_{i_l} \neq F_{i_{l+2}}$, $F_{i_l} \cap F_{i_{l+2}} = \emptyset$, $F_{i_l} \neq F_{i_{l+3}}$ for all l by the previous argument. If $p = 4$, then \mathcal{L} is a 4-belt and $\omega = \omega' = \omega(\mathcal{L})$. Let $p \geq 5$. Then $F_{i_1} = F_{i_5} \neq F_{i_6}$, in particular, $p \geq 6$. But F_{i_6} is separated from $F_{i_2}, F_{i_3}, F_{i_4}$ by $F_{i_1} = F_{i_5}$, which is a contradiction. Thus, $p = 4$.

Let $|\omega| = 5$ and $2 \operatorname{rk} \mathbf{B}_4 = \operatorname{rk} \mathbf{H}_3$. If $\omega' \neq \omega$, then $\omega' = \omega(\mathcal{B}_4)$ for some 4-belt, and P_ω has the structure drawn on Fig. 8a). Now let $\omega' = \omega$. If $F_{i_l} = F_{i_{l+2}}$ for some l , then by the previous argument P_ω has the structure drawn on Fig. 8b). If $F_{i_l} \cap F_{i_{l+2}}$ is an edge for some l , then P_ω has the structure drawn on Fig. 8c). If $F_{i_l} = F_{i_{l+3}}$, then P_ω is contractible, which is a contradiction. Now assume that $F_{i_l} \neq F_{i_{l+1}}$, $F_{i_l} \neq F_{i_{l+2}}$, $F_{i_l} \cap F_{i_{l+2}} = \emptyset$, $F_{i_l} \neq F_{i_{l+3}}$ for all l . If $F_{i_l} \cap F_{i_{l+3}}$ is an edge for some l , then $\mathcal{B}_4 = (F_{i_l}, F_{i_{l+1}}, F_{i_{l+2}}, F_{i_{l+3}})$ is a 4-belt. Let $i = \omega \setminus \{i_l, i_{l+1}, i_{l+2}, i_{l+3}\}$. The face F_i lies in one of the connected components of the complement to this belt in ∂P . If F_i intersects two opposite faces of the belt, say $F_{i_{l+1}}$ and $F_{i_{l+2}}$, then it should also intersect $F_{i_{l+3}}$ and $F_{i_{l+4}}$ for otherwise the pair $\{F_{i_{l+1}}, F_{i_{l+2}}\}$ can be included into two 4-belts, which contradicts the condition $2 \operatorname{rk} \mathbf{B}_4 = \operatorname{rk} \mathbf{H}_3$. Since P is flag, this means, that \mathcal{B}_4 is a belt around F_i and P_ω is contractible. Thus, F_i intersects at most two faces and they should be successive in the belt. We obtain the cases b) and c) of Fig. 8 again. Now consider the case when $F_{i_l} \cap F_{i_{l+3}} = \emptyset$ for all l . Then $p \geq 5$, $F_{i_l} \neq F_{i_{l+4}}$ and $\omega = \{i_l, i_{l+1}, i_{l+2}, i_{l+3}, i_{l+4}\}$ for any l . If $p = 5$, then \mathcal{L} is a 5-belt (Fig. 8d). Else $F_{i_l} = F_{i_{l+5}}$, in particular, $p \geq 7$. Then $F_{i_{l+6}}$ is separated from $F_{i_{l+1}}, F_{i_{l+2}}, F_{i_{l+3}}, F_{i_{l+4}}$ by $F_{i_l} = F_{i_{l+5}}$, which is a contradiction. Thus, $p = 5$. Now we have considered all the possible cases and the proof is finished. \square

Corollary 3.4. *Let P be a flag 3-polytope with $2 \operatorname{rk} \mathbf{B}_4 = \operatorname{rk} \mathbf{H}_3$. Then the image I_7 of the mapping*

$$H^3(\mathcal{Z}_P) \otimes H^4(\mathcal{Z}_P) \rightarrow H^7(\mathcal{Z}_P)$$

is a free abelian group with a basis corresponding to elements $\widetilde{\mathcal{B}}_5$, where \mathcal{B}_5 is a 5-belt, and generators of the groups $\widetilde{H}^1(P_\omega) \simeq \mathbb{Z}$ for P_ω drawn on Fig. 8 a)-c).

Corollary 3.5. *Let P be a flag 3-polytope with $2 \operatorname{rk} \mathbf{B}_4 = \operatorname{rk} \mathbf{H}_3$.*

$$\operatorname{rk} I_7 = \#\{5\text{-belts}\} + (m - 5)\#\{\text{trivial 4-belts}\} + (m - 4)\#\{\text{nontrivial 4-belts}\}.$$

Proof. For any 4-belt $\mathcal{B} = (F_i, F_j, F_k, F_l)$ and any face $F_r \notin \mathcal{B}$ if F_r intersects opposite faces of the belt, say F_i and F_k , then $F_r \cap F_j \neq \emptyset$, for otherwise (F_i, F_j, F_k, F_r) is a 4-belt, and $F_r \cap F_l \neq \emptyset$ for the same reason. Since P is flag, this implies that \mathcal{B} surrounds F_r . Otherwise, F_r intersects at most two faces, and they should be successive. Then $\mathcal{B} \cup F_r$ has the form drawn on Fig. 8a)-c). For a trivial belt we have $m - 5$ such faces F_r , and for a nontrivial belt we have $m - 4$ such faces. This finishes the proof. \square

Theorem 3.6. *A flag simple 3-polytope P belongs to $\mathcal{P}_{aPog} \setminus \{I^3, M_5 \times I\}$ if and only if*

$$2 \operatorname{rk} \mathbf{B}_4 = \operatorname{rk} \mathbf{H}_3, \text{ and } \operatorname{rk} I_7 = \operatorname{rk} \mathbf{B}_5 + (m - 5)\operatorname{rk} \mathbf{B}_4,$$

where $\operatorname{rk} \mathbf{B}_5 = \#\{5\text{-belts}\}$ is a B-rigid number. In particular, the property to be an almost Pogorelov polytope is B-rigid.

Proof. Corollary 3.5 implies that if the conditions of the theorem hold, then every 4-belt of P is trivial, hence P is an almost Pogorelov polytope. Lemma 3.2 implies that P has no adjacent quadrangles. Hence, P is different from the cube and the pentagonal prism.

Now let $P \in \mathcal{P}_{aPog} \setminus \{I^3, M_5 \times I\}$. It has no adjacent quadrangles, for otherwise these quadrangles should be surrounded by a nontrivial 4-belt. Consider a pair of nonadjacent faces F_i and F_k that can be included into a 4-belt (F_i, F_j, F_k, F_l) . The belt surrounds some quadrangle F_r . Let F_i and F_k be included into the other 4-belt (F_i, F_p, F_k, F_q) . This belt surrounds some other quadrangle $F_t \neq F_r$. Then (F_i, F_r, F_k, F_t) is a 4-belt. It surrounds some quadrangle adjacent to both F_t and F_r . A contradiction. Thus, any pair of nonadjacent faces of P can be included in at most one 4-belt, and $2 \operatorname{rk} \mathbf{B}_4 = \operatorname{rk} \mathbf{H}_3$ by Lemma 3.1. Then $\operatorname{rk} I_7 = \operatorname{rk} \mathbf{B}_5 + (m - 5)\operatorname{rk} \mathbf{B}_4$ by Corollary 3.5. This finishes the proof. \square

Corollary 3.7. *Any almost Pogorelov polytope with at most 11 faces is B-rigid.*

Proof. Indeed, as we mentioned above for $m = 6$ the cube, and for $m = 7$ the pentagonal prism is a unique flag 3-polytope. For $m = 8$ there are no almost Pogorelov polytopes. For $m = 9$ the associahedron As^3 is a unique almost Pogorelov polytope. For $m = 10$ and 11 different almost Pogorelov polytopes have different number of quadrangles, which is equal to $\operatorname{rk} \mathbf{B}_4$. \square

Corollary 3.8. *A flag simple 3-polytope P is an ideal almost Pogorelov polytope if and only if*

$$2 \operatorname{rk} \mathbf{B}_4 = \operatorname{rk} \mathbf{H}_3 = m - 2, \text{ and } \operatorname{rk} I_7 = \operatorname{rk} \mathbf{B}_5 + \frac{(m - 5)(m - 2)}{2}.$$

In particular, the property to be an ideal almost Pogorelov polytope is B-rigid.

Proof. Indeed, an almost Pogorelov polytope is ideal if and only if any its vertex lies on a unique quadrangle, which is equivalent to the fact that the number of quadrangles $p_4 = \operatorname{rk} \mathbf{B}_4$ multiplied by 4 is equal to the number of vertices f_0 , which is $2(m - 2)$ for any simple 3-polytope. \square

Corollary 3.9. *The 3-dimensional permutohedron Pe^3 is B -rigid. Moreover, any ideal almost Pogorelov polytope with $m \leq 20$ is B -rigid.*

Proof. Indeed, Pe^3 is a unique ideal almost Pogorelov polytope with minimal number of faces $m = 14$. Since $m = 2 + 2p_4$, this number is even. For $m = 16$ there are no ideal almost Pogorelov polytopes. For $m = 18$ and $m = 20$ there are unique ideal almost Pogorelov polytopes. \square

4. THE QUOTIENT RING OF $H^*(\mathcal{Z}_P)$ MODULO THE IDEAL GENERATED BY A_3 .

Now we will give equivalent characterizations of almost Pogorelov and ideal almost Pogorelov polytopes in terms of the quotient ring of $H^*(\mathcal{Z}_P)$ modulo the ideal generated by A_3 .

Lemma 4.1. *Let P be a flag 3-polytope. Then for $k \geq 5$ any its k -belt \mathcal{B} different from the belt surrounding the base of a k -gonal prism, contains a pair of nonadjacent faces that can not be included into any 4-belt.*

Proof. Let $\mathcal{B} = (F_{i_1}, F_{i_2}, \dots, F_{i_k})$ and C_1 and C_2 be components of its complement in ∂P . Let any pair of non-successive faces of \mathcal{B} can be included into a 4-belt. Then there is a 4-belt $(F_{i_1}, F_{p_1}, F_{i_3}, F_{q_1})$. At least one of the faces F_{p_1} and F_{q_1} , say F_{p_1} is different from F_{i_2} , hence lies in $\overline{C_1}$ or $\overline{C_2}$, say $\overline{C_1}$. There is a 4-belt $(F_{i_2}, F_{p_2}, F_{i_4}, F_{q_2})$. As before, F_{p_2} lies in $\overline{C_1}$ or $\overline{C_2}$. If F_{p_2} lies in $\overline{C_1}$, then $F_{p_1} = F_{p_2}$, since no other faces in $\overline{C_1}$ different from F_{p_1} can intersect both F_{i_2} and F_{i_4} (this follows from the Jordan curve theorem, since the set $F_{i_2} \cap \overline{C_1}$ lies inside the disk bounded by a simple piecewise linear curve lying inside $F_{i_1} \cup F_{i_2} \cup F_{i_3} \cup F_{p_1}$, and $F_{i_4} \cap \overline{C_1}$ lies outside this curve (see Fig. 10a)). Thus, F_{p_1} is adjacent to F_{i_1} , F_{i_2} , F_{i_3} , and F_{i_4} . Since P is flag, we obtain configuration drawn on Fig. 10b). Then $F_{q_1}, F_{q_2} \subset \overline{C_2}$. Thus, $F_{q_1} = F_{q_2}$ by the same argument, and we obtain the same picture as for F_{p_1} . There is a 4-belt $(F_{i_3}, F_{p_3}, F_{i_5}, F_{q_3})$. The face F_{i_3} intersects only faces F_{i_2} , F_{i_4} , F_{p_1} , and F_{q_1} . Since $F_{i_2} \cap F_{i_5} = \emptyset$, we have $\{F_{p_3}, F_{q_3}\} = \{F_{p_1}, F_{q_1}\}$, and we can assume that $F_{p_3} = F_{p_1}$, and $F_{q_3} = F_{q_1}$. Repeating this argument, we obtain that $F_{p_i} = F_{p_1}$, $F_{q_i} = F_{q_1}$ for all i , and \mathcal{B} is the belt around the base of a k -gonal prism, which is a contradiction.

Thus, $F_{p_2} \subset \overline{C_2}$, $F_{q_2} \subset F_{i_3} \cup \overline{C_2}$, and $F_{q_1} \subset F_{i_2} \cup \overline{C_1}$. Moreover, if $F_{q_1} = F_{i_2}$, then $F_{p_1} \cap F_{i_2} = \emptyset$. Else $F_{p_1}, F_{q_1} \subset \overline{C_1}$, and at least one of these faces do not intersect F_{i_2} . Without loss of generality we can assume that $F_{p_1} \cap F_{i_2} = \emptyset$. Similarly $F_{p_2} \cap F_{i_3} = \emptyset$. Repeating the argument, we obtain $F_{p_3} \subset \overline{C_1}$, $F_{q_3} \subset F_{i_4} \cup \overline{C_1}$, $F_{p_3} \cap F_{i_4} = \emptyset$, and so on. If k is odd, then $F_{p_k} \subset \overline{C_1}$, $F_{q_k} \subset F_{i_{k+1}} \cup \overline{C_1}$, and $F_{p_1} \subset F_{i_2} \cup \overline{C_2}$, which is a contradiction. If k is even, then $k \geq 6$. Consider the 4-belt $(F_{i_1}, F_s, F_{i_4}, F_t)$. Both faces F_s and F_t do not belong to \mathcal{B} , since they intersect both F_{i_1} and F_{i_4} . But in $\overline{C_1}$ there are no faces intersecting both F_{i_1} and F_{i_4} , because $F_{p_3} \cap F_{i_4} = \emptyset$. Similarly in $\overline{C_2}$ there are no faces intersecting both F_{i_1} and F_{i_4} , because $F_{p_k} \cap F_{i_1} = \emptyset$. A contradiction. This finishes the proof. \square

Corollary 4.2. *In the ring $H^*(\mathcal{Z}_P)/\langle A_3 \rangle$ all the elements $[\widetilde{\mathcal{B}}_k]$ corresponding to k -belts, $k \geq 5$, are zero.*

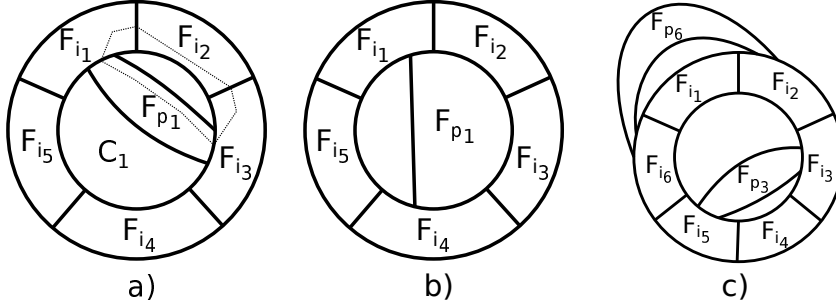

FIGURE 10. Configuration of faces near the belt

Corollary 4.3. *Let P be a flag 3-polytope with $2 \operatorname{rk} \mathbf{B}_4 = \operatorname{rk} \mathbf{H}_3$. Then the image A_7 of the mapping*

$$A_3 \otimes H^4(\mathcal{Z}_P) \rightarrow H^7(\mathcal{Z}_P)$$

is a free abelian group \mathbf{B}_5 with the basis corresponding to elements $\widetilde{\mathcal{B}}_5$, where \mathcal{B}_5 is a 5-belt.

Proof. Indeed, Lemma 4.1 implies, that $\mathbf{B}_5 \subset A_7$. Let $x \in A_7$. Then

$$x = \left(\sum_{\omega \in N_2^0(P)} \lambda_\omega \widetilde{\omega} \right) \cdot \left(\sum_{\tau \subset [m]: |\tau|=3} y_\tau \right) = \sum_{\eta \subset [m]: |\eta|=5} z_\eta,$$

where each nonzero y_τ corresponds to an element in $\widehat{H}_2(P_\tau, \partial P_\tau) \neq 0$, and each nonzero z_η corresponds to an element in $\widehat{H}_1(P_\eta, \partial P_\eta) \neq 0$ such that for some $\omega \in N_2^0(P)$ we have $\omega \subset \eta$ and $\widehat{H}_2(P_{\eta \setminus \omega}, \partial P_{\eta \setminus \omega}) \neq 0$. By Lemma 3.3 P_η should have structure drawn on Fig. 8a)-d). For cases a)-c) for any $\omega \in N_2^0(P)$, $\omega \subset \eta$ the set $P_{\eta \setminus \omega}$ is contractible. Thus, each η has the form $\omega(\mathcal{B}_5)$ for some 5-belt, and $z_\eta = \mu_\eta \widetilde{\mathcal{B}}_5$. Hence, $A_7 \subset \mathbf{B}_5$, and this finishes the proof. \square

Denote $\mathbf{I}_7 = I_7/A_7$.

Corollary 4.4. *Let P be a flag simple 3-polytope with $2 \operatorname{rk} \mathbf{B}_4 = \operatorname{rk} \mathbf{H}_3$. Then group \mathbf{I}_7 is a free abelian group of rank*

$$(m-5) \#\{\text{trivial 4-belts}\} + (m-4) \#\{\text{nontrivial 4-belts}\} \geq (m-5) \operatorname{rk} \mathbf{B}_4.$$

Corollary 4.5. *A flag simple 3-polytope P belongs to $\mathcal{P}_{\text{aPog}} \setminus \{I^3, M_5 \times I\}$ if and only if*

$$2 \operatorname{rk} \mathbf{B}_4 = \operatorname{rk} \mathbf{H}_3, \text{ and } \operatorname{rk} \mathbf{I}_7 = (m-5) \operatorname{rk} \mathbf{B}_4.$$

Corollary 4.6. *A flag simple 3-polytope P is an ideal almost Pogorelov polytope if and only if*

$$2 \operatorname{rk} \mathbf{B}_4 = \operatorname{rk} \mathbf{H}_3 = m-2, \text{ and } \operatorname{rk} \mathbf{I}_7 = \frac{(m-5)(m-2)}{2}.$$

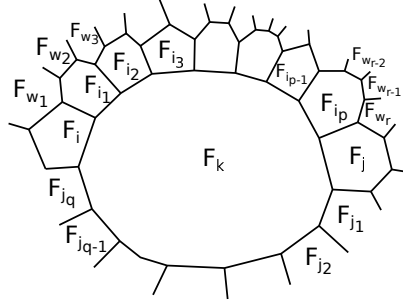

FIGURE 11. Case 1

5. ANALOG OF THE SCC FOR ALMOST POGORELOV POLYTOPES

In this section we generalize the SCC to almost Pogorelov polytopes.

Definition 5.1. A k -path, $k \geq 1$, (or a *thick path*) is a sequence $(F_{i_1}, \dots, F_{i_k})$ of faces such that successive faces are adjacent. A k -path is called *simple*, if all its faces are pairwise distinct. By definition a *length* of a k -path is equal to k . For any two faces in P there is a thick path connecting them. The shortest thick path between faces is simple.

A 1-loop is a face. By a k -loop, $k \geq 2$, we call a closed $(k+1)$ -path $(F_{i_1}, \dots, F_{i_{k+1}})$: $F_{i_{k+1}} = F_{i_1}$. We denote the k -loop simply $(F_{i_1}, \dots, F_{i_k})$. A k -loop is called *simple*, if all its faces are distinct. For convenience we assume that the parameter j in the index i_j of a k -loop belongs to $\mathbb{Z}_k = \mathbb{Z}/k\mathbb{Z}$, that is $i_k = i_0$, $i_{k+1} = i_1$ and so on.

For a thick path, a k -loop or a k -belt \mathcal{L} denote by $|\mathcal{L}|$ the union of its faces. The following result generalize the SCC, which is crucial for Pogorelov polytopes.

Lemma 5.2. *Let P be an almost Pogorelov polytope. Then for three pairwise different faces $\{F_i, F_j, F_k\}$ such that $F_i \cap F_j = \emptyset$ there exists an l -belt ($l \geq 4$) \mathcal{B}_l such that $F_i, F_j \in \mathcal{B}_l$, $F_k \notin \mathcal{B}_l$, and F_k does not intersect at least one of the two connected components of $|\mathcal{B}_l| \setminus (F_i \cup F_j)$ if and only if F_k does not intersect quadrangles among the faces F_i and F_j .*

Remark 3. The same result in the dual setting for simplicial polytopes was earlier proved in [FMW20, Proposition F.1].

Proof. If F_i is a quadrangle adjacent to F_k , then any l -belt \mathcal{B}_l containing F_i and not containing F_k in the closure of each connected component of $|\mathcal{B}_l| \setminus (F_i \cup F_j)$ contains a face from the 4-belt around F_i adjacent to F_k . Hence, F_k intersects both connected components.

Now let F_k do not intersect quadrangles among the faces F_i and F_j .

Since P is flag, there is an s -belt $\mathcal{B}_1 = (F_i, F_{i_1}, \dots, F_{i_p}, F_j, F_{j_1}, \dots, F_{j_q})$, with $F_k \notin \mathcal{B}_1$, $s = p + q + 2$, and $p, q \geq 1$. The complement $\partial P \setminus |\mathcal{B}_1|$ consists of two connected components C_1 and C_2 , both homeomorphic to disks. Without loss of generality assume that $F_k \subset \overline{C_1}$. Then either $\overline{C_1} = F_k$, or $\partial C_1 \cap F_k$ consists of finite set of disjoint edge-segments $\gamma_1, \dots, \gamma_d$.

In the first case \mathcal{B}_1 surrounds F_k , and F_i and F_j are adjacent to F_k . Consider all faces $\{F_{w_1}, \dots, F_{w_r}\}$ in $\overline{C_2}$ adjacent to faces in $\{F_{i_1}, \dots, F_{i_p}\}$ (see Fig. 11), in the order we meet them while walking round ∂C_2 from $\overline{C_2} \cap F_i$ to $\overline{C_2} \cap F_j$. Then $F_{w_a} \cap F_{j_b} = \emptyset$ for any a, b , for otherwise $(F_k, F_{j_b}, F_{w_a}, F_{i_c})$ is a 4-belt for any i_c with $F_{i_c} \cap F_{w_a} \neq \emptyset$, since $F_k \cap F_{w_a} = \emptyset$ and $F_{j_b} \cap F_{i_c} = \emptyset$. This belt should surround a quadrangle from \mathcal{B}_1 intersecting both F_{j_b} and F_{i_c} . This quadrangle can be only F_i or F_j , which is a contradiction. We have a thick path $(F_i, F_{w_1}, \dots, F_{w_r}, F_j)$. Consider the shortest thick path of the form $(F_i, F_{w_{s_1}}, \dots, F_{w_{s_t}}, F_j)$. If two faces of this path intersect, then they are successive, else there is a shorter thick path. Thus we have the belt $\mathcal{B}_l = (F_i, F_{w_{s_1}}, \dots, F_{w_{s_t}}, F_j, F_{j_1}, \dots, F_{j_q})$ with faces of the segment $(F_{w_{s_1}}, \dots, F_{w_{s_t}})$ not intersecting F_k .

In the second case we can assume that $F_i \cap F_k = \emptyset$ or $F_j \cap F_k = \emptyset$, say $F_i \cap F_k = \emptyset$, for otherwise we can take the belt \mathcal{B}'_1 around F_k . Let $\gamma_a = (F_k \cap F_{u_{a,1}}, \dots, F_k \cap F_{u_{a,l_a}})$. Denote by \mathcal{U}_a the thick path $(F_{u_{a,1}}, \dots, F_{u_{a,l_a}})$, and by \mathcal{S}_a the segment $(F_{s_{a,1}}, \dots, F_{s_{a,t_a}})$ of \mathcal{B}_1 between \mathcal{U}_a and \mathcal{U}_{a+1} . Then $\mathcal{B}_1 = (\mathcal{U}_1, \mathcal{S}_1, \mathcal{U}_2, \dots, \mathcal{U}_d, \mathcal{S}_d)$.

Consider the thick path $\Pi_a = (F_{w_{a,1}}, \dots, F_{w_{a,r_a}}) \subset \overline{C_2}$ arising while walking round ∂C_2 along edges $\partial C_2 \cap F_{u_{a,j}}$, $j = 1, \dots, l_a$ (see Fig. 12). Then $\Pi_a \cap \Pi_b = \emptyset$ for $a \neq b$, else $(F_w, F_{u_{a,j_1}}, F_k, F_{u_{b,j_2}})$ is a 4-belt for any $F_w \in \Pi_a \cap \Pi_b$ such that $F_w \cap F_{u_{a,j_1}} \neq \emptyset$, $F_w \cap F_{u_{b,j_2}} \neq \emptyset$. This belt surrounds a quadrangle F_x adjacent to F_k . If $F_x \subset \overline{C_1}$, then $F_x \cap F_w = \emptyset$, which is a contradiction. Otherwise, $F_x \in \mathcal{B}_1$, and the faces $F_{u_{a,j_1}}$ and $F_{u_{b,j_2}}$ are adjacent to it in the belt. Then $a = b$ (since P is flag), which is a contradiction. Also $F_{w_{a,j_1}} \neq F_{w_{a,j_2}}$ for $j_1 \neq j_2$. This is true for faces adjacent to the same face $F_{u_{a,i}}$. Let $F_{w_{a,j_1}} = F_{w_{a,j_2}}$. If the faces are adjacent to the successive faces $F_{u_{a,i}}$ and $F_{u_{a,i+1}}$, then the flagness condition implies that $j_1 = j_2$ and $F_{w_{a,j_1}}$ is the face in $\overline{C_2}$ intersecting $F_{u_{a,i}} \cap F_{u_{a,i+1}}$. If the faces are adjacent to non-successive faces $F_{u_{a,i}}$ and $F_{u_{a,j}}$, then $(F_{w_{a,j_1}}, F_{u_{a,i}}, F_k, F_{u_{a,j}})$ is a 4-belt around a quadrangle F_x . If $F_x \subset \overline{C_1}$, then $F_x \cap F_{w_{a,j_1}} = \emptyset$. Otherwise, $F_x \in \mathcal{B}_1$, and the faces $F_{u_{a,i}}$ and $F_{u_{a,j}}$ are adjacent to it in the belt. Without loss of generality we can assume that $F_x = F_{u_{a,i+1}}$, and $j = i + 2$. Then $j_1 = j_2$, and $F_{w_{a,j_1}}$ is a unique face in $\overline{C_2}$ intersecting $F_{u_{a,i+1}}$. A contradiction.

Now consider the thick path $\mathcal{V}_b = (F_{v_{b,1}}, \dots, F_{v_{b,c_b}})$ arising while walking round ∂C_1 along edges $\partial C_1 \cap F_{s_{b,j}}$ (see Fig. 12). Then $|\mathcal{V}_a| \cap |\mathcal{V}_b| = \emptyset$ for $a \neq b$, and $|\Pi_a| \cap |\mathcal{V}_b| = \emptyset$ for any a, b , since interiors of the corresponding faces lie in different connected components of $\partial P \setminus (|\mathcal{B}_1| \cup F_k)$.

Now we will deform the segments $\mathcal{I} = (F_{i_1}, \dots, F_{i_p})$ and $\mathcal{J} = (F_{j_1}, \dots, F_{j_q})$ of the belt \mathcal{B}_1 to obtain a new belt $(F_i, \mathcal{I}', F_j, \mathcal{J}')$ with \mathcal{I}' not intersecting F_k . First substitute the thick path Π_a for each segment $\mathcal{U}_a \subset \mathcal{I}$ and the thick path \mathcal{V}_b for each segment $\mathcal{S}_b \subset \mathcal{J}$. Since $F_{s_{a,t_a}} \cap F_{w_{a+1,1}} \neq \emptyset$, $F_{w_{a,r_a}} \cap F_{s_{a,1}} \neq \emptyset$, $F_{v_{a,c_a}} \cap F_{u_{a+1,1}} \neq \emptyset$, and $F_{u_{a,l_a}} \cap F_{v_{a,1}} \neq \emptyset$ for any a and $a + 1$ considered mod d , we obtain a loop $\mathcal{L}_1 = (F_i, \mathcal{I}_1, F_j, \mathcal{J}_1)$ instead of \mathcal{B}_1 .

Since $F_i \cap F_k = \emptyset$, we have $F_i = F_{s_{a_i, f_i}}$ for some a_i, f_i . If $F_j = F_{s_{a_j, f_j}}$ for some a_j, f_j , then we can assume that $a_i \neq a_j$, else the faces in \mathcal{I} or \mathcal{J} already do not intersect F_k , and \mathcal{B}_1 is a belt we need. If $F_j = F_{u_{a_j, f_j}}$ for some a_j and some $f_j > 1$, then substitute the thick path $(F_{w_{a_j,1}}, \dots, F_{w_{a_j, g_j}})$, where g_j – the first integer with $F_{w_{a_j, g_j}} \cap F_j \neq \emptyset$ (then $F_j \cap F_{u_{a_j, f_j-1}} \cap F_{w_{a_j, g_j}}$

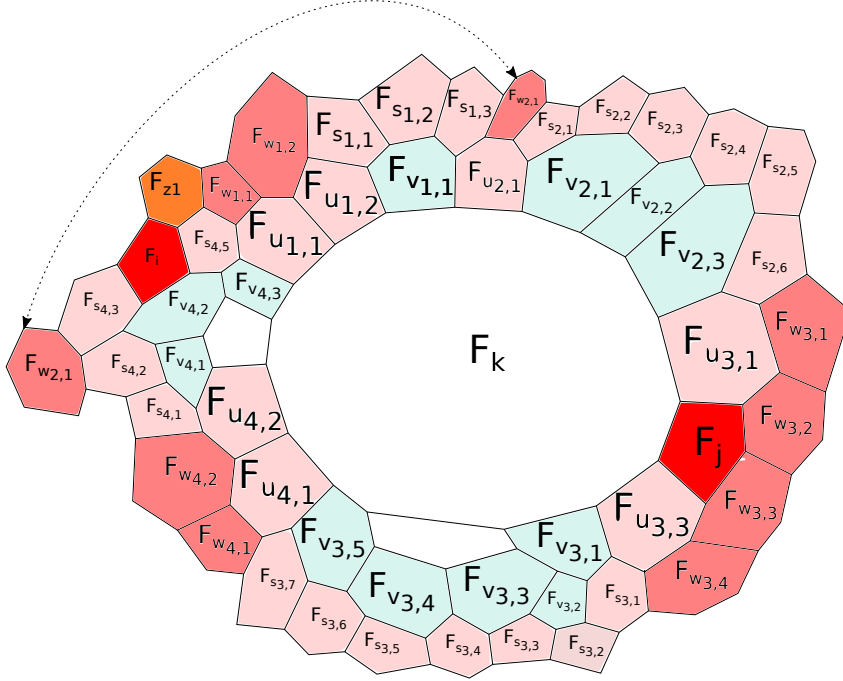

FIGURE 12. Case 2

is a vertex), for the segment $(F_{u_{a_j,1}}, \dots, F_{u_{a_j, f_j-1}})$ to obtain a loop $\mathcal{L}_2 = (F_i, \mathcal{I}_2, F_j, \mathcal{J}_1)$ (else set $\mathcal{I}_2 = \mathcal{I}_1$ and $\mathcal{L}_2 = \mathcal{L}_1$) with faces in \mathcal{I}_2 not intersecting F_k . If $1 < f_j < l_{a_j}$, then $F_{w_{a_j, g_j}} \cap F_{u_{a_j, f_j+1}} = \emptyset$, for otherwise $(F_k, F_{u_{a_j, f_j-1}}, F_{w_{a_j, g_j}}, F_{u_{a_j, f_j+1}})$ is a 4-belt around the quadrangle F_j . Then $F_{w_{a, l}} \cap F_{u_{a_j, r}} = \emptyset$ for any $r \in \{f_j + 1, \dots, l_{a_j}\}$ and a, l , such that either $a \neq a_j$, or $a = a_j$, and $l \in \{1, \dots, g_j\}$. Hence faces of the segment $(F_{u_{a_j, f_j+1}}, \dots, F_{u_{a_j, l_{a_j}}})$ do not intersect faces in \mathcal{I}_2 .

Now a face $F_{i'_a}$ of \mathcal{I}_2 can intersect a face $F_{j'_b}$ of \mathcal{J}_1 only if $F_{i'_a} = F_{w_{c, h}}$ for some c, h , and $F_{j'_b} = F_{s_{a_i, l}}$ for $l < f_i$, or $F_{j'_b} = F_{s_{a_j, l}}$ for $F_j = F_{s_{a_j, f_j}}$ and $l > f_j$. In the first case take the smallest l for all c, h , and the correspondent face $F_{w_{c, h}}$. Consider the face $F_{u_{b, g}} = F_{i_e} \in \mathcal{I}$ with $F_{u_{b, g}} \cap F_{w_{c, h}} \neq \emptyset$. Then $\mathcal{L}' = (F_{s_{a_i, l}}, F_{s_{a_i, l+1}}, \dots, F_i, F_{i_1}, \dots, F_{i_e}, F_{w_{c, h}})$ is a simple loop. If $f_i < t_{a_i}$, then consider the thick path $\mathcal{Z}_1 = (F_{z_{1,1}}, \dots, F_{z_{1, y_1}})$ arising while walking in $\overline{C_2}$ along ∂C_2 from the face $F_{z_{1,1}}$ intersecting $F_i \cap F_{i_1}$ by the vertex, to the face $F_{z_{1, y_1}}$ preceding $F_{w_{a_i+1, 1}}$. Consider the thick path $\mathcal{X}_1 = (F_{v_{a_i, 1}}, \dots, F_{v_{a_i, x_1}})$ with x_1 being the first integer with $F_{v_{a_i, x_1}} \cap F_i \neq \emptyset$. Consider the simple curve $\eta \subset \partial P$ consisting of segments connecting the midpoints of the successive edges of intersection of the successive faces of \mathcal{L}' . It divides ∂P into two connected components \mathcal{E}_1 and \mathcal{E}_2 with $\mathcal{J}_1 \setminus (F_{s_{a_i, l}}, \dots, F_{s_{a_i, f_i-1}})$ lying in one connected component, say \mathcal{E}_1 , and $\mathcal{Z}_1 -$ in $\mathcal{E}_2 \cup F_{w_{c, h}}$. Now substitute \mathcal{X}_1 for the segment $(F_{s_{a_i, 1}}, \dots, F_{s_{a_i, f_i-1}})$ of \mathcal{J}_1 . If $f_i < t_{a_i}$ substitute \mathcal{Z}_1 for the segment $(F_{s_{a_i, f_i+1}}, \dots, F_{s_{a_i, t_{a_i}}})$ of \mathcal{I}_2 to obtain a new loop $(F_i, \mathcal{I}_3, F_j, \mathcal{J}_2)$

with faces in \mathcal{I}_3 not intersecting F_k . A face $F_{i''_a}$ in \mathcal{I}_3 can intersect a face $F_{j''_b}$ in \mathcal{J}_2 only if $F_{i''_a} = F_{w_{c',h'}}$ for some c', h' , $F_j = F_{s_{a_j, f_j}}$, and $F_{j''_b} = F_{s_{a_j, l}}$ for $l > f_j$. The thick path \mathcal{Z}_1 lies in $\mathcal{E}_2 \cup F_{w_{c,h}}$ and the segment $(F_j = F_{s_{a_j, f_j}}, \dots, F_{s_{a_j, t_{a_j}}})$ lies in \mathcal{E}_1 ; hence intersections of faces in \mathcal{I}_3 with faces in \mathcal{J}_2 are also intersections of the same faces in \mathcal{I}_2 and \mathcal{J}_1 , and $F_{w_{c',h'}}$ is either $F_{w_{c,h}}$, or lies in \mathcal{E}_1 . We can apply the same argument for \mathcal{S}_{a_j} as for \mathcal{S}_{a_i} to obtain a new loop $\mathcal{L}_4 = (F_i, \mathcal{I}_4, F_j, \mathcal{J}_3)$ with faces in \mathcal{I}_4 not intersecting F_k and faces in \mathcal{J}_3 . Then take the shortest thick path from F_i to F_j in $F_i \cup \mathcal{I}_4 \cup F_j$ and the shortest thick path from F_j to F_i in $F_j \cup \mathcal{J}_3 \cup F_i$ to obtain a belt we need.

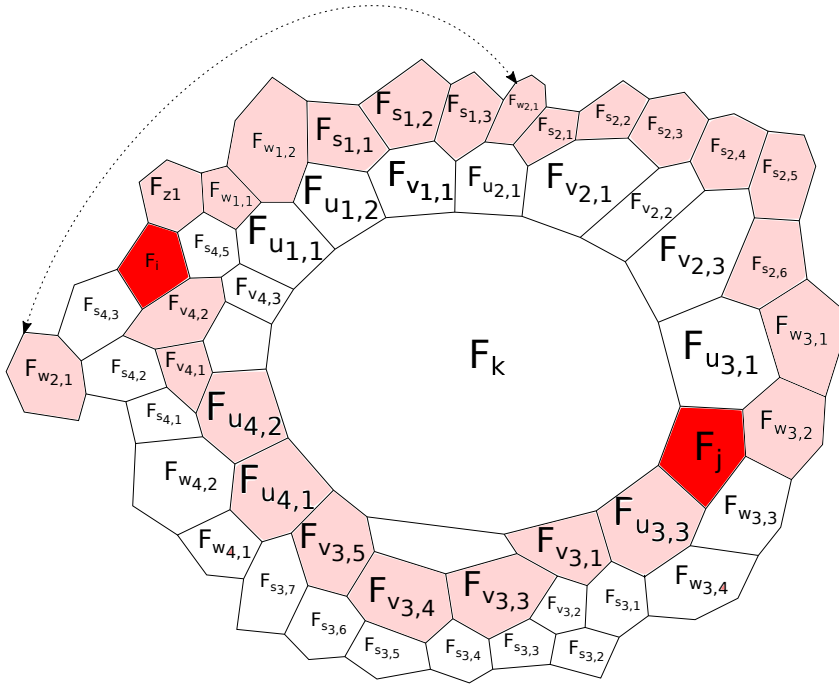

FIGURE 13. Modified belt

□

Denote by P_8 a polytope obtained from the cube by cutting off two disjoint nonadjacent orthogonal edges (Fig. 14). It is easy to see, that the polytope P_8 is flag.

Remark 4. It is not difficult to show that there are only two flag 3-polytopes with $m = 8$: the polytope P_8 , and the hexagonal prism $M_6 \times I$. Moreover, P_8 has five 4-belts (four trivial and one nontrivial), and $M_6 \times I$ has nine 4-belts (six trivial and three nontrivial). Hence, both of them are B -rigid.

Proposition 5.3. *A flag polytope P is an almost Pogorelov polytope or the polytope P_8 if and only if it satisfies the condition of Lemma 5.2.*

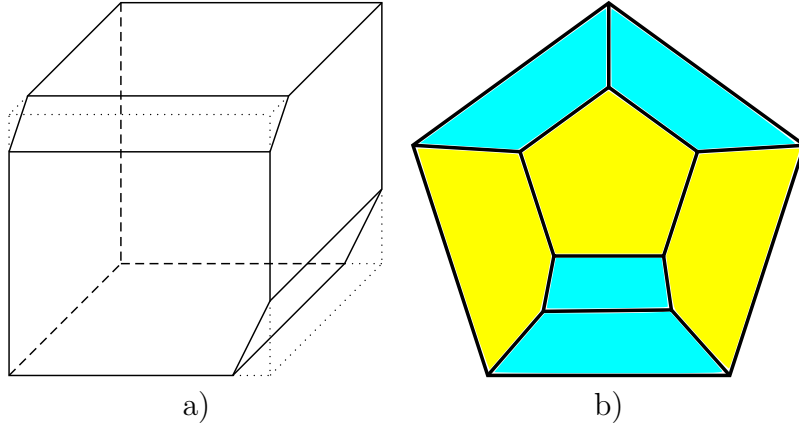
FIGURE 14. a) A polytope P_8 ; b) its Schlegel diagram

Proof. Indeed, let a flag polytope P satisfy the condition of Lemma 5.2. Assume that P has a nontrivial 4-belt $\mathcal{B}_4 = (F_s, F_t, F_u, F_v)$. If F_s is not adjacent to some faces $F_i \in \overline{C_1}$ and $F_j \in \overline{C_2}$, where C_1 and C_2 are the connected components of $\partial P \setminus |\mathcal{B}_4|$, then we can take $F_k = F_s$. Any belt \mathcal{B} containing F_i and F_j and not containing F_k should pass through F_t and F_v , in particular, each component of $|\mathcal{B}| \setminus (F_i \cup F_j)$ intersects F_k . A contradiction. Thus, any face of \mathcal{B}_4 should be adjacent to all the faces either in $\overline{C_1}$, or in $\overline{C_2}$. Without loss of generality assume that F_s is adjacent to all the faces in $\overline{C_1}$. Then $\overline{C_1}$ consists of the faces F_{i_1}, \dots, F_{i_p} , where $(F_t, F_{i_1}, \dots, F_{i_p}, F_v)$ is a part of the belt around F_s . We have $p \geq 2$, since \mathcal{B}_4 is a nontrivial belt. In particular, F_v does not intersect $F_{i_1}, \dots, F_{i_{p-1}}$, and F_t does not intersect F_{i_2}, \dots, F_{i_p} . Then F_t and F_v are adjacent to all the faces in $\overline{C_2}$, and F_u – in $\overline{C_1}$. Since P is flag, $F_t \cap F_{i_1} \cap F_u$, $F_{i_1} \cap F_{i_2} \cap F_u, \dots, F_{i_{p-1}} \cap F_{i_p} \cap F_u, F_{i_p} \cap F_v \cap F_u$ are vertices. Then all the faces F_{i_1}, \dots, F_{i_p} are quadrangles. The same argument works for $\overline{C_2}$. Then P has the structure drawn on Fig. 15. Let $p \geq 3$. Consider the faces $F_i = F_{i_1}$, $F_j = F_{j_1}$, and $F_k = F_{i_3}$. Any belt \mathcal{B} containing F_{i_1} contains either the part (F_v, F_{i_1}, F_{i_2}) , or (F_s, F_{i_1}, F_u) . In the first case this belt also should contain $F_k = F_{i_3}$. In the second case it intersects $F_k = F_{i_3}$ by both connected components of $|\mathcal{B}| \setminus (F_i \cup F_j)$. A contradiction. Hence, $p = 2$. For the same reason $q = 2$. Thus, $P = P_8$.

At last, let us prove that P_8 satisfies the condition of Lemma 5.2. Its group of combinatorial symmetries acts transitively on quadrangles and pentagons. Denote by \mathcal{B} the 4-belt of pentagons, and by C_1 and C_2 connected components of its complement in ∂P . Each component $\overline{C_1}$ and $\overline{C_2}$ consists of two quadrangles.

If F_i is a quadrangle adjacent to F_k , then any l -belt \mathcal{B}_l containing F_i and not containing F_k in the closure of each connected component of $|\mathcal{B}_l| \setminus (F_i \cup F_j)$ contains a face from the 4-belt around F_i adjacent to F_k . Hence, F_k intersects both connected components.

Now let F_k do not intersect quadrangles among the faces F_i and F_j .

If F_k is a quadrangle in $\overline{C_1}$, then at least one of the faces F_i and F_j , say F_i , should be a pentagon. Since $F_i \cap F_j = \emptyset$, F_j is either the pentagon opposite to F_i in \mathcal{B} , or a quadrangle

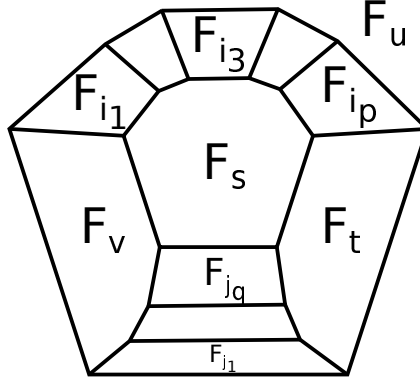

FIGURE 15. A polytope P assumed to satisfy the condition of Lemma 5.2

in $\overline{C_2}$. In the first case, if F_i intersects both quadrangles in $\overline{C_1}$, then \mathcal{B} is a belt we need. If F_i intersects only one quadrangle in $\overline{C_1}$, then the belt around a quadrangle in $\overline{C_2}$ is a belt we need. In the second case F_i is adjacent to both quadrangles in $\overline{C_1}$ and the belt around the quadrangle in $\overline{C_2}$ different from F_j is a belt we need.

If F_k is a pentagon, then it is adjacent to three of four quadrangles of P . If both faces F_i and F_j are pentagons, then they are both adjacent to F_k , and the belt around the fourth quadrangle is a belt we need. If F_i is the fourth quadrangle, then it is adjacent to all the pentagons different from F_k . Then F_j is a quadrangle, and F_i and F_j lie in different components $\overline{C_1}$ and $\overline{C_2}$. Then F_j is a quadrangle adjacent to F_k , which is a contradiction. This finishes the proof. \square

Remark 5. Thus, we have a characterization of the families of flag, almost Pogorelov and Pogorelov polytopes in terms of the existence of the belt that passes through F_i and F_j , where $F_i \cap F_j = \emptyset$, and does not pass through F_k . It should be mentioned, that there are other characterizations of these families in terms of belts. Namely, a simple 3-polytope is flag if and only if any its face is surrounded by a belt [BE17I, BEMPP17]. It is almost Pogorelov or the polytope P_8 if and only if in addition the loop around any trivial belt is simple [E19]. A simple 3-polytope is Pogorelov if and only if any pair of adjacent faces is surrounded by a belt [BE17I, BEMPP17]. Moreover, a simple 3-polytope is strongly Pogorelov if and only if any its face is surrounded by two belts [B1913].

6. GENERALIZATION OF THE ANNIHILATOR LEMMA

In this section we generalise another crucial tool from [FMW15] – the annihilator lemma.

Lemma 6.1. *Let P be a simple 3-polytope and $\alpha \in H$*

$$\alpha = \sum_{\omega \in N_2(P)} r_\omega \tilde{\omega} \quad \text{with } |\{\omega : r_\omega \neq 0\}| \geq 2.$$

Then for any $\omega = \{p, q\}$ with $r_\omega \neq 0$ we have

- (1) $\dim \text{Ann}_H(\alpha) \leq \dim \text{Ann}_H(\tilde{\omega})$;
- (2) $\dim \text{Ann}_H(\alpha) < \dim \text{Ann}_H(\tilde{\omega})$, if there is $\omega' = \{s, t\}$ with $r_{\omega'} \neq \emptyset$ admitting an l -belt \mathcal{B}_l containing F_s and F_t such that either F_p or F_q does not belong to \mathcal{B}_l and does not intersect at least one of the two connected components of $|\mathcal{B}_l| \setminus (F_s \cup F_t)$.

Proof. Choose a complementary subspace C_ω to $\text{Ann}_H(\tilde{\omega})$ in H as a direct sum of complements $C_{\omega, \tau}$ to $\text{Ann}_H(\tilde{\omega}) \cap \widehat{H}_*(P_\tau, \partial P_\tau, \mathbb{Q})$ in $\widehat{H}_*(P_\tau, \partial P_\tau, \mathbb{Q})$ for all $\tau \subset [m] \setminus \omega$. Then for any $\beta \in C_\omega \setminus \{0\}$ we have $\beta \tilde{\omega} \neq 0$, which is equivalent to the fact that $\beta = \sum \beta_\tau$, $\beta_\tau \in C_{\omega, \tau}$, $\tau \subset [m] \setminus \omega$, with $\beta_{\tau_\beta} \tilde{\omega} \neq 0$ for some $\tau_\beta \subset [m] \setminus \omega$. Moreover for any $\omega' \neq \omega$ with $r_{\omega'} \neq 0$ and $\tau \subset [m] \setminus \omega$, $\tau \neq \tau_\beta$, we have $\tau_\beta \sqcup \omega \notin \{\tau \cup \omega', \tau_\beta \cup \omega', \tau \sqcup \omega\}$; hence $(\beta \cdot \alpha)_{\tau_\beta \sqcup \omega} = r_\omega \beta_{\tau_\beta} \cdot \tilde{\omega} \neq 0$, and $\beta \alpha \neq 0$. Then C_ω forms a direct sum with $\text{Ann}(\alpha)$, and $\dim \text{Ann}_H(\alpha) \leq \dim \text{Ann}_H(\tilde{\omega})$.

Now consider some $\omega' \neq \omega$, $|\omega'| = 2$, $r_{\omega'} \neq 0$, satisfying additional condition of the lemma say for F_q . Then there is an l -belt \mathcal{B}_l such that $F_s, F_t \in \mathcal{B}_l$, $F_q \notin \mathcal{B}_l$, and F_q does not intersect one of the two connected components B_1 and B_2 of $|\mathcal{B}_l| \setminus (F_s \cup F_t)$, say B_1 . Take $\xi = [\sum_{i: F_i \subset B_1} F_i] \in \widehat{H}_2(P_\tau, \partial P_\tau, \mathbb{Q})$, $\tau = \{i: F_i \in \mathcal{B}_l \setminus \{F_s, F_t\}\}$, and $[F_s] \in \widehat{H}_2(P_{\omega'}, \partial P_{\omega'}, \mathbb{Q})$. Then $\xi \cdot [F_s]$ is a generator in $H_1(\mathcal{B}_l, \partial \mathcal{B}_l, \mathbb{Q}) \simeq \mathbb{Q}$. On the other hand, take $[F_q] \in \widehat{H}_2(P_\omega, \partial P_\omega, \mathbb{Q})$. Then either $F_p \in \mathcal{B}_l \setminus \{F_s, F_t\}$, and $\xi \cdot \tilde{\omega} = 0$, since $\tau \cap \omega \neq \emptyset$, or $F_p \notin \mathcal{B}_l \setminus \{F_s, F_t\}$, and $\pm \xi \cdot \tilde{\omega} = \xi \cdot [F_q] = 0$, since F_q does not intersect B_1 . In both cases $\xi \in \text{Ann}(\tilde{\omega})$ and $\xi \cdot \tilde{\omega}' \neq 0$. Then $\xi \cdot \alpha \neq 0$, since $\tau \sqcup \omega' \neq \tau \sqcup \omega_1$ for $\omega_1 \neq \omega'$. Consider any $\beta = \sum_{\tau \subset [m] \setminus \omega} \beta_\tau \in C_\omega \setminus \{0\}$. We have $(\beta \cdot \alpha)_{\tau_\beta \sqcup \omega} \neq 0$. If $(\xi \cdot \alpha)_{\tau_\beta \sqcup \omega} \neq 0$, then since ξ is a homogeneous element, $(\xi \cdot \alpha)_{\tau_\beta \sqcup \omega} = r_{\omega_1} \xi \cdot \tilde{\omega}_1$ for $\omega_1 = (\tau_\beta \sqcup \omega) \setminus \tau = \{q, r\}$, $r \in [m]$. We have $\xi \cdot \tilde{\omega}_1 = \pm \xi \cdot [F_q] = 0$, since F_q does not intersect B_1 . A contradiction. Thus, $((\xi + \beta) \cdot \alpha)_{\tau_\beta \sqcup \omega} = (\beta \cdot \alpha)_{\tau_\beta \sqcup \omega} \neq 0$; hence $(\xi + \beta) \cdot \alpha \neq 0$, and the space $\langle \xi \rangle \oplus C_\omega$ forms a direct sum with $\text{Ann}_H(\alpha)$. This finishes the proof. \square

Remark 6. In Proposition 8.3 we show that for the 3-dimensional associahedron, which is the simplest almost Pogorelov polytope without adjacent quadrangles, there is an example when $\dim \text{Ann}_H(\alpha) = \dim \text{Ann}_H(\tilde{\omega})$.

Corollary 6.2. *Ley P be a simple 3-polytope, and $\omega \in N_2(P)$ such that*

$$\dim \text{Ann}_H(\alpha) < \dim \text{Ann}_H(\tilde{\omega})$$

for any $\alpha = \lambda_\omega \omega + \sum_{\omega' \in N_2(P) \setminus \{\omega\}} \lambda_{\omega'} \tilde{\omega}'$ with $\lambda_\omega \neq 0$ and $\lambda_{\omega'} \neq 0$ at least for one ω' , then for any isomorphism of graded rings $\varphi: H^*(\mathcal{Z}_P) \rightarrow H^*(\mathcal{Z}_Q)$ for a simple 3-polytope Q we have $\varphi(\tilde{\omega}) = \pm \tilde{\omega}'$ for some $\omega' \in N_2(Q)$.

Proof. Indeed, we have

$$\varphi(\tilde{\omega}) = \sum_{\omega'' \in N_2(Q)} \lambda_{\omega''} \tilde{\omega}''.$$

Then at least for one ω'' with $\lambda_{\omega''} \neq 0$ we have

$$\varphi^{-1}(\omega'') = \mu_\omega \tilde{\omega} + \sum_{\omega' \in N_2(P) \setminus \{\omega\}} \mu_{\omega'} \tilde{\omega}' \text{ with } \mu_\omega \neq 0.$$

If $\mu_{\omega'} \neq 0$, then by Lemma 6.1 we have in cohomology over \mathbb{Q} :

$$\dim \text{Ann}_{H(P)}(\tilde{\omega}) > \dim \text{Ann}_{H(P)}(\varphi^{-1}(\tilde{\omega}'')) = \dim \text{Ann}_{H(Q)}(\tilde{\omega}'') \geq \dim \text{Ann}_{H(Q)}(\varphi(\tilde{\omega})).$$

A contradiction. Hence $\mu_{\omega'} = 0$ for all ω' , and $\varphi(\tilde{\omega}) = \pm \tilde{\omega}''$. \square

Definition 6.3. Let P be a simple 3-polytope. We will call an element $\omega' = \{s, t\} \in N_2(P)$ *good* for an element $\omega = \{p, q\} \in N_2(P)$, if there is an l -belt \mathcal{B}_l containing F_s and F_t such that either F_p or F_q does not belong to \mathcal{B}_l and does not intersect at least one of the two connected components of $\mathcal{B}_l \setminus \{F_s, F_t\}$. Otherwise, we call ω' *bad* for ω .

Corollary 6.4. *Let P be a simple 3-polytope. If any $\omega' \in N_2(P) \setminus \{\omega\}$ is good for an element $\omega \in N_2(P)$, then for any isomorphism of graded rings $\varphi: H^*(\mathcal{Z}_P) \rightarrow H^*(\mathcal{Z}_Q)$ for a simple 3-polytope Q we have $\varphi(\tilde{\omega}) = \pm \tilde{\omega}'$ for some $\omega' \in N_2(Q)$.*

Corollary 6.5. *Let P be a simple 3-polytope and $\omega \in N_2(P)$. Then for any isomorphism of graded rings $\varphi: H^*(\mathcal{Z}_P) \rightarrow H^*(\mathcal{Z}_Q)$ for a simple 3-polytope Q we have $\varphi(\tilde{\omega}) = \sum_{\omega'' \in N_2(Q)} \lambda_{\omega''} \tilde{\omega}''$,*

where there is $\omega'' \in N_2(Q)$ such that $\lambda_{\omega''} \neq 0$ and all the other elements in $N_2(Q)$ with nonzero coefficients are bad for ω'' . Moreover, this is valid for any $\omega'' \in N_2(Q)$ such that $\lambda_{\omega''} \neq 0$ and $\varphi^{-1}(\tilde{\omega}'')$ has a nonzero coefficient at $\tilde{\omega}$.

Proof. Indeed, let

$$\varphi(\tilde{\omega}) = \sum_{\omega'' \in N_2(Q)} \lambda_{\omega''} \tilde{\omega}''.$$

Then at least for one ω'' with $\lambda_{\omega''} \neq 0$ we have

$$\varphi^{-1}(\tilde{\omega}'') = \mu_{\omega} \tilde{\omega} + \sum_{\omega' \in N_2(P) \setminus \{\omega\}} \mu_{\omega'} \tilde{\omega}' \text{ with } \mu_{\omega} \neq 0.$$

If $\lambda_{\omega''} \neq 0$, and ω'' is good for ω'' , then by Lemma 6.1 we have in cohomology over \mathbb{Q} :

$$\dim \text{Ann}_{H(P)}(\tilde{\omega}) \geq \dim \text{Ann}_{H(P)}(\varphi^{-1}(\tilde{\omega}'')) = \dim \text{Ann}_{H(Q)}(\tilde{\omega}'') > \dim \text{Ann}_{H(Q)}(\varphi(\tilde{\omega})).$$

A contradiction. Hence $\lambda_{\omega''} = 0$ for all elements $\omega'' \in N_2(Q)$, which are good for ω'' . Moreover, by a similar argument, $\mu_{\omega'} = 0$ for all elements, which are good for ω . \square

Corollary 6.6. *Let P be an almost Pogorelov polytope different from the cube and the pentagonal prism, and $\omega = \{p, q\} \in N_2(P)$. Then an element $\omega' = \{s, t\} \in N_2(P) \setminus \{\omega\}$ is bad for ω if and only if at least one of the faces F_s and F_t is a quadrangle, and either F_p and F_q are opposite faces of the 4-belt around this face, or exactly one of the faces F_p and F_q belongs to this belt, and the other face among F_s and F_t is either the other face among F_p and F_q , or is a quadrangle adjacent to it. In particular,*

- (1) *If F_p and F_q are not adjacent to quadrangles, then any element $\omega' \in N_2(P) \setminus \{\omega\}$ is good for ω . In particular, this is valid, if both F_p and F_q are quadrangles.*
- (2) *If F_p is a quadrangle and F_q is adjacent to quadrangles, then $\omega' \in N_2(P) \setminus \{\omega\}$ is bad for ω if and only if $\omega' = \{p, r\}$, where F_r is a quadrangle adjacent to F_q .*

- (3) If each of the faces F_p and F_q is adjacent to quadrangles, and F_p and F_q do not belong to any 4-belt, then $\omega' = \{s, t\} \in N_2(P) \setminus \{\omega\}$ is bad for ω if and only if either one of the faces F_s and F_t is F_p or F_q and the other face is a quadrangle adjacent to the other face, or both F_s and F_t are quadrangles, and one of them is adjacent to exactly F_p , and the other – to exactly F_q .
- (4) If the faces F_p and F_q belong to a 4-belt around the face F_r , then $\omega' = \{s, t\} \in N_2(P) \setminus \{\omega\}$ is bad for ω if and only if either $\omega' = \{r, s\}$, or one of the faces F_s and F_t is F_p or F_q and the other face is a quadrangle adjacent to the other face, or both F_s and F_t are quadrangles, and one of them is adjacent to exactly F_p , and the other – to exactly F_q .

Proof. Without loss of generality assume that $q \notin \omega'$. If ω' is bad for ω , then by Lemma 5.2 one of the faces F_s and F_t , say F_s , is a quadrangle adjacent to F_q . Then $F_p \neq F_s$. If $F_p \neq F_t$, then either F_p is adjacent to F_s , or F_t is a quadrangle adjacent to F_p .

On the other hand, let F_s be a quadrangle adjacent to F_q . Then $F_p \neq F_s$. If either $F_p = F_t$, or $F_p \neq F_t$ and F_p is adjacent to F_s , or F_t is a quadrangle adjacent to F_p , then ω' is bad for ω . \square

Corollary 6.7. *Let P be an almost Pogorelov polytope different from the cube and the pentagonal prism, and $\omega = \{p, q\} \in N_2(P)$ such that F_p and F_q are not adjacent to quadrangles. Then for any isomorphism of graded rings $\varphi: H^*(\mathcal{Z}_P) \rightarrow H^*(\mathcal{Z}_Q)$ for a simple 3-polytope Q we have $\varphi(\tilde{\omega}) = \pm \tilde{\omega}'$ for some $\omega' \in N_2(Q)$*

Proof. This follows directly from Corollary 6.4. \square

Corollary 6.8. *Let P be an almost Pogorelov polytope different from the cube and the pentagonal prism, and \mathcal{B}_k be a k -belt such that the set $|\mathcal{B}_k|$ does not have common points with quadrangles. Then for any isomorphism of graded rings $\varphi: H^*(\mathcal{Z}_P) \rightarrow H^*(\mathcal{Z}_Q)$ for a simple 3-polytope Q we have $\varphi(\tilde{\mathcal{B}}_k) = \pm \tilde{\mathcal{B}}'_k$ for some k -belt \mathcal{B}' of Q .*

Proof. We know from Section 2 that $\varphi(\tilde{\mathcal{B}}_k) = \sum_j \mu_j \tilde{\mathcal{B}}'_{k,j}$ for k -belts $\mathcal{B}'_{k,j}$ of Q .

Lemma 6.9. *Let P be a simple 3-polytope and $\omega = \{p, q\} \in N_2(P)$. Then an element*

$$x = \sum_{\eta} \alpha_{\eta} + \sum_{\tau} \beta_{\tau} \in \bigoplus_{\eta} \tilde{H}^0(P_{\eta}) \bigoplus_{\tau} \tilde{H}^1(P_{\tau})$$

is divisible by $\tilde{\omega}$ if and only if $\alpha_{\eta} = 0$ for all η , and each nonzero β_{τ} is divisible by $\tilde{\omega}$ (in particular, $\omega \subset \tau$ and $\tilde{H}^0(P_{\tau \setminus \omega}) \neq 0$).

Proof. If x is divisible by $\tilde{\omega}$, then $x = \tilde{\omega} \sum_{\zeta} \xi_{\zeta}$ for $\xi_{\zeta} \in \tilde{H}^0(P_{\zeta})$. Then $x = \sum_{\omega \cap \zeta = \emptyset} \tilde{\omega} \xi_{\zeta}$, where

$\tilde{\omega} \xi_{\zeta} \in \tilde{H}^1(P_{\omega \sqcup \zeta})$, and $\omega \sqcup \zeta \neq \omega \sqcup \zeta'$ for $\zeta \neq \zeta'$. Thus, each nonzero summand β_{τ} has the form $\tilde{\omega} \xi_{\zeta}$, in particular, $\omega \subset \tau$, and $\tilde{H}^0(P_{\tau \setminus \omega}) = \tilde{H}^0(P_{\zeta}) \neq 0$. \square

Corollary 6.10. *Let P be a simple 3-polytope and $\omega = \{p, q\} \in N_2(P)$. Then an element $x = \sum_j \mu_j \tilde{\mathcal{B}}_{k,j} \in \mathcal{B}_k$ is divisible by $\tilde{\omega}$ if and only if each $\tilde{\mathcal{B}}_{k,j}$ with $\mu_j \neq 0$ is divisible by $\tilde{\omega}$, and if and only if each belt $\mathcal{B}_{k,j}$ with $\mu_j \neq 0$ contains F_p and F_q .*

Proof. This follows directly from Lemma 6.9, since the element $\widetilde{\mathcal{B}}_{k,j}$ is divisible by $\widetilde{\omega}$ if and only if $\omega \subset \omega(\mathcal{B}_{k,j})$, that is $\mathcal{B}_{k,j}$ contains F_p and F_q . \square

Take any $\omega = \{p, q\} \in N_2(P)$, $\omega \subset \omega(\mathcal{B}_k)$. Since both faces F_p and F_q do not intersect quadrangles, Corollary 6.7 implies that $\varphi(\widetilde{\omega}) = \pm\widetilde{\omega}'$ for some $\omega' \in N_2(Q)$. Then $\omega' \subset \omega(\mathcal{B}'_{k,j})$ for each $\mu_j \neq 0$. Thus, the isomorphism φ maps the set $\{\pm\widetilde{\omega} : \omega \subset \omega(\mathcal{B}_k)\}$ bijectively to the corresponding set of any $\mathcal{B}'_{k,j}$ with $\mu_j \neq 0$. But such a set defines uniquely the k -belt; hence we have only one nonzero μ_j , which should be equal to ± 1 . This finishes the proof. \square

7. B-RIGID SUBSETS FOR ALMOST POGORELOV POLYTOPES

In this section we study B -rigid subsets for almost Pogorelov polytopes.

Lemma 7.1. *The set of subgroups $G(\mathcal{B}_4) \subset \mathbf{H}_3$ of rank 2 generated by elements $[\widetilde{\omega}] = \widetilde{\omega} + A_3$ and $[\widetilde{\omega}'] = \widetilde{\omega}' + A_3$, where $\omega \sqcup \omega' = \omega(\mathcal{B}_4)$ is B -rigid in the class of flag 3-polytopes with $2 \operatorname{rk} \mathcal{B}_4 = \operatorname{rk} \mathbf{H}_3$.*

Proof. The elements $\{[\widetilde{\omega}]\}$, where $\omega \in N_2(P)$ are subsets of $\omega(\mathcal{B}_4)$ for 4-belts, form a basis in \mathbf{H}_3 . Take an element

$$\alpha = \lambda_1[\widetilde{\omega}_1] + \lambda'_1[\widetilde{\omega}'_1] + \cdots + \lambda_k[\widetilde{\omega}_k] + \lambda'_k[\widetilde{\omega}'_k],$$

where $\mathcal{B}_{4,1}, \dots, \mathcal{B}_{4,k}$ are all 4-belts, and $\omega_i \sqcup \omega'_i = \omega(\mathcal{B}_{4,i})$. We have $[\widetilde{\omega}_i] \cdot [\widetilde{\omega}'_i] = \widetilde{\mathcal{B}}_{4,i}$.

As mentioned above we have an embedding $H^*(\mathcal{Z}_P) \subset H^*(\mathcal{Z}_P) \otimes \mathbb{Q} = H^*(\mathcal{Z}_P, \mathbb{Q})$. Images of these subgroups are 2-dimensional linear subspaces in $\mathbf{H}_3 \otimes \mathbb{Q}$. For the element $\alpha \in \mathbf{H}_3 \otimes \mathbb{Q}$ define a linear subspace

$$A(\alpha) = \{\beta \in \mathbf{H}_3 \otimes \mathbb{Q} : \alpha \cdot \beta = 0\}$$

We have

$$\beta = \mu_1[\widetilde{\omega}_1] + \mu'_1[\widetilde{\omega}'_1] + \cdots + \mu_k[\widetilde{\omega}_k] + \mu'_k[\widetilde{\omega}'_k],$$

and

$$\alpha \cdot \beta = \sum_{i=1}^k (\lambda_i \mu'_i - \lambda'_i \mu_i) \widetilde{\mathcal{B}}_{4,i}.$$

Then $\beta \in A(\alpha)$ if and only if $\lambda_i \mu'_i - \lambda'_i \mu_i = 0$ for all $i = 1, \dots, k$. Thus, $\dim A(\alpha) = \dim \mathbf{H}_3 \otimes \mathbb{Q} - l$, where l is the number of i with $(\lambda_i, \lambda'_i) \neq (0, 0)$. Hence, maximal dimension is for $\alpha \in \langle [\widetilde{\omega}_i], [\widetilde{\omega}'_i] \rangle$ for some i . Therefore, the collection of these subspaces is B -rigid over \mathbb{Q} , and the collection of the corresponding subgroups is B -rigid. \square

Corollary 7.2. *The set of elements*

$$\{\pm \widetilde{\mathcal{B}}_4 : \mathcal{B}_4 \text{ is a 4-belt}\} \subset H^6(\mathcal{Z}_P)$$

is B -rigid in the class of flag 3-polytopes with $2 \operatorname{rk} \mathcal{B}_4 = \operatorname{rk} \mathbf{H}_3$.

Proof. Indeed, $\widetilde{\mathcal{B}}_{4,i}$ is a generator of the image of the bilinear mapping

$$\langle [\widetilde{\omega}_i], [\widetilde{\omega}'_i] \rangle \times \langle [\widetilde{\omega}_i], [\widetilde{\omega}'_i] \rangle \rightarrow H^6(\mathcal{Z}_P).$$

□

Corollary 7.3. *Let $P, Q \in \mathcal{P}_{aPog} \setminus \{I^3, M_5 \times I\}$. Then any isomorphism of graded rings $\varphi: H^*(\mathcal{Z}_P) \rightarrow H^*(\mathcal{Z}_Q)$ induces a bijection φ_4 between the sets of quadrangles of P and Q by the rule*

$$\varphi_4(F_i) = F'_{i'}, \text{ where } \varphi(\widetilde{\mathcal{B}}_i) = \pm \widetilde{\mathcal{B}}'_{i'}, \text{ for 4-belts } \mathcal{B}_i \text{ and } \mathcal{B}'_{i'} \text{ around } F_i \text{ and } F'_{i'}.$$

Proof. Indeed, any 4-belt around a quadrangle does not surround a quadrangle on the other side, for otherwise $P = I^3$. □

Notation 7.4. In what follows we will use notations from Corollary 7.3, namely φ_4 for the isomorphism between the sets of quadrangles of polytopes $P, Q \in \mathcal{P}_{aPog} \setminus \{I^3, M_5 \times I\}$ induced by an isomorphism of graded rings $\varphi: H^*(\mathcal{Z}_P) \rightarrow H^*(\mathcal{Z}_Q)$, and \mathcal{B}_i and $\mathcal{B}'_{i'}$ for the 4-belts around quadrangles F_i and $F'_{i'}$ such that $\varphi_4(F_i) = F'_{i'}$.

Lemma 7.5. *The set of elements:*

$$\{\pm[\widetilde{\omega}]: \omega \in N_2(P), \omega \subset \omega(\mathcal{B}_4) \text{ for some 4-belt } \mathcal{B}_4\} \subset \mathbf{H}_3$$

is B-rigid in the class of flag 3-polytopes with $2 \operatorname{rk} \mathbf{B}_4 = \operatorname{rk} \mathbf{H}_3$.

Proof. Consider the 4-belt $\mathcal{B}_{4,i}$ corresponding to the pair $\omega_i, \omega'_i \in N_2(P)$. Let $\omega_i = \{p, q\}$, $\omega'_i = \{s, t\}$. Consider the belt \mathcal{B}_l around the face F_p . It contains both F_s and F_t . Let B_1 and B_2 be the connected components of $\mathcal{B}_l \setminus \{F_s, F_t\}$. They lie in different connected components of $\partial P \setminus \{\mathcal{B}_{4,i}\}$. Let F_q intersect some face $F_a \in B_1$ and some face $F_b \in B_2$. Then (F_p, F_a, F_q, F_b) is a 4-belt. It is different from $\mathcal{B}_{4,i}$ and contains F_p and F_q . A contradiction to Lemma 3.1.

Now let $\varphi: H^*(\mathcal{Z}_P) \rightarrow H^*(\mathcal{Z}_Q)$ be an isomorphism of graded rings for flag polytopes P and Q with $2 \operatorname{rk} \mathbf{B}_4 = \operatorname{rk} \mathbf{H}_3$. By Lemma 7.1

$$\varphi(\widetilde{\omega}_i) = \lambda_j \widetilde{\omega}_j + \lambda'_j \widetilde{\omega}'_j + \sum_{\widetilde{\omega} \in A_3(Q)} \mu_\omega \widetilde{\omega}$$

for some $j \in \{1, \dots, k\}$. Since $\varphi^{-1}(A_3(Q)) \subset A_3(P)$, for at least one of the elements $\widetilde{\omega}_j$ and $\widetilde{\omega}'_j$ with nonzero coefficient, say for $\widetilde{\omega}_j$, its preimage contains $\widetilde{\omega}_i$ with a nonzero coefficient:

$$\varphi^{-1}(\widetilde{\omega}_j) = \tau_i \widetilde{\omega}_i + \tau'_i \widetilde{\omega}'_i + \sum_{\widetilde{\omega} \in A_3(P)} \eta_\omega \widetilde{\omega}, \quad \tau_i \neq 0.$$

If $\tau'_i \neq 0$, then by Lemma 6.1 we have in cohomology over \mathbb{Q} :

$$\dim \operatorname{Ann}_{H(P)}(\widetilde{\omega}_i) > \dim \operatorname{Ann}_{H(P)}(\varphi^{-1}(\widetilde{\omega}_j)) = \dim \operatorname{Ann}_{H(Q)}(\widetilde{\omega}_j) \geq \dim \operatorname{Ann}_{H(Q)}(\varphi(\widetilde{\omega}_i)).$$

A contradiction. Hence $\tau'_i = 0$ and for the mapping $\widehat{\varphi}: \mathbf{H}_3(P) \rightarrow \mathbf{H}_3(Q)$ we have: $\widehat{\varphi}^{-1}([\widetilde{\omega}_j]) = \tau_i [\widetilde{\omega}_i]$. Then $\tau_i = \pm 1$ and $\widehat{\varphi}([\widetilde{\omega}_i]) = \pm [\widetilde{\omega}_j]$. This finishes the proof. □

Lemma 7.6. *The sets of elements:*

$$\{\pm[\tilde{\omega}]: \omega \in N_2(P), \omega \subset \omega(\mathcal{B}_4) \text{ for a trivial 4-belt } \mathcal{B}_4\} \subset \mathbf{H}_3$$

and

$$\{\pm\widetilde{\mathcal{B}}_4: \mathcal{B}_4 \text{ is a trivial 4-belt}\} \subset H^6(\mathcal{Z}_P)$$

are B -rigid in the class of flag 3-polytopes with $2 \operatorname{rk} \mathcal{B}_4 = \operatorname{rk} \mathbf{H}_3$.

Proof. Indeed, any generator of $\widetilde{H}^1(P_\omega) = \mathbb{Z}$ for P_ω from Fig. 8 a)-c) is divisible by exactly $\tilde{\omega}$ and $\tilde{\omega}'$ for the corresponding belt \mathcal{B}_4 with $\tilde{\omega} \cdot \tilde{\omega}' = \widetilde{\mathcal{B}}_4$ among all the elements in $H^3(\mathcal{Z}_P)$ corresponding to sets in $N_2(P)$. Therefore, the set $\omega \in N_2(P) \setminus N_2^0(P)$ corresponds to a trivial 4-belt if and only if the free abelian subgroup $[\tilde{\omega}] \cdot H^4(\mathcal{Z}_P) \subset \mathbf{I}_7$ has rank $(m-5)$, and the element $\widetilde{\mathcal{B}}_4$ corresponds to a trivial belt if and only if it is divisible by such an element $[\tilde{\omega}] \in \mathbf{H}_3$. \square

Corollary 7.7. *Let $P, Q \in \mathcal{P}_{\text{aPog}} \setminus \{I^3, M_5 \times I\}$, and let \mathcal{B}_k be a k -belt passing through a quadrangle F_i and its adjacent faces F_p and F_q . Then for any isomorphism of graded rings $\varphi: H^*(\mathcal{Z}_P) \rightarrow H^*(\mathcal{Z}_Q)$ we have*

$$\varphi(\widetilde{\mathcal{B}}_k) = \sum_j \mu_j \widetilde{\mathcal{B}}'_{k,j}$$

for k -belts $\mathcal{B}'_{k,j}$ of Q such that for any $\mu_j \neq 0$ the belt $\widetilde{\mathcal{B}}'_{k,j}$ passes through the nonadjacent faces F'_p and $F'_{q'}$ of Q , where $\varphi(\widetilde{\{p, q\}} + A_3(P)) = \pm \widetilde{\{p', q'\}} + A_3(Q)$. Moreover, F'_p and $F'_{q'}$ are adjacent to the quadrangle $F'_i = \varphi_4(F_i)$ of Q (see Notation 7.4).

Proof. We know from Section 2 that $\varphi(\widetilde{\mathcal{B}}_k) = \sum_j \mu_j \widetilde{\mathcal{B}}'_{k,j}$ for k -belts $\mathcal{B}'_{k,j}$ of Q .

Lemma 7.8. *Let $P \in \mathcal{P}_{\text{aPog}} \setminus \{I^3, M_5 \times I\}$, and let \mathcal{B}_k be a k -belt passing through a quadrangle F_i and its adjacent faces F_p and F_q . Let x be a generator of $\widetilde{H}^1(P_\tau) = \mathbb{Z}$ for $\tau = \omega(\mathcal{B}_k)$ (in this case $x = \pm \widetilde{\mathcal{B}}_k$), or $\tau = \omega(\mathcal{B}_k) \sqcup \{r\}$, where F_r either is not adjacent to faces in \mathcal{B}_k , or is adjacent to exactly one face in \mathcal{B}_k . Then x is divisible by any element in the coset $\widetilde{\{p, q\}} + A_3(P)$.*

Proof. Indeed, consider the set $P_{\tau \setminus \{p, q\}}$. One of its connected components is F_i , since F_i can not be adjacent to F_r (for otherwise, F_r is also adjacent to both F_p and F_q , which is a contradiction). Then for $[F_i] \in \widehat{H}_2(P_{\tau \setminus \{p, q\}}, \partial P_{\tau \setminus \{p, q\}})$ and $[F_p] \in \widehat{H}_2(P_{\{p, q\}}, \partial P_{\{p, q\}})$ we have $[F_i \cap F_p]$ is a generator of $H_1(P_\tau, \partial P_\tau) \simeq \widetilde{H}^1(P_\tau)$. On the other hand, for any $\{s, t\} \in N_2^0(P)$ at least one of the faces F_s and F_t does not belong to the belt around F_i , say F_s . Then either $F_s = F_i$, or $F_s \cap F_i = \emptyset$. Therefore $\xi \cdot \widetilde{\{s, t\}} = 0$, where ξ is the element in $H^*(\mathcal{Z}_P)$ corresponding to $[F_i] \in \widehat{H}_2(P_{\tau \setminus \{p, q\}}, \partial P_{\tau \setminus \{p, q\}})$. Thus, $\pm \xi \cdot (\widetilde{\{p, q\}} + \sum_{\omega \in N_2^0(P)} \lambda_\omega \tilde{\omega}) = x$. \square

Then $\varphi(\widetilde{\mathcal{B}}_k)$ is divisible by any element in the coset $\pm \widetilde{\{p', q'\}} + A_3(Q)$, in particular, by $\widetilde{\{p', q'\}}$. By Corollary 6.10 each belt $\mathcal{B}'_{k,j}$ passes through F'_p and $F'_{q'}$. The second part of the Corollary follows from the fact that $\widetilde{\mathcal{B}}'_i$ is also divisible by any element in the coset $\pm \widetilde{\{p', q'\}} + A_3(Q)$ and passes through F'_p and $F'_{q'}$. \square

Proposition 7.9. *Let $P, Q \in \mathcal{P}_{aPog} \setminus \{I^3, M_5 \times I\}$, and let F_p be a quadrangle of P not adjacent to a face F_q . Assume that for an isomorphism of graded rings $\varphi: H^*(\mathcal{Z}_P) \rightarrow H^*(\mathcal{Z}_Q)$ we have $\varphi(\widetilde{\{p, q\}}) = \pm \widetilde{\{s, t\}}$ for some $\{s, t\} \in N_2(Q)$. Then $p' \in \{s, t\}$ for $F_{p'} = \varphi_4(F_p)$ (see Notation 7.4). In particular, $\varphi(\widetilde{\{p, q\}}) = \pm \widetilde{\{p', q'\}}$ for quadrangles F_p and F_q , and the set*

$$\{\pm \widetilde{\{p, q\}}: F_p \text{ and } F_q \text{ are quadrangles}\} \subset H^3(\mathcal{Z}_P)$$

is B -rigid in the class $\mathcal{P}_{aPog} \setminus \{I^3, M_5 \times I\}$.

Proof. We start with technical results.

Lemma 7.10. *Let F_i and F_j be two adjacent faces of a polytope $\mathcal{P}_{aPog} \setminus \{I^3, M_5 \times I\}$, and F_u, F_v be the faces intersecting $F_i \cap F_j$ by vertices. Then the loop $\mathcal{L} = (F_u, F_{i_1}, \dots, F_{i_k}, F_v, F_{j_1}, \dots, F_{j_r})$ around F_i and F_j , where $F_{i_l} \cap F_i$ are successive edges of F_i , and $F_{j_l} \cap F_j$ are successive edges of F_j is simple. It is a belt if and only if both F_u and F_v are not quadrangles. Moreover, if we delete from \mathcal{L} the quadrangles among F_u and F_v , we obtain a belt.*

Proof. Any face of a flag polytope is surrounded by a belt (see, for example, [BE17I, Proposition 2.9.2.]). Hence, $\mathcal{B}_1 = (F_u, F_{i_1}, \dots, F_{i_k}, F_v, F_j)$ and $\mathcal{B}_2 = (F_v, F_{j_1}, \dots, F_{j_r}, F_u, F_i)$ are belts. Then \mathcal{L} is not simple if and only if $F_{i_p} = F_{j_q}$ for some p, q . But then (F_i, F_j, F_{i_p}) is a 3-belt, which is a contradiction. Thus, \mathcal{L} is a simple loop. If it is not a belt, then two non-successive faces are adjacent. This can be possible only if they do not belong to \mathcal{B}_1 and \mathcal{B}_2 , that is one face is F_{i_p} , and the other is F_{j_q} . Then $(F_i, F_j, F_{i_p}, F_{j_q})$ is a 4-belt. It should surround a quadrangle adjacent to both F_i and F_j . It can be only F_u and F_v . If both of these faces are not quadrangles, then \mathcal{L} is a belt. Else delete these faces to obtain a new simple loop \mathcal{L}' . If two non-successive faces of this loop are adjacent, they have the form F_{i_p} and F_{j_q} . By the previous argument these faces should be adjacent to a quadrangle F_u or F_v . Then $(i_p, j_q) \in \{(i_k, j_1), (i_1, j_r)\}$ and F_{i_p} and F_{j_q} are successive in \mathcal{L}' . A contradiction. \square

Lemma 7.11. *Let $P \in \mathcal{P}_{aPog} \setminus \{I^3, M_5 \times I\}$. Then for any three pairwise different faces $\{F_i, F_j, F_k\}$ such that $F_i \cap F_j = \emptyset$, F_k is a quadrangle, and at least one of the faces F_i and F_j is not adjacent to F_k , there exists an l -belt ($l \geq 4$) \mathcal{B}_l such that $F_i, F_j \in \mathcal{B}_l$, $F_k \notin \mathcal{B}_l$, and \mathcal{B}_l does not contain any of the two pairs of opposite faces of the 4-belt around F_k .*

Proof. Let $(F_{i_1}, F_{i_2}, F_{i_3}, F_{i_4})$ be the 4-belt around F_k , and $F_{j_1}, F_{j_2}, F_{j_3}, F_{j_4}$ be the faces intersecting the edges $F_{i_l} \cap F_{i_{l+1}}$ by vertices different from $F_{i_l} \cap F_{i_{l+1}} \cap F_k$ (for convenience we consider $l \in \mathbb{Z}_4 = \mathbb{Z}/4\mathbb{Z}$ for i_l and j_l). By Lemma 7.10 for any l we have $F_{j_l} \neq F_{j_{l+1}}$ and $F_{j_l} \neq F_{j_{l+2}}$, since $F_{i_{l+1}}$ and $F_{i_{l+2}}$ are not quadrangles. Since there are at most one face among F_i and F_j in the 4-belt around F_k , there are at least two pairs $(F_{i_l}, F_{i_{l+1}})$ not containing both F_i and F_j . For them there is at least one $F_{j_l} \notin \{F_i, F_j\}$. Thus, we obtain a triple $\{F_{i_l}, F_{i_{l+1}}, F_{j_l}\}$ not containing faces in $\{F_i, F_j\}$. By Lemma 7.10 there is a belt corresponding to $(F_{i_l}, F_{i_{l+1}})$. It contains $F_{i_{l+2}}, F_{i_{l+3}}$, and contains F_{j_l} if and only if it is not a quadrangle. Connect the midpoints of edges of intersection of successive faces of this belt to obtain a piecewise linear closed cycle containing in one component of the complement F_{i_l} and $F_{i_{l+1}}$. Substitute a disk for this component to obtain a spherical graph. By [BE17I, Lemma 5.1.1] (also [BE17S, Lemma 3.11]) this graph corresponds

to a flag simple polytope. By the analog of SCC for flag polytopes (see Section 2) there is a belt in this polytope, which contains the faces arisen from F_i and F_j and does not contain the face corresponding to the disk. In P this belt corresponds to a belt \mathcal{B}_l we need, since subdivision of the disk does not add or remove edges of intersection of faces of the belt. The belt \mathcal{B}_l contains F_i and F_j , but does not contain F_{i_l} and $F_{i_{l+1}}$. This finishes the proof. \square

Now we are ready to proof Proposition 7.9. Let $p' \notin \{s, t\}$. The faces F'_s and F'_t are not adjacent simultaneously to any quadrangle, for otherwise $\{s, t\} \notin N_2^0(Q)$, $\{p, q\} \notin N_2^0(P)$, and F_p is adjacent to a quadrangle. In particular, they are not adjacent simultaneously to $F'_{p'}$. By Lemma 7.11 there is a belt \mathcal{B}'_l in Q , which contains F'_s and F'_t , and does not contain any of the pairs of opposite faces of the belt $\mathcal{B}_{p'}$ around $F'_{p'}$. Consider the preimage

$$\varphi^{-1}(\widetilde{\mathcal{B}'_l}) = \sum_s \lambda_s \widetilde{\mathcal{B}_{l,s}}.$$

By Corollary 6.10 any of the belts with $\lambda_s \neq 0$ contains F_p and F_q . In particular, it passes through a pair of opposite faces in the belt \mathcal{B}_p around F_p . By Corollary 7.7

$$\widetilde{\mathcal{B}'_l} = \varphi \left(\sum_s \lambda_s \widetilde{\mathcal{B}_{l,s}} \right) = \sum_s \lambda_s \varphi(\widetilde{\mathcal{B}_{l,s}}) = \sum_s \lambda_s \sum_j \mu_{s,j} \widetilde{\mathcal{B}'_{l,j}} = \sum_j \left(\sum_s \lambda_s \mu_{s,j} \right) \widetilde{\mathcal{B}'_{l,j}}$$

where each belt $\mathcal{B}'_{l,j}$, such that $\lambda_s \neq 0 \neq \mu_{s,j}$ for some s , contains a pair of opposite faces in the belt $\mathcal{B}_{p'}$. But \mathcal{B}'_l is equal to one of this belts, hence also contains a pair of opposite faces of the belt $\mathcal{B}_{p'}$ around $F'_{p'}$. A contradiction. Thus, $p' \in \{s, t\}$.

If F_p and F_q are both quadrangles, then Corollary 6.7 implies that $\varphi(\widetilde{\{p, q\}}) = \pm \widetilde{\{s, t\}}$ for some $\{s, t\} \in N_2^0(Q)$. From the above argument $q' \in \{s, t\}$ for $F'_{q'} = \varphi_4(F_q)$. Thus, $\{s, t\} = \{p', q'\}$. This finishes the proof. \square

Lemma 7.12. *Let $P, Q \in \mathcal{P}_{aPog} \setminus \{I^3, M_5 \times I\}$, and let \mathcal{B}_{2k} be a $(2k)$ -belt of P containing k quadrangles. Then for any isomorphism of graded rings $\varphi: H^*(\mathcal{Z}_P) \rightarrow H^*(\mathcal{Z}_Q)$ we have $\varphi(\widetilde{\mathcal{B}_{2k}}) = \pm \widetilde{\mathcal{B}'_{2k}}$ for a $(2k)$ -belt \mathcal{B}'_{2k} in Q containing k quadrangles. In particular, the set of elements*

$$\{\pm \widetilde{\mathcal{B}_{2k}} : \mathcal{B}_{2k} - \text{a } (2k)\text{-belt containing } k \text{ quadrangles}\} \subset H^{2k+2}(\mathcal{Z}_P)$$

is B-rigid in the class $\mathcal{P}_{aPog} \setminus \{I^3, M_5 \times I\}$. Moreover, φ_4 (see Notation 7.4) induces a bijection between quadrangles of \mathcal{B}_{2k} and quadrangles of \mathcal{B}'_{2k} , and for any two faces of F_p and F_q of \mathcal{B}_{2k} adjacent to a quadrangle F_i in \mathcal{B}_{2k} we have

$$\varphi(\widetilde{\{p, q\}} + A_3(P)) = \pm \widetilde{\{p', q'\}} + A_3(Q),$$

where the faces F'_p and $F'_{q'}$ are adjacent to $F'_i = \varphi_4(F_i)$.

Proof. Since P has no adjacent quadrangles, $\mathcal{B}_{2k} = (F_{i_1}, F_{j_1}, F_{i_2}, F_{j_2}, \dots, F_{i_k}, F_{j_k})$, where F_{i_1}, \dots, F_{i_k} are quadrangles, and F_{j_1}, \dots, F_{j_k} are not. Also $k \geq 3$, since each 4-belt surrounds a quadrangle and for this reason can not contain quadrangles.

We have

$$\varphi(\widetilde{\mathcal{B}}_{2k}) = \sum_s \mu_s \widetilde{\mathcal{B}'_{2k,s}},$$

where by Corollary 6.10 and Proposition 7.9 for each $\mu_s \neq 0$ the belt $\mathcal{B}'_{2k,s}$ contains all the pairs of quadrangles $\{F'_{i'_a} = \varphi_4(F_{i_a}), F'_{i'_b} = \varphi_4(F_{i_b})\}$, $a \neq b$. There are $\frac{k(k-1)}{2}$ such pairs. The belt $\mathcal{B}'_{2k,s}$ may contain at most this number of pairs of quadrangles, and it is achieved if and only if $\mathcal{B}'_{2k,s}$ contains exactly k quadrangles, and

$$\mathcal{B}'_{2k,s} = (F'_{u_1}, F'_{v_1}, F'_{u_2}, F'_{v_2}, \dots, F'_{u_k}, F'_{v_k})$$

for some quadrangles $F'_{u_1}, \dots, F'_{u_k}$. Then φ_4 induces a bijection between the sets $\{F_{i_1}, \dots, F_{i_k}\}$ and $\{F'_{u_1}, \dots, F'_{u_k}\}$: $F_{i_a} \rightarrow F'_{u_{a'}} = \varphi_4(F_{i_a})$. At this moment we do not know if this bijection preserves the cyclic order.

For each pair $\{j_{a-1}, j_a\}$ (where we assume that $a, a-1 \in \mathbb{Z}_k = \mathbb{Z}/k\mathbb{Z}$) we have $\varphi(\widetilde{\{j_{a-1}, j_a\}} + A_3(P)) = \pm\{z, w\} + A_3(Q)$ for faces F_z and F_w adjacent to $F_{u_{a'}}$. Moreover, by Corollary 7.7 the belt $\mathcal{B}'_{2k,s}$ passes through F_z and F_w . Thus, $\{z, w\} = \{v_{a'-1}, v_{a'}\}$. Since the belt $\mathcal{B}'_{2k,s}$ is covered by segments $(F'_{v_{a'-1}}, F'_{u_{a'}}, F'_{v_{a'}})$, there is only one belt $\mathcal{B}'_{2k,s}$ with $\mu_s \neq 0$, and $\varphi(\widetilde{\mathcal{B}}_{2k}) = \pm\widetilde{\mathcal{B}'_{2k,s}}$. \square

Lemma 7.13. *Let $P, Q \in \mathcal{P}_{aPog} \setminus \{I^3, M_5 \times I\}$, and let \mathcal{B}_{2k} be a trivial $(2k)$ -belt of P containing k quadrangles. Then for any isomorphism of graded rings $\varphi: H^*(\mathcal{Z}_P) \rightarrow H^*(\mathcal{Z}_Q)$ we have $\varphi(\widetilde{\mathcal{B}}_{2k}) = \pm\widetilde{\mathcal{B}'_{2k}}$ for a trivial $(2k)$ -belt \mathcal{B}'_{2k} in Q containing k quadrangles. In particular, the set of elements*

$$\{\pm\widetilde{\mathcal{B}}_{2k} : \mathcal{B}_{2k} - \text{a trivial } (2k)\text{-belt containing } k \text{ quadrangles}\} \subset H^{2k+2}(\mathcal{Z}_P)$$

is B -rigid in the class $\mathcal{P}_{aPog} \setminus \{I^3, M_5 \times I\}$.

Proof. As before, we see that $k \geq 3$, since each 4-belt surrounds a quadrangle and for this reason can not contain quadrangles.

By Lemma 7.13 we have $\varphi(\widetilde{\mathcal{B}}_{2k}) = \pm\widetilde{\mathcal{B}'_{2k}}$ for a $(2k)$ -belt \mathcal{B}'_{2k} in Q containing k quadrangles. We will use notations from the proof of this lemma.

Assume that the belt \mathcal{B}_{2k} surrounds a face F_i , and the belt \mathcal{B}'_{2k} is not trivial.

Consider a subgroup $G(\mathcal{B}_{2k}) \subset H^{2k+3}(\mathcal{Z}_P)$ consisting of all the elements divisible by $\widetilde{\{i_a, i_b\}}$ for all $a \neq b$, and by each member of a coset $\widetilde{\{j_{a-1}, j_a\}} + A_3(P)$ for all a . We have $2k+3 \leq m$, since outside the belt there are at least two faces, for otherwise P should be a prism and have adjacent quadrangles.

Since $\omega(\mathcal{B}_{2k}) = \bigcup_{a \neq b} \{i_a, i_b\} \bigcup_a \{j_{a-1}, j_a\}$ Lemma 6.9 implies that any element in $G(\mathcal{B}_{2k})$ has the form

$$\sum_{\tau \supset \omega(\mathcal{B}_l)} \beta_\tau, \text{ where } \beta_\tau \in \widetilde{H}^1(P_\tau), |\tau| = l+1,$$

and each nonzero β_τ is divisible by all $\widetilde{\{i_a, i_b\}}$ and $\widetilde{\{j_{a-1}, j_a\}}$. Then $\tau = \omega(\mathcal{B}_{2k}) \sqcup \{r\}$. We have $F_r \neq F_i$, for otherwise P_τ is contractible. Let F_r be adjacent to two non-successive faces of \mathcal{B}_{2k} , say F_p and F_q . Then (F_r, F_p, F_i, F_q) is a 4-belt surrounding a quadrangle F_{i_a} in \mathcal{B}_{2k} , and $\{F_p, F_q\} = \{F_{j_{a-1}}, F_{j_a}\}$. There are k such quadrangles. If F_r is adjacent to some face in \mathcal{B}_{2k} different from $F_{j_{a-1}}$, F_{i_a} , and F_{j_a} , then this face is not successive with F_{i_a} , and by the previous argument F_{i_a} belongs a 4-belt around a quadrangle, which is a contradiction. Thus, F_r is not adjacent to other faces in \mathcal{B}_{2k} . There are k faces of this type. For them $P_{\tau \setminus \{i_b\}}$ is connected for any $i_b \neq i_a$, hence β_τ is not divisible by $\widetilde{\{i_a, i_b\}}$. If F_r is adjacent to two successive faces of \mathcal{B}_{2k} , then one of this faces is a quadrangle, and F_r is of previous type. If F_r is adjacent to exactly one face of \mathcal{B}_{2k} , then this face is not a quadrangle, and P_τ is homeomorphic to $|\mathcal{B}_{2k}|$. If F_r is not adjacent to faces in \mathcal{B}_{2k} , then P_τ is a disjoint union of $|\mathcal{B}_{2k}|$ and F_r . In both cases $\widetilde{H}^1(P_\tau) = \mathbb{Z}$, and its generator is divisible by all the elements $\widetilde{\{i_a, i_b\}}$ and $\widetilde{\{j_{a-1}, j_a\}}$. Moreover, by Lemma 7.8 this generator is also divisible by any element in the coset $\widetilde{\{j_{a-1}, j_a\}} + A_3(P)$. Thus, $G(\mathcal{B}_{2k})$ is a free abelian group of rank $m - 2k - 1 - k = m - 3k - 1$.

Now consider the belt \mathcal{B}'_{2k} . Since $\varphi(\widetilde{\{i_a, i_b\}}) = \pm \{u_{a'}, u_{b'}\}$ for all $a \neq b$, and $\varphi(\widetilde{\{j_{a-1}, j_a\}} + A_3(P)) = \pm \{v_{a'-1}, v_{a'}\} + A_3(Q)$ for all a , we have $\varphi(G(\mathcal{B}_{2k})) = G(\mathcal{B}'_{2k})$. By the above argument each element in $G(\mathcal{B}'_{2k})$ has the form

$$\sum_{\tau \supset \omega(\mathcal{B}'_{2k})} \beta'_\tau, \text{ where } \beta'_\tau \in \widetilde{H}^1(Q_\tau), |\tau| = l + 1,$$

and each nonzero β'_τ is divisible by all $\widetilde{\{u_a, u_b\}}$ and $\widetilde{\{v_{a-1}, v_a\}}$. Also $\tau = \omega(\mathcal{B}'_{2k}) \sqcup r$. Consider a face F'_r of Q . Let F'_r be adjacent to two non-successive faces of \mathcal{B}'_{2k} , say F'_p and F'_q . Since \mathcal{B}'_{2k} is a nontrivial belt and Q is a flag polytope, F'_r is not adjacent to some face of \mathcal{B}'_{2k} . We can assume that for the segment $T = (F'_p, F'_{w_1}, \dots, F'_{w_t}, F'_q)$ of \mathcal{B}'_{2k} the face F'_r is not adjacent to $F'_{w_1}, \dots, F'_{w_t}$. Then F'_p and F'_q are not quadrangles, for otherwise either F'_{w_1} or F'_{w_t} is adjacent to F'_r . Hence, $\mathcal{B}'_{t+3} = (F'_r, F'_p, F'_{w_1}, \dots, F'_{w_t}, F'_q)$ is a $(t+3)$ -belt, where $4 \leq t+3 \leq 2k$, and $t+3 = 2k$ only if F'_p and F'_q are faces adjacent to one face F'_v in \mathcal{B}'_{2k} . This face F'_v is a quadrangle, since F'_p and F'_q are not quadrangles. Then $F'_v \cap F'_r \neq \emptyset$, for otherwise (F'_v, F'_p, F'_r, F'_q) is a 4-belt around a quadrangle adjacent to the quadrangle F'_v . Thus, if $t+3 = 2k$, then F'_r is adjacent only to the three faces $F'_{v_{a-1}}$, F'_{u_a} , and F'_{v_a} in \mathcal{B}'_{2k} for some a .

Now assume that $t+3 < 2k$. If $t+3 = 4$, then \mathcal{B}'_{t+3} surrounds a quadrangle adjacent to three successive faces of \mathcal{B}'_{2k} , which is a contradiction. Thus, $t+3 \geq 5$. Moreover, $t+3 \geq 6$ is an even number, for otherwise either F'_p or F'_q is a quadrangle. In particular, there are at least two quadrangles in T . Consider the preimage

$$\varphi^{-1}(\widetilde{\mathcal{B}'_{t+3}}) = \sum_s \lambda_s \widetilde{\mathcal{B}_{t+3,s}}$$

Each belt $\mathcal{B}_{t+3,s}$ is divisible by any $\widetilde{\{i_a, i_b\}}$ for $\{u_{a'}, u_{b'}\} \subset \omega(\mathcal{B}'_{t+3})$. Corollary 7.7 implies that it is also divisible by any $\widetilde{\{j_{a-1}, j_a\}}$ with $\{v_{a'-1}, v_{a'}\} \subset \omega(\mathcal{B}'_{t+3})$ (since in this case $F_{v_{a'}} \in T$).

In particular, it contains $F_{j_{a-1}}, F_{i_a}, F_{j_a}, F_{j_{b-1}}, F_{i_b}$, and F_{j_b} . The mapping φ_4^{-1} sends the set of quadrangles in T injectively to some set of quadrangles in $\mathcal{B}_{t+3,s} \cap \mathcal{B}_{2k}$. Moreover, the image of each quadrangle is contained in $\mathcal{B}_{t+3,s} \cap \mathcal{B}_{2k}$ with two adjacent faces. Denote by $M \subset \mathcal{B}_{t+3,s} \cap \mathcal{B}_{2k}$ the union of the images of quadrangles and the faces in $\mathcal{B}_{t+3,s} \cap \mathcal{B}_{2k}$ adjacent to these images. The set M is a disjoint union of segments of \mathcal{B}_{2k} . Enumerate them in the order they appear in the belt. If we identify the last face of each segment with the first face of the next segment (both of them are not quadrangles), we obtain one segment consisting of $|T| = t + 2$ faces. If M consists of more than one connected component, then it has more than $t + 2$ faces. But M has at most $t + 3$ faces, since $M \subset \mathcal{B}_{t+3,s}$. Therefore, $M = \mathcal{B}_{t+3,s} \subset \mathcal{B}_{2k}$. This is impossible, since $t + 3 < 2k$. Thus, M is a segment of \mathcal{B}_{2k} consisting of $t + 2$ faces. Then the $(t + 3)$ -th face in $\mathcal{B}_{t+3,s}$ is some face $F_x \notin \mathcal{B}_{2k}$. Since $\mathcal{B}_{t+3,s}$ is a belt, F_x is different from F_i . Let F_{j_a} and F_{j_b} be the first and the last faces of M (we know that these faces are not quadrangles, in particular, they are not adjacent). Then $(F_{j_a}, F_i, F_{j_b}, F_x)$ is a 4-belt surrounding some quadrangle $F_{i_c} \in \mathcal{B}_{2k}$. Then $\{F_{j_a}, F_{j_b}\} = \{F_{j_{c-1}}, F_{j_c}\}$, and F_x is adjacent to F_{i_c} . Therefore $M = \mathcal{B}_{2k} \setminus \{F_{i_c}\}$, and $t + 2 = 2k - 1$, which is a contradiction. Hence, the case $t + 3 < 2k$ is impossible.

Thus, if the face F'_r is adjacent in $\mathcal{B}_{2k'}$ to non-successive faces, then it is adjacent exactly to some quadrangle F'_{u_a} and its adjacent faces $F'_{v_{a-1}}, F'_{v_a}$. There are $2k$ faces of this type. If F'_r is adjacent to two successive faces, then one of them is a quadrangle, and we come to the previous case. Also F'_r can be adjacent to exactly one face F'_{v_a} , which is not a quadrangle, or to no faces in \mathcal{B}'_{2k} . In each of these cases $\widetilde{H}^1(Q_\tau) = \mathbb{Z}$. In the first case the generator is not divisible by $\widetilde{\{u_a, u_b\}}$ for any $b \neq a$, since $Q_{\tau \setminus \{u_a, u_b\}}$ is connected. In the second and the third cases the generator is divisible by all the elements $\widetilde{\{u_a, u_b\}}$ and $\widetilde{\{v_{a-1}, v_a\}}$. Moreover, by Lemma 7.8 it is also divisible by any element in the coset $\widetilde{\{v_{a-1}, v_a\}} + A_3(Q)$. Thus, $G(\mathcal{B}'_{2k})$ is a free abelian group of rank $m - 2k - 2k = m - 4k$. Since $m - 4k < m - 3k - 1$ for $k > 1$ we obtain a contradiction. Thus, \mathcal{B}'_{2k} is a trivial belt. This finishes the proof. \square

Lemma 7.14. *Let $P \in \mathcal{P}_{aPog} \setminus \{I^3, M_5 \times I\}$, F_i be its quadrangle, and let \mathcal{B}_{2k} be the $(2k)$ -belt containing k quadrangles and surrounding a face F_j . Then F_i and F_j are adjacent if and only if the element $\widetilde{\mathcal{B}_{2k}}$ is divisible by any element in the coset $\widetilde{\{p, q\}} + A_3(P)$ for one of the two pairs of opposite faces $\{F_p, F_q\}$ of the 4-belt \mathcal{B}_i around F_i . In particular, if F_i and F_j are adjacent, then for any isomorphism of graded rings $\varphi: H^*(\mathcal{Z}_P) \rightarrow H^*(\mathcal{Z}_Q)$ for a polytope $Q \in \mathcal{P}_{aPog} \setminus \{I^3, M_5 \times I\}$ we have $\varphi(\widetilde{\mathcal{B}_{2k}}) = \pm \widetilde{\mathcal{B}'_{2k}}$ for a $(2k)$ -belt \mathcal{B}'_{2k} containing k quadrangles and surrounding a face $F'_{j'}$ adjacent to $F'_{i'} = \varphi_4(F_i)$.*

Proof. If F_j is adjacent to F_i , then Lemma 7.8 implies that $\widetilde{\mathcal{B}_2}$ is divisible by any element in the coset $\widetilde{\{p, q\}} + A_3(P)$ for faces F_p, F_q adjacent to F_i and lying in \mathcal{B}_{2k} . On the other hand, if the element $\widetilde{\mathcal{B}_{2k}}$ is divisible by any element in the coset $\widetilde{\{p, q\}} + A_3(P)$ for faces F_p, F_q adjacent to F_i , then it is divisible by $\widetilde{\{p, q\}}$. Hence, \mathcal{B}_{2k} contains F_p and F_q . If it does not contain F_i , then (F_i, F_p, F_j, F_q) is a 4-belt around some quadrangle adjacent to F_i . A contradiction.

By Lemma 7.13 we have $\varphi(\widetilde{\mathcal{B}}_{2k}) = \pm \widetilde{\mathcal{B}}'_{2k}$ for a belt \mathcal{B}'_{2k} containing k quadrangles and surrounding a unique face $F'_{j'}$. The element $\widetilde{\mathcal{B}}_{2k}$ is divisible by any element in the coset $\widetilde{\{p', q'\}} + A_3(Q)$ for faces $F'_{p'}, F'_{q'}$ adjacent to $F'_{j'}$. Hence, the face $F'_{j'}$ is adjacent to $F'_{i'}$. \square

Lemma 7.15. *Let $P \in \mathcal{P}_{aPog} \setminus \{I^3, M_5 \times I\}$, and let \mathcal{B}_{2k} be the $(2k)$ -belt containing k quadrangles and surrounding a face F_i , and \mathcal{B}_{2l} be the $(2l)$ -belt containing l quadrangles and surrounding a face F_j . Then F_i and F_j are adjacent if and only if the elements $\widetilde{\mathcal{B}}_{2k}$ and $\widetilde{\mathcal{B}}_{2l}$ have exactly one common divisor among elements $\widetilde{\{p, q\}}$ corresponding to pairs of quadrangles. In particular, if F_i and F_j are adjacent, then for any isomorphism of graded rings $\varphi: H^*(\mathcal{Z}_P) \rightarrow H^*(\mathcal{Z}_Q)$ for a polytope $Q \in \mathcal{P}_{aPog} \setminus \{I^3, M_5 \times I\}$ we have $\varphi(\widetilde{\mathcal{B}}_{2k}) = \pm \widetilde{\mathcal{B}}'_{2k}$ for a $(2k)$ -belt \mathcal{B}'_{2k} containing k quadrangles and surrounding a face $F'_{i'}$, and $\varphi(\widetilde{\mathcal{B}}_{2l}) = \pm \widetilde{\mathcal{B}}'_{2l}$ for a $(2l)$ -belt \mathcal{B}'_{2l} containing l quadrangles and surrounding a face $F'_{j'}$ adjacent to $F'_{i'}$.*

Proof. We have $k, l \geq 3$, since a 4-belt surrounds a quadrangle and can not contain quadrangles. If F_i and F_j are adjacent, then, since P is flag, $\mathcal{B}_1 \cap \mathcal{B}_2$ consists of two non-adjacent faces intersecting the edge $F_i \cap F_j$ by vertices, and both of them are quadrangles. On the other hand, let $F_i \cap F_j = \emptyset$, and $\{u, v\} \subset \omega(\mathcal{B}_1) \cap \omega(\mathcal{B}_2)$ with $F_u \cap F_v = \emptyset$. Then (F_u, F_i, F_v, F_j) is a 4-belt around a quadrangle. If F_u and F_v are quadrangles, we have a contradiction. If $F_i = F_j$, then the elements $\widetilde{\mathcal{B}}_{2k}$ and $\widetilde{\mathcal{B}}_{2l}$ have $\frac{k(k-1)}{2} \geq 3$ common divisors corresponding to pairs of quadrangles. The second part of the lemma follows from Lemma 7.13. \square

Remark 7. Lemmas 7.13, 7.14, and 7.15 imply that any ideal almost Pogorelov polytope is B -rigid. The details see in [E20b].

8. COHOMOLOGY RING $H^*(\mathcal{Z}_{As^3})$

For the associahedron As^3 we have the following picture. The group of symmetries of As^3 acts transitively on quadrangles (3 quadrangles) and pentagons (6 pentagons).

There are three equivalence classes of edges:

- (1) a common edge of a quadrangle and a pentagon (12 edges);
- (2) a common edge of pentagons connecting two vertices of quadrangles (3 edges);
- (3) a common edge of pentagons containing a common vertex of 3 pentagons (6 edges).

There are two equivalence classed of vertices:

- (1) vertices of quadrangles (12 vertices);
- (2) common vertices of 3 pentagons (2 vertices).

We have the following subsets P_ω of faces with $\widetilde{H}^0(P_\omega) \neq 0$ (see Fig. 17). The complementary subsets $P_{[m] \setminus \omega}$ are exactly subsets with $\widetilde{H}^1(P_{[m] \setminus \omega}) \neq 0$. It should be $|\omega| \geq 2$.

- (1) For $|\omega| = 2$ the sets $\omega = \{i, j\}$ correspond to pairs of nonadjacent faces $F_i, F_j, F_i \cap F_j = \emptyset$. We have 3 types of pairs encoded by numbers k_1, k_2 , of edges of faces: $4 - 4$ (3 pairs, all equivalent); $4 - 5$ (6 pairs, all equivalent); $5 - 5$ (6 pairs, all equivalent); In total we

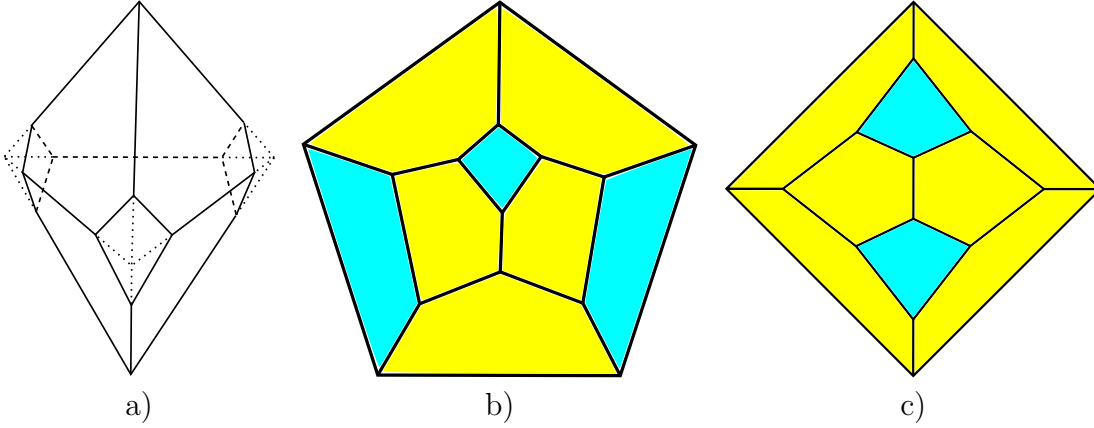

FIGURE 16. a) a 3-dimensional associahedron (Stasheff polytope) As^3 as a truncated bipyramid; b) its Schlegel diagram based at a pentagon; c) its Schlegel diagram based at a quadrangle

have $\mathbb{Z}^{15} = H^3(\mathcal{Z}_P)$. By the Poincare duality $H^9(\mathcal{Z}_P) \simeq \mathbb{Z}^{15}$. The generators correspond to generators in $\tilde{H}^1(P_{[m]\setminus\omega})$ for the complementary subsets.

- (2) For $|\omega| = 3$ the sets $\omega = \{i, j, k\}$ correspond to either triples of disjoint faces or to pairs of disjoint sets: a face and a pair of adjacent faces; For the first type we have only one set $4 - 4 - 4$. This corresponds to $\mathbb{Z}^2 \subset H^4(\mathcal{Z}_P)$. For the second type we have cases: $4 - 45$ (for each quadrangle 4 pairs 45 , in total 12 pairs, all equivalent); $4 - 55$ (for each quadrangle one pair, in total 3 pairs, all equivalent); $5 - 45$ (for each pentagon two pairs, in total 12 pairs, all equivalent); $5 - 55$ (for each pentagon one pair, in total 6 pairs, all equivalent). This corresponds to $\mathbb{Z}^{33} \subset H^4(\mathcal{Z}_P)$. In total, since no two faces can give nonzero contribution to $H^4(\mathcal{Z}_P)$, we have $H^4(\mathcal{Z}_P) = \mathbb{Z}^2 \oplus \mathbb{Z}^{33} = \mathbb{Z}^{35}$. By the Poincare duality $H^8(\mathcal{Z}_P) \simeq \mathbb{Z}^2 \oplus \mathbb{Z}^{33} = \mathbb{Z}^{35}$. Here the summand \mathbb{Z}^2 corresponds to the complement to three disjoint quadrangles, which is a sphere with two holes. The generators in \mathbb{Z}^{33} correspond to generators in $\tilde{H}^1(P_{[m]\setminus\omega})$ for the complementary subsets.
- (3) Let $|\omega| = 4$. Four can be expressed as a sum of positive integers in the following ways: $4 = 1 + 1 + 1 + 1$; $4 = 1 + 1 + 1 + 2$; $4 = 1 + 3$; $4 = 2 + 2$. First let us mention that if one of the connected components of P_ω consists of one face, then either there are only two components, or there are three components each consisting of a single quadrangle (it can be extracted from Fig. 16). Thus, we can have only $1 + 3$ or $2 + 2$. For the first case we may have $4 - 445$ (two for each quadrangle, all equivalent, in total 6), $4 - 455$ (two for each quadrangle, all equivalent, in total 6), or $5 - 455$ (one for each pentagon, all equivalent, in total 6). For the second case we may have only $45 - 45$ (all equivalent, in total 6). Since P has no 3-belts, we have $H^5(\mathcal{Z}_P) \simeq \mathbb{Z}^{24}$. By the Poincare duality $H^7(\mathcal{Z}_P) \simeq \mathbb{Z}^{24}$. The generators correspond to generators in $\tilde{H}^1(P_{[m]\setminus\omega})$ for the complementary subsets.

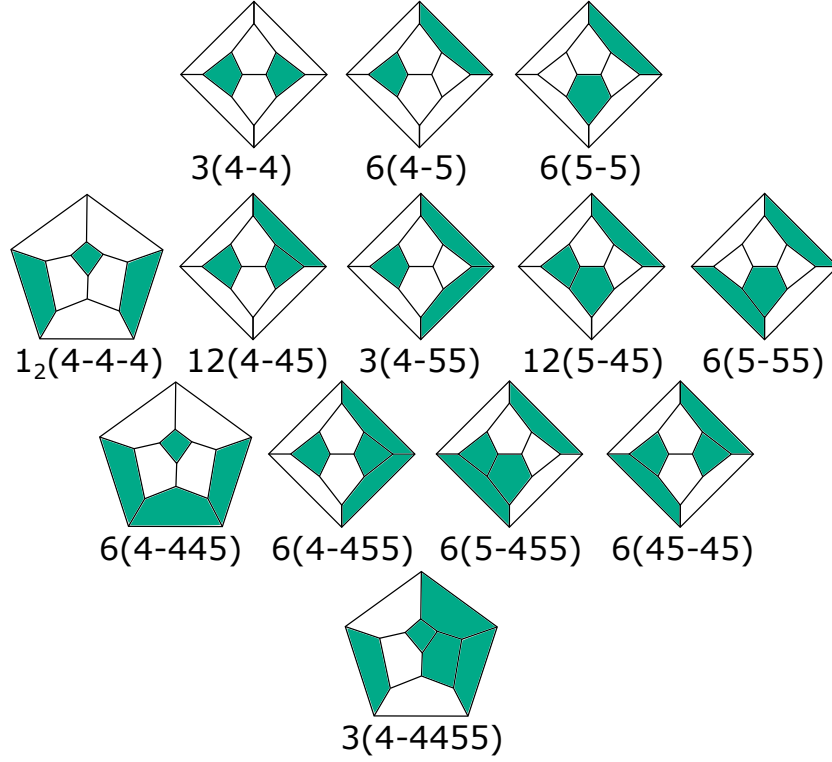

FIGURE 17. Collections P_ω giving classes in $\tilde{H}^0(P_\omega)$

TABLE 1. Additive structure of $H^*(\mathcal{Z}_{As^3})$

k	0	1	2	3	4	5	6	7	8	9	10	11	12
$H^k(\mathcal{Z}_P)$	\mathbb{Z}	0	0	\mathbb{Z}^{15}	\mathbb{Z}^{35}	\mathbb{Z}^{24}	\mathbb{Z}^6	\mathbb{Z}^{24}	\mathbb{Z}^{35}	\mathbb{Z}^{15}	0	0	\mathbb{Z}

- (4) For $\omega = 5$ we have $5 = 1 + 4 = 2 + 3$. For the first case we have 4 – 4455 (one for each quadrangle, all equivalent, in total 3). The case $2 + 3$ is impossible, since for any pair of adjacent faces the set of faces not adjacent to both of them has cardinality at most 2. We have $\mathbb{Z}^3 \subset H^6(\mathcal{Z}_P)$. The complementary subsets are 4-belts and correspond to generators in $\tilde{H}^1(P_{[m]\setminus\omega})$, and we obtain a complementary summand $\mathbb{Z}^3 \subset H^6(\mathcal{Z}_P)$ such that $H^6(\mathcal{Z}_P) = \mathbb{Z}^3 \oplus \mathbb{Z}^3$.

Additive structure of $H^*(\mathcal{Z}_P)$ is represented in Table 1.

Choose in each group $\tilde{H}^0(P_\omega) = \mathbb{Z}$ a generator β_ω . We will call these generators *canonical generators*. There is only one set P_ω with $\text{rk } \tilde{H}^0(P_\omega) > 1$. This is the union of three quadrangles with $\tilde{H}^0(P_\omega) = \mathbb{Z}^2$. Choose in this group two generators $\beta_{\omega,1}$ and $\beta_{\omega,2}$ corresponding to two quadrangles. We will also call these generators *additional*. Canonical and additional generators

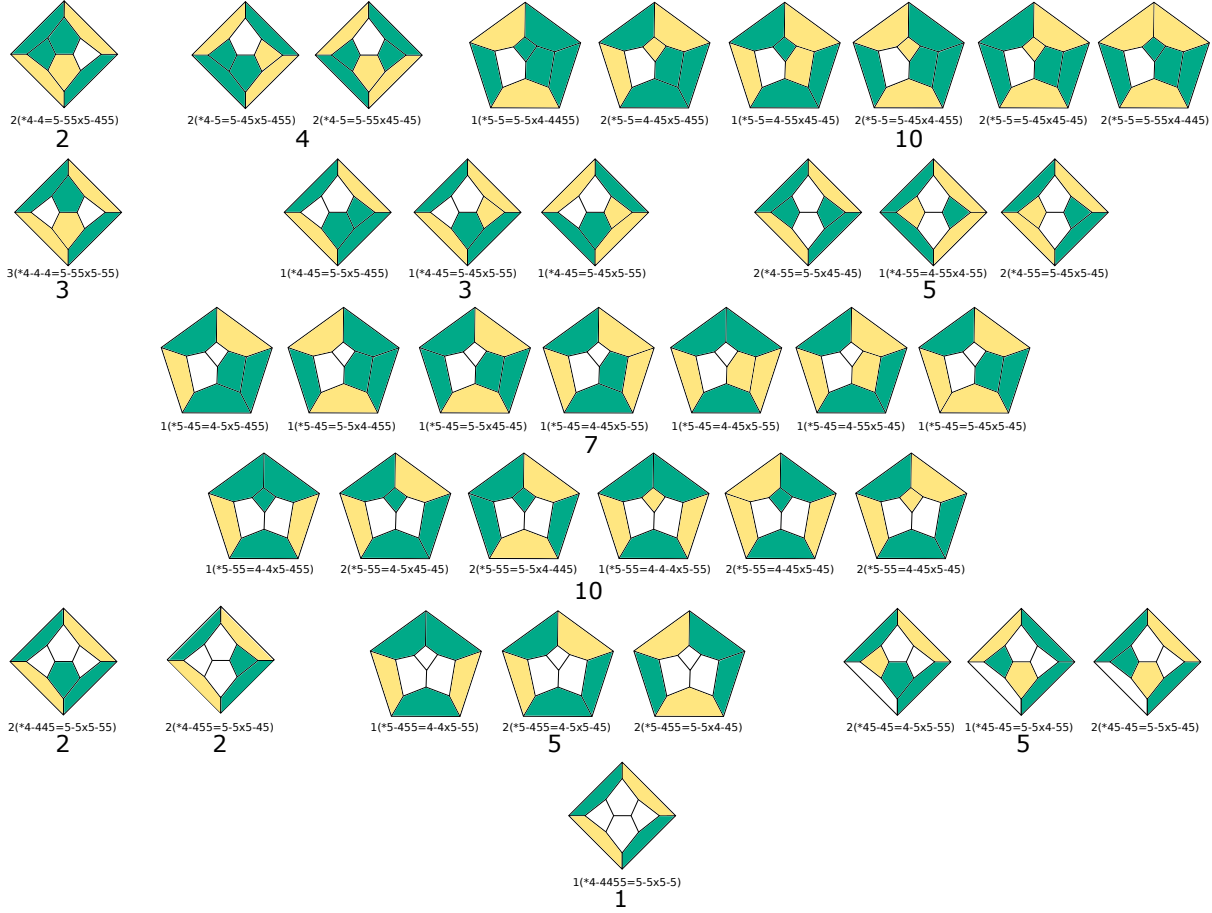

FIGURE 18. Decompositions of the sets $P_{[m]\omega}$ with $\tilde{H}^0(P_\omega) \neq 0$

together form the set of multiplicative generators $\{\beta\}$ of $H^*(\mathcal{Z}_{As^3})$, since As^3 is a flag polytope. For short we will call them *generators*.

To describe the multiplication in $H^*(\mathcal{Z}_P)$ we need to describe how the product of each two generators can be expressed in terms of the elements $\{\beta^*\}$ dual to generators, where $\beta \cdot \beta^* = [\mathcal{Z}_P]$ – a fundamental class in cohomology, and $\beta \cdot (\beta')^* = 0$ for $\beta \neq \beta'$.

For each set P_ω with $\tilde{H}^0(P_\omega) \neq 0$ on Fig. 18 we describe all the ways how $P_{[m]\omega}$ up to combinatorial symmetries can be represented as a union of $P_{\omega_1} \cup P_{\omega_2}$ with $[m] \setminus \omega = \omega_1 \sqcup \omega_2$ and $\tilde{H}^0(P_{\omega_1}) \neq 0$, $\tilde{H}^0(P_{\omega_2}) \neq 0$. Also we give the number of combinatorially symmetric decompositions.

On Fig. 19 we describe all the ways how the boundary ∂P of the polytope P up to combinatorial symmetries can be decomposed as a union of three sets P_{ω_1} , P_{ω_2} , and P_{ω_3} with $[m] = \omega_1 \sqcup \omega_2 \sqcup \omega_3$, and $\tilde{H}^0(P_{\omega_i}) \neq 0$ for $i = 1, 2, 3$. We present the number of combinatorially

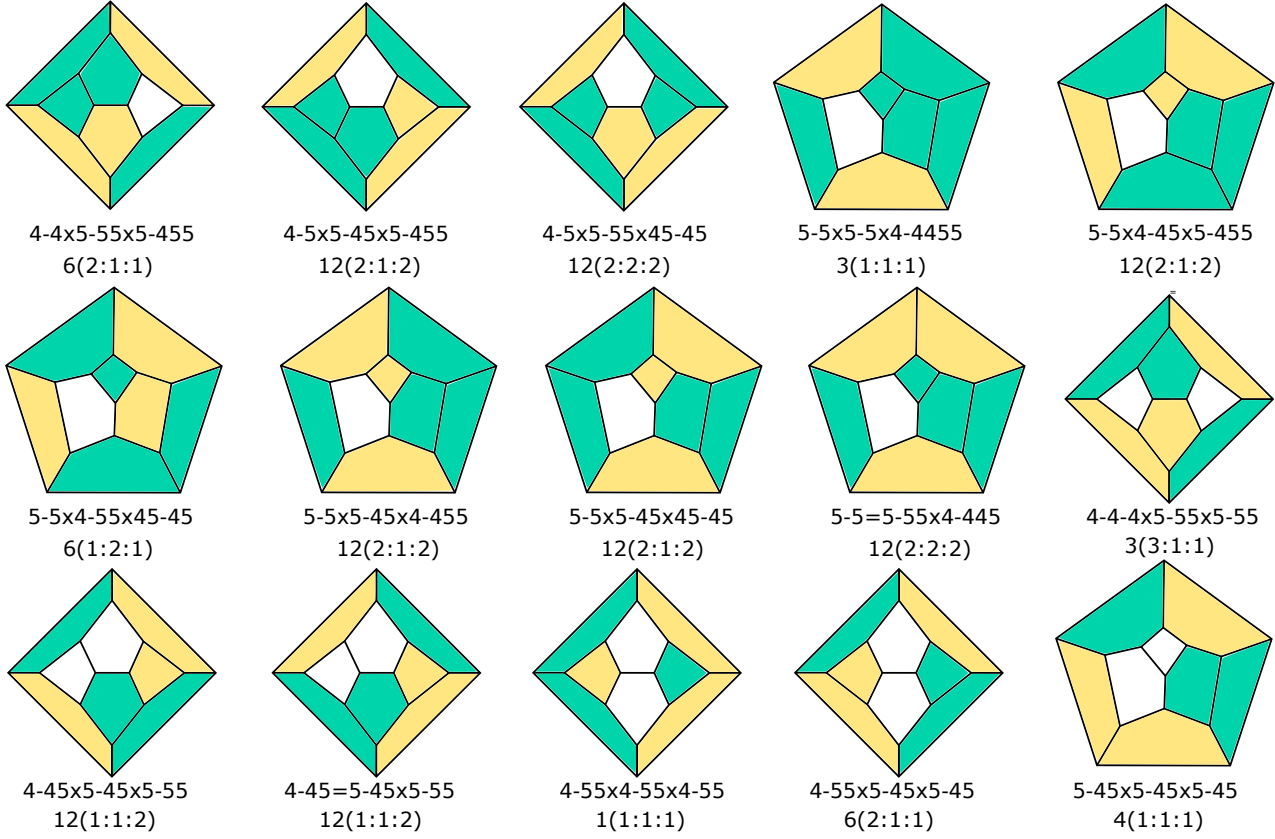

FIGURE 19. Decompositions $\partial P = P_{\omega_1} \cup P_{\omega_2} \cup P_{\omega_3}$ with $[m] = \omega_1 \sqcup \omega_2 \sqcup \omega_3$, and $\tilde{H}^0(P_{\omega_i}) \neq 0$ for $i = 1, 2, 3$

symmetric decompositions and for each set we give the number of decompositions where it arises.

For generators $\beta_1 \in \tilde{H}^0(P_{\omega_1})$, $\beta_2 \in \tilde{H}^0(P_{\omega_2})$ their product $\beta_1 \cdot \beta_2$ can be expressed uniquely in terms of elements $\beta^* \in \tilde{H}^1(P_{\omega_1 \sqcup \omega_2})$ dual to generators $\beta \in \tilde{H}^0(P_{\omega_3})$, $\omega_3 = [m] \setminus (\omega_1 \sqcup \omega_2)$. If $\tilde{H}^0(P_{\omega_3}) = \mathbb{Z}$, then $\beta_1 \cdot \beta_2$ is necessarily $\pm\beta_{\omega_3}$. If $\tilde{H}^0(P_{\omega_3}) = \mathbb{Z}^2$, then P_{ω_3} is the set of three disjoint quadrangles, and due to Fig. 18 P_{ω_1} and P_{ω_2} both are disjoint unions of a pentagon and two adjacent pentagons. There are 3 such decompositions. The dual classes $\beta_{\omega_3,1}^*$ and $\beta_{\omega_3,2}^*$ in $H_1(P_{[m] \setminus \omega_3}, \partial P_{[m] \setminus \omega_3})$ are represented by the edges connecting a vertex of the quadrangle corresponding to the generator to a vertex of the third quadrangle. The edge connecting vertices of the two quadrangles corresponding to generators gives the element $\pm\beta_{\omega_3,1}^* \pm \beta_{\omega_3,2}^*$. Thus, the three products $\beta_1 \cdot \beta_2$ are equal to $\pm\beta_{\omega_3,1}^*$, $\pm\beta_{\omega_3,2}^*$, and $\pm\beta_{\omega_3,1}^* \pm \beta_{\omega_3,2}^*$.

Up to signs this gives a full description of the ring $H^*(\mathcal{Z}_{As^3}, \mathbb{Z})$.

For an element $\tilde{\omega}$, $\omega = \{F_p, F_q\}$, $F_p \cap F_q = \emptyset$, the complementary subspace in $H^*(\mathcal{Z}_P, \mathbb{Q})$ to $\text{Ann}_H(\tilde{\omega})$ is generated by the element $\tilde{\omega}^* \in H^m(\mathcal{Z}_P, \mathbb{Q})$ dual to $\tilde{\omega}$, and the canonical generators dividing $\tilde{\omega}^*$. In particular,

- (1) If F_p and F_q are both quadrangles, then $\text{codim Ann}_H(\tilde{\omega}) = 5$;
- (2) If F_p is a quadrangle, and F_q is a pentagon, then $\text{codim Ann}_H(\tilde{\omega}) = 9$;
- (3) If F_p and F_q are both pentagons, then $\text{codim Ann}_H(\tilde{\omega}) = 21$.

Also

- (1) If F_p and F_q are both quadrangles, then any element $\omega' \in N_2(P) \setminus \{\omega\}$ is good for ω ;
- (2) If F_p is a quadrangle, and F_q is a pentagon, then an element $\omega' \in N_2(P) \setminus \{\omega\}$ is bad for ω if and only if $\omega' = \{p, r\}$, where F_r is a quadrangle adjacent to F_q . There are two such pairs;
- (3) If F_p and F_q are both pentagons, then they are both adjacent to a unique quadrangle F_r . Then an element $\omega' = \{s, t\} \in N_2(P) \setminus \{\omega\}$ is bad for ω if and only if either $\omega' = \{F_r, F_u\}$, where $F_u \cap F_r = \emptyset$, or $\omega' = \{p, v\}$, where $F_v \neq F_r$ is a quadrangle adjacent to F_q , or $\omega' = \{q, w\}$, where $F_w \neq F_r$ is a quadrangle adjacent to F_p , or $\omega' = \{v, w\}$. There are 7 bad elements in total.

Corollary 8.1. *The set of elements $\{\pm\tilde{\omega}\}$ corresponding to pairs of quadrangles in As^3 is mapped to itself under each automorphism of a graded ring $H^*(\mathcal{Z}_P)$.*

Corollary 8.2. *Under each automorphism of a graded ring $H^*(\mathcal{Z}_P)$ for $P = As^3$ each element $\tilde{\omega}$, where $\omega = \{p, q\}$, F_p is a quadrangle, and F_q is a pentagon, is mapped to the element $\pm\tilde{\omega}' + \lambda_1\tilde{\omega}'_1 + \lambda_2\tilde{\omega}'_2$, where ω' has the same type as ω , and ω'_1, ω'_2 are bad for ω' .*

Proposition 8.3. *Let $\omega = \{p, q\}$, where F_p is a quadrangle, and F_q is a pentagon, and let F_u and F_v be quadrangles different from F_p . Then for $\omega_1 = \{q, u\}$, $\omega_2 = \{q, v\}$ and any λ_1, λ_2 we have*

$$\dim \text{Ann}_H(\tilde{\omega}) = \dim \text{Ann}_H(\tilde{\omega} + \lambda_1\tilde{\omega}_1 + \lambda_2\tilde{\omega}_2).$$

Proof. Denote $4-5 = \tilde{\omega}$, $4-4_1 = \tilde{\omega}_1$, $4-4_2 = \tilde{\omega}_2$, $\alpha = 4-5 + \lambda_1 4-4_1 + \lambda_2 4-4_2$. Then due to Fig. 18

- (1) $4-4_1^*$ is divided by $5-55_{11}$, $5-55_{12}$, $5-455_{11}$, and $5-455_{12}$. Moreover, choosing appropriate signs of generators, we can assume that

$$4-4_1^* = 5-55_{11} \cdot 5-455_{11} = 5-55_{12} \cdot 5-455_{12}.$$

- (2) $4-4_2^*$ is divided by $5-55_{21}$, $5-55_{22}$, $5-455_{21}$, and $5-455_{22}$. Here all the elements listed above are different. Moreover, we can assume that

$$4-4_2^* = 5-55_{21} \cdot 5-455_{21} = 5-55_{22} \cdot 5-455_{22}.$$

- (3) $4-5^*$ is divided by $5-45_1$, $5-45_2$, $5-455_{11}$, $5-455_{21}$, $5-55_{11}$, $5-55_{21}$, $45-45_1$ and $45-45_2$. Moreover, choosing appropriate signs of generators, we have

$$4-5^* = 5-45_1 \cdot 5-455_{11} = 5-45_2 \cdot 5-455_{21} = 5-55_{12} \cdot 45-45_1 = 5-55_{22} \cdot 45-45_2.$$

An element belongs to $\text{Ann}_H(\tilde{\omega})$ if and only if in its expression in terms of the canonical generators and dual elements coefficients at $4\text{-}5^*$ and $5\text{-}45_1$, $5\text{-}45_2$, $5\text{-}455_{11}$, $5\text{-}455_{21}$, $5\text{-}55_{12}$, $5\text{-}55_{22}$, $45\text{-}45_1$ and $45\text{-}45_2$ are zero.

Let $x = \sum_{\beta} (\varphi(\beta)\beta + \varphi(\beta^*)\beta^*)$ be the expression of an element $x \in H^*(\mathcal{Z}_P, \mathbb{Q})$ in terms of generators and dual elements. We have

$$\begin{aligned} x = & x_1 + \varphi(4\text{-}4_1^*)4\text{-}4_1^* + \varphi(5\text{-}55_{11})5\text{-}55_{11} + \varphi(5\text{-}55_{12})5\text{-}55_{12} + \varphi(5\text{-}455_{11})5\text{-}455_{11} + \varphi(5\text{-}455_{12})5\text{-}455_{12} + \\ & + \varphi(4\text{-}4_2^*)4\text{-}4_2^* + \varphi(5\text{-}55_{21})5\text{-}55_{21} + \varphi(5\text{-}55_{22})5\text{-}55_{22} + \varphi(5\text{-}455_{21})5\text{-}455_{21} + \varphi(5\text{-}455_{22})5\text{-}455_{22} + \\ & + \varphi(4\text{-}5^*)4\text{-}5^* + \varphi(5\text{-}45_1)5\text{-}45_1 + \varphi(5\text{-}45_2)5\text{-}45_2 + \varphi(45\text{-}45_1)45\text{-}45_1 + \varphi(45\text{-}45_2)45\text{-}45_2, \end{aligned}$$

where x_1 is a linear combination of generators and dual elements having zero product with $4\text{-}4_1$, $4\text{-}4_2$, and $4\text{-}5$. Also $\alpha = 4\text{-}5 + \lambda_1 4\text{-}4_1 + \lambda_2 4\text{-}4_2$. We have

$$\begin{aligned} 5\text{-}455 \cdot 4\text{-}4 &= 45\text{-}45 \cdot 4\text{-}5 = -5\text{-}55^*; \\ 5\text{-}55 \cdot 4\text{-}4 &= 5\text{-}45 \cdot 4\text{-}5 = -5\text{-}455^*; \\ 5\text{-}455 \cdot 4\text{-}5 &= -5\text{-}45^*; \\ 5\text{-}55 \cdot 4\text{-}5 &= -45\text{-}45^*. \end{aligned}$$

Therefore,

$$\begin{aligned} -x \cdot \alpha = & [\varphi(4\text{-}5^*) + \varphi(4\text{-}4_1^*)\lambda_1 + \varphi(4\text{-}4_2^*)\lambda_2] [\mathcal{Z}_P] + \\ & + \varphi(5\text{-}455_{11})\lambda_1 5\text{-}55_{11}^* + [\varphi(5\text{-}455_{12})\lambda_1 + \varphi(45\text{-}45_1)] 5\text{-}55_{12}^* + \\ & + [\varphi(5\text{-}55_{11})\lambda_1 + \varphi(5\text{-}45_1)] 5\text{-}455_{11}^* + \varphi(5\text{-}55_{12})\lambda_1 5\text{-}455_{12}^* + \\ & + \varphi(5\text{-}455_{21})\lambda_2 5\text{-}55_{21}^* + [\varphi(5\text{-}455_{22})\lambda_2 + \varphi(45\text{-}45_2)] 5\text{-}55_{22}^* + \\ & + [\varphi(5\text{-}55_{21})\lambda_2 + \varphi(5\text{-}45_2)] 5\text{-}455_{21}^* + \varphi(5\text{-}55_{22})\lambda_2 5\text{-}455_{22}^* + \\ & + \varphi(5\text{-}455_{11})5\text{-}45_1^* + \varphi(5\text{-}455_{21})5\text{-}45_2^* + \varphi(5\text{-}55_{12})45\text{-}45_1^* + \varphi(5\text{-}55_{22})45\text{-}45_2^*. \end{aligned}$$

Thus, $x \cdot \alpha = 0$ if and only if

$$\begin{aligned} 0 = & \varphi(5\text{-}455_{11}) = \varphi(5\text{-}455_{21}) = \varphi(5\text{-}55_{12}) = \varphi(5\text{-}55_{22}) = \\ & = \varphi(5\text{-}55_{12})\lambda_1 = \varphi(5\text{-}455_{11})\lambda_1 = \varphi(5\text{-}55_{22})\lambda_2 = \varphi(5\text{-}455_{21})\lambda_2 = \\ & = \varphi(5\text{-}455_{12})\lambda_1 + \varphi(45\text{-}45_1) = \varphi(5\text{-}55_{11})\lambda_1 + \varphi(5\text{-}45_1) = \\ & = \varphi(5\text{-}455_{22})\lambda_2 + \varphi(45\text{-}45_2) = \varphi(5\text{-}55_{21})\lambda_2 + \varphi(5\text{-}45_2) = \\ & = \varphi(4\text{-}5^*) + \varphi(4\text{-}4_1^*)\lambda_1 + \varphi(4\text{-}4_2^*)\lambda_2. \end{aligned}$$

This is equivalent to 9 linearly independent equations:

$$\begin{aligned} \varphi(5\text{-}455_{11}) &= 0; & \varphi(5\text{-}455_{21}) &= 0; & \varphi(5\text{-}55_{12}) &= 0; & \varphi(5\text{-}55_{22}) &= 0; \\ \varphi(45\text{-}45_1) &= -\varphi(5\text{-}455_{12})\lambda_1; & \varphi(5\text{-}45_1) &= -\varphi(5\text{-}55_{11})\lambda_1; \\ \varphi(45\text{-}45_2) &= -\varphi(5\text{-}455_{22})\lambda_2; & \varphi(5\text{-}45_2) &= -\varphi(5\text{-}55_{21})\lambda_2; \\ \varphi(4\text{-}5^*) &+ \varphi(4\text{-}4_1^*)\lambda_1 + \varphi(4\text{-}4_2^*)\lambda_2 & &= 0. \end{aligned}$$

Thus, $\text{codim Ann}_H(\alpha) = 9 = \text{codim Ann}_H(\tilde{\omega})$. □

9. ACKNOWLEDGEMENTS

The author is grateful to Victor Buchstaber for his encouraging support and attention to this work, and Donald Stanley for a fruitful discussion. He is grateful to the Fields Institute for Research in Mathematical Sciences (Canada) for providing excellent research conditions and support while working on this paper at the Thematic Program on Toric Topology and Polyhedral Products.

REFERENCES

- [A70a] E.M. Andreev, *On convex polyhedra in Lobachevskii spaces*, Math. USSR-Sb, 10:3 (1970), 413–440.
- [A70b] E.M. Andreev, *On convex polyhedra of finite volume in Lobachevskii space*, Math. USSR-Sb. 12:2 (1970), 255–259.
- [B74] D. Barnette, *On generation of planar graphs*, Discrete Mathematics. 7:(3-4) (1974) 199–208.
- [B1913] G.D. Birkhoff, *The Reducibility of Maps*, American Journal of Mathematics. 1913. V. 35, N 2. P. 115–128.
- [BGGMTW05] G. Brinkmann, S. Greenberg, C. Greenhill, B.D. McKay, R. Thomas, P. Wollan, *Generation of simple quadrangulations of the sphere*, Discrete Mathematics. 305 (2005), 33–54.
- [B17] F. Bosio, *Two transformations of simple polytopes preserving moment-angle manifolds*, arXiv:1708.00399v1.
- [BE15] V.M. Buchstaber, N.Yu. Erokhovets, *Truncations of Simple Polytopes and Applications*, Proc. Steklov Inst. Math., 2015. V. 289. P. 104–133.
- [BE17S] V.M. Buchstaber, N.Yu. Erokhovets, *Fullerenes, Polytopes and Toric Topology*, In Volume 35 Combinatorial and Toric Homotopy: Introductory Lectures of Lect. Notes Ser. Inst. Math. Sci. Natl. Univ. Singap.; World Sci. Publ.: River Edge, NJ, USA, 2017; P. 67–178, arXiv: math.CO/160902949.
- [BE17I] V.M. Buchstaber, N.Yu. Erokhovets, *Construction of families of three-dimensional polytopes, characteristic patches of fullerenes and Pogorelov polytopes*, Izvestiya: Mathematics, **81**:5 (2017).
- [BEMPP17] V.M. Buchstaber, N.Yu. Erokhovets, M. Masuda, T.E. Panov, S. Park, *Cohomological rigidity of manifolds defined by right-angled 3-dimensional polytopes*, Russian Math. Surveys. 2017. V. 72, N. 2. P. 199–256. arXiv:1610.07575v3.
- [BP15] V.M. Buchstaber, T. E. Panov, *Toric topology*, Math. Surveys Monogr. V. 204, Amer. Math. Soc.: Providence, RI, USA, 2015.
- [CLMP20] Y. Cho, E. Lee, M. Masuda, S. Park, *Unique toric structure on a Fano Bott manifold*, ArXiv: 2005.02740v1.
- [DJ91] M.W. Davis and T. Januszkiewicz, *Convex polytopes, Coxeter orbifolds and torus actions*, Duke Math. J. **62** (1991), no. 2, 417–451.
- [D98] T. Dösljić, *On lower bounds of number of perfect matchings in fullerene graphs*, J. Math. Chem. 1998. V. 24, N 4. P. 359–364.
- [D03] T. Dösljić, *Cyclical edge-connectivity of fullerene graphs and $(k, 6)$ -cages*, J. Math. Chem. 2003. V. 33, N 2. P. 103–112.
- [FMW15] F. Fan, J. Ma, X. Wang, *B-Rigidity of flag 2-spheres without 4-belt*, arXiv:1511.03624.
- [FW15] F. Fan and X. Wang *On the cohomology of moment-angle complexes associated to Gorenstein* complexes*, Preprint (2015); arXiv:1508.00159v1.
- [FMW20] F. Fan, J. Ma, X. Wang, *Some rigidity problems in toric topology: I*, arXiv:2004.03362v2.
- [FMW20b] F. Fan, J. Ma, X. Wang, *Some rigidity problems in toric topology: II*, In preparation.

- [E19] N.Yu. Erokhovets, *Three-dimensional right-angled polytopes of finite volume in the Lobachevsky space: combinatorics and constructions*, Proc. Steklov Inst. Math., **305** (2019), 78–134.
- [E20b] N. Erokhovets, *B-rigidity of ideal almost Pogorelov polytopes*, arXiv:2005.07665v3.
- [K69] A. Kotzig, *Regularly connected trivalent graphs without non-trivial cuts of cardinality 3*, Acta. Fac. Rerum Natur. Univ. Comenian. Math. Publ. 1969. V. 21, P. 1-14.
- [P67] A.V. Pogorelov, *A regular partition of Lobachevskian space*, Math. Notes. 1:1 (1967), 3–5.
- [R96] I. Rivin, *A characterization of ideal polyhedra in hyperbolic 3-space*, Ann. of Math., Second Series. 1996. V. 143, N 1. P. 51–70.
- [T98] W.P. Thurston, *Shapes of polyhedra and triangulations of the sphere*, Geometry and Topology Monographs, **1** (1998), 511–549.
- [V87] A.Yu. Vesnin, *Three-dimensional hyperbolic manifolds of Löbell type*, Siberian Mathematical Journal, 28:5 (1987), 731–734.
- [V17] A.Yu. Vesnin, *Right-angled polyhedra and hyperbolic 3-manifolds*, Russian Math. Surveys, 72:2 (2017), 335–374.
- [VE20] A. Yu. Vesnin, A. A. Egorov, *Ideal right-angled polyhedra in Lobachevsky space*, Chebyshevskii sbornik, 21:2 (2020), 65–83.
- [V15] V.D. Volodin, *Combinatorics of flag simplicial 3-polytopes*, Russian Math. Surveys. 2015. V. 70, N 1, P. 168–170.

DEPARTMENT OF MECHANICS AND MATHEMATICS, MOSCOW STATE UNIVERSITY, 119992 MOSCOW, RUSSIA

E-mail address: `erochovetsn@hotmail.com`