

Feedback game on Eulerian graphs

Naoki Matsumoto* and Atsuki Nagao†

Abstract

In this paper, we introduce a two-player impartial game on graphs, called a *feedback game*, which is a variant of the generalized geography. The feedback game can be regarded as the undirected edge geography with an additional rule that the first player who goes back to the starting vertex wins the game. We consider the feedback game on Eulerian graphs since the game ends only by going back to the starting vertex. We first show that deciding the winner of the feedback game on Eulerian graphs is PSPACE-complete in general even if its maximum degree is at most 4. In the latter half of the paper, we discuss the feedback game on two subclasses of Eulerian graphs, triangular grid graphs and toroidal grid graphs.

Keywords: Feedback game; Edge geography; Eulerian graph; Triangular grid graph; Toroidal grid graph.

AMS 2010 Mathematics Subject Classification: 05C57, 05C45, 91A43, 91A46.

1 Introduction

All graphs considered in this paper are finite, loopless and undirected unless otherwise mentioned. A graph G is *Eulerian* if each vertex of G has even degree. For other basic terminology in graph theory, we refer to [6].

In combinatorial game theory, an impartial game has been well studied for a long time. So far, many interesting impartial graphs have been found; e.g., Nim [4], Kayles [8] and Poset game [16]. The most famous result in this area is the Sprague-Grundy theorem [12, 17] stating that every impartial game (under the normal play convention) is equivalent to the Grundy value (or Nimber) which plays an important role to determine whether the player can win the game from a given position. There are also many interesting games played on graphs; Vertex Nim [7], Ramsey game [9], Voronoi game [18] and so on. For more details and other topics, we refer the reader to survey several books and articles [1, 2, 3, 5].

One of most popular impartial games on graphs is the generalized geography. The *generalized geography* is a two-player game played on a directed graph D whose vertices are words and $xy \in A(D)$ if and only if the end character of a word x is the first one of y ,

*Research Institute for Digital Media and Content, Keio University, Kanagawa, Japan, E-mail: naoki.matsumo10@gmail.com

†Ochanomizu University, Tokyo, Japan. E-mail: a-nagao@is.ocha.ac.jp

where $A(D)$ is the set of arcs of D . For example, if x is “Japan” and y is “Netherlands”, then $xy \in A(D)$ but $yx \notin A(D)$. In this setting, the game begins from some starting word and both players alternately extend a directed path using unused words. The first player unable to extend the directed path loses. It is known that deciding the winner of the generalized geography is PSPACE-complete [14]. Moreover, several variants of the generalized geography have been considered, e.g., the planar generalized geography [14], edge geography [15] and undirected geography [11]. It is also known that for each above variant, the decision problem which player wins the game is PSPACE-complete in general, except the undirected vertex geography.

In this paper, we consider a new impartial game on a graph, called a *feedback game*, which is a variant of the undirected edge geography. (We sometimes call it a *game* for the simplicity of the paper.)

Definition 1 (Feedback game). *There are two players; Alice and Bob, starting with Alice. For a given connected graph G with a starting vertex s , a token is put on s . They alternately move the token on a vertex u to a neighbor v of u and then delete an edge uv . The first player who able to move the token back to s or to an isolated vertex (after removing an edge used by the last move) wins the game.*

In this paper, we investigate the feedback game on Eulerian graphs. Note that if a given connected graph G is Eulerian, then the game does not end until the token goes back to the starting vertex s , and further observe that Bob always wins the feedback game on any connected bipartite Eulerian graph (cf. [11]): Let G be a connected bipartite Eulerian graph, and so, all vertices of G are properly colored by two colors, black and white. Without loss of generality, we may suppose that the starting vertex is colored by black. Throughout the game on G , a token is always moved to a white (resp., black) vertex by Alice (resp., Bob). Thus Bob necessarily wins the game.

On the other hand, for a given connected Eulerian graph G , the decision problem which player wins the feedback game on G is PSPACE-complete even if the maximum degree of G is at most 4 (Theorem 3). Therefore, a main study on the feedback game is to determine the winner of the game on a connected Eulerian graph with more additional restrictions.

The remaining of the paper is organized as follows. In the next section, we prove the PSPACE-completeness of the feedback game. In Section 3, we introduce an *even kernel* (resp., an *even kernel graph*), first introduced in [11], which is an useful subset (resp., subgraph) guaranteeing the existence of a winning strategy of the second player. In Sections 4 and 5, focusing on *triangular grid graphs* and *toroidal grid graphs*, we determine the winner of the feedback game on several subclasses of them.

2 Complexity of the feedback game

Because the feedback game can be seen as a variant of the undirected edge geography, it is a simple idea to construct a reduction from the undirected edge geography to the feedback game.

Definition 2 (Undirected/Directed edge geography). *There are two players; Alice and Bob, starting with Alice. For a given connected undirected/directed graph G with a starting vertex s , a token is put on s . They alternately move the token on a vertex u to a neighbor/out-neighbor v of u and then delete an edge/arc uv . The first player who able to move the token to an isolated vertex (after removing an edge/arc used by the last move) wins the game.*

The directed edge geography is known as PSPACE-complete [15] via a reduction from TQBF, and the undirected edge geography is also known as PSPACE-complete [11] via a reduction from the directed edge geography. Here TQBF (true quantified Boolean formula) is, given a quantified formula, the determination of whether there exists an assignment to the input variables such that the formula shows 1.

The feedback game is different from these edge geographies on the winning rule. Since a player wins when a token reaches the starting vertex, it is difficult to reduce from an instance of undirected edge geographies to that of the feedback game. To avoid this difficulty we use the same idea about reduction from TQBF to the directed edge geography, and add a gadget before making the graph undirected.

Theorem 3. *It is PSPACE-complete to determine whether there exists a strategy that the first player wins a feedback game, even if the given graph is Eulerian.*

Proof. We can see that this determination is in PSPACE, since we can check the winner using a DFS-like algorithm that recurs $O(|E|)$ times and uses $O(|E|)$ spaces on each recursion.

Now we reduce any instance of TQBF to an instance of determining the winner on the feedback game. The first step is the same as the famous reduction from TQBF to the directed edge geography [15] and we obtain a graph H as an instance. Note that $\Delta(H) = 3$ [14], where $\Delta(H)$ denotes the maximum degree of H , and that the obtained graph H has only one vertex s with in-degree 0 and out-degree 2.

By the definition of the feedback game, the winner can also win in the view of the “directed version” of the feedback game on H . (Note that any player wins without going back to s ; the player wins only when the other cannot move anymore.) From now on, as shown in Figure 1, we use pseudo-arcs to make a reduction to the “undirected version” of the feedback game [11].

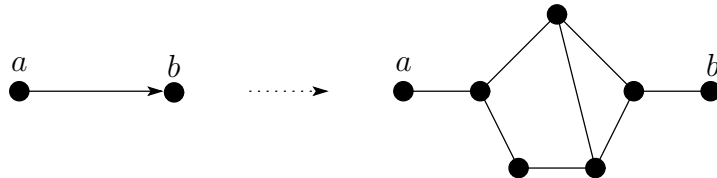

Figure 1: Replacing an arc with a pseudo-arc

We make the undirected graph H' obtained as above be Eulerian. Let $D = \{x_1, x_2, \dots, x_{2p}\}$ for $p \geq 1$ be the set of vertices in $V(H')$ of odd degree. First, we add a path abc and two edges as and cs , that is, $sabc$ forms a 4-cycle. Note that the first player does not use the edge sa nor sc at the start on the game; that immediately

leads to a suicide. Next, for each x_i where $1 \leq i \leq 2p$, we make a path $P_i = x_i y_i z_i$ of length 2 with adding two vertices y_i and z_i . Finally, we add edges $z_1 a, z_2 a, z_{2i-1} y_{2i-3}$ and $z_{2i} y_{2i-3}$, where $2 \leq i \leq p$. Clearly, the resulting graph G is Eulerian. Furthermore, it is not difficult to see that the winner of the feedback game on G is the same as that of H' ; note that the player who moves the token from a vertex x_i (which is an odd in H') to y_i loses the game. \square

Note that, a graph we obtain from these reductions has no vertex degree greater than 3. When we discuss Eulerian graphs, a graph can be added vertices and edges and can have vertices degree only 2 or 4. Thus, we obtain the following corollary.

Corollary 4. *It is PSPACE-complete to determine whether there exists a strategy that the first player wins a feedback game, even if the given graph is a connected graph with maximum degree at most 3 or a connected Eulerian graph with maximum degree at most 4.*

3 Even kernel graph

Remember that Bob wins the feedback game on every connected bipartite Eulerian graph. Focusing on this fact, Fraenkel et al. [11] introduced a good concept, called an *even kernel*.

Definition 5 (Even kernel). *Let G be a connected graph with a starting vertex s . An even kernel of G with respect to s is a non-empty subset $S \subseteq V(G)$ such that*

1. $s \in S$,
2. no two elements of S are adjacent, and
3. every vertex not in S is adjacent to an even number (possibly 0) of vertices in S .

It is known in [10] that to find an even kernel of a given graph is NP-complete even if the graph is bipartite or its maximum degree is at most 3. To make the even kernel be easy to handle, we introduce a graph version concept of the even kernel, called an *even kernel graph*. For a graph G and two disjoint subsets $A, B \subseteq V(G)$, $E_G(A, B)$ denotes the set of edges between A and B (i.e., one of ends of the edge in the set belongs to A and the other belongs to B).

Definition 6 (Even kernel graph). *Let G be a connected Eulerian graph with a starting vertex s . An even kernel graph with respect to s is a bipartite subgraph H_s with the bipartition $V(H_s) = B \cup W$ and $E(H_s) = E_G(B, W)$, where B is an even kernel of G and W is a superset of the set $N_G(B) = \{v \in V(G) \setminus B : v \text{ is adjacent to a vertex } u \in B\}$.*

For example, see Figure 2. The right of the figure, the graph H_s , is an even kernel graph of the graph G with a starting vertex s . The bold lines are edges of H_s and dotted lines are ones in $E(G) \setminus E(H_s)$, and black vertices in B (where $s \in B$) and white ones in W . Observe that for every vertex $v \in B$, all edges incident to v in G belong to $E(H_s)$.

Remark. If G has an even kernel, then G always has an even kernel graph. In Figure 2, H_s is a spanning subgraph of G , but an even kernel graph is not necessarily spanning in

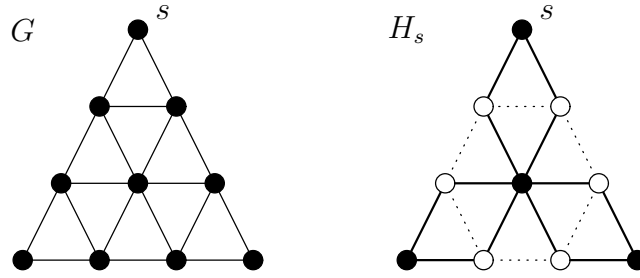

Figure 2: An even kernel graph H_s of a connected Eulerian graph G

general. Furthermore, the existence of even kernel graphs depends on the position of a starting vertex s . In fact, it is easy to see that the graph G shown in Figure 2 has no even kernel graph if its starting vertex is of degree 4.

By the definition, we see the existence of an even kernel (graph) of a connected Eulerian graph G guaranteeing that Bob wins the game on G .

Lemma 7 ([11]). *Let G be a connected graph with a starting vertex s . If G has an even kernel with respect to s , then Bob can win the game on G .*

We conclude this section with showing that the converse of Lemma 7 is not true even if G is Eulerian, that is, a connected Eulerian graph G does not necessarily have an even kernel graph even if Bob can win the game on G .

Proposition 8. *There exist infinitely many connected Eulerian graphs without an even kernel graph on which Bob wins the game (with respect to a prescribed starting vertex).*

Proof. We first give a construction of desired connected Eulerian graphs. Prepare two even cycles $C_{2k} = u_0u_1u_2 \dots u_{2k-1}$ and $C_{4k} = v_0v_1v_2 \dots v_{4k-1}$ for some $k \geq 2$. Add edges u_iv_{2i} and u_iv_{2i+1} for any $i \in \{0, 1, \dots, 2k-1\}$. Finally, we add a starting vertex s so that s and v_j are adjacent for any $j \in \{0, 1, \dots, 4k-1\}$. The resulting graph is denoted by G_k ; for example, see Figure 3.

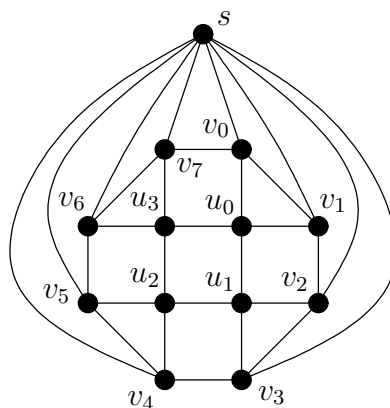

Figure 3: The graph G_2

We next show that Bob can win the game on G_k . Without loss of generality, we may suppose that Alice first moves the token to v_0 and that Bob moves it from v_0 to u_0 . If Alice

moves the token to v_1 , then Bob wins the game. Thus we may assume that Alice moves it to u_1 , and then Bob moves it to u_2 . After that, Alice (resp., Bob) moves the token from u_{2i} to u_{2i+1} (resp., from u_{2i+1} to u_{2i+2}), where subscripts are modulo $2k$. Therefore, Bob finally moves the token to u_0 , that is, Alice has to move it to v_1 . Thus, Bob wins the game on G_k .

Finally, we claim that G_k has no even kernel graph with respect to s . Suppose to the contrary that G_k has an even kernel graph H_s with bipartite sets B and W where $s \in B$. By the definition of an even kernel graph, $sv_i \in E(H_s)$ for all $i \in \{0, 1, \dots, 4k - 1\}$, that is, $v_i \in W$. Since H_s is bipartite, $v_i v_{i+1} \notin E(H_s)$ where subscripts are modulo $4k$. Thus all edges between two cycles C_{4k} and C_{2k} belong to $E(H_s)$, and hence, $u_j \in B$ for any $j \in \{0, 1, \dots, 2k - 1\}$. However, u_0 and u_1 must be adjacent in H_s , which contradicts the bipartiteness of H_s . \square

4 Triangular grid graphs

At first, we give a recursive definition of triangular grid graphs.

Definition 9 (Triangular grid graph). *A triangular grid graph T_n with $n \geq 0$ is recursively constructed as follows.*

- $T_0 (= P^0)$ consists of an isolated vertex v_0^0 and no edge.
- T_n with $n \geq 1$ is obtained from T_{n-1} by adding a path $P^n = v_0^n v_1^n \dots v_n^n$ and edges $v_0^n v_0^{n-1}$, $v_n^n v_{n-1}^{n-1}$, $v_i^n v_{i-1}^{n-1}$ and $v_i^n v_i^{n-1}$ for any $i \in \{1, \dots, n-1\}$.

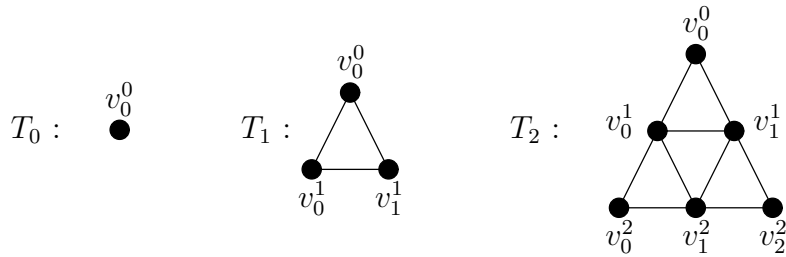

Figure 4: Triangular grid graphs T_0, T_1 and T_2

For example, see Figure 4. It is easy to see that every triangular grid graph is connected and Eulerian and that its maximum degree is at most 6. Moreover, it has high symmetry as we know. Thus the class of triangular grid graphs seems to be a reasonable subclass of connected Eulerian graphs for considering the feedback game.

For triangular grid graphs, we have the following setting v_0^0 as a starting vertex (where note that the vertex v_0^0 can be regarded as v_0^n and v_n^n by symmetry).

Theorem 10. *If $n \neq 2^m - 3$ with $m \geq 2$, then Bob wins the game on the triangular grid graph T_n with a starting vertex v_0^0 .*

Proof. We prove the theorem by induction on n . For the base case, we can easily find that each of T_2 (the left of Figure 6), T_3 (the right of Figure 2), T_4, T_6 (Figure 5) has at

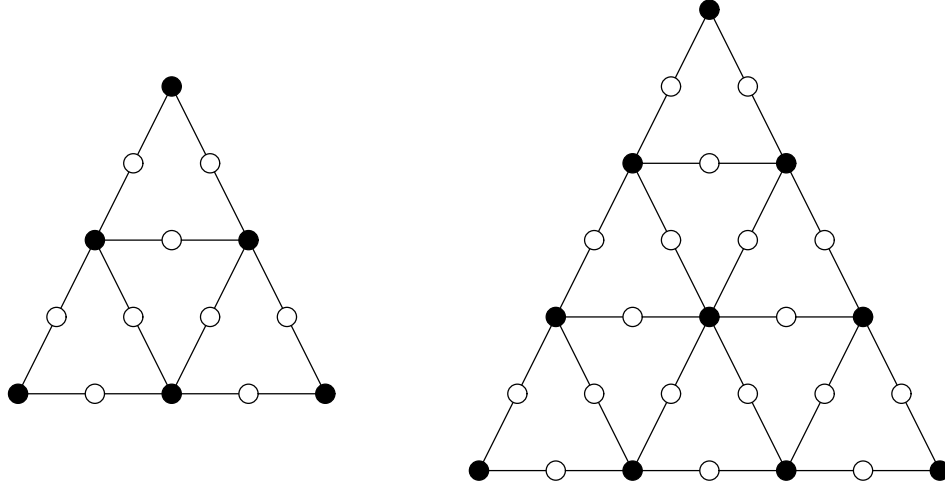

Figure 5: Even kernel graphs of T_4 and T_6

least one even kernel graph, i.e., Bob wins the game on these triangular grid graphs by Lemma 7.

For an induction rule, we assume that each of $T_{2^i-2}, T_{2^i-1}, \dots, T_{2^{i+1}-4}, T_{2^{i+1}-2}$ has at least one even kernel graph. Here we construct even kernel graphs on triangular grid graphs using those even kernel graphs. Using four even kernel graphs on T_α , we can construct an even kernel graph on $T_{2\alpha+3}$; for example, see Figure 6.

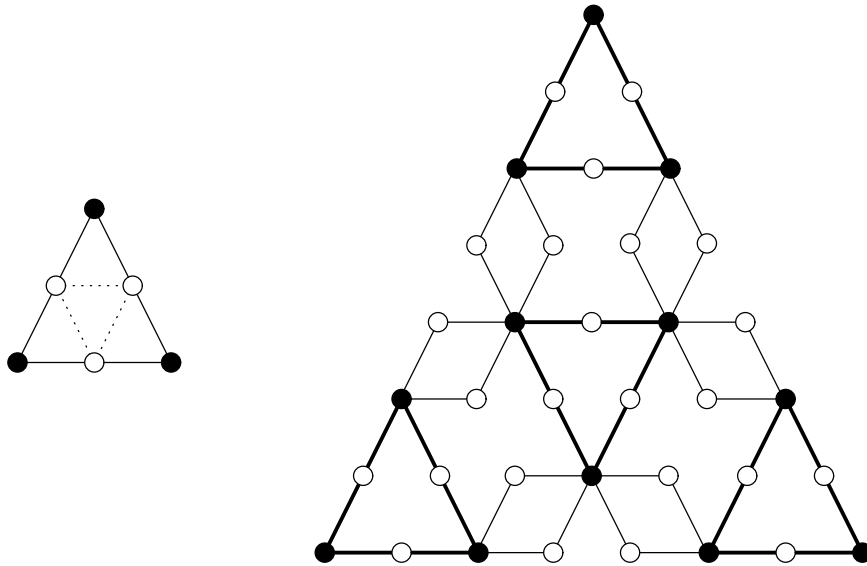

Figure 6: An even kernel graph H of T_2 and that of T_7 based on H

From the assumption and this fact, each of $T_{2^{i+1}-1}, T_{2^{i+1}+1}, \dots, T_{2^{i+2}-5}, T_{2^{i+2}-1}$ has at least one even kernel graph. For triangular grid graphs $T_{2^{i+1}-2}, T_{2^{i+1}}, \dots, T_{2^{i+2}-4}, T_{2^{i+2}-2}$, it is clear that they have an even kernel graph with bipartite sets $B = \{v_k^j : j \equiv k \equiv 0 \pmod{2}\}$ and $W = \{v_k^j : j \equiv 1 \pmod{2} \text{ or } k \equiv 1 \pmod{2}\}$ since their height is even (as shown in Figure 5); note that in every even kernel graph constructed above,

all vertices of degree 2 are in the same partite set. Then, all triangular grid graphs $T_{2^{i+1}-2}, T_{2^{i+1}-1}, \dots, T_{2^{i+2}-4}, T_{2^{i+2}-2}$ have at least one even kernel graph. By induction, all triangular grid graph T_n has at least one even kernel graph when $n \neq 2^m - 3$. This together with Lemma 7 leads to that Bob wins the game on T_n when $n \neq 2^m - 3$. \square

Theorem 10 shows that Bob can win the game when the starting vertex is v_0^0 . This is a common case, that is, we can see that every even kernel graphs in T_n must include v_0^0 .

Lemma 11. *There is no even kernel graph on T_n that does not include v_0^0 when $n > 1$.*

Proof. We prove the lemma by contradiction and induction on the distance of v_0^0 and another vertex. If an even kernel graph H does not include v_0^0 , then neither v_0^1 nor v_1^1 is contained in H by the definition. Therefore, all vertices whose distance from v_0^0 is 1 must not be in H .

Assume that no vertex whose distance from v_0^0 is at most k is in an even kernel graph H with bipartite sets B and W , where B contains a starting vertex, we can see that any v_i^{k+1} ($0 \leq i \leq k+1$) cannot be in B by definition; because any v_j^k ($0 \leq j \leq k$) is not a member of W from the assumption. If v_i^{k+1} is a member of W , by definition, v_i^{k+1} must have two or four edges in H . This condition and local restrictions show that both v_i^{k+2} and v_{i+1}^{k+2} are a member of B . This violates the definition for B . Therefore, v_i^{k+1} cannot be a member of W .

By induction on k , if H does not include v_0^0 , any vertex is not a member of H , a contradiction. Therefore, all even kernel graphs of T_n must includes v_0^0 . \square

For the case when $n = 2^m - 3$ with $m \geq 2$, we have checked that Alice wins the game on T_n with a starting vertex v_0^0 for small cases $n = 1, 5$. Furthermore, we confirm that there exists no even kernel graph of T_n if $n = 2^m - 3$ with $m \geq 2$, as follows.

Theorem 12. *If $n = 2^m - 3$ with $m \geq 2$, then there exists no even kernel graph of the triangular grid graph T_n .*

Proof. Suppose to the contrary that T_n has a even kernel graph H_n . From Lemma 11, any even kernel graph H_n of T_n contains v_0^0, v_0^n and v_n^n . Furthermore, these three vertices are in $B \subset V(H_n)$, which is a subset containing a starting vertex.

By symmetry, let i be the smallest number such that $v_0^{2i} \notin B$, i.e., if $v_{2j}^{2j} \notin B$ with $j < i$, then we relabel $v_0^k, v_1^k, \dots, v_k^k$ as $v_k^k, v_{k-1}^k, \dots, v_0^k$ for any $k \in \{1, 2, \dots, n\}$. Then v_0^1, \dots, v_0^{2i-1} are in W . By definition and local restrictions, it must be hold that $v_j^k \in B$ when j, k is even, otherwise $v_j^k \in W$. We say this pattern on $\Delta v_0^0 v_0^{2i-2} v_{2i-2}^{2i-2}$ close-packed or $\Delta v_0^0 v_0^{2i-2} v_{2i-2}^{2i-2}$ is called a *close-packed triangle*, where Δabc ($a, b, c \in V(T_n)$) denotes a triangular grid graph T_p for some $p \in \{0, 1, \dots, n\}$ which is contained in T_n as a subgraph.

Since v_0^{2i-1}, v_1^{2i-1} and v_0^{2i} are in W and $v_0^{2i-2} \in B$, we have $v_1^{2i} \in B$, and this leads to $v_1^{2i+1} \in W$ and $v_0^{2i+1} \in B$. Observe that $v_{2i}^{2i} \notin B$, since otherwise, v_2^{2i} is also in B by the observation in the second paragraph, which contradicts $v_1^{2i} \in B$. Moreover, with the similar observation, $v_{2i-1}^{2i}, v_{2i+1}^{2i+1} \in B$ and $v_{2i}^{2i+1} \in W$.

Two black vertices v_1^{2i} and v_{2i-1}^{2i} and white vertices v_j^{2i-1} , where $0 \leq j \leq 2i-1$, force that all $v_j^{2i} \in B$ if j is odd and all $v_j^{2i} \in W$ if j is even. By local restrictions, $\Delta v_1^{2i} v_{2i-1}^{2i} v_{2i-1}^{4i-2}$ is close-packed; note that $v_2^{2i+2}, v_{2i}^{2i+2} \notin B$, since if $v_2^{2i+2} \in B$ (resp., $v_{2i}^{2i+2} \in B$), then v_1^{2i+1}

(resp., v_{2i}^{2i+1}) in W must be of degree 3, a contradiction. Furthermore, $\Delta v_1^{2i} v_{2i-1}^{2i} v_{2i-1}^{4i-2}$ forces v_j^{2i+j} , where $0 \leq j \leq 2i-1$ and v_{2i}^{2i+j} , where $0 \leq j \leq 2i-1$ are in W . Note that whether v_{2i}^{4i} is in B or W is not revealed yet under above discussions. (Since the degree of a vertex in W may be zero, every vertex of T_n can be a member in $V(H_n)$.) Now we have:

1. White vertices v_j^{2i+j} , where $0 \leq j \leq 2i-1$, and black one v_0^{2i+1} generate a close-packed triangle $\Delta v_0^{2i+1} v_0^{4i-1} v_{2i-2}^{4i-1}$.
2. White vertices v_{2i}^{2i+j} , where $0 \leq j \leq 2i-1$, and black one v_{2i+1}^{2i+1} generate a close-packed triangle $\Delta v_{2i+1}^{2i+1} v_{2i+1}^{4i-1} v_{4i-1}^{4i-1}$.

These successive generation can stop if $n = 4i - 1$. If $n = 4i - 1$, H_n is constructed by four close-packed triangles. If $n < 4i - 1$, above generation are not satisfied. Therefore there does not exist such i under that n . Otherwise, $n > 4i - 1$, above generation must continue, as follows:

Two close-packed triangles $\Delta v_0^{2i+1} v_0^{4i-1} v_{2i-2}^{4i-1}$ and $\Delta v_{2i+1}^{2i+1} v_{2i+1}^{4i-1} v_{4i-1}^{4i-1}$ force that $v_j^{4i} \in W$, where $0 \leq j \leq 4i$ and $j \neq 2i$. We next focus on the fact that $v_{2i-1}^{4i-1}, v_{2i}^{4i-1}, v_{2i-1}^{4i}$ and v_{2i+1}^{4i} must be in W . This fact implies v_{2i}^{4i} cannot be a member of H_n since local constrains force $v_{2i-1}^{4i+1}, v_{2i+2}^{4i+1}, v_{2i+1}^{4i+2} \in B$. These new black vertices generate new three close-packed triangles $\Delta v_1^{4i+1} v_{2i-1}^{4i+1} v_{2i-1}^{6i-1}$, $\Delta v_{2i+1}^{4i+2} v_{2i+1}^{6i} v_{4i-1}^{6i}$ and $\Delta v_{2i+2}^{4i+1} v_{4i}^{4i+1} v_{4i}^{6i-1}$, and these new close-packed triangles force two extra close-packed triangles $\Delta v_0^{4i+2} v_0^{6i} v_{2i-2}^{6i}$, $\Delta v_{4i+2}^{4i+2} v_{4i+2}^{6i} v_{6i}^{6i}$. In this case, these successive generation can stop if $n = 6i$, and also this discussion can continue recursively if $n > 6i$.

Let r be the number of recursion on the above discussion, i.e., H_n contains r^2 close-packed triangles. By the hypothesis, there can exist such i on T_n if $n = r(2i + 1) - 3$, where $i, r \geq 1$, which implies that only if n can be represented as $n = r(2i + 1) - 3$, where $i, r \geq 1$, H_n can exist. Therefore, by the assumption that $n = 2^m - 3$, there must not exist an even kernel graph for T_n when $m > 1$ since 2^{m-j} cannot be represented as $2i + 1$ for any $i \geq 1$ and $j \leq m$, a contradiction. \square

Thus we propose the following conjecture which implies that for every triangular grid graph T_n with a starting vertex v_0^0 , Bob wins the game on T_n if and only if T_n contains an even kernel graph with respect to v_0^0 .

Conjecture 13. *If $n = 2^m - 3$ with $m \geq 2$, then Alice wins the game on the triangular grid graph T_n with a starting vertex v_0^0 .*

5 Toroidal grid graphs

In this section, we investigate the feedback game on toroidal grid graphs. The undirected edge geography on a grid graph (which is the Cartesian product of two paths) is completely solved [11], and the directed edge geography on a directed toroidal grid graph is also investigated in [13].

Definition 14 (Toroidal grid graph). A toroidal grid graph $Q(m, n)$ is the Cartesian product of two cycles $C_m = u_0u_1 \dots u_{m-1}$ and $C_n = v_0v_1 \dots v_{n-1}$ with $m \geq 2$ and $n \geq 2$, that is,

- $V(Q(m, n)) = \{(u_i, v_j) : i \in \{0, 1, \dots, m-1\}, j \in \{0, 1, \dots, n-1\}\}$.
- $(u_i, v_j)(u_{i'}, v_{j'}) \in E(Q(m, n))$ if and only if
 - $i = i'$ and $v_jv_{j'} \in E(C_n)$ or
 - $j = j'$ and $u_iu_{i'} \in E(C_m)$.

In other words, $Q(m, n)$ is a 4-regular *quadrangulation* embedded on the torus, which is a graph on a surface with each face quadrangular. For example, see Figure 7; by identifying the top and bottom (resp., right and left) sides along the direction of arrows, we have the toroidal grid graph $Q(3, 4)$. Note that $Q(m, n)$ is vertex-transitive, that is, there exists an automorphism of the graph mapping a vertex into any other vertex. Thus the feedback game on $Q(m, n)$ does not depend on the choice of a starting vertex, and hence, toroidal grid graphs seem to be a reasonable subclass of connected Eulerian graphs with maximum degree at most 4 for considering the feedback game.

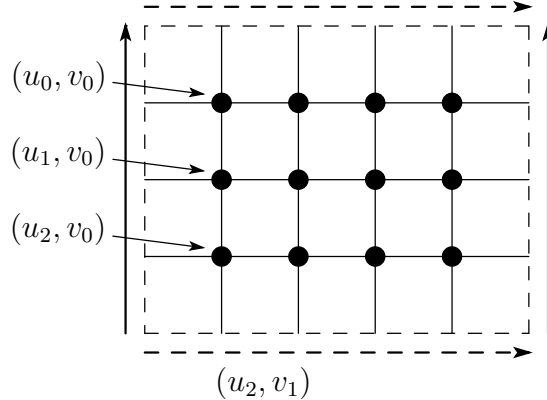

Figure 7: The toroidal grid graph $Q(3, 4)$

For several combinations of m and n , we have determined a winner of the game, as follows. In particular, if the greatest common divisor of m and n , denoted by $\gcd(m, n)$, is bigger than one, then Bob can win the game on $Q(m, n)$, and otherwise it seems to be that Alice can win the game.

Theorem 15. *If $\gcd(m, n) = c > 1$, then Bob can win the game on $Q(m, n)$.*

Proof. By the assumption, let $m = ck$ and $n = ck'$ for some positive integers k and k' . The toroidal grid graph $Q(c, c)$ with a starting vertex $s = (u_0, v_0)$ has an even kernel graph H^c with bipartite sets B and W such that $(u_i, v_i) \in B$, $(u_i, v_{i+1}), (u_{i+1}, v_i) \in W$ and edges $(u_i, v_i)(u_i, v_{i+1}), (u_i, v_i)(u_{i+1}, v_i), (u_i, v_{i+1})(u_{i+1}, v_{i+1})$ and $(u_{i+1}, v_i)(u_{i+1}, v_{i+1})$ are in $E(H^c)$ for any $i \in \{0, 1, \dots, c-1\}$, where subscripts are modulo c (see Figure 8).

Note that $Q(m, n)$ can be “covered” by $Q(c, c)$ ’s, and hence, we can obtain an even kernel graph of $Q(m, n)$ by combining that of $Q(c, c)$, as shown in Figure 9. (Figure 9 represents $Q(6, 9)$ covered by six $Q(3, 3)$ ’s with an even kernel graph shown in Figure 8.)

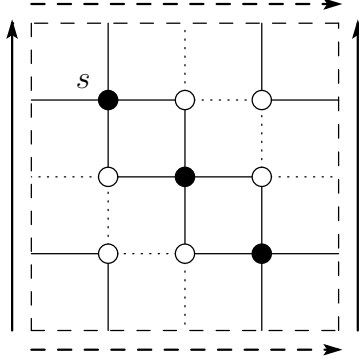

Figure 8: An even kernel graph of $Q(3, 3)$

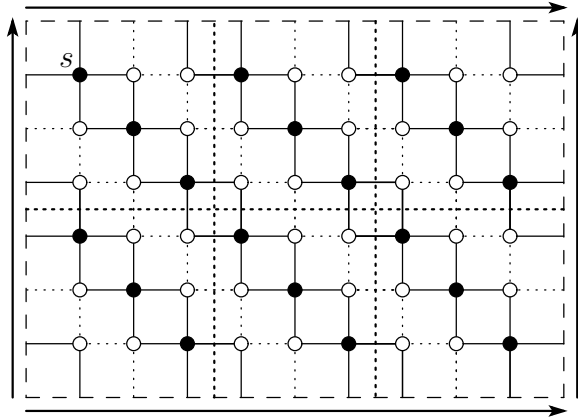

Figure 9: The toroidal grid graph $Q(6, 9)$ covered by $Q(3, 3)$'s with even kernel graphs

Therefore, since $Q(m, n)$ has an even kernel graph if $\gcd(m, n) = c > 1$, the theorem holds by Lemma 7. \square

Theorem 16. *If $\gcd(2, n) = 1$, then Alice can win the game on $Q(2, n)$.*

Proof. Without loss of generality, we set (u_0, v_0) be a starting vertex. Since $\gcd(2, n) = 1$, n is odd. Alice first moves the token to (u_0, v_1) . After that, Alice plays the game according to Bob's move as follows:

- (i) If Bob moves the token to (u_1, v_i) through an edge $(u_0, v_i)(u_1, v_i)$, Alice moves it to (u_0, v_i) using $(u_1, v_i)(u_0, v_i)$.
- (ii) If Bob moves the token to (u_0, v_{i+1}) , then Alice moves it to (u_0, v_{i+2}) , where subscripts modulo n .

Observe that the strategy (i) can be always applied and that after the strategy (i) is applied, Bob must move the token from (u_0, v_i) to (u_0, v_{i+1}) . Note that the index $i + 1$ is always even when Alice uses the strategy (ii). Therefore, since n is odd, Alice finally moves the token from (u_0, v_{n-1}) to (u_0, v_0) , that is, she wins the game. \square

Theorem 17. *If $\gcd(3, n) = 1$, then Alice can win the game on $Q(3, n)$.*

Proof. Without loss of generality, a starting vertex s is (u_0, v_0) . Moreover, by Theorem 16, we may assume that $n \geq 4$.

Alice first moves the token to (u_1, v_0) . If Bob moves it to (u_2, v_0) , then Alice wins the game. Thus Bob moves the token to (u_1, v_1) by symmetry and then Alice moves it to (u_2, v_1) . Next Bob has to move the token to (u_2, v_2) (otherwise Alice can move it back to s) and then Alice moves it to (u_0, v_2) . After that, Alice plays the game according to Bob's move until the token is moved to (u_i, v_{n-2}) for some $i \in \{0, 1, 2\}$ by herself, as follows (where i and j in the following are modulo 3 and n , respectively):

- (i) If Bob moves the token on (u_i, v_j) to (u_i, v_{j-1}) , then Alice moves it to (u_i, v_{j-2}) .
- (ii) If Bob moves the token on (u_i, v_j) to (u_{i+1}, v_j) , then Alice moves it to (u_{i+1}, v_{j-1}) .
- (iii) If Bob moves the token on (u_i, v_j) to (u_i, v_{j+1}) then Alice moves it to (u_{i+1}, v_{j+1}) .

Observe that in the above beginning moves from the starting vertex to (u_0, v_2) , Alice applies only the strategy (iii) twice except her first move.

In the strategy (i), after Alice's move, (u_i, v_{j-2}) is incident to the unique edge $(u_{i-1}, v_{j-2})(u_i, v_{j-2})$ unless $(u_i, v_{j-2}) = (u_0, v_0)$, since two edges $(u_i, v_{j-3})(u_i, v_{j-2})$ and $(u_i, v_{j-2})(u_{i+1}, v_{j-2})$ are used by the moves in (iii). Similarly, for the strategy (ii), (u_{i+1}, v_{j-1}) is incident to the unique edge $(u_i, v_{j-1})(u_{i+1}, v_{j-1})$. Thus, after Alice's move by the strategy (i) (resp., (ii)), Bob must move the token to (u_{i-1}, v_{j-2}) (resp., (u_i, v_{j-1})). Hereafter, Alice moves the token to (u_{i-1}, v_{j-3}) (resp., (u_i, v_{j-2})) and then the same situation occurs of the current vertex. Hence by applying the above move repeatedly, the token is finally carried to s from (u_0, v_1) by Alice.

Therefore, we may suppose that until Alice moves the token to (u_i, v_{n-2}) for some $i \in \{0, 1, 2\}$ by herself, she always applies the strategy (iii), that is, two indices i and j of a current vertex (u_i, v_j) are alternately increased one by one by Alice and Bob, respectively. Therefore, we may assume that Alice finally moves the token to (u_0, v_{n-2}) (resp., (u_1, v_{n-2})) from (u_2, v_{n-2}) (resp., (u_0, v_{n-2})) depending on n ; otherwise, i.e., if Alice finally moves the token (u_2, v_{n-2}) from (u_1, v_{n-2}) , then $n-2 \equiv 1 \pmod{3}$ and hence $n \equiv 0 \pmod{3}$, contrary to $\gcd(3, n) = 1$.

Thus the token is now put on (u_0, v_{n-2}) or (u_1, v_{n-2}) . In the former case, Bob moves to (u_0, v_{n-1}) and then Alice wins the game by moving it back to s . In the latter case, Bob moves to (u_1, v_{n-1}) and then Alice moves it to (u_1, v_0) . After that, since Bob must move the token to (u_2, v_0) , Alice wins the game by moving it from (u_2, v_0) to s . Therefore, the theorem holds. \square

Theorem 18. *If $\gcd(m, n) = 1$, then there exists no even kernel graph of $Q(m, n)$.*

Proof. Let $\text{Ev}(m, n) \subseteq Q(m, n)$ be an even kernel graph of $Q(m, n)$. From the definition, any vertex in the white part of $\text{Ev}(m, n)$, denoted by $W(m, n)$, has two or four neighbours¹ and they are in the black part of $\text{Ev}(m, n)$, denoted by $B(m, n)$. A *stopgap* of $\text{Ev}(m, n)$ is a vertex in $W(m, n)$ of degree 2 such that its neighbours lie on the same row or column. When we ignore all stopgaps, $\text{Ev}(m, n)$ has several components surrounded by vertices in $W(m, n)$. Note that any vertex in $B(m, n)$ cannot be adjacent to vertices not in $W(m, n)$.

¹A vertex in $W(m, n)$ can have no neighbour, but in this case we can remove it from $\text{Ev}(m, n)$.

We denote a component and stopgaps which are its neighbours (if exist) as a *cluster* (see Figure 10). In Figure 10, black vertices are in $B(m, n)$, gray vertices with bold circle are in $W(m, n)$, and gray vertices without edges are not in $\text{Ev}(m, n)$.

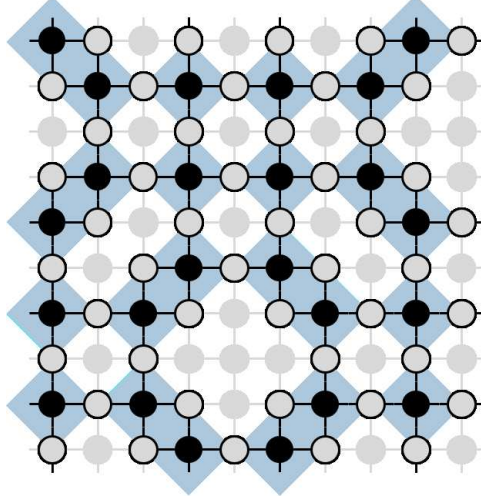

Figure 10: An even kernel graph $\text{Ev}(10, 10)$ of $Q(10, 10)$ and its clusters denoted by shaded regions

Every cluster looks a rectangle rotated 45 degrees. This means that a cluster has four sides consisting of diagonally consecutive vertices in $W(m, n)$. For clusters, we have following claims.

Claim 1. *Every clusters are rectangles unless $\text{Ev}(m, n) = Q(m, n)$.*

Proof. Assume that a cluster C is not a rectangle. Then there must exist a vertex in $W(m, n) \subset C$ which is not a stopgap, and is adjacent to a vertex not in $\text{Ev}(m, n)$ and odd number of vertices in $B(m, n)$ (since all vertices in $B(m, n)$ are of degree 4). This contradicts the definition of $\text{Ev}(m, n)$. \square

Claim 2. *Any component in $Q(m, n) \setminus \text{Ev}(m, n)$ induces a rectangular region.*

Proof. This follows from the similar discussion in the proof of Claim 1. (For an example of such regions, see a white region shown in Figure 10.) \square

Using these claims, $\text{Ev}(m, n)$ must be $Q(m, n)$ when $\gcd(m, n) = 1$ if exists. On the other hand, $Q(m, n)$ is not bipartite when $\gcd(m, n) = 1$. This contradicts the definition of $\text{Ev}(m, n)$. Therefore there exists no even kernel graph of $Q(m, n)$ if $\gcd(m, n) = 1$ \square

Under results obtained above, we conclude the paper with proposing the following conjecture which implies that Alice can win the feedback game on $Q(m, n)$ if and only if $\gcd(m, n) = 1$.

Conjecture 19. *Alice can win the game on $Q(m, n)$ if $\gcd(m, n) = 1$.*

Acknowledgement

We express our appreciation to Professor Shozo Okada with taking this opportunity, since the results in Section 4 are based on his document for a special class. We also appreciate Kazuki Kurimoto who is a graduate student in Kyoto Sangyo University, giving us a nice proof of the feedback game on the triangular grid T_5 .

References

- [1] B. Allen and M.A. Nowak, Games on graphs, *Eur. Math. Soc.* **1** (2014), 113–151.
- [2] C. Berge, Combinatorial games on a graph, *Discrete Math.* **151** (1996), 59–65.
- [3] E.R. Berlekamp, J.H. Conway and R.K. Guy, Winning Ways for Your Mathematical Plays, A K Peters/CRC Press, 4 vols. (1982 – 2004).
- [4] C.L. Bouton, Nim, a game with a complete mathematical theory, *Ann. of Math.* **3** (1901), 35–39.
- [5] J.H. Conway, On Numbers and Games, *A K Peters/CRC Press* (2000).
- [6] R. Diestel, Graph Theory (fifth edition), *Graduate Texts in Mathematics* **173**, Springer, 2016.
- [7] E. Duchêne and G. Renault, Vertex Nim played on graphs, *Theoret. Comput. Sci.* **516** (2014), 20–27.
- [8] H.E. Dudeney, The Canterbury puzzles, Dover, puzzle 73 (2002), 118–119 (Originally published in 1908).
- [9] P. Erdős and J.L. Selfridge, On a combinatorial game, *J. Combin. Theory Ser. A* **14** (1973), 298–301.
- [10] A.S. Fraenkel, Even kernels, *Electron. J. Combin.* **1** (1994), #R5.
- [11] A.S. Fraenkel, E.R. Scheinerman and D. Ullman, Undirected edge geography, *Theoret. Comput. Sci.* **112** (1993), 371–381.
- [12] P.M. Grundy, Mathematics and games, *Eureka* **2** (1939), 6–9.
- [13] M.S. Hogan and D.G. Horrocks, Geography played on an n -cycle times a 4-cycle, *Integers* **3** (2003), #G02.
- [14] D. Lichtenstein and M. Sipser, GO is Polynomial-Space Hard, *J. ACM* **27** (1980), 393–401.
- [15] T.J. Schaefer, On the complexity of some two-person perfect-information games, *J. Comput. System Sci.* **16** (1978), 185–225.

- [16] M. Soltys and C. Wilson, On the complexity of computing winning strategies for finite poset games, *Theory Comput. Syst.* **48** (2011), 680–692.
- [17] R.P. Sprague, Über mathematische Kampfspiele, *Tohoku Math. J.* **41** (1935), 438–444.
- [18] S. Teramoto, E.D. Demaine and R. Uehara, The Voronoi game on graphs and its complexity, *J. Graph Algorithms Appl.* **15** (2011), 485–501.

Appendix

Since it is clear that Alice wins the feedback game on T_1 , we shall prove that Alice wins the game on T_5 with starting vertex $s = v_0^0$.

Without loss of generality, Alice first moves the token to v_0^1 , and then Bob moves it to either (i) v_0^2 or (ii) v_1^2 . In the case (i) (resp., (ii)), Alice next moves the token to v_0^3 (resp., v_2^2). For the case (i), as shown the left of Figure 11, we can construct a “good” bipartite subgraph for Alice; note that Alice can move the token to a black vertex in the remaining game as in the argument of the even kernel. Therefore, Alice can finally move the token back to the starting vertex s .

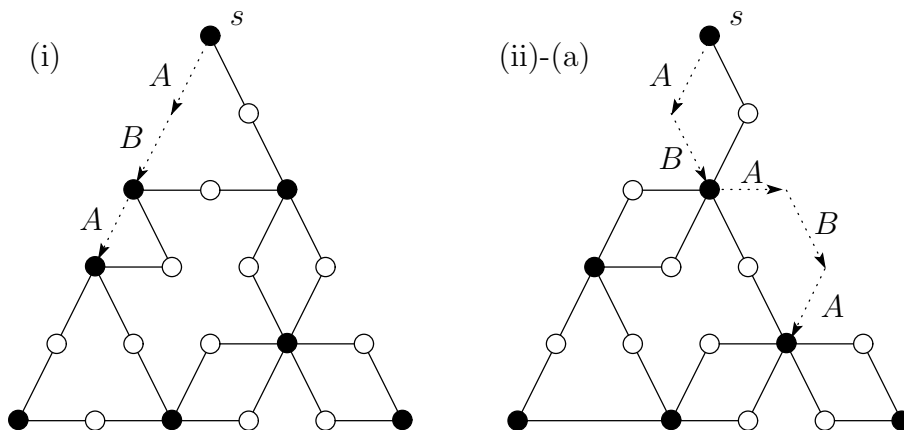

Figure 11: Good bipartite subgraphs for the cases (i) and (ii)-(a)

We divide the case (ii) to two subcases; (a) Bob moves the token to v_3^3 , or (b) he moves the token to v_2^2 . In the former case, as shown in the right of Figure 11, Alice wins the game similarly to the case (i). In the latter case, Alice moves the token to v_3^4 . If Bob moves the token to v_4^4 or v_4^5 , then Alice can move it back to v_3^4 along a 4-cycle $v_3^4 v_4^4 v_5^5 v_4^5$. Moreover, if Bob moves the token to v_3^3 , then Alice can win the game by moving it to v_2^2 (since Bob must move it to v_1^1 in his next move). Such a vertex u (to which a player loses the game by moving the token) is called a *dead vertex* (see Figure 12; a dead vertex is marked by ‘d’ and colored by gray). Thus Bob moves the token from v_3^4 to either (1) v_3^5 or (2) v_2^4 .

The proof of the case (1): Alice moves the token to v_2^5 . By observing that v_2^4 and v_1^5 are dead, Bob must move the token to v_1^4 , and then Alice moves it to v_0^3 . Since v_0^4 is also dead

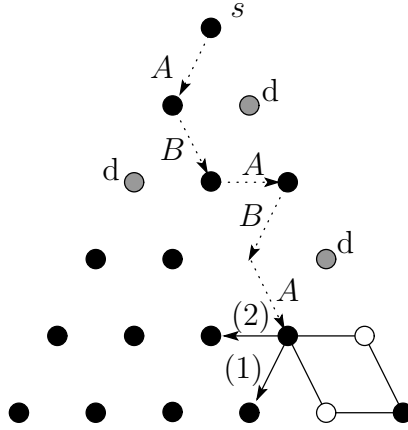

Figure 12: The case (ii)-(b)

now, Bob moves the token to v_1^3 . Therefore, Alice can force Bob to move the token to a dead vertex, by moving it from v_1^3 to v_1^4 .

The proof of the case (2): Alice moves the token to v_2^5 . Similarly to the previous case, Bob must move the token to v_1^4 since v_1^5 and v_3^5 are dead. After that, Alice can force Bob to move the token to a dead vertex by using one of the following two patterns (\rightarrow_A (resp., \rightarrow_B) means a move of the token by Alice (resp., Bob)):

1. $v_1^4 \rightarrow_A v_2^4 \rightarrow_B v_1^3 \rightarrow_A v_1^2 \rightarrow_B v_2^3 \rightarrow_A v_2^4$
2. $v_1^4 \rightarrow_A v_2^4 \rightarrow_B v_2^3 \rightarrow_A v_1^2 \rightarrow_B v_1^3 \rightarrow_A v_2^4$

Therefore, Alice wins the feedback game on the triangular grid graph T_5 .