

Closed-Loop Frequency Analysis of Reset Control Systems

Ali Ahmadi Dastjerdi, *Member, IEEE*, Alessandro Astolfi, *Fellow, IEEE*, Niranjan Saikumar, *Member, IEEE*, Nima Karbasizadeh, *Member, IEEE*, Duarte Valério, *Senior Member, IEEE* and S. Hassan HosseinNia, *Senior Member, IEEE*

Abstract—This paper introduces a closed-loop frequency analysis tool for reset control systems. To begin with sufficient conditions for the existence of the steady-state response for a closed-loop system with a reset element and driven by periodic references are provided. It is then shown that, under specific conditions, such a steady-state response for periodic inputs is periodic with the same period as the input. Furthermore, a framework to obtain the steady-state response and to define a notion of closed-loop frequency response, including high order harmonics, is presented. Finally, pseudo-sensitivities for reset control systems are defined. These simplify the analysis of this class of systems and allow a direct software implementation of the analysis tool. To show the effectiveness of the proposed analysis method the position control problem for a precision positioning stage is studied. In particular, comparison with the results achieved using methods based on the Describing Function shows that the proposed method achieves superior closed-loop performance.

Index Terms—Convergent, Frequency-Domain Analysis, Pseudo-Sensitivities, Reset Controllers.

I. INTRODUCTION

PROPORTIONAL Integral Derivative (PID) controllers are used in more than 90% of industrial control applications [1]–[3]. However, cutting-edge industrial applications have control requirements that cannot be fulfilled by PID controllers. To overcome this problem linear controllers may be substituted by non-linear ones. Reset controllers are one such non-linear controllers which have attracted attention due to their simple structure and their ability to improve closed-loop performance [4]–[20].

This paper is submitted for review on 24-11-2020. This work has been partially supported by NWO through OTP TTW project #16335, by the EACEA, by the European Union's Horizon 2020 Research and Innovation Programme under grant agreement No 739551 (KIOS CoE), and by the Italian Ministry for Research in the framework of the 2017 Program for Research Projects of National Interest (PRIN), Grant no. 2017YKXYXJ.

A. Ahmadi Dastjerdi, N. Saikumar, N. Karbasizadeh and S.H. HosseinNia are with Department of Precision and Microsystems Engineering, Delft University of Technology, Delft, The Netherlands, (e-mail: A.AhmadiDastjerdi@tudelft.nl, N.Saikumar@tudelft.nl, N.KarbasizadehEsfahani@tudelft.nl, S.H.HosseinNiaKani@tudelft.nl).

A. Astolfi is with the Department of Electrical and Electronic Engineering, Imperial College London, London, SW7 2AZ, UK and with the Dipartimento di Ingegneria Civile e Ingegneria Informatica, Università di Roma "Tor Vergata", Rome, 00133, Italy (e-mail: a.astolfi@imperial.ac.uk).

D. Valério is with faculty of IDMEC, Instituto Superior Técnico, Universidade de Lisboa, Lisboa, Portugal (duarte.valerio@tecnico.ulisboa.pt).

A traditional reset controller consists of a linear element the state of which is reset to zero when the input equals zero. The simplest reset element is the Clegg Integrator (CI), which is a linear integrator with a reset mechanism [4]. To provide design freedom and applicability, reset controllers such as First Order Reset Elements (FORE) [21], [22] and Second Order Reset Elements (SORE) have also been introduced [14]. These reset elements are utilized to construct new compensators to achieve significant performance enhancement [17], [23]–[27]. In order to further improve the performance of reset control systems several techniques, such as the considerations of non-zero reset values [9], [22], reset bands [28], [29], fixed reset instants, and $PI + CI$ configurations [30]–[32] have been introduced.

Frequency-domain analysis is preferred in industry since this allows ascertaining closed-loop performance measures in an intuitive way. However, the lack of such methods for non-linear controllers is one of the reasons why non-linear controllers are not widely popular in industry. The Describing Function (DF) method is one of the few methods for approximately studying non-linear controllers in the frequency-domain and this has been widely used also in the literature of reset controllers [9], [17], [27], [33]. The DF method relies on a quasi-linear approximation of the steady-state output of a non-linear system considering only the first harmonic of the Fourier series expansion of the input and output signals (assumed periodic). The general formulation of the DF method for reset controllers is presented in [33], which however does not provide any information on the closed-loop steady-state response.

In this paper, first, sufficient conditions for the existence of the steady-state response for a closed-loop system with a reset element and driven by a periodic input are given. Then, a notion of closed-loop frequency response for reset control systems, including high order harmonics, is introduced. Pseudo-sensitivities to combine harmonics and facilitate analyzing reset control systems in the closed-loop configuration are then defined. All of these ideas can be utilized to develop a toolbox which is briefly discussed. Furthermore, the method is used to analyze the performance of a precision positioning stage. Note finally that, contrary to the DF method, which provides only approximations for the periodic steady-state response of reset control systems, the proposed tools allow computing exact steady-state responses to periodic excitations.

The paper is organized as follows. Preliminaries on the frequency analysis for reset controllers are presented in Sec-

tion II. In Section III sufficient conditions to define a notion of frequency response are presented. Then, a method to obtain closed-loop frequency responses for reset control systems, including high order harmonics, is developed, and pseudo-sensitivities are defined. In Section IV the steady-state response of reset controllers to periodic inputs is studied. In Section V the performance of our proposed methods is assessed on an illustrative example. Finally, some concluding remarks and suggestions for future studies are given in Section VI.

II. PRELIMINARIES

In this section frequency-domain descriptions for reset controllers are briefly recalled. The state-space representation of a reset element is given by equations of the form

$$\begin{cases} \dot{x}_r(t) = A_r x_r(t) + B_r r(t), & r(t) \neq 0, \\ x_r(t^+) = A_\rho x(t), & r(t) = 0, \\ u_r(t) = C_r x(t) + D_r r(t), \end{cases} \quad (1)$$

in which $x_r(t) \in \mathbb{R}^{n_r}$ is the reset states, $r(t) \in \mathbb{R}$ is an external signal, $u_r(t)$ is the control input, A_r , B_r , C_r and D_r are the dynamic matrices of the reset element, and A_ρ determines the value of the reset states after the reset action. The transfer function $C_r(sI - A_r)^{-1}B_r + D_r$ is called the base transfer function of the reset controller. To study the reset controller (1) in the frequency-domain one could use various approaches. For example, in order to find the DF, a sinusoidal reference $r(t) = a_0 \sin(\omega t)$, $\omega > 0$ is applied and the output is approximated by means of the first harmonic of the Fourier series expansion of the steady-state response (provided if exists). In order to have a well-defined steady-state response we assume that A_r has all eigenvalues with negative real part and $A_\rho e^{\frac{A_r \pi}{\omega}}$ has all eigenvalues with magnitude smaller than one [33]. In this case, the state-space representation of the reset element (1) can be re-written as

$$\begin{cases} \dot{x}_r(t) = A_r x_r(t) + a_0 B_r \sin(\omega t), & t \neq t_k, \\ x_r(t^+) = A_\rho x(t), & t = t_k, \\ u_r(t) = C_r x(t) + a_0 D_r \sin(\omega t), \end{cases} \quad (2)$$

with $\omega > 0$, in which $t_k = \frac{k\pi}{\omega}$, with $k \in \mathbb{N}$, are the reset instants. According to [33], the DF associated to system (2) is given by

$$\begin{aligned} \mathcal{N}_{DF}(\omega) &= \frac{a_1(\omega) e^{j\varphi_1(\omega)}}{a_0} \\ &= C_r(j\omega I - A_r)^{-1}(I + j\theta(\omega))B_r + D_r, \end{aligned} \quad (3)$$

where

$$\begin{aligned} \theta(\omega) &= \frac{-2\omega^2}{\pi} \left(I + e^{\frac{\pi A_r}{\omega}} \right) \left((I + A_\rho e^{\frac{\pi A_r}{\omega}})^{-1} A_\rho \left(I + e^{\frac{\pi A_r}{\omega}} \right) \right. \\ &\quad \left. - I \right) (\omega^2 I + A_r^2)^{-1}. \end{aligned} \quad (4)$$

Recently, a new tool, called Higher-Order Sinusoidal Input Describing Functions (HOSIDF), for studying non-linearities in the frequency-domain has been introduced in [34]. In this

method a non-linear system is considered as a virtual harmonic generator and the HOSIDF is defined as [34]:

$$H_n(j\omega) = \frac{a_n(\omega) e^{j\varphi_n(a_0, \omega)}}{a_0}, \quad (5)$$

in which $a_n(\omega)$ and $\varphi_n(a_0, \omega)$ are the n^{th} components of the Fourier series expansion of the steady-state output of the system to a sinusoidal input. This framework has been extended to the reset controller (1) in [35] and $H_n(j\omega)$ for this controller is obtained as

$$\begin{cases} C_r(j\omega I - A_r)^{-1}(I + j\theta(\omega))B_r + D_r, & n = 1, \\ C_r(jn\omega I - A_r)^{-1}j\theta(\omega)B_r, & n > 1 \text{ odd}, \\ 0, & n \text{ even}. \end{cases} \quad (6)$$

Note that the above frequency analysis is made simple by the fact that the reset instants are known, that is the reset controller is studied in the open-loop. Frequency properties of reset controllers as part of a closed-loop system in the presence of a periodic reference or disturbance input are much more difficult to study, and are the subject of the next section.

III. CLOSED-LOOP FREQUENCY RESPONSE OF RESET CONTROL SYSTEMS

Consider the single-input single-output (SISO) control architecture in the top diagram of Fig. 1. This includes as particular cases all schemes discussed in Section I. The closed-loop system consists of a linear plant with transfer function $G(s)$, two linear controllers with proper transfer function $C_{\Sigma_1}(s)$ and $C_{\Sigma_2}(s)$, and a reset controller with base transfer function $C_{\mathcal{R}}(s)$. Let \mathcal{L} be the LTI part of the system and assume that $G(s)$ is strictly proper. The state-space realization of \mathcal{L} is described by the equations

$$\mathcal{L} : \begin{cases} \dot{\zeta}(t) = A\zeta(t) + Bw(t) + B_u u_R(t), \\ u(t) = C_u \zeta(t) + D_u r(t), \\ e_R(t) = C_{e_R} \zeta(t) + D_{e_R} r(t), \\ y(t) = C\zeta(t), \end{cases} \quad (7)$$

where $\zeta(t) \in \mathbb{R}^{n_p}$ describes the states of the plant and of the linear controllers (n_p is the number of states of the linear part), A , B , C , B_u , C_{e_R} , C_u , D_u and D_{e_R} are the corresponding dynamic matrices, $y(t) \in \mathbb{R}$ is the output of the plant and $w(t) = [r(t) \ d(t)]^T \in \mathbb{R}^2$ is an external input. The state-space representation of the reset controller is given by the equations

$$\begin{cases} \dot{x}_r(t) = A_r x_r(t) + B_r e_R(t), & e_R(t) \neq 0, \\ x_r(t^+) = A_\rho x_r(t), & e_R(t) = 0, \\ u_R(t) = C_r x_r(t) + D_r e_R(t). \end{cases} \quad (8)$$

The closed-loop state-space representation of the overall system can, therefore, be written as

$$\begin{cases} \dot{x}(t) = \bar{A}x(t) + \bar{B}w(t), & e_R(t) \neq 0, \\ x(t^+) = \bar{A}_\rho x(t), & e_R(t) = 0, \\ u(t) = \bar{C}_u x(t) + \bar{D}_u r(t), \\ e_R(t) = \bar{C}_{e_R} x(t) + D_{e_R} r(t), \\ y(t) = \bar{C}x(t), \end{cases} \quad (9)$$

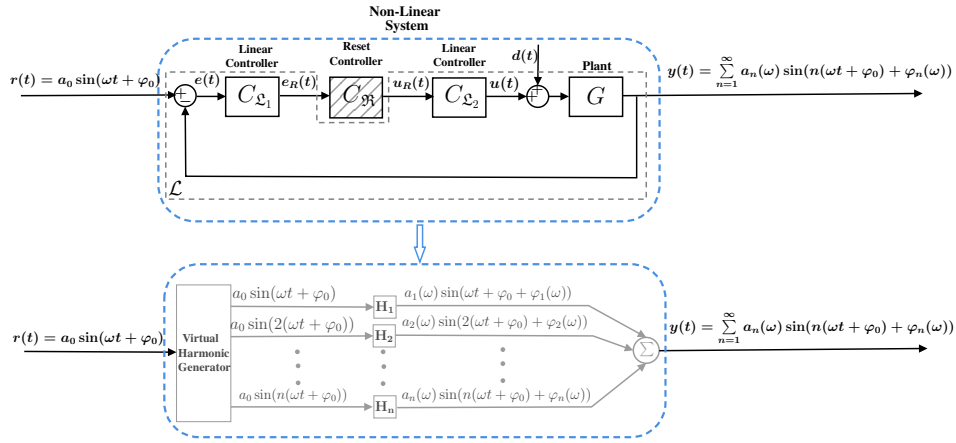

Fig. 1: Closed-loop architecture with reset controller (top). HOSIDF representation of the closed-loop configuration (bottom).

where $x(t) = [x_r(t)^T \quad \zeta(t)^T]^T \in \mathbb{R}^{n_p + n_r}$, and

$$\bar{A} = \begin{bmatrix} A_r & B_r C_{eR} \\ B_u C_r & A + B_u D_r C_{eR} \end{bmatrix}, \quad \bar{C} = [0_{1 \times n_r} \quad C], \quad \bar{B} = \begin{bmatrix} 0_{n_r \times 2} \\ B \end{bmatrix} + \begin{bmatrix} B_r D_{eR} & 0_{n_r \times 1} \\ B_u D_r D_{eR} & 0_{n_p \times 1} \end{bmatrix}, \quad \bar{A}_\rho = \begin{bmatrix} A_\rho & 0_{n_r \times n_p} \\ 0_{n_p \times n_r} & I_{n_p \times n_p} \end{bmatrix}, \\ \bar{C}_u = [C_r D_{\Sigma_2} \quad C_{eR} D_r D_{\Sigma_2} + C_u], \quad \bar{C}_{eR} = [0_{1 \times n_r} \quad C_{eR}], \quad \text{and } \bar{D}_u = D_u D_{eR} D_r \text{ with } D_{\Sigma_2} \text{ the feedthrough matrix of } C_{\Sigma_2}(s).$$

A. Stability and Convergence

In this section sufficient conditions for the existence of a steady-state solution for the closed-loop reset control system (9) driven by periodic inputs is provided. This is based on the H_β condition [5], [36]–[38], which we recall in what follows. Let

$$C_0 = [\rho \quad \beta C_{eR}], \quad B_0 = \begin{bmatrix} I_{n_r \times n_r} \\ 0_{n_p \times n_r} \end{bmatrix}, \quad (10) \\ \rho = \rho^T > 0, \quad \rho \in \mathbb{R}^{n_r \times n_r}, \quad \beta \in \mathbb{R}^{n_r \times 1}.$$

The H_β condition states that the reset control system (9) with $w = 0$ is quadratically stable if and only if there exist $\rho = \rho^T > 0$ and β such that the transfer function

$$H(s) = C_0(sI - \bar{A})^{-1} B_0 \quad (11)$$

is Strictly Positive Real (SPR), (\bar{A}, B_0) and (\bar{A}, C_0) are controllable and observable, respectively, and

$$A_\rho^T \rho A_\rho - \rho < 0. \quad (12)$$

Definition 1: A time $\bar{T} > 0$ is called a reset instant for the reset control system (9) if $e_R(\bar{T}) = 0$. For any given initial condition and input w the resulting set of all reset instants defines the reset sequence $\{t_k\}$, with $t_k \leq t_{k+1}$, for all $k \in \mathbb{N}$. The reset instants t_k of the reset control system (9) have the well-posedness property if for any initial condition x_0 and any input w , all reset instants are distinct, and there exists a $\lambda > 0$ such that for all $k \in \mathbb{N}$, $\lambda \leq t_{k+1} - t_k$ [9], [39].

Remark 1: If the H_β condition holds, then the reset control system (9) has the uniform bounded-input bounded-state (UBIBS) property and the reset instants have the well-posedness property [40]. Therefore, the reset control system (9) has a unique well-defined solution for $t \geq t_0$ for

any initial condition x_0 and input $w(t)$ which is a Bohl function [9], [39].

To develop a frequency analysis for the reset control system (9), the following assumption is required.

Assumption 1: The initial condition of the reset controller is zero. In addition, there are infinitely many reset instants and $\lim_{k \rightarrow \infty} t_k = \infty$.

The second term in Assumption 1 is introduced to rule out a trivial situation. In fact, if $\lim_{k \rightarrow \infty} t_k = T_K$, then for all $t \geq T_K$ the reset control system (9) is a stable linear system. Two important technical lemmas, which are used in the proof of the following theorem, are now formulated and proved.

Lemma 1: Let $\{t_k\}$ and $\{\tilde{t}_k\}$ be the reset sequences of the reset control system (9) for two different initial conditions ζ_0 and $\tilde{\zeta}_0$ of the linear part and for the same input. Suppose Assumption 1 and the H_β condition hold and w is a Bohl function. Then $\lim_{k \rightarrow \infty} (t_k - \tilde{t}_k) = 0$.

Proof: To begin with note that, for any initial condition $x_0 = [0^T \quad \zeta_0^T]^T$, the signal $e_R(t)$ in (9) can be obtained through the equation (see Lemma 3 in the Appendix)

$$\begin{cases} \dot{x}_I(t) = \bar{A}x_I(t) + \bar{B}w(t) + \begin{bmatrix} B_r \\ 0_{n_p \times 2} \end{bmatrix} w_I(t), & e_R(t) \neq 0, \\ x_I(t^+) = \bar{A}_\rho x_I(t), & e_R(t) = 0, \\ e_R(t) = \bar{C}_{eR} x_I(t) + D_{eR} r(t) + [1 \ 0] w_I(t), \end{cases} \quad (13)$$

with $x_I(0) = 0$ and

$$\begin{cases} \dot{Z}(t) = AZ(t), \\ w_I(t) = \begin{bmatrix} C_{eR} \\ 0 \end{bmatrix} Z(t), \end{cases} \quad Z(0) = \zeta_0. \quad (14)$$

Since the linear part of the system contains the internal model (14) of w_I , and $w(t)$ is a Bohl function, based on [5], [37] $e_R(t)$ is asymptotically independent of $w_I(t)$. This implies that $\lim_{k \rightarrow \infty} (t_k - \tilde{t}_k) = 0$. ■

Lemma 2: Consider the reset control system (9). Suppose Assumption 1 holds, w is a Bohl function, and the H_β

condition is satisfied. Then the reset control system (9) is uniformly exponentially convergent.

Proof: To begin with note that the property of uniformly exponentially convergence is as given in [41]. Since the H_β condition is satisfied, according to Remark 1, the reset control system (9) has a unique well-defined solution for any initial condition x_0 and any w which is a Bohl function. Let x and \tilde{x} be two solutions of the reset control system (9) corresponding to the same input w and to two different initial conditions. Since the H_β condition is satisfied $x(t)$ and $\tilde{x}(t)$ are bounded for all t . Let $\Delta x := x(t) - \tilde{x}(t)$, and let $\{t_k\}$ and $\{\tilde{t}_k\}$ be the reset sequences of $x(t)$ and $\tilde{x}(t)$. Define $\mathcal{M} = \{t \in \mathbb{R}^+ \mid t \neq t_k \wedge t \neq \tilde{t}_k\}$. By Lemma 1

$$\forall \delta > 0, \exists \Pi > 0 \text{ such that } k > \Pi \Rightarrow |t_k - \tilde{t}_k| < \delta. \quad (15)$$

Moreover, by the well-posedness property, there exists a $\lambda > 0$ such that $\lambda \leq t_{k+1} - t_k$ and $\lambda \leq \tilde{t}_{k+1} - \tilde{t}_k$. Thus, selecting δ sufficiently small yields

$$x(t_k + \delta) = e^{\bar{A}\delta} \bar{A}_\rho x(t_k) + \int_{t_k}^{t_k + \delta} e^{\bar{A}(t_k + \delta - \tau)} \bar{B} w(\tau) d\tau, \quad (16)$$

for all t_k sufficiently large. By (15), $\tilde{t}_k = t_k + \delta'$, with $0 \leq \delta' \leq \delta$. Thus

$$\begin{aligned} \tilde{x}(t_k + \delta) = & e^{\bar{A}(\delta - \delta')} \bar{A}_\rho \left(e^{\bar{A}\delta'} \tilde{x}(t_k) \right. \\ & + \int_{t_k}^{t_k + \delta'} e^{\bar{A}(t_k + \delta' - \tau)} \bar{B} w(\tau) d\tau \\ & \left. + \int_{t_k + \delta'}^{t_k + \delta} e^{\bar{A}(t_k + \delta - \tau)} \bar{B} w(\tau) d\tau. \right) \quad (17) \end{aligned}$$

Now, by (16) and (17)

$$\begin{aligned} \Delta x(t_k + \delta) = & \bar{A}_\rho \Delta x(t_k) + (e^{\bar{A}\delta} \bar{A}_\rho - e^{\bar{A}(\delta - \delta')} \bar{A}_\rho e^{\bar{A}\delta'}) \tilde{x}(t_k) \\ & - e^{\bar{A}(\delta - \delta')} \bar{A}_\rho \int_{t_k}^{t_k + \delta'} e^{\bar{A}(t_k + \delta' - \tau)} \bar{B} w(\tau) d\tau \\ & + \int_{t_k}^{t_k + \delta'} e^{\bar{A}(t_k + \delta - \tau)} \bar{B} w(\tau) d\tau \\ & + (e^{\bar{A}\delta} - I) \bar{A}_\rho \Delta x(t_k) \\ = & \bar{A}_\rho \Delta x(t_k) + O(\delta, \tilde{x}(t_k), x(t_k)), \quad (18) \end{aligned}$$

and, using (15),

$$\lim_{k \rightarrow \infty} O(\delta, \tilde{x}(t_k), x(t_k)) = 0. \quad (19)$$

The same discussion applies for \tilde{t}_k . Hence, for t sufficiently large we have

$$\begin{cases} \Delta \dot{x}(t) = \bar{A} \Delta x(t), & t \in \mathcal{M}, \\ \Delta x(t^+) = \bar{A}_\rho \Delta x(t), & t \notin \mathcal{M}. \end{cases} \quad (20)$$

Due to the satisfaction of the H_β condition [5], [36], [37], there exist a matrix $P \in \mathbb{R}^{(n_p + n_r) \times (n_p + n_r)}$, $P = P^T > 0$, and a scalar $\alpha > 0$ such that

$$P \bar{A} + \bar{A}^T P \leq -2\alpha P, \quad (21)$$

$$\bar{A}_\rho^T P \bar{A}_\rho - P \leq 0. \quad (22)$$

Using the candidate Lyapunov function $V(\Delta x) = \frac{1}{2}(\Delta x)^T P(\Delta x)$ yields

$$\begin{cases} \dot{V} \leq -\alpha V, & t \in \mathcal{M}, \\ V(\Delta x(t^+)) = V(\Delta x(t)) + \Xi(t, \delta), & t \notin \mathcal{M}. \end{cases} \quad (23)$$

Thus, using (20) and (22) for t sufficiently large yields

$$\Xi(t, \delta) \leq 0. \quad (24)$$

Hence, since Δx is bounded, there exist $\alpha_m > 0$ and $\mathcal{K} > 0$ such that

$$\|x_2(t) - x_1(t)\|_P^2 \leq \mathcal{K} e^{-\alpha_m t}, \quad (25)$$

for all $t \geq 0$ (see Lemma 4 in the Appendix). This implies that the reset control system (9) is uniformly exponentially convergent. ■

Theorem 1: Consider the reset control system (9). Suppose Assumption 1 holds, $w(t) = w_0 \sin(\omega t)$ ¹, and the H_β condition is satisfied. Then the reset control system (9) has a periodic steady-state solution which can be expressed as $\bar{x}(t) = \mathcal{S}(\sin(\omega t), \cos(\omega t), \omega)$ for some function $\mathcal{S} : \mathbb{R}^3 \rightarrow \mathbb{R}^{n_r + n_p}$.

Proof: Since the H_β condition holds and $w(t) = w_0 \sin(\omega t)$ is a Bohl function, by Remark 1 the reset control system (9) has a unique solution for any initial condition x_0 . In addition, the reset control system (9) has the UBIBS property and, according to Lemma 2, it is uniformly exponentially convergent. Hence, the proof of the existence of the function \mathcal{S} relies on the results in [41]. We only need to show that \mathcal{S} is unique. To this end, similarly to [42], assume that the reset control system (9) has two steady-state solutions $\bar{x}_2(t) = \mathcal{S}_2(\sin(\omega t), \cos(\omega t), \omega)(t)$ and $\bar{x}_1(t) = \mathcal{S}_1(\sin(\omega t), \cos(\omega t), \omega)(t)$, for $w(t) = w_0 \sin(\omega t)$. Since the H_β condition holds, by Lemma 2 there exist $\alpha_m > 0$ and $\mathcal{K} > 0$ such that

$$\|\bar{x}_2(t) - \bar{x}_1(t)\|_P^2 \leq \mathcal{K} e^{-\alpha_m t}, \quad (26)$$

hence, the claim. ■

Corollary 1: Consider the reset control system (9) with $r(t) = r_0 \sin(\omega t)$ and $d = 0$, for all $t \geq 0$. Then the even harmonics and the subharmonics of the steady-state response have zero amplitude, and the sequence of reset instants is periodic with period $\frac{\pi}{\omega}$.

Proof: The response of (9) for $r = r_0 \sin(\omega t)$ and $d = 0$, for all $t \geq 0$, is given by

$$x(t) = r_0 \left(e^{\bar{A}(t - t_k)} \left(\xi_k + \psi(t_k) \right) - \psi(t) \right), \quad t \in (t_k, t_{k+1}], \quad (27)$$

where

$$\begin{aligned} \psi(t) = & (\omega I \cos(\omega t) + \bar{A} \sin(\omega t)) \mathcal{F}, \\ \mathcal{F} = & (\omega^2 I + \bar{A}^2)^{-1} \bar{B} \begin{bmatrix} 1 \\ 0 \end{bmatrix}, \\ t_k = & \{t_k \in \mathbb{R}^+, k \in \mathbb{Z}^+ \mid e_R(t_k) = 0\}, \\ \xi_k = & \frac{1}{r_0} x(t_k^+) = \frac{1}{r_0} \bar{A}_\rho x(t_k). \end{aligned} \quad (28)$$

¹For ease of the notation we consider $w(t) = w_0 \sin(\omega t)$. However, Theorem 1 is also applicable in the case in which $w(t) = [r_0 \sin(\omega t + \phi_1) \ d_0 \sin(\omega t + \phi_2)]^T$.

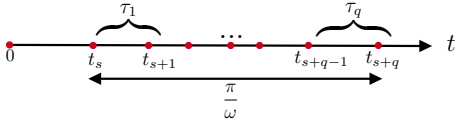

Fig. 2: Steady-state reset instants of the reset control system (9)

Thus

$$\bar{x}(t) = r_0 \left(e^{\bar{A}(t-t_s)} (\xi_s + \psi(t_s)) - \psi(t) \right), \quad t \in (t_s, t_{s+1}], \quad (29)$$

with

$$\begin{aligned} \xi_s = & \bar{A}_\rho e^{\bar{A}(t_s-t_{s-1})} \left(\bar{A}_\rho e^{\bar{A}(t_{s-1}-t_{s-2})} \dots \bar{A}_\rho e^{\bar{A}(t_1-t_0)} (\xi_0 + \psi(t_0)) \right. \\ & + \bar{A}_\rho e^{\bar{A}(t_{s-1}-t_{s-2})} \dots \bar{A}_\rho e^{\bar{A}(t_2-t_1)} (I - \bar{A}_\rho) \psi(t_1) \\ & + \bar{A}_\rho e^{\bar{A}(t_{s-1}-t_{s-2})} \dots \bar{A}_\rho e^{\bar{A}(t_2-t_1)} (I - \bar{A}_\rho) \psi(t_2) \\ & \left. + \dots + (I - \bar{A}_\rho) \psi(t_{s-1}) \right) - \bar{A}_\rho \psi(t_s). \quad (30) \end{aligned}$$

According to [43], uniformly convergent systems forget their initial conditions. By Lemma 1 and Lemma 2, ξ_s and the reset instants are unique for any t_0 and ζ_0 . Hence, the transient response of ξ_s converges to zero which implies that

$$\begin{aligned} \xi_s = & \bar{A}_\rho e^{\bar{A}(t_s-t_{s-1})} \left((I - \bar{A}_\rho) \psi(t_{s-1}) \right. \\ & + \bar{A}_\rho e^{\bar{A}(t_{s-1}-t_{s-2})} (I - \bar{A}_\rho) \psi(t_{s-2}) \\ & + \bar{A}_\rho e^{\bar{A}(t_{s-1}-t_{s-2})} \bar{A}_\rho e^{\bar{A}(t_{s-2}-t_{s-3})} (I - \bar{A}_\rho) \psi(t_{s-3}) \\ & + \dots + \bar{A}_\rho e^{\bar{A}(t_{s-1}-t_{s-2})} \dots \bar{A}_\rho e^{\bar{A}(t_{s-m+1}-t_{s-m})} \\ & \left. (I - \bar{A}_\rho) \psi(t_{s-m}) \right) - \bar{A}_\rho \psi(t_s). \quad (31) \end{aligned}$$

Therefore, since reset occurs when

$$\bar{C}_{e_R} \bar{x}(t) + D_{e_R} r_0 \sin(\omega t) = 0, \quad (32)$$

if $\{t_s, t_{s-1}, \dots, t_{s-m}\}$ are reset instants and satisfy (32), then $\{t_s, t_{s-1}, \dots, t_{s-m}\} + \frac{\pi}{\omega}$ also satisfy (32), which implies that the sequence of reset instants is periodic with period $\frac{\pi}{\omega}$. Using this property in (29) shows that $\bar{x}(t) = -\bar{x}(t + \frac{\pi}{\omega})$ and $t_{s+q} - t_s = \frac{\pi}{\omega}$, hence $\xi_s = -\xi_{s+q}$. This means that the even harmonics of the steady-state response of the reset control system (9) have zero amplitude. In addition, $\bar{x}(t) = \bar{x}(t + \frac{2\pi}{\omega})$, which implies that the steady-state response of the reset control system (9) does not contain any subharmonic. ■

Remark 2: The reset sequence $\{t_k\}$ and the reset values ζ_k are independent of the input amplitude for $r(t) = r_0 \sin(\omega t)$. We now show that the function \mathcal{S} can be derived explicitly for $r(t) = r_0 \sin(\omega t)$ and $d = 0$. Suppose there are $q - 1$ reset instants between t_s and $t_s + \frac{\pi}{\omega}$ (Fig. 2). Assume $\sin(\omega t_s) = \kappa$, then $\cos(\omega t_s) = \pm \sqrt{1 - \kappa^2}$ (without loss of generality we consider the positive value). Using trigonometry relations, one

has that

$$\begin{aligned} \psi(t_s) &= f_0(\kappa), \\ \psi(t_s + \tau_1) &= f_1(\kappa, \tau_1), \\ &\vdots \\ \psi(t_s + \tau_1 + \dots + \tau_q) &= f_q(\kappa, \tau_1, \tau_2, \dots, \tau_q). \quad (33) \end{aligned}$$

Moreover,

$$\begin{aligned} \xi_{s+i} = & \bar{A}_\rho \left(e^{\bar{A}\tau_i} (g_{i-1}(\kappa, \xi_s, \tau_1, \dots, \tau_{i-1}) + f_{i-1}(\kappa, \tau_1, \dots, \tau_{i-1})) \right. \\ & \left. - f_i(\kappa, \tau_1, \tau_2, \dots, \tau_i) \right) = g_i(\kappa, \xi_s, \tau_1, \tau_2, \dots, \tau_i), \quad (34) \end{aligned}$$

with $i = 1, 2, \dots, q$ and $g_0(\kappa, \xi_s) = \xi_s$. Now, since $e_R(t)$ is zero at reset instants, one has that

$$\begin{aligned} \bar{C}_{e_R} \left(e^{\bar{A}\tau_i} (g_{i-1}(\kappa, \xi_s, \tau_1, \dots, \tau_{i-1}) + f_{i-1}(\kappa, \tau_1, \dots, \tau_{i-1})) \right. \\ \left. - f_i(\kappa, \tau_1, \tau_2, \dots, \tau_i) \right) + D_{e_R} \sin(\omega(t_s + \tau_1 + \dots + \tau_i)) \\ = E_i(\kappa, \xi_s, \tau_1, \dots, \tau_i) = 0, \quad (35) \end{aligned}$$

with $i = 1, 2, \dots, q$. In addition,

$$\begin{aligned} \tau_1 + \tau_2 + \dots + \tau_q &= \frac{\pi}{\omega}, \\ \xi_s = -\xi_{s+q} &\Rightarrow g_q(\kappa, \xi_s, \tau_1, \tau_2, \dots, \tau_q) + \xi_s = 0. \quad (36) \end{aligned}$$

Moreover, by the well-posedness property of reset instants (see Definition 1), reset instants are distinct. Hence, there are $q + 2$ independent equations and $q + 2$ parameters $(\kappa, \xi_s, q, \tau_1, \tau_2, \dots, \tau_q)$, $q \in \mathbb{N}$. In addition, the well-posedness property implies that the reset intervals are lower bounded [9]. Hence,

$$\exists \lambda \leq \tau_i \Rightarrow q \leq \frac{\pi}{\lambda \omega} - 1. \quad (37)$$

Furthermore, for $q = 1$, the equations have always a unique solution. Thus, there exists a bounded non-empty set $Q = \{Q_i \in \mathbb{N} | Q_i \leq q_{\max}\}$ such that for $q \in Q$, the equations have a solution. Hence, $\bar{x}(t)$, the steady-state response of the reset control system (9) to $r(t) = r_0 \sin(\omega t)$, is the solution of (35)-(36) for $q = q_{\max}$. Since $\bar{x}(t)$ is periodic with period $\frac{2\pi}{\omega}$, one has

$$\bar{x}(t) = \sum_{n=1}^{\infty} a_n \cos((2n+1)\omega t) + b_n \sin((2n+1)\omega t). \quad (38)$$

According to Theorem 1, \bar{x} is unique and equal to the function \mathcal{S} . Thus,

$$\begin{aligned} \bar{x}(t) &= \sum_{n=1}^{\infty} a_n \cos((2n+1)\omega t) + b_n \sin((2n+1)\omega t) \\ &= \mathcal{S}(\sin(\omega t), \cos(\omega t), \omega). \quad (39) \end{aligned}$$

Finally, one could also use De Moivre's formula to find a formal polynomial expansion for \mathcal{S} in terms of $\sin(\omega t)$ and $\cos(\omega t)$.

B. HOSIDF of The Closed-Loop Reset Control Systems

In Section III-A sufficient conditions for the existence of the steady-state solution for the reset control system (9) driven by periodic inputs have been presented. Moreover, the steady-state solution has been explicitly calculated. In this section the HOSIDF technique [34] is applied to the steady-state response of the system to derive a notion of frequency response for the reset control system (9), which allows analyzing tracking and disturbance rejection performance (see the bottom diagram of Fig. 1).

1) *Tracking Performance*: Consider the reset control system (9) with $r(t) = r_0 \sin(\omega t)$ and $d(t) = 0$, for all $t \geq 0$. We now derive relations between the input $r(t)$ and the steady-state response of the output y , of the error e , and of the control input u . To this end, consider the steady-state reset instants $t_s, t_{s+1}, \dots, t_{s+q}$ and their associated reset values $\xi_s, \xi_{s+1}, \dots, \xi_{s+q}$ which are calculated through (35) and (36).

Theorem 2: Consider the reset control system (9) with $r(t) = r_0 \sin(\omega t)$ and $d(t) = 0$, for all $t \geq 0$. Let $T_n(j\omega)$ be the ratio of the n^{th} harmonic component of the output signal y to the first harmonic component of r . Then

$$T_n(j\omega) = \begin{cases} \mathfrak{I}(1, \omega) - \bar{C}(j\omega I + \bar{A})\mathcal{F}, & n = 1, \\ \mathfrak{I}(n, \omega), & n > 1 \text{ odd}, \\ 0, & n \text{ even}, \end{cases} \quad (40)$$

in which

$$\mathfrak{I}(n, \omega) = \frac{2j\omega\bar{C}}{\pi}(\bar{A} - jn\omega I)^{-1} \left(\sum_{i=1}^q \mathcal{R}(i, n, \omega) \right), \quad (41)$$

$$\mathcal{R}(i, n, \omega) = \left(\frac{e^{\bar{A}(t_{s+i} - t_{s+i-1})}}{e^{jn\omega t_{s+i}}} - \frac{I}{e^{jn\omega t_{s+i-1}}} \right) \left(\xi_{s+i-1} + \psi(t_{s+i-1}) \right). \quad (42)$$

Proof: By [33], [34]

$$T_n(j\omega) = \frac{\int_{t_s}^{t_s + \frac{2\pi}{\omega}} y(t) e^{-jn\omega t} dt}{\int_{t_s}^{t_s + \frac{2\pi}{\omega}} r_0 \sin(\omega t) e^{-jn\omega t} dt}. \quad (43)$$

Using (29), (43) is rewritten as

$$T_n(j\omega) = \frac{j\omega\bar{C}}{\pi} \left(\sum_{i=1}^{2q} \left(\int_{t_{s+i-1}}^{t_{s+i}} \mathcal{X}_i(t) e^{-jn\omega t} dt \right) - \int_{t_s}^{t_s + \frac{2\pi}{\omega}} \psi(t) e^{-jn\omega t} dt \right), \quad (44)$$

where

$$\mathcal{X}_i(t) = e^{\bar{A}(t - t_{s+i-1})} \left(\xi_{s+i-1} + \psi(t_{s+i-1}) \right). \quad (45)$$

For n even the first part of (44) is zero by Corollary 1, while for n odd one has

$$\begin{aligned} & \int_{t_{s+i-1}}^{t_{s+i}} \mathcal{X}_i(t) e^{-jn\omega t} dt \\ &= \int_{t_{s+i-1}}^{t_{s+i}} e^{\bar{A}(t - t_{s+i-1})} \left(\xi_{s+i-1} + \psi(t_{s+i-1}) \right) e^{-jn\omega t} dt \\ &= \int_{t_{s+i-1} + \frac{\pi}{\omega}}^{t_{s+i} + \frac{\pi}{\omega}} e^{\bar{A}(t - t_{s+i-1})} \left(-\xi_{s+i-1} - \psi(t_{s+i-1}) \right) \frac{e^{-jn\omega t}}{e^{-jn\pi}} dt \\ &= \int_{t_{s+i-1} + \frac{\pi}{\omega}}^{t_{s+i} + \frac{\pi}{\omega}} \mathcal{X}_i(t) e^{-jn\omega t} dt = (A - jn\omega I)^{-1} \mathcal{R}_{(i,n)}, \end{aligned} \quad (46)$$

while the second term in (44) is given by

$$\int_{t_{s_0}}^{t_{s_{s_m}}} \psi(t) e^{-jn\omega t} dt = \begin{cases} \pi \left(I - \frac{j\bar{A}}{\omega} \right) \mathcal{F}, & n = 1, \\ 0, & n > 2. \end{cases} \quad (47)$$

Thus, substituting (46) and (47) to (44) yields the claim. ■

Definition 2: The family of complex valued functions $T_n(j\omega)$, $n = 1, 2, \dots$ is the complementary sensitivity of the reset control system (9).

Corollary 2: Consider the reset control system (9) with $r(t) = r_0 \sin(\omega t)$ and $d(t) = 0$, for all $t \geq 0$. Let $S_n(j\omega)$ be the ratio of the n^{th} harmonic component of the error signal e to the first harmonic component of r . Then

$$S_n(j\omega) + T_n(j\omega) = \begin{cases} 1, & n = 1, \\ 0, & n > 1. \end{cases} \quad (48)$$

Corollary 3: Consider the reset control system (9) with $r(t) = r_0 \sin(\omega t)$ and $d(t) = 0$, for all $t \geq 0$. Let $CS_n(j\omega)$ be the ratio of the n^{th} harmonic component of the control input signal u to the first harmonic component of r . If the plant is stable, then

$$CS_n(j\omega) = \frac{T_n(j\omega)}{G(nj\omega)}. \quad (49)$$

Definition 3: The families of complex valued functions $S_n(j\omega)$ and $CS_n(j\omega)$, $n = 1, 2, \dots$, are the sensitivity and the control sensitivity of the reset control system (9), respectively.

2) *Disturbance Rejection*: In this section relations between $d(t) = \sin(\omega t)$ and the error $e(t)$ and the control input $u(t)$ are found in the case in which $r(t) = 0$ for the reset control system (9) using the same procedure provided in Section III-B.1. The matrix $\psi(t)$ has to be replaced by

$$\begin{aligned} \psi_{\mathcal{D}}(t) &= (\omega I \cos(\omega t) + \bar{A} \sin(\omega t)) \mathcal{F}_{\mathcal{D}}, \\ \mathcal{F}_{\mathcal{D}} &= (\omega^2 I + \bar{A}^2)^{-1} \bar{B} \begin{bmatrix} 0 \\ 1 \end{bmatrix}. \end{aligned} \quad (50)$$

Let $t'_s, t'_{s+1}, \dots, t'_{s+q'}$ and $\xi'_s, \xi'_{s+1}, \dots, \xi'_{s+q'}$ be the steady-state reset instants and their associated reset values for the reset control system (9) with $d(t) = d_0 \sin(\omega t)$ and $r(t) = 0$, respectively. In addition, since $r(t) = 0$, (35) is changed to

$$\begin{aligned} & \bar{C}_{e_R} \left(e^{\bar{A}\tau'_i} (g_{i-1}(\kappa'_i, \xi'_s, \tau'_1, \dots, \tau'_{i-1}) + f_{i-1}(\kappa'_i, \tau'_1, \dots, \tau'_{i-1})) \right. \\ & \left. - f_i(\kappa'_i, \tau'_1, \tau'_2, \dots, \tau'_i) \right) = E_i(\kappa'_i, \xi'_s, \tau'_1, \dots, \tau'_i) = 0, \end{aligned} \quad (51)$$

with $i = 1, 2, \dots, q'$. Now, substituting $\psi(t)$ with $\psi_{\mathcal{D}}(t)$ in relations (33) and (34), and considering (51) instead of (35), the steady-state response of the reset control system (9) for $d(t) = d_0 \sin(\omega t)$ and $r(t) = 0$ can be found using the same procedure provided in Section III-A.

Corollary 4: Consider the reset control system (9) with $d(t) = d_0 \sin(\omega t)$ and $r(t) = 0$, for all $t \geq 0$. Let $PS_n(j\omega)$ be the ratio of the n^{th} harmonic component of the error signal e to the first harmonic component of d . Then

$$PS_n(j\omega) = \begin{cases} \mathfrak{P}(1, \omega) + \bar{C}(j\omega I + \bar{A})\mathcal{F}_{\mathcal{D}}, & n = 1, \\ \mathfrak{P}(n, \omega), & n > 1 \text{ odd}, \\ 0, & n \text{ even}, \end{cases} \quad (52)$$

in which

$$\mathfrak{P}(n, \omega) = \frac{2j\omega\bar{C}}{\pi} (jn\omega I - \bar{A})^{-1} \left(\sum_{i=1}^{q'} \mathcal{R}_{\mathcal{D}}(i, n, \omega) \right), \quad (53)$$

$$\mathcal{R}_{\mathcal{D}}(i, n, \omega) = \left(\frac{e^{\bar{A}(t'_{s+i} - t'_{s+i-1})}}{e^{jn\omega t'_{s+i}}} - \frac{I}{e^{jn\omega t'_{s+i-1}}} \right) \left(\xi'_{s+i-1} + \psi_{\mathcal{D}}(t'_{s+i-1}) \right). \quad (54)$$

Corollary 5: Consider the reset control system (9) with $d(t) = d_0 \sin(\omega t)$ and $r(t) = 0$, for all $t \geq 0$. Let $CS_{d_n}(j\omega)$ be the ratio of the n^{th} harmonic component of the control input signal u to the first harmonic component of d . If the plant is stable, then

$$CS_{d_n}(j\omega) = \begin{cases} \frac{-PS_1(j\omega)}{G(j\omega)} - 1, & n = 1, \\ \frac{-PS_n(j\omega)}{G(nj\omega)}, & n > 1. \end{cases} \quad (55)$$

Definition 4: The families of complex valued functions $PS_n(j\omega)$ and $CS_{d_n}(j\omega)$, $n = 1, 2, \dots$, are the process-sensitivity and the control sensitivity due to the presence of the disturbance of the reset control system (9), respectively.

C. Pseudo-Sensitivities For Reset Control Systems

The analysis of the error signal e and of the control input u is one of the main factors while designing a controller. In linear systems this analysis is performed using the closed-loop transfer functions [44]. As discussed in Section I, although reset control systems may be analyzed using the DF of the reset controller in the closed-loop sensitivity equations, this yields an approximation which is not precise due to the existence of high order harmonics. On the other hand, it is not trivial to analyze reset controllers considering all harmonics. In order to perform the analysis of reset control systems straightforwardly we combine all harmonics into one frequency function for each closed-loop frequency response. In the literature, there are several studies about definition of Bode plot for non-linear systems [45], [46]. However, all of these focus only on the gain of the system. In the following, pseudo-sensitivities, which have both gain and phase components, are defined.

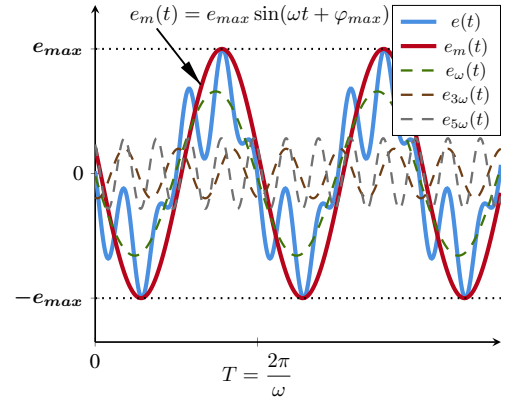

Fig. 3: The error signal $e(t)$ with its 1st, 3rd, and 5th harmonics. $e_m(t)$ is fitted to $e(t)$ and it is an indicator of the maximum error of the system.

It has been proven that the error and the control input signals of the reset control system (9) are periodic with period $\frac{2\pi}{\omega}$ (Fig. 3). We define the pseudo-sensitivity as the ratio of the maximum error of the reset control system (9), for $r(t) = r_0 \sin(\omega t)$ and $d(t) = 0$, for all $t \geq 0$, to the amplitude of the reference at each frequency.

Definition 5: The Pseudo-sensitivity S_∞ is, for all $\omega \in \mathbb{R}^+$,

$$S_\infty(j\omega) = e_{\max}(\omega) e^{j\varphi_{\max}(\omega)},$$

where $\varphi_{\max} = \frac{\pi}{2} - \omega t_{\max}$,

$$\begin{aligned} e_{\max}(\omega) &= \frac{\max_{t_s \leq t \leq t_s + 2q} (r(t) - y(t))}{r_0} \\ &= \sin(\omega t_{\max}) - \frac{1}{r_0} \bar{C} \bar{x}(t_{\max}), \\ t_{\max} &\in \{t_{ext} \mid \dot{e}(t_{ext}) = 0, t_s \leq t_{ext} \leq t_s + 2q\} \\ &\quad \cup \{t_{s+i} \mid i \in \mathbb{Z}, 0 \leq i \leq 2q\}. \end{aligned}$$

Using (9) and (29) t_{ext} can be obtained from

$$\begin{aligned} \dot{e}(t_{ext}) = 0 &\Rightarrow \omega \cos(\omega t_{ext}) - \bar{C} \bar{B} \begin{bmatrix} 1 \\ 0 \end{bmatrix} \sin(\omega t_{ext}) \\ &= \bar{C} \bar{A} \left(e^{\bar{A}(t_{ext} - t_{s+i})} (\xi_{s+i} + \psi(t_{s+i})) - \psi(t_{ext}) \right), \\ t_{ext} &\in (t_{s+i}, t_{s+i+1}], \quad i = \{i \in \mathbb{Z}^+ \mid i < 2q\}. \end{aligned} \quad (56)$$

Similarly, the pseudo-process sensitivity is defined as the ratio of the maximum error signal of the reset control system (9) for $d(t) = d_0 \sin(\omega t)$ and $r(t) = 0$, for all $t \geq 0$, to the amplitude of the disturbance at each frequency.

Definition 6: The Pseudo-process sensitivity PS_∞ is, for all $\omega \in \mathbb{R}^+$,

$$PS_\infty(j\omega) = e_{\max_d}(\omega) e^{j\varphi_{\max_d}(\omega)},$$

where $\varphi_{\max_d} = \frac{\pi}{2} - \omega t_{\max_d}$,

$$\begin{aligned} e_{\max_d}(\omega) &= \frac{\max_{t'_s \leq t \leq t'_s + 2q} -y(t)}{d_0} = -\frac{1}{d_0} \bar{C} \bar{x}(t_{\max_d}), \\ t_{\max_d} &\in \{t_{ext_d}\} \cup \{t'_{s+i}, i \in \mathbb{Z}, 0 \leq i \leq 2q'\}. \end{aligned}$$

In a similar way t_{ext_d} is obtained from

$$\begin{aligned} \dot{e}(t_{ext_d}) &= \frac{1}{d_0} \bar{C} \dot{\bar{x}}(t_{ext_d}) = 0 \Rightarrow \bar{C} \bar{B} \begin{bmatrix} 0 \\ 1 \end{bmatrix} \sin(\omega t_{ext_d}) \\ &= \bar{C} \bar{A} \left(\psi_{\mathcal{D}}(t_{ext_d}) - e^{\bar{A}(t_{ext_d} - t'_{s+i})} (\xi'_{s+i} + \psi_{\mathcal{D}}(t'_{s+i})) \right), \\ t_{ext_d} &\in (t'_{s+i}, t'_{s+i+1}], \quad i = \{i \in \mathbb{Z}^+ \mid i < 2q'\}. \end{aligned} \quad (57)$$

In order to analyze the noise rejection capability of the system the pseudo-complementary sensitivity is defined as the ratio of the maximum output of the reset control system (9) for $r(t) = r_0 \sin(\omega t)$ and $d = 0$, for all $t \geq 0$, to the amplitude of the reference at each frequency.

Definition 7: The Pseudo-complementary sensitivity T_∞ is, for all $\omega \in \mathbb{R}^+$,

$$T_\infty(j\omega) = y_{\max}(\omega) e^{j\varphi_{\max_y}(\omega)},$$

where $\varphi_{\max_y} = \frac{\pi}{2} - \omega t_{\max_y}$,

$$\begin{aligned} y_{\max}(\omega) &= \frac{\max_{t_s \leq t \leq t_s+2q} y(t)}{r_0} = \frac{1}{r_0} \bar{C} \bar{x}(t_{\max_y}), \\ t_{\max_y} &\in \{t_{ext_y}\} \cup \{t_{s+i}, i \in \mathbb{Z}, 0 \leq i \leq 2q\}. \end{aligned}$$

Similarly,

$$\begin{aligned} \dot{y}(t_{ext_y}) &= \frac{1}{r_0} \bar{C} \dot{\bar{x}}(t_{ext_y}) = 0 \Rightarrow \bar{C} \bar{B} \begin{bmatrix} 1 \\ 0 \end{bmatrix} \sin(\omega t_{ext_y}) \\ &= \bar{C} \bar{A} \left(\psi(t_{ext_y}) - e^{\bar{A}(t_{ext_y} - t_{s+i})} (\xi_{s+i} + \psi(t_{s+i})) \right), \\ t_{ext_y} &\in (t_{s+i}, t_{s+i+1}], \quad i = \{i \in \mathbb{Z}^+ \mid i < 2q\}. \end{aligned} \quad (58)$$

The pseudo-control sensitivity is defined as the ratio of the maximum control input signal of the reset control system (9) for $r(t) = r_0 \sin(\omega t)$ and $d = 0$, for all $t \geq 0$, to the amplitude of the reference at each frequency.

Definition 8: The Pseudo-control sensitivity CS_∞ is, for all $\omega \in \mathbb{R}^+$,

$$CS_\infty(j\omega) = u_{\max}(\omega) e^{j\varphi_{\max_u}(\omega)},$$

where $\varphi_{\max_u} = \frac{\pi}{2} - \omega t_{\max_u}$,

$$\begin{aligned} u_{\max}(\omega) &= \frac{\max_{t_s \leq t \leq t_s+2q} u(t)}{r_0} \\ &= \frac{1}{r_0} \bar{C}_u \bar{x}(t_{\max_u}) + \bar{D}_u \sin(\omega t_{\max_u}), \\ t_{\max_u} &\in \{t_{ext_u}\} \cup \{t'_{s+i}, i \in \mathbb{Z}, 0 \leq i \leq 2q'\}. \end{aligned}$$

In addition, t_{ext_u} can be found utilizing the relation

$$\begin{aligned} \dot{u}(t_{ext_u}) &= 0 \Rightarrow \bar{D}_u \omega \cos(\omega t_{ext_u}) + \bar{C}_u \bar{B} \begin{bmatrix} 1 \\ 0 \end{bmatrix} \sin(\omega t_{ext_u}) \\ &= \bar{C}_u \bar{A} \left(\psi(t_{ext_u}) - e^{\bar{A}(t_{ext_u} - t_{s+i})} (\xi_{s+i} + \psi(t_{s+i})) \right), \\ t_{ext_u} &\in (t_{s+i}, t_{s+i+1}], \quad i = \{i \in \mathbb{Z}^+ \mid i < 2q\}. \end{aligned} \quad (59)$$

In linear control theory, the transfer function of the closed-loop system from the disturbance input d to the control input u is equal to minus the transfer function from the reference signal r to the output signal y . However, this relation does not hold for the pseudo-sensitivities due to the non-linear nature of the controller. Hence, the pseudo-control sensitivity of the disturbance is defined as the ratio of the maximum amplitude

of the control input, for $d(t) = d_0 \sin(\omega t)$ and $r = 0$ for all $t \geq 0$, to the amplitude of the disturbance, at each frequency.

Definition 9: The Pseudo-control sensitivity of the disturbance CS_{d_∞} is, for all $\omega \in \mathbb{R}^+$,

$$CS_{d_\infty}(j\omega) = u_{\max_d}(\omega) e^{j\varphi_{\max_{u_d}}(\omega)},$$

where $\varphi_{\max_{u_d}} = \frac{\pi}{2} - \omega t_{\max_{u_d}}$,

$$\begin{aligned} u_{\max_d}(\omega) &= \frac{\max_{t'_s \leq t \leq t'_s+2q} u(t)}{d_0} = \frac{1}{d_0} \bar{C}_u \bar{x}(t_{\max_{u_d}}), \\ t_{\max_{u_d}} &\in \{t_{ext_{u_d}}\} \cup \{t'_{s+i}, i \in \mathbb{Z}, 0 \leq i \leq 2q'\}. \end{aligned} \quad (60)$$

Finally, $t_{ext_{u_d}}$ is calculated through the relation

$$\begin{aligned} \dot{u}(t_{ext_{u_d}}) &= 0 \Rightarrow \bar{C}_u \bar{B} \begin{bmatrix} 0 \\ 1 \end{bmatrix} \sin(\omega t_{ext_{u_d}}) = \bar{C}_u \bar{A} \left(\psi_{\mathcal{D}}(t_{ext_{u_d}}) \right. \\ &\quad \left. - e^{\bar{A}(t_{ext_{u_d}} - t'_{s+i})} (\xi'_{s+i} + \psi_{\mathcal{D}}(t'_{s+i})) \right), \\ t_{ext_{u_d}} &\in (t'_{s+i}, t'_{s+i+1}], \quad i = \{i \in \mathbb{Z}^+ \mid i < 2q'\}. \end{aligned} \quad (61)$$

We conclude this series of definitions with the following result.

Corollary 6: Consider the reset control system (9). The pseudo-sensitivities and the closed-loop HOSIDFs are independent of the amplitude of the harmonic excitation input.

D. High Frequency Analysis

The evaluation of the sensitivities and the pseudo-sensitivities may be computationally expensive, particularly at high frequencies. In order to simplify these relations the reset instants at high frequencies can be approximated. For sufficiently large frequencies, since the open-loop transfer function is strictly proper and (40) and (27) hold, one has

$$\lim_{\omega \rightarrow \infty} \frac{\max_{t_s \leq t \leq t_s+q} |e_R(t) - e_{R_1}(t)|}{\max_{t_s \leq t \leq t_s+q} |e_{R_1}(t)|} = 0, \quad (62)$$

where $e_{R_1}(t) = R_1 \sin(\omega t + \varphi_{e_{R_1}})$ is the first harmonic of $e_R(t)$ (see Appendix III). Thus,

$$\begin{aligned} \forall \epsilon \in (0, 1) \exists \omega_h \in \mathbb{R}^+ \mid \forall \omega \geq \omega_h : \\ \frac{\max_{t_s \leq t \leq t_s+q} |e_R(t) - e_{R_1}(t)|}{\max_{t_s \leq t \leq t_s+q} |e_{R_1}(t)|} \leq \epsilon. \end{aligned} \quad (63)$$

Therefore, if ϵ is chosen sufficiently small, the steady-state reset instants for $\omega \geq \omega_h$ can be approximated as

$$t_k \approx \frac{k\pi - \varphi_{e_{R_1}}}{\omega}, \quad (64)$$

in which

$$\varphi_{e_{R_1}} \approx \frac{C_{\mathcal{L}_1}(j\omega)}{1 + C_{\mathcal{L}_1} C_{\mathcal{R}_{DF}} C_{\mathcal{L}_2} G(j\omega)}, \quad (65)$$

where $C_{\mathcal{R}_{DF}}$ is the DF of $C_{\mathcal{R}}$ obtained using (3).

Remark 3: The accuracy of the approximation depends on the magnitude of ϵ . The smaller the value of ϵ , the more accurate the approximation is.

Let $\omega \geq \omega_h$ and $r(t) = \sin(\omega t - \varphi_{e_{R_1}})$. Then (9) can be re-written as

$$\begin{cases} \dot{\bar{x}}(t) = \bar{A}\bar{x}(t) + \bar{B}\sin(\omega t - \varphi_{e_{R_1}}), & t \neq \frac{k\pi}{\omega}, \\ \bar{x}(t^+) = \bar{A}_\rho \bar{x}(t), & t = \frac{k\pi}{\omega}, \\ y(t) = \bar{C}\bar{x}(t). \end{cases} \quad (66)$$

Thus, $\psi(t)$ in (27) is given by

$$\psi_\varphi(t) = (\omega I \cos(\omega t - \varphi_{e_{R_1}}) + \bar{A} \sin(\omega t - \varphi_{e_{R_1}}))\mathcal{F}. \quad (67)$$

The steady-state reset instants are $\{\frac{(2k)\pi}{\omega}, \frac{(2k+1)\pi}{\omega}\}$, $k \in \mathbb{N}$. Therefore,

$$\begin{aligned} \xi_s = -\xi_{s+1} &= \frac{-\bar{A}_\rho(I + e^{\frac{\bar{A}\pi}{\omega}})\psi_\varphi(0)}{I + \bar{A}_\rho e^{\frac{\bar{A}\pi}{\omega}}} \Rightarrow \mathcal{R}(1, n, \omega) \\ &= -(e^{\frac{\bar{A}\pi}{\omega}} + I)(\xi_s + \psi_\varphi(0)). \end{aligned} \quad (68)$$

Hence, for $\omega \geq \omega_h$, $T_n(j\omega)$ for the reset control system (9) are approximated by

$$\begin{cases} \bar{C}(\bar{A} - j\omega I)^{-1}\theta_\varphi(\omega) - \bar{C}(j\omega I + \bar{A})\mathcal{F}, & n = 1, \\ \bar{C}(\bar{A} - jn\omega I)^{-1}\theta_\varphi(\omega), & n > 1 \text{ odd}, \\ 0, & n \text{ even}, \end{cases} \quad (69)$$

in which

$$\begin{aligned} \theta_\varphi(\omega) &= \frac{-2j\omega e^{j\varphi_{e_{R_1}}}}{\pi} (I + e^{\frac{\bar{A}\pi}{\omega}}) \left(I \right. \\ &\quad \left. - (I + \bar{A}_\rho e^{\frac{\bar{A}\pi}{\omega}})^{-1} (\bar{A}_\rho (I + e^{\frac{\bar{A}\pi}{\omega}})) \right) \psi_\varphi(0). \end{aligned} \quad (70)$$

A similar analysis holds for the steady-state response of the reset control system (9) to a disturbance input. Similarly, let $d = \sin(\omega t - \varphi_{e_{d_1}})$. Then

$$\varphi_{e_{d_1}} \approx \frac{-C_{\mathcal{L}_1}(j\omega)G(j\omega)}{1 + C_{\mathcal{L}_1}C_{\mathcal{R}_{DF}}C_{\mathcal{L}_2}G(j\omega)}, \quad (71)$$

and $\psi_{\mathcal{D}}$ in (50) is given by

$$\psi_{\mathcal{D}_\varphi}(t) = (\omega I \cos(\omega t - \varphi_{e_{d_1}}) + A \sin(\omega t - \varphi_{e_{d_1}}))\mathcal{F}_{\mathcal{D}}. \quad (72)$$

Similarly,

$$\begin{aligned} \xi'_s = -\xi'_{s+1} &= \frac{-\bar{A}_\rho(I + e^{\frac{\bar{A}\pi}{\omega}})\psi_{\mathcal{D}_\varphi}(0)}{I + \bar{A}_\rho e^{\frac{\bar{A}\pi}{\omega}}} \Rightarrow \mathcal{R}_{\mathcal{D}}(1, n, \omega) \\ &= -(e^{\frac{\bar{A}\pi}{\omega}} + I)(\xi'_s + \psi_{\mathcal{D}_\varphi}(0)). \end{aligned} \quad (73)$$

Therefore, for ω sufficiently large $PS_n(j\omega)$ for the reset control system (9) are approximated as

$$\begin{cases} \bar{C}(j\omega I - \bar{A})^{-1}\theta_{\mathcal{D}_\varphi}(\omega) + \bar{C}(j\omega I + \bar{A})\mathcal{F}_{\mathcal{D}}, & n = 1, \\ \bar{C}(jn\omega I - \bar{A})^{-1}\theta_{\mathcal{D}_\varphi}(\omega), & n > 1 \text{ odd}, \\ 0, & n \text{ even}, \end{cases} \quad (74)$$

in which

$$\begin{aligned} \theta_{\mathcal{D}_\varphi}(\omega) &= \frac{-2j\omega e^{j\varphi_{e_{d_1}}}}{\pi} (I + e^{\frac{\bar{A}\pi}{\omega}}) \left(I \right. \\ &\quad \left. - (I + \bar{A}_\rho e^{\frac{\bar{A}\pi}{\omega}})^{-1} (\bar{A}_\rho (I + e^{\frac{\bar{A}\pi}{\omega}})) \right) \psi_{\mathcal{D}_\varphi}(0). \end{aligned} \quad (75)$$

Remark 4: The presented results have been integrated into an open source toolbox, which has been developed using Matlab, see [47]. This toolbox facilitates the analysis and design for reset control systems.

IV. PERIODIC INPUTS

In Section III a notion of frequency response and pseudo-sensitivities for reset control systems have been defined. These serve as graphical tools for performance analysis of reset controllers. The pseudo-sensitivities determine how a system amplifies harmonic inputs at various frequencies, information which is essential for control designers. However, this information is obtained for a single harmonic excitation and since the superposition principle does not hold, it provides only an approximation in the case of multi-harmonics excitation. In this section the steady-state performance in the presence of multi-harmonics excitation and periodic inputs is investigated. This is reasonable since most references and disturbances are periodic [12], [48].

For ease of notation let $\text{lcm}\left(\frac{a_1}{b_1}, \frac{a_2}{b_2}, \dots, \frac{a_i}{b_i}\right)$ denote the least common multiple of $\frac{a_1}{b_1}, \frac{a_2}{b_2}, \dots$, and $\frac{a_i}{b_i}$ and $\text{gcd}\left(\frac{a_1}{b_1}, \frac{a_2}{b_2}, \dots, \frac{a_i}{b_i}\right)$ denote the greatest common divisor of $\frac{a_1}{b_1}, \frac{a_2}{b_2}, \dots$, and $\frac{a_i}{b_i}$ in which $a_i \in \mathbb{N}$ and $b_i \in \mathbb{N}$.

Theorem 3: Consider the reset control system (9). Suppose the H_β condition and Assumption 1 hold. Then for any periodic excitation of the form

$$w(t) = w_0 \sin\left(\frac{2\pi}{T_0}t\right) + w_1 \sin\left(\frac{2\pi}{T_1}t\right) + \dots + w_N \sin\left(\frac{2\pi}{T_N}t\right), \quad (76)$$

with $w_i = [r_i, d_i]^T$, the reset control system (9) has a periodic steady-state solution of the form

$$\begin{aligned} \bar{x}(t) &= a_0 + \sum_{n=1}^{\infty} a_n \cos(n\omega_M t) + b_n \sin(n\omega_M t), \\ \omega_M &= 2\pi \times \text{gcd}\left(\frac{1}{T_0}, \frac{1}{T_1}, \dots, \frac{1}{T_N}\right). \end{aligned}$$

Proof: Let $t_{s_{M+i}}$ be the steady-state reset instants of the reset control system (9) for w is given in (76). By (9) the steady-state solution for w as in (76) is given by

$$\bar{x}(t) = e^{\bar{A}(t-t_{s_M})} \left(\xi_{s_M} + \psi_M(t_{s_M}) \right) - \psi_M(t), \quad t \in (t_{s_M}, t_{s_{M+1}}], \quad (77)$$

where

$$\begin{aligned} \psi_M(t) &= \psi_0(t) + \psi_1(t) + \dots + \psi_N(t), \\ \psi_i(t) &= (\omega_i I \cos(\omega_i t) + \bar{A} \sin(\omega_i t))\mathcal{F}_i, \\ \mathcal{F}_i &= (\omega_i^2 I + \bar{A}^2)^{-1} \bar{B} w_i. \end{aligned}$$

By Lemma 2 the reset control system (9) forgets the initial condition; thus, using as similar procedure as the one in

Section III-A, yields

$$\begin{aligned} \bar{x}(t) = & e^{\bar{A}(t-t_{s_M})} \left((I - \bar{A}_\rho) \psi_M(t_{s_M}) + e^{\bar{A}(t_{s_M}-t_{s_M-1})} \left(\right. \right. \\ & (I - \bar{A}_\rho) \psi_M(t_{s_M-1}) + \dots + \bar{A}_\rho e^{\bar{A}(t_{s_M-1}-t_{s_M-2})} \dots \\ & \left. \left. \bar{A}_\rho e^{\bar{A}(t_{s_M-m+1}-t_{s_M-m})} (I - \bar{A}_\rho) \psi_M(t_{s_M-m}) \right) \right) \\ & - \psi_M(t), \quad t \in (t_{s_M}, t_{s_M+1}]. \end{aligned}$$

Since the resetting condition is

$$\bar{C}_{eR} \bar{x}(t) + D_{eR} [1 \ 0] w_M(t) = 0, \quad (78)$$

if $\{t_{s_M}, t_{s_M-1}, \dots, t_{s_M-m}\}$ are reset instants and satisfy (78), then $t \in \{t_{s_M}, t_{s_M-1}, \dots, t_{s_M-m}\} + \frac{2\pi}{\omega_M}$ are such that (78) holds, which implies that the sequence of reset instants is periodic with period $\frac{2\pi}{\omega_M}$; hence, $\bar{x}(t) = \bar{x}(t + \frac{2\pi}{\omega_M})$, and using the Fourier series representation yields

$$\bar{x}(t) = a_0 + \sum_{n=1}^{\infty} a_n \cos(n\omega_M t) + b_n \sin(n\omega_M t). \quad (79)$$

Corollary 7: Consider the reset control system (9). Suppose the H_β condition and Assumption 1 hold. Then for any periodic input $w_P(t) = w_P(t + T_P)$ the reset control system (9) has a steady-state periodic solution with the same period time T_P .

Proof: A periodic function can be written as

$$w_P(t) = a'_0 + \sum_{n=1}^{\infty} a'_n \cos(n\frac{2\pi}{T_P}t) + b'_n \sin(n\frac{2\pi}{T_P}t). \quad (80)$$

Using Theorem 3 the steady-state solution of (9) for the input (80) is

$$\begin{aligned} \bar{x}(t) = & a_0 + \sum_{n=1}^{\infty} a_n \cos(n\omega_M t) + b_n \sin(n\omega_M t), \\ \omega_M = & 2\pi \times \gcd\left(\frac{1}{T_P}, \frac{2}{T_P}, \dots, \frac{n}{T_P}\right) = \frac{2\pi}{T_P}, \text{ hence the claim.} \end{aligned}$$

V. AN ILLUSTRATIVE EXAMPLE

In this section an illustrative example showing the effectiveness of the developed results is presented. A 3DOF precision positioning system, see Fig. 4, [1] and [49], is selected for this purpose. In this system we only consider mass 3 and actuator 1A (see Fig. 4) which can be modelled via the transfer function, see [50],

$$G(s) = \frac{8695}{s^2 + 4.36s + 7627}. \quad (81)$$

Note that the H_β condition holds for all of the controllers designed in the following subsections.

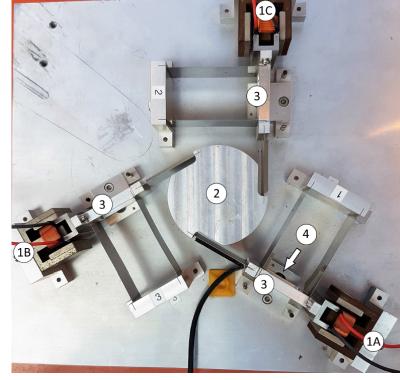

Fig. 4: A 3 DOF planar precision positioning Spyder stage. The voice coil actuators 1A, 1B and 1C control three masses (labelled as 3) which are constrained by leaf flexures. The three masses are connected to a central mass (labelled as 2) through leaf flexures. A Linear encoder (labelled as 4) is placed under mass 3 to provide the position feedback

A. The Optimal Structure for CI

The closed-loop frequency responses of the system with two reset controllers are compared against the closed-loop frequency responses achievable with a “tamed” PID controller [1] with base linear transfer function

$$C_{PID}(s) = k_p \left(1 + \frac{\omega_i}{s} \right) \left(\frac{\frac{s}{\omega_d} + 1}{\frac{s}{\omega_t} + 1} \right). \quad (82)$$

The first reset controller is obtained by replacing the integrator in (82) with a CI yielding

$$C_{SP(CI)D}(s) = k_p \left(1 + \frac{\omega_i}{s} \right) \left(\frac{\frac{s}{\omega_d} + 1}{\frac{s}{\omega_t} + 1} \right), \quad (83)$$

and the second reset controller is the parallel form of (83), that is

$$C_{PP(CI)D}(s) = k_p \left(1 + \frac{\omega_i}{s} + \frac{\frac{s}{\omega_d}}{\frac{s}{\omega_t} + 1} \right). \quad (84)$$

Note that, unlike the case of linear controllers, the parallel and series configuration of reset controllers can result in totally different responses. In this example we show that in contrast with the DF method, our method is capable of exposing this difference. Setting 100 Hz as the crossover frequency ω_c , the control parameters have been tuned based on the method proposed in [1], [44], [51] as $K_p = \frac{1}{3|G(j\omega_c)|} = 14.35$, $\omega_t = 3\omega_c = 600\pi$, $\omega_i = \frac{\omega_c}{10} = 20\pi$, and $\omega_d = \frac{\omega_c}{3} = 66.6\pi$. All frequency responses are obtained utilizing the toolbox in [47]. The open-loop frequency response of the system with the controller C_{PID} , and the DFs and the amplitudes of third harmonics of the system with the controllers $C_{SP(CI)D}$, $C_{PP(CI)D}$ are shown in Fig. 5. Based on the DF analysis

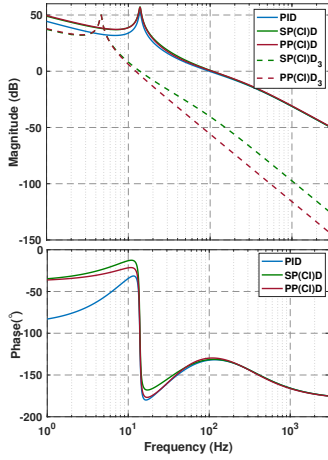
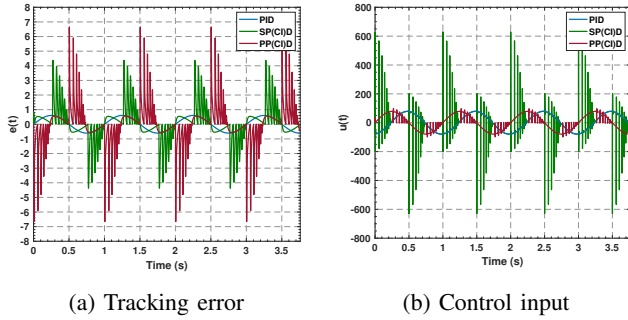

Fig. 5: The DFs and the amplitudes of the third harmonics of the open-loop system with the controllers $C_{SP(CI)D}$ and $C_{PP(CI)D}$, and open-loop frequency response of the system with the controller C_{PID}



(a) Tracking error

(b) Control input

Fig. 6: Time histories of the tracking errors and of the control inputs of the system with the controllers $C_{PP(CI)D}$, $C_{SP(CI)D}$ and C_{PID} for $r(t) = 100 \sin(2\pi t)$

it is expected that the tracking performances and the disturbance rejection capabilities of the system with controllers $C_{PP(CI)D}$ and $C_{SP(CI)D}$ are the same, and these performance capabilities are superior to those of the system with the controller C_{PID} . In addition, the control inputs and the noise attenuation capabilities of the system with these controllers are expected to be almost the same. However, the magnitude of high order harmonics of the reset controllers is different. The time-domain results (Fig. 6) disprove the predictions which rely on the DF method. In this figure the tracking errors and the amplitude of the control inputs of the system with these controllers are displayed for $r(t) = 100 \sin(2\pi t)$. It is seen that the control input of the system with the controller $C_{SP(CI)D}$ is much larger than the amplitude of the control inputs of the system with the controllers C_{PID} and $C_{PP(CI)D}$, whereas the tracking performance of the system with the controller $C_{SP(CI)D}$ is worse than the tracking performances of the system with the controllers C_{PID} and $C_{PP(CI)D}$. Note that similar to results presented in [17], [25], [52], [53], the amplitudes of even harmonics of the response are zero.

Unlike the DF method, the pseudo-sensitivities (Fig. 7) allows justifying why the performance of the system with

the controller C_{PID} is superior to the performances of the system with the controllers $C_{PP(CI)D}$ and $C_{SP(CI)D}$ in terms of precision and control effort. As illustrated in Fig. 7a, at low frequency the tracking performance of the system with the controller C_{PID} is better than that of the system with the controllers $C_{PP(CI)D}$ and $C_{SP(CI)D}$. Moreover, the tracking performance of the system with the controller $C_{PP(CI)D}$ is better than the tracking performance of the system with the controller $C_{SP(CI)D}$ at frequencies around the cross-over frequency. As it can be seen in Fig. 7b, the amplitude of the function CS_∞ of the system with the controller $C_{SP(CI)D}$ is much higher than that of the system with the controller $C_{PP(CI)D}$ and of the control sensitivity of the system with the controller C_{PID} . Thus, to avoid saturation problems designers should use the function CS_∞ instead of using the result obtained from the DF method when reset controllers are used.

In addition, as shown in Fig. 7c, the low frequency disturbance rejection capability of the system with the controller C_{PID} is better than that of the system with the controllers $C_{PP(CI)D}$ and $C_{SP(CI)D}$. Furthermore, as illustrated in Fig. 7d, the noise attenuating capabilities of the system with these three controllers are the same. The differences between the performances of the system with the controllers $C_{PP(CI)D}$ and $C_{SP(CI)D}$ are due to the differences in the amplitude and phase of the high order harmonics produced by these controllers.

To sum up, although it has been shown that using CIs, instead of linear integrators, improves the transient response of the system, the proposed results show that this deteriorates the tracking performance of the system, and the system needs a “stronger” actuator. Moreover, the actual implementation of the CI has significant effects on the performance of the system which cannot be exposed by using the results obtained with the DF method. This analysis reveals that the CI should be used in the parallel architecture (84), yielding a system with better precision and lower control input once compared with the system with the CI in the series architecture (83).

B. Performance of “Constant in gain Lead in phase (CgLp)” Compensators

Reset elements are utilized to introduce new compensators to enhance performance of control systems [17], [23]–[27]. In this section a new reset compensator called Constant in gain Lead in phase (CgLp) is analyzed. It consists of a reset filter FORE and a Proportional Derivative (PD) filter in series [17], [25]. The DF of a CgLp compensator is given in Fig. 8. Note that the combination of a PD and a FORE produces a compensator with a constant gain, while providing a phase lead. To study the effects of the “position” of the control elements on the performance of systems with reset controllers, two controllers (see Fig. 9) with CgLp compensators are

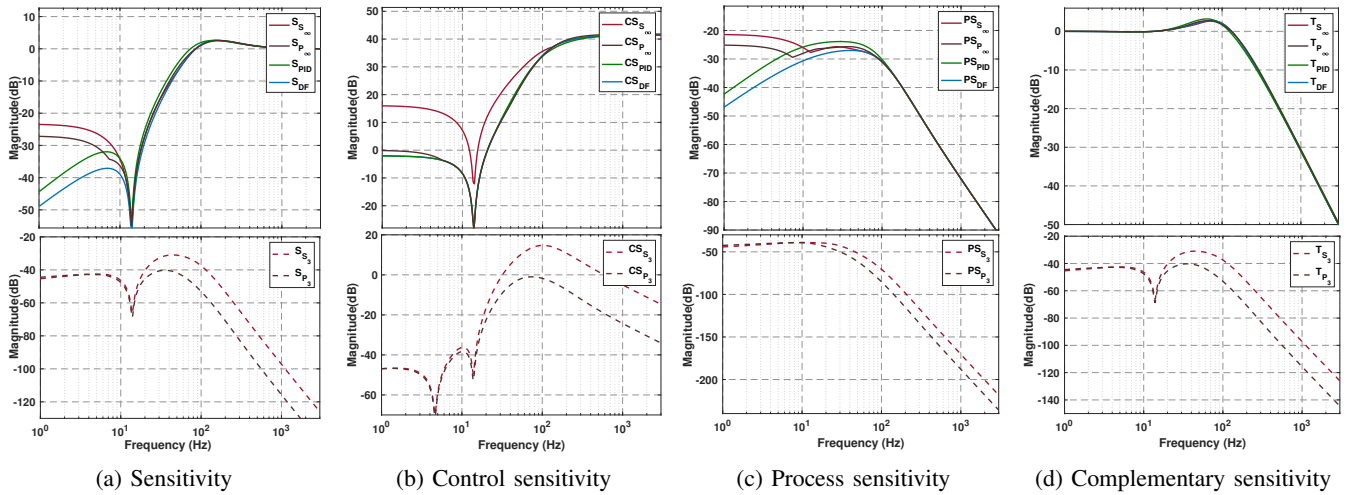

Fig. 7: The DFs (... DF), amplitudes of the third harmonics of the sensitivities (...), and amplitudes of pseudo-sensitivities (... ∞) of the closed-loop system with the controllers $C_{SP(CI)D}$, $C_{PP(CI)D}$, and closed-loop sensitivities of the system with the controller C_{PID}

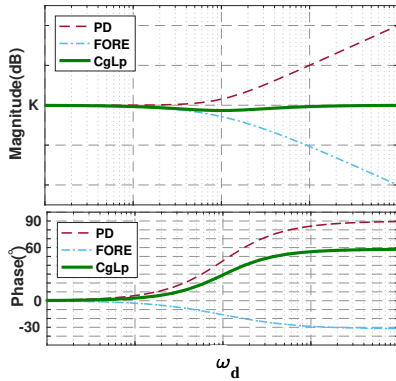

Fig. 8: The DF of a CgLp compensator

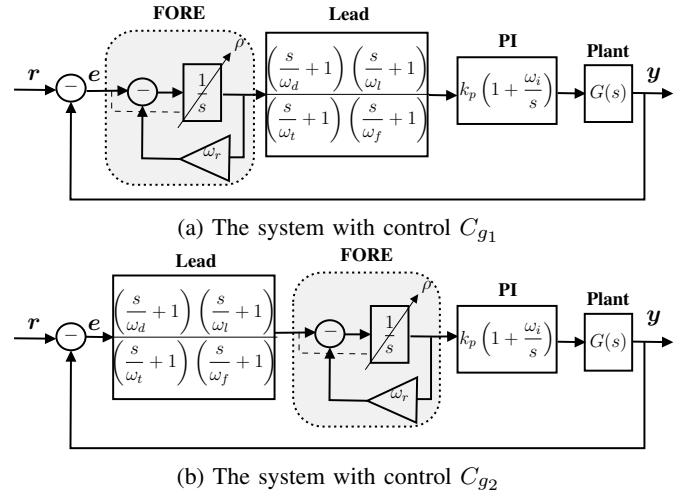

Fig. 9: Block diagrams of the Spyder plant with controllers C_{g1} (top), and C_{g2} (bottom)

considered. Both controllers are described by

$$C_{g_i}(s) = k_p \underbrace{\left(\frac{1}{\frac{s}{\omega_r} + 1} \right)}_{\text{CgLp}} \underbrace{\left(\frac{\frac{s}{\omega_d} + 1}{\frac{s}{\omega_l} + 1} \right)}_{\text{Lead}} \underbrace{\left(1 + \frac{\omega_i}{s} \right)}_{\text{Tamed PID}} \underbrace{\left(\frac{\frac{s}{\omega_l} + 1}{\frac{s}{\omega_f} + 1} \right)}_{\text{Lead}} \quad (85)$$

The parameters of these two controllers are the same and tuned optimally based on the method described in [52], yielding $k_p = 25.5$, $\omega_r = 111\pi$, $\omega_d = 105.2\pi$, $\omega_l = 1640\pi$, $\omega_i = 20\pi$, $\omega_l = 105.2\pi$, $\omega_f = 260\pi$, and $\gamma = 0.3$. The only difference between these two controllers is in the “position” of the filters. For C_{g1} is FORE-lead-proportional-integrator, while for C_{g2} one has lead-FORE-proportional-integrator. The DFs and the amplitudes of the third harmonic of the open-loop system with both controllers are given in Fig. 10. The DFs of the open-loop system with both controllers are the same, but the amplitudes of their third harmonic are different which yields different performances. In Fig. 11 the closed-loop frequency responses of the system with both controllers, including the amplitudes of the third harmonics, the DFs and

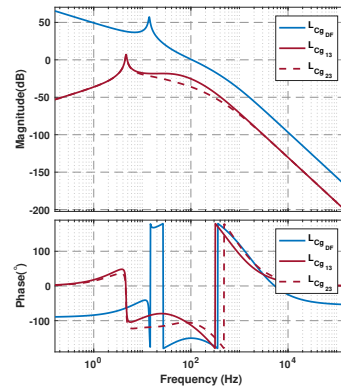

Fig. 10: The DFs and the amplitudes of the third harmonics of the open-loop system with the controllers C_{g1} and C_{g2}

amplitudes of pseudo-sensitivities, are presented. Note that

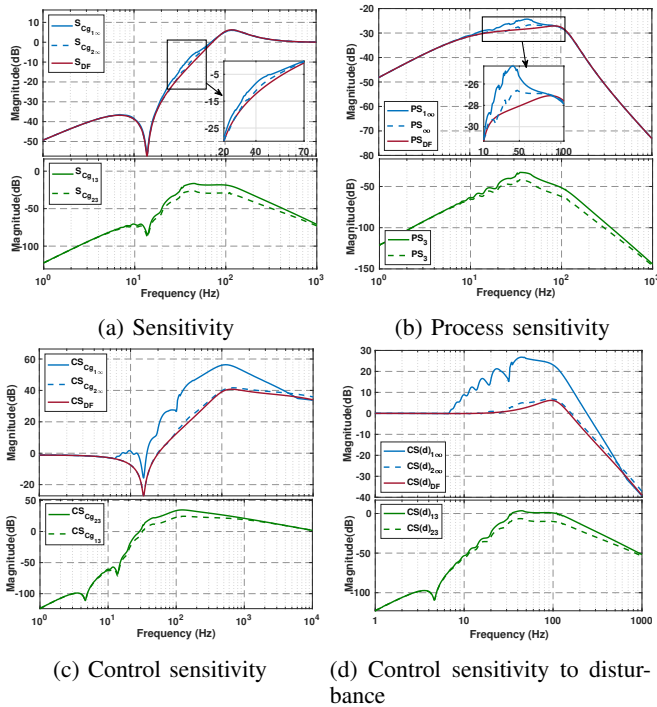

Fig. 11: The DFs (... DF), amplitudes of the third harmonics of the sensitivities (...3), and amplitudes of pseudo-sensitivities (... ∞) of the closed-loop system with the controllers C_{g_1} and C_{g_2}

there are significant differences between the results obtained using the DF method and the proposed tools. Unlike the DF method, the proposed tools reveal the effects of the “position” of the control filters on the performance of the reset control systems. The differences in magnitude and phase of the high order harmonics of the open-loop system with these controllers (Fig. 10) leads to discrepancies between the closed-loop frequency responses. As shown in Fig. 11a, the system with the controller C_{g_2} has better tracking performance than that of the system with the controller C_{g_1} . In addition, the amplitude of the third harmonic of the sensitivity of the system with C_{g_2} is smaller than that resulting from the use of the controller C_{g_1} around the cross-over frequency. Moreover, as illustrated in Fig. 11b, the system with the controller C_{g_2} has better disturbance rejection capability than the system with the controller C_{g_1} . As shown in Fig. 11c and Fig. 11d, the system with the controller C_{g_1} has larger control input in comparison with the system with the controller C_{g_2} . As discussed, unlike the case of linear controller and the results obtained using the DF method, the control sensitivity due to the disturbance CS_{d_∞} is different from the complementary sensitivity, particularly at middle frequencies.

In addition, the tracking error and the error due to the presence of disturbance of the system with the controller C_{g_1} at 5 Hz are obtained experimentally (Table I). As was shown, there are negligible differences between experimental and our proposed results. These small differences between the theoretical and the experimental results are due to quantization, digitalization of the controller, numerical approximations, and the presence

TABLE I: Comparison between the theoretical and experimental results in terms of tracking performance and disturbance rejection

Performance	C_{g_1}	
	Theory	Experiment
Tracking $\frac{e_r}{ r }$ (dB)	-37.57	-35.8
Disturbance rejection $\frac{e_w}{ w }$ (dB)	-33.1	-34

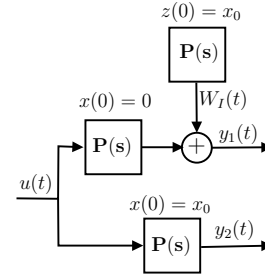

Fig. 12: Diagram of the result in Lemma 3

of noise.

In summary the proposed methods allow predicting the closed-loop performance of reset control systems more accurately than the DF method. In addition, it reveals important features of reset controllers which are not exposed by the DF method.

VI. CONCLUSION

This paper has proposed an analytical approach to obtain closed-loop frequency responses for reset control systems, including high order harmonics. To this end, sufficient conditions for the existence of the steady-state solution of the closed-loop reset control systems driven by periodic inputs have been presented. Moreover, pseudo-sensitivities, which serve as a graphical tool for performance analysis of reset controllers, have been defined: these relate the error and control input of the system to the reference and the disturbance. All calculations can be performed in a user-friendly toolbox to make this approach easy of use. To show the effectiveness of the proposed method, the performances of a high-precision positioning stage with reset controllers have been assessed using the DF method and our proposed method. The results confirm that the proposed method predicts the closed-loop performance of reset control systems more accurately than the DF method.

APPENDIX I

Lemma 3: Consider the linear systems $\dot{x}_{p_1}(t) = A_p x_{p_1}(t) + B_p u(t)$, $y_{p_1}(t) = C_p x_{p_1}(t)$, with $x_{p_1}(0) = x_0$, $\dot{x}_{p_2}(t) = A_p x_{p_2}(t) + B_p u(t)$, $y_{p_2}(t) = C_p x_{p_2}(t) + W_I(t)$, with $x_{p_2}(0) = 0$, and $\dot{z}(t) = A_p z(t)$, $W_I(t) = C_p z(t)$, with $z(0) = x_0$, in which A_p , B_p , and C_p describe a realization of transfer function $P(s)$ (see Fig. 12). Then $y_{p_1}(t) = y_{p_2}(t)$, for all $t \geq 0$.

Proof: Note that $W_I(t) = C_p e^{A_p t} x_0$. Thus,

$$y_{p_2}(t) = y_{p_1}(t) = C_p e^{A_p(t)} x_0 + \int_0^t e^{A_p(t-\tau)} B_p u(\tau) d\tau.$$

APPENDIX II

Lemma 4: Consider a positive and bounded function $V(t)$. Suppose that there exists a $\alpha > 0$ such that

$$\begin{cases} \dot{V} \leq -\alpha V & t \in \mathcal{M}, \\ V(\Delta x(t^+)) = V(\Delta x(t)) + \Xi(t, \delta), & t \notin \mathcal{M}. \end{cases} \quad (86)$$

If for t sufficiently large

$$\Xi(t, \delta) \leq 0, \quad (87)$$

then there exist $\alpha_m > 0$ and $\mathcal{K} > 0$ such that

$$V(t) \leq \mathcal{K}e^{-\alpha_m t}, \text{ for all } t \geq 0. \quad (88)$$

Proof: Since V is bounded, by (86) and (87), V achieves its maximum value at some time $t_{v_m} < \infty$. In other words, there exists a time $0 \leq t_{v_m} < \infty$ such that

$$\begin{cases} V(t_{v_m}) \geq V(t), & t \leq t_{v_m}, \\ V(t_{v_m}) > V(t). & t > t_{v_m}, \end{cases} \quad (89)$$

Therefore, by (87) and well-posedness property, there exists a bounded set $\mathcal{T} = \{t_i > t_{v_m} \mid t_i \notin \mathcal{M} \wedge \Xi(t_i, \delta) > 0, i \in \mathbb{N}\}$. Thus, using (89) there exists a bounded set $\mathcal{A} = \{\alpha_i > 0 \mid V(t_i) = e^{-\alpha_i(t_i - t_{v_m})}V(t_{v_m}), t_i \in \mathcal{T}\}$. Since the set \mathcal{A} is bounded, there exists a $\alpha' > 0$ such that for all $\alpha_i \in \mathcal{A}$ one has that $\alpha' \leq \alpha_i$. Now considering $\alpha_m = \min(\alpha, \alpha')$, based on (86) and (87), yields

$$V(t) \leq e^{-\alpha_m(t - t_{v_m})}V(t_{v_m}) = \mathcal{K}e^{-\alpha_m t}, \text{ for all } t \geq 0. \quad (90)$$

Finally, if \mathcal{T} and \mathcal{A} are empty sets, then selecting $\alpha_m = \alpha$ the claim yields. ■

APPENDIX III

Note that by (27) and (40), $\lim_{\omega \rightarrow \infty} \bar{y}(t) = 0$ and $\lim_{\omega \rightarrow \infty} T_n(j\omega) = 0$. In addition, since $y(t) = r_0 \sum_{n=1}^{\infty} T_n(j\omega)$, $\lim_{\omega \rightarrow \infty} \sum_{n=1}^{\infty} T_n(j\omega) = 0$. On the other hand, if the transfer function of the controller $C_{\mathcal{L}_1}$ is proper, then $\lim_{\omega \rightarrow \infty} C_{\mathcal{L}_1}(nj\omega) = K_{c1}$; otherwise, $\lim_{\omega \rightarrow \infty} (nj\omega)^{n_c} C_{\mathcal{L}_1}(nj\omega) = 1$, with $n_c \geq 1$. In the case in which $C_{\mathcal{L}_1}$ is proper.

$$\begin{aligned} \lim_{\omega \rightarrow \infty} \frac{\max_{t_s \leq t \leq t_s+q} |e_R(t) - e_{R_1}(t)|}{\max_{t_s \leq t \leq t_s+q} |e_{R_1}(t)|} &\leq \lim_{\omega \rightarrow \infty} \frac{K_{c1}r_0 \sum_{n=3}^{\infty} T_n(j\omega)}{K_{c1}r_0} \\ &\Rightarrow \lim_{\omega \rightarrow \infty} \frac{\max_{t_s \leq t \leq t_s+q} |e_R(t) - e_{R_1}(t)|}{\max_{t_s \leq t \leq t_s+q} |e_{R_1}(t)|} = 0. \end{aligned} \quad (91)$$

■ In the case in which $C_{\mathcal{L}_1}$ is strictly proper.

$$\begin{aligned} \lim_{\omega \rightarrow \infty} \frac{\max_{t_s \leq t \leq t_s+q} |e_R(t) - e_{R_1}(t)|}{\max_{t_s \leq t \leq t_s+q} |e_{R_1}(t)|} &< \lim_{\omega \rightarrow \infty} \frac{\frac{r_0}{\omega^{n_c}} \left| \sum_{n=3}^{\infty} \frac{T_n(j\omega)}{\omega^{n_c}} \right|}{\frac{r_0}{\omega^{n_c}}} \\ &\Rightarrow \lim_{\omega \rightarrow \infty} \frac{\max_{t_s \leq t \leq t_s+q} |e_R(t) - e_{R_1}(t)|}{\max_{t_s \leq t \leq t_s+q} |e_{R_1}(t)|} = 0. \end{aligned} \quad (92)$$

ACKNOWLEDGMENT

The authors would like to thank Prof. Alfonso Baños from University of Murcia, Spain, for his kind guidance and for the useful discussions.

REFERENCES

- [1] A. A. Dastjerdi, N. Saikumar, and S. H. HosseinNia, "Tuning guidelines for fractional order PID controllers: Rules of thumb," *Mechatronics*, vol. 56, pp. 26 – 36, 2018.
- [2] A. O'Dwyer, *Handbook of PI and PID controller tuning rules*. World Scientific, 2009.
- [3] Y. Chen, "Ubiquitous fractional order controls?" *IFAC Proceedings Volumes*, vol. 39, no. 11, pp. 481 – 492, 2006, 2nd IFAC Workshop on Fractional Differentiation and its Applications.
- [4] J. C. Clegg, "A nonlinear integrator for servomechanisms," *Transactions of the American Institute of Electrical Engineers, Part II: Applications and Industry*, vol. 77, no. 1, pp. 41–42, 1958.
- [5] O. Beker, C. Hollot, Y. Chait, and H. Han, "Fundamental properties of reset control systems," *Automatica*, vol. 40, no. 6, pp. 905 – 915, 2004.
- [6] O. Beker, C. V. Hollot, and Y. Chait, "Plant with integrator: an example of reset control overcoming limitations of linear feedback," *IEEE Transactions on Automatic Control*, vol. 46, no. 11, pp. 1797–1799, 2001.
- [7] D. Netic, A. R. Teel, and L. Zaccarian, "Stability and performance of siso control systems with first-order reset elements," *IEEE Transactions on Automatic Control*, vol. 56, no. 11, pp. 2567–2582, 2011.
- [8] A. F. Villaverde, A. B. Blas, J. Carrasco, and A. B. Torrico, "Reset control for passive bilateral teleoperation," *IEEE Transactions on Industrial Electronics*, vol. 58, no. 7, pp. 3037–3045, 2011.
- [9] A. Baños and A. Barreiro, *Reset control systems*. Springer Science & Business Media, 2011.
- [10] S. van Loon, K. Gruntjens, M. Heertjes, N. van de Wouw, and W. Heemels, "Frequency-domain tools for stability analysis of reset control systems," *Automatica*, vol. 82, pp. 101 – 108, 2017.
- [11] D. Wu, G. Guo, and Y. Wang, "Reset integral-derivative control for HDD servo systems," *IEEE Transactions on Control Systems Technology*, vol. 15, no. 1, pp. 161–167, 2007.
- [12] A. Pavlov, B. Hunnekens, N. Wouw, and H. Nijmeijer, "Steady-state performance optimization for nonlinear control systems of Lur'e type," *Automatica*, vol. 49, no. 7, pp. 2087 – 2097, 2013.
- [13] F. S. Panni, H. Waschl, D. Alberer, and L. Zaccarian, "Position regulation of an EGR valve using reset control with adaptive feedforward," *IEEE Transactions on Control Systems Technology*, vol. 22, no. 6, pp. 2424–2431, 2014.
- [14] L. Hazeleger, M. Heertjes, and H. Nijmeijer, "Second-order reset elements for stage control design," in *American Control Conference (ACC)*, 2016, pp. 2643–2648.
- [15] R. Beerens, A. Bisoffi, L. Zaccarian, W. Heemels, H. Nijmeijer, and N. van de Wouw, "Reset integral control for improved settling of PID-based motion systems with friction," *Automatica*, vol. 107, pp. 483 – 492, 2019.
- [16] N. Saikumar, R. K. Sinha, and S. Hassan HosseinNia, "Resetting disturbance observers with application in compensation of bounded nonlinearities like hysteresis in piezo-actuators," *Control Engineering Practice*, vol. 82, pp. 36 – 49, 2019.
- [17] N. Saikumar, R. K. Sinha, and S. H. HosseinNia, "'Constant in gain Lead in phase' element-application in precision motion control," *IEEE/ASME Transactions on Mechatronics*, vol. 24, no. 3, pp. 1176–1185, 2019.

- [18] W. P. M. H. Heemels, G. E. Dullerud, and A. R. Teel, “ \mathcal{L}_2 -gain analysis for a class of hybrid systems with applications to reset and event-triggered control: A lifting approach,” *IEEE Transactions on Automatic Control*, vol. 61, no. 10, pp. 2766–2781, 2016.
- [19] F. Fichera, C. Prieur, S. Tarbouriech, and L. Zaccarian, “Lmi-based reset \mathcal{H}_∞ design for linear continuous-time plants,” *IEEE Transactions on Automatic Control*, vol. 61, no. 12, pp. 4157–4163, 2016.
- [20] A. Banos and A. Barreiro, “Delay-independent stability of reset systems,” *IEEE Transactions on Automatic Control*, vol. 54, no. 2, pp. 341–346, 2009.
- [21] L. Zaccarian, D. Nesic, and A. R. Teel, “First order reset elements and the Clegg integrator revisited,” in *American Control Conference*, 2005, pp. 563–568 vol. 1.
- [22] I. Horowitz and P. Rosenbaum, “Non-linear design for cost of feedback reduction in systems with large parameter uncertainty,” *International Journal of Control*, vol. 21, no. 6, pp. 977–1001, 1975.
- [23] B. Hunnekens, N. van de Wouw, M. Heertjes, and H. Nijmeijer, “Synthesis of variable gain integral controllers for linear motion systems,” *IEEE Transactions on Control Systems Technology*, vol. 23, no. 1, pp. 139–149, 2014.
- [24] S. J. A. M. Van den Eijnden, Y. Knops, and M. F. Heertjes, “A hybrid integrator-gain based low-pass filter for nonlinear motion control,” in *IEEE Conference on Control Technology and Applications (CCTA)*, 2018, pp. 1108–1113.
- [25] A. Palanikumar, N. Saikumar, and S. H. HosseinNia, “No more differentiator in PID: Development of nonlinear lead for precision mechatronics,” in *European Control Conference (ECC)*, 2018, pp. 991–996.
- [26] L. Chen, N. Saikumar, and S. H. HosseinNia, “Development of robust fractional-order reset control,” *IEEE Transactions on Control Systems Technology*, vol. 28, no. 4, pp. 1404–1417, 2020.
- [27] D. Valerio, N. Saikumar, A. A. Dastjerdi, N. Karbasizadeh, and S. H. HosseinNia, “Reset control approximates complex order transfer functions,” *Nonlinear Dynamics*, pp. 1–15, 2019.
- [28] A. Barreiro, A. Baños, S. Dormido, and J. A. González-Prieto, “Reset control systems with reset band: Well-posedness, limit cycles and stability analysis,” *Systems & Control Letters*, vol. 63, pp. 1–11, 2014.
- [29] A. Baños and M. A. Davó, “Tuning of reset proportional integral compensators with a variable reset ratio and reset band,” *IET Control Theory & Applications*, vol. 8, no. 17, pp. 1949–1962, 2014.
- [30] A. Vidal and A. Banos, “QFT-based design of PI+CI reset compensators: Application in process control,” in *16th Mediterranean Conference on Control and Automation*, 2008, pp. 806–811.
- [31] U. R. Nair, R. Costa-Castelló, and A. Baños, “Grid voltage regulation using a reset PI+CI controller for energy storage systems,” vol. 51, no. 4, pp. 226 – 231, 2018, 3rd IFAC Conference on Advances in Proportional-Integral-Derivative Control PID.
- [32] S. H. HosseinNia, I. Tejado, D. Torres, B. M. Vinagre, and V. Feliu, “A general form for reset control including fractional order dynamics,” *IFAC Proceedings Volumes*, vol. 47, no. 3, pp. 2028–2033, 2014.
- [33] Y. Guo, Y. Wang, and L. Xie, “Frequency-domain properties of reset systems with application in hard-disk-drive systems,” *IEEE Transactions on Control Systems Technology*, vol. 17, no. 6, pp. 1446–1453, 2009.
- [34] P. Nuij, O. Bosgra, and M. Steinbuch, “Higher-order sinusoidal input describing functions for the analysis of non-linear systems with harmonic responses,” *Mechanical Systems and Signal Processing*, vol. 20, no. 8, pp. 1883–1904, 2006.
- [35] K. Heinen, “Frequency analysis of reset systems containing a Clegg integrator,” Master’s thesis, Delft University of Technology, 2018.
- [36] Y. Guo, L. Xie, and Y. Wang, *Analysis and Design of Reset Control Systems*. Institution of Engineering and Technology, 2015.
- [37] C. Hollot, O. Beker, Y. Chait, and Q. Chen, “On establishing classic performance measures for reset control systems,” in *Perspectives in robust control*. Springer, 2001, pp. 123–147.
- [38] A. A. Dastjerdi, A. Astolfi, and S. H. HosseinNia, “A frequency-domain stability method for reset systems,” in *IEEE 59th Conference on Decision and Control*, 2020.
- [39] A. Banos, J. I. Mulero, A. Barreiro, and M. A. Davo, “An impulsive dynamical systems framework for reset control systems,” *International Journal of Control*, vol. 89, no. 10, pp. 1985–2007, 2016.
- [40] A. A. Dastjerdi, A. Astolfi, and S. H. HosseinNia, “Frequency-domain stability method for reset control systems,” *arXiv preprint arXiv:2009.00569*, 2020.
- [41] A. Pavlov, N. van de Wouw, and H. Nijmeijer, “Frequency response functions for nonlinear convergent systems,” *IEEE Transactions on Automatic Control*, vol. 52, no. 6, pp. 1159–1165, 2007.
- [42] A. Pavlov, A. Pogromsky, N. van de Wouw, and H. Nijmeijer, “Convergent dynamics, a tribute to Boris Pavlovich Demidovich,” *Systems & Control Letters*, vol. 52, no. 3, pp. 257 – 261, 2004.
- [43] A. Pavlov, N. van de Wouw, and H. Nijmeijer, “Convergent piecewise affine systems: analysis and design part i: continuous case,” in *Proceedings of the 44th IEEE Conference on Decision and Control*, 2005, pp. 5391–5396.
- [44] R. M. Schmidt, G. Schitter, and A. Rankers, *The Design of High Performance Mechatronics High-Tech Functionality by Multidisciplinary System Integration*. IOS Press, 2014.
- [45] O. Beker, “Analysis of reset control systems.” Ph.D. dissertation, University of Massachusetts Amherst, 2002.
- [46] A. Pavlov, N. van de Wouw, and H. Nijmeijer, “Frequency response functions and bode plots for nonlinear convergent systems,” in *Proceedings of the 45th IEEE Conference on Decision and Control*, 2006, pp. 3765–3770.
- [47] A. A. Dastjerdi, “Toolbox for frequency analysis of reset control systems.” [Online]. Available: <https://www.tudelft.nl/en/3me/about/departments/precision-and-microsystems-engineering-pme/research/mechatronic-system-design-msd/msd-research/motion-control/toolbox-frequency-analysis-of-reset-control-systems/>
- [48] W.-Y. Huang, C.-P. Chao, J.-R. Kang, and C.-K. Sung, “The application of ball-type balancers for radial vibration reduction of high-speed optic disk drives,” *Journal of Sound and Vibration*, vol. 250, no. 3, pp. 415–430, 2002.
- [49] N. Saikumar, D. Valerio, and S. H. HosseinNia, “Complex order control for improved loop-shaping in precision positioning,” in *IEEE 58th Conference on Decision and Control*, 2019, pp. 7956–7962.
- [50] H. Xiaojun, A. Ahmadi Dastjerdi, N. Saikumar, and S. HosseinNia, “Tuning of ‘Constant in gain Lead in phase (CgLP)’ reset controller using Higher-Order Sinusoidal Input Describing Function (HOSIDF),” in *Australian and New Zealand Control Conference (ANZCC)*, 2020.
- [51] M. E. Krijnen, R. A. van Ostayen, and H. HosseinNia, “The application of fractional order control for an air-based contactless actuation system,” *ISA Transactions*, vol. 82, pp. 172 – 183, 2018, fractional Order Signals, Systems, and Controls: Theory and Application.
- [52] A. A. Dastjerdi, N. Saikumar, and S. H. HosseinNia, “Tuning of a class of reset elements using pseudo-sensitivities,” *arXiv preprint arXiv:2005.02887*, 2020.
- [53] N. Karbasizadeh, A. Ahmadi Dastjerdi, N. Saikumar, D. Valerio, and S. HosseinNia, “Benefiting from linear behaviour of a nonlinear reset-based element at certain frequencies,” in *Australian and New Zealand Control Conference (ANZCC)*, 2020.

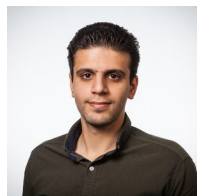

Ali Ahmadi Dastjerdi received his master degree in mechanical engineering from Sharif University of Technology, Iran, in 2015. He is currently working as a PhD candidate at the department of precision and microsystem engineering, TU Delft, The Netherlands. He has also collaborated with Prof. Alessandro Astolfi since 2019 as a sabbatical leave in Imperial College University. His primary research interests are on mechatronic systems design, precision engineering, precision motion control, and nonlinear control.



Alessandro Astolfi was born in Rome, Italy, in 1967. He graduated in electrical engineering from the University of Rome in 1991. In 1992 he joined ETH-Zurich where he obtained a M.Sc. in Information Theory in 1995 and the Ph.D. degree with Medal of Honor in 1995 with a thesis on discontinuous stabilization of nonholonomic systems. In 1996 he was awarded a Ph.D. from the University of Rome La Sapienza for his work on nonlinear robust control. Since 1996 he has been with the Electrical and Electronic Engineering

Department of Imperial College London, London (UK), where he is currently Professor of Nonlinear Control Theory and Head of the Control and Power Group. From 1998 to 2003 he was also an Associate Professor at the Dept. of Electronics and Information of the Politecnico di Milano. Since 2005 he has also been a Professor at Dipartimento di Ingegneria Civile e Ingegneria Informatica, University of Rome Tor Vergata. He has been a visiting lecturer in Nonlinear Control in several universities, including ETH-Zurich (1995-1996); Terza University of Rome (1996); Rice University, Houston (1999); Kepler University, Linz (2000); SUPELEC, Paris (2001), Northeastern University (2013). His research interests are focused on mathematical control theory and control applications, with special emphasis for the problems of discontinuous stabilization, robust and adaptive control, observer design and model reduction. He is the author of more than 150 journal papers, of 30 book chapters and of over 240 papers in refereed conference proceedings. He is the author (with D. Karagiannis and R. Ortega) of the monograph *Nonlinear and Adaptive Control with Applications* (Springer-Verlag). He is the recipient of the IEEE CSS A. Ruberti Young Researcher Prize (2007), the IEEE RAS Google Best New Application Paper Award (2009), the IEEE CSS George S. Axelby Outstanding Paper Award (2012), the Automatica Best Paper Award (2017). He is a Distinguished Member of the IEEE CSS, IET Fellow, IEEE Fellow and IFAC Fellow. He served as Associate Editor for *Automatica*, *Systems and Control Letters*, the *IEEE Trans. on Automatic Control*, the *International Journal of Control*, the *European Journal of Control* and the *Journal of the Franklin Institute*; as Area Editor for the *Int. J. of Adaptive Control and Signal Processing*; as Senior Editor for the *IEEE Trans. on Automatic Control*; and as Editor-in-Chief for the *European Journal of Control*. He is currently Editor-in-Chief of the *IEEE Trans. on Automatic Control*. He served as Chair of the IEEE CSS Conference Editorial Board (2010-2017) and in the IPC of several international conferences. He has been/is a Member of the IEEE Fellow Committee (2016, 2018/2019).

Niranjan Saikumar received his PhD degree in electrical engineering from Indian Institute of Science, India in 2015. He is currently working as a postdoc at the department of precision and microsystem engineering, TU Delft, The Netherlands. His research interests are on precision motion control, and nonlinear precision control and mechatronic system with distributed actuation.

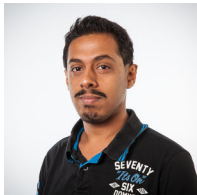

Nima Karbasizadeh has received his M.Sc. degree in Mechatronics from University of Tehran, Iran in 2017. He is currently a PhD candidate at the department of precision and microsystem engineering, Delft University of Technology, the Netherlands. His research interests are precision motion control, nonlinear precision control, mechatronic system design and haptics.



Duarte Valério is Associate Professor at Instituto Superior Técnico University of Lisbon, where he got his MSc (2001) and PhD (2005) in Mechanical Engineering, with theses on fractional control, i.e. on the use of fractional (non-integer) order derivatives in control. He has worked with fractional control and fractional dynamic systems, and their applications in several areas, ever since. He also researches in the fields of energy conversion (in particular, the control of Wave Energy Converters, that produce

electricity from the energy of sea waves) and bioengineering applications (modelling and control of dynamic systems such as biological processes). He has co-authored over forty papers in journals with impact factors, three books, over sixty papers in conference proceedings, and nine book chapters.

S. Hassan HosseinNia received his PhD degree with honour "cum laude" in electrical engineering specializing in automatic control: application in mechatronics, from the University of Extremadura, Spain in 2013. His main research interests are in precision mechatronic system design, precision motion control and mechatronic system with distributed actuation and sensing. He has an industrial background working at ABB, Sweden. Since October 2014 he is appointed as an assistant professor at the

department of precision and microsystem engineering at TU Delft, The Netherlands. He is an associate editor of the international journal of advanced robotic systems and *Journal of Mathematical Problems in Engineering*.

