

---

# Comparison of Syntactic and Semantic Representations of Programs in Neural Embeddings

---

*Author:*  
Austin P. Wright

*Supervisor:*  
Herbert Wiklicky

Submitted in partial fulfillment of the requirements for the MSc degree in  
Computing (Machine Learning) of Imperial College London

August 2019

## **Abstract**

Neural approaches to program synthesis and understanding have proliferated widely in the last few years; at the same time graph based neural networks have become a promising new tool. This work aims to be the first empirical study comparing the effectiveness of natural language models and static analysis graph based models in representing programs in deep learning systems. It compares graph convolutional networks using different graph representations in the task of program embedding. It shows that the sparsity of control flow graphs and the implicit aggregation of graph convolutional networks cause these models to perform worse than naive models. Therefore it concludes that simply augmenting purely linguistic or statistical models with formal information does not perform well due to the nuanced nature of formal properties introducing more noise than structure for graph convolutional networks.

# Contents

<b>1</b>	<b>Introduction</b>	<b>3</b>
<b>2</b>	<b>Background</b>	<b>5</b>
2.1	Deep Learning . . . . .	6
2.1.1	Machine Learning . . . . .	6
2.1.2	Multilayer Perceptron . . . . .	8
2.1.3	Training . . . . .	10
2.1.4	Convolutional Neural Networks . . . . .	11
2.1.5	Autoencoders . . . . .	13
2.1.6	Natural Language Processing . . . . .	14
2.1.7	Graph Convolutions . . . . .	15
2.1.8	Program Analysis . . . . .	16
2.2	Program Synthesis . . . . .	18
2.2.1	History . . . . .	18
2.2.2	Classical Formal Program Synthesis . . . . .	20
2.2.3	Neural Program Synthesis . . . . .	27
2.3	Similar Work . . . . .	27
<b>3</b>	<b>Methods</b>	<b>29</b>
3.1	Goals . . . . .	29
3.2	Design . . . . .	30
3.2.1	Dataset . . . . .	30
3.2.2	Feature Engineering . . . . .	33
3.2.3	Static Analysis Step . . . . .	35
3.2.4	Other Formats . . . . .	38
3.2.5	Neural Architectures . . . . .	39
3.3	Implementation . . . . .	42

<b>4</b>	<b>Evaluation and Analysis</b>	<b>46</b>
<b>5</b>	<b>Conclusions and Future Work</b>	<b>50</b>

# Chapter 1

## Introduction

Among the oldest goals in computer science has been the problem of program synthesis, however it has also been among the most elusive. Currently the most active area of interest in computer science is deep learning, bringing groundbreaking new results in many problems that were once very difficult. It is then natural to ask how we may try to apply deep learning to the age old problem of program synthesis.

The current state of the art in program synthesis goes one of two ways, either treating programs entirely like natural text in a single sequence and thus using existing natural language processing techniques, or eschewing deep learning altogether and using formal methods entirely and treating programs as purely mathematical objects. One of the more common and useful mathematical representations of programs is in various kinds of static analysis graphs, such as a control flow graph. While in the past these kinds of representations have not been compatible with deep learning, recent developments in geometric deep learning has opened the door to utilizing these graphs in neural networks. The hope would be that a graph neural network would be able to have all of the gains of a deep language system, and integrate the nuance from mathematical analysis and combine this information for better performance than either of the two other methods alone.

This work is an empirical study on the effectiveness of static analysis graph based representations when compared to linguistic representations of computer programs in deep learning systems. While the project proposal was initially to study deep learning applications in program synthesis, throughout this process and review it became clear that while there have been certain conjectures on the effectiveness of graph based representations, no study has

been done to show that these kinds of representations outperform other kinds of models. Towards answering this question of model effectiveness in general this work considers the specific case of program embedding, or encoding. This problem is a useful formulation, as it is both useful in its own right within a program synthesis framework like CEGIS (see section 2.2), and can act as a proxy for other kinds of program understanding tasks by forcing a model to learn to represent the whole program itself. Therefore this work will analyze the comparative effectiveness of equivalent models using either purely language based, or formal graph augmented, program representations.

# Chapter 2

## Background

Due to the breadth of topics discussed in this work, and the variance in expertise of the relevant audience, no background in the relevant fields of Deep Learning or Program Analysis are assumed beyond introductory linear algebra and statistics. This background chapter aims to provide relevant context and understanding of these fields required to follow the later analysis; however it should not be taken as exhaustive or supremely rigorous.

Section 2.1 on Deep Learning will introduce the general machine learning problem formulation, and introduce the fundamental pillars of how deep learning models work. It will then introduce the specialized convolution and graph convolution structures that are relevant to the models used in the work. Finally it will introduce some basic natural language processing as well as static program analysis techniques in order to understand how programs fit in to these deep learning models. Generally more emphasis is given to the deep learning portion of the background since bulk of the methods actually implemented in the work involve deep learning, where as the program analysis techniques used are rather simple. Overall this should provide enough background for an undergraduate to get up to speed and understand the context and content of the work outlined in the following chapters.

Section 2.2, while not directly relevant to the specific methods used, includes a background and history of Program Synthesis techniques. This is because this work began as an analysis of these deep learning methods in program synthesis, and the most relevant future works for these technologies is in that field. Therefore this background while not technically relevant, aims to inform the past and future context where the technologies analyzed

are most relevantly applied.

## 2.1 Deep Learning

### 2.1.1 Machine Learning

Since Deep Learning is just a special class of models in within the general framework of machine learning we are first going to introduce the fundamentals of machine learning. Machine Learning in effect is the synthesis of statistical modeling which the reader is likely already familiar, with a focus on computational tools and tractability. There are general definitions for this class of algorithms that learn from data such as the Probably Approximately Correct (PAC) Learning framework [Valiant, 1984]. In essence there are three main components in machine learning, the *data*, the *model*, and the *training algorithm*. The fundamental machine learning task is for a given task, the *model* uses the *training algorithm* on the *data* in order to improve its performance on said task. The most basic form of machine learning would be the case of a linear regression, where given a set of points (the data) find the line (linear model) that best matches the trend in the data. This is done

Figure 2.1: Linear Regression

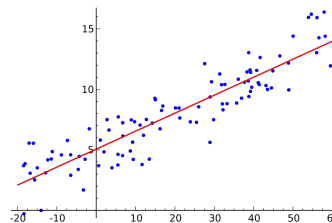

Source:

[https://en.wikipedia.org/wiki/File:Linear\\_regression.svg](https://en.wikipedia.org/wiki/File:Linear_regression.svg)

using the Ordinary Least Squares procedure (training algorithm) in order to optimize a certain goal, in this case the square error or total distance of the model line from the data. Often you hear the term *objective function*, this term simply represents the metric by which the model is evaluated, which is essentially part of the training algorithm (this is because much of the time the objective function used to train a model might actually be different that whatever final evaluation metric is used for a model).



There are a huge host of problems and types of data used for the machine learning problem, since it is so general. However broadly these problems can be broken into supervised learning and unsupervised learning. In a supervised learning problem the data is divided into two parts, the input and the label. In this situation normally a model is trained to predict a label based on just an input. Supervised learning includes everything from linear regression (as the model can be viewed as predicting an output/label  $y$  value from a given/input  $x$  value), to machine translation (predicting an output french translation from an input english sentence). This is generally the most common form of machine learning and performs the best as evaluation is easy with provided ground truth in the form of labels. However often times this labeling for the data is not possible or economical. Unsupervised Learning is learning from data without labels. This includes clustering algorithms that try and find structure in a dataset, or dimensionality reduction like Principle Component Analysis that tries to represent a high dimensional dataset with a small set of features. This framework is generally less efficient in the information it can extract from a dataset since there is no ground truth provided other than the data itself, however this class can be very useful in the many cases where data labeling is simply not an option.

The main goal of most machine learning models is to perform well not just on a given dataset, but on new unseen data. This is called *generalization* and is a very hard problem. Different kinds of models have what is called *capacity* which essentially means the amount of flexibility the model has in how fine tuned it is to small patterns in the data (this generally correlates with the number of learnable parameters in the model). Very low capacity can lead to *underfitting* where a model might not be able to learn of the most important patterns in the data. However if a dataset has a lot of noise or the capacity of the model is very high, a model could learn false patterns that are just results of noise that will not generalize, this is called *overfitting*. Both of these effects hurt the generalization of a model, and so a challenge in machine learning is finding the Goldilocks sweet spot for a given problem between underfitting with too low of a capacity and overfitting with too high. Controlling the model capacity is something that is normally done through methods like *regularization* which penalize too high of a model capacity, or other methods that might depend on the specific model at hand. We also attempt to measure this generalization phenomena by a technique called *cross-validation* which will use a subset of the actual dataset to train, and then use the held out portion to test the model on. This information can act

Figure 2.2: Over and Under Fitting

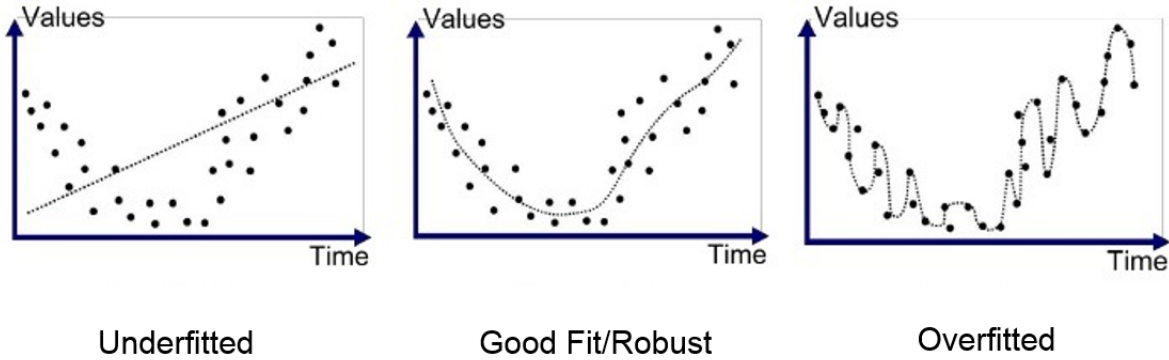

Source: <https://medium.com/greyatom/what-is-underfitting-and-overfitting-in-machine-learning-and-how-to-deal-with-it-6803a989c76>

as a proxy for true generalization and is often used to tune *hyperparameters* or the parameters that are determined before training (things like the size of the model or attributes of the training algorithm).

Deep Learning fits within this framework as simply a class of models called Artificial Neural Networks. Later sections will go into more depth on how these specific models work, but they still have the same challenges as any other model might for machine learning problems. They have fallen into favor as they have been shown to perform well for a variety of very hard tasks (most importantly for this work text and language processing), however it is important to know that deep learning models are not fundamentally different than a linear regression in the overall class of problems they are trying to solve and the general kinds of challenges that may arise.

### 2.1.2 Multilayer Perceptron

The most basic kind of deep learning model is the *Deep Feedforward Network* also called a *Multilayer Perceptron*. However before understanding what a multilayer perceptron is, perhaps we should first cover what a single perceptron is. The perceptron is a computational unit that takes inspiration from the biology of a neuron, in that it has a set of inputs that are combined and then has what is called an *activation* which produces a single output. This is where the similarities with biology and the brain for the most part

end, despite all of the hype around deep neural networks. Perceptrons ac-

Figure 2.3: Perceptron Unit

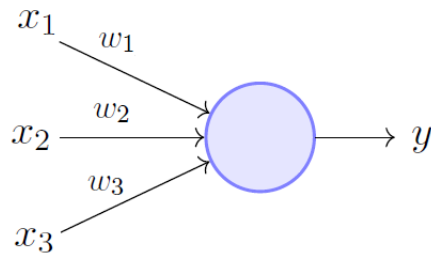

Perceptron Model (Minsky-Papert in 1969)

Source: <https://towardsdatascience.com/perceptron-the-artificial-neuron-4d8c70d5cc8d>

tually date back to the earliest days of artificial intelligence research in the sixties[Minsky and Papert, 1988]. Specifically for a given input vector  $\vec{x}$  a perceptron will take the dot product of  $\vec{x}$  with a weight vector  $\vec{w}$ , which is of course equivalent to taking a weighted sum of each individual input. Then this output is passed into what is called an activation function  $\sigma$ . The output thus of a perception is  $y = \sigma(\vec{w} \cdot \vec{x})$ . In the early days this activation function was a simple threshold, yielding 1 if the input was large enough and 0 otherwise. Later this was adapted to a continuous version called the sigmoid function, defined as:

$$\sigma(x) = \frac{1}{1 + e^{-x}}$$

However today many different kinds of activation functions are used including the hyperbolic tangent and the rectified linear unit (ReLU). However regardless of activation function, a single perceptron is not a particularly powerful model, it essentially is just a linear model with an added function but cannot learn nonlinear features. The key step in making perceptrons useful is stacking them together, this puts the deep into deep learning and the multilayer in multilayer perceptron. By chaining the outputs of perceptrons as the input to another layer of perceptrons, this forms a “hidden layer” as the inputs are processed to some intermediate value before finally being processed into a final output ( $y = \sigma_2(\vec{w}_2 \cdot \sigma_1(\vec{w}_1 \cdot \vec{x}))$ ). This architecture with just a single hidden layer actually forms on its own a universal function

Figure 2.4: Multilayer Perceptron

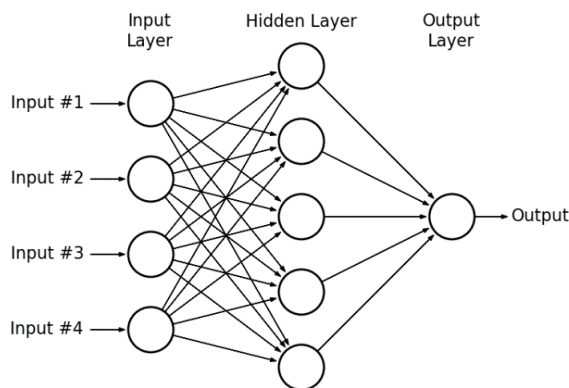

Source: [https://www.researchgate.net/figure/A-hypothetical-example-of-Multilayer-Perceptron-Network\\_fig4\\_303875065](https://www.researchgate.net/figure/A-hypothetical-example-of-Multilayer-Perceptron-Network_fig4_303875065)

approximator, where if there are a sufficient number of neurons (perceptrons within a network are often called neurons) in the hidden layer with a non-linear activation function and a simple linear activation for the final output layer, any function can be modeled by this deep network (by learning the correct set of weights). However the model is not limited to just one hidden layer, and empirically it has been shown that generally adding more layers and making the model “deeper” is more efficient than adding more neurons to a given layer and making the model “wider”.

### 2.1.3 Training

However a model with great ability to model functions in theory does not matter much if there is no way to train it. That is the situation deep feedforward networks were in for a long time until *back-propagation* was developed as a way to train these networks via *gradient descent* [Rumelhart et al., 1988]. Unlike linear regression where parameters can be solved exactly in closed form, the nonlinearities generally make the problem of finding the correct weights in deep networks *non-convex*. What that means is that finding the correct weights is a much harder problem and involved incrementally improving the model as opposed to calculating the solution all at once. This is done by a method called *gradient descent* (descent because we are normally trying to minimize some kind of error or loss). For a dataset we can calculate the

loss of the model as a function of the weights of the model,  $L(\vec{\theta})$ . Then in order to change the weights and improve the loss the gradient (derivative) is calculated  $\nabla L(\vec{\theta})$  to find out a first order approximation of how much the loss changes by changing each weight. Then each weight is changed by a small amount in the direction that would improve the loss. Then the process is repeated many times until an optimum value of the weights is found. This process does not necessarily guarantee a global optimum, however empirically if the process is repeated enough times with different random starting values of the weights it has been found that for the most part these local optima are good. In practice this gradient is only calculated over a small subset of the data (Stochastic Gradient Descent) and the size of the update changes as the training process continues (ADAM), in addition to a number of other small optimizations, however the core concept remains the same.

This technique then comes down to calculating the gradient of the loss in terms of each parameter. The process by which those values are calculated is called back-propagation (although it is really just application of the chain rule). The chain rule states that we can take the derivative of composed functions  $\left(\frac{d}{dx}z(y(x)) = \left(\frac{d}{dy}z(y)\right) \cdot \left(\frac{d}{dx}y(x)\right)\right)$ . Since the output of each layer is just a function of the previous layers we can use the chain rule to expand the  $\nabla L(\vec{\theta})$  term in terms of the output of previous layers, and propagate that information backwards through the network without having to recompute partial derivatives. This work will not go into the specifics of how the mathematics works, but suffice to say that this idea, while simple, paved the way for training deep networks by gradient descent to be at all tractable.

#### 2.1.4 Convolutional Neural Networks

Up to this point the network architecture we have discussed have been fully connected (or dense) feedforward neural networks. However as discussed previously there is a cost to having many parameters in the model, in terms of overfitting and in terms of training by calculating too many gradients. Therefore it is often useful to utilize the structure of the data in order to reduce the number of parameters used in a network. Many kinds of data contain a degree of locality, such as images and text containing local features. The most influential architecture that takes advantage of this, and also the advancement that took deep learning from an obscure to a behemoth research field is the convolutional layer[Lecun et al., 1998]. The most common use of

Figure 2.5: Convolutional Architecture for AlexNet

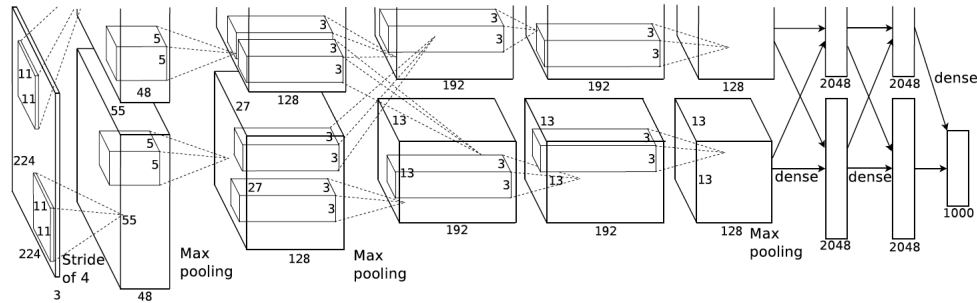

convolutional layers is in 2D image processing tasks, and while eventually the application relevant to this work is 1D convolutions over text, the concepts are still the same. In a convolutional layer a *filter* slides over every position on the input 2D grid (or more precisely slides over every  $n^{th}$  position determined by the stride parameter), and for each position the filter is dotted with the input. Since the dot product is in some sense a similarity metric, the output of the convolution can be construed as the similarity of the local region of the input image and the filter for every position of the input. For example a filter that has learned an image like a vertical line, when convolved over the input will show the locations on the input that seem to contain vertical lines. With many different filters this can be used to extract many different local features from the input that do not depend on the specific location of the feature. These layers are then composed to encode increasingly abstract information, from lines to shapes to layouts, out of an input, until eventually the hidden state can be passed to a fully connected layer and processed in the same way as a feed forward network. The key benefits of this are that small constant size filters (independent of input size) have many fewer parameters allowing the model to use many different filters to be composed to extract a variety of features. At the same time, the translation independence and locality of the features makes them more robust. This method also learns how to extract local features directly from the data, where as previous approaches had involved using expert knowledge to know what features to look for. This is what made AlexNet[Krizhevsky et al., 2017] kick start the current deep learning fervor in 2012 when it vastly outperformed other models in an image recognition competition.

Figure 2.6: MNIST Autoencoder

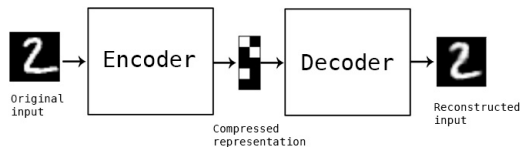

### 2.1.5 Autoencoders

The structure of problems this work is concerned with is the class of latent space models. This is where for a given, probably high dimensional, dataset we assume that there is some other lower dimensional latent space that contains all or most of the relevant information of the data. For instance in the popular MNIST dataset, images are large 28x28 or 784 dimensional vectors, however for the most part the only useful information can be encoded in a few dimensions representing the values as well as perhaps a few style attributes. An *autoencoder* is a deep network that learns this latent representation. The structure of such a network as shown in figure 2.6 contains three main components. First there is the encoder network, that transforms the data to some low dimension state, the state itself at this intermediate layer then encodes all of the information about the input that the network can access, finally there is the decoder network that takes this state and then tries to rebuild the original input. These models are unsupervised, as opposed the more standard supervised learning paradigm, because it does not require separate labels for each datum, but rather uses simply the raw data itself as labels in order to learn just re represent the data as opposed to necessarily predict something. However this low dimensional representation is very useful in itself.

Latent space models can be incredibly useful because of the so called “curse of dimensionality”, where very high dimensional data makes many kinds of analysis or visualization simply impossible. Building a low dimensional probabilistic representation of a complex dataset helps in understanding some of the abstract structure of very complex high dimensional data. Among these uses is in the ability to easily sample from a low dimensional space, and then generate good high dimensional examples from the original data space. It allows for optimization and visualization techniques that are impossible for very high dimensional spaces such as Bayesian Optimization[Frazier, 2018], or for tractable comparisons between data that

encodes more meaningful semantic similarity. In particular since the space of possible programs has a vary high complexity and dimensionality, if a a low dimensional latent space can be built, there are a huge variety of potential uses from program synthesis, to encoding program similarity.

### 2.1.6 Natural Language Processing

Other than computer vision, the most impactful area of application for deep learning has been natural language processing. In tasks such as machine translation and automated question answering deep learning models have clearly outperformed other kinds of models.

The first thing to notice when trying to process text in a machine learning system is the conversion from the qualitative to the quantitative. For images this is easy as pixel values are already in a numeric form, however the input of text needs processing before being able to be thrown into a neural network. The naive way to input language into a model is to use a simple one-hot encoding. One-hot vectors are vectors containing all zeros except for a single value of one at a specified index. This index is used to represent a single qualitative category, in this case a word. So a one hot encoding for text would just require a comprehensive dictionary, and mapping of every word to its corresponding index. This quickly becomes an issue as vocabularies in natural language can be very large, and the sparsity of the information for inputs makes it very difficult to learn patterns from sequences. Therefore what is commonly used is a word embedding [Mikolov et al., 2013]. A word embedding trains a separate network on a large corpora of text to predict context words, input a word in one-hot encoding and it will output a set of predicted adjacent words. After training this network it then uses the hidden layer state vector whose dimension is much less than the one-hot vector, as a dense representation for each word. This process is similar to a more data rich contextual work level autoencoder. This style of dense representation has been shown to include a lot of interesting semantic meaning (for instance the popular example is taking the vector for the work “king”, subtracting the vector for “man”, and adding the vector for “woman”, will give a vector closest to the one representing “queen”).

After encoding words into this vector space, natural language processing (NLP) becomes a task simply involving one dimensional sequences. While the most state of the art performant methods use a mechanism called Attention[Vaswani et al., 2017][Ra one dimensional convolutional models also perform very well and require



Figure 2.7: Graph Convolutional Network

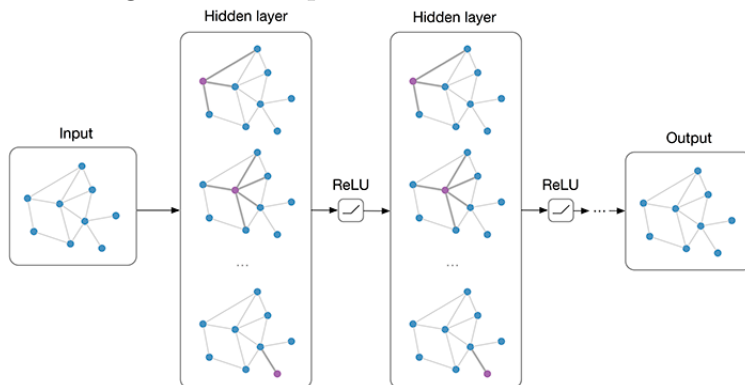

substantially fewer computational resources[Bai et al., 2018]. In this work we will be modeling programming language using these tools for natural language, as both are essentially the same as far as NLP tools are concerned. In particular this work will make use of one dimensional convolutional networks for processing the text of programs.

### 2.1.7 Graph Convolutions

While convolutions have proved to be revolutionary for image processing, and recurrent networks and attention for language; interest has grown for structures that can achieve similar results for more complicated structures than grids or sequences, and generalize to and non-euclidean topologies[Bronstein et al., 2017][Scarselli et al., 2003]. Because of the added complexity of arbitrary graphs, there is not one single method that has converged to be the best generalization of convolution to graph structures. Generally there are spectral methods that take the whole graph structure, spatial methods that aggregate local information of nodes based on neighbors, and others such as Graph Attention Network [Veličković et al., 2017] that use mechanisms like attention from NLP. For the purposes of this work we will focus on the graph representation learning work from [Pan et al., 2018] which uses the Graph Convolution concept from [Kipf and Welling, 2016]. This model uses a graph laplacian to encode local graph information into successive layers' nodes. Precisely we have a graph input defined as a vector of node values  $X$  and an adjacency matrix  $A$ . A graph convolutional layer with learnable weights  $W$  on the input graph

$\langle X, A \rangle$  with activation  $\phi$  is defined

$$f_\phi(X, A | W) = \phi(\tilde{D}^{-1/2} \tilde{A} \tilde{D}^{-1/2} X W)$$

Where  $\tilde{A} = A + I$  to add node self similarity and  $\tilde{D}_{ii} = \sum_j \tilde{A}_{ij}$  for the local aggregation and then used as  $\tilde{D}^{-1/2}$  as a symmetric normalization of the transformation. The layer outputs a vector  $Z$  which is the same shape as  $X$ , and successive layers need to utilize the same structure matrix  $A$ . However this technique has still been shown in [Pan et al., 2018] to be able to effectively encode structural information purely in the hidden state  $Z$ . Essentially what the network learns is how to propagate information in general between connected nodes.

### 2.1.8 Program Analysis

These graph layers are relevant to the program synthesis domain because programs unlike natural language have a formal graph structure underlying them. The degree to which these graph structures help in auto-encoding programs in fact is the key question of this work.

There are essentially two kinds of graph information found in programs, *syntactic* and *semantic* information. Because programs are written in programming languages, which are formal languages with a strict grammar, they have syntactic information in the form of the abstract syntax tree, which is now encodable into a graph convolutional network. Then there is semantic information, which sadly in general is an undecidable property thanks to Rice’s theorem. However there are still static program analysis techniques that can unveil useful if not fully complete information. The one covered in this work is *control flow analysis*.

Programs do not always simply execute in the linear line by line order that they are written in, instead features like loops and conditionals cause the program counter to jump around from line to line in a nonlinear fashion. While we cannot predict the exact path that the program will take, we can build up a graph the models all of the possible paths a program can take, an example of code and its corresponding graph can be seen in figure 2.8. This graph contains a lot of the overall semantic structure of the program that is invisible if purely analyzing the text. This graph is constructed depending on the language, but in general consists of a set of rules, for each kind of

Figure 2.8: Example Program and Control Flow Graph

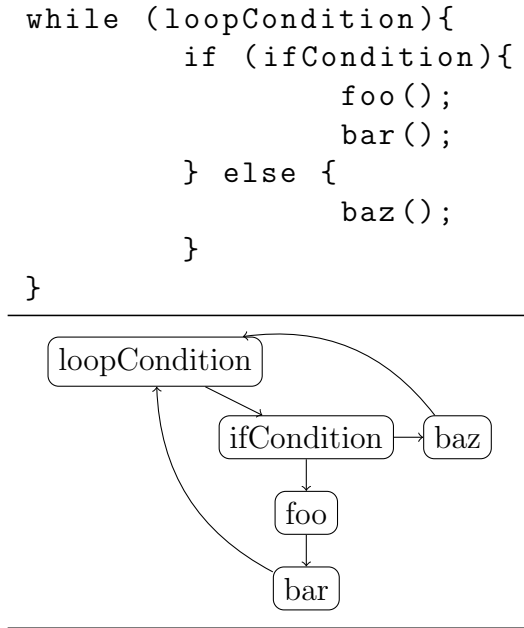

statement how does it potentially alter the flow of the program. For instance assignments simply pass the program along from the previous to the next line which would represent a single directed edge to the next line. While an if statement can send the program to one of two different points, and so two edges are added from the if statement, one to each of the potential next statements. In such a graph any kind of loop or recursion introduces a cycle, and the final graph is an overestimate of all the possible traces of a program. This kind of analysis is strictly local and breaks down when outside procedures are called or if the program modifies the program counter itself, however in the context of this work we will ignore such programs and assume all calls halt and bring the program counter back to to location from which they are called.

Section 2.1 has introduced the basics of deep learning and the classes of models that will be used in the rest of this work. It has also shown how these models might be applied to programs both as bodies of text and as formal graphs. The section 2.2 on Program Synthesis aims to give a historical overview of the field of program synthesis and place the potential applications of this work in a greater context. However it is not strictly

required to understand the methods of this work and so is more recommended than required reading.

## 2.2 Program Synthesis

### 2.2.1 History

Ever since the early days of Computer Science, Program Synthesis has been an ambitious goal. After all in a field made to automate processes, among the first tasks a computer scientist might think to automate is the work she is doing, programming. In the summer of 1957 Alonzo Church was among the first to formalize this problem, in his case as building circuits to fulfill certain mathematical properties[Church, 1957]. This mathematical and logical framework for the problem persisted during the early days of artificial intelligence research, with automata theory approaches and high level programming languages among the takes on the general problem.

However with the problem being generally considered part of the field of artificial intelligence, its advancements also fell victim to the AI winters of the seventies and the nineties. After Churches early problem statement the most influential framework is that of Manna and Waldinger in 1980[Manna and Waldinger, 1980]. The input for this framework is a first order logical formula meant to specify the properties of a function to synthesize. Then the system will construct a proof from the formula using such tools as resolution and induction to build a function that fulfills the specification as correct by construction. This method could only support very small functions, and the programming language generated is comparatively minimal. However the logical deductive strategy more or less set the direction of the field towards formal logic as the toolset for specification and construction. Logic is a sensible way to frame program synthesis, as is a compact way to write exactly the properties one might want in a program, as well as coming with lots of existing techniques for manipulating formulae in a very sound manner.

However there is a cost to using logical formulae as the underlying tool for synthesis, as writing out good logical specifications can sometimes be just as if not more difficult than the programming we are trying to automate. So instead of formal specifications, another approach is to use examples. This approach of programming by examples is appealing, as anyone regardless of

their ability to code or write formulae can simply do examples of a task that he might want the computer to automate. A popular way to formulate this approach was that of Inductive Programming. While Mana and Waldinger introduced a deductive approach, taking a general principle and deducing the specific program that fulfilled the principle; inductive programming takes specific examples and induces a more general program that is consistent with those examples.

This inductive programming was developed at much the same time as the field of Machine Learning was being defined, and has a very similar structure. Leslie Valiant in his 1984 paper for Probably Approximately Correct (PAC) Learning [Valiant, 1984] lays out the primary framework for machine learning. This approach introduced computational complexity into the problem, as well as making it a probabilistic model. This would introduce a split in artificial intelligence research, as some continued in the formal logical line, while statistical machine learning developed separately. These two branches came out of the second AI winter as squarely different fields. Statistical learning tended to gravitate towards problems in natural language as opposed to the formal languages of computer programs, while the field of formal methods came out of the turn of the century with newly efficient algorithms for boolean satisfiability and later satisfiability modulo theories that allowed first order logic formulae to be solved much more efficiently. As a result program synthesis generally remained in the logical paradigm, and in fact in many departments left AI altogether in favor of these formal methods and programming languages groups.

Then in 2012 when AlexNet[Krizhevsky et al., 2017] kickstarted the deep learning revolution in statistical machine learning, the fields began to come closer together again. Within these well defined logical frameworks, deep learning models were able to add a heuristic level improvement in solving strategies, using Neural Guided Search, NeuroSymbolic Synthesis, or Reinforcement Learning[Polozov, 2018]. While formal methods remains as the best performant of program synthesis techniques, further integration of statistical learning has opened new and exciting areas to explore. This work fits in that tradition, of deep learning techniques that can be used to potentially augment existing logical synthesis systems. The following sections will go into more depth on the workings of existing program synthesis techniques to give context for application of the deep learning model.

Table 2.1: Common Logical Connectives

Symbol (with variable(s))	Name	Meaning
$\neg a$	Negation	not $a$
$a \wedge b$	Conjunction	$a$ and $b$
$a \vee b$	Disjunction	$a$ or $b$
$a \rightarrow b$	Implication	if $a$ then $b$

## 2.2.2 Classical Formal Program Synthesis

### Formal Logic

The basis for program synthesis engines is formal logic. This section will give a brief introduction to logic, it will somewhat gloss over a lot of the nuances and intricacies as this section aims to primarily just establish a working context and vocabulary for the computational tools discussed later on. By the end of this section if a reader has no background in logic beforehand, she should be able to read logical sentences and be able to understand what they mean at an intuitive level rather than a strict formal level.

Boolean logic is a system for reasoning about the truth or falsity of various kinds of statements expressed as logical formulae. The basic kind of statement is called a logical proposition, and thus we will begin with propositional logic. A proposition has two essential components, *variables* and *connectives*. A variable is any symbol that we determine to represent the truth value of something, for instance whether it is raining which we can represent in a formula with the symbol  $r$ . Connectives combine variables in such a way that their combination is a logical statement with its own truth value. For instance we can use the connective *and* (written as  $\wedge$ ), to write the statement, that is both raining ( $r$ ) and sunny ( $s$ ) as  $r \wedge s$ . This statement has a truth value itself, depending on the values of the variables that it includes. The set of connectives that are commonly used are shown in Table 2.1. The final notational addition are special symbols that represent something that is always true ( $\top$ ) or always false ( $\perp$ ). A propositional formula can thus be defined recursively: A propositional formula is either truth ( $\top$ ), false ( $\perp$ ), a variable, or a connective of formula(e).

For example we can write out the proposition, that if it is raining ( $r$ ) then you are wet  $w$  or you have an umbrella ( $u$ ) as:

$$r \rightarrow (w \vee u) \tag{2.1}$$

This is a valid statement syntactically as it uses the connective  $\rightarrow$  between the variable  $r$  and proposition  $(w \vee u)$  which is a proposition as it is the connective  $\vee$  between variables  $w$  and  $u$ . We can express the truth of this statement, depending on the values of the variables in something called a truth table. This table lays out the semantic meaning behind the syntactic

Table 2.2: Truth Table for Equation 2.1

$r$	$w$	$u$	$r \rightarrow (w \vee u)$
$\top$	$\top$	$\top$	$\top$
$\top$	$\top$	$\perp$	$\top$
$\top$	$\perp$	$\perp$	$\perp$
$\perp$	$\top$	$\top$	$\top$
$\perp$	$\top$	$\perp$	$\top$
$\perp$	$\perp$	$\top$	$\top$
$\perp$	$\perp$	$\perp$	$\top$

logical sentence. We can use this underlying interpretation to show equivalences between statements that have the same truth table. This allows us to

Table 2.3: Equivalent Truth Table for Equation 2.1

$r$	$w$	$u$	$\neg(r \wedge \neg w \wedge \neg u)$
$\top$	$\top$	$\top$	$\top$
$\top$	$\top$	$\perp$	$\top$
$\top$	$\perp$	$\perp$	$\perp$
$\perp$	$\top$	$\top$	$\top$
$\perp$	$\top$	$\perp$	$\top$
$\perp$	$\perp$	$\top$	$\top$
$\perp$	$\perp$	$\perp$	$\top$

reason about formulae symbolically using equivalent substitutions (written  $\equiv$ ) such as  $(p \vee \neg p) \equiv \top$  or  $\neg(p \wedge q) \equiv \neg p \vee \neg q$  and so forth. The truth table primitive definitions for the common connectives are shown in Table 2.4, these connectives are then composed to form the full set of possible truth tables and thus logical sentences (in fact you don't even need all of these connectives as they can be defined in terms of each other, but this set is commonly used as primitive).

Table 2.4: Truth Tables for Common Connectives

$p$	$q$	$p \wedge q$	$p$	$q$	$p \vee q$	$p$	$q$	$p \rightarrow q$	$p$	$\neg p$
$\top$	$\top$	$\top$	$\top$	$\top$	$\top$	$\top$	$\top$	$\top$	$\top$	$\perp$
$\top$	$\perp$	$\perp$	$\top$	$\perp$	$\top$	$\top$	$\perp$	$\top$	$\top$	$\perp$
$\perp$	$\top$	$\perp$	$\perp$	$\top$	$\top$	$\perp$	$\top$	$\top$	$\perp$	$\top$
$\perp$	$\perp$	$\perp$	$\perp$	$\perp$	$\perp$	$\perp$	$\perp$	$\perp$	$\perp$	$\top$

## First Order Logic

In the propositional logic, every object is logical and has a truth table, be it a variable or proposition, everything is strictly logical. However often times we want to be able to reason about nonlogical objects, and for that we introduce a system called *First Order Logic*. The key addition in first order logic is the introduction of quantification over nonlogical variables and boolean predicates on these variables. A variable that is nonlogical exists over some domain of discourse, such as the natural numbers, these variables represent distinct objects in this domain that may have certain characteristics, but cannot be interpreted as true or false within the formula. In order to reason about these kinds of objects we define predicates, which map these abstract objects to the boolean space of true and false. For instance we can define the *odd* predicate on the natural numbers, so  $odd(3)$  is true, while  $odd(4)$  is false. This predicate is defined for any natural number in our discourse so we can abstract a specific number by the symbol  $x$  which is a non logical variable, and then  $odd(x)$  becomes a logical predicate depending on the value of  $x$ , and since it has a defined boolean value it can be used in logical formulae.

However in this case  $x$  is too abstract to reason about on its own, and so we *bind* these non logical variables using *quantifiers*. There are two quantifiers in first order logic: the existential quantifier, read as “there exists” and written as  $\exists$ , and the universal quantifier read as “for all” and written as  $\forall$ . These quantifiers bind non logical variables in formulae, and allow predicates to have determinate truth value.  $odd(x)$  on its own depends of the value of  $x$  which is free since it is an arbitrary variable, however when we say  $\exists x.odd(x)$ , or “there exists an  $x$  such that  $odd(x)$  is true” the truth of the statement is well defined. We just have to find any specific value for the symbol  $x$  within our discourse, for instance 3, that satisfies  $odd(x)$  to satisfy the statement; and since we can the statement is true.

This system is clearly very general and powerful, and unsurprisingly this



makes reasoning about arbitrary first order sentences a very hard problem. It is a generalization of propositional logic, as we can interpret the logical variables as predicates with no arguments. However despite it being difficult in general, its expressiveness makes it useful in many domains.

## Satisfiability

Now let us return to propositional logic so that we can introduce the basic problem of satisfiability, this will form the computational basis for tools that can then be generalized to harder first order logic. So consider again sentence 2.1,  $r \rightarrow (w \vee u)$ . Whether the proposition is true depends on the values of the variables. We can call a specific set of assignments to the variables an *interpretation* or a *model*. While the statement in general is defined by the truth table, a specific interpretation selects a row from that table, and thus allows the whole proposition to have a single truth value. So under the interpretation where the atoms  $\{r, u\}$  are true and  $\{w\}$  is false, the proposition can be said to be true. We can write this out by saying that the interpretation *satisfies* the formula, since it sets the variables in such a way as to make the formula true, this is written in our mathematical notation for a model  $M$  and formula  $\phi$  as:

$$M \models \phi$$

If a formula has no models that can satisfy it, we say that the formula is *unsatisfiable*, while if any model satisfies it we say the formula is *valid*. In general what we want is to be able to write formulae and then have a computer calculate either a satisfying interpretation or determine it is unsatisfiable. In general we know this is a very hard problem, as to check a formula exhaustively would require checking every row in its truth table, scaling exponentially with the number of variables. As it turns out this is perhaps the most well studied problem in computational complexity, and more or less defines the class of *NP-Complete*. However using lots of very complicated and fancy algorithms and data structures, this problem of SAT is one that is in theory very difficult, but in practice somewhat tractable. So despite a huge explosion in the worst case, much of the time for small to medium sized problems we can solve the boolean satisfiability problem.

## Satisfiability Modulo Theories

Once SAT became a tractable problem in the nineties, the next step in typical computer science fashion was to use solvers as a backend for a more expressive language and class of problems. Instead of reasoning over discrete boolean variables, we want to be able to reason in first order logic about more complicated objects like numbers or eventually programs. So we define theories for these domains in first order logic, and then use these theories in formulae to determine satisfiability, giving the Satisfiability Modulo Theories (SMT) problem. While most solvers do not allow quantifiers in the actual formulae they check, the theories used on the backend will involve first order quantifiers. This is because in general first order logic is not only NP, but undecidable, and so the full expressiveness of first order logic is limited to certain decidable subsets defining theories which can be solved computationally.

The most basic theory is that of equality and uninterpreted functions, this is sometimes called the empty theory and is used as a base for other theories. As the name suggests it introduces the equality symbol ( $=$ ) to first order logic which acts over nonlogical values. It also introduces nonlogical functions, which are called uninterpreted since they have no definition other than how they are used ( $f(x)$  does not actually calculate some function  $f$  but rather defines that there is a function  $f$  defined over the values for  $x$ ). The only requirement for functions is that they are consistent where if given the same arguments always have the same output, in formal language for any function  $f$  we have  $\forall x_1, \dots, x_n \forall y_1, \dots, y_n. (x_1 = y_1, \dots, x_n = y_n) \rightarrow f(x_1, \dots, x_n) = f(y_1, \dots, y_n)$ . This theory allows syntactic properties in whatever universe if being used to be checked. For instance we can check that two pieces of code should return the same value. In the code in algorithm 2.1, we can verify that the two functions return the same value using the theory of equality and uninterpreted functions. We do this by writing a formula that asks “Is there such a input where the outputs of the two functions differ?”. This gives the following formula

$$\begin{aligned} & (input = x) \wedge (input = a) \wedge \\ & (y = x) \wedge (z = y) \wedge (foo = mul(z, z)) \wedge \\ & (bar = mul(a, a)) \wedge \\ & \neg(bar = foo) \end{aligned}$$

The formula makes no assumptions over how the  $*$  function works, and

---

**Algorithm 2.1** Example QF\_UF

---

```
def foo(x):  
    y = x  
    z = y  
    return z * z  
  
def bar(a):  
    return a * a
```

---

yet only assuming the consistency of the function and SMT solver will quickly show that this formula is unsatisfiable as expected, showing that the functions return the same value for arbitrary inputs.

There are many theories defined for most SMT systems, like linear integer arithmetic, linear real arithmetic, bitvectors, and more; these clearly are useful in understanding programs in a logical manner and work in very standard ways, having definitions for the relevant sets of numbers and operations on them  $\{+, -, *, \leq, \text{etc...}\}$ . One of the more interesting theories that is used is the theory of arrays or the theory of memories, which is clearly vital if we aim to be able to verify and eventually synthesize programs. This theory introduces the nonlogical type of an array, which is essentially a mapping of indices to values. This involves overloading and allowing the equality operator to be defined for array types, as well as introducing two more nonlogical symbols, *read* and *write*. These definitions form the axioms of the theory:

1. Writing a value to an index can then be read from that same index as that value

$$\forall i. \text{read}(\text{write}(a, i, v)) = v$$

2. Writing to a different index does not change the value at other indices

$$\forall i, j. \neg(i = j) \rightarrow (\text{read}(\text{write}(a, i, v), j) = \text{read}(a, j))$$

3. Arrays with the same values at all indices are equal

$$(\forall i. \text{read}(a, i) = \text{read}(b, i)) \rightarrow (a = b)$$

This in conjunction with a suitable numerical theory generally forms enough of a background to reason about most programs. Solving formulae using

Figure 2.9: CEGIS Framework

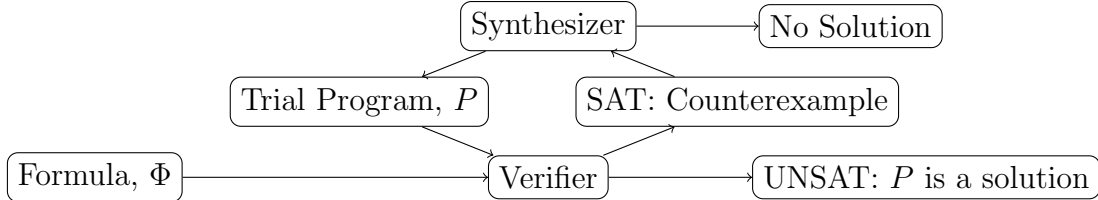

these theories generally requires solvers to build specific tactics for how to go about solving them. While some theories are harder, this division of the more complicated first order logic going on the side of standard theories allows SMT solvers to be well optimized for most use cases. Therefore all one needs to do in order to verify some property of a program is to encode the actions of the program, be it memory access or arithmetic, into these logical theories; at which point the SMT solver can check for desired properties. This on its own is a very useful application of SMT, however we aim to go one step further and actually synthesize programs that satisfy a given property.

### Syntax Guided Synthesis

Now that we have built the background in order to verify properties in programs, the next step is synthesizing programs that fulfill these properties. The framework we will introduce is called Counter Example Guided Inductive Synthesis (CEGIS) and in particular the problem within that framework of Syntax Guided Synthesis (SyGuS).

The SMT backend we have developed can be used to formalize a certain property of a program via a formula, and to verify that the property holds. Therefore the problem of synthesis is actually just a search problem, over the space of possible programs. This general paradigm is expressed in the CEGIS framework. In this framework the only hole left to fill in is the synthesizer, which has a lot of freedom in how it works. All the synthesizer now has to do is try as many different programs as it likes, and every time it gets it wrong it can potentially learn from the generated counterexample. The SyGuS problem adds one additional component of structure to the system, by stating the the synthesizer can only generate programs that comply with a specific grammar. This helps limit the search space from the whole universe of text to a small set of syntactically correct programs, so the grammar ensures syntax while SMT solver ensures semantics.

While this framework allows for potentially very advanced synthesizers, however currently the state of the art, as determined by the SyGuS competition[Padhi, 2019], utilizes essentially a well optimized enumerative solver, trying programs from the syntax exhaustively. This goes to show both how hard the problem is, that there is nothing that obviously outperforms a somewhat naive solution, and that there is still tremendous potential in developing synthesis tools. The next section will explore exciting new directions that are being researched that can fit into this overall CEGIS framework.

### 2.2.3 Neural Program Synthesis

Historically program synthesis has been squarely framed in terms of formal logic. However recent development in the CEGIS framework has opened the door for new kinds of approaches to program synthesis that do not involve logic programming or formal methods, as those components are abstracted away by the framework and computed by a separate SMT solver. This opens the door deep learning researchers to latch themselves onto yet another branch of computer science. Here there are two popular ways to integrate modern machine learning into this problem. Either building a model to learn to synthesize programs all on its own, in a reinforcement learning type setting, or using the immense amount of data generated from trying different programs to build models that can act as heuristics in other synthesizers. The latter is currently the most successful, and is in use by Microsoft Research and others and is a very active area of research[Zhang et al., 2018][Lee et al., 2018][Kalyan et al., 2018][

At the same time work has been done in representing the text of programs in embedded form more suitable for deep learning techniques[Alon et al., 2018]. This work follows that path and aims to build a semantically meaningful encoding of program text in a probabilistic latent space. This could fit into a CEGIS style solver by being able to search a lower dimensional and more semantically meaningful space of programs.

## 2.3 Similar Work

There have been a few similar works in program embeddings and it is a very new and active area of research. In [Wang et al., 2017] embedding is assisted by semantic information in the form of live program traces, using recurrent neural networks to encode information from traces. This differs

from the goal of this work which is to encode purely statically, however it does show the value of semantic information in the effectiveness of program embedding. More recently in 2019 there have been two interesting works worth comparing to. The SemCluster [Perry et al., 2019] approach clusters similar algorithms using a more formal approach, classifying code based on partitions of the input space of the program into equivalence classes. The code2vec paper [Alon et al., 2018] is the closest to this work, using a neural model to encode programs into a vector space, using both text and the abstract syntax tree. The primary difference is first in the neural architecture being used, code2vec uses an attention mechanism while this work uses convolutional and graph convolutional layers. The other primary novelty in this work is it is the first to analyze the effectiveness of these models not just on syntactic graphs, but on static semantic analysis in the form of control flow diagrams.

# Chapter 3

## Methods

### 3.1 Goals

Since the impetus for this study is in program synthesis, the goal must be to study the potential for these different models to generate programs. However full program synthesis tools in this case would add needless complication to the more restricted study of this work, therefore the program embedding goal was chosen. The task of embedding involves encoding as much information about a program text as possible, and then the ability to regenerate a program from that information as correctly as possible. This covers the core competency of program understanding and generation in the program synthesis world, while reducing the need for more complicated frameworks. The general pipeline will be like in figure 3.1, where raw code will be processed then encoded.

Therefore within the framework of embedding there are a few key evaluation metrics to use. Firstly there is the actual loss function comparing a reconstruction and original, in this case the Cross Entropy. There is also the simple accuracy, the rate at which the reconstruction correctly generates the same tokens as the original programs. There are also higher level ways to evaluate the effectiveness of the embedding, such as procedure name comparison. This is where programs are embedded anonymously without names, and then programs close to each-other in the embedding space are compared to see if they have real semantic similarity, which would be a good sign of the model embedding meaningful information about the programs.

These comparisons will be done on a few classes of models. Firstly are

Figure 3.1: General Embedding Pipeline

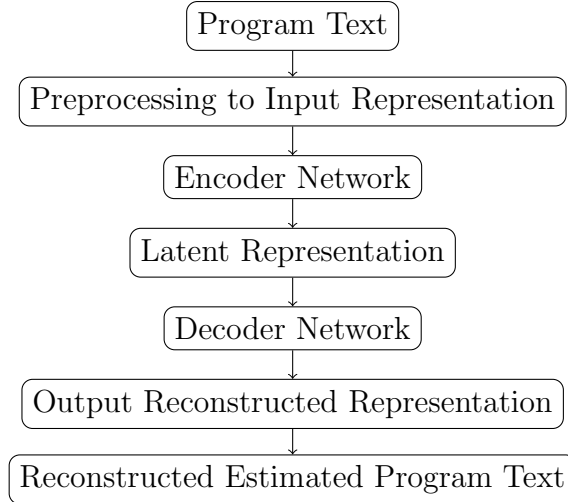

the Graph Convolutional Models. In these models it is easy to compare static analysis to a control, this is done by using two equally sized graph convolutional networks, and training one with a control flow graph as the adjacency matrix, and comparing with a linear control group that uses an adjacency matrix representing just a linear flow from token to token which is the same assumption made in normal linguistic models. This allows a truly apples to apples comparison as the networks will have identical size and design, and their only difference will be the degree to which they have been provided nontrivial analysis graph representations. The hypothesis going in to this experiment is that models using analysis graphs should significantly outperform naive models. The success or failure of this hypothesis will then be tested using the above mentioned metrics.

## 3.2 Design

### 3.2.1 Dataset

As with all machine learning problems the single most important component is the data. For this work two different datasets utilizing different programming languages were considered, initially the Natural Program Synthesis Dataset or NAPS[Zavershynskyi et al., 2018], and then a dataset of Java open source



code[Alon et al., 2018], [Allamanis et al., 2016]. While the primary insights of this work used the Java data, both provided useful information and will be described here.

The NAPS dataset aims to build a large library of 'competitive programming' solutions in order to provide a basis of 'algorithmic problems'. Competitive programming competitions, in this case from the website codeforces, emulate programming problems of the kind found in technical interviews. This involves traversing different data structures, dynamic programming, and the like. This is appealing for the program synthesis space as programs are small in the number of lines used, and strictly limited in scope consisting of a single function designed to do a single task. And while the problems are simple in one aspect, they also have among the most complex semantics, involving subtle algorithms and techniques, of other program synthesis data. This should in principle allow models to learn complex fundamentals of algorithmic thinking while being able to remain a set of unique and distant data, as opposed to natural code with complex interdependencies that does not generally lend itself to independent and identically distributed code blocks.

This dataset scrapes solutions from specific codeforces competitions, limiting itself to easy and intermediate level problems. However these competitions allow a variety of programming languages to be used, so in order to aggregate as much data into the same form as possible, compatible solutions are converted into a custom domain specific language called UAST. This DSL aims to maintain the overall readability of programs while getting rid of runtimes or compilation steps. It is converted to from the range of languages found in the codeforces competitions, Java, C++, C#, Pascal, and Python. The preprocessing done also aims to anonymize the problem specifications, and variables are all names simply in order of appearance (*var0*, *var1*, etc...). NAPS currently consists of 16410 training examples and 485 test examples as split by the original authors.

The NAPS dataset is a very exciting and ambitious new dataset, which is why it was initially chosen for this work. However ultimately the difficulty associated with the dataset outweighed the gains for the goals fo this project. Firstly the dataset is somewhat small by many deep learning standards, and initial explorations found most well performing models to be susceptible to overfitting because of this. In addition the actual programs, while not large, are highly nuanced and complex, making the task of learning their representations very difficult, which made showing differences between the different models difficult to ascertain. And so since the essential goal of this

Table 3.1: Open Source Projects Used

Project Name	Git SHA	Description
cassandra	53e370f	Distributed Database
elasticsearch	485915b	REST Search Engine
gradle	8263603	Build System
hadoop-common	42a61a4	Map-Reduce Framework
hibernate-orm	e65a883	Object/Relational Mapping
intellij-community	d36c0c1	IDE
liferay-portal	39037ca	Portal Framework
presto	4311896	Distributed SQL query engine
spring-framework	826a00a	Application Framework
wildfly	c324eaa	Application Server

work is not to build a state of the art model per se, but rather to make a strong empirical comparison between equivalent models, it was determined that a larger and easier dataset would be more appropriate.

Therefore the dataset that was ultimately used is the Java open source data from [Alon et al., 2018], [Allamanis et al., 2016]. As described in their paper [Allamanis et al., 2016], 11 open source Java projects from GitHub were clones. The most popular projects were found by taking the sum of the z-scores of the number of watchers and forks of each project, using GHTorrent [Gousios and Spinellis, 2012]. The top 11 projects were chosen that contained more than 10MB of source code files each. These projects have thousands of forks and stars, being widely known among software developers. The projects along with short descriptions are shown in Table 3.1. Using this procedure a mature, large, and diverse corpus of real source code is selected.

While using open source repositories has the benefit of a very large corpus, there is the cost of having code that is natural, and therefore being formatted in larger classes and not the small self contained blocks from NAPS. In order to make the size of each datum for our analysis tractable we then extracted methods from the raw Java classes and performed our analysis on these

processed methods. The exact procedure used to process the methods will be further explained in section 3.2.2. Despite the difficulty in using purely natural code, there are also benefits in terms of the applicability of the results of this work. Since the ultimate goal of program synthesis is in generating not just code, but ideally readable code or human-like code, the ability of models to represent code not just in a vacuum but in the real applications that need to be built is a more valuable trait to evaluate. These natural code methods are also in general much simpler than the complex puzzles found in NAPS, which means that the models are better able to represent the code and allowing for a more effective comparison between models.

### 3.2.2 Feature Engineering

Since the Java data consists of a large directory structure of raw Java files, various preprocessing had to be performed in order to extract the features and representations used in the experiment. This consists of three main phases, extracting methods from the large library of Java class files, generating the sequence of processed tokens used to represent the text of the methods, and the static analysis phases generating a control flow graph.

Since we are dealing with raw java code from real programmers, there is some variance in certain style conventions. In order to reduce variance and make different analysis steps easier, the first transformation performed on the code is some automatic formatting through Eclipse. This ensured consistent use of brackets in all situations where they are optional and other automatic formatting steps to increase verbosity.

The next step in building a dataset suitable for deep learning models is extracting the relevant text sequences. As stated before, only methods are considered as they represent the best atomic units of computation that we want to represent. This is done by traversing the tree directory structure of the different repositories in the dataset, and for each class parsing the Java code. The classes do not need to be fully compiled since we do not really care about running the code, only extracting the relevant components. The abstract syntax tree is then traversed, where all method declaration nodes are processed. Then any method that is abstract, or a constructor are ignored. This is because we are trying to consider actual computational blocks, and obviously abstract methods contain no code and constructors only have meaning in so far as they instantiate the class, which for the purposes of this work are ignored, and so constructors are also not useful. This set of method

declarations and bodies is then passed to the next processing step.

After extracting the blocks of text that are set to be analyzed, they need to be converted into a format that is workable within a machine learning setting. This involves two procedures, first is anonymization, and the second is numericalization. First is anonymization. Since point of this work is for the most part concerned with the structure of computer programs, not variable naming conventions we want to make identifier names anonymous. Also, since ultimately the full corpus of processed method text needs to be contained within a fixed sized vocabulary it would be impractical to include every variable name individually. This also has the effect where the model does not know the actual name of each method, and therefore allows for evaluation criteria involving name prediction and similarity. Therefore identifiers with unique names are replaced in text with the *id* token. Relationships between which *id* tokens refer to the same variable are then saved as well for potential use in certain models, however this is not strictly necessary for the techniques explored in this work. The anonymization however is not universal. A few common variable names that could be useful to differentiate are maintained, such as *i* and *j* (see figure 3.2). In addition to variable names, method names are important to differentiate. Recursive invocations of the method being processed (in addition to the actual name in the declaration) are replaced with the *method* token, while invocations of other methods are replaced with the *other\_method* token. This process thus transforms the specific text of each method into a general and universal vocabulary and format, and thus allows for patterns within the actual structure of methods to be learned.

Next is the numericalization process. Since the neural networks require numeric inputs as opposed to strings the sequence of tokens must be converted to a string of vectors. The first step of this process is to develop a vocabulary for the whole corpus of the dataset. Once the entire set of used tokens is known, we can represent each token by a unique number being the index of their location within that vocabulary. That index will then be converted to a one-hot encoding vector for each token, this makes each qualitatively different token independent from each other without the false quantitate information of just the raw index number. In most natural language processing tasks this process goes one step further and the one-hot encoded word representation is converted to a dense embedding, however in this case there are actually not that many different tokens that need to be considered. Due to the anonymization process, the size of the vocabulary

is tractably small and thus the network is able to function using the raw encoding of the tokens. This helps reduce the variance in our results as there does not need to be a training process to build deep embeddings for each token, and the only training process in the whole work will be the direct comparison of models. The full set of 143 tokens in the vocabulary and their frequencies is shown in table 3.2. This vocabulary includes the expected syntax of java, as well as some of the specially included identifiers (like common type names and variable names), and some common literals (like single digit integers) and additional terms for other kinds of literals. This completes the process so that the raw java is converted into sequences of tensors that can be inputted into deep learning models. The final preprocessing step is the static analysis, being the primary experimental factor in this work.

It is important to note that this process abstracts away a huge amount of information. In fact the resultant text does not super closely resemble useable code, but rather is closer to a boilerplate pseudocode template. Such a template could still be useful as an intermediary, where formal methods can fill in specific identifiers and so forth, and the template only includes high level structural information. Of course this means that the learning task being trained for is substantially limited, and as is shown later, this does have a significant effect on the result. However this is in fact a necessary evil of deep learning or pure statistical language model techniques, since these models require a fixed vocabulary that would require a certain amount of abstraction no matter what. Therefore this analysis is still meaningful in so far as it is comparing where and how deep learning models perform when augmented with formal data. Yet we must still be cognizant of the limitations of this kind of formulation.

### 3.2.3 Static Analysis Step

The final and most important step in the processing of the input data for this work is the static analysis step. In figure 3.3 the preprocessing pipeline is shown. In it can be seen the two forms of input data that are generated, the raw code sequence tensors, and the control flow graph adjacency matrix. Later models will be compared when given inputs of just the code sequence, or the code sequence with the control flow matrix and the difference in performance will be analyzed.

The static analysis being performed here is among the most simple, and making the fewest assumptions about the code as possible. In this analysis

Figure 3.2: Vocabulary Frequencies

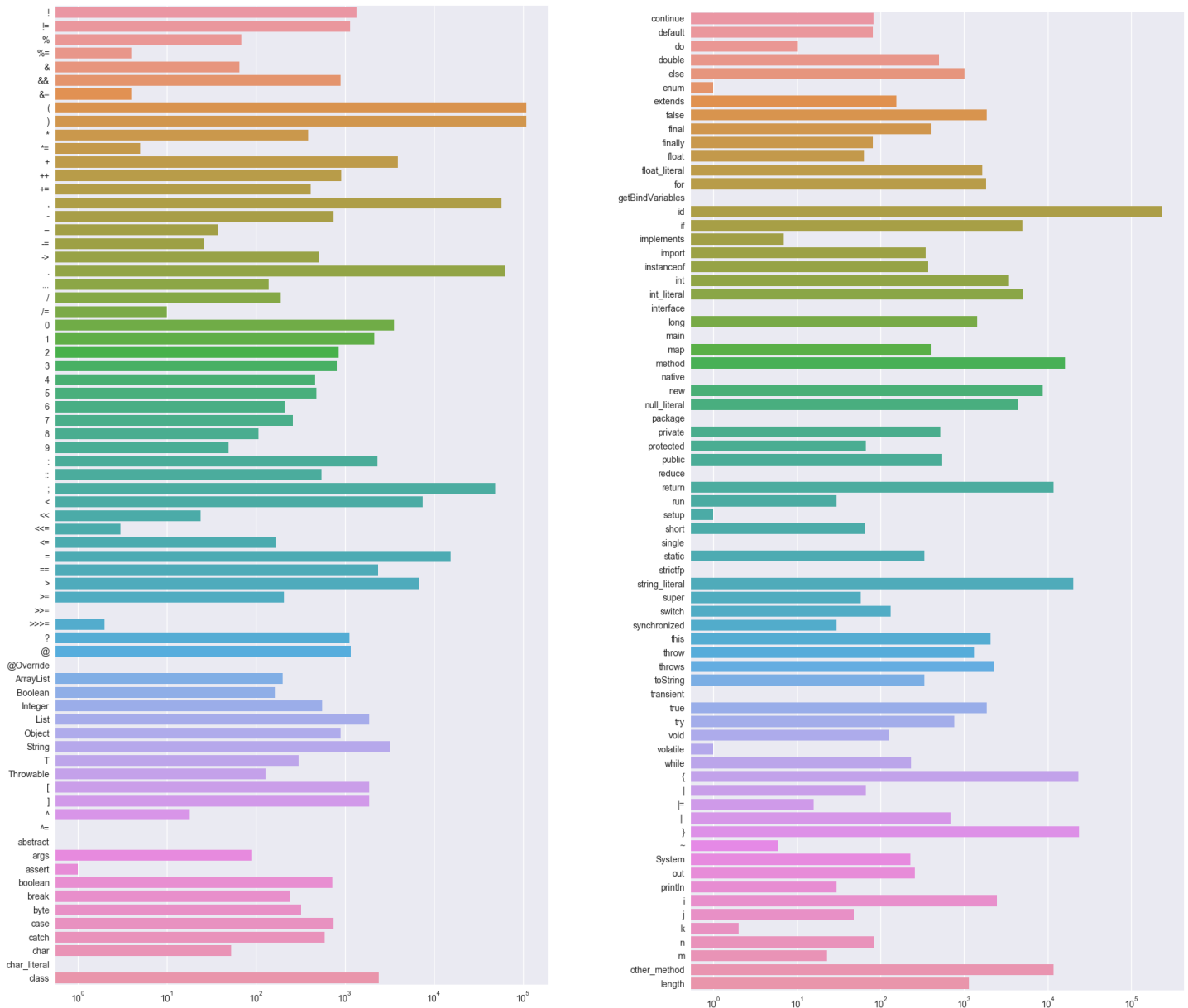
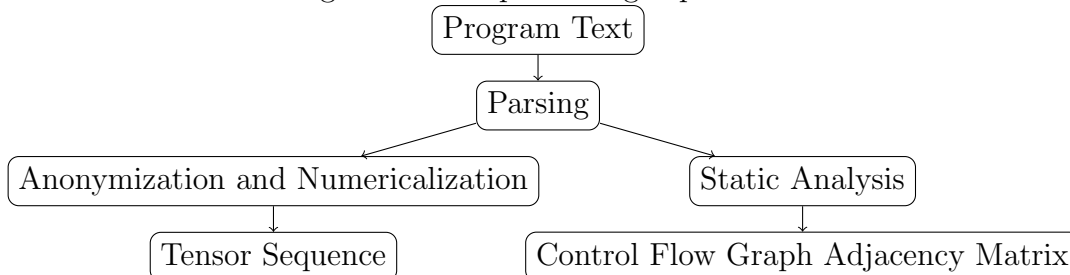

Figure 3.3: Preprocessing Pipeline



it is assumed all procedure calls halt and return back to where they were invoked. The flow of the program is modeled from token to token in order to match the dimension of the outputted matrix with the token sequence. While it is very possible to reduce the size of this graph to more basic blocks without a loss of generality, the formatting gain in this work is more valuable as it allows a cleaner way to compare the addition or subtraction of this information within the context of graph neural networks. In this vein there are a huge number of optimizations and other choices that could have been made in building this analysis system that were omitted in order to provide the most basic, comparable, baseline result possible.

Control flow from token to token is modeled through an adjacency matrix of size  $n \times n$  where  $n$  is the length of the sequence for a given method. Values of 1 at location  $i, j$  represent that there may exist a flow of the program from token  $i$  to token  $j$ . Of course since this is a simple analysis and in general information about whether such a transition will take place is undecidable this only provides a loose model of the structure of the method. However since this analysis never uses this graph in any mathematical modeling, but rather tries to learn patterns statistically from how different programs are structured this is not an issue.

For this analysis there are 7 special tokens which alter the flow from token to token, *if*, *else*, *do*, *while*, *for*, *return*, and *method*. All other tokens are assumed to simply pass control linearly along to the next token. These other special tokens however edit the control flow graph (specific implementation details for how the sequence is actually processed are in section 3.3). When encountering an *if* token there are two edges added. The graph will continue linearly through the conditional statement, however once reaching the actual enclosed code block in brackets there are two edges, one continuing flow into

the block and one skipping the block entirely and connecting the two brackets in the adjacency matrix. The *else* tokens work in much the same way, without the conditional statement (*else if* statements are therefore just modeled as equivalent to *if* statements). Clearly this is an over-approximation of real possible paths, since for instance in a simple *if...else...* combination the graph makes it possible to traverse without entering either block. However for the reasons explained earlier, this is not so much of a problem in representing the overall structure of the method in a way to be learned statistically as opposed to formally, given the inherent restrictions of static analysis.

The looping tokens of *do*, *while*, and *for* all act essentially the same in this analysis. After the condition (at the beginning of the loop for *while* and *for* and at the end of the loop for *do*) two edges are added to the graph, one representing continuing on with the rest of the program and one connecting back to the beginning of the loop, introducing a cycle into the control flow graph. The other looping mechanism considered in the analysis step is simple recursion. When encountering the *method* token, which represents the name of the current method, an edge is added from the end of the invocation to the beginning of the sequence. An edge is also added continuing on linearly with the program. This therefore implies that the recursion is not infinite and that eventually the call will terminate.

The final special token is the *return* token. When encountering this token, the flow graph will continue processing up until the next semicolon for the end of the full return statement, (this allows things like recursive calls within a return statement), and then add an edge going straight to the end of the method, and not add any other possible flows.

### 3.2.4 Other Formats

There are many different forms of static analysis that could result in other interesting graphs for this kind of experiment. This section will discuss some of those alternatives and why they were not selected.

The most obvious structure that was omitted from this work is the abstract syntax tree. The syntactic information of the AST also fits nicely within a graph structure, is easy to parse out, seems to be very representative of the overall code structure, and is used in other works on program embedding (albeit in very different ways). There are two main reasons that the AST was not part of the comparisons in this work: non-matching structure and redundant information. When parsing a method, the abstract syntax tree



will contain nodes not just from the terminal tokens, but also representing different abstract nodes from non-terminals in the grammar. This causes the structure of the AST graph to not match the raw code sequence. This means that the technique in this work of Graph Convolutional networks over the code sequence, with varying adjacency matrices could not work as the resultant graph and matrix for the AST would not 'fit' for analyzing the raw code. This would mean for the comparisons in the work either some information about the size of the AST graph would be available for the control models, or else the comparison would not be using equivalent data. This complication did not appear to be worthwhile for this work, as the only information gained from the AST is syntactic, lacking the semantic analysis information that is the heart of this comparison. This is to say that the information from the AST is redundant from what the model could learn just from the raw text.

The other kind of alternative is different kinds of static analysis. Beyond a control flow graph there are other kinds of graphs that could be generated statically from source code, from liveness analysis to last-write analysis. However almost all of these analyses are actually predicated on control flow information, and control flow information better portrays the large scale structure of the program. Therefore if control flow provides the best first order approximation of the program among static analysis techniques, and is required for more advanced analyses, then for the purposes of having the most clear baseline comparison it is the obvious choice for this work. Other frameworks may be extended as future work, however for an initial exploration analyzing the effectiveness of this class of techniques, it is better to be more limited in scope.

### 3.2.5 Neural Architectures

After the data has been processed to a form acceptable for deep learning models, these models can be trained. The primary comparison of this work utilizes the Graph Convolutional Network architecture from [Kipf and Welling, 2016] which was explained generally in section 2.1.7.

The processed data will be used to train a Graph Convolutional Autoencoder. This requires two inputs, the code sequence and adjacency matrix. The model then encodes these inputs into a smaller dimensional latent space, and then decodes that space back to produce an output sequence. Because it is an autoencoder, this output sequence is set to be the same as the input sequence, thereby measuring how well the latent space can represent and

reconstruct the program text. This work compares completely equivalently specified Graph Convolutional Autoencoders, with the only difference being the adjacency matrix that they are given during training. Figure 3.4 showcases the pipeline on how the different models are trained. There are three

Figure 3.4: Model Comparison

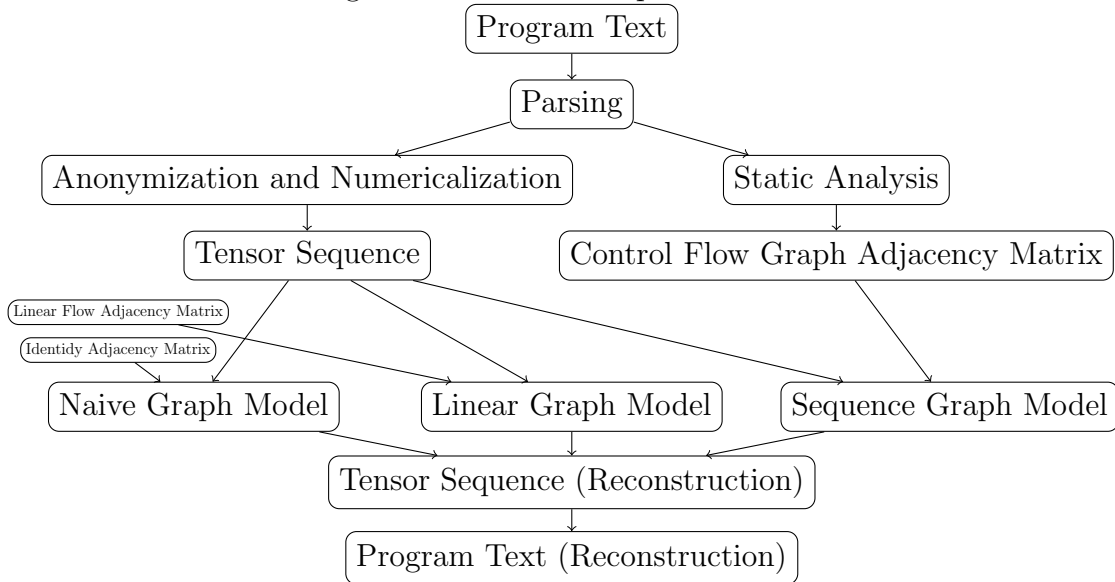

different situations this work will compare within the Graph Convolutional framework. Those are using the Control Flow or Sequence graph input, using a linear graph input, and a naive input.

The sequence graph works as described earlier, representing the sequence/flow of the program from token to token. The linear graph input makes the linguistic assumption of a simple linear sequence of tokens, this is to say the adjacency matrix given to the model consists just of nodes pointing from each token to the next in a linear fashion. Finally the naive baseline provides no graph information whatsoever to the model (which in effect inputs the identity matrix due to the workings graph convolution [Kipf and Welling, 2016]) which essentially reduces the problem to a very simple token encoding problem. Therefore using identical models, these three pipelines can test how useful the additional contextual information provided by the graphs are. The initial hypothesis being that the sequence graph will perform better than the linear which will perform better than the naive. This hypothesis will then be

Figure 3.5: Example Program and Different Graph Inputs

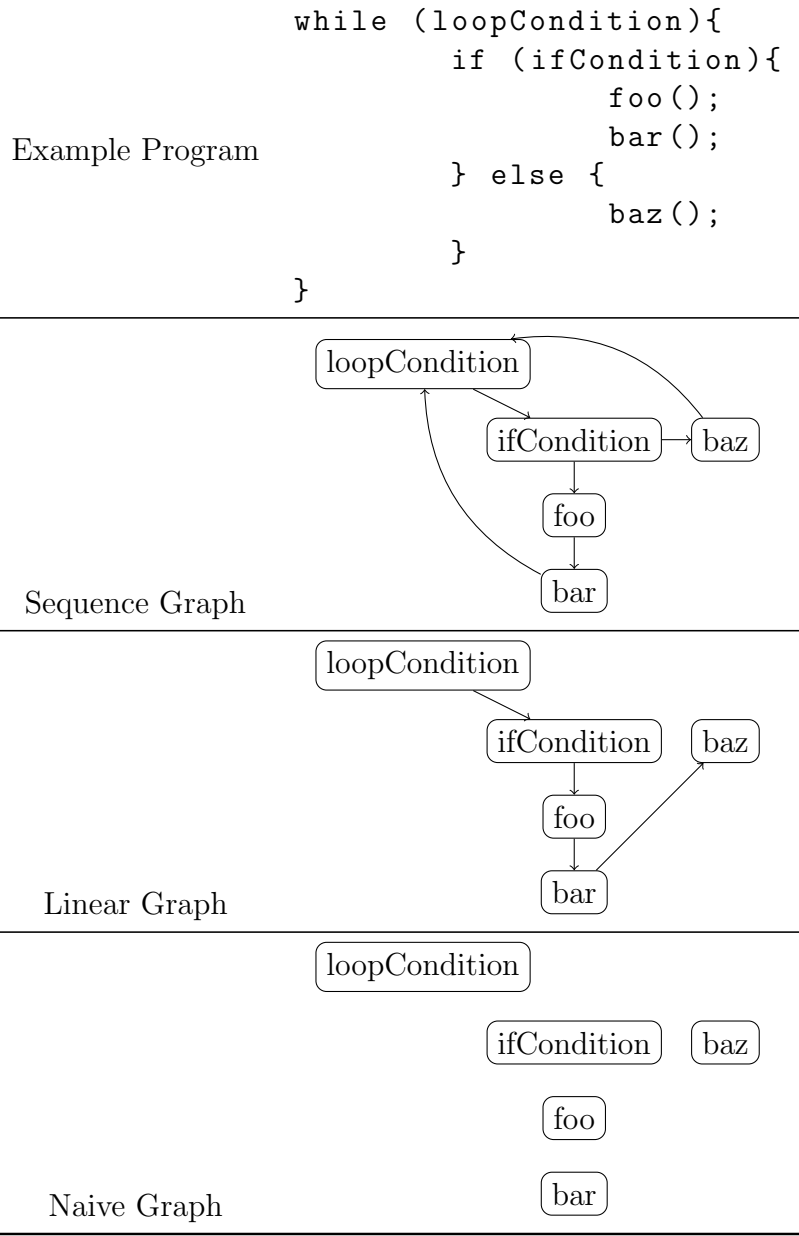

tested by training the models through the described pipeline and measuring and comparing the performance difference.

### 3.3 Implementation

This section will now provide a more detailed explanation of the implementation of the design set above, in addition the full source code can be found at <https://gitlab.doc.ic.ac.uk/aw2318/msc-individual-project/> and is also included alongside this report in the project submission. Python was chosen as the standard environment for deep learning research, and PyTorch was chosen as the deep learning framework. PyTorch was chosen over other frameworks like Tensorflow due to readability, consistency with Imperial College coursework practice, and available open source implementations. The most valuable of these reasons is the open source implementations. The Graph Convolutional Network paper has made their code open source and available on Github (<https://github.com/tkipf/pygcn>). By using this code as the basic units for the Graph Convolutional Autoencoders this work is able to ensure greater reproducibility, and avoid potential bugs. Algorithm 3.1 shows the specific code defining the GraphConvolution layer which is essentially unchanged from the original paper. Algorithm 3.2 shows the code for the full autoencoder.

The model expects input data  $x$  and  $adj$ , each being torch tensors, with shapes of  $n \times v$  and  $n \times n$  respectively where  $n$  is the length of the given code sequence, and  $v$  is the size of the vocabulary. This represents the sequence of one-hot representations of the code, and the adjacency matrix for the graph. Then depending on the *depth* parameter, this input is passed through a number of GraphConvolution layers, where the hidden states have shape  $n \times h$ , where  $h$  is the hidden size parameter, this represents the hidden state value for each node. After passing through the encoding layers, the latent value is generated by passing through a sigmoid activation and producing a latent variable sequence of size  $n \times l$  representing the code sequence. Note through all of these Graph Convolution layers, the same adjacency matrix is used unchanged, which is the same strategy used in the original work for deep Graph Convolutional Networks. Then a symmetric process is used in decoding the latent variable to a reconstructed code sequence tensor. As can be seen clearly, the model actually is independent of the size of the sequence, relying on the graph properties to propagate information. This is a benefit

---

**Algorithm 3.1** Graph Convolutional Layer

---

```
1 class GraphConvolution(Module):
2
3     def __init__(self, in_features, out_features,
4                 bias=True):
5         super(GraphConvolution, self).__init__()
6         self.in_features = in_features
7         self.out_features = out_features
8         self.weight = Parameter(torch.FloatTensor(
9             in_features, out_features))
10        if bias:
11            self.bias = Parameter(torch.FloatTensor(
12                out_features))
13        else:
14            self.register_parameter('bias', None)
15        self.reset_parameters()
16
17    def reset_parameters(self):
18        stdv = 1. / math.sqrt(self.weight.size(1))
19        self.weight.data.uniform_(-stdv, stdv)
20        if self.bias is not None:
21            self.bias.data.uniform_(-stdv, stdv)
22
23    def forward(self, input, adj):
24        support = torch.mm(input, self.weight)
25        output = torch.mm(adj, support)
26        if self.bias is not None:
27            return output + self.bias
28        else:
29            return output
30
31    def __repr__(self):
32        return self.__class__.__name__ + '␣(' \
33            + str(self.in_features) + '␣->␣' \
34            + str(self.out_features) + ')'
```

---

---

**Algorithm 3.2** Graph Convolutional Autoencoder

---

```
1 class GCAE(nn.Module):
2     def __init__(self, nfeat, nhid, nlatent, depth
      =10):
3         super(GCAE, self).__init__()
4         self.nfeat = nfeat
5         self.nhid = nhid
6         self.nlatent = nlatent
7         self.encoder_gc_init = GraphConvolution(
          nfeat, nhid, bias=False)
8         self.encoder_gc = [GraphConvolution(nhid,
          nhid, bias=False) for _ in range(depth)]
9         self.encoder_gc_final = GraphConvolution(
          nhid, nlatent, bias=False)
10        self.decoder_gc_init = GraphConvolution(
          nlatent, nhid, bias=False)
11        self.decoder_gc = [GraphConvolution(nhid,
          nhid, bias=False) for _ in range(depth)]
12        self.decoder_gc_final = GraphConvolution(
          nhid, nfeat, bias=False)
13
14        def encode(self, x, adj):
15            x = F.relu(self.encoder_gc_init(x, adj))
16            for gc in self.encoder_gc:
17                x = F.relu(gc(x, adj))
18            z = torch.sigmoid(self.encoder_gc_final(x,
          adj))
19            return z
20
21        def decode(self, z, adj):
22            x = F.relu(self.decoder_gc_init(z, adj))
23            for gc in self.decoder_gc:
24                x = F.relu(gc(x, adj))
25            x = F.relu(self.decoder_gc_final(x, adj))
26            return x
27
28        def forward(self, x, adj):
29            z = self.encode(x, adj)
30            recon = self.decode(z, adj)
31            return recon
```

meaning there does not need to be any padding and the same network can be trained directly on the various sized methods in the dataset. However because of this that means the latent space is also dependently sized, as opposed to a more standard fixed vector. This will mean that the actual latent dimension for this experiment to be meaningful will have to be very small, in order to sufficiently compress the original sequence and make the latent representation meaningful and useful.

For the experiment, models were trained with the same procedure and with the same hyperparameters, varying only the adjacency matrix. A hidden size of 32, zero additional depth layers, and a latent size of 4 were chosen, which while small by many deep learning standards were in line with the size of the dataset and compute resources available, and helped reduce model size and variance. In particular the latent size of 4 allows for visualization of program encodings, which is among the goals of the work. The training procedure utilized a Cross Entropy Loss objective function, which is common in autoencoders and in this case also frames the autoencoder as a form of classification, classifying the token value for each position. The models were also regularized using  $l_2$  regularization with a value of  $10^{-5}$ , and trained using Adam optimization [Kingma and Ba, 2014] with a learning rate of  $10^{-3}$ . Each of the three scenarios of adjacency matrix were trained over the dataset of 13000 methods over 5 epochs. These are very small models by deep learning standards. This is partially due to time and computational restrictions but also due to the heavily abstracted and simplified nature of the task. And so while it may be possible to achieve more interesting results in future works using larger networks on a less abstracted problem, this simplified problem is still able to show a few key results in the nature of how graph convolutional networks are able to encode programs and exposes certain limitations even given the small scale implementation.

# Chapter 4

## Evaluation and Analysis

After running the training procedure described above, Figure 4.1 shows the training curves for all three models showing both the training loss and accuracy (as measured as percent of tokens correctly reconstructed). Table 4.1 shows the same metrics on unseen test data. Table 4.2 shows the resultant reconstructed text of the different models for an unseen test method. As these results show, performance is substantially worse than expected, and in fact shows a trend precisely opposite to what is expected. The hypothesis predicted that the sequence graph result would outperform linear which would outperform naive graphs. In fact the naive graph vastly outperformed the other models, and there was little difference between the sequence and linear graph models. Therefore this work is forced to reject the initial hypothesis and come to some explanation of the results. And in the spirit of science, a negative result is as good as a positive result. The rest of this section will aim to analyze these results, and understand what exactly happened.

One key component that becomes clear upon analysis is the essential

Table 4.1: Test Metrics and Standard Deviations

	Mean Loss	$\sigma$	Mean Accuracy	$\sigma$
Sequence Graph	0.87364	0.743	83.0%	15.0%
Linear Graph	0.92246	0.788	83.5%	14.8%
Naive Graph	0.07852	0.146	98.5%	2.9%



Figure 4.1: Training Curves

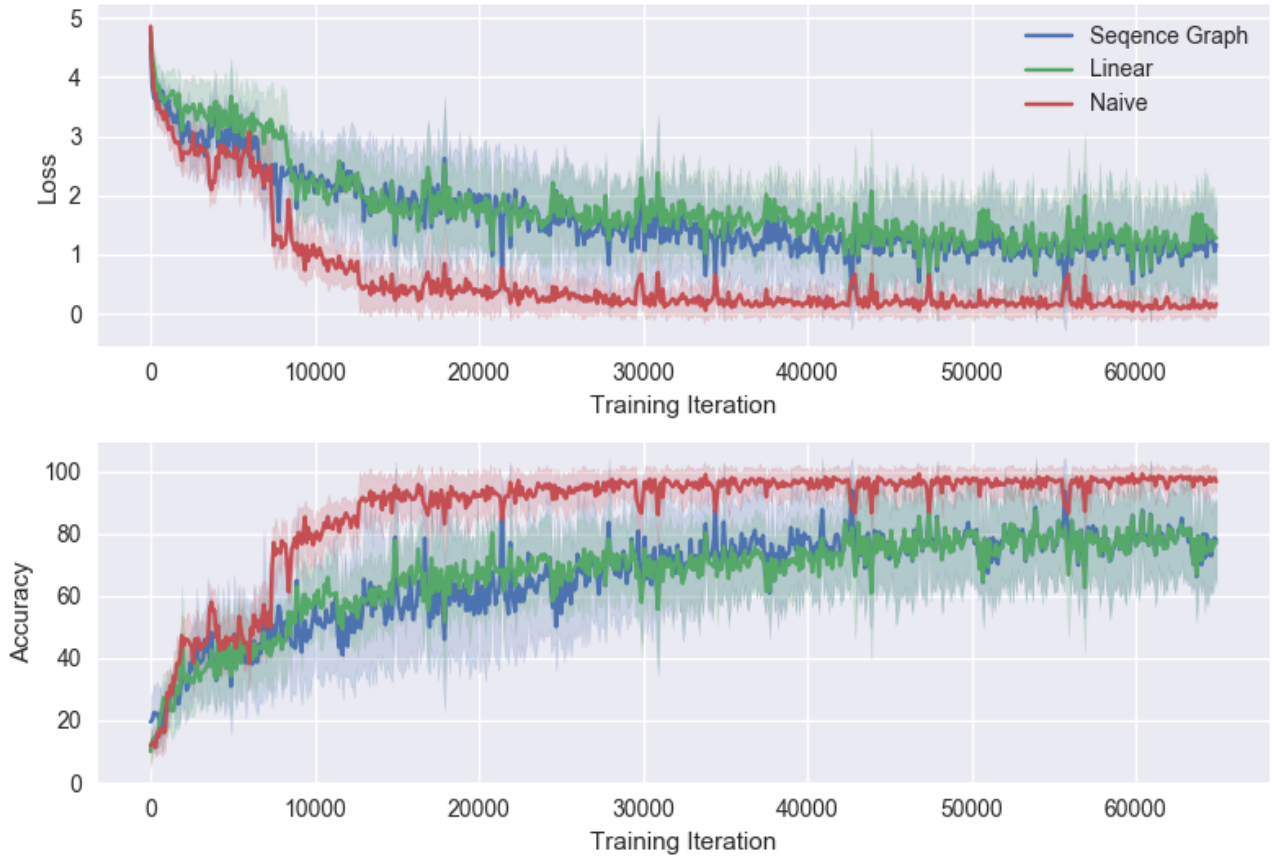

Table 4.2: Example Reconstructions

Original Code	<code>method ( int n ) { int id = 1 ; for ( int i = 2 ; i &lt;= n ; i ++ ) { id *= i ; } return id ; }</code>
Sequence Graph	<code>method ( id id ) { ; id = ; } } id id , id return return id id id ; id id ) { ) ( { ; } return id ; }</code>
Linear Graph	<code>method ( id id ) { ; ) ) ) ; id ( id id id ) ) ) ) ; id ) id id id id id ; } return id ; }</code>
Naive Graph	<code>method ( int :: ) { int id = :: ; for ( int i = :: ; i :: :: ; i ++ ) { id :: i ; } return id ; }</code>

similarity between the linear and sequence graph models. When looking closely at most of the natural code in the dataset it can be seen that the vast majority of methods are actually just simple imperative executions of small chunks of code. This makes sense within the object oriented paradigm of Java where each method aims to do one very limited function. What this means then is that this specific kind of static analysis does not actually induce a sufficiently large difference for the vast majority of programs such that these networks can learn the difference within a reasonable amount of time over the size of the data collected. In short, one of the takeaways is that *the vast majority of natural methods do not have very complicated control flows* and therefore models relying on information from control flow graphs for small segments of object oriented code (which is the vast majority of how real code is structured) have strong limitations.

Furthermore looking at example reconstructions such as in table 4.2, another pattern becomes clear. The kinds of predictions the poorly performing models are making are mostly in 'hedging their bets' and guessing many common terms in a row to get at least some tokens correct. Part of this can be attributed to the way this test was conducted, parsing more finely into individual tokens more heavily weights much of the minutiae of the program, and therefore these models learned statistically useful but practically meaningless patterns. This kind of situation may occur when the actual noise of the input signal is too great, and so the models learn to be more biased. This is a likely explanation, due to the mechanics of how graph convolution works. The transformations in Graph Convolutional Networks learn to propagate information fully locally between connected nodes (including the augmented self loops). In order for this to work it essentially aggregates all local connections together within the same weight. What this means is that in the naive case where only self loops exist the network is able to learn how each token can be encoded purely based on itself, building what amounts to a word embedding. However when introducing any linear connections, the network cannot tell the difference between an edge connecting the previous token and the self loop, or even further if there is an additional edge from the control flow, information propagates in the exact same way. What this amounts to is anything other than the self loops just introducing noise into the system, making the network more biased. Furthermore the purely local nature of these transformations means that the network cannot learn the global high level structural information that is essentially the only information that is maintained through the abstraction preprocessing. This would

be fixed in more traditional convolution by adding depth to the network, however because of the aggregation property this essentially just multiplies the noise effect when attempted. In addition experiments where the identity augmentation is removed from the graph convolutional models also produce substantially worse performance due to the inability to propagate any information in the same node from layer to layer making the model nothing more than trying to predict a token two or three tokens in the future. Essentially graph convolutional networks perform best under a number of conditions, namely strong local correlation, node agnostically, and much high density of connections than are found in control flow graphs. Due to this experiment lacking those properties, graph convolutions are a poor fit for representing programs in this way. The naive graph model is able to avoid these issues by having only the identity connections, and therefore being able to actually learn a consistent way to encode. However this encoding is not actually that insightful, as it more or less acts as a pure encoding of each individual token, containing no information about the program globally. And so while it performs well it is not very interesting. Essentially the main result of this analysis is that *graph convolutional networks do not encode information from control flow graphs well* and that in the world of program synthesis too much is lost when trying to abstract away program specifics to fit within a purely neural network based model.

# Chapter 5

## Conclusions and Future Work

The primary result of this study is that using the popular notion of Graph Convolutional Networks, augmentation with control flow graphs have no discernible gain in program embedding performance, and in fact graph convolutions in general are a poor choice for the task currently when compared to other results using linguistic models. This has implications in the development of geometric deep learning, where it would imply that while existing local methods are useful in certain applications where the graphs in question imply more basic correlation between connected nodes, there is a lack of methods interpreting nuanced global properties of the graphs. In the field of program synthesis it also implies that more purely linguistic solutions that can take advantage of more sophisticated models like attention are preferable to augmentation of less powerful models with formal analysis. And even further that the necessary abstractions required in order to fit programs into a deep learning framework remove too much nuance and thus purely statistical methods are not likely to be effective in program synthesis. Therefore it also further supports the use of CEGIS style frameworks for program synthesis, where the oracle consisting of statistical or deep learning models and the formal verifier are more separated and each task is more individually optimized, as the relevant information toward those tasks do not substantially overlap. Finally the most valuable conclusions from such a strong negative result, given that this is the first empirical evaluation of its kind and the many computational limitations and strong abstractions, is the need for replication. However if these results are replicated, it would certainly have an effect on the direction of future program synthesis research.

# Bibliography

- [Allamanis et al., 2016] Allamanis, M., Peng, H., and Sutton, C. (2016). A convolutional attention network for extreme summarization of source code. In *International Conference on Machine Learning (ICML)*.
- [Alon et al., 2018] Alon, U., Zilberstein, M., Levy, O., and Yahav, E. (2018). code2vec: Learning Distributed Representations of Code. *arXiv e-prints*, page arXiv:1803.09473.
- [Bai et al., 2018] Bai, S., Zico Kolter, J., and Koltun, V. (2018). An Empirical Evaluation of Generic Convolutional and Recurrent Networks for Sequence Modeling. *arXiv e-prints*, page arXiv:1803.01271.
- [Bronstein et al., 2017] Bronstein, M. M., Bruna, J., LeCun, Y., Szlam, A., and Vandergheynst, P. (2017). Geometric deep learning: Going beyond euclidean data. *IEEE Signal Processing Magazine*, 34(4):18–42.
- [Church, 1957] Church, A. (1957). Applications of recursive arithmetic to the problem of circuit synthesis. *Summaries of the Summer Institute of Symbolic Logic*, 1:3–50.
- [Feng et al., 2018] Feng, Y., Martins, R., Bastani, O., and Dillig, I. (2018). Program synthesis using conflict-driven learning. In *Proceedings of the 39th ACM SIGPLAN Conference on Programming Language Design and Implementation, PLDI 2018*, pages 420–435, New York, NY, USA. ACM.
- [Frazier, 2018] Frazier, P. I. (2018). A Tutorial on Bayesian Optimization. *arXiv e-prints*, page arXiv:1807.02811.
- [Gousios and Spinellis, 2012] Gousios, G. and Spinellis, D. (2012). Ghtorrent: Github’s data from a firehose. In *Proceedings of the 9th IEEE Work-*

- ing Conference on Mining Software Repositories*, MSR '12, pages 12–21, Piscataway, NJ, USA. IEEE Press.
- [Kalyan et al., 2018] Kalyan, A., Mohta, A., Polozov, O., Batra, D., Jain, P., and Gulwani, S. (2018). Neural-Guided Deductive Search for Real-Time Program Synthesis from Examples. *arXiv e-prints*, page arXiv:1804.01186.
- [Kingma and Ba, 2014] Kingma, D. P. and Ba, J. (2014). Adam: A Method for Stochastic Optimization. *arXiv e-prints*, page arXiv:1412.6980.
- [Kipf and Welling, 2016] Kipf, T. N. and Welling, M. (2016). Semi-Supervised Classification with Graph Convolutional Networks. *arXiv e-prints*, page arXiv:1609.02907.
- [Krizhevsky et al., 2017] Krizhevsky, A., Sutskever, I., and Hinton, G. E. (2017). Imagenet classification with deep convolutional neural networks. *Commun. ACM*, 60(6):84–90.
- [Lecun et al., 1998] Lecun, Y., Bottou, L., Bengio, Y., and Haffner, P. (1998). Gradient-based learning applied to document recognition. *Proceedings of the IEEE*, 86(11):2278–2324.
- [Lee et al., 2018] Lee, W., Heo, K., Alur, R., and Naik, M. (2018). Accelerating search-based program synthesis using learned probabilistic models. In *Proceedings of the 39th ACM SIGPLAN Conference on Programming Language Design and Implementation*, PLDI 2018, pages 436–449, New York, NY, USA. ACM.
- [Manna and Waldinger, 1980] Manna, Z. and Waldinger, R. (1980). A deductive approach to program synthesis. *ACM Trans. Program. Lang. Syst.*, 2(1):90–121.
- [Mikolov et al., 2013] Mikolov, T., Chen, K., Corrado, G., and Dean, J. (2013). Efficient Estimation of Word Representations in Vector Space. *arXiv e-prints*, page arXiv:1301.3781.
- [Minsky and Papert, 1988] Minsky, M. L. and Papert, S. A. (1988). *Perceptrons: Expanded Edition*. MIT Press, Cambridge, MA, USA.
- [Padhi, 2019] Padhi, S. (2019). Sygus-comp 2018 results.

- [Pan et al., 2018] Pan, S., Hu, R., Long, G., Jiang, J., Yao, L., and Zhang, C. (2018). Adversarially Regularized Graph Autoencoder for Graph Embedding. *arXiv e-prints*, page arXiv:1802.04407.
- [Perry et al., 2019] Perry, D. M., Kim, D., Samanta, R., and Zhang, X. (2019). Semcluster: Clustering of imperative programming assignments based on quantitative semantic features. *In Proceedings of the 40th ACM SIGPLAN Conference on Programming Language Design and Implementation (PLDI '19)*,, page 14.
- [Polosukhin and Skidanov, 2018] Polosukhin, I. and Skidanov, A. (2018). Neural Program Search: Solving Programming Tasks from Description and Examples. *arXiv e-prints*, page arXiv:1802.04335.
- [Polozov, 2018] Polozov, A. (2018). Program synthesis in 2017-18. <https://alexpolozov.com/blog/program-synthesis-2018/>.
- [Radford et al., 2019] Radford, A., Wu, J., Child, R., Luan, D., Amodei, D., and Sutskever, I. (2019). Language models are unsupervised multitask learners.
- [Rumelhart et al., 1988] Rumelhart, D. E., Hinton, G. E., and Williams, R. J. (1988). Neurocomputing: Foundations of research. chapter Learning Representations by Back-propagating Errors, pages 696–699. MIT Press, Cambridge, MA, USA.
- [Scarselli et al., 2009] Scarselli, F., Gori, M., Tsoi, A. C., Hagenbuchner, M., and Monfardini, G. (2009). The graph neural network model. *IEEE Transactions on Neural Networks*, 20(1):61–80.
- [Valiant, 1984] Valiant, L. G. (1984). A theory of the learnable. *Commun. ACM*, 27(11):1134–1142.
- [Vaswani et al., 2017] Vaswani, A., Shazeer, N., Parmar, N., Uszkoreit, J., Jones, L., Gomez, A. N., Kaiser, L., and Polosukhin, I. (2017). Attention Is All You Need. *arXiv e-prints*, page arXiv:1706.03762.
- [Veličković et al., 2017] Veličković, P., Cucurull, G., Casanova, A., Romero, A., Liò, P., and Bengio, Y. (2017). Graph Attention Networks. *arXiv e-prints*, page arXiv:1710.10903.

- [Wang et al., 2017] Wang, K., Singh, R., and Su, Z. (2017). Dynamic Neural Program Embedding for Program Repair. *arXiv e-prints*, page arXiv:1711.07163.
- [Wu et al., 2019] Wu, Z., Pan, S., Chen, F., Long, G., Zhang, C., and Yu, P. S. (2019). A Comprehensive Survey on Graph Neural Networks. *arXiv e-prints*, page arXiv:1901.00596.
- [Zavershynskyi et al., 2018] Zavershynskyi, M., Skidanov, A., and Polosukhin, I. (2018). NAPS: Natural Program Synthesis Dataset. *arXiv e-prints*, page arXiv:1807.03168.
- [Zhang et al., 2018] Zhang, L., Rosenblatt, G., Fetaya, E., Liao, R., Byrd, W. E., Might, M., Urtasun, R., and Zemel, R. (2018). Neural Guided Constraint Logic Programming for Program Synthesis. *arXiv e-prints*, page arXiv:1809.02840.