

Thesis presented to the Instituto Tecnológico de Aeronáutica, in partial fulfillment of the requirements for the degree of Doctor of Science in the Graduate Program of Electronics and Computing Engineering, Field of Informatics.

Gabriel de Souza Pereira Moreira

**CHAMELEON: A DEEP LEARNING
META-ARCHITECTURE FOR NEWS
RECOMMENDER SYSTEMS**

Thesis approved in its final version by signatories below:

Prof. Dr. Adilson Marques da Cunha

Advisor

Prof. Dr. Pedro Teixeira Lacava

Dean for Graduate Education and Research

Campo Montenegro
São José dos Campos, SP - Brazil
2019

Cataloging-in Publication Data
Documentation and Information Division

Moreira, Gabriel de Souza Pereira
CHAMELEON: A Deep Learning Meta-Architecture for News Recommender Systems / Gabriel de Souza Pereira Moreira.
São José dos Campos, 2019.
186f.

Thesis of Doctor of Science – Course of Electronics and Computing Engineering. Area of Informatics – Instituto Tecnológico de Aeronáutica, 2019. Advisor: Prof. Dr. Adilson Marques da Cunha.

1. Recommender Systems. 2. Deep Learning. 3. Recurrent Neural Networks. I. Instituto Tecnológico de Aeronáutica. II. Title.

BIBLIOGRAPHIC REFERENCE

MOREIRA, Gabriel de Souza Pereira. **CHAMELEON: A Deep Learning Meta-Architecture for News Recommender Systems**. 2019. 186f. Thesis of Doctor of Science – Instituto Tecnológico de Aeronáutica, São José dos Campos.

CESSION OF RIGHTS

AUTHOR'S NAME: Gabriel de Souza Pereira Moreira

PUBLICATION TITLE: CHAMELEON: A Deep Learning Meta-Architecture for News Recommender Systems.

PUBLICATION KIND/YEAR: Thesis / 2019

It is granted to Instituto Tecnológico de Aeronáutica permission to reproduce copies of this thesis and to only loan or to sell copies for academic and scientific purposes. The author reserves other publication rights and no part of this thesis can be reproduced without the authorization of the author.

Gabriel de Souza Pereira Moreira
Rua Fauze Dimas Lumumba Gonçalves, 307, Jd. Santa Inês I
12248-460 – São José dos Campos, São Paulo

CHAMELEON: A DEEP LEARNING META-ARCHITECTURE FOR NEWS RECOMMENDER SYSTEMS

Gabriel de Souza Pereira Moreira

Thesis Committee Composition:

Prof. Dr. Paulo Marcelo Tasinaffo	Presidente	-	ITA
Prof. Dr. Adilson Marques da Cunha	Advisor	-	ITA
Prof. Dr. Luiz Alberto Vieira Dias	Membro interno	-	ITA
Prof. Dr. Leandro Balby Marinho	Membro externo	-	UFCG
Prof. Dr. Rodrygo Santos	Membro externo	-	UFMG

I dedicate this work to my dear wife Luiza, for years of support and encouragement throughout my career, to my lovely children Melissa and Samuel, for understanding their busy father, to my parents Francisco and Rosângela for the education and motivation they provided me while growing and above all to my God for sustaining and inspiring me.

Acknowledgments

First at all, I would like to thank God for providing me health, intelligence, and inspiration to accomplish this research.

Then, I would like to thank my wife Luiza, who encouraged me all the time, dedicating great love, patience, and support so that I could carry out this work.

My children Melissa and Samuel, for all their love, inspiration and comprehension for their busy dad. In special, Melissa deserves the credit for the name *CHAMELEON* in the title of this research.

My parents Rosangela and Francisco, for the provided education and constant motivation that allowed me to get up to here.

My parents-in-law, for all the support to my children and for their prayers.

My sister Liliane, for being a partner of all my challenges and achievements.

Prof. Adilson Marques da Cunha, for dedicated guidance since my Masters, which I take not only for my thesis, but for life.

Prof. Dietmar Jannach, which was my mentor at the *ACM RecSys'18 Doctoral Symposium* and a great research partner during the final phase of this work.

The Brazilian Aeronautics Institute of Technology (*Instituto Tecnológico de Aeronáutica* - ITA), for providing me with an excellent learning environment and professional development.

The Globo.com, for providing context on their technical challenges on news recommendation and for sharing an exclusive large and high-quality dataset for this research.

The company CI&T, for allowing me to carry out this research in parallel with my responsibilities and to internalize the learned knowledge into my company's projects.

Finally, all family and friends who encouraged and supported me in this journey.

*“For the Lord gives wisdom;
from his mouth come knowledge and understanding.”*
— PROVERBS 2:6

Resumo

Sistemas de Recomendação (SR) têm sido cada vez mais populares para auxiliar os usuários em suas escolhas, melhorando seu engajamento e satisfação com os serviços online. Os SR se tornaram um tópico de pesquisa popular e, desde 2016, métodos e técnicas de *Deep Learning* têm sido explorados nesta área.

Os SR de notícias são projetados para personalizar a experiência dos usuários e ajudá-los a descobrir artigos relevantes em um amplo e dinâmico espaço de busca. Contudo, este é um cenário desafiador para recomendações. Grandes portais publicam centenas de notícias por dia, implicando que é necessário lidar com o crescimento acelerado do número de itens, que se tornam rapidamente obsoletos e irrelevantes para a maioria dos usuários. Pode ser observado no comportamento dos leitores de notícia que suas preferências são mais instáveis do que as de usuários de outros domínios onde sistemas de recomendação são tradicionalmente aplicados, como entretenimento (e.g., filmes, seriados, músicas). Adicionalmente, o domínio de notícias possui um alto nível de esparsidade, pois a maioria dos usuários é anônima, sem comportamento passado observado.

A principal contribuição desta pesquisa é a meta-arquitetura de *Deep Learning* CAMALEÃO, em inglês *CHAMELEON*, projetada para endereçar os desafios específicos de recomendação de notícias. Ela consiste de uma arquitetura de referência modular, que pode ser instanciada usando diferentes componentes arquiteturais de redes neurais.

Como informações sobre interações passadas de usuários são escassas no domínio de notícias, o contexto do usuário pode ser utilizado para lidar com o problema de *cold-start* de usuários. O conteúdo textual do artigo também é importante para endereçar o problema de *cold-start* de itens. Adicionalmente, o decaimento temporal da relevância dos itens (artigos) é bastante acelerado no domínio de notícias. Finalmente, acontecimentos externos importantes podem atrair temporariamente o interesse público global, um fenômeno geralmente conhecido como *concept drift* em aprendizado de máquina. Todas estas características são explicitamente modeladas nesta pesquisa por um sistema de recomendação híbrido baseado em sessões, utilizando Redes Neurais Recorrentes.

A tarefa de recomendação endereçada neste trabalho consiste na predição do próximo clique de um usuário, utilizando apenas informação disponível em sua sessão atual.

Um método é proposto para uma realística avaliação *offline* temporal de tal tarefa, reproduzindo o fluxo de interações de usuários e de novos artigos sendo continuamente publicados em um portal de notícias.

Experimentos executados nesta pesquisa, utilizando duas grandes bases de dados, mostram a efetividade do *CHAMELEON* na recomendação de notícias em muitos aspectos de qualidade, como acurácia, cobertura de catálogo de itens, capacidade de recomendar itens não-populares e redução do problema de *cold-start* de itens, quando comparado com outros algoritmos tradicionais e com o estado-da-arte para recomendação baseada em sessão.

Abstract

Recommender Systems (RS) have been increasingly popular in assisting users with their choices, thus enhancing their engagement and overall satisfaction with online services. RS have become a popular research topic and, since 2016, Deep Learning methods and techniques have been increasingly explored in this area. News RS are aimed to personalize users experiences and help them discover relevant articles from a large and dynamic search space. Therefore, it is a challenging scenario for recommendations. Large publishers release hundreds of news daily, implying that they must deal with fast-growing numbers of items that get quickly outdated and irrelevant to most readers. News readers exhibit more unstable consumption behavior than users in other domains such as entertainment. External events, like breaking news, affect readers interests. In addition, the news domain experiences extreme levels of sparsity, as most users are anonymous, with no past behavior tracked. The main contribution of this research was named *CHAMELEON*, a Deep Learning meta-architecture designed to tackle the specific challenges of news recommendation. It consists of a modular reference architecture which can be instantiated using different neural building blocks. As information about users' past interactions is scarce in the news domain, the user context can be leveraged to deal with the *user cold-start problem*. Articles' content is also important to tackle the *item cold-start problem*. Additionally, the temporal decay of items (articles) relevance is very accelerated in the news domain. Furthermore, external breaking events may temporally attract global readership attention, a phenomenon generally known as *concept drift* in machine learning. All those characteristics are explicitly modeled on this research by a contextual hybrid session-based recommendation approach using Recurrent Neural Networks. The task addressed by this research is session-based news recommendation, i.e., next-click prediction using only information available in the current user session. A method is proposed for a realistic temporal offline evaluation of such task, replaying the stream of user clicks and fresh articles being continuously published in a news portal. Experiments performed with two large datasets have shown the effectiveness of the *CHAMELEON* for news recommendation on many quality factors such as accuracy, item coverage, novelty, and reduced item cold-start problem, when compared to other traditional and state-of-the-art session-based recommendation algorithms.

List of Figures

FIGURE 2.1 – Recommender System methods taxonomy, adapted from (ISINKAYE <i>et al.</i> , 2015)	31
FIGURE 3.1 – The GRU4Rec general architecture, from (HIDASI <i>et al.</i> , 2016)	52
FIGURE 3.2 – The GRU4Rec - Session-parallel mini-batch creation, from (HIDASI <i>et al.</i> , 2016)	52
FIGURE 3.3 – The <i>GRU4Rec</i> - Mini-batch sampling, from (HIDASI <i>et al.</i> , 2016)	53
FIGURE 3.4 – The <i>CRNN</i> architecture, from (SMIRNOVA; VASILE, 2017)	55
FIGURE 3.5 – The <i>DLRec</i> architecture for recommendation, from (WU <i>et al.</i> , 2016)	56
FIGURE 3.6 – The <i>CA-RNN</i> architecture, from (LIU <i>et al.</i> , 2016)	56
FIGURE 3.7 – An example of input and transition contexts in a user purchasing sequence, from (LIU <i>et al.</i> , 2016)	57
FIGURE 3.8 – The linear user-based GRU cell, with the addition of user representation, from (DONKERS <i>et al.</i> , 2017)	58
FIGURE 3.9 – The <i>Hierarchical RNN</i> architecture for personalized session-based recommendation, from (QUADRANA <i>et al.</i> , 2017)	58
FIGURE 3.10 –The 3D-CNN architecture, from (TUAN; PHUONG, 2017)	60
FIGURE 3.11 –The <i>DeepJoNN</i> architecture, from (ZHANG <i>et al.</i> , 2018)	61
FIGURE 3.12 –The workflow of the proposed <i>SR-GNN</i> method, from (WU <i>et al.</i> , 2019)	61
FIGURE 3.13 –The <i>ConvMF</i> architecture, from (KIM <i>et al.</i> , 2016)	64
FIGURE 3.14 –The <i>D-Attn</i> architecture, from (SEO <i>et al.</i> , 2017)	65
FIGURE 3.15 –The architecture of <i>DeepCoNN</i> , from (ZHENG <i>et al.</i> , 2017)	66
FIGURE 3.16 –The <i>TransNet</i> architecture, from (CATHERINE; COHEN, 2017)	67
FIGURE 3.17 –The Architecture for text item recommendation, proposed from (BANSAL <i>et al.</i> , 2016)	68

FIGURE 3.18 –The Architecture of a Deep architecture for quote recommendation, from (LEE <i>et al.</i> , 2016)	69
FIGURE 3.19 –The <i>DKN</i> framework, from (WANG <i>et al.</i> , 2018)	71
FIGURE 3.20 –The Multi-View Deep Neural Network, from (ELKAHKY <i>et al.</i> , 2015)	72
FIGURE 3.21 –The <i>Temporal DSSM (TDSSM)</i> architecture, (SONG <i>et al.</i> , 2016) . .	74
FIGURE 3.22 –Encoder for triplets of articles, from (OKURA <i>et al.</i> , 2017)	75
FIGURE 3.23 –The <i>Recurrent Attention DSSM</i> architecture, from (KUMAR <i>et al.</i> , 2017a)	76
FIGURE 4.1 – The Conceptual Model of factors affecting news relevance for users .	79
FIGURE 4.2 – CHAMELEON - The Deep Learning Meta-Architecture for News Recommender Systems	83
FIGURE 5.1 – A <i>supervised</i> CNN-based instantiation of the <i>ACR</i> module	98
FIGURE 5.2 – A <i>supervised</i> RNN-based instantiation of the <i>ACR</i> module	99
FIGURE 5.3 – An <i>unsupervised</i> instantiation of the <i>ACR</i> module	101
FIGURE 5.4 – Illustration of the evaluation protocol. After training for 5 hours, the sessions of the next hour are evaluated.	107
FIGURE 6.1 – <i>G1</i> dataset (16 days) - Accuracy (<i>MRR@10</i>) after every 5 hours . .	114
FIGURE 6.2 – <i>Adressa</i> dataset (16 days) - Accuracy (<i>MRR@10</i>) after every 5 hours	114
FIGURE 6.3 – The Recommendation Accuracy (<i>HR@10</i>) of algorithms (lines) x Avg. Normalized Popularity (bars) by session click order	115
FIGURE 6.4 – The Correlation matrices on <i>MRR@10</i> by hour	116
FIGURE 6.5 – <i>G1</i> dataset (9 days) - Evolution over time of the <i>BFR@10</i> at 75% <i>percentile</i> of the recommendation algorithms	125
FIGURE 6.6 – <i>Adressa</i> dataset (9 days) - Evolution over time of the <i>BFR@10</i> at 75% <i>percentile</i> of the recommendation algorithms	125
FIGURE 6.7 – The trade-off between Accuracy (<i>MRR@10</i>) and Novelty (<i>ESI-R</i>) for different values of β	127
FIGURE A.1 – An illustration of a Multi-Task Learning architecture	135
FIGURE A.2 – An illustration of a <i>Sequence Autoencoder</i> , adapted from (SRIVAS- TAVA <i>et al.</i> , 2015)	135

FIGURE A.1 – A typical CNN architecture	145
FIGURE A.2 – An RNN and its unfolding in time for forward computation	147
FIGURE A.3 – The <i>Deep Semantic Structured Model (DSSM)</i> , from (HUANG <i>et al.</i> , 2013)	148
FIGURE A.4 – The <i>Convolutional Latent Semantic Model (CLSM)</i> , from (SHEN <i>et</i> <i>al.</i> , 2014)	149
FIGURE A.5 – The Word2Vec Skip-gram model, from (MIKOLOV <i>et al.</i> , 2013a)	151

List of Tables

TABLE 4.1 – Comparison among Deep Neural Architectures for News RS	91
TABLE 5.1 – Features used by the <i>Article Content Representation (ACR)</i> module.	97
TABLE 5.2 – Features used by the <i>Next-Article Recommendation (NAR)</i> module	103
TABLE 5.3 – Baseline session-based recommender algorithms used in the experiments.	106
TABLE 5.4 – Statistics of the datasets used for the experiments.	110
TABLE 6.1 – The Accuracy results from <i>G1</i> and <i>Adressa</i>	112
TABLE 6.2 – The evaluation of other quality factors for the <i>G1</i> and <i>Adressa</i> datasets	117
TABLE 6.3 – <i>The Input Configurations (IC)</i> for the <i>NAR</i> module	118
TABLE 6.4 – The Effects of different input feature configurations on recommendation quality.	119
TABLE 6.5 – The alternative content processing techniques to generate <i>ACEs</i> . . .	120
TABLE 6.6 – The Results for the <i>G1</i> dataset, with <i>CHAMELEON</i> using different <i>ACEs</i>	121
TABLE 6.7 – The Results for the <i>Adressa</i> dataset, with <i>CHAMELEON</i> using different <i>ACEs</i>	121
TABLE 6.8 – The analysis of the item cold-start problem by algorithm for the <i>G1</i> dataset	123
TABLE 6.9 – The analysis of the item cold-start problem by algorithm for <i>Adressa</i> dataset	123
TABLE 6.10 – The evaluation of <i>CHAMELEON</i> 's loss regularization factor for novelty (β)	126
TABLE C.1 – The best hyper-parameters per algorithm and dataset	141

List of Abbreviations and Acronyms

ACE	Article Content Embedding
ACM	Association for Computing Machinery
ACR	Article Content Representation module (CHAMELEON)
BERT	Bidirectional Encoder Representations from Transformers
BFR@n	Batches before First Recommendation metric
BP	Back-propagation
BPR	Bayesian Personalized Ranking
BPR-MF	Bayesian Personalized Ranking Matrix Factorization
CAR	Contextual Article Representation sub-module (CHAMELEON)
CARS	Context-Aware Recommender Systems
CB	Content-Based baseline algorithm
CBF	Content-Based Filtering
CHAMELEON	Contextual Hybrid session-bAsed MEta-architecture applying deep LEarning On News recommender systems
CET	Content Embeddings Training sub-module (CHAMELEON)
CBOW	Continuous Bag Of Words
CF	Collaborative Filtering
CNN	Convolutional Neural Network
CO	Co-Occurrence baseline algorithm
COV@n	Item Coverage metric
CTR	Click-Through Rate
DAE	Deep Auto Encoder
DBN	Deep Belief Network
DBM	Deep Boltzmann Machine
DeepJoNN	Deep Joint Network for session-based News recommendations
DFFNN	Deep Feed-Forward Neural Network
DKN	Deep Knowledge-aware network for News recommendation
DL	Deep Learning
DNN	Deep Neural Network
DRL	Deep Reinforcement Learning

DSSM	Deep Structured Semantic Model
EILD-R	Expected Intra-List Diversity with Rank-sensitivity metric
EILD-RR	Expected Intra-List Diversity with Rank- and Relevance-sensitivity metric
ESI-R@n	Expected Self-Information with Rank-sensitivity metric
ESI-RR@n	Expected Self-Information with Rank- and Relevance-sensitivity metric
HR@n	Hit Rate metric
HRNN	Hierarchical RNN
IC	Input Configuration
FF	Feed-Forward
FM	Factorization Machines
GNN	Graph Neural Networks
GRU	Gated Recurrent Unit
GRU4Rec	Gated Recurrent Unit network for Recommendation
GPU	Graphics Processing Units
IR	Information Retrieval
KNN	K-Nearest Neighbors
LDA	Latent Dirichlet Allocation
LSA	Latent Semantic Analysis
MF	Matrix Factorization
LSTM	Long Short Term Memory
MAP	Mean Average Precision
MLP	Multi-Layer Perceptron
MRR@n	Mean Reciprocal Ranking metric
MSE	Mean Squared Error
MSI	Mean Self-Information
MTL	Multi-Task Learning
MV-DNN	Multi-View Deep Neural Network
NARM	Neural Attentive Recommendation Machine
NDCG	Normalized Discounted Cumulative Gain
NAR	Next-Article Recommendation module (CHAMELEON)
NAS	Neural Architecture Search
NER	Named Entity Recognition
NLP	Natural Language Processing
PCA	Principal Component Analysis
PMF	Probabilistic Matrix Factorization
QRNN	Quasi-Recurrent Neural Networks
RA-DSSM	Recurrent Attention DSSM
RBM	Restricted Boltzmann Machine
ReLU	Rectified Linear Unit

RL	Reinforcement Learning
RMSE	Root Mean Squared Error
RNN	Recurrent Neural Network
RQ	Research Question
RRQ	Research Requirement
RR	Recommendations Ranking sub-module (CHAMELEON)
RS	Recommender Systems
SDA-GRU	Sequence Denoising GRU Autoencoder
SGD	Stochastic Gradient Descent
SER	SEssion Representation sub-module (CHAMELEON)
SR	Sequential Rules baseline algorithm
SR-GNN	Session-based Recommendation using Graph Neural Networks
STAMP	Short-Term Attention/Memory Priority Model
TDSSM	Temporal DSSM
TF-IDF	Term Frequency-Inverse Document Frequency
TFR	Textual Features Representation sub-module (CHAMELEON)
t-SNE	t-Distributed Stochastic Neighbor Embedding
UGRNN	Update Gate RNN
URL	Uniform Resource Locator (a.k.a web address)
V-SkNN	Vector Multiplication Session-Based kNN
W2V*TF-IDF	<i>TF-IDF</i> weighted <i>word2vec</i>

List of Symbols

\mathbb{A}	A set
\mathbb{R}	The set of real numbers
$a \in \mathbb{R}^d$	A vector a with dimension d
a_i	Element i of vector a , with indexing starting at 1
$A_{i,j}$	Element i, j of matrix A
$A_{i,:}$	Row i of matrix A
$A_{:,i}$	Column i of matrix A
A^\top	Transpose of matrix A
$a \oplus b$	Concatenation of vectors a and b
$a \cdot b$	Dot product between vectors a and b
$A \odot B$	Element-wise (Hadamard) product of A and B
$f(x; \theta)$	A function of x parametrized by θ .
$\ a\ $	Euclidean (L^2) norm of a vector a
$P(a)$	Probability distribution over a discrete variable
$\log(x)$	Natural logarithm of x
$x^{(i)}$	The i -th example (input) from a dataset
$y^{(i)}$	The target or label associated with $x^{(i)}$, for supervised learning

Contents

1	INTRODUCTION	23
1.1	Contextualization	24
1.2	Motivation	25
1.3	Objective	26
1.4	Research Questions	27
1.5	Research Scope	28
1.6	Presentation Order	29
2	NEWS RECOMMENDER SYSTEMS	30
2.1	Recommender Systems Background	30
2.1.1	Collaborative Filtering	30
2.1.2	Content-Based Filtering	34
2.1.3	Hybrid Recommender Systems	36
2.1.4	Recommender Systems Evaluation	36
2.2	News Recommender Systems	40
2.2.1	Content-Based Filtering for News RS	42
2.2.2	Collaborative Filtering for News RS	43
2.2.3	Hybrid RS for News RS	44
3	DEEP LEARNING FOR RECOMMENDER SYSTEMS	47
3.1	Item Embeddings and 2vec Models	48
3.2	Deep Collaborative Filtering	48
3.3	Deep Sequence-Based, Session-Based, and Session-Aware RS	50
3.3.1	The <i>GRU4Rec</i>	51

3.3.2	The Multi-modal Data for Session-based Recommendations (<i>p-RNNs</i>)	54
3.3.3	The <i>Contextual Recurrent Neural Networks (CRNN)</i>	54
3.3.4	The <i>DLRec</i>	55
3.3.5	The Recurrent Recommender Networks (RRN)	56
3.3.6	The <i>Context-Aware Recurrent Neural Network (CA-RNN)</i>	56
3.3.7	The User-based RNN	57
3.3.8	The <i>Hierarchical Recurrent Neural Networks (HRNN)</i>	58
3.3.9	The <i>Inter-Intra Session RNN (II-RNN)</i>	58
3.3.10	The <i>3D CNN</i> Recommendation Architecture	59
3.3.11	The <i>Deep Joint Network for Session-based News Recommendations (Deep JoNN)</i>	59
3.3.12	The <i>Session-Based Recommendation with Graph Neural Networks (SR-GNN)</i>	61
3.3.13	Other Session-based Approaches	62
3.4	Deep Feature Extraction from Heterogenous Data	63
3.4.1	Hybrid RS Leveraging Textual Reviews	64
3.4.2	Text Recommendations Using Deep Learning	68
3.5	Multi-View Learning for Recommender Systems	71
3.5.1	The <i>Multi-View Deep Neural Network (MV-DNN)</i>	72
3.5.2	The <i>Temporal DSSM (TDSSM)</i>	73
3.5.3	The <i>Recurrent Attention DSSM (RA-DSSM)</i>	75
4	CHAMELEON - A DEEP LEARNING META-ARCHITECTURE FOR NEWS RECOMMENDER SYSTEMS	78
4.1	The Problem Context	79
4.1.1	Factors Affecting News Relevance	79
4.1.2	News RS Challenges	80
4.2	Requirements	81
4.3	The Proposed Meta-Architecture	82
4.3.1	The <i>Article Content Representation (ACR)</i> Module	83
4.3.2	The <i>Next-Article Recommendation (NAR)</i> Module	84

4.4	Comparison with Related Works	90
4.4.1	The <i>GRU4Rec</i> and Derived Work on Session-based RS Using RNN	91
4.4.2	The <i>DSSM</i> and Derived Works on Multi-view Learning	92
4.4.3	Deep Feature Extraction from Textual Data	94
4.4.4	Balancing Accuracy and Novelty in Recommender Systems	95
5	CHAMELEON INSTANTIATIONS AND EXPERIMENTS DESIGN	97
5.1	The <i>CHAMELEON</i> Instantiations	97
5.1.1	The <i>ACR</i> Module Instantiations	97
5.1.2	The <i>NAR</i> Module Instantiations	102
5.2	Baseline Recommendation Methods	105
5.3	Evaluation Methodology	105
5.3.1	Evaluation Protocol	105
5.3.2	Metrics	107
5.3.3	Datasets	109
5.4	Implementation	110
6	MAIN RESULTS AND DISCUSSION	111
6.1	Evaluation of Recommendation Quality (RQ1)	112
6.1.1	Accuracy Analysis	112
6.1.2	Analysis of Additional Quality Factors	117
6.2	Analyzing the Importance of Input Features for the <i>NAR</i> Module (RQ2)	118
6.3	Analyzing the Effect of Textual Representation in Recommendations (RQ3)	120
6.4	Reducing the Item Cold-Start Problem for News Recommendation (RQ4)	122
6.5	Balancing Accuracy and Novelty with <i>CHAMELEON</i> (RQ5)	126
7	CONCLUSION	128
7.1	Contributions	130
7.2	Recommendations	131

7.3	Suggestions for Future Works	131
ANNEX A	– THE ACR MODULE - TRAINING OF THE SUPERVISED AND UNSUPERVISED INSTANTIATIONS	133
A.1	The Supervised ACR Module Training Method	133
A.2	The Unsupervised ACR Module Training Method	135
ANNEX B	– NOVELTY AND DIVERSITY METRICS	137
B.0.1	The ESI-R@n	137
B.0.2	The ESI-RR@n	138
B.0.3	The EILD-R@n	139
B.0.4	The EILD-RR@n	139
ANNEX C	– ALGORITHMS’ HYPER-PARAMETERS FOR EXPERI- MENTS	141
APPENDIX A	– DEEP LEARNING BACKGROUND	142
A.1	Architectures of Deep Learning	143
A.1.1	The Restricted Boltzmann Machine (RBM)	143
A.1.2	The Deep Belief Network (DBN)	143
A.1.3	The Deep Feed-Forward Neural Network (FFNN)	144
A.1.4	The Deep Auto Encoder (DAE)	144
A.1.5	The Convolutional Neural Network (CNN)	145
A.1.6	The Recurrent Neural Network (RNN)	146
A.1.7	The <i>Deep Structured Semantic Model (DSSM)</i>	148
A.2	Deep Learning for NLP	150
GLOSSARY	152
BIBLIOGRAPHY	161

1 Introduction

Recommender Systems (RS) have been increasingly popular in assisting users with their choices and helping them to filter through large information and product spaces, enhancing their engagement and satisfaction with online services (JAWAHEER *et al.*, 2014).

Typically, RS focus on two tasks: (1) *predict task*, i.e., given a user and an item, what is the user likely preference for the item; and (2) *recommendation task*, i.e., given a user, produce the best ranked list of n-items for user needs (ISINKAYE *et al.*, 2015).

RS became a topic of interest among machine learning, information retrieval, and human-computer interaction researchers (EKSTRAND *et al.*, 2011). There has been a vast amount of research in this field, mostly focusing on designing new algorithms for recommendations (SHANI; GUNAWARDANA, 2010).

Research on recommender algorithms garnered significant attention since 2006, when Netflix launched the *Netflix Prize* to improve the state of movie recommendation. The objective of this competition was to build a recommender algorithm that could beat their internal *CineMatch* algorithm in offline tests by 10% of accuracy increase (BENNETT; LANNING, 2007; GOMEZ-URIBE; HUNT, 2015). That prize motivated high activity, both in academia and amongst hobbyists. The \$1 M prize demonstrates the value that vendors place on accurate recommendations.

Perhaps the most widely-known application of recommender system technologies is Amazon.com, which has evolved its system during the last two decades (SMITH; LINDEN, 2017). They have increased sales volume by providing product recommendations based on purchase and browsing history, in addition to contextual information (e.g., the item a user is currently viewing).

Supporting discovery in information spaces of such magnitude is a significant challenge, as the sizes of these decision domains are often very large: Netflix had over 17,000 movies in its selection (BENNETT; LANNING, 2007), and Amazon.com had over 410,000 titles in its Kindle store alone (AMAZON.COM, 2010).

Recommender systems have been researched and applied in online services from different domains, like e-commerce (e.g., Amazon (LEE; HOSANAGAR, 2014)), music (BU *et*

al., 2010; OORD *et al.*, 2013; WANG; WANG, 2014) (e.g., Spotify, Pandora, Last.fm), videos (e.g. YouTube (DAVIDSON *et al.*, 2010), Netflix (GOMEZ-URIBE; HUNT, 2015)), people (BADENES *et al.*, 2014) (e.g., Facebook), jobs (BASTIAN *et al.*, 2014) (e.g., LinkedIn (KENTHAPADI *et al.*, 2017), Xing (MISHRA; REDDY, 2016)), and research papers (WANG; BLEI, 2011; BEEL *et al.*, 2013c) (e.g., Docear (BEEL *et al.*, 2013b)), among others.

Since 2016, it has steeply increased the RS research exploring Deep Learning (HINTON *et al.*, 2006; HINTON; SALAKHUTDINOV, 2006; BENGIO *et al.*, 2007; BENGIO *et al.*, 2009) architectures and methods (HIDASI *et al.*, 2017), which have already been successful in other complex domains, such as Computer Vision, Natural Language Processing (NLP), machine translation, and speech recognition.

1.1 Contextualization

The consumption of online news has increased rapidly, in contrast with the decline of traditional newspapers. By 2012, the percentage of users visiting news portals already represented the major portion of overall Web traffic (TREVISIOL *et al.*, 2014).

News recommender systems are aimed to personalize users experiences and help them discover relevant articles from a large and dynamic search space. Popular news portals such as Google News (DAS *et al.*, 2007), Yahoo! News (TREVISIOL *et al.*, 2014), The New York Times (SPANGHER, 2015), Washington Post (GRAFF, 2015; BILTON, 2016), among others, have gained increasing attentions from a massive amount of online news readers.

As an example, the Washington Post reported that when they started sending out personalized newsletters, they experienced that click-through rates for the personalized newsletters were three times the average and the overall open rate consisted of the double of the average for the Post’s newsletters (BILTON, 2016; GULLA *et al.*, 2017).

Online news recommendations have been addressed by researchers in the last years, using different families of recommendation methods: Content-Based Filtering (LI *et al.*, 2011; CAPELLE *et al.*, 2012; REN; FENG, 2013; ILIEVSKI; ROY, 2013; MOHALLICK; ÖZGÖBEK, 2017), Collaborative Filtering (DAS *et al.*, 2007) (PELÁEZ *et al.*, 2016), and Hybrid approaches (CHU; PARK, 2009; LIU *et al.*, 2010) (LI *et al.*, 2011; RAO *et al.*, 2013a; LIN *et al.*, 2014; LI *et al.*, 2014; TREVISIOL *et al.*, 2014; EPURE *et al.*, 2017).

For some domains like news and e-commerce, most users are not logged-in and their short-term reading interests must be estimated from a few interactions within its session. In this scenario, a session can be seen as a sequence of user interactions that takes place within a given time frame (QUADRANA *et al.*, 2017).

Session-based recommendation is the task of recommending relevant items given an

ongoing user session (QUADRANA *et al.*, 2018). This type of task used to be underappreciated in recommender systems, due to the usual sparsity of training data (ZHANG *et al.*, 2019). Although, in recent years, it has been observed and increased interest in session-based recommendation (QUADRANA *et al.*, 2018).

Recurrent Neural Networks (RNN) possess several properties that make them attractive for sequence modeling. In particular, they are capable of incorporating input from past consumption events, allowing to derive a wide range of sequence-to-sequence mappings (DONKERS *et al.*, 2017).

The seminal work in the usage of RNNs for session-based recommendation was the *GRU4Rec* architecture (HIDASI *et al.*, 2016), based in a type of RNN known as Gated Recurrent Unit (GRU) (CHO *et al.*, 2014a; CHUNG *et al.*, 2014). Since *GRU4Rec*, a research line emerged with subsequent works on the usage of RNNs for session-based recommendation (HIDASI *et al.*, 2016; HIDASI; KARATZOGLOU, 2018; WU *et al.*, 2016; LIU *et al.*, 2016; SMIRNOVA; VASILE, 2017). RNNs have also been explored for session-aware recommendation (DONKERS *et al.*, 2017; QUADRANA *et al.*, 2017; RUOCCO *et al.*, 2017; SKREDE, 2017), a task where the user can be identified and his previous behaviour is available, possibly helping to model his preferences (QUADRANA *et al.*, 2017).

However, as shown in (JANNACH; LUDEWIG, 2017; LUDEWIG; JANNACH, 2018; LUDEWIG *et al.*, 2019a), approaches using neural networks that rely only on information about logged interactions (non-hybrid), have certain limitations and they can, depending on the experimental setting, be outperformed by much simpler approaches for session-based recommendations, e.g., nearest-neighbor techniques.

1.2 Motivation

News portals are a challenging scenario for recommendations (ZHENG *et al.*, 2018) for a number of reasons. Large publishers release thousands of news daily, implying that they must deal with fast-growing numbers of items that get quickly outdated and irrelevant to most readers. This scenario results in an extreme level of the *item cold-start problem*, where it gets hard for the RS to learn quickly who to recommend fresh articles before they get irrelevant, in a couple of hours.

Additionally, the news domain suffers from an extreme *user cold-start problem*, as most users are anonymous, and it gets hard to learn their preferences with almost no past behavior tracked (PELÁEZ *et al.*, 2016). In such scarcity of information about the user, understanding his context might be helpful to provide meaningful recommendations.

Furthermore, news readers may exhibit more unstable consumption behavior than

users in other domains such as entertainment, as their interests usually change over time. External events reported in breaking news may also temporally attract global attention (EPURE *et al.*, 2017), a phenomenon generally known as *concept drift* in machine learning (ŽLIOBAITĚ *et al.*, 2016).

This research was motivated by the potential, envisioned by this author, of leveraging Deep Learning architectures and methods to tackle the specific challenges of news recommendation.

In special, to deal with the *user cold-start problem*, it could be leveraged contextual information from the user session. The sequence of items previously clicked in a session could be processed by a Recurrent Neural Networks (RNN). Additional contextual information, such as user location, device and session could be easily incorporated by neural networks.

To deal with the *item cold-start problem*, a typical solution is a hybrid recommendation approach, that leverages not only users behaviour, but also the items content. Deep Learning techniques have been effective in extracting relevant features from unstructured data, such as text (BANSAL *et al.*, 2016), music (OORD *et al.*, 2013) (WANG; WANG, 2014), and images (MCAULEY *et al.*, 2015; HE *et al.*, 2016).

Finally, to deal with the *concept drift*, it could be devised a protocol in which the neural networks are trained incrementally over the continuous stream of users interactions and published articles. Additionally, neural networks could be used to learn a non-linear function to model the temporal decay of news relevance.

During this research, it was identified a research gap, as only six works proposing deep neural architectures for news recommendation had been published¹, and all of those architectures addressed only one or two of the aforementioned challenges. Furthermore, those works evaluated only one aspect of recommendation quality – accuracy – and used unrealistic protocols for offline evaluation, which will hardly reproduce the online performance of those methods².

1.3 Objective

The main objective of this research is to propose a Deep Learning meta-architecture – the *CHAMELEON* – designed to tackle the specific challenges of news recommendation and improve the recommendation quality of news portals.

¹To the best of the knowledge from this research so far, the only works presenting a deep learning architecture for news recommendation were (SONG *et al.*, 2016), (KUMAR *et al.*, 2017a; KUMAR *et al.*, 2017c), (PARK *et al.*, 2017), (OKURA *et al.*, 2017), (ZHANG *et al.*, 2018), and (WANG *et al.*, 2018).

²A comparison between the *CHAMELEON* meta-architecture and those other neural architectures for news recommendation is presented in Section 4.4.

For the purpose of this research, a meta-architecture is a reference architecture that collects together decisions relating to an architecture strategy (MALAN; BREDEMEYER, 2004). A meta-architecture might be instantiated as different architectures with similar characteristics that fulfill a common task, in this case, news recommendations.

The *CHAMELEON* meta-architecture is structured to support changes, operating at the level of inputs, outputs, modules, sub-modules, and their interactions. Modules and sub-modules can be instantiated by different architectures, as they evolve. Such modular structure also make their components evaluation straightforward.

The *CHAMELEON* acronym stands for *Contextual Hybrid session-bAseed MEta-architecture applying deep LEarning On News recommender systems*.

1.4 Research Questions

This thesis addresses the following Research Questions (RQ):

- *RQ1* - How does a contextual and hybrid RS based on the proposed neural meta-architecture perform in the news domain, in terms of recommendation quality factors (accuracy, item coverage, novelty, and diversity), compared to other traditional and state-of-the-art approaches for session-based recommendation?
- *RQ2* - What is the effect on news recommendation quality factors of leveraging different types of information in a neural-based contextual hybrid RS?
- *RQ3* - What is the effect on news recommendation quality of using different textual representations, produced by statistical NLP and Deep NLP techniques?
- *RQ4* - Is a hybrid RS based in the proposed meta-architecture able to reduce the problem of *item cold-start* in the news domain, compared to other existing approaches for session-based recommendation?
- *RQ5* - Is it possible for a neural-based RS to effectively balance the trade-off between the recommendation quality factors of *accuracy* and *novelty*?

To the best of our knowledge, those research questions are explored for the first time in this research, as the other six works proposing neural-based approaches for news recommendation³ are only optimized and evaluated for recommendation accuracy, ignoring other recommendation quality attributes very important for news recommendation, such

³The existing works on neural-based news recommender systems, to the best of our knowledge, are (SONG *et al.*, 2016), (KUMAR *et al.*, 2017a; KUMAR *et al.*, 2017c), (PARK *et al.*, 2017), (OKURA *et al.*, 2017), (ZHANG *et al.*, 2018), and (WANG *et al.*, 2018).

as novelty, diversity and robustness against the *item cold-start problem*. Their evaluation protocols are not realistic, for not considering the temporal dynamics of news publishing and readership. Furthermore, those works do not investigate the individual importance of different types of information or different representations of the articles' textual content.

1.5 Research Scope

The recommendation task addressed in this work is the next-item prediction for user sessions (SMIRNOVA; VASILE, 2017), i.e., "what is the next most likely article a user might read in a session?". Supervised machine learning is employed for this task, as models are trained using past user interactions on news portals to predict future article reads (labels).

As information about users' past interactions is scarce in the extreme cold-start scenario of news recommendation and users have a constant drift on their interests. This work focuses in session-based recommendation, the most typical scenario in news portals, mostly accessed by anonymous users. The usage of session-aware recommendation algorithms in the news domain is out of the scope of this research for the aforementioned reason.

Deep neural architectures, like RNNs and Convolutional Neural Networks (CNNs), are investigated, assessed, compared, and combined to provide guidelines for instantiation, implementation, and evaluation of the proposed Deep Learning Meta-Architecture for News Recommendations: *CHAMELEON*.

Users' context and interactions and also items' static and dynamic information are combined into a contextual and hybrid recommendation approach based on neural networks. RNNs are used to model the sequence of clicks within users sessions, as additional contextual information.

The content of news articles is leveraged in a hybrid recommendation approach to counter the *item cold-start problem*. The textual representation is learned using feature extractors based on CNNs and RNNs.

The dynamics of news readership, like the temporal decay of articles relevance, is learned by the neural networks. They are trained incrementally on the clicks stream, adapting to changes in global interests and temporal seasonality.

A number of experiments address the Research Questions, stated in Section 1.4, to evaluate the quality of recommendations provided by the instantiations of the proposed meta-architecture and compared to traditional and state-of-the-art algorithms for session-based recommendation. The investigated recommendation quality factors are: (a) accuracy, (b) item coverage, (c) novelty, (d) diversity, and (e) robustness against the item

cold-start problem.

The experiments are performed on two large news portals datasets and follow a proposed temporal offline evaluation protocol to provide a more realistic evaluation, which emulates a continuous stream of user clicks, while fresh articles are published.

Regarding to other recommendation techniques, like collaborative filtering based on nearest neighbours or matrix factorization, although relevant, are out of the scope of this research work for, historically, not being successful for recommendations on the news domain.

1.6 Presentation Order

In Chapter 2, it is presented the background concepts on Recommender Systems and a survey on News Recommender Systems. Chapter 3 presents a survey of related works on Deep Learning architectures applied for Recommender Systems. In Chapter 4, the proposed Deep Learning Meta-Architecture for News Recommender Systems is presented. In Chapter 5, it is proposed some instantiations of *CHAMELEON* and the experimental design is presented. In Chapter 6, it is developed the analysis of the main experimental results and the discussion of Research Questions. Finally, in Chapter 7, the main conclusions, recommendations, and suggestions for future work are presented.

2 News Recommender Systems

This chapter describes, in the first section, the necessary background of Recommender Systems methods and evaluation approaches. The second section covers related works on News Recommender Systems.

2.1 Recommender Systems Background

Historically, people have relied on recommendations and mentions from their peers or the advice of experts to support decisions and discover new material. These methods of recommending new things have their limits, particularly for information discovery. There may be an independent film or book that a person would enjoy, but no one in their circle of acquaintances has heard of it yet. Computer-based RS provide the opportunity to expand the set of people from whom users can obtain recommendations. They also enable the mining of users history for patterns, potentially providing a more finely-tuned selection experience (EKSTRAND *et al.*, 2011).

Historical user activity is key for building user profiles capable to predict user behavior and affinities in many web applications such as targeting of online advertising, content personalization, social recommendations, and web search (AHMED *et al.*, 2011).

The main families of recommendation methods are Collaborative Filtering (CF), Content-Based Filtering (CBF), and Hybrid Filtering, as shown in Figure 2.1, which are briefly described in the next sub-sections.

This research is specially focused in Hybrid Filtering, which combines item attributes (CBF) and past user behaviours (CF) to provide recommendations, specifically in cold-start scenarios like in news portals.

2.1.1 Collaborative Filtering

Collaborative Filtering (CF) is a popular and well-known family of methods for RS. The main idea behind CF methods is that users that agree about the relevance of many

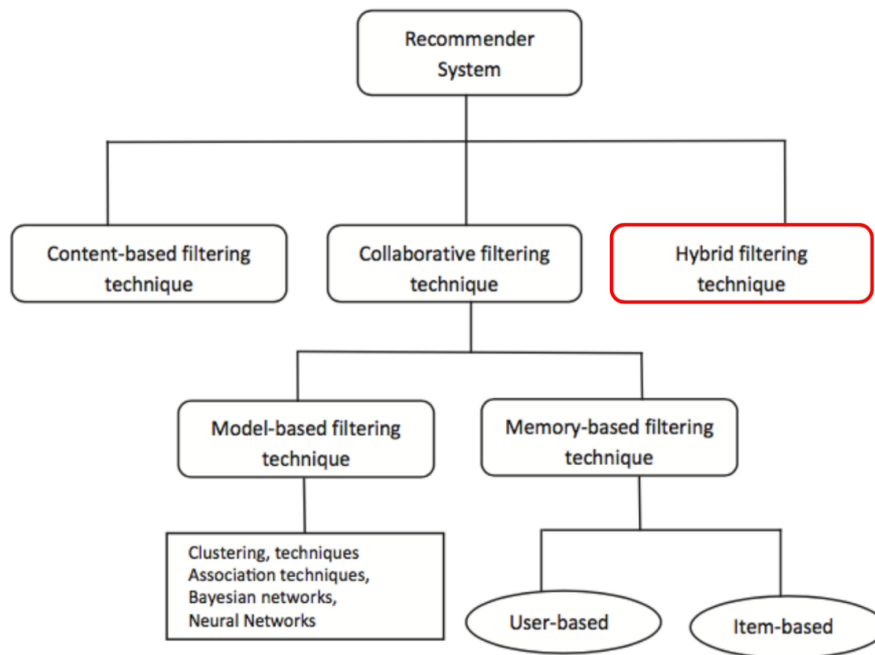

FIGURE 2.1 – Recommender System methods taxonomy, adapted from (ISINKAYE *et al.*, 2015)

items will probably have similar preferences on other items (EKSTRAND *et al.*, 2011).

Users may explicitly input their preferences through system interfaces, like *movie star ratings* on Netflix or *likes* on Facebook. However, explicit feedback is not always available. Thus, RS may infer user preferences from more abundant implicit feedback, which indirectly reflects users preferences based on user behavior. Types of implicit feedback include clicks, page views, browsing history, purchase history, search patterns, or even mouse movements. For example, a user that purchased many books by the same author probably likes that author (HU *et al.*, 2008a).

Implicit and explicit feedback provide key information for modeling users’ preferences on items and for personalizing recommendations (JAWAHEER *et al.*, 2014).

The main methods for CF are memory-based (e.g., Nearest Neighbors) and model-based (e.g., Clustering, Association Rules, Matrix Factorization, Neural Networks) (JANNACH *et al.*, 2010). Matrix Factorization (MF) is a collection of Linear algebra methods that factorizes a matrix into a product of matrices. Traditional CF techniques are based on Matrix Factorization of the User-Item matrix (KOREN *et al.*, 2009).

The main challenges of CF methods are related to the intensively researched cold-start problem. Generally, lots of items available in the system have just a few ratings per user leading to a sparse user-item matrix. In such scenario, it is difficult to match similar users by usage of their ratings in common items. The item cold-start problem occurs when an item is not rated by a substantial number of users to be eligible for recommendation,

while the user cold-start problem happens when the system has not enough users ratings to learn their preferences and make accurate recommendations (PAIXÃO, 2017).

In the next sub-sections the main approaches for CF are briefly described: (a) memory-based and (b) model-based CF (ZHANG *et al.*, 2014).

2.1.1.1 Memory-based CF

Memory-based CF was one of the first computer-based recommender methods (BREESE *et al.*, 1998). It tries to find users that are similar to the active user and uses their preferences to predict ratings for the active user (BREESE *et al.*, 1998). Ratings or interactions are used to calculate the similarity and weight between users or items.

There are several advantages of memory-based CF. First of all, since we only need to calculate similarity, it is easy to implement. Second, memory-based CF systems are scalable to large size data. Third, most of memory-based systems are online learning models. Thus, new arrival of data can be easily handled. At last, the recommendation results can be understood and can provide feedback to explain why to recommend these items (ZHENG, 2016).

However, several limitations are also existing in memory-based CF techniques. It is very slow as it uses the entire database every time it makes a prediction. The recommendation results are unreliable and not accurate, when data is sparse and common rated items are very few (THORAT *et al.*, 2015; ZHENG, 2016).

Neighbor-based CF (HERLOCKER *et al.*, 1999) – a type of memory-based recommender algorithm – was the seminal work of CF methods and involves two steps: similarity calculation and prediction. In the similarity calculation step, similarity metrics (e.g., Pearson or Cosine similarity) can be measured between users (User-kNN) or items (Item-kNN). To generate recommendations for a given user, a set of similar users (neighbors) is selected and the most preferred items from those users are recommended.

2.1.1.2 Model-based CF

Model-based CF are based on machine learning or data mining models and may leverage complex rating patterns in training data. Model-based CF algorithms are developed to counter the shortcomings of memory-based CF models (ZHENG, 2016).

There are some advantage of model-based CF algorithms, as they can improve prediction performance and are usually scalable for being a compressed version of the users behaviour patterns. Therefore, those algorithms also suffer from the sparsity problem so that it is unable to generate reasonable recommendations for those users who provide few

ratings (BETRU *et al.*, 2017).

Models like Naive Bayes (MIYAHARA; PAZZANI, 2000) and Bayesian Networks (SHEN *et al.*, 2003) were explored for recommendations in the early days. Clustering algorithms were also used as CF models, when user ratings were categorical.

Matrix Factorization (MF) (KOREN *et al.*, 2009) is the most successful collaborative filtering approach. It finds common factors in a joint latent space of user and item features, that may be the underlying reasons behind users interactions. For example, in a movie recommender system, these factors can be genre, actors, director, the special effects, or even the city where the movie was shot. In the end, MF finds a feature set for each user and item, as the result of the factorization process. After trained, the user preference for an item can be estimated by the scalar product between the factor vectors of those user and item (ZHENG, 2016).

MF proceeds by decomposing the original rating matrix $R \in \mathbb{R}^{m \times n}$ consisting of ratings by m users for n items into two low-rank matrices $U \in \mathbb{R}^{m \times d}$ and $V \in \mathbb{R}^{n \times d}$ consisting of the user and item features respectively of rank d , like in Equation 2.1.

$$R \approx U \times V \quad (2.1)$$

The system learns the latent factors by minimizing the objective function shown as follows

$$\operatorname{argmin}_{U, V} l(R, U, V) + \beta(\|U\| + \|V\|), \quad (2.2)$$

where $l(R, U, V)$ is the loss function of predicting rating using the latent factors U and V and the last term regularizes factors weights, controlled by β importance, to avoid overfitting.

The *Weighted Matrix Factorization (WMF)* version (HU *et al.*, 2008b) has also been extensively used. Other classical MF method is the *Probabilistic Matrix Factorization (PMF)* (MNIH; SALAKHUTDINOV, 2008). The underlying assumption behind this method is that the prior probability distribution of latent factors and the probability of observed ratings given the latent factors follows a Gaussian distribution.

Many algorithms have been developed to enhance the performance of *Probabilistic Matrix Factorization (PMF)*, by designing of the Bayesian versions, like *Bayesian Personalized Ranking Matrix Factorization (BPR-MF)* (RENDLE *et al.*, 2009), *Bayesian PMF* (SALAKHUTDINOV; MNIH, 2008), *Sparse Covariance Matrix Factorization (SCMF)* (SHI *et al.*, 2013), and (XU *et al.*, 2013b) or incorporating side information, such as social relationships (ADAMS *et al.*, 2010; MA *et al.*, 2011; ZHAO *et al.*, 2014).

Although efficient, matrix factorization methods suffer from the cold-start problem. Another problem often presented in many real world applications is data sparsity or reduced coverage (LI *et al.*, 2015). Incorporating side information has shown promising performance in collaborative filtering in such scenarios, like in (PORTEOUS *et al.*, 2010) (KIM; CHOI, 2014) (PARK *et al.*, 2013). But Matrix Factorization are still shallow models unable to capture complex rating of existing patterns in user interactions.

More recently, neural networks have being used for model-based CF, like in (SALAKHUTDINOV *et al.*, 2007) (WANG *et al.*, 2015), and (WU *et al.*, 2016). As neural networks for CF are key in this research, they are explored in more detail on Chapter 3.

2.1.2 Content-Based Filtering

Collaborative Filtering models suffer from the sparsity problem. For those users with no previous interactions, model-based CF is unable to generate reasonable recommendations (SCHEIN *et al.*, 2002).

Content-Based Filtering (CBF) is another family of methods which matches users and items by means of their attributes, ignoring other users behaviors. Content information is proved to be effective to reduce the *item cold-start problem* (SCHEIN *et al.*, 2002). This problem takes place when an item have being involved in very few interactions, so that there is not enough behavioral information to recommend an item (BURKE, 2007).

Content-Based Filtering (CBF) methods filters items based on the similarity of the contents the user is interested in. These approaches utilize different resources, such as item information or user profiles, to learn latent factors of users or items. In this manner, even for a user which provided little interactions, his preference can still somehow be inferred. For example, a brand new user in restaurants' recommendation system might get relevant recommendations only considering the city he lives and setting in his profile (e.g., vegetarian).

Another advantage of Content-Based Filtering (CBF) methods is that they provide transparency on how the recommender system works and recommendations are easily explainable (LI *et al.*, 2014). Thus, the user might understand recommendations provided.

A series of user studies conducted by Pu and Chen (PU; CHEN, 2006; PU; CHEN, 2007) have indicated that explanation interfaces could effectively help build users' trust in the system. Other researchers also state that explanation interfaces can cultivate user trust (SINHA; SWEARINGEN, 2002), promote loyalty, increase satisfaction, and make it easier for users to find what they want (MUHAMMAD *et al.*, 2015).

However, one important limitation of content based recommender system is that it recommends the same types of items – which is known as the *bubble effect* – and because

of that it suffers from an overspecialization problem.

A CBF popular method for text-based recommendations comes from Information Retrieval. *Term Frequency-Inverse Document Frequency (TF-IDF)* (RAMOS *et al.*, 2003) is a statistical method able to identify the most relevant words of a document, after being trained in a related corpus of documents. It creates a sparse vector representation of the documents, which can be used to compute the similarity between articles (e.g., cosine similarity). When applied for recommendation, user profiles vectors are aggregated by the weighted average of item's *TF-IDF* vectors and the most similar non-interacted items are recommended to users.

Topic Modeling, a common technique in text mining, have also being explored for CBF, matching items with the user topics of interest, automatically inferred based on his interactions on other items. Topic models provide an interpretable low-dimensional representation of documents (CHANG *et al.*, 2009). Topic models are unsupervised, which means that they do not require human labeling and are able to cluster words that co-occur in different documents.

In one of our previous work (MOREIRA; SOUZA, 2016), *TF-IDF* and Topic Modeling are used based on *Non-negative Matrix Factorization (NMF)* for content and people recommendations in an enterprise collaboration platform named Smart CanvasTM. The discovered topics were also used to provide to the users explanation for the recommendations.

Topic modeling techniques have evolved from probabilistic *Latent Semantic Analysis (LSA)* to a *Bayesian version – Latent Dirichlet Allocation (LDA)* (BLEI *et al.*, 2003). The *LDA* (BLEI *et al.*, 2003) is a graphical model which reveals how the words of each document are assumed to come from a mixture of topics. The topic proportions are document-specific, but the set of topics is shared by the corpus. For example, *LDA* can capture that one article might be about biology and statistics, while another might be about biology and physics (WANG; BLEI, 2011).

The *LDA* has been used to describe users as a mixture of topics and to assume that each of their actions is motivated by choosing a topic of interest first and subsequently words that might happen in a relevant document for the user. *LDA* has being used model users interests along time (AHMED *et al.*, 2011) or to model user context (YU *et al.*, 2012). In tag-based recommendation systems, *LDA* is also used to find the latent relation between keywords of item description and item tags created by users, such that the items can be recommended based on the tags (KRESTEL *et al.*, 2009) (SONG *et al.*, 2011).

In (TAMIR *et al.*, 2016), authors recommend textual content employing three basic steps: (1) Content understanding, (2) Profile aggregation, and (3) Matching. In the Content understanding step, *LDA* topic modeling technique is used for latent topics discovery

on content corpus. In the Profile aggregation step, user’s interests on topics are inferred based on their interactions with contents. And in the Matching step, a relevant content is recommended for each user topics of interest.

2.1.3 Hybrid Recommender Systems

Hybrid recommender systems (BURKE, 2007) emerged as various recommender strategies have matured, combining two or more algorithms into composite systems, that ideally build on the strengths of their component algorithms to achieve some synergy. One example could be, due to the inability of collaborative filtering to recommend new items, combining it with content-based filtering to minimize the cold-start problem (BURKE, 2007).

A survey conducted in (BURKE, 2002) identified seven different strategies for hybrid RS: Weighted, Switching, Mixed, Feature Combination, Feature Augmentation, Cascade, and Meta-level. In (BURKE, 2007), six of those hybrid types were explored, combining four basic recommendation methods: content-based, collaborative-filtering, heuristic collaborative, and knowledge-based, generating 41 possible hybrid combinations. The author highlighted the importance of examining the design goals for a hybridized system (overall accuracy, cold-start performance, etc.), evaluating the relative performance of each component of the hybrid system under those conditions.

One of the pioneer works that have explored the hybrid combination of textual information reviews with users rating was (JAKOB *et al.*, 2009). It found that movie reviews are usually related to different aspects, such as price, service, positive or negative feelings, and those aspects that can be exploited for rating prediction.

Some popular hybrid approaches are combining MF on user-item interactions matrix and probabilistic topic models (e.g., *LDA*) on side textual item information, like in (WANG; BLEI, 2011) for scientific articles and also in (NIKOLENKO, 2015) for sponsored content.

2.1.4 Recommender Systems Evaluation

With a large variety of algorithms available, selecting the most appropriate algorithm for a system is non-trivial (BEEL *et al.*, 2013a). Typically, such decisions are driven by an evaluation process (HERLOCKER *et al.*, 2004), based on experiments comparing the performance of a number of candidate recommenders. Such evaluations are typically performed by applying some evaluation metrics that can assess different factors of recommendation quality (SHANI; GUNAWARDANA, 2010).

There are three main RS evaluation methods: (1) user studies, (2) online evaluations,

and (3) offline evaluations (RICCI *et al.*, 2011).

In user studies or virtual lab studies (EKSTRAND *et al.*, 2011), a controlled experiment is conducted with volunteer users, which explicitly rate recommendations generated by different algorithms. The algorithm with the highest average rating is considered the best approach for a given context (RICCI *et al.*, 2011). User studies typically ask their participants to quantify their overall satisfaction with the recommendations, providing a qualitative feedback. Therefore, this approach is rarely used for recommender system evaluations (BEEL *et al.*, 2013c), due to its costs and to possible biases in the experiment.

In online evaluations or user trials (EKSTRAND *et al.*, 2011), recommendations are shown to real users of the system during their session (RICCI *et al.*, 2011). Users are not asked explicitly to rate recommendations but the recommender system observes how often a user accepts a recommendation. To compare two algorithms, recommendations using each algorithm are randomly assigned to different user sessions and the general acceptance of the algorithms recommendation is compared (A/B testing) (BEEL *et al.*, 2013a).

Offline evaluations use offline datasets of users interactions and possibly items meta-data, from which some user interactions has been removed. Subsequently, the recommender algorithms are analyzed on their ability to infer users preferences and recommend meaningful items, which are assessed based on the hidden interactions (BEEL *et al.*, 2013c). This kind of evaluation can run multiple times at a low cost, and usually deliver the results in some hours. Typically, offline evaluations are meant to identify the most promising recommendation approaches (KNIJNENBURG *et al.*, 2012), before involving users (EKSTRAND *et al.*, 2011).

2.1.4.1 Evaluation Metrics

Most results in RS are evaluated in offline setting by accuracy metrics, which measure the RS ability to recommend items that users had actually interacted (SHANI; GUNAWARDANA, 2010). One popular metric in the past was *Root Mean Squared Error (RMSE)*, used for example to evaluate ratings predictions (e.g., in a 1-5 scale) in the *Netflix Prize* (BENNETT; LANNING, 2007).

Recent research has focused in Top-N accuracy metrics, in which it is measured the relevance of the top-N recommendations from a ranked list. Many of those metrics were borrowed from Information Retrieval (IR), like accuracy metrics (e.g., Precision@N, Recall@N), and ranking metrics (e.g., *Normalized Discounted Cumulative Gain (NDCG)* (JÄRVELIN; KEKÄLÄINEN, 2002), *Mean Average Precision (MAP)*, *Mean Reciprocal Ranking (MRR)*).

Besides accuracy, coverage is another important evaluation factor. Users coverage

measures the percentage of users for which a RS is able to provide recommendations, whilst item coverage measures the percentage of items that are ever recommended (MAKSAI *et al.*, 2015). *Gini Index* and *Shannon's Entropy* have also been used as coverage metrics (SHANI; GUNAWARDANA, 2010).

Diversity is an important evaluation factor in many recommendation scenarios, like entertainment and news. If the RS only suggest similar items to the user, this may lead to poor user experiences. The most common metrics for diversity are based on dissimilarity between recommended items (ZHANG *et al.*, 2002; ZIEGLER *et al.*, 2005; RODRIGUEZ *et al.*, 2012; LI *et al.*, 2014).

Other relevant evaluation factors, specially in the news domain, are novelty and serendipity (IAQUINTA *et al.*, 2008) (MURAKAMI *et al.*, 2007).

Novelty occurs when the system suggests to the user an unknown item, that he might have autonomously discovered. (GARCIN *et al.*, 2014) define novelty as the fraction of recommended articles that are not among the most popular items. A variation of such a metric, called *surprisal*, is a weighted sum of negative log frequencies of the items in the recommendation list (ZHOU *et al.*, 2010).

Serendipity is the quality of being both unexpected and useful (MAKSAI *et al.*, 2015). A serendipitous recommendation helps the user to find a surprisingly interesting item that he could not have otherwise discovered (or it would have been really hard to discover) (IAQUINTA *et al.*, 2008). Serendipity metrics were proposed by (MURAKAMI *et al.*, 2007) and (GE *et al.*, 2010) for music and TV show recommendation.

The most popular metric for online evaluation of news recommendation is the Click-Through Rate (CTR), consisting of the ratio between the number of clicked items and the number of recommended items. The CTR is a de-facto standard in the industry, because it is often correlated to the revenues generated by the news website, from either advertisements (ads) displayed on the website or paid articles (or sometimes both) (GARCIN *et al.*, 2014). The CTR is usually very low (e.g., 0.5%), due to the fact that most users only read a low fraction of all recommended stories in a news portal (LOMMATZSCH, 2014). (GARCIN *et al.*, 2014) suggests that the *Success@k* (*Precision@k*) metric would be better than the CTR to compare offline and online evaluations.

A similar metric is Online Accuracy. While CTR consider only clicks on recommended items, online accuracy considers a recommendation as accurate if the user browsed to the recommended page in the future, even if he did not clicked immediately in the provided recommendation (MAKSAI *et al.*, 2015).

2.1.4.2 The Limitation in RS Evaluation

Offline evaluation assesses whether the RS can recommend items that users had actually clicked in the recorded history. Therefore, it is not possible to affirm that non-clicked items, which users may not be aware of, were not relevant to the user (PU *et al.*, 2011). Such limitation are addressed by live experiments in online evaluations, which are usually more costly for requiring a production recommender system in place, prepared to run A/B testing with a considerable number of users.

Logged users interactions are influenced by the page layout, by the order in which the items were presented (position bias), and also by the recommender algorithms that provided recommendations. In that setting, offline evaluation would be biased to give higher accuracy to algorithms that mimics recommenders that were in place when logs were recorded.

The best scenario for logged interactions database is when users are provided with only random recommendations, thus eliminating the bias from item positions and recommender algorithms. Although, in this setting, when no recommender systems are in place, items on the news portal front page usually attract the most clicks, creating bias towards popularity-based algorithms. In the live evaluation, the popularity-based strategy is clearly not the most interesting, because users do not want to read articles they have already seen on the front page (GARCIN *et al.*, 2014).

Evaluation with historical datasets is reproducible and convenient to test many methods, but it has a variety of shortcomings and may not generalize to real-world performance (KIRSHENBAUM *et al.*, 2012). A known challenge in recommender systems evaluation is that optimizing recommendation algorithms using offline evaluation metrics do not always correlate with online evaluation metrics and user satisfaction.

In one of our previous work (MOREIRA *et al.*, 2015), a comparison was conducted between offline and online accuracy evaluation of different algorithms and settings in a real-world content recommender system - Smart CanvasTM. The experiments have shown that, in general, offline accuracy and online CTR did not correlate well, like also observed in (BEEL *et al.*, 2013a) and (GARCIN *et al.*, 2014). An interesting finding was that by filtering only recommendations of non-popular long-tail articles, which are usually more interesting for users, it was observed better alignment between offline and online accuracies.

In (MAKSAI *et al.*, 2015), they investigated predicting the online performance of news recommendation algorithms by a regression model using offline metrics. Their results confirmed that there is more to online performance than just offline Accuracy. Other metrics, such as Coverage or Serendipity, play important roles in predicting or optimizing online metrics such as CTR. Their model can then be applied to trade-off curves for each

algorithm constructed from offline data to select the optimal algorithm and parameters.

2.2 News Recommender Systems

The problem of filtering and recommending news stories has been investigated for more than 20 years now, such as in the early work of (KONSTAN *et al.*, 1997), and it continues to be researched in the last years (PELÁEZ *et al.*, 2016; LOMMATZSCH *et al.*, 2017a; MOHALLICK; ÖZGÖBEK, 2017; EPURE *et al.*, 2017; ÖZGÖBEK *et al.*, 2014).

(KARIMI *et al.*, 2018) provides a comprehensive survey on news recommendation methods, by analyzing 112 papers with new algorithms proposals, published from 2005 to 2016. The most popular approaches were Content-Based Filtering (59 papers) and Hybrid Approaches (45 papers). Collaborative Filtering-based methods for news recommendation were proposed only by 19 papers, although CF is the method of choice in most of other recommender systems domains.

With the large volume of events being reported everyday, an important issue of online news reading services is how to provide personalized news recommendation, helping readers to find interesting stories that maximally match their reading interests (LIN *et al.*, 2014).

Differently from other domains (i.e., products or movies), news recommender systems have some peculiar characteristics. The set of items (usually news stories) universe is dynamic, where each item is expected to have a short shelf life. News stories undergoes a constant churn with new stories added every minute and old ones getting dropped (DAS *et al.*, 2007). The user-item matrix is very sparse, as most online users are anonymous and actually read few stories from the entire repository (LIN *et al.*, 2014). A high volume of news articles overload the web within limited time span. This requires more computation resources for generating fresh personalized news recommendation (MOHALLICK; ÖZGÖBEK, 2017).

Temporal modeling of users' preferences is important in many recommendation scenarios, specially for news RS (LI *et al.*, 2014; LIU *et al.*, 2010). (BILLSUS; PAZZANI, 1999a) was one of the first to find that there were two types of user interest in news reading: short-term and long-term. The short-term interest usually is related to hot news events or user context-specific interests thus changing quickly. In contrast, long term interest often reflects more stable user preferences (LIU *et al.*, 2010; SONG *et al.*, 2016).

The user context is also important for relevant recommendations to alleviate the cold-start and data sparsity issues in the existing systems. People might be interested in different topics depending on the day of the week, or even the hour (MOHALLICK; ÖZGÖBEK,

2017).

In (SAID *et al.*, 2013), they have analyzed and visualized the weekly and hourly impressions and also the CTR in the *Plista* news recommendation system (KILLE *et al.*, 2013). They found out that traditional news sources are mainly consumed during the first half of the day whereas topic-focused news receive the bulk of their interaction latter in the day. Readers of traditional news are more likely to interact with recommendations (higher CTR) than readers of topic-focused domains like motorcycles, technology, and business.

Popularity is an important readership factor, as breaking news or popular topics usually attract high attention of readers. The content popularity over time is a crucial ingredient in content management, since the commercial value of most content is varying or decaying temporally (CHU; PARK, 2009).

In (LOMMATZSCH *et al.*, 2017a) they observed that popular, medium popular, and unpopular items have different, but typical life cycles in terms of number of interactions. They proposed a simple weighted moving average approach to predict the item popularity in a near future (e.g., in the next 15 minutes), so that the trending item popularity information could be used in a recommendation model. Therefore, their proposed approach was not evaluated in the paper.

Recency or freshness is also very important because, specially in the news domain, information value decays rapidly over time (LOMMATZSCH *et al.*, 2017a). In (TREVISIOL *et al.*, 2014), they reported that in Yahoo! News, 80% of visits are received within the first 30 hours after the article publication and before the first 20% of the overall article lifespan. In (GULLA *et al.*, 2016), they conducted a log analysis on four different newspapers in Norway, and observed that readers interests on news story usually decays exponentially within 2-3 days after published, but at very different decay rates, depending on the publisher and on the article category.

According to (KARIMI *et al.*, 2018), the recency of an article can be considered in the recommendation process at three stages: pre-filtering (removing outdated news before the ranking) (DAS *et al.*, 2007; DESARKAR; SHINDE, 2014; SARANYA; SADHASIVAM, 2012), recency modeling (including recency into the recommender algorithms) (BIELIKOVÁ *et al.*, 2012; PON *et al.*, 2007; YEUNG *et al.*, 2010), and post-filtering (re-ranking relevant items according to their freshness) (LI *et al.*, 2011; MEDO *et al.*, 2009; ZHENG *et al.*, 2013). The influence of articles recency in its relevance may depend on the article topic, exceptional events, specific contextual conditions or users preferences (KARIMI *et al.*, 2018).

On typical landing pages of news portals, popularity and recency are typically the most important ranking criterion. Those properties usually form the basis of hard-to-beat non-personalized baseline recommenders, which can work for most users, generally interested in fresh and popular stories, including first-timers (DOYCHEV *et al.*, 2014; KARIMI *et al.*,

2018).

In news RS, user feedback is implicit, often described by binary ratings indicating whether a user has clicked on a news story. While clicks can be used to capture positive user interest, they don't say anything about a user's negative interest, differently from explicit feedback, like ratings (DAS *et al.*, 2007) (LIN *et al.*, 2014).

User engagement in news websites can be evaluated by different metrics such as dwell time (time the user spends reading articles) (DALLMANN *et al.*, 2017), CTR, session duration, page views, among others. The authors of (IQBAL *et al.*, 2016) propose focus ratio and active ratio, as effective metrics for tracking user engagement. Focus ratio is the difference between the time a web page has been loaded in a browser and the time that page was actually visible in the active tab. On the other hand, active ratio is the difference between the time a web page is visible in the active tab and the user is actually considered viewing or interacting with that page. Such metrics could hopefully be used as a richer implicit feedback than clicks to model user interest in a news story.

(MOHALLICK; ÖZGÖBEK, 2017) conducts a relevant review about privacy issues in news recommendation domain. The user demographic information (e.g., name, age, gender, occupation, and relationship status), contextual information like time and location, and his logged behavior in terms of page access patterns, may reveal sensible personal preferences or interests. The paper presents a set of privacy protection techniques, like anonymization, perturbation, and cryptographic procedures.

2.2.1 Content-Based Filtering for News RS

The unstructured format of the news stories makes the recommendation process difficult to analyze and might result in unreliable recommendation. News recommender systems are mostly text-centric as the news domain is rich in text and unstructured in nature (MOHALLICK; ÖZGÖBEK, 2017).

CBF methods have been used for news recommendations, as their textual content is a rich source of information. However, in some scenarios, simply representing user's profile information by a bag of words is insufficient to capture the exact reading interest of the user (LI *et al.*, 2011).

In recommendation research, news content are usually represented by using vector space model (e.g., *TF-IDF*) (BILLSUS; PAZZANI, 1999b; CAPELLE *et al.*, 2012; REN; FENG, 2013) or topic distributions obtained by language models (e.g., *LDA*). Specific similarity measurements were adopted to evaluate the relatedness between news articles (LI *et al.*, 2011). Interestingly, a user study with volunteers showed up that users' declared interest in news topics did not strongly predict their actual interest in specific news items (SELA

et al., 2015).

Typically, news articles describe the occurrence of a specific event. Named entities include when, where, what happened, who are involved, and so on. News readers might have special preference on some particular named entities contained in news articles. Thus, *Named Entity Recognition (NER)* techniques have been largely used in personalized news recommendation (LI *et al.*, 2011).

Among the first systems, the *News Dude* (BILLSUS; PAZZANI, 1999b) was a personal news recommender agent that utilizes *TF-IDF* combined with the *K-Nearest Neighbor algorithm* to recommend news items to individual users. *Newsjunkie* (GABRILOVICH *et al.*, 2004) was other system that recommended news stories by formal measures of information novelty and shows how techniques can be used to custom-tailor news feeds based on user's reading history. *YourNews* (AHN *et al.*, 2007) aimed to increase the transparency of adapted news delivery by allowing users to adapt user profiles. (LEE; PARK, 2007) present a mobile web news recommendation system, which incorporates news article attributes and user preferences with regard to categories into the modeling process.

(ILIEVSKI; ROY, 2013) proposed a probabilistic model using a set of a hand-crafted hierarchical taxonomy to represent news articles content like genre, location, keywords, and publisher.

An important limitation in CBF systems is that it tends to create stationary user profiles. That happens because recommendations tend to be always similar to the ones the user has previously seen, creating a *bubble filter*. Lack of news diversity may lead to poor user experiences (LI *et al.*, 2014). When visiting a news website, the user is looking for new information, information that he did not know before, that may even surprise him (LIU *et al.*, 2010).

A typical approach to tackle this issue of CBF is to model news diversity, as dissimilarity between news. (ZHANG; HURLEY, 2008) recommend news articles with diverse topics in a single recommendation session. In (LI *et al.*, 2011), they explicitly consider the diversity among news items in the recommended list, modeled as a budgeted maximum coverage problem.

2.2.2 Collaborative Filtering for News RS

There were few works using collaborative filtering (content agnostic) for news recommendations, i.e., ignoring articles content and using only users behaviour.

Google News presented their CF method in (DAS *et al.*, 2007). They used three approaches, combined using a linear model: collaborative filtering, by using *MinHash* clustering; *Probabilistic Latent Semantic Indexing (PLSI)*; and co-visitation counts.

In (PELÁEZ *et al.*, 2016), they use matrix factorization to learn mapping of users and items into a common Euclidean space, where the similarities can be computed in a linear geometric context. The purpose was to suggest for each reader an ordered list of news that other readers with similar trajectories have seen in the past.

2.2.3 Hybrid RS for News RS

Hybrid RS have being popular for news recommendations, in which the inability of collaborative filtering to recommend news items is commonly alleviated by combining it with content-based filtering, like in (CHU; PARK, 2009) and (RAO *et al.*, 2013a).

In a subsequent work from Google News researchers (LIU *et al.*, 2010), a Bayesian hybrid framework was introduced, combining CF models presented in (DAS *et al.*, 2007) with a probabilistic CBF model, which uses news categories and takes into account global news trends. By analyzing Google News large-scale logs to measure the stability of users' news interests, they found out that their interests do vary over time but follow the aggregate local news interest trends.

Recommender Systems often face the exploration/exploitation problem, where two competing goals must be balanced: exploiting user previous choices to provide accurate recommendations, and exploring his other possible interests, not specifically related to his previous choices, to reduce overspecialization. In (LI *et al.*, 2010), Yahoo! researchers model news recommendations as a contextual bandit problem, a principled approach in which a learning algorithm sequentially selects articles to serve users based on contextual information of the user and articles, while simultaneously adapting its article-selection strategy based on user-click feedback to maximize total user clicks in the long run.

(CHU; PARK, 2009) proposed a hybrid feature-based machine learning approach for personalized news recommendation to handle the cold-start problem. They build content profiles combining static and dynamic characteristics (e.g., popularity and freshness), which are updated in real time. User profiles of users included demographic information and a summary of user activities within Yahoo! properties. Based on all features in user and content profiles, they used bi-linear regression models to provide personalized recommendations of new items for both existing and new users.

The *SCENE* (LI *et al.*, 2011) method performs a two-stage clustering on both news attributes (e.g., textual content, named entities) along with their special properties (popularity and recency), and user access patterns. *SCENE* is composed of three major components: Newly-Published News Articles Clustering, User Profile Construction, and Personalized News Items Recommendation. For personalization, user's profile is constructed in three different dimensions - news topic distribution, similar access patterns,

and news entity preference.

In (KIRSHENBAUM *et al.*, 2012), a live comparison of 20 different methods for personalized article recommendation was performed at *forbes.com*. The winning method was a hybrid of item-item collaborative filtering and a content-based *TF-IDF* method, including Wikipedia-based features and a Bayesian score remapping technique.

(LIN *et al.*, 2014) proposed *PRemiSE*, a hybrid system that embeds content-based (named entities from news stories), collaborative filtering, and social networking approaches into a unified probabilistic framework, to produce predictions that balance the content of news, the reading preferences of users, and recommendations from "experts". The social networks and experts are virtual and inferred from user's access logs, by using the information diffusion theory.

In (LI *et al.*, 2014), long-term user history was leveraged to provide coarse grain news recommendation for certain news groups. The short-term history of the user was then used to recommend specific news articles within the selected groups. They select news items from the user-item affinity graph, by using an absorbing random walk model to increase the diversity of the recommended news list.

In (LOMMATZSCH, 2014), they describe how they won the *Plista* news recommendations contest, which allowed research teams to compete by providing the best recommendations for real users (online evaluation). In that work, they implemented a context-aware delegation strategy, which selects a recommender algorithm (e.g., User-based CF, Item-based CF, CBF, Popular) based on the request context (e.g., day of the week, hour, current page popularity). They found out that there is not a single optimal algorithm - the accuracy is strongly dependent on the context and on the publisher.

(GARCIN *et al.*, 2014) employs Context Trees for news recommendations. A context-tree recommender system builds a hierarchy of contexts, arranged in a tree such that a child node completely contains the context of its parents. A context can be the sequence of stories read by a user, the sequence of topics, or topic distributions. This class of recommender systems adapts its model to current trends and reader preferences.

In (TREVISIOL *et al.*, 2014), Yahoo! researchers have reported an interesting strategy to deal with cold-start news recommendation. They found out that the referrer URL (from which the user is coming from) has a big predictive potential for next click prediction. They define a special case of *BrowseGraph* model - the *ReferrerGraph*, that consists of a sub-graph built from the browsing sessions with homogeneous referrer URL.

The New York Times started with CBF based on articles tags, but soon observed limitations in the user profiling and recommendation accuracy. After some prototypes and online evaluation, they could improve recommendation effectiveness by usage of Collaborative Topic Modeling (WANG; BLEI, 2011), which initializes the item representation

based on a mixture of its topics (*LDA*) and updates it based on audience reading patterns. (SPANGHER, 2015)

In (CALDARELLI *et al.*, 2016), they describe a preliminary research on news recommendations based on a signal processing technique (e.g., the discrete wavelet transform). Users profiles are modeled as bag-of-signal, which represent the informative entities and the time use patterns, and allow to compute the similarity between users.

In (EPURE *et al.*, 2017), they use Markov processes over news categories to model users' short-term, medium-term, and long-term interests. They found out that, within sessions, users are likely to read news within the same category, although users' interest proportion on the categories change every 1 to 4 months.

To the best of the knowledge from this research so far, the only works presenting a deep learning architecture for news recommendation were (SONG *et al.*, 2016), (KUMAR *et al.*, 2017a; KUMAR *et al.*, 2017c), (PARK *et al.*, 2017), (OKURA *et al.*, 2017), (ZHANG *et al.*, 2018), and (WANG *et al.*, 2018). Those works are described with more detail Chapter 3 and compared to our proposed meta-architecture in Section 4.4.

3 Deep Learning for Recommender Systems

This chapter presents the related work on the application of Deep Learning architectures and methods for Recommender Systems. A background on Deep Learning methods and techniques is provided in Appendix A.

Deep Learning research (HINTON *et al.*, 2006; HINTON; SALAKHUTDINOV, 2006; BENGIO *et al.*, 2007; BENGIO *et al.*, 2009) has yielded relevant advances in computer vision, audio, speech recognition, and natural language processing. However, applications of deep learning in recommender systems have not been extensively explored yet (ZHENG, 2016). The uptake of deep learning by the recommender systems community was relatively slow, as the topic became popular only in 2016, with the first Deep Learning for Recommender Systems workshop at *ACM RecSys 2016* (HIDASI *et al.*, 2017).

In many recommender systems, scalability and handling dynamic pools of items and users are considered as critical needs. One of the advantages of Neural Networks for recommender systems is that they scale to the size of a training set (by training using mini-batches) and also support online learning, as updating latent factors of items or users can get performed independently from historical data (ZHENG *et al.*, 2017).

In the survey conducted in (ZHANG *et al.*, 2019), the strengths of Deep Learning-based recommender systems are summarized as follows: (a) *Nonlinear Transformation* – the ability to model nonlinearity in data, differently from linear techniques such as matrix factorization, factorization machines, and sparse linear models; (b) *Representation Learning* – reduces the efforts in hand-crafting feature design and enables models to include heterogeneous content information such as text, images, audio, and even video; (c) *Sequence Modeling* – as RNNs and CNNs can be effectively model sequential data, such as session clicks; and (d) *Flexibility* – neural networks can be modularized and combined to formulate powerful hybrid recommendation models, such as the architectures proposed in our research.

(HIDASI, 2017) divided the main approaches using Deep Learning in Recommender Systems as: (a) *Item Embeddings and 2vec Models*, (b) *Deep Collaborative Filtering*,

(c) *Deep Session-Aware and Session-Based RS*, and (d) *Deep Feature Extraction from Heterogeneous Data*, and their combinations.

In this Chapter, we briefly touch (a) and (b), focusing our review on works on (c) and (d), which are more relevant for this research.

3.1 Item Embeddings and 2vec Models

Different approaches to learn embeddings (also known as distributed representations, or latent features) for items have been proposed in recommender systems research, like Matrix Factorization (MF) methods (GRBOVIC *et al.*, 2015).

Recent methods focus on item embeddings without user identification and can be used as the basis of more advanced methods or as item-to-item recommenders. Most of the models use some variation of *Word2Vec* (MIKOLOV *et al.*, 2013a) - originally devised for word embeddings on event data.

The *Prod2Vec* (GRBOVIC *et al.*, 2015) is an extension of the *Word2Vec* algorithm to product shopping sequences. It learns item embeddings for products, trying to predict the other products users have also bought in e-commerce portals. As a result, the *Prod2Vec* can be seen as a matrix factorization technique on the product co-occurrence matrix. A similar proposal was presented as the *Item2Vec* (BARKAN; KOENIGSTEIN, 2016).

The *Meta-Prod2Vec* (VASILE *et al.*, 2016) has improved upon the *Prod2Vec*, by using the product metadata side information to regularize the final product embeddings.

The *Content2Vec* jointly embed all product information into a product vector such that the inner-product of any two product vectors is proportional to the probability that the two products will be bought by the same user (NEDELEC *et al.*, 2017). It has used a multi-model hybrid RS approach, with the *Prod2Vec* for CF, the *AlexNet* CNN architecture for image representation and the *Word2Vec* + the *TextCNN* for text representation.

3.2 Deep Collaborative Filtering

A natural application of deep models is the Collaborative Filtering (CF). Leveraging the versatility of deep models, multiple types of interaction and context are often integrated (HIDASI *et al.*, 2017).

Early pioneer work on CF based on using neural networks was done in (SALAKHUTDINOV *et al.*, 2007). They introduced a two-layer RBM to model ratings. An RBM model was trained for each user, and visible *softmax* units corresponds with the items rated by

the user. If two users rated the same item, their RBMs shared weights connected to the corresponding visible unit (ZHENG, 2016), with better for computational tractability.

Autoencoders and denoising autoencoders (VINCENT *et al.*, 2008), with intentionally corrupted input, have being used as the central component of their CF recommender systems (CHEN *et al.*, 2012; SEDHAIN *et al.*, 2015; STRUB; MARY, 2015).

The idea of user-based *AutoRec* (SEDHAIN *et al.*, 2015) was to learn hidden structures that can reconstruct user’s ratings given her historical ratings as inputs using traditional autoencoders. In terms of user personalization, such approach shares a similar spirit as the item-item model (SARWAR *et al.*, 2001; NING; KARYPIS, 2011) that represent a user as his rated item features.

In (WANG *et al.*, 2015), it was introduced a technique named *Collaborative Deep Learning (CDL)*, which utilizes ratings and also item review texts, in order to address the cold-start problem. They integrate a bayesian *Stack Denoise Auto Encoder (SDAE)* (VINCENT *et al.*, 2010) and *Collaborative Topic Regression (CTR)* (WANG; BLEI, 2011). It learns latent factors of items from review texts and draw a latent user vector from a Gaussian distribution (ZHENG, 2016).

The *CDL* uses tags and metadata instead of the item ID. It was the first deep model to learn from review texts for recommender systems (BETRU *et al.*, 2017). However, they did not modeled reviews by users, in which users preferences could be better inferred (ZHENG, 2016). In addition, their approach was only suitable for one-class collaborative filtering problems (PAN *et al.*, 2008). Other limitation was text representation using bag-of-words, which does not provide semantic similarity, and word order is lost (ZHENG, 2016) (BETRU *et al.*, 2017).

In (LI *et al.*, 2015), authors proposed a general deep architecture named *Deep Collaborative Filtering (DCF)*, which integrates matrix factorization and deep feature learning. It models the mappings between the latent factors used in CF and the latent layers in deep models. They also present a practical instantiation of the proposed architecture, by utilizing the probabilistic matrix factorization and *Marginalized Denoising Autoencoders (mDA)* (CHEN *et al.*, 2012), with high scalability and low computational cost.

In (WU *et al.*, 2016), a method for top-N recommendation named *Collaborative Denoising AutoEncoder (CDAE)* is presented. It is probably the first work to utilize, for recommender systems, the idea of *Denoising AutoEncoders (DAE)* (VINCENT *et al.*, 2008). The DAE extends the classical autoencoder by training to reconstruct each data point from its (partially) corrupted version. The goal of DAE is to force the hidden layer to discover more robust features and to prevent it from simply learning the identity function. The model learns latent representations of corrupted user-item preferences that can best reconstruct the full input, recovering co-preference patterns.

(WANG *et al.*, 2016) developed the *Collaborative Recurrent AutoEncoder (CRAE)*, which can model the generation of item sequences while extracting the implicit relationship between items (and users). It used an encoder-decoder architecture, corrupting input items texts (e.g., movie plot, review) with a $\langle BLANK \rangle$ token. The synergy between denoising and CF has enabled the *CRAE* to make accurate recommendations while learning to fill in the blanks in sequences. The *CRAE* was the first model to bridge the gap between RNN and CF, with respect to hybrid methods for RS.

Multi-VAE and *Multi-DAE* (LIANG *et al.*, 2018) have proposed variants of the variational autoencoder for recommendation with implicit data and they have shown better performance than *CDAE*. The authors also have introduced a principled Bayesian inference approach for parameter estimation and have shown favorable results over the commonly used likelihood functions.

(HE *et al.*, 2017) authors devised a general framework named *Neural Collaborative Filtering (NCF)*. They modeled user-item interactions in three different instantiations: the *Generalized Matrix Factorization (GMF)*; the *Multi-Layer Perceptron (MLP)*; and their combination as *Neural Matrix Factorization (NeuMF)*. Their experiments have shown that by using deeper layers of neural networks offered better recommendation performance.

Negative sampling approaches can be used to reduce the number of training unobserved instances. Follow-up work (NIU *et al.*, 2018; SONG *et al.*, 2018) proposed using pairwise ranking loss to enhance performance. (LIAN *et al.*, 2017) and (WANG *et al.*, 2017) extended the *NCF* model to cross-domain recommendations. It was shown in (XUE *et al.*, 2017) and (ZHANG *et al.*, 2018) that the one-hot identifier can be replaced with columns or rows of the interaction matrix to retain user/item interaction patterns (ZHANG *et al.*, 2019).

3.3 Deep Sequence-Based, Session-Based, and Session-Aware RS

Since historical behaviors from different time periods have different effects on users' behaviors, the importance of sequential information in recommender systems has been gradually recognized by researchers. Methods based on Markov assumption, including *Factorizing Personalized Markov Chain (FPMC)* (RENDLE *et al.*, 2010) and *Hierarchical Representation Model (HRM)* (WANG *et al.*, 2015), have been widely used for sequential prediction. However, a major problem of these methods is that they independently combine several components. To solve this deficiency, the RNN has been employed to model global sequential dependency among all possible components (LIU *et al.*, 2016).

Much of the research recommender systems has focused on models that work when a

user identifier is available and a clear user profile can be built. Classic recommendation algorithms require many user interactions to start providing useful recommendations. Therefore, in many websites like e-commerce, news and media websites, users are not required to login for browsing.

In order to provide better recommendations, those websites try to employ techniques like cookies and browser fingerprinting to recognize the user. But those approaches are not reliable for long-term users tracking, as users may use multiple devices, clean their cookies regularly, or even set a browser setting to prevent cookies creation.

The Session-Based RS is a type of a Context-Aware RS (CARS), which leverages information available in the current session for recommendations, ignoring user profiles. Session-based implementations generally use simple item-to-item recommendations, looking for items similar to the ones the user has consumed in that session, or using transition probabilities based in the last click. Publishers observe relatively short sessions, with fewer than ten clicks on average (EPURE *et al.*, 2017).

In Session-Aware RS, additional information about the user session is incorporated in the prediction process (TWARDOWSKI, 2016). In this setting, users identifiers are present. Thus, it is possible to propagate information from the previous user session to the next, thus improving the recommendation accuracy.

This research is focused in Session-Based RS. This is a challenging problem, specially when recommended items are ephemeral, with its short life-cycle too short or its availability too dynamic, allowing to identify it only by unique id, like in news recommendations and online auctions for ads.

The Recurrent Neural Networks (RNN) and the Convolutional Neural Networks (CNN) are gaining attention as suitable for session-based/aware recommendations, since the seminal work of (HIDASI *et al.*, 2016). Relevant works in this recent research line are described in more detail in the next subsections.

3.3.1 The *GRU4Rec*

The *GRU4Rec* (HIDASI *et al.*, 2016) has represented the seminal work in the usage of Recurrent Neural Network (RNN) for session-based recommendations. For better modeling of longer sessions, they have used Gated Recurrent Unit (GRU) (CHO *et al.*, 2014a; CHUNG *et al.*, 2014), which deals with the vanishing gradient problem, common in standard RNN.

The input vector is a one-hot encoded representation of the item, with the vector length equal to the total number of items. The output is the predicted score for a fixed number of items, i.e. the likelihood of being the next in the session, as illustrated in

Figure 3.1.

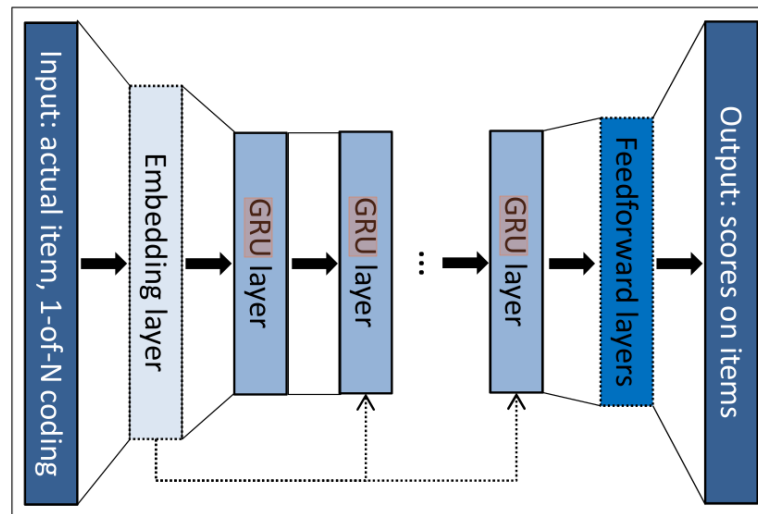
FIGURE 3.1 – The GRU4Rec general architecture, from (HIDASI *et al.*, 2016)

They have used an efficient approach of session-parallel mini-batches, by first creating an order for the sessions and then using the first event of the first X sessions to form the input of the first mini-batch (which desired output is the second events of active sessions). The second mini-batch is formed from the second events and so on. If any of the sessions end, the next available session is put in its place, as shown in Figure 3.2. Sessions are assumed to be independent, thus they reset the appropriate hidden state, when this switch occurs.

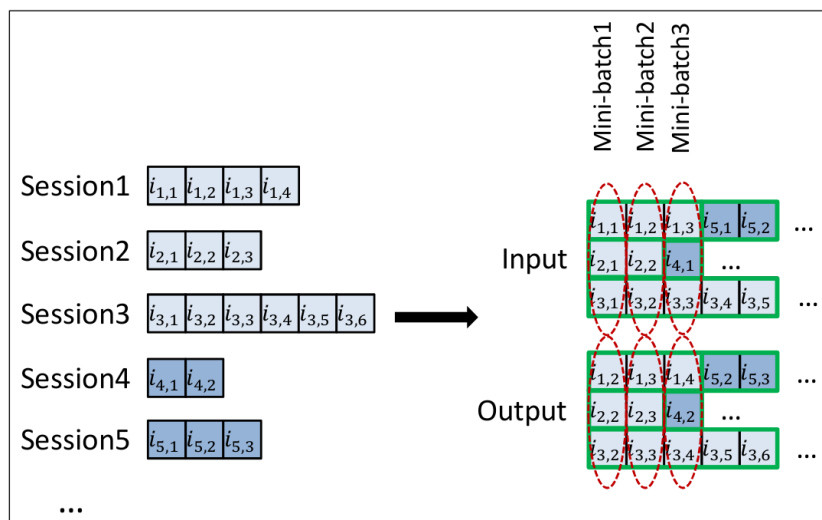
FIGURE 3.2 – The GRU4Rec - Session-parallel mini-batch creation, from (HIDASI *et al.*, 2016)

The number of items may be in the order of hundreds of thousands or even few millions, making it hard to scale by calculating a score for each item in each step. They have used negative sampling to compute scores for some negative samples, besides the desired output

(other items in the same mini-batch), and modify the weights, so that the desired output is highly ranked, as shown in Figure 3.3.

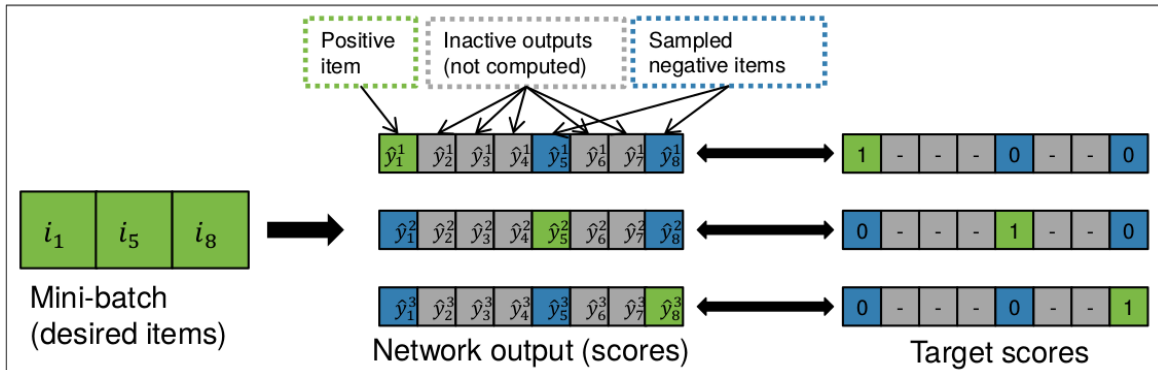

FIGURE 3.3 – The *GRU4Rec* - Mini-batch sampling, from (HIDASI *et al.*, 2016)

The training procedure uses mini-batch negative sampling, from other items in the same batch that users have not interacted with. It is basically a form of popularity-based sampling, since the training iterates through all events, thus the probability of an item acting as a negative sample is proportional to its support. This popularity bias in the sampling process makes sense, under the hypothesis that popular items missed by the user are more likely to express a dislike than other unknown items, which the user could be interested if he is aware of them.

They evaluated their approach on two datasets: click-streams of an e-commerce and video watching in a Youtube-like service. The evaluation was done by providing the session events from test set one-by-one, and also by checking the rank of the item of the next session event, compared to other negative examples (the most popular 30k items not clicked by the user). The hidden state of the GRU is reset to zero after a session finishes. At the end, the authors have compared the two pairwise ranking losses: the *Bayesian Personalized Ranking (BPR)* and their own *TOP1* ranking loss.

The Recall@20 and the *Mean Reciprocal Rank (MRR@20)* metrics were computed and their results were 20 - 30% better than baseline approaches like *Item-KNN* and *BPR-MF*.

In a subsequent paper in this research line (HIDASI; KARATZOGLOU, 2018), the authors designed a better loss function and used additional samples besides the ones in mini-batch. They observed that limiting negative samples from the same mini-batch does not provide flexibility, as its always popularity-based sampling. So, they proposed sampling more items outside the mini-batch, shared with all mini-batch examples. A hyperparameter controls whether the external sampling will use uniform or popularity-based sampling.

They also proposed a family of Ranking-max loss function, in which, instead of averaging the pairwise ranking loss between the target item and all sampled items, the loss is computed only by comparing with the most relevant sample score. This approach solved

vanishing of gradients as the number of samples increased.

Therefore, despite the success of RNNs in session-based recommendation, (JANNACH; LUDEWIG, 2017) indicated that some trivial methods (e.g., simple neighbourhood approach) could achieve the same or even better accuracy results as GRU4Rec while being computationally much more efficient.

The GRU4Rec method is one of the baselines used in our experiments, as described in Section 5.3.

3.3.2 The Multi-modal Data for Session-based Recommendations (*p-RNNs*)

In (HIDASI *et al.*, 2016), they extended the GRU4Rec to be a hybrid session-based architecture, where side features (image and textual description) of the item are also used besides the item ID.

They have proposed multi-modal architecture named *p-RNNs*. It was not end-to-end, in the sense that image features were independently extracted by using transfer learning (last average pooling layer) from a pre-trained *GoogLeNet* (SZEGEDY *et al.*, 2015) architecture implementation.

The textual representation was not directly learned by a neural network, instead they simply have used *TF-IDF* vectorization (SALTON; BUCKLEY, 1988). They reported that in their experiments, word embeddings (MIKOLOV *et al.*, 2013a) and Language Modeling with RNNs (MIKOLOV *et al.*, 2010a) did not perform well, maybe due to the noisier descriptions in the used dataset.

This complex architecture was composed by different subnets, as each information source (IDs, images, textual descriptions) had their own RNN. All subnets were combined in different configurations and trained with distinct strategies (simultaneous, alternating, residual, and interleaving).

The *p-RNN* architecture has presented significant performance improvements over feature-less session models, while all session-based models outperform the item-to-item type of baseline.

3.3.3 The *Contextual Recurrent Neural Networks (CRNN)*

In (SMIRNOVA; VASILE, 2017), a family of *Contextual Recurrent Neural Networks (CRNN)* was proposed, by using RNN cells to learn context-aware transitions for session-based recommendation. Their experiments on e-commerce datasets have considered con-

textual information, like type of the interaction (eg. view, add-to-basket, sale), time gaps between events, and time of day of interaction. In their architecture, the current context is used in the input module and the next context on the output module, as shown in Figure 3.4.

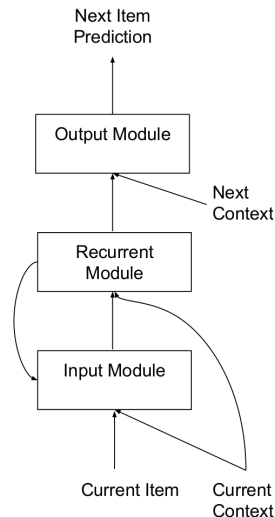

FIGURE 3.4 – The *CRNN* architecture, from (SMIRNOVA; VASILE, 2017)

They have experimented feeding the context into a GRU, by using two strategies: the Context-dependent input/output representation and the Context-dependent hidden dynamics. The latter strategy was the most successful in experiments against sequential and non-sequential baselines.

3.3.4 The *DLRec*

(WU *et al.*, 2016) proposed a sequence-based recommendation neural model named *DLRec*, to predict the probability that the user will access an item given the time heterogeneous feedback of this user. Their proposed architecture, shown in Figure 3.5, contains recurrent and non-recurrent subnets. In the non-recurrent part, the user one-hot vector u is mapped to a feed-forward layer. In the recurrent, the input layer consists of vectors u , $v(t)$, $a(t)$, and $s(t-1)$, representing the current user, item, feedback activity, and the last hidden layer state, respectively. In the last layer, the two subnets are combined in a softmax layer, with a probability distribution over all items. In this setting, user characteristics are only considered independently from sequence properties.

Their experiments were performed on media and e-commerce datasets, and *DLRec* was able to provide more accurate recommendations than other non-sequential recommenders, such as *BPR-MF* (RENDLE *et al.*, 2009) and *CLiMF* (SHI *et al.*, 2012).

The adaptive context-specific input matrices capture external situations where user behaviors happen such as time, location, weather, and so on. These matrices capture how much the length of time intervals between adjacent behaviors in historical sequences affect the transition of global sequential features.

In Figure 3.7, authors show an example of a purchasing sequence of an user. Input contexts are external contexts like location, time (weekdays or weekends, morning or evening), or weather (sunny or rainy). Transition contexts are contexts of transitions between two adjacent input elements in historical sequences, i.e. time intervals.

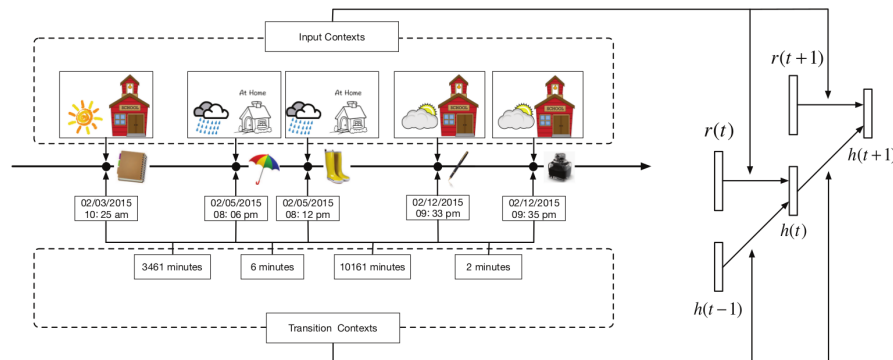

FIGURE 3.7 – An example of input and transition contexts in a user purchasing sequence, from (LIU *et al.*, 2016)

The *Bayesian Personalized Ranking (BPR)* (RENDLE *et al.*, 2009) and the *Back Propagation Through Time (BPTT)* (RUMELHART *et al.*, 1988) are used for the learning of the CA-RNN. Their experimental results on an e-commerce dataset and on a movies dataset have shown that the CA-RNN outperformed other competitive sequential and context-aware models.

3.3.7 The User-based RNN

In (DONKERS *et al.*, 2017), they adapted GRU to deeply integrate user embeddings into the update gating process, as shown in Figure 3.8. These user-based GRUs are designed and optimized for the purpose of generating personalized next item recommendations in sequence-based RS. They have created two strategies for this integration: the *Rectified Linear User Integration* and the *Attentional User Integration*.

Their experiments were performed in movies and music listening datasets. RNN models with user information have presented higher accuracy and the *Attentional User-based GRU* has performed the best in most cases.

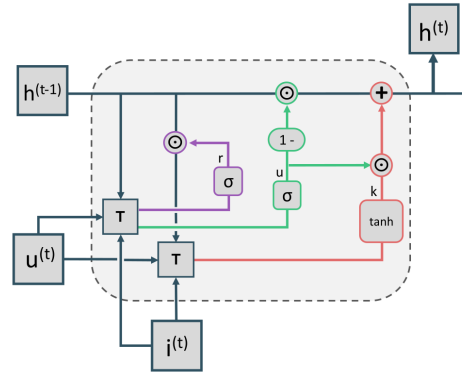

FIGURE 3.8 – The linear user-based GRU cell, with the addition of user representation, from (DONKERS *et al.*, 2017)

3.3.8 The *Hierarchical Recurrent Neural Networks (HRNN)*

(QUADRANA *et al.*, 2017) also proposed a way to personalize RNN models with users' cross-session information and to provide session-aware recommendations. Their architecture, shown in Figure 3.9, is based on a *Hierarchical RNN (HRNN)*, where the hidden state of a lower-level RNN at the end of one user session is passed as an input to a higher-level RNN, which aims at predicting a good initialization (i.e., context vector) for the hidden state of the lower RNN for the next session of the user.

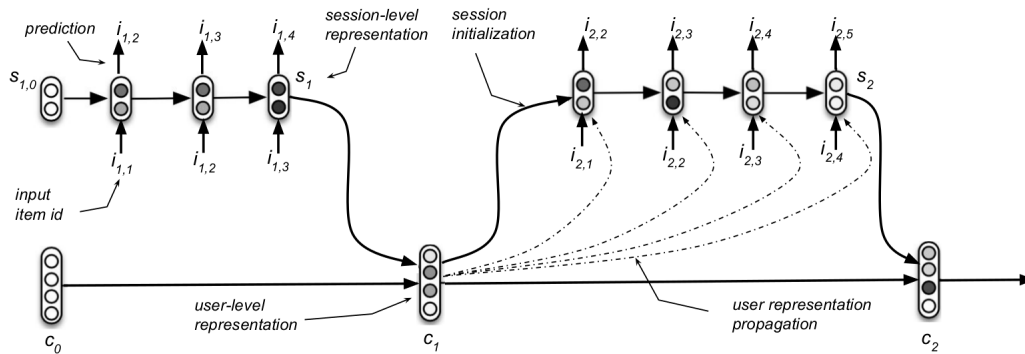

FIGURE 3.9 – The *Hierarchical RNN* architecture for personalized session-based recommendation, from (QUADRANA *et al.*, 2017)

In their experiments, the proposed *HRNN* architecture outperformed state-of-the-art session-based RNNs and other basic personalization strategies for session-aware recommendation on two datasets from jobs and video streaming domains.

3.3.9 The *Inter-Intra Session RNN (II-RNN)*

In (RUOCCO *et al.*, 2017), it was proposed the *II-RNN* to leverage information from previous user sessions to the current one. Their work is similar to (QUADRANA *et al.*,

2017), although both researches were independently developed in parallel. In the II-RNN, the second RNN learns from recent sessions and predicts user's interests in the current session. By feeding this information to the original RNN, it is able to improve its recommendations.

Their proposed model especially improved recommendations at the start of sessions and was able to deal with the cold-start problem in session-aware RS.

3.3.10 The *3D CNN* Recommendation Architecture

In (TUAN; PHUONG, 2017), the authors describe a method that combines session clicks and content features such as item descriptions and item categories to generate recommendations. That was a pioneering work in RS research, by using 3-dimensional CNNs with character-level encoding from all input data.

The *3D CNN* recommendation architecture provides a way to capture spatio-temporal patterns and it was originally introduced for video data (JI *et al.*, 2013; TRAN *et al.*, 2015).

The main difference between 3D and 2D CNN is that in 3D CNN the convolution and pooling are performed in all three dimensions (i.e. spatio-temporally), while in 2D CNNs they are performed spatially in two dimensions, even if the input is 3-dimensional.

Character-level networks allow modeling different data types, by using their raw textual representation, thus reducing feature engineering effort. In the proposed model, each input feature is represented as its own alphanumeric format, without the need of categorical embeddings.

The input 3D tensor, illustrated in Figure 3.10, represents the one-hot encoded characters of each of the features in the first two dimensions, and the third dimension represents the time (item views in the same session). As the input tensor is fixed, it was necessary to truncate the length for textual features and the maximum number of clicks in the session.

They have applied the proposed method to predict add-to-cart events in e-commerce websites. On two real datasets, their method outperformed several baselines and a state-of-the-art method based on recurrent neural networks.

3.3.11 The *Deep Joint Network for Session-based News Recommendations (Deep JoNN)*

Inspired by the 3D-CNN architecture from (TUAN; PHUONG, 2017), (ZHANG *et al.*, 2018) proposed a neural architecture for session-based news recommendation that uses a character-level convolutional network to process articles' input features: (a) item ID, (b)

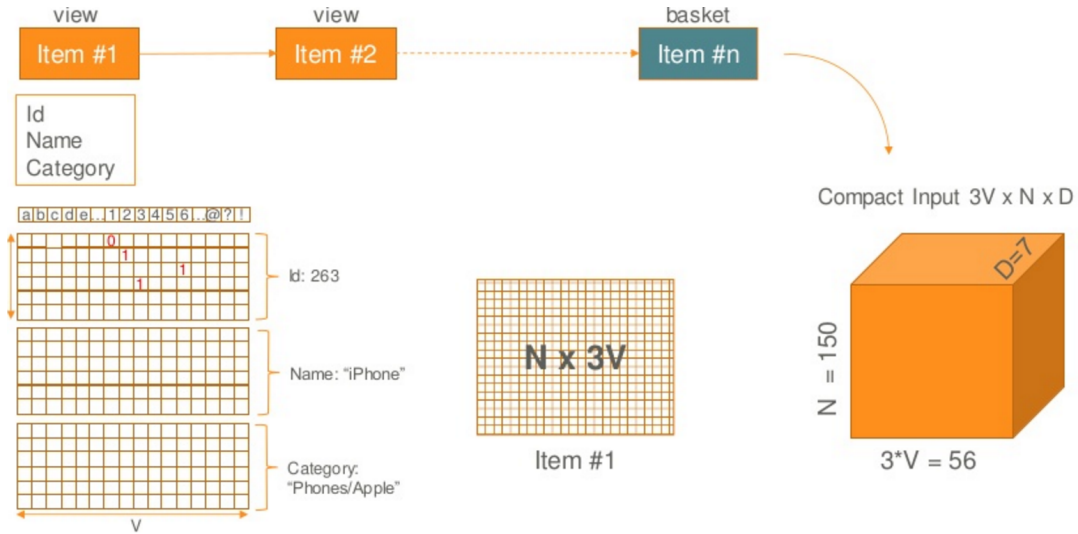

FIGURE 3.10 – The 3D-CNN architecture, from (TUAN; PHUONG, 2017)

keywords and entities, and (c) category.

But differently from (TUAN; PHUONG, 2017), instead of processing the sequence of sessions by a dimension of the CNN, they are processed by a Recurrent Neural Network, as shown in Figure 3.11.

They have also proposed a time-decay function to penalize the scores of older news articles, presented in Equation 3.1,

$$R_{decay} = e^{-\lambda \cdot (t-t_0)}, \quad (3.1)$$

where t and t_0 represent the click time and the publication time of the news, respectively. The decay rates are multiplied by the output values from LSTM RNN layer to form the final outputs.

In their evaluation protocol, they have used the last click of sessions as the test set. Negative items were randomly sampled for training, independently of their publishing time.

They have measured accuracy metrics ($Recall@20$, $MRR@20$) and compared *DeepJoNN* against some baselines: POP, Item-KNN (HIDASI *et al.*, 2016), BPR-MF (RENDLE *et al.*, 2009), and HRNN (QUADRANA *et al.*, 2017).

A discussion on the similarities and differences between *DeepJoNN* and *CHAMELEON* are presented in Section 4.4.

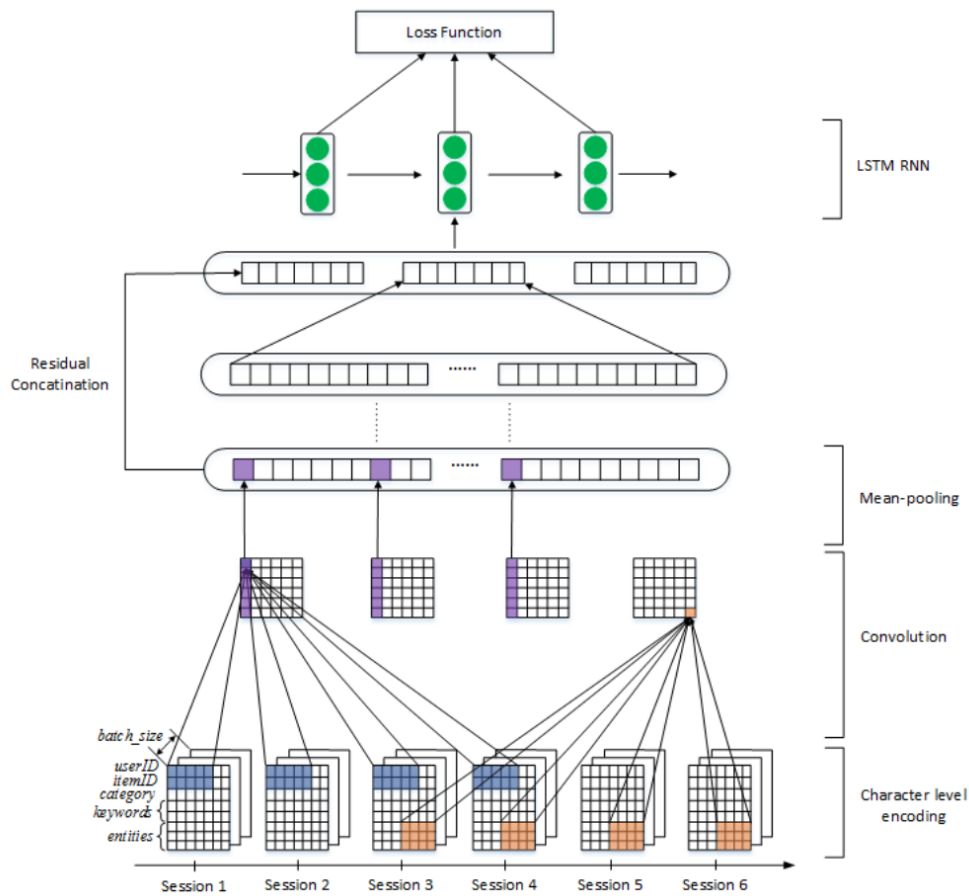

FIGURE 3.11 – The *DeepJoNN* architecture, from (ZHANG *et al.*, 2018)

3.3.12 The *Session-Based Recommendation with Graph Neural Networks (SR-GNN)*

Graph Neural Networks (GNN) are designed for generating representations for graphs (SCARSELLI *et al.*, 2008; LI *et al.*, 2016). It was recently proposed a method for *Session-based Recommendation using Graph Neural Networks (SR-GNN)* (WU *et al.*, 2019), which is illustrated in 3.12.

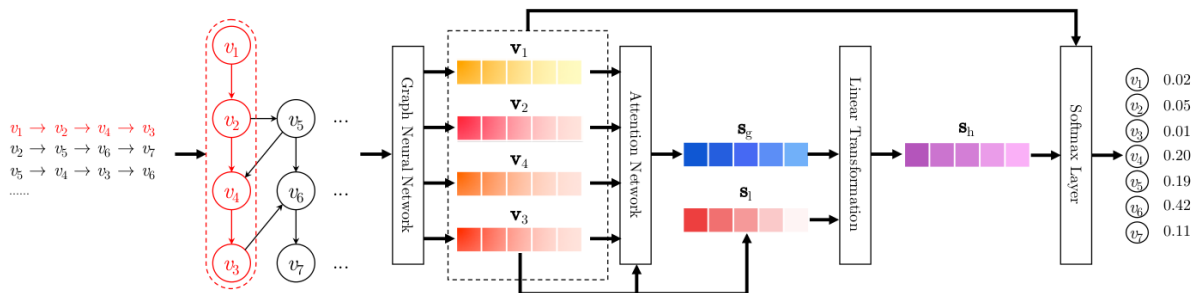

FIGURE 3.12 – The workflow of the proposed *SR-GNN* method, from (WU *et al.*, 2019)

In the first step of their method, session sequences are modeled as graph-structured data. Then, their proposed GNN captures transitions of items and generates item embed-

ding vectors correspondingly. Each session is represented as the composition of the global preference and the current interest of that session using an attention network. Finally, it is predicted the probability of each item that will appear to be the next-click one for each session.

The authors of *SR-GNN* argue that their proposed model is more capable to capture complex transitions of items than RNN-based methods for session-based recommendation.

Their experiments were conducted on two e-commerce datasets and the *SR-GNN* indeed outperformed other neural architectures for session-based recommendation methods, such as *GRU4Rec* (HIDASI *et al.*, 2016), *NARM* (LI *et al.*, 2017) and *STAMP* (LIU *et al.*, 2018).

The state-of-the-art *SR-GNN* method is one of the baselines used in our experiments, as described in Section 5.3.

3.3.13 Other Session-based Approaches

In (TAN *et al.*, 2016), they employed data augmentation strategies to generate additional sessions by taking every possible sequence, by starting from the beginning of a session and also randomly removing some items from these sequences (embedding dropout). Naturally, those additional sessions made training time much longer, as pointed by (HIDASI; KARATZOGLOU, 2018). They also have tried to employ *Student-Teacher training*, by using items sequence clicked by users after a target item as privileged information (VAPNIK; VASHIST, 2009), by using generalized distillation (LOPEZ-PAZ *et al.*, 2015), during the training time, even though this "future" information was not available in testing time. Future items in the sequence were trained by a Teacher network, and a Student network was used as input to the previous items of the target item, having Teacher's output as a soft label. Therefore, this model did not performed well, in terms of training time and accuracy (only a slight improvement for small datasets).

In (TWARDOWSKI, 2016), it was also used RNNs in a session-based recommendation system. His network architecture input receives item metadata and contextual information from events in the session. Textual information is represented as: bag-of-words vectors (losing words ordering and text semantics); categorical information, as one-hot vector; and numeric attributes, scaled to $[0, 1]$. Embedding layers convert this input representations into lower-dimensional continuous spaces. Event embeddings are passed in time sequence to an RNN, which hidden state is further merged with item embeddings in a feed-forward network. Their experiments on products and ads datasets have presented superior performance, if compared to some baselines as: a popularity model and a content-based model.

In (LI *et al.*, 2017), it was proposed the *Neural Attentive Recommendation Machine (NARM)*, a hybrid neural encoder-decoder architecture leveraging GRU layers and attention mechanisms to model user’s sequential behavior and capture user’s main purpose in the current session, which are combined as a unified session representation later (LI *et al.*, 2017). The recommendation scores is computed for each candidate item with a bi-linear matching scheme based on this unified session representation. *NARM* trains jointly item and session representations, as well as their matches. Their experiments were performed on e-commerce datasets, and *NARM* was able to outperform *GRU4Rec*, as well as other KNN-based baselines.

In (LIU *et al.*, 2018), the *Short-Term Attention/Memory Priority Model (STAMP)* was proposed. Such model is able to capture users’ general interests from the long-term memory of a session context, whilst taking into account users’ current interests from the short-term memory of the last-clicks. According to the authors, their idea is similar to *NARM* (LI *et al.*, 2017), although *STAMP* explicitly emphasizes the current interest reflected by the last click to capture the hybrid features of current and general interests from previous clicks, while *NARM* only captures the general interests. Furthermore, differently than *NARM* which uses GRU, the *STAMP* is based on MLP with attention mechanisms. According to their experiments in e-commerce datasets, it resulted in higher accuracy and faster training time than *NARM*.

3.4 Deep Feature Extraction from Heterogenous Data

Traditional CBF and Hybrid RS generally represent item’s textual information as bags-of-words (MELVILLE *et al.*, 2002) (AGARWAL; CHEN, 2009) or TF-IDF encodings, or rely on topic modeling (WANG; BLEI, 2011) (GOPALAN *et al.*, 2014). A potential drawback of these approaches is that they do not take word orders and the such as surrounding words and word orders (KIM *et al.*, 2016). Furthermore, the extracted textual features may not be necessarily relevant for recommendation (BANSAL *et al.*, 2016).

With deep learning, it became easier to reliably extract useful features directly from content and use them for recommendations. Depending on the domain, the content and its processing can greatly differ (HIDASIS *et al.*, 2017).

For recommendations based on images (MCAULEY *et al.*, 2015) (HE *et al.*, 2016), generally Convolutional Neural Networks (CNNs) are used. For textual items, common approaches are weighted words embeddings, paragraph vectors, CNNs, and RNNs (BANSAL *et al.*, 2016).

Deep architectures for hybrid RS leverage interaction data (Collaborative Filtering) with items metadata (Content-Based Filtering) generally involves the following three main

steps:

1. **Initializing** - to obtain item representations based on metadata and use them as initial item features;
2. **Regularizing** - to compare metadata representations with interactions' representations (which should be close) adding a regularizing term to loss off this difference; and
3. **Joining** - to generate an item feature vector, by concatenating metadata embedding (fixed by item) with learned users' interactions representations.

3.4.1 Hybrid RS Leveraging Textual Reviews

The next subsections cover hybrid approaches for item recommendations, by using their side textual information like movies, products, and restaurants' reviews.

3.4.1.1 The *Convolutional Matrix Factorization (ConvMF)*

In (KIM *et al.*, 2016), the authors have proposed the *Convolutional Matrix Factorization (ConvMF)* shown in Figure 3.13, by integrating the CNN with the *Probabilistic Matrix Factorization (PMF)*. Consequently, the ConvMF captures content information from documents and further enhances the rating prediction accuracy.

The integrated CNN component uses pre-trained word embeddings and is able to capture subtle contextual difference of a word in a document. Their experiments have shown that the ConvMF had a superior accuracy (lower *RMSE*) over *PMF* and *CDL* approaches.

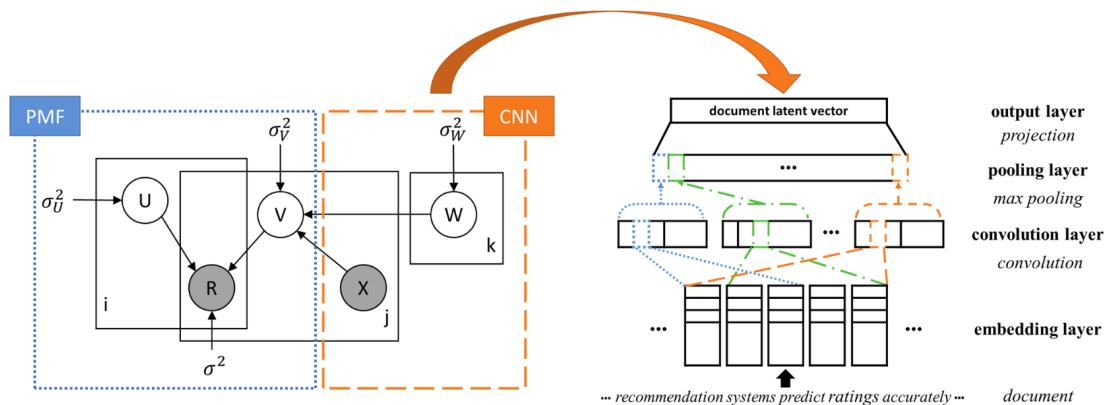

FIGURE 3.13 – The *ConvMF* architecture, from (KIM *et al.*, 2016)

3.4.1.2 The *Dual Attention-based Model (D-Attn)*

In (SEO *et al.*, 2017), authors also proposed to model user preferences and item properties, by using CNNs, because of its ability to extract complex features. They trained user and item networks jointly, enabling the interaction between users and items similarly, as matrix factorization.

But, differently from previous works, like (KIM *et al.*, 2016), they have used dual local and global attention mechanisms. The local attention selects informative keywords from a local window, before the words are fed into the convolutional layer, providing insight on user's preferences or items' properties. The global attention helps CNNs to focus on the semantic meaning of the whole review text.

Thus, combined local and global attentions have enabled an interpretable and improved representation of users and items.

Their D-Attn architecture, shown in Figure 3.14, outperformed *ConvMF+*, matrix factorization, and topical (*HFT*) model on popular review datasets (Yelp and Amazon).

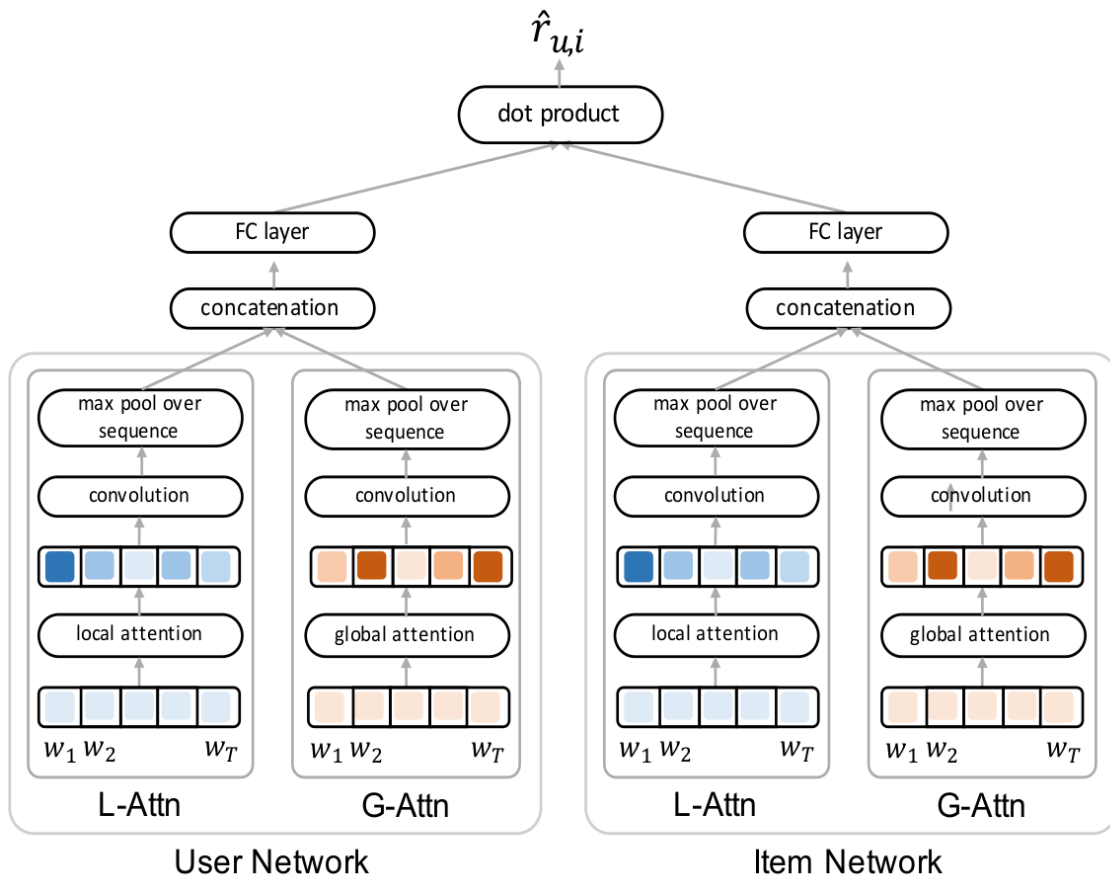

FIGURE 3.14 – The *D-Attn* architecture, from (SEO *et al.*, 2017)

3.4.1.3 The Deep Cooperative Neural Networks (DeepCoNN)

In (ZHENG *et al.*, 2017), the authors have proposed a model named Deep Cooperative Neural Networks (DeepCoNN), which consists of two parallel CNNs coupled in the last layers, as presented in Figure 3.15.

One of the networks focuses on learning user behaviors, exploiting reviews written by user, and the other one learns item properties from reviews written for the item.

A shared layer is introduced on top, to couple these two networks together. The shared layer enables latent factors learned for users and items to interact with each other, in a manner similar to Factorization Machine (FM) techniques.

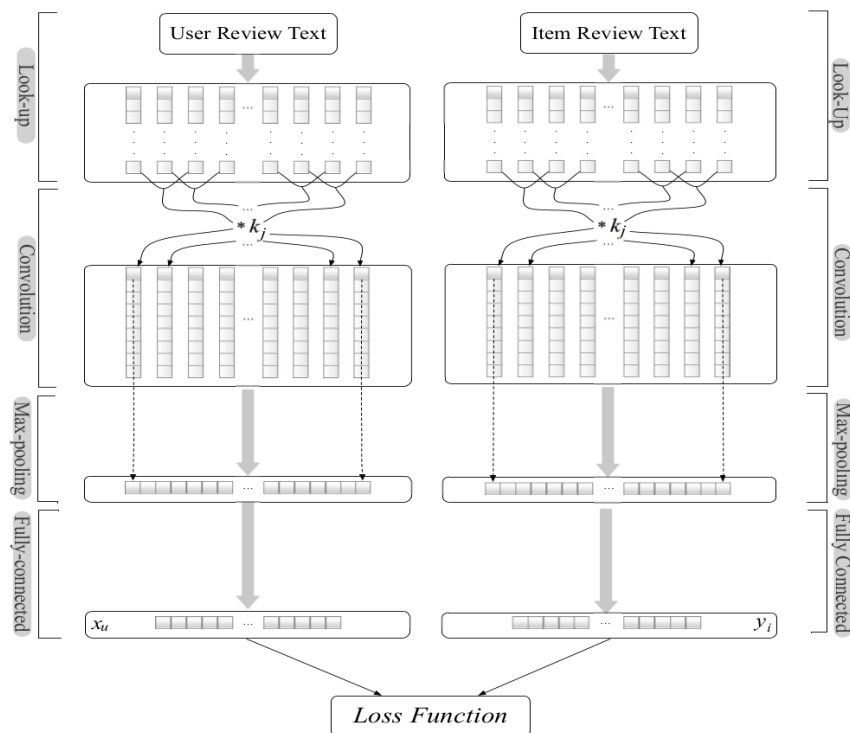

FIGURE 3.15 – The architecture of *DeepCoNN*, from (ZHENG *et al.*, 2017)

To capture the semantic meaning existing in review texts, the *DeepCoNN* represents review texts, by using pre-trained word-embedding techniques (TURIAN *et al.*, 2009) (MIKOLOV *et al.*, 2010b) (MIKOLOV *et al.*, 2013b) to extract semantic information from reviews.

Their experimental results demonstrated that the *DeepCoNN* outperformed a set of baseline recommender systems on a variety of datasets.

One drawback of the *DeepCoNN* is that, similarly to MF, it cannot deal with those users or items without ratings. The authors recommend the incorporation of user demographic information such as ages or genders, to enable reasonable recommendations to newly joining users (ZHENG, 2016).

3.4.1.4 The *Transformational Neural Network (TransNet)*

(CATHERINE; COHEN, 2017) have proposed an extension of *DeepCoNN* architecture named *Transformational Neural Networks (TransNet)*.

In their experiments, they have observed that much of the predictive value from the *DeepCoNN* came from reviews of the target user for the target item in training set and that can be considered a type of data leak. Such evaluation setting was unrealistic, as user reviews on unseen items would not be available in operational system (test time).

The *TransNet* extended the *DeepCoNN* model, by introducing an additional latent layer, representing an approximation of the review, and corresponding to the user-target item pair. This layer is used in training time as a regularization, to be similar to the latent representation of the actual review written by the target user for the target item.

The *TransNet*, as shown in Figure 3.16, consists of two networks: a Target Network, that processes the target review rev_{AB} ; and a Source Network, that processes the texts of the (user, item) pair that does not include the joint review rev_{AB} .

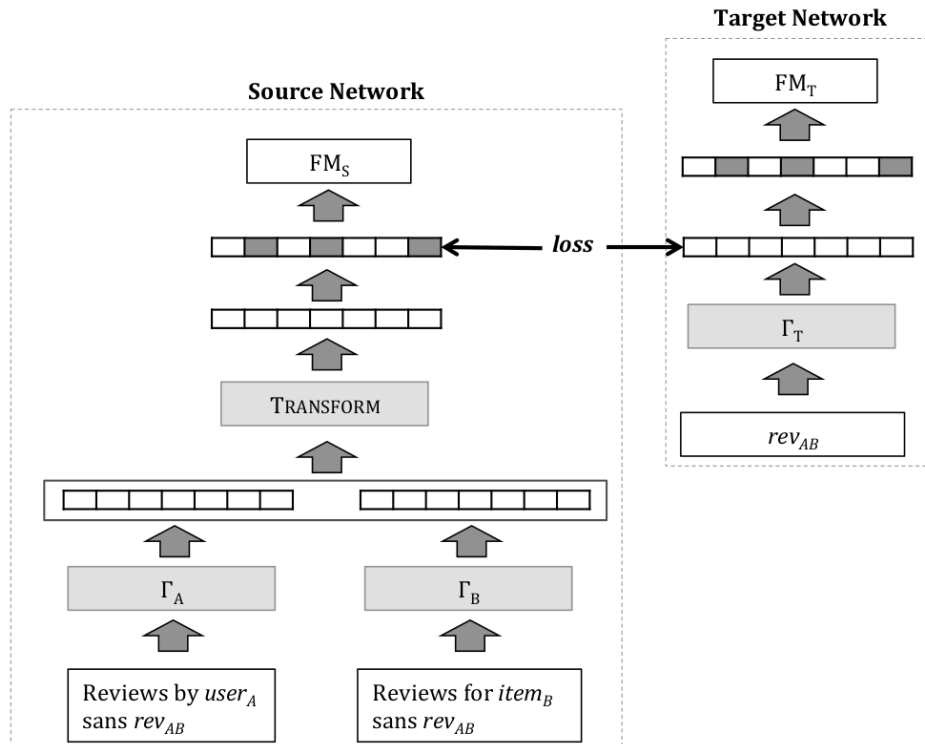

FIGURE 3.16 – The *TransNet* architecture, from (CATHERINE; COHEN, 2017)

The *TransNet* also uses only the text of reviews and is user/item identity-agnostic - the user and the item are fully represented, by using review texts, and their identities are not used in the model. They also have proposed the Extended *TransNet (TransNet-Ext)* architecture, which uses identities of users and items to learn a latent representation, similarly to Matrix Factorization.

3.4.2 Text Recommendations Using Deep Learning

The next sections present research on textual items of RS like blogs, social media posts, research papers, and news articles using Deep Learning.

3.4.2.1 Ask the GRU: Multi-task Learning for Deep Text Recommendations

In (BANSAL *et al.*, 2016), authors present a method leveraging Recurrent Neural Networks (RNNs) (WERBOS, 1990) to represent text items for collaborative filtering.

As RNNs are high capacity models, thus prone to overfitting, authors used multi-task learning for regularization. They have used a simple side task for predicting item metadata such as genres or item tags. In such approach, the network producing vector representations for items directly from their text content is shared for both tag predictions and recommendation tasks. This allows to make predictions even in cold-start conditions, while providing regularization for the recommendation model (BANSAL *et al.*, 2016).

The proposed architecture is presented in Figure 3.17. Items were represented by an item-specific embedding combined with a two-layer GRU (RNN) - a bidirectional layer followed by an unidirectional layer, which hidden states of the sequence were pooled to form its representation. Users and tags are also represented by embeddings, which are combined with the item representation to do tag prediction and recommendation (multi-task learning). The model was end-to-end, which means that all parameters were trained simultaneously.

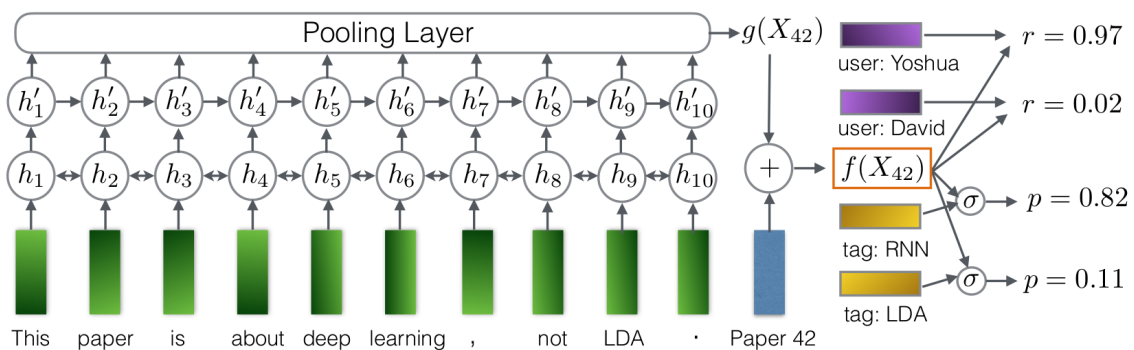

FIGURE 3.17 – The Architecture for text item recommendation, proposed from (BANSAL *et al.*, 2016)

They evaluated their model on the task of scientific paper recommendation, by using two publicly available datasets, where items are associated with text abstracts (WANG; BLEI, 2011) (WANG *et al.*, 2015).

The authors found that the RNN-based models yielded up to 34% relative-improvement in *Recall@50* for cold-start recommendation over Collaborative Topic Regression (CTR)

approach of (WANG; BLEI, 2011) and a word-embedding based model (WESTON *et al.*, 2011), while giving competitive performance for warm-start recommendation. Finally, they pointed out that multi-task learning improves the performance of all models significantly, including baselines.

3.4.2.2 Quote Recommendation in Dialogue Using Deep Neural Network

In (LEE *et al.*, 2016), the authors have introduced the task of recommending quotes which are suitable for given dialogue context.

Their architecture, shown in Figure 3.18, have modeled semantic representation of each utterance and constructed a sequence model for the dialog thread.

The CNN maps tweets in the thread to their distributional vectors. And then, the sequence of tweet distributional vectors are fed to the RNN so as to compute the relevance of target quotes to the given tweet dialogue.

To evaluate the model, they have collected a large set of Twitter dialogues with quote occurrences, in order to evaluate the proposed recommender system. Their experimental results have shown their approach outperforming not only other state-of-the-art algorithms in quote recommendation task, but also other neural network based methods built for similar tasks.

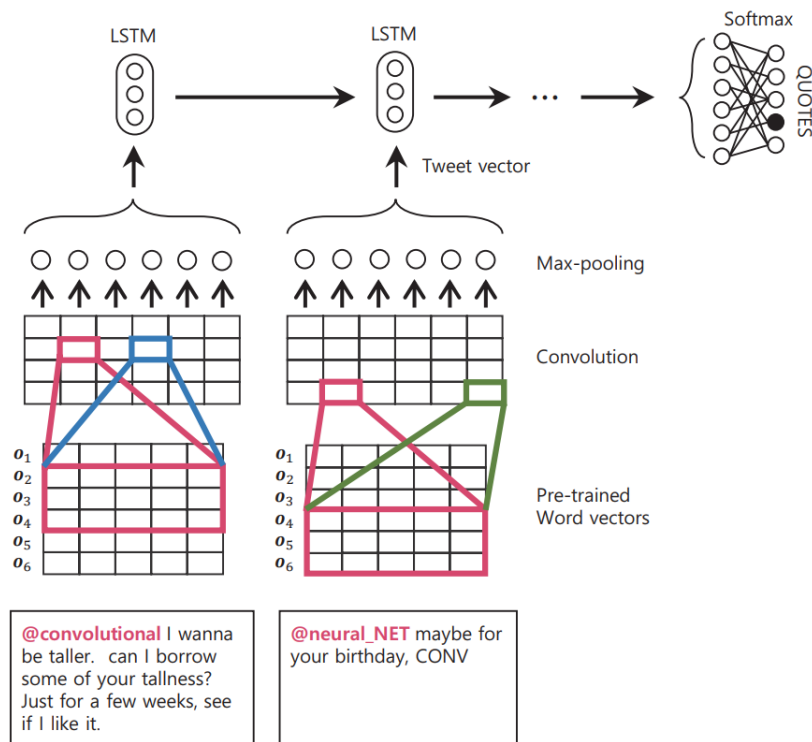

FIGURE 3.18 – The Architecture of a Deep architecture for quote recommendation, from (LEE *et al.*, 2016)

3.4.2.3 News Recommendations with DNN

In (PARK *et al.*, 2017), researchers from *NAVER* news portal proposed a hybrid neural architecture for news recommendation based on RNNs. Their article embeddings were trained from bag-of-words representation from queries, titles, and contents of the news articles.

Trials with different losses functions were reported in that work, without (cosine similarity, MSE) and with negative samples (*BPR* and *TOP1* (HIDASI *et al.*, 2016)).

They have also proposed a personalization re-ranking approach, in which the users content preference is a weighted average of the categories of articles the user has read recently. For articles without an editorial-defined category, they used a CNN-based text classifier to predict the article categories.

They trained two RNN models, session-based and history-based RNN models, the latter one considering all clicks of a user.

Surprisingly, the accuracy of their session-based RNN model was much higher than for the history RNN model – which already included the current session clicks. That result reinforces how determinant can be the short-term interests to model next-click predictions in session-based recommendation scenarios.

The neural architecture for news recommendation proposed by (PARK *et al.*, 2017) have some similarities and many differences to our research, which are discussed next in Section 4.4.

3.4.2.4 Deep Knowledge-aware Network for News Recommendation (DKN)

In (WANG *et al.*, 2018), it was proposed the *Deep Knowledge-Aware Network (DKN)*, that incorporates knowledge graph representation for news recommendation, which is presented in Figure 3.19.

DKN is a content-based model for Click-Through Rate (CTR) prediction, which takes one piece of candidate news and one user’s click history as input, and outputs the probability of the user clicking the news.

Specifically, for a piece of input news, their method enrich the news title information by associating each word in the news content with a relevant entity in a knowledge graph and expand with its immediate neighbors to provide complementary information.

The key component of *DKN* is a multi-channel and word-entity-aligned knowledge-aware convolutional neural network that fuses semantic-level and knowledge-level representations of news. It treats words and entities as multiple channels, and explicitly keeps their alignment relationship during convolution. In addition, to address users’ diverse

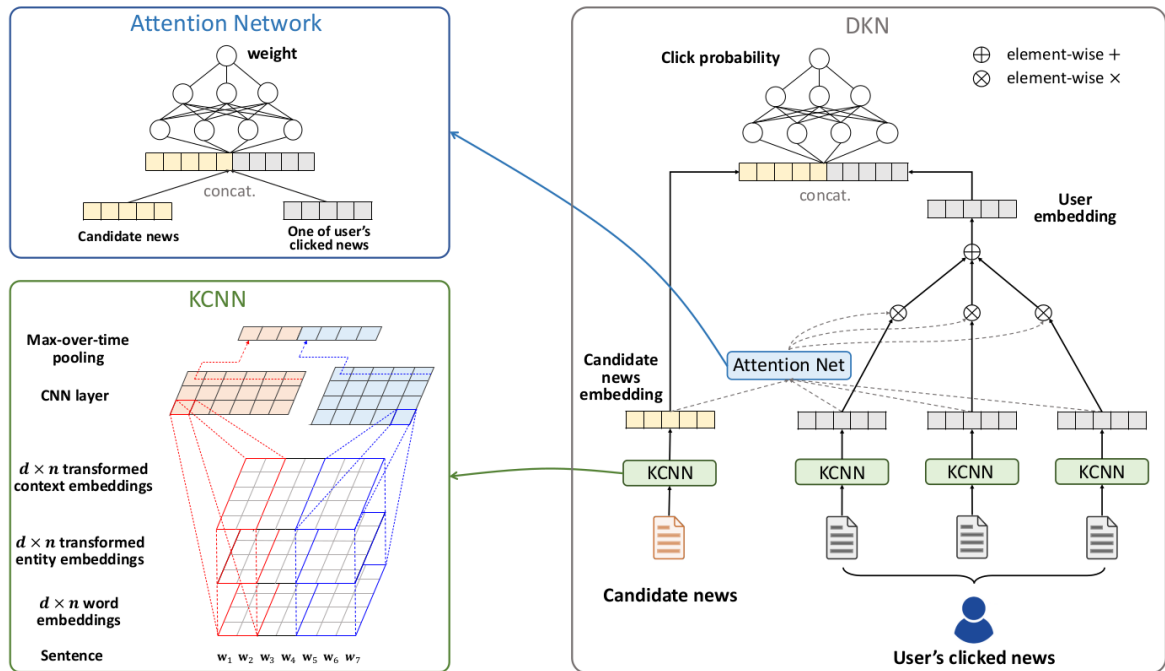
FIGURE 3.19 – The *DKN* framework, from (WANG *et al.*, 2018)

interests, they also use an attention mechanism to dynamically aggregate a user's history with respect to current candidate news.

Their experiments showed that the proposed method was able to provide more accurate recommendations than other Deep Learning architectures, such as *Wide & Deep* (CHENG *et al.*, 2016), *DeepFM* (GUO *et al.*, 2017), and *DMF* (XUE *et al.*, 2017).

Some similarities and differences between *DKN* and *CHAMELEON* are discussed in Section 4.4.

3.5 Multi-View Learning for Recommender Systems

Many domains have multiple data source modalities like visual, audio, textual and structured data. Multi-view or multi-modal learning aims to learn how to model latent factors for each view and jointly optimizes all the functions to improve the generalization performance (ZHAO *et al.*, 2017). Multi-view learning algorithms can be classified into three groups: co-training, multiple kernel learning, and subspace learning.

Subspace learning-based approaches are of special interest in this research. Such approaches aim to obtain a latent subspace shared by multiple views by assuming that the input views are generated from this latent subspace (XU *et al.*, 2013a).

The *Deep Structured Semantic Model (DSSM)* (HUANG *et al.*, 2013), described with more detail in Appendix A.1.7, is a deep neural network for learning semantic represen-

tations of entities in a common continuous semantic space and measuring their semantic similarities. It projects user queries and documents features to a shared latent space, where the similarity between the clicked documents retrieved by a query is maximized.

The *DSSM* was further extended to RS by *MV-DNN* (ELKAHKY *et al.*, 2015), *TDSSM* (SONG *et al.*, 2016), and *RA-DSSM* (KUMAR *et al.*, 2017a) architectures, which are discussed in the next sub-sections.

3.5.1 The *Multi-View Deep Neural Network (MV-DNN)*

(ELKAHKY *et al.*, 2015) proposed a Deep Learning architecture to map users and items to a latent space, where the similarity between users and their preferred items is maximized. This architecture was named *Multi-View Deep Neural Network (MV-DNN)*. In the literature, multi-view learning is a well-studied area which learns from data that do not share common feature space (SUN, 2013).

The *MV-DNN*, shown in Figure 3.20, is an extension of the *DSSM* (HUANG *et al.*, 2013). It was designed for cross-domain recommendation, treating users as the pivot view and each domain (supposing Z domains) as an auxiliary view, leading to $Z+1$ feed forward networks in total. The *MV-DNN* projects users and items, each of which is represented by a rich feature set, through non-linear transformation layer(s) to a compact shared latent semantic space where it is maximized the similarity between the mapping of the user and mappings of items liked by the user.

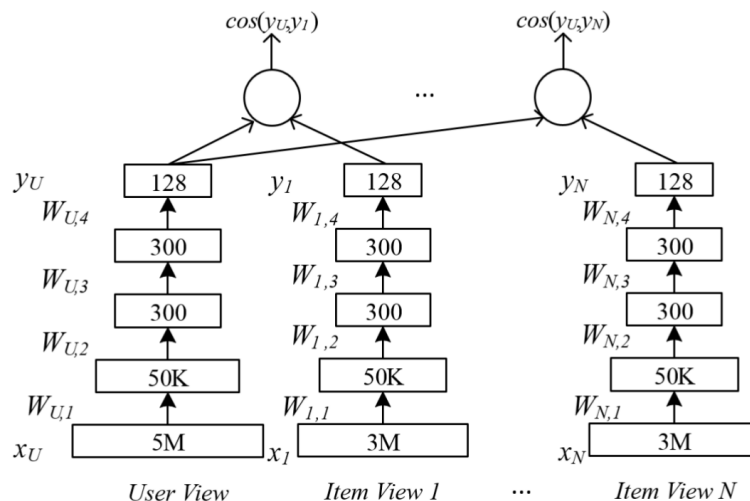

FIGURE 3.20 – The Multi-View Deep Neural Network, from (ELKAHKY *et al.*, 2015)

The user feature representation has allowed the model to learn relevant user behavior patterns and gives useful recommendations for users who do not have any interaction with the service, given that they have adequate search and browsing history. The combination

of different domains into a single model for learning helps improved the recommendation quality across all the domains, as well as having a more compact and a semantically richer user latent feature vector.

The feature extraction process was not automatically learned by Deep Learning. Textual features were handcrafted, by using *TF-IDF* or letter-*trigrams* and categorical features were one-hot encoded (binary features), leading to highly-dimensional feature vectors (3.5 million features for user vectors and between 50 and 100 thousand features for each item domain features). Because of the high dimension space, some techniques like *K-means* and *Local Sensitive Hashing (LSH)* were used for dimensionality reduction, before the fully connected layers of the neural network.

At that time, authors claimed that their approach was significantly better than the state-of-the-art algorithms (up to 49% enhancement on existing users and 115% enhancement on new users).

In addition, their experiments on a publicly open data set also indicate the superiority of their method in comparison with transitional generative topic models, for modeling cross-domain recommender systems. Experimental results have also shown that combining features from all domains produces much better performance than building separate models for each domain.

(ZHENG *et al.*, 2017) critique the aspect that *MV-DNN* outputs were coupled with a cosine similarity objective function to produce latent factors with high similarity. In this way, user and item factors were not learned explicitly in relation to the rating information, with no guarantee that the learned factors could help the recommendation task.

3.5.2 The *Temporal DSSM (TDSSM)*

(SONG *et al.*, 2016) pointed out that in the *MV-DNN* architecture (and *DSSM* as well), both the user view and item view were static, in the sense that the input features represented a holistic view of users interests, during a certain period of time. The model thus lacked the ability of responding promptly to some scenarios where freshness and temporal dynamics of items are sometimes more important than the content relevance itself, like news recommendation.

The authors have introduced the *TDSSM* architecture, shown in Figure 3.21, where user features are modeled by the combination of a static and a time dependent part (SONG *et al.*, 2016). The key difference to *MV-DNN* is the usage of an RNN to model user interests at different time spots.

In their experiment, they have used previous two-weeks clicks as short-term history, with each day as a time spot. Therefore, the length of the LSTM for the *TDSSM* was 14

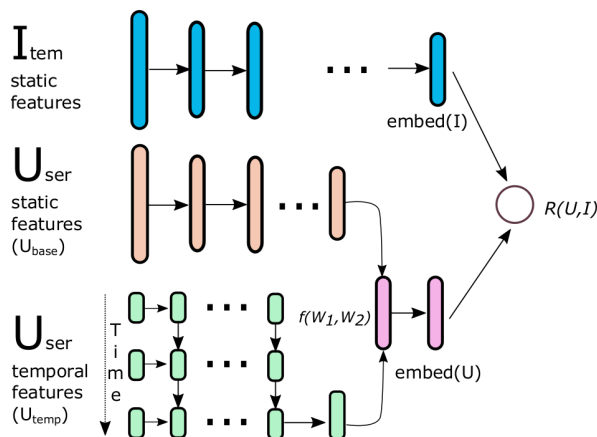

FIGURE 3.21 – The *Temporal DSSM (TDSSM)* architecture, (SONG *et al.*, 2016)

steps. For the *Multi-Rate TDSSM (MR-TDSSM)*, they use two LSTMs in different rates, where the fast-rate LSTM used daily signals and the slow-rate LSTM leveraged weekly signals.

To speedup training and reduce the number of parameters to learn, they have used the original *DSSM* to pre-train user and item embeddings, which were the inputs to the *MR-TDSSM* model.

Their results were superior than matrix factorization and popularity baselines.

3.5.2.1 The Embedding-based News Recommendation

In (OKURA *et al.*, 2017), it was proposed an embedding-based method for news recommendation. Their method has three steps: (i) start with distributed representations of articles content (bag-of-words) based on a variant of a denoising autoencoder, (ii) generate user representations by using a recurrent neural network (RNN) with browsing histories as input sequences, and (iii) match and list articles for users based on inner-product operations by taking system performance into consideration.

For step (i), they proposed an interesting approach to generate article embeddings unsupervisedly, adapting the regular loss function (reconstruction error) used for denoising autoencoder to include a regularization that ensures that the categorical similarities among the embeddings of the original articles are preserved, as shown in Figure 3.22.

For step (2), they have used a loss function based on triplets with the user representation, and a pair of article representations (one positive sample and one negative sample). It is important to note that, instead of using randomly sampling articles as negative instances, they have used as negative samples the non-clicked items recommended for users during their sessions, as they had such data available.

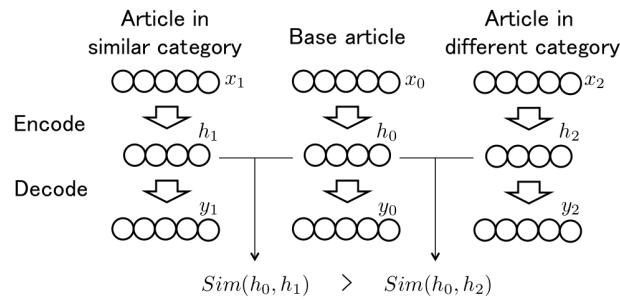
FIGURE 3.22 – Encoder for triplets of articles, from (OKURA *et al.*, 2017)

In step (3), the recommendations relevance is obtained by a simple inner-product relation between an article and a user representation (learned by an RNN).

They report their offline and online experiments on Yahoo! Japan’s homepage. In the offline evaluation, authors compared different baselines with RNNs-based techniques to learn user representations, and the GRU provided the most accurate recommendations.

In the online evaluation, their proposed model provided an improvement of 23% for CTR and 10% for total duration, when compared with their baseline method in production.

3.5.3 The *Recurrent Attention DSSM (RA-DSSM)*

In (KUMAR *et al.*, 2017b), it is proposed a neural architecture based on *DSSM* for news recommendation. That model provides sequence-based (not session-based) recommendation, considering the sequence of all available clicks for given user, ignoring the temporal characteristics of news domain.

Initially, they learned *doc2vec* embeddings to represent the articles content. Then, they proposed simple approaches to build users profiles based on weighted averages of those *doc2vec* embeddings, where the latter clicks are more influential to the user profile. The network is trained by using the loss function from *DSSM* (HUANG *et al.*, 2013).

In (KUMAR *et al.*, 2017a), the same authors proposed an RNN-based model to build user profiles, named *Recurrent Attention DSSM (RA-DSSM)*, as shown in Figure 3.23.

For learning a non-linear mapping for users, they use an attention-based recurrent layer in combination with fully connected layers. The sequence in which the articles are read by the user encapsulates information about long-term user interests, which are processed by an LSTM (HOCHREITER; SCHMIDHUBER, 1997; SUTSKEVER *et al.*, 2014). They have used bidirectional LSTMs (SCHUSTER; PALIWAL, 1997), to capture both static and dynamic interests, which the user has developed over time. A neural attention mechanism (BAHDANAU *et al.*, 2014) was also incorporated to learn the extent of each user interests.

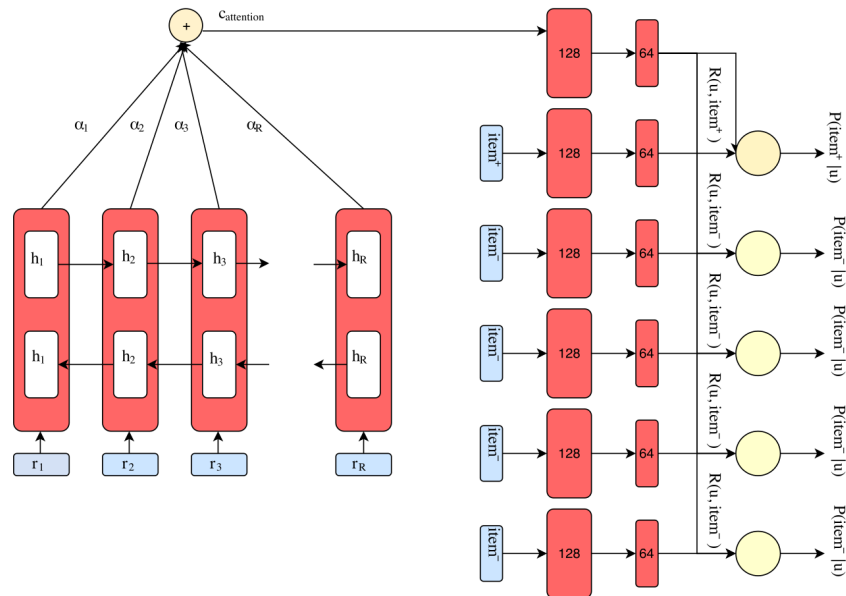

FIGURE 3.23 – The *Recurrent Attention DSSM* architecture, from (KUMAR *et al.*, 2017a)

For learning mappings for items, only fully connected layers are used, based on the textual content of news articles. The articles content was represented as *doc2vec* embeddings (LE; MIKOLOV, 2014) with 300 dimensions.

In order to capture the similarity between users and items, they were projected to the same latent space, by adapting the *Deep Structured Semantic Model (DSSM)* (HUANG *et al.*, 2013) presented in Section A.1.7. For each positive sample, it was used 4 negative instances randomly sampled (i.e., articles not interacted by the user), independently of the articles publishing date.

Finally, a ranking based loss function was used to learn the parameters of the network. To recommend news articles to the users, they have used the computed inner product between user and item latent vectors.

In their offline experiments in a real-word dataset published by the *CLEF-NewsREEL 2017* competition (KILLE *et al.*, 2013; KILLE *et al.*, 2017; LOMMATZSCH *et al.*, 2017b), they could get a 4.7% improvement (Hit Ratio@10) over other methods such as *BPR*, *eALS*, and *NeuMF*. Their model also has shown some effectiveness in handling user cold-start and item cold-start problems.

Therefore, the evaluation protocols used by (KUMAR *et al.*, 2017b) and (KUMAR *et al.*, 2017a) were not realistic for real news portals for some reasons. First at all, their experiments reserved only the latter user click for the test set, and trained upon the all the previous user clicks. This protocol did not emulate session-based recommendations, in which it would not be able to train the model for every new click of a user session to provide next-click recommendation. Another issue is that their protocol ignores the

temporal aspects on news domain, training and evaluating on sequences of user clicks from different days, with very different time intervals among the clicks, and providing negative samples that may be not reasonable, e.g., sampling a very old articles or articles published in a far future.

The research group have also proposed a 3D CNN (KUMAR *et al.*, 2017c) to capture temporal changes in users interests and to provide better recommendations, combining users interactions with the content of the articles.

Finally, in a subsequent article (KHATTAR *et al.*, 2018), the news recommendation is treated as a binary classification problem. Similar heuristics of (KUMAR *et al.*, 2017b) are used to build users profiles. Instead of using a similarity-based loss function, the user profile and article representations are element-wise multiplied and passed through a number of feed forward layers to output the predicted score for a given user and item pair.

The same research group have proposed different neural architectures to tackle sequence-based news recommendation (KUMAR *et al.*, 2017b; KUMAR *et al.*, 2017c; KUMAR *et al.*, 2017a; KHATTAR *et al.*, 2018). All their experiments use the same dataset and evaluation protocol, but they did not report a comparison between their proposed architectures, unfortunately.

As the *RA-DSSM* (KUMAR *et al.*, 2017a) have some similarities to the proposed neural architectures in this research, a comparison is developed in Section 4.4

4 CHAMELEON - A Deep Learning Meta-Architecture for News Recommender Systems

This chapter describes the proposed Deep Learning Meta-Architecture for News Recommender Systems – the *CHAMELEON* (MOREIRA, 2018).

When building a news recommender system, one has several design choices regarding the types of data that are used, the chosen algorithms, and the specific network architecture when relying on deep learning approaches. *CHAMELEON* provides an architectural abstraction (a “meta-architecture”), which contains a number of general building blocks for news recommenders, which can be instantiated in various ways, depending on some particularities of the given problem setting.

”Meta” means the concept applied to itself. A meta-architecture can be defined as an architecture for creating architectures (HAKIMI, 2013). When working at the meta level, we’re not thinking about the things themselves – but in how those things may change overtime and how to support that change, by evolving the architecture (BLOOMBERG, 2014). The fundamental reason to work at the meta level is to create an abstraction that indicates which components might change.

For the purpose of this research, a meta-architecture is a reference architecture that collects together decisions relating to an architecture strategy (MALAN; BREDEMEYER, 2004). In a sense, a meta-architecture can be also be seen as a way to reduce the search space for Neural Architecture Search (NAS), a technique for automating the design of artificial neural networks.

A Meta-Architecture might be instantiated as different architectures with similar characteristics that fulfill a common task, in this case, news recommendations.

Meta-architectures using deep learning have been proposed for different domains. For example, in (FUENTES *et al.*, 2017) and (NIITANI *et al.*, 2017), *Faster Region-based Convolutional Neural Network (Faster R-CNN)*, *Region-based Fully Convolutional Network (R-*

FCN), and *Single Shot Multibox Detector (SSD)* were defined as Deep Meta-Architectures for object detection in computer vision. Those meta-architectures abstract the Feature Extractor module, whose components can be instantiated as more concrete CNN architectures, like *VGG-16* (SIMONYAN; ZISSERMAN, 2014), *Inception-v3* (SZEGEDY *et al.*, 2016), or *Resnet* (HE *et al.*, 2016).

4.1 The Problem Context

In this Section, it is characterized the context of the news recommendation problem, in terms of influencing factors and challenges.

4.1.1 Factors Affecting News Relevance

Many factors may influence the relevance of news article for users, as can be seen in the proposed Conceptual Model presented in Figure 4.1.

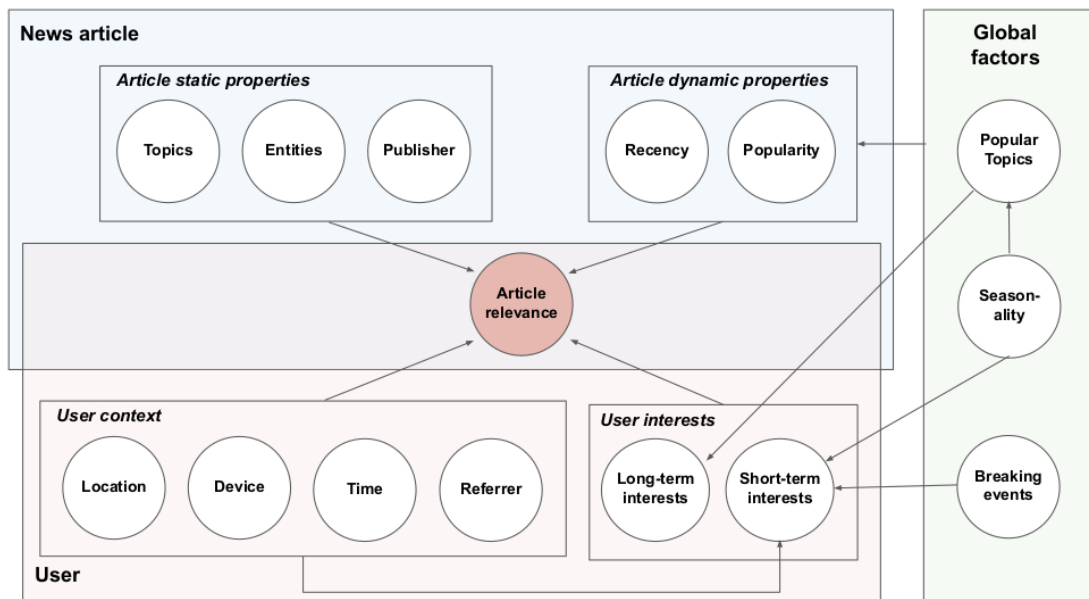

FIGURE 4.1 – The Conceptual Model of factors affecting news relevance for users

With respect to *article-related* factors, we distinguish between **static** and **dynamic properties**. Static properties refer to article’s content (text), its title, **topics**, mentioned **entities** (e.g., places and people) or other metadata (LI *et al.*, 2011; SAID *et al.*, 2013). The reputation of the **publisher** can also add trust to an article (LOMMATZSCH, 2014; GULLA *et al.*, 2016). Some news-related aspects can also dynamically change, in particular its **popularity** (CHU; PARK, 2009; LOMMATZSCH *et al.*, 2017a) and **recency** (TREVISIOL *et al.*, 2014; GULLA *et al.*, 2016). On landing pages of news portals, those two properties

are typically the most important ranking criteria and in comparative evaluations, recommending recently popular items often shows to be a comparably well-performing strategy (KARIMI *et al.*, 2018).

When considering *user-related* factors, we distinguish between users' **short-term and long-term interests** and contextual factors. Regarding the context, their **location** (FORTUNA *et al.*, 2010; MONTES-GARCÍA *et al.*, 2013; TAVAKOLIFARD *et al.*, 2013), their **device** (LEE; PARK, 2007), and the current **time** (MOHALLICK; ÖZGÖBEK, 2017; MONTES-GARCÍA *et al.*, 2013) can influence users' short term interests, and thus the relevance of a news article (MOHALLICK; ÖZGÖBEK, 2017; SAID *et al.*, 2013). In addition, the **referrer** URL can contain helpful information about a user's navigation and reading context (TREVISIOL *et al.*, 2014).

Considering user's long-term interests can also be helpful, as some user preferences might be stable over extended periods of time (PELÁEZ *et al.*, 2016). Such interests may be specific personal preferences (e.g., chess playing) or influenced by popular global topics (e.g., on technology). In this work, we address only short-term user preferences, since we focus on scenarios where most users are anonymous. In general, however, as shown in (QUADRANA *et al.*, 2017), it is possible to merge long-term and short-term interests by combining different RNNs when modeling user preferences.

Finally, there are **global factors** that can affect the general popularity of an item, and thus, its relevance for a larger user community. Such global factors include, for example, **breaking news** regarding natural disasters or celebrity news. Some **topics** are generally **popular** for many users (e.g., sports events like Olympic Games); and some follow some **seasonality** (e.g., political elections), which also influences the relevance of individual articles at a given point in time (CHU; PARK, 2009; GULLA *et al.*, 2016; LOMMATZSCH *et al.*, 2017a).

The proposed Meta-Architecture models all these factors either explicitly or implicitly to improve recommendations accuracy, depending on current context of users and articles.

4.1.2 News RS Challenges

The news domain is specially challenging for Recommender Systems (KARIMI *et al.*, 2018; ÖZGÖBEK *et al.*, 2014). Those challenges are summarized as follows:

The news domain has, however, a number of characteristics that makes the recommendation task particularly difficult (KARIMI *et al.*, 2018; ÖZGÖBEK *et al.*, 2014), among them the following:

- *Extreme user cold-start* - On many news sites, the users are anonymous or not logged

in. News portals have often very little or no information about an individual user past behavior (LI *et al.*, 2011; PELÁEZ *et al.*, 2016; LIN *et al.*, 2014);

- *Accelerated decay of item relevance* - The relevance of an article can decrease very quickly after publication and can also be immediately outdated when new information about an ongoing development is available. Considering the recency of items is therefore very important to achieve high recommendation quality, as each item is expected to have a short shelf life (DAS *et al.*, 2007; ÖZGÖBEK *et al.*, 2014);
- *Fast growing number of items* - Hundreds of new stories are added daily in news portals (SPANGHER, 2015). This intensifies the item cold-start problem. However, fresh items have to be considered for recommendation, even if not too many interactions are recorded for them (PELÁEZ *et al.*, 2016). Scalability problems may arise as well, in particular for news aggregators, due to the high volume of new articles being published (KARIMI *et al.*, 2018; MOHALLICK; ÖZGÖBEK, 2017; ÖZGÖBEK *et al.*, 2014); and
- *Users preferences shift* - The preferences of individual users are often not as stable as in other domains like entertainment (PELÁEZ *et al.*, 2016). Moreover, short-term interests of users can also be highly determined by their contextual situation (PELÁEZ *et al.*, 2016; CAMPOS *et al.*, 2014; KILLE *et al.*, 2013; MA *et al.*, 2016) or by exceptional situations like breaking news (EPURE *et al.*, 2017).

4.2 Requirements

To conceptualize the *CHAMELEON* Meta-Architecture, some requirements were first devised, based on challenges of news recommender systems and also on the capabilities provided by Deep Learning. The *CHAMELEON* Meta-Architecture should be able:

- *RR1* - to provide personalized news recommendations in extreme cold-start scenarios, as most news are fresh and most users cannot be identified;
- *RR2* - to automatically learn news representations from textual content and news metadata, minimizing the need of manual feature engineering;
- *RR3* - to leverage the user session information, as the sequence of interacted news may indicate user's short-term preferences for session-based recommendations;
- *RR4* - to leverage users' contextual information, as a rich data source in such information scarcity about the user;

- *RR5* - to model explicitly contextual news properties (popularity and recency), as those are important factors on news interest life cycle;
- *RR6* - to support an increasing number of new items and users by incremental model retraining (online learning), without the need to retrain on the whole historical dataset; and
- *RR7* - to provide a modular structure for news recommendation, allowing its modules to be instantiated by different and increasingly advanced neural network architectures and methods.

4.3 The Proposed Meta-Architecture

For the purpose of this research, the *CHAMELEON* acronym stands for *Contextual Hybrid session-bAseD MEta-architecture applying deep LEarning On News recommender systems*.

A chameleon was chosen to represent this research for having some commonalities with the proposed Meta-Architecture. First of all, that reptile has a unique ability to adapt his skin coloration, depending upon his context. The proposed Meta-Architecture provides contextual recommendations for the users, depending on their location, time, and used device. Secondly, chameleons have the most distinctive eyes of any reptile. Each eye can pivot and focus independently, allowing the chameleon to observe two different objects simultaneously. The proposed Meta-Architecture have two independent and complementary modules: one focused in news articles representation learning and the other targeting news recommendations.

Finally, chameleons are accurate hunters, as their elastic tongue precisely targets their prey. The proposed Meta-Architecture aims to provide accurate recommendations for news portals' readers.

The *CHAMELEON* Meta-Architecture was conceptualized based on requirements outlined in Section 4.2.

It was structured to support changes, operating at the level of inputs, outputs, modules, sub-modules, and their interactions. Modules and sub-modules can be instantiated by different architectures, as they evolve. Such modular structure also make their components evaluation straightforward.

The main building blocks of *CHAMELEON* are presented in Figure 4.2. It is based on neural networks, which naturally support incremental online learning from mini-batches (*RR6*).

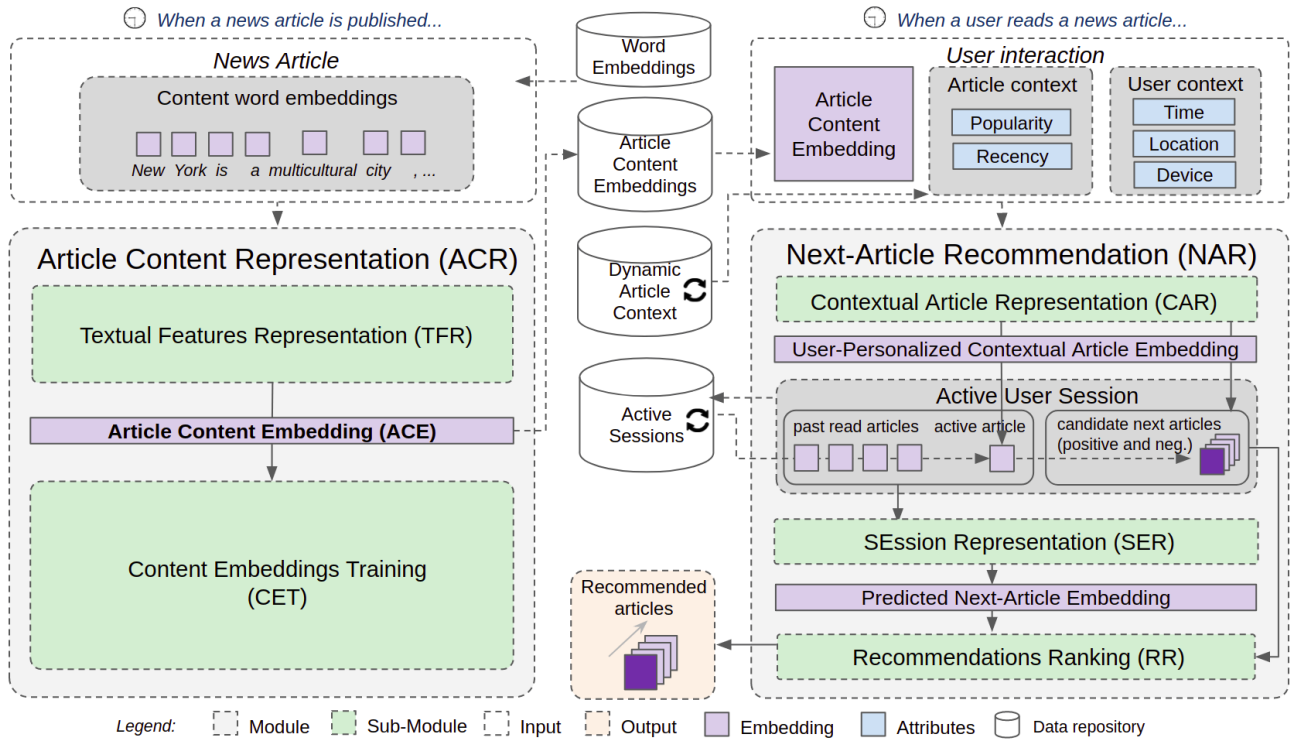

FIGURE 4.2 – CHAMELEON - The Deep Learning Meta-Architecture for News Recommender Systems

The *CHAMELEON* is composed of two modules (*RR7*) with independent life cycles for training and inference:

- The *Article Content Representation (ACR)* module used to learn a distributed representation (an embedding) of articles’ content; and
- The *Next-Article Recommendation (NAR)* module responsible to generate next-article recommendations for ongoing user sessions.

They are described in detail in the next sections.

4.3.1 The *Article Content Representation (ACR)* Module

The *ACR* module is responsible for learning distributed representations (embeddings) from news’ contents.

The input for the *ACR* module is the article textual content, represented as a sequence of word embeddings. Pre-training word embeddings in a larger text corpus of the target language (e.g., Wikipedia) is a common practice in Deep NLP, by using methods like *Word2Vec* and *GloVe*, as described in Section A.2.

The *ACR* module learns an *Article Content Embedding* for each article independently from the recorded user sessions. This is done for scalability reasons, because training user

interactions and articles in a joint process would be computationally very expensive, given the typically large amount of daily user interactions in a typical news portal. Instead, the internal model is trained for a side classification task (e.g. predicting target metadata attributes of an article).

The *ACR module* is composed of two sub-modules: *Textual Features Representation (TFR)* and *Content Embeddings Training (CET)*.

4.3.1.1 The *Textual Features Representation (TFR)* Sub-module

The *TFR* sub-module is responsible to learn relevant features directly from the article textual content (*RR2*). It might be instantiated as a Deep *NLP* architecture, like *CNN* (LEE *et al.*, 2016; CATHERINE; COHEN, 2017; SEO *et al.*, 2017), *RNN*, and variations (BANSAL *et al.*, 2016), or *Quasi-Recurrent Neural Networks (QRNNs)* (BRADBURY *et al.*, 2016).

The *TFR* sub-module process article’s textual content using one of those *Deep NLP* architectures, which are followed by sequence of Fully Connected (*FC*) layers to output the *Article Content Embedding*.

4.3.1.2 The *Content Embeddings Training (CET)* Sub-module

The *Content Embeddings Training (CET)* sub-module is responsible to train the *Article Content Embeddings (ACE)* for a side task.

It can be instantiated as a *supervised* or *unsupervised* learning model. In the *supervised approach*, the side task is to predict articles’ metadata attributes, such as articles categories. In the *unsupervised approach*, the task is to reconstruct the original article text from the learned *ACE*, as an sequence autoencoder (DAI; LE, 2015; SRIVASTAVA *et al.*, 2015).

In Annex A, it is described the training methods of the *supervised* and the *unsupervised* instantiations of the *ACR* module.

4.3.2 The *Next-Article Recommendation (NAR)* Module

The *Next-Article Recommendation (NAR)* module is responsible to provide news articles recommendations for active user sessions. It is designed as a hybrid recommender system, considering both the recorded user interactions and the content (*RR2*) of the news articles.

It is also a context-aware recommender system, in that it leverages information about

the user context ($RR4$), e.g., location, device, previous clicks in the session, and article’s context — popularity and recency ($RR5$) – which quickly decay over time.

Generally, considering these additional factors can be crucial for the effectiveness of the session-based recommendations, in particular as previous work has shown that RNNs without side information are often not much better than relatively simpler algorithms (JANNACH; LUDEWIG, 2017; LUDEWIG; JANNACH, 2018).

The NAR module is based on RNNs, which are suitable to work on sequences. In this case, the task is next-click prediction, i.e. to predict the next article a user might be interested in his session ($RR3$).

The NAR module is composed by three sub-modules: *Contextual Article Representation (CAR)*, *SEssion Representation (SER)*, and *Recommendations Ranking (RR)*. These sub-modules are described in the following sections.

4.3.2.1 The *Contextual Article Representation (CAR)* Sub-module

The CAR sub-module is responsible to combine the inputs for the NAR module: (1) the pre-trained Article Content Embedding; (2) the contextual properties of the article (popularity and recency); and (3) the user context (e.g., time, location, device, and referer). Such contextual information is valuable in the extreme cold-start scenario on news recommendation domain.

This sub-module can be implemented as a sequence of feed-forward *Fully Connected (FC)* layers or by using Factorization Machines (FM) to learn a representation based on its input feature interactions.

The CAR sub-module outputs the *User-Personalized Contextual Article Embedding*, whose representations might differ for the same article, depending on the user context and on the current article context (popularity and recency).

4.3.2.2 The *SEssion Representation (SER)* Sub-module

The *SEssion Representation (SER)* sub-module is responsible to model users’ short-term preferences, based on the sequence of interactions (reading news) in user’s active session.

The proposed instantiations of the SER sub-module are RNN-based, which naturally deals with sequential data. It can be instantiated by different types of RNN cells, such as LSTM (HOCHREITER; SCHMIDHUBER, 1997), GRU (CHUNG *et al.*, 2014), or *Update Gate RNN (UGRNN)* (COLLINS *et al.*, 2017).

The usage of RNNs for session-based recommendations was originally proposed by

(HIDASI *et al.*, 2016) and derived work (HIDASI; KARATZOGLOU, 2018; QUADRANA *et al.*, 2017; DONKERS *et al.*, 2017) has usually trusted on item IDs to model users preferences in their sessions, which knowledgeably intensifies the item cold-start problem.

The input for the *SER* sub-module is the sequence of news readings by the user in a session, represented as *the User-Personalized Contextual Article Embeddings*. Such approach was designed to leverage item’s content and context, and be able to recommend fresh articles.

The *SER* sub-module outputs a *Predicted Next-Article Embedding* – the expected representation of a news content the user would like to read next in the active session.

4.3.2.3 The *Recommendations Ranking (RR)* Sub-module

The *RR* sub-module is responsible to recommend articles for a user session.

Most deep learning architectures proposed for session-based RS are modeled as a classification problem, in which each available item has an output neuron, i.e., the neural network outputs a vector whose dimension is the number of available items, like (HIDASI *et al.*, 2016; HIDASI; KARATZOGLOU, 2018). Such approach may work for domains where the items number is more stable, like movies and books. Although, in the dynamic scenario of news recommendations, where thousands of news stories are added and removed daily, such approach would require to include additional output neurons for newly published articles, and eventually a full retrain of the network.

For this reason, instead of using a *softmax cross-entropy loss*, the *NAR* module optimization goal is to maximize the similarity between the *Predicted Next-Article Embedding* and the *User-Personalized Contextual Article Embedding* corresponding to the next article actually read by the user in his session (positive sample), whilst minimizing its similarity with negative samples (articles not read by the user during the session).

With this strategy, a newly published article might be immediately recommended (*RR6*), as soon as its *Article Content Embedding* is trained and added to a repository.

One inspiration for this approach came from the *DSSM* (HUANG *et al.*, 2013) and its derived works for RS, like the *MV-DNN* (ELKAHKY *et al.*, 2015), the *TDSSM* (SONG *et al.*, 2016), and the *RA-DSSM* (KUMAR *et al.*, 2017a), which uses a ranking loss based on embeddings similarity, presented in Sections A.1.7, 3.5.1, 3.5.2, and 3.5.3, respectively.

The aforementioned objective is related to recommendation accuracy, i.e. to predict the next article that the user will click next. As described in Section 2.1.4.1, it is known for many years that prediction accuracy is not the only factor that determines the success of a recommender. Other quality factors discussed in the literature are, e.g., novelty, catalog coverage, and diversity (NOIA *et al.*, 2017). Those other quality factors often im-

poses a trade-off with recommendation accuracy, because the objectives are contradictory (KARIMI *et al.*, 2018; CASTELLS *et al.*, 2015).

For example, in the context of news recommendation, the aspect of novelty is particularly relevant to avoid a “rich-get-richer” phenomenon where a small set of already popular articles get further promoted through recommendations and less popular or more recent items rarely make it into a recommendation list. Improving novelty means to recommend less popular and more long-tailed articles, which will also increase the item coverage, but will inevitably reduce the recommender accuracy (KARIMI *et al.*, 2018).

In this work, it is proposed a new approach to balance the trade-off between two conflicting quality factors – accuracy and novelty – of a session-based news recommender system. The formal optimization objectives of the *NAR* module is presented in the next sections.

4.3.2.4 Optimizing for Recommendation Accuracy

Formally, the method for optimizing prediction accuracy is described as follows. The inputs for the *NAR* module are represented by “*i*” as the article ID, “*uc*” as the user context, “*ax*” as the article context, and “*ac*” as the article textual content. Based on those inputs, we define “ $cae = \Psi(i, ac, ax, uc)$ ” as the *User-Personalized Contextual Article Embedding*, where $\Psi(\cdot)$ represents a sequence of fully-connected layers with non-linear activation functions to combine the inputs for the RNN.

The symbol *s* stands for the user session (sequence of articles previously read, represented by their *cae* vectors), and “ $nae = \Gamma(s)$ ” denotes the *Predicted Next-Article Embedding*, where $\Gamma(\cdot)$ is the output embedding predicted by the RNN as the next article.

In Equation 4.1, the function *R* describes the relevance of an item *i* for a given user session *s* as the similarity between the *nae* vector predicted as the next-article for the session and the *cae* vectors from the recommendable articles.

$$R(s, i) = \text{sim}(nae, cae) \quad (4.1)$$

The $\text{sim}(\cdot)$ function can be the *cosine similarity* (Equation 4.2), originally proposed by (HUANG *et al.*, 2013) and experimented in (MOREIRA *et al.*, 2018), or a learnable similarity function, like in our subsequent work (MOREIRA *et al.*, 2019a).

$$\text{sim}(\theta) = \frac{a \cdot b}{\|a\| \|b\|} \quad (4.2)$$

The ultimate task of the *NAR* module is to produce a ranked list of items (top-n

recommendation) that we assume the user will read next¹. Using $i \in \mathbb{D}$ to denote the set of all items that can be recommended, we can define a ranking-based loss function for a problem setting as follows. The goal of the learning task is to maximize the similarity between the predicted next article embedding (*nae*) for the session and the *cae* vector of the next-read article (positive sample, denoted as i^+), while minimizing the pairwise similarity between the *nae* and the *cae* vectors of the negative samples $i^- \in \mathbb{D}^-$. i.e., those that were not read by the user in this session. Since \mathbb{D} can be large in the news domain, we approximate it through a set \mathbb{D}' , which is the union of the unit set of the read articles (positive sample) $\{i^+\}$ and a set with random negative samples from \mathbb{D}^- .

As proposed in (HUANG *et al.*, 2013), we compute the posterior probability of an article being the next one given an active user session with a *softmax* function over the relevance scores, as shown in Equation 4.3,

$$P(i | s, \mathbb{D}') = \frac{\exp(\gamma R(i, s))}{\sum_{i' \in \mathbb{D}'} \exp(\gamma R(i', s))} \quad (4.3)$$

where γ is a smoothing factor (usually referred to as *temperature*) for the *softmax* function, which can be trained on a held-out dataset or which can be empirically set.

Using these definitions, the model parameters θ in the *NAR* module are estimated to maximize the accuracy of the recommendations, i.e, the likelihood of correctly predicting the next article given a user session. The corresponding loss function to be minimized, originally proposed in the *DSSM* (HUANG *et al.*, 2013), follows the pairwise learning-to-rank paradigm (LIU *et al.*, 2015; RAHIMI *et al.*, 2019), as shown in Equation 4.4,

$$\text{accuracy_loss}(\theta) = \frac{1}{|\mathbb{C}|} \sum_{(s, i^+, \mathbb{D}') \in \mathbb{C}} -\log(P(i^+ | s, \mathbb{D}')), \quad (4.4)$$

where \mathbb{C} is the set of user clicks available for training, whose elements are triples of the form (s, i^+, \mathbb{D}') .

Since *accuracy_loss*(θ) is differentiable w.r.t. to θ (the model parameters to be learned), we can use back-propagation on gradient-based numerical optimization algorithms in the *NAR* module.

4.3.2.5 Balancing Recommendations *Accuracy* and *Novelty*

In order to incorporate the aspect of novelty of the recommendations directly in the learning process, it is proposed in this work a novelty regularization term in the loss function of the *NAR* module. This regularization term has a hyper-parameter which can

¹This corresponds to a typical next-click prediction problem.

be tuned to achieve a balance between novelty and accuracy, according to the desired effect for the given application. Note that this approach is not limited to particular instantiations of the *CHAMELEON* meta-architecture, but can be applied to any other neural architecture which takes article’s recent popularity as one of the inputs and uses a *softmax* loss function for training (HUANG *et al.*, 2013).

In this proposed approach, it is considered the novelty definition by (VARGAS; CASTELLS, 2011; VARGAS, 2015), which is based on the inverse popularity of an item. The underlying assumption of this definition is that less popular (long-tail) items are more likely to be unknown to users and their recommendation will lead to higher novelty levels (KARIMI *et al.*, 2018).

The proposed novelty component therefore aims to bias the recommendations of the neural network toward more novel items. The positive items (actually clicked by the user) are not penalized based on their popularity, only the negative samples. The novelty of the negative items is weighted by their probabilities to be the next item in the sequence (computed according to Equation 4.3) to push those items to the top of the recommendation lists that are both novel and relevant.

Formally, the novelty loss component is defined in Equation 4.5,

$$\text{nov_loss}(\theta) = \frac{1}{|\mathbb{C}|} \sum_{(s, i^+, D'^-) \in \mathbb{C}} \frac{\sum_{i \in D'^-} P(i | s, D'^-) * \text{novelty}(i)}{\sum_{i \in D'^-} P(i | s, D'^-)}, \quad (4.5)$$

where \mathbb{C} is the set of recorded click events for training, \mathbb{D}'^- is a random sample of the negative samples, not including the positive sample as in the accuracy loss function (Equation 4.4). The novelty values of the items are weighted by their predicted relevance $P(i | s, \mathbb{D}'^-)$ in order to push both novel and relevant items towards the top of the recommendations list.

The novelty metric in Equation 4.6 is defined based on the *recent normalized popularity* of items. The negative logarithm in Equation 4.6 increases the value of the novelty metric for long-tail items. The computation of the *normalized popularity* sums up to 1.0 for all recommendable items (set \mathbb{I}), as shown in Equation 4.7. Since we are interested in the recent popularity, we only consider the clicks an article has received within a time frame (e.g., in the last hour), as returned by the function `recent_clicks(\cdot)`.

$$\text{novelty}(i) = -\log_2(\text{rec_norm_pop}(i) + 1), \quad (4.6)$$

$$\text{rec_norm_pop}(i) = \frac{\text{recent_clicks}(i)}{\sum_{j \in \mathbb{I}} \text{recent_clicks}(j)} \quad (4.7)$$

4.3.2.5.1 Complete Loss Function The complete loss function proposed in this work combines the objectives of accuracy and novelty, as shown in Equation 4.8,

$$L(\theta) = \text{accuracy_loss}(\theta) - \beta * \text{nov_loss}(\theta), \quad (4.8)$$

where β is the tunable hyper-parameter for novelty. Notice that the novelty loss term is subtracted from the accuracy loss, as this term is higher when more novel items are recommended. The values for β can either be set based on domain expertise or be tuned to achieve the desired effects.

4.4 Comparison with Related Works

In the face of Deep Learning rapid advances, a specific architecture may become obsolete some months after its proposal, for using neural network components or methods that are not state-of-the-art anymore.

For this reason, the *CHAMELEON* was structured as a high-level meta-architecture, to be modularized and support changes (RR7). It is composed of inputs, outputs, modules, sub-modules, data repositories, and their interactions. Modules and sub-modules can be instantiated by newly proposed neural network architectures or by existing architectures that prove themselves to work better for specific types of news portals.

The inspiration for the *CHAMELEON* Meta-Architecture came from a survey on tens of works on News Recommender Systems and on Deep Learning methods applied to RS, as described in Chapters 2 and 3. It was designed specifically to address the challenges on news recommendation.

To the best of the knowledge from this research so far, the only works presenting a deep learning architecture for news recommendation were (SONG *et al.*, 2016), (KUMAR *et al.*, 2017a; KUMAR *et al.*, 2017c), (PARK *et al.*, 2017), (OKURA *et al.*, 2017), (ZHANG *et al.*, 2018), and (WANG *et al.*, 2018). Those neural architectures for news recommendation were described in more detail on Chapter 3. In Table 4.1 it is consolidated a feature matrix with the main differences among those architectures and the *CHAMELEON*. Those differences are discussed throughout the rest of this section.

In general, some of those works addressed sequence-based recommendation, ignoring the temporal intervals between user sessions. Only (PARK *et al.*, 2017), (OKURA *et*

TABLE 4.1 – Comparison among Deep Neural Architectures for News RS

<i>Features</i>	<i>(SONG et al., 2016)</i>	<i>(KUMAR et al., 2017a)</i>	<i>(PARK et al., 2017)</i>	<i>(OKURA et al., 2017)</i>	<i>(WANG et al., 2018)</i>	<i>(ZHANG et al., 2018)</i>	<i>CHAMELEON</i>
Session-based recommendation	No	No	YES	YES	No	YES	YES
Multiple quality objectives	No	No	No	No	No	No	YES
Temporal articles relevance decay	No	No	No	No	No	YES (exponential function)	YES (decay learned by the model)
Time-aware negative sampling	No	No	YES	No	N/A	No	YES
Modeling of article context (recency, recent popularity)	No	No	No	No	No	No	YES
User Context	No	No	No	No	No	No	YES
Textual Content Features	Letter trigrams processed by MLP	doc2vec	PV-DBoW	Denoising auto-encoder	Enrichment with a Knowledge Graph	Character-level CNN	Sup. and Unsup. ACR instantiations (CNN, GRU)
Architecture for sequence modeling	RNN	RNN	RNN	RNN	DNN with attention	RNN	RNN
Loss function	Log likelihood from <i>DSSM</i> (pairwise ranking)	Log likelihood from <i>DSSM</i> (pairwise ranking)	BPR, TOP1 (pairwise ranking)	Pairwise ranking with position bias	Log loss (pointwise ranking)	BPR, TOP1 (pairwise ranking)	Log likelihood from <i>DSSM</i> (pairwise ranking)

et al., 2017), and (ZHANG *et al.*, 2018) address session-based news recommendations, like *CHAMELEON*.

4.4.1 The *GRU4Rec* and Derived Work on Session-based RS Using RNN

Since the *GRU4Rec*, proposed in the seminal work of (HIDASI *et al.*, 2016) (described in Section 3.3.1), and the subsequent work on (HIDASI *et al.*, 2016; HIDASI; KARATZOGLOU, 2018), a research line has emerged on the usage of RNN on session-based recommendations. (WU *et al.*, 2016) have proposed an RNN to predict the probability that the

user will access an item given heterogeneous feedback of this user and (LIU *et al.*, 2016) and (SMIRNOVA; VASILE, 2017) have proposed some adaptations to feed RNNs with user contextual information.

One limitation of *GRU4Rec* in the news domain is that the method can only recommend items that appeared in the training set, because it is trained to predict scores for a fixed number of items. Another potential limitation is that RNN-based approaches, that only use item IDs for learning with no side information, might not be much better or even worse in terms of prediction accuracy than simpler approaches. Detailed analyses of this phenomenon can be found in (JANNACH; LUDEWIG, 2017; JUGOVAC *et al.*, 2018; LUDEWIG; JANNACH, 2018). The *CHAMELEON* uses articles content and context embeddings to represent items and also user context to represent users, dealing smoothly with the incoming stream of new articles and users interactions.

In (PARK *et al.*, 2017), it was proposed a deep neural architecture for news recommendation, which was described in Section 3.4.2.3. There are some similarities to *CHAMELEON*, as their architecture uses RNN for session-based recommendation. They also leverage the articles content – in their case a bag-of-words representation – to provide hybrid recommendation to combat the item cold-start problem.

It is reported in their study that they had tried many paired ranking losses functions, such as *BPR* and *TOP1* (HIDASI *et al.*, 2016). During the design of the *CHAMELEON*, those losses functions were also explored, but it was observed that the *DSSM*-based loss function resulted in a much higher accuracy.

Differently from their approach, which takes the articles categories in a post-processing reranking heuristic, the *CHAMELEON* includes the article metadata (e.g., category, author) as an input feature for the RNN, deeply integrated with other features, such as the article context (e.g., popularity, recency) and the user context (e.g., time, device, location).

Another key difference is that their model projects linearly the output of the RNN to the same space of their article content embeddings to be able to compute similarities, whereas in *CHAMELEON* the similarity is computed based on *User-Personalized Contextual Article Embeddings*, which are generated as a non-linear combination of the content of the articles with user-personalized and contextual information.

4.4.2 The *DSSM* and Derived Works on Multi-view Learning

The *Deep Semantic Structured Model (DSSM)* was proposed in (HUANG *et al.*, 2013) for the query ranking purpose, as described in Section A.1.7. Essentially, the *DSSM* can be seen as a multi-view learning model that often is composed of two or more neural

networks for each individual view. In the original two-view *DSSM* model, the left network represents the query view and the right network represents the document view.

(ELKAHKY *et al.*, 2015) have adapted the *DSSM* for the recommendation task, as described in Section 3.5.1. They map users and items to a latent space, where the similarity between users and their preferred items is maximized. This architecture was named the *Multi-View Deep Neural Network (MV-DNN)*.

The *DSSM* and the *MV-DNN* multi-learning view models were important inspirations to the *CHAMELEON* Meta-Architecture, in special, for the approach of item recommendation, by ranking similar embeddings. Usual works on neural networks for RS use a fixed set of items (output neurons), which would be unsuitable to recommend fresh articles, i.e., not seen during training.

(SONG *et al.*, 2016) have pointed out that, in *MV-DNN* and *DSSM* architectures, the user view and item view were static, representing a holistic view of users' interests, during a certain period of time. They proposed an extension to those models named the *TDSSM* (SONG *et al.*, 2016), which replaces the left network with item static features, and the right network with two subnetworks to model user static features (with MLP) and user temporal features (with RNNs). Their case study was on news RS, making that work particularly interesting for this research, as presented in Section 3.5.2.

To model users interests at varying time spots, they have used two LSTMs in different rates – the *fast-rate* LSTM used daily signals and the *slow-rate* LSTM leveraged weekly signals. Although, they did not model user sessions explicitly. Users and items representation were pre-trained by a *DSSM*, for which authors do not describe the used features and textual representation. In the proposed *CHAMELEON*, items and users representations are learned directly from news content and users behaviours across sessions.

As introduced in Section 3.5.2.1, the neural architecture proposed by (OKURA *et al.*, 2017) for session-based news recommendation have some similarities to *CHAMELEON*. They created a modified denoising autoencoder to learn textual content representation from articles. RNNs are used to learn and infer users representation. In this sense, it could be considered as an instantiation of the *ACR* and *NAR* modules of *CHAMELEON*.

Among the differences, they use a pairwise ranking loss not based in *softmax* and they do not include neither article context (e.g., popularity and recency) and user context (e.g., time, device) when providing recommendation, which may limit their accuracy. Finally, their negative sampling approach considers only non-clicked articles listed vertically, which may reinforce a selection bias created by the current ranking system.

(KUMAR *et al.*, 2017a) have proposed the *RA-DSSM* architecture, as described in Section 3.5.3. It was also an extension of the *DSSM*, now applied to news recommendations domain. The *RA-DSSM* could be seen as a partial instantiation of *CHAMELEON's* *NAR*

module. They leveraged *bidirectional LSTM* with an attention mechanism to provide session-based recommendations.

The *RA-DSSM* provide sequence-based (not session-based) recommendation, ignoring the temporal aspects of news readership. Their evaluation protocol is not realistic to emulate news portals behaviour, as previously discussed in Section 3.5.3.

Like this proposed *CHAMELEON*, the *RA-DSSM* do not represent the articles only by their IDs. Instead, they represent articles content as *doc2Vec* embeddings (LE; MIKOLOV, 2014), which are unsupervisedly pre-trained on the text. On the other hand, the *Article Content Representation (ACR) module* of *CHAMELEON* trains news content embeddings from articles' text in a *supervised* or *unsupervised* approach.

Finally, the *RA-DSSM* does not use any contextual information about the user and articles, which may profoundly limit its accuracy in a extreme cold-start scenario like news recommendation, as previously discussed.

4.4.3 Deep Feature Extraction from Textual Data

Deep learning has been shown to be able to automatically extract powerful features from unstructured data. Recent research on hybrid RS has leveraged deep learning to extract features from textual data, like *ConvMF* (KIM *et al.*, 2016), *D-Attn* (SEO *et al.*, 2017), *DeepCoNN* (ZHENG *et al.*, 2017), and *TransNets* (CATHERINE; COHEN, 2017). Therefore, those hybrid RS studies leverage textual data from side information, like movie or product reviews.

(BANSAL *et al.*, 2016) proposed a neural architecture for scientific articles recommendation. They used an end-to-end neural network based on GRUs, to jointly model papers' textual content and item ID in multi-task objectives: predicting papers tags and users preferences on items. According to the authors, such multi-task learning lead to better content representations. It would hardly scale in the news domain, since the number of user interactions on news portals is massive and, on their architecture, full processing of text is required to obtain articles content representation.

In (WANG *et al.*, 2018) it was introduced a neural architecture for news recommendation named *DKN*, described in more details in Section 3.4.2.4. It models the sequence of past users clicks (sequence-aware, not session-based RS) for CTR prediction. Differently than *CHAMELEON*, they do not use the actual content of the article, but only its title. Then, they search in a knowledge graph the entities mentioned in the title, and then expand the content representation with the found entities and their immediate neighbours in the graph. They also use CNNs to process the textual content, but their architecture have an additional channel to process the found entities representations.

Furthermore, in *DKN* the sequence of user clicks is processed by a DNN with attention mechanism, while the *CHAMELEON* processes the sequence of clicks by using an RNN.

The *DKN* is a sequence-aware RS and not a session-based RS such as *CHAMELEON*, ignoring the important temporal aspects of news readership. It models the sequence of all user clicks, regardless the elapsed time between the user sessions and clicks, which may vary from minutes to months.

Finally, the evaluation protocol proposed by (WANG *et al.*, 2018) is not realistic for news recommendation, as it samples candidate news regardless of their publishing date, and also do not evaluate aspects other than accuracy, such as novelty and diversity.

Other related work is (ZHANG *et al.*, 2018), described in more detail in Section 3.3.11. They have proposed a neural architecture – the *DeepJoNN* – for session-based news recommendation, that uses a character-level CNN to process articles’ input features and processes the sequence of session clicks with an RNN.

The *DeepJoNN* does not use any contextual features from the user or articles (e.g., recent popularity). They also do not model the temporal aspects of news readership, randomly sampling articles published in different periods together for training.

Furthermore, the authors of *DeepJoNN* have proposed a fixed exponential function to model the temporal decay of news relevance. On the other hand, *CHAMELEON* uses the recency as an input feature, letting the network to learn an arbitrary function to model the news relevance decay, depending on the content of the article and on the user and article contexts.

4.4.4 Balancing Accuracy and Novelty in Recommender Systems

The novelty of a recommended item can be defined in different ways, e.g., as the non-obviousness of the item suggestions (HERLOCKER *et al.*, 2004) or in terms of how different an item is with respect to what has already been experienced by a user or the community (VARGAS; CASTELLS, 2011). Recommending solely novel or unpopular items can, however, be of limited value when they do not match the users’ interests well. Therefore, the goal of a recommender is often to balance these competing factors, i.e., make somewhat more novel and thus risky recommendations, while at the same time ensuring high accuracy.

In the literature, a number of ways have been proposed to *quantify* the degree of novelty, including alternative ways of considering popularity information (ZHOU *et al.*, 2010) or the distance of a candidate item to user’s profile (KARIMI *et al.*, 2018; NAKATSUJI *et al.*, 2010; RAO *et al.*, 2013b). In (VARGAS; CASTELLS, 2011), the authors propose to

measure novelty as the opposite of popularity of an item, under the assumption that less popular (long-tail) items are more likely to be unknown to users and their recommendation will, hopefully, lead to higher novelty levels. In our work, we will also consider the popularity-based novelty of the recommendations and adapt existing novelty metrics from the literature.

Regarding the treatment of trade-off situations, different technical approaches are possible. One can, for example, try to re-rank an accuracy-optimized recommendation list, either to meet globally defined quality levels (ADOMAVICIUS; KWON, 2011) or to achieve recommendation lists that match the preferences of individual users (JUGOVAC *et al.*, 2017). Another approach is to vary the weights of the different factors to find a configuration that leads to both high accuracy and novelty (GARCIN *et al.*, 2013).

Finally, one can try to embed the consideration of trade-offs within the learning phase, e.g., by using a corresponding regularization term. In (COBA *et al.*, 2018), the authors propose a method called *Novelty-aware Matrix Factorization (NMF)*, which tries to simultaneously recommend accurate and novel items. Their proposed regularization approach is pointwise, meaning that the novelty of each candidate item is considered individually.

In our recommendation approach, we consider trade-offs in the regularization term as well. Differently, from (COBA *et al.*, 2018), however, our approach is not focused on matrix factorization, but rather on neural models that are derived from the *DSSM*. Furthermore, the objective function in our work uses a pairwise ranking approach to learn how to enhance the novelty level of the top-n recommendations.

5 CHAMELEON Instantiations and Experiments Design

In this chapter, it is described: some instantiations of the *CHAMELEON* meta-architecture; their implementation strategies; the evaluation methodology, including metrics and datasets; and the experimental design.

The results of the evaluation will be discussed later in Chapter 6.

5.1 The *CHAMELEON* Instantiations

In this section, it is described the *CHAMELEON* instantiations for experiments. The *The ACR* module is instantiated as three concrete architectures – two *supervised* and other *unsupervised*. It is also described an instantiation of the *NAR* module.

5.1.1 The *ACR* Module Instantiations

In this section, it is described the *ACR* module instantiations for the experiments – *supervised* and *unsupervised*. Their training methods are detailed in Annex A.

The input features and target attributes (only for *supervised* instantiations) for the *ACR* module are presented in Table 5.1.

TABLE 5.1 – Features used by the *Article Content Representation (ACR)* module.

<i>Features</i>	<i>Type</i>	<i>Description</i>
Input features		
Textual Content	Emb.	Article text represented as a sequence of word embeddings, pre-trained for the language of the dataset. ¹
Target features (<i>supervised</i> only)		
Category	Categ.	The category of the article, defined by editors.
Keywords*	Categ.	Human-labeled keywords for the Adressa dataset.

The input for the *ACR* module is the sequence of word embeddings of the news article content. More formally, let $x_i \in \mathbb{R}^k$ be the k -dimensional word embedding vector corresponding to the i -th word in the document. A document of length n (padded when necessary) is represented, as shown in Equation 5.1

$$x_{1:n} = x_1 \oplus x_2 \oplus \dots \oplus x_n, \quad (5.1)$$

where \oplus is the concatenation operator.

5.1.1.1 The *ACR* Module - Supervised Instantiation

It is proposed two *supervised* instantiations for the *ACR* module – one CNN-based and the other RNN-based – presented in Figures 5.1 and 5.2, respectively. Those different instantiations are further implemented in the experiments to analyze the effect of different textual representation in recommendation quality.

Their *sub-modules* instantiations for *supervised* scenario are described next.

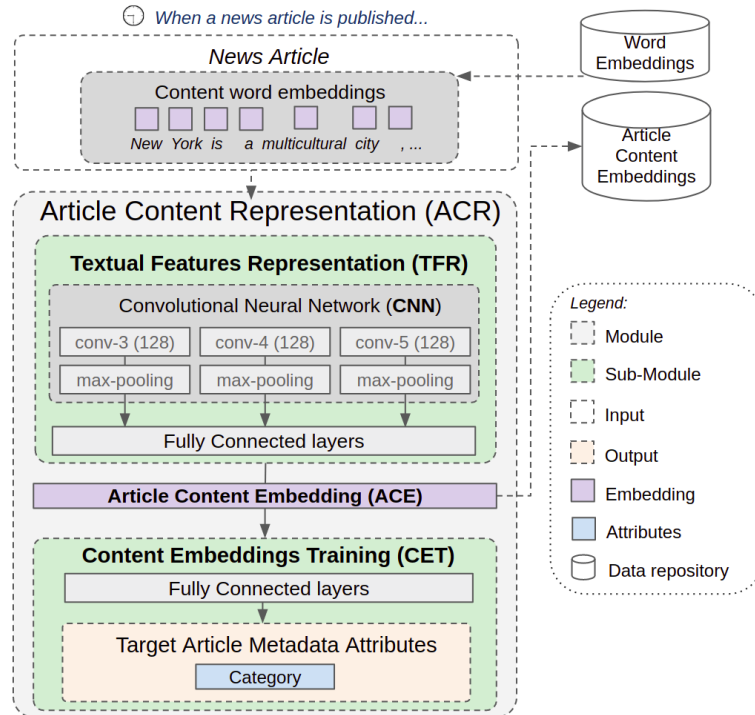
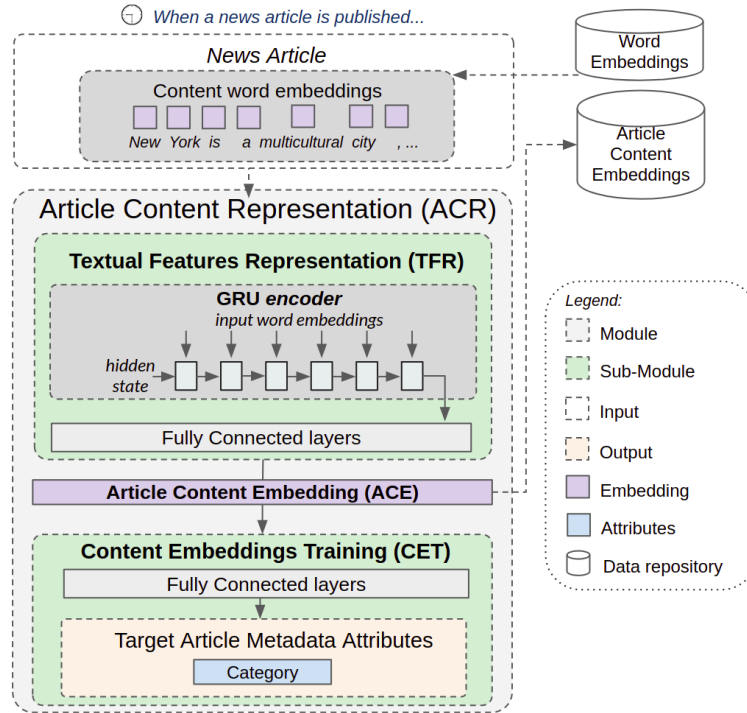

FIGURE 5.1 – A *supervised* CNN-based instantiation of the *ACR* module

5.1.1.1.1 A CNN-based Instantiation of the *Text Feature Representation (TFR)* Sub-module

In the CNN-based instantiation of the *Text Feature Representation*

¹Portuguese: Pre-trained *word2Vec skip-gram* model (300 dimensions) available at <http://nilc.icmc.usp.br/embeddings>; Norwegian: a *skip-gram* model (100 dimensions) available at <http://vectors.nlpl.eu/repository> (model #100).

 FIGURE 5.2 – A supervised RNN-based instantiation of the *ACR* module

tion (*TFR*) sub-module, it was instantiated as an architecture based on Convolutional Neural Networks (CNN), inspired on (KIM, 2014). CNNs have being widely used in Deep NLP research as a simple, fast, and powerful method for feature extraction from textual data.

It has a three independent convolutional layers, each one with filter region sizes of 3, 4, and 5. Each filter performs the convolution operation in a sliding window of word embeddings – in this case, sliding over 3, 4, or 5 words at a time. More formally, let $x_{i:i+j}$ refer to the concatenation of words $x_i, x_{i+1}, \dots, x_{i+j}$. A convolution operation involves a filter $w \in \mathbb{R}^{sk}$, which is applied to a window of s word embeddings of k dimensions to produce a new feature. For example, as shown in Equation 5.2, a feature c_i is generated from a window of words $x_{i:i+s-1}$.

$$c_i = f(w \cdot x_{i:i+s-1} + b) \quad (5.2)$$

Here, $b \in \mathbb{R}$ is a bias term, \cdot is the dot product (a sum over element-wise multiplications), and f is a non-linear function: the *Rectified Linear Units (ReLU)*. A filter is applied to each possible window of words in the document $x_{1:s}, x_{2:s+1}, \dots, x_{n-s+1:n}$ to produce a feature map $c \in \mathbb{R}^{n-s+1}$, as shown in Equation 5.3.

$$c = [c_1, c_2, \dots, c_{n-s+1}] \quad (5.3)$$

A number of filters g is defined for each specific filter size s . Each of these filters will produce a feature map for each sliding window over the input text.

News articles' length may vary, but it is necessary to have a fixed dimension for the *Article Content Embedding*. Thus, for each filter, a max-pooling operation is performed over its produced feature maps, returning its largest value, which are concatenated in a unified feature map $m \in \mathbb{R}^g$ for each filter size s . Finally, the unified feature maps for all filter sizes are concatenated in a vector $z \in \mathbb{R}^{gs}$ – the Article Content Embedding of the *ACR* module.

5.1.1.1.2 An RNN-based Instantiation of the *Text Feature Representation (TFR)* Sub-module In the RNN-based instantiation of the *Text Feature Representation (TFR)* sub-module, it was instantiated based on a type of RNN architecture – the Gated Recurrent Unit (GRU) (CHUNG *et al.*, 2014), which is less computationally expensive than Long Short-Term Memory (LSTM) (GERS, 2001; HOCHREITER; SCHMIDHUBER, 1997).

A GRU network updates its hidden state as follows:

$$z_t = \sigma_g(W_z x_t + V_z h_{t-1} + b_z) \quad (5.4)$$

$$r_t = \sigma_g(W_r x_t + V_r h_{t-1} + b_r) \quad (5.5)$$

$$\hat{h}_t = \tanh(W_h x_t + V_h (r_t \odot h_{t-1}) + b_h) \quad (5.6)$$

$$h_t = (1 - z_t) \cdot h_{t-1} + z_t \cdot \hat{h}_t \quad (5.7)$$

where \odot denotes element-wise multiplication, σ_g and \tanh are sigmoid and tangent functions respectively, W , V , and b are parameter matrices and vectors. The reset gate r_t and update gate z_t control how information is updated to the new hidden state.

In this *TFR* sub-module instantiation, the GRU layer processes the input text word-by-word.

The hidden states at each step are *max-pooled* to generate a representation of the article content. This representation is processed by an additional feed forward fully connected layer, which outputs the *Article Content Embedding (ACE)*. The *ACE* is trained by the *CET* sub-module, described next.

5.1.1.1.3 Content Embedding Training (CET) Sub-module Instantiation The *Content Embedding Training (CET)* sub-module was instantiated by simple neural components – a *dropout* layer followed by a feed-forward layer with non-linear activation function. The network is trained to minimize the *softmax cross-entropy loss* of the predicted categories.

More details on the training of the supervised instantiation of the *ACR* module are found in Annex A.

5.1.1.2 The *ACR* Module - Unsupervised Instantiation

An *unsupervised* instantiation of the *ACR* module is presented in Figure 5.3.

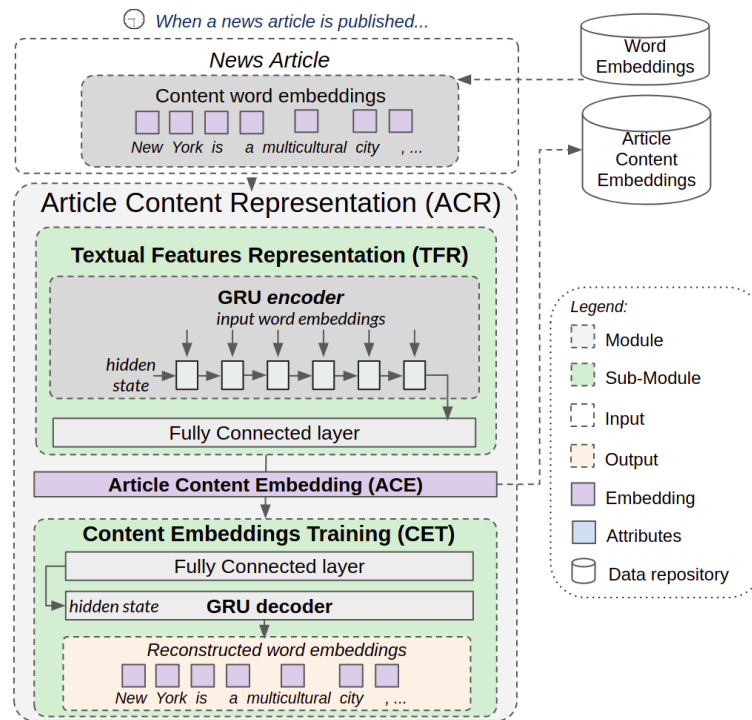

FIGURE 5.3 – An *unsupervised* instantiation of the *ACR* module

As described in Annex A, the *unsupervised* instantiation is based in a *Sequence Autoencoder* (DAI; LE, 2015; SRIVASTAVA *et al.*, 2015) - a type of RNN-based Encoder-Decoder architecture. The article text is encoded to generate a compressed representation and decoded to reconstruct the original input text, represented as a sequence of word embeddings.

5.1.1.2.1 The *Text Feature Representation (TFR)* Sub-module Instantiation

The *TFR* sub-module acts as an encoder of the input text. It is instantiated with a *GRU* (CHUNG *et al.*, 2014) *encoder layer*, which process the input word embeddings one-by-one.

The last hidden state of the *GRU encoder layer* is used as input of a feed-forward layer with *tanh* activation function, which projects the content representation to the specified dimension for the *Article Content Embedding (ACE)*.

In the experiments implementation, the first 30 words from the concatenation of article’s title and content was considered as input. It was added some random noise to the input word embeddings, an approach known as *Denoising Autoencoder* (ALAIN; BENGIO, 2014)), to work as a regularizer.

As suggested by (SUTSKEVER *et al.*, 2014) and (SRIVASTAVA *et al.*, 2015), the sequence of input words is reversed (while keeping as target words the original words ordering), because doing so has been shown to improve reconstruction accuracy and to introduce short term dependencies in data that make the optimization problem easier.

5.1.1.2.2 The *Content Embedding Training (CET)* Sub-module Instantiation

The *CET* sub-module acts as a decoder, trying to reconstruct the original text from the encoded *ACE*.

It is composed by a feed-forward layer, which project the *ACE* back to the dimension (number of units) of the *GRU decoder layer*.

The *GRU decoder layer* have its hidden state initialized by the previous feed-forward layer.

The first input for the *GRU decoder layer* is a padding embedding and expected output is the embedding of the first word of article’s text. Next, the first word is used as input and the second word as output, and so forth.

The network is trained to minimize the *Mean Squared Error (MSE)* between the correct and predicted word embeddings, as detailed in Annex A.

5.1.2 The *NAR* Module Instantiations

To feed the *Next Article Recommendation (NAR)* module, rich features were extracted from the user interactions logs, as detailed in Table 5.2. The input features were prepared as follows.

Categorical features with low cardinality (i.e., with less than 10 distinct values) were one-hot encoded and features with high cardinality were represented as trainable embeddings. Numerical features were standardized with *z-normalization*.

The *Article Content Embeddings* are L2-normalized, so that each embedding has zero mean and unit size.

The dynamic features for *novelty* and *recency* were normalized based on a sliding

window of the recent clicks (within the last hour), so that they can accommodate both repeating changes in their distributions over time, e.g., within different periods of the day, and abrupt changes in global interest, e.g., due to breaking news.

TABLE 5.2 – Features used by the *Next-Article Recommendation (NAR)* module

<i>Group</i>	<i>Features</i>	<i>Type</i>	<i>Description</i>
Dynamic article features			
Article Context	Novelty	Num.	The novelty of an article, computed based on its normalized recent popularity, as described in Equation 4.6.
	Recency	Num.	Computed as the logarithm of the elapsed days (with hours represented as the decimal part) since an article was published: $\log_2((\text{current_date} - \text{published_date})+1)$.
Static article features			
Id	Id	Emb.	Trainable embeddings for article IDs.
Content	ACE	Emb.	The <i>Article Content Embedding</i> representation learned by the <i>ACR</i> module.
Metadata	Category	Cat.	Article category
	Author *	Cat.	Article author
User context features			
Location	Country, Region, City*	Categ.	Estimated location of the user
	Device type	Categ.	Desktop, Mobile, Tablet, TV**
Device	OS	Categ.	Device operating system
	Platform**	Categ.	Web, mobile app
Time	Hour of the day	Num.	Hour encoded as cyclic continuous feature (using sine and cosine)
	Day of the week	Num.	Day of the week
Referrer	Referrer type	Categ.	Type of referrer: e.g., direct access, internal traffic, search engines, social platforms, news aggregators

* Only available for the Adressa dataset.

** Only available for the G1 dataset.

In the following sections, the sub-modules instantiations of the *NAR* module are described.

5.1.2.1 The *Contextual Article Representation (CAR)* Sub-module Instantiation

The *CAR* sub-module is instantiated as follows.

First, all input features f are concatenated and normalized by a layer with trainable scalar parameters to center (γ) and scale (β) input features, as shown in Equation 5.8.

$$\text{norm}(f) = (f * \gamma) + \beta, \quad (5.8)$$

This is followed by two feed-forward fully connected layers, with *Leaky ReLU* (MAAS *et*

al., 2013) and *tanh* activation functions, respectively, whose output is the *User-Personalized Contextual Article Embedding*.

5.1.2.2 The SEssion Representation (SER) Sub-module Instantiation

The *SER* sub-module uses an RNN to model the sequence of user interactions. We empirically tested different RNN cells, like variations of LSTM (HOCHREITER; SCHMIDHUBER, 1997) and GRU (CHUNG *et al.*, 2014), whose results were very similar. At the end, we selected the Update Gate RNN (*UGRNN*) cell (COLLINS *et al.*, 2017), as it led to slightly higher accuracy. The *UGRNN* architecture is a compromise between *LSTM/GRU* and a vanilla RNN. In the *UGRNN* architecture, there is only one additional gate, which determines whether the hidden state should be updated or carried over (COLLINS *et al.*, 2017). Adding a new (non bi-directional) RNN layer on top of the previous one also led to some accuracy improvement.

The RNN layer is followed by a sequence of two feed-forward layers, with *Leaky ReLU* and *tanh* activation functions, respectively, whose output is the *Predicted Next-Article Embedding*.

5.1.2.3 The Recommendations Ranking (RR) Sub-module Instantiation

The *RR* sub-module is responsible to rank candidate articles based on the relevance of an article for a given session, based on embeddings similarity.

As described in Section 4.3.2.4 and reported in (MOREIRA *et al.*, 2018), it is possible to use the *cosine similarity*.

For these experiments, also reported in (MOREIRA *et al.*, 2019a), the architecture was instantiated so that it was flexible to learn an arbitrary matching function $\text{sim}(\cdot)$. It was composed by the element-wise product of the embeddings, followed by a number of feed-forward layers with non-linear activations (*Leaky ReLU* (MAAS *et al.*, 2013)), as shown in Equation 5.9,

$$\text{sim}(nae, cae) = \phi(nae \odot cae), \quad (5.9)$$

where $\phi(\cdot)$ represents a sequence of fully-connected layers with non-linear activation functions and the last layer outputs a single scalar representing the relevance of an article as the predicted next article. In our study, $\phi(\cdot)$ consisted of a sequence of 4 feed-forward layers with a *Leaky ReLU* activation function (MAAS *et al.*, 2013), with 128, 64, 32, and 1 output units.

Finally, the model is trained to minimize the *NAR* module loss function, described in

Section 4.3.2.5.1.

5.2 Baseline Recommendation Methods

In our experiments, we consider (a) different variants of our instantiation of the *CHAMELEON* meta-architecture to assess the value of considering additional types of information and (b) a number of session-based recommender algorithms, described in Table 5.3. While some of the chosen baselines appear conceptually simple, recent work has shown that some of them are able to outperform very recent neural approaches for session-based recommendation tasks (JANNACH; LUDEWIG, 2017; LUDEWIG; JANNACH, 2018; JUGOVAC *et al.*, 2018; LUDEWIG *et al.*, 2019b). Furthermore, the simple methods, unlike neural-based approaches, can be continuously updated over time and take newly published articles into account.

5.3 Evaluation Methodology

One main goal of our experimental analyses is to make our evaluations as realistic as possible. We therefore did not use the common evaluation approach of random train-test splits and cross-validation.

Instead, we use a temporal offline evaluation method (MOREIRA *et al.*, 2018), which simulates a streaming flow of user interactions (clicks) and new articles being published, whose value quickly decays over time. Since in practical environments it is highly important to very quickly react to incoming events (LUDMANN, 2017; KILLE *et al.*, 2017), the baseline recommender methods were constantly updated over time.

CHAMELEON's *NAR* module supports online learning, as it is trained on mini-batches. In our evaluation protocol, we decided to emulate a streaming scenario, in which each user session is used for training only once. Such a scalable approach is different from many model-based recommender systems, like *GRU4Rec*, which require training for some epochs on a large set of recent user interactions to reach competitive accuracy results.

5.3.1 Evaluation Protocol

The evaluation process works as follows:

- The recommenders are continuously trained on users' sessions ordered by time and grouped by hours. Each five hours, the recommenders are evaluated on sessions from the next hour, as exemplified in Figure 5.4. With this interval of five hours

TABLE 5.3 – Baseline session-based recommender algorithms used in the experiments.

Neural Methods	
<i>GRU4Rec</i>	A landmark neural architecture using RNNs for session-based recommendation (HIDASI <i>et al.</i> , 2016), described in Section 3.3.1. For this experiment, we used the <i>GRU4Rec v2</i> implementation, which includes the improvements reported in (HIDASI; KARATZOGLOU, 2018). We furthermore improved the algorithm’s negative sampling strategy for the scenario of news recommendation.
<i>SR-GNN</i>	A recently published state-of-the-art architecture for session-based recommendation based on Graph Neural Networks (WU <i>et al.</i> , 2019), described in Section 3.3.12. Their authors reported superior performance over other neural architectures such as <i>GRU4Rec</i> (HIDASI <i>et al.</i> , 2016), <i>NARM</i> (LI <i>et al.</i> , 2017) and <i>STAMP</i> (LIU <i>et al.</i> , 2018).
Association Rules-based Methods	
<i>Co-Occurrence (CO)</i>	Recommends articles commonly viewed together with the last read article in previous user sessions. This algorithm is a simplified version of the association rules technique, having two as the maximum rule size (pairwise item co-occurrences) (LUDEWIG; JANNACH, 2018; JUGOVAC <i>et al.</i> , 2018).
<i>Sequential Rules (SR)</i>	The method uses association rules of size two. It however considers the sequence of the items within a session. A rule is created when an item q appeared after an item p in a session, even when other items were viewed between p and q . The rules are weighted by the distance x (number of steps) between p and q in the session with a linear weighting function $w_{SR} = 1/x$ (LUDEWIG; JANNACH, 2018);
Neighborhood-based Methods	
<i>Item-kNN</i>	Returns the most similar items to the last read article using the cosine similarity between their vectors of co-occurrence with other items within sessions. This method has been commonly used as a baseline when neural approaches for session-based recommendation were proposed, e.g., in (HIDASI <i>et al.</i> , 2016).
<i>Vector Multiplication Session-Based kNN (V-SkNN)</i>	This method compares the entire active session with past (neighboring) sessions to determine items to be recommended. The similarity function emphasizes items that appear later within the session. The method proved to be highly competitive in the evaluations in (JANNACH; LUDEWIG, 2017; LUDEWIG; JANNACH, 2018; JUGOVAC <i>et al.</i> , 2018).
Other Methods	
<i>Recently Popular (RP)</i>	This method recommends the most viewed articles within a defined set of recently observed user interactions on the news portal (e.g., clicks during the last hour). Such a strategy proved to be very effective in the <i>2017 CLEF News-REEL Challenge</i> (LUDMANN, 2017).
<i>Content-Based (CB)</i>	For each article read by the user, this method suggests recommendable articles with similar content to the last clicked article, based on the cosine similarity of their <i>Article Content Embeddings</i> .

(not a divisor of 24 hours), it was possible to sample different hours of the day across the dataset for evaluation. After the evaluation of the next hour was done, this hour is also considered for training, until the entire dataset is covered.² It is important to notice that, while the baseline methods are continuously updated during the evaluation hour, *CHAMELEON*'s model is not. This allows us to emulate a realistic scenario in production where the neural network is trained and deployed once an hour to serve recommendations for the next hour;

- For each session in the evaluation set, we incrementally “revealed” one click after the other to the recommender, as done, e.g., in (HIDASI *et al.*, 2016) and (QUADRANA *et al.*, 2017);
- For each click to be predicted, we created a random set containing 50 recommendable articles that were *not* viewed by the user in the session (negative samples) plus the true next article (positive sample), as done in (KOREN *et al.*, 2009) and (CREMONESI *et al.*, 2010). We then evaluate the algorithms in the task of ranking those 51 items;
- Given these rankings, standard information retrieval metrics can be computed.

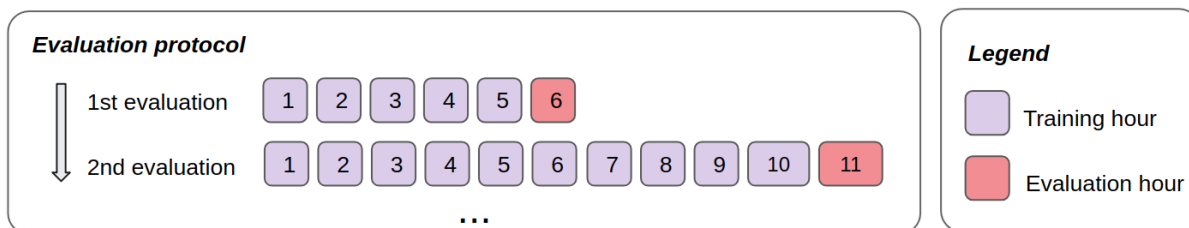

FIGURE 5.4 – Illustration of the evaluation protocol. After training for 5 hours, the sessions of the next hour are evaluated.

For a realistic evaluation, it is important that the chosen negative samples consist of articles which would be of some interest to readers and which were also available for recommendation in the news portal at a given point of time. For the purpose of this study, we therefore selected as recommendable articles the ones that received at least one click by any user in the preceding hour. To finally select the negative samples, we implemented a popularity-based sampling strategy similar to the one from (HIDASI *et al.*, 2016).

5.3.2 Metrics

To measure quality factors such as accuracy, item coverage, novelty, and diversity, we have selected a set of top-N metrics from the literature. We chose the cut-off threshold at

²Our dataset consists of 16 days. We used the first two days to learn an initial model for the session-based algorithms and report the averaged measures after that warm-up period.

$N=10$, representing about 20% of the list containing the 51 sampled articles (1 positive sample and 50 negative samples).

The accuracy metrics used in our study – Hit Rate and Mean Reciprocal Rank – originate from Information Retrieval field and are very popular in Recommender Systems.

The *Hit Rate* ($HR@n$) is the percentage of times in which *relevant* items (the next clicked ones) are retrieved among the top- N ranked items, as shown in Equation 5.10,

$$HR@n = \frac{1}{Q} \sum_{i=1}^Q \begin{cases} 1 & \text{if } \text{rank}_i \leq n \\ 0, & \text{otherwise} \end{cases}, \quad (5.10)$$

where Q is a sample of recommendation lists, rank_i refers to the rank position of the *relevant* item for the i -th recommendation list. If rank_i is greater than n , this recommendation scores as 0.

The *Mean Reciprocal Rank* ($MRR@n$) is a ranking metric that is sensitive to the position of the true next item (*relevant* item) in the list. As shown in Equation 5.11, it is the average of reciprocal ranks of results for a sample of recommendation lists Q ,

$$MRR@n = \frac{1}{Q} \sum_{i=1}^Q \begin{cases} \frac{1}{\text{rank}_i}, & \text{if } \text{rank}_i \leq n \\ 0, & \text{otherwise} \end{cases}, \quad (5.11)$$

where rank_i refers to the rank position of the *relevant* item for the i -th recommendation list. If rank_i is greater than n , this recommendation scores as 0.

Both metrics are common when evaluating session-based recommendation algorithms (HIDASI *et al.*, 2016; LUDEWIG; JANNACH, 2018; JUGOVAC *et al.*, 2018).

As an additional metric, we considered *Item Coverage* ($COV@n$), which is sometimes also called “aggregate diversity” (ADOMAVICIUS; KWON, 2011). The idea here is to measure to what extent an algorithm is able to diversify the recommendations and to make a larger fraction of the item catalog visible to the users. The $COV@n$ metric is defined in Equation 5.12,

$$COV@n = \frac{|\mathbb{S}|}{|\mathbb{T}|}, \quad (5.12)$$

where \mathbb{S} is the set with distinct articles that appeared in any top- N recommendation list and \mathbb{T} is the set with all distinct *recommendable* items (JANNACH *et al.*, 2015). In our case, an item is considered *recommendable* if it has been clicked by any user in the last hour.

To measure novelty and diversity, we adapted the evaluation metrics that were pro-

posed in (VARGAS; CASTELLS, 2011; CASTELLS *et al.*, 2015; VARGAS, 2015). We provide details of their implementation in Annex B.

The novelty metrics $ESI-R@n$ and $ESI-RR@n$ are based on item popularity, returning higher values for long-tail items. The $ESI-R@n$ (Expected Self-Information with Rank-sensitivity) metric includes a rank discount, so that items in the top positions of the recommendation list have a higher effect on the metric. The $ESI-RR@n$ (Expected Self-Information with Rank- and Relevance-sensitivity) metric not only considers a rank discount, but also combines novelty with accuracy, as the relevant (clicked) item will have a higher impact on the metric if it is among the top- n recommended items. Our diversity metrics are based on the *Expected Intra-List Diversity (EILD)* metric. Analogously to the novelty metrics, there are variations to account for rank-sensitivity ($EILD-R@n$) and for both rank- and relevance-sensitivity ($EILD-RR@n$).

For our experiments, all recommender algorithms were tuned towards higher accuracy ($MRR@10$) for each dataset using random search on a hold-out validation set. The resulting best hyper-parameters are documented in Annex C.

5.3.3 Datasets

Two large news portals datasets are used for the experiments. The datasets contain recorded user interactions and information about the published articles:

- *Globo.com (G1)* dataset - Globo.com is the most popular media company in Brazil. This dataset was originally shared by us in (MOREIRA *et al.*, 2018), with a second version shared in (MOREIRA *et al.*, 2019a)³, which also includes contextual information. The dataset was collected from the G1 news portal, which has more than 80 million unique users and publishes over 100,000 new articles per month; and
- *SmartMedia Adressa dataset* - This dataset contains approximately 20 million page visits from a Norwegian news portal (GULLA *et al.*, 2017). In our experiments we used the full-version dataset, which is available upon request⁴, and includes article text and click events of about 2 million users and 13,000 articles.

Both datasets include the textual content of the news articles, article metadata (such as publishing date, category, and author), and logged user interactions (page views) with contextual information. Since we are focusing on session-based news recommendations and short-term users preferences, it is not necessary to train algorithms for long periods.

³<https://www.kaggle.com/gspmoreira/news-portal-user-interactions-by-globocom>

⁴<http://reclab.idi.ntnu.no/dataset>

Therefore, and because articles become outdated very quickly, we have selected for the experiments all available user sessions from the first 16 days for both datasets.

In a pre-processing step, like in (LUDEWIG; JANNACH, 2018; EPURE *et al.*, 2017; TWAR-DOWSKI, 2016), we organized the data into sessions using a 30 minute threshold of inactivity as an indicator of a new session. Sessions were then sorted by timestamp of their first click. From each session, we removed repeated clicks on the same article, as we are not focusing on the capability of algorithms to act as reminders as in (LERCHE *et al.*, 2016). Sessions with only one interaction are not suitable for next-click prediction and were discarded. Sessions with more than 20 interactions (stemming from *outlier* users with an unusual behavior or from bots) were truncated.

The characteristics of the resulting pre-processed datasets are shown in Table 5.4. Coincidentally, the datasets are similar in many statistics, except for the number of articles. For the *G1* dataset, the number of recommendable articles (clicked by at least one user) is much higher than for the Adressa dataset. The higher *Gini index* of the articles’ popularity distribution also indicates that the clicks in the Adressa dataset are more biased to popular articles, leading to a higher inequality in clicks distribution than for the *G1*.

TABLE 5.4 – Statistics of the datasets used for the experiments.

	<i>Globo.com (G1)</i>	<i>Adressa</i>
Language	Portuguese	Norwegian
Period (days)	16	16
# users	322,897	314,661
# sessions	1,048,594	982,210
# clicks	2,988,181	2,648,999
# articles	46,033	13,820
Avg. sessions length (# clicks / # sessions)	2.84	2.70
<i>Gini index</i> (of the article pop. distribution)	0.952	0.969

5.4 Implementation

The architecture instantiations of the *CHAMELEON* were implemented using *TensorFlow* (ABADI *et al.*, 2016), a popular and efficient numerical computation framework for deep learning. *TensorFlow* computations are described in a graph model, which may be executed onto a wide variety of different hardware platforms, including Graphics Processing Unit (GPU) cards (ABADI *et al.*, 2016).

The source code with the implementations of *CHAMELEON* and the baseline methods were published⁵ to make the experiments results reproducible.

⁵https://github.com/gabrielspmoreira/chameleon_recsys

6 Main Results and Discussion

In this chapter, we present the analysis of the main results of the experiments and discuss our findings under the perspective of our research questions.

As previously stated in Chapter 1, the experiments were designed to address the following Research Questions (RQ):

- *RQ1* - How does a contextual and hybrid RS based on the proposed neural meta-architecture perform in the news domain, in terms of recommendation quality factors (accuracy, item coverage, novelty, and diversity), compared to other traditional and state-of-the-art approaches for session-based recommendation?
- *RQ2* - What is the effect on news recommendation quality factors of leveraging different types of information in a neural-based contextual hybrid RS?
- *RQ3* - What is the effect on news recommendation quality of using different textual representations, produced by statistical NLP and Deep NLP techniques?
- *RQ4* - Is a hybrid RS based in the proposed meta-architecture able to reduce the problem of *item cold-start* in the news domain, compared to other existing approaches for session-based recommendation?
- *RQ5* - Is it possible for a neural-based RS to effectively balance the trade-off between the recommendation quality factors of *accuracy* and *novelty*?

Those questions are addressed by a number of experiments on two news portals datasets (Section 5.3.3), comparing *CHAMELEON* instantiations with baseline algorithms (Section 5.2) using the evaluation methodology proposed in Section 5.3.

For all tables presented in this Chapter, the best results for a metric are printed in bold face. If the best results are significantly different¹ from measures of all other algorithms, they are marked with *** when $p < 0.001$, with ** when $p < 0.01$, and with * symbol when $p < 0.05$.

¹As errors around the reported averages were normally distributed, we used paired Student's t-tests with Bonferroni correction for significance tests.

6.1 Evaluation of Recommendation Quality (RQ1)

In this section, it is investigated how session-based recommendation methods, including the proposed hybrid RNN-based architecture (*CHAMELEON*), perform in the news domain in terms of recommendation quality factors – accuracy, item coverage, novelty, and diversity. The accuracy analysis was initially explored in (MOREIRA *et al.*, 2018) and the final experiments, including other quality factors and more baselines, were reported in (MOREIRA *et al.*, 2019a).

At first, it is analyzed the obtained accuracy results and then it is discussed the other quality factors.

For these experiments, it was used an instantiation of *CHAMELEON*'s *NAR* module, which leverages all available information: the article Id, the article context, the article content (embeddings), the article metadata and the user context features, which are described in detail in Table 5.2.

6.1.1 Accuracy Analysis

Table 6.1 shows the accuracy results obtained from different algorithms in terms of the *HR@10* and *MRR@10* accuracy metrics. The reported values correspond to the average of measures obtained from each evaluation hour, according to the evaluation protocol described in Section 5.3.

TABLE 6.1 – The Accuracy results from *G1* and *Adressa*

<i>Algorithm</i>	G1 dataset		Adressa dataset	
	<i>HR@10</i>	<i>MRR@10</i>	<i>HR@10</i>	<i>MRR@10</i>
<i>CHAMELEON</i>	0.6738***	0.3458***	0.7018***	0.3421***
<i>SR</i>	0.5900	0.2889	0.6288	0.3022
<i>Item-kNN</i>	0.5707	0.2801	0.6179	0.2819
<i>CO</i>	0.5689	0.2626	0.6131	0.2768
<i>V-SkNN</i>	0.5467	0.2494	0.6140	0.2723
<i>SR-GNN</i>	0.5144	0.2467	0.6122	0.2991
<i>GRU4Rec</i>	0.4669	0.2092	0.4958	0.2200
<i>RP</i>	0.4577	0.1993	0.5648	0.2481
<i>CB</i>	0.3643	0.1676	0.3307	0.1253

In this comparison, *CHAMELEON* outperforms the other baseline algorithms on both datasets and on both accuracy metrics by a large margin. The *SR* method performs second-best. The *CB* is the least accurate recommendation method, as it is not influenced by articles popularity like the other methods, but solely by content similarity.

Generally, the accuracy improvement obtained by *CHAMELEON* over the best baseline method (*SR*) is higher for the *G1* dataset. This can be explained by the facts that

(a) the number of articles in the *G1* dataset is more than 3 times higher than in the other dataset and (b) the *G1* dataset has a lower popularity bias, see the *Gini index* in Table 5.4. As a result, algorithms that have a higher tendency to recommend popular items are less effective for datasets with a more balanced click distribution (i.e., a lower *Gini index*). Looking, for example, at the algorithm that simply recommends recently-popular articles (*RP*), it is possible to see that its performance is much higher for the *Adressa* dataset, even though the best obtained measures (by *CHAMELEON*) are almost similar for both datasets.

It is also possible to observe that the other neural approaches (i.e., *SR-GNN* and *GRU4Rec*) were not able to provide better accuracy than non-neural baselines for session-based news recommendation. One of the reasons might be that in a real-world scenario—as emulated in our evaluation protocol—neural-based models (including *CHAMELEON*) cannot be updated as often as the baseline methods, due to challenges of asynchronous model training and frequent deployment.

Additionally, *CHAMELEON*'s architecture was designed to be able to recommend fresh articles not seen during training. *SR-GNN* and *GRU4Rec* in contrast, cannot make recommendations for items that were not encountered during training, which limits their accuracy in a realistic evaluation. In our datasets, for example, we found that about 3% (*Adressa* dataset) and 4% (*G1* dataset) of the item clicks in each evaluation hour were on fresh articles, i.e., on articles that were not seen in the preceding training hours.

From the two neural methods, the newer graph-based *SR-GNN* method was performing much better than *GRU4Rec* in our problem setting. However, the *SR-GNN* does not achieve the accuracy of *CHAMELEON*, even when *CHAMELEON* is not leveraging any additional side information other than the article ID (configuration *IC1* in Table 6.4), as it will be presented in an *ablation study* in Section 6.2.

In Figures 6.1 and 6.2, it is plotted the obtained accuracy values (*MRR@10*) of the different algorithms along the 16 days, with an evaluation after every 5 hours. It is possible to see that, after training for some hours, *CHAMELEON* clearly recommends with higher accuracy than all other algorithms.

6.1.1.1 Analysis of Recommendation Accuracy by Session Size

Additionally, it was conducted an analysis on how the accuracy of next-article recommendation varies for latter clicks within sessions, i.e., the accuracy to predict the 2nd, 3rd, 4th, 5th, and 6th clicks. In Figure 6.3, the *HR@10* for each algorithm is segmented by session click order, and gray bars represent the average *normalized popularity* (Equation 4.7) at that session position.

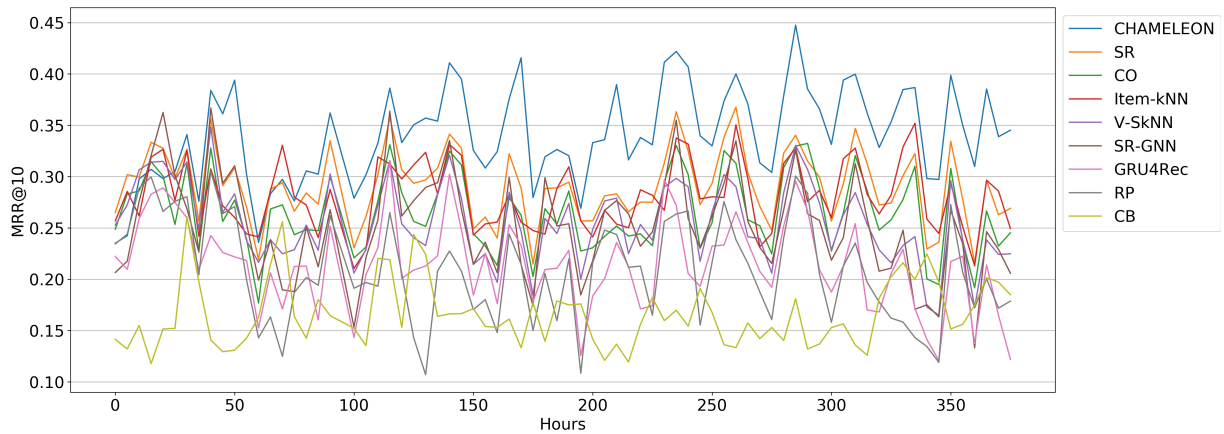
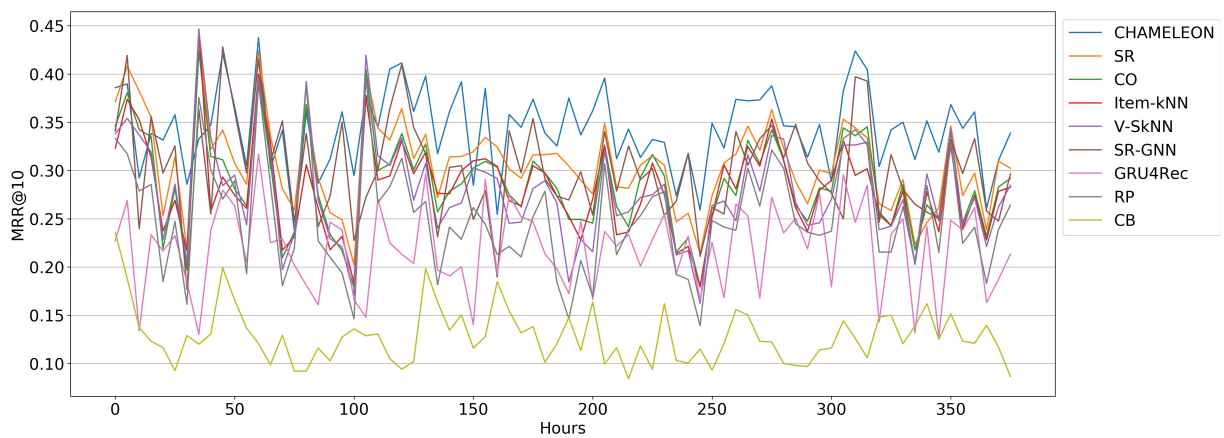
FIGURE 6.1 – *G1* dataset (16 days) - Accuracy ($MRR@10$) after every 5 hoursFIGURE 6.2 – *Adressa* dataset (16 days) - Accuracy ($MRR@10$) after every 5 hours

Interestingly, it is possible to observe for both datasets, a higher popularity-bias in first session clicks, which reduces for latter clicks. A possible explanation for that may reside on the fact that generally news portals highlight very popular articles in their homepages to attract users attention, influencing more the first clicks of users sessions.

The accuracy of the *RP* method decays almost linearly with the decrease of normalized popularity, as expected. As the *CB* method is agnostic to articles popularity, it was able to perform even slightly better for latter clicks, as users may start to browse for related content. After the *CB* method, the *CHAMELEON* ranks second in terms of lower relative decrease in accuracy, showing robustness and flexibility to leverage side-information other than popularity to provide accurate recommendations for latter session clicks.

6.1.1.2 Analysis of Accuracy Correlation

It was also analyzed the *Pearson* correlation of recommendation accuracy results across the evaluation hours of the evaluated algorithms. A high correlation between the accuracy of two methods means that they vary in the same direction, depending on the changes

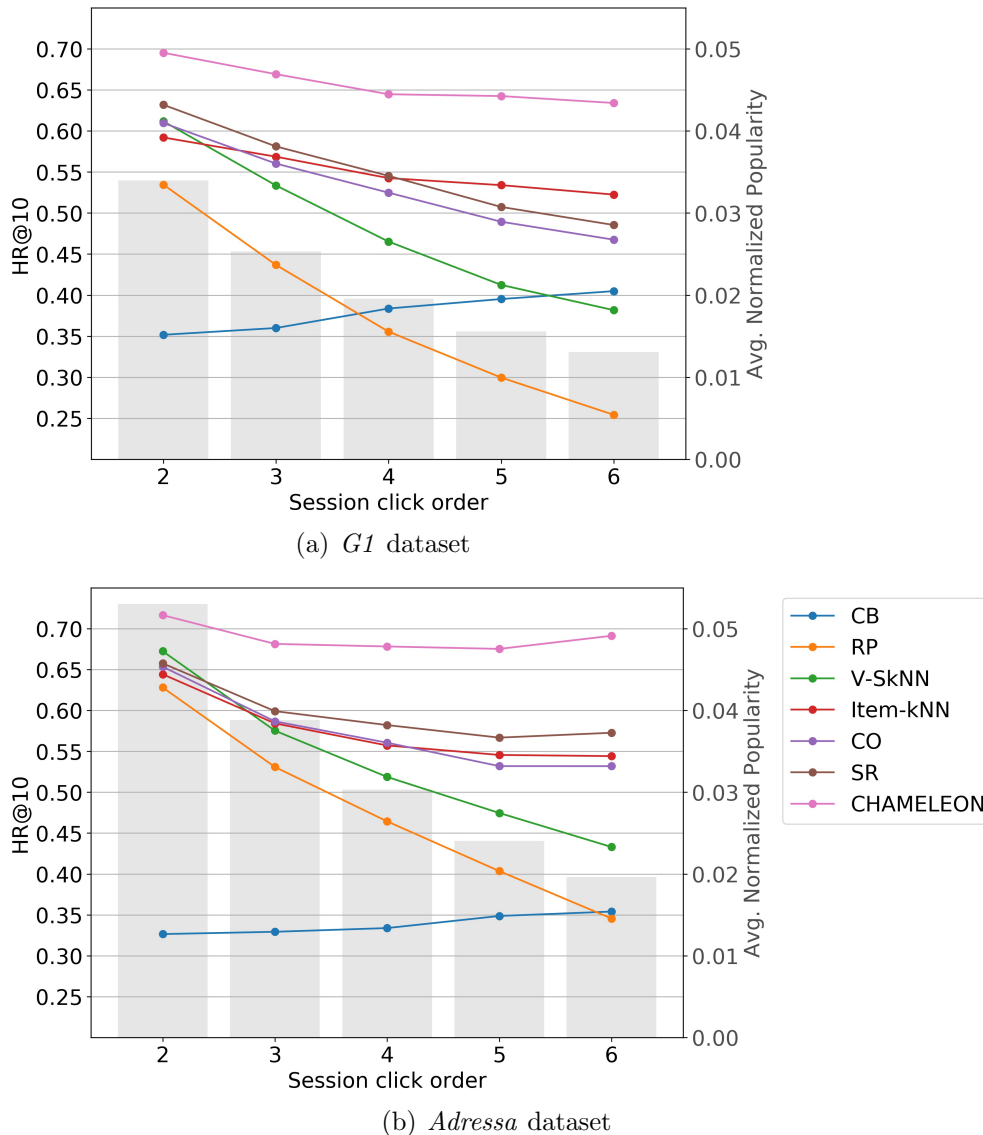

FIGURE 6.3 – The Recommendation Accuracy ($HR@10$) of algorithms (lines) x Avg. Normalized Popularity (bars) by session click order

across time of users' global behaviour (e.g., users interests focused in more popular or more niche topics).

Figure 6.4 presents a correlation matrix of algorithms' accuracy ($MRR@10$) across evaluation hours.

As expected, the *Content-Based algorithm (CB)* is the less correlated one compared to all other algorithms. It solely uses content similarity for recommendation, ignoring previous users interactions. The other baselines are well correlated, for using solely item IDs and being popularity biased.

For the *G1* dataset, the baselines with the highest correlation with *CHAMELEON* were *SR* (0.68), *CO* (0.65), and *SR-GNN* (0.55), and for the *Adressa* dataset, they were *SR-GNN* (0.74), *GRU4Rec* (0.58), and *RP* (0.57).

It is also possible to see that for the *Adressa* dataset, popularity-based algorithms have their recommendation accuracy more correlated to *RP* than in *G1* dataset. Even *CHAMELEON*'s correlation with *RP* algorithm is higher for *Adressa* (0.57) than for *G1* (0.41) dataset. This is another evidence that the *Adressa* dataset has a stronger popularity-bias compared to the *G1* dataset.

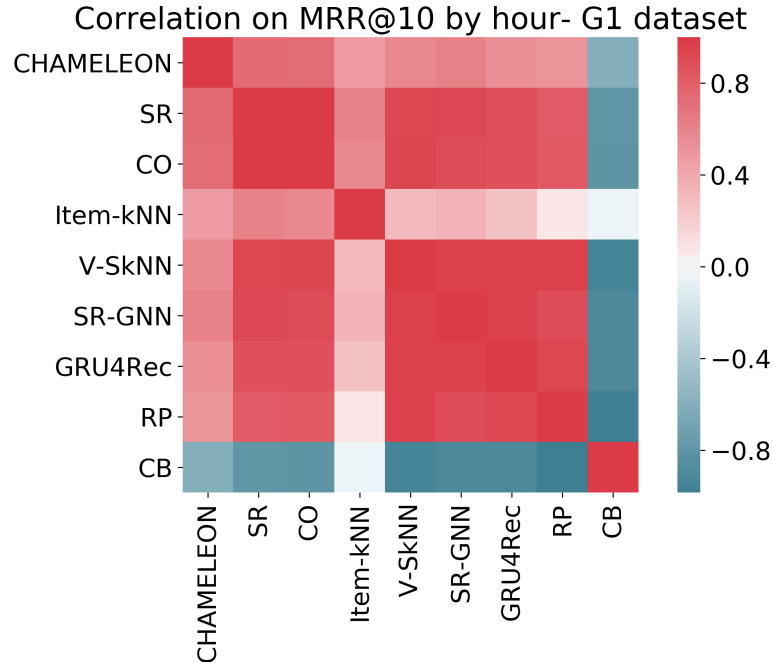
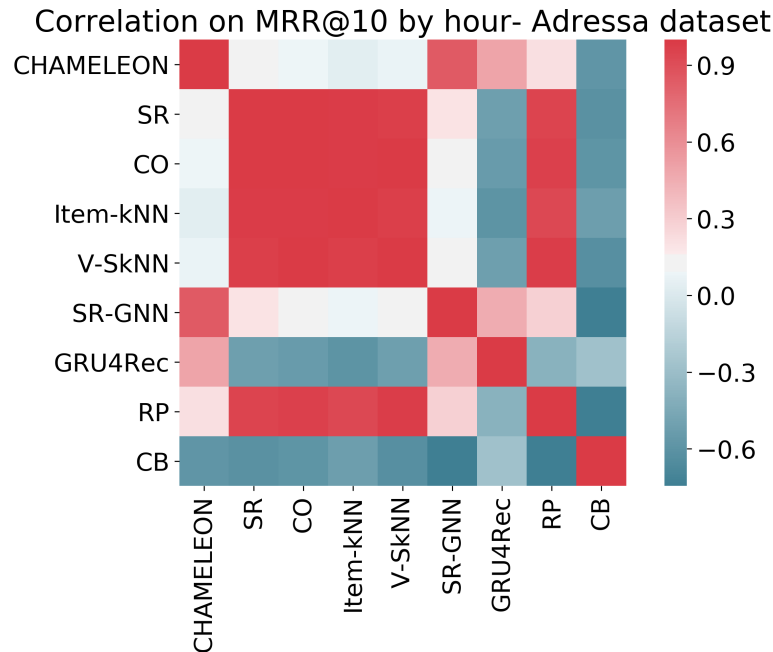
(a) *G1* dataset(b) *Adressa* datasetFIGURE 6.4 – The Correlation matrices on *MRR@10* by hour

6.1.2 Analysis of Additional Quality Factors

It was also investigated recommendation quality factors other than accuracy in our research—item coverage, novelty, and diversity. The results are shown in Table 6.2, and can be summarized as follows:

TABLE 6.2 – The evaluation of other quality factors for the *G1* and *Adressa* datasets

<i>Recommender</i>	<i>Item Coverage</i>	<i>Novelty</i>		<i>Diversity</i>	
	<i>COV@10</i>	<i>ESI-R@10</i>	<i>ESI-RR@10</i>	<i>EILD-R@10</i>	<i>EILD-RR@10</i>
G1 dataset					
<i>CHAMELEON</i>	0.6373	6.4177	0.7302***	0.3620	0.0419***
<i>SR</i>	0.2763	5.9747	0.5747	0.3526	0.0374
<i>Item-kNN</i>	0.3913	6.5909	0.6301	0.3552	0.0361
<i>CO</i>	0.2499	5.5728	0.5126	0.3570	0.0352
<i>V-SkNN</i>	0.1355	5.1760	0.4411	0.3558	0.0339
<i>SR-GNN</i>	0.3196	5.4280	0.5093	0.3668	0.0350
<i>GRU4Rec</i>	0.6333	5.2332	0.3925	0.3662	0.0310
<i>RP</i>	0.0218	4.4904	0.3259	0.3750***	0.0296
<i>CB</i>	0.6774	8.1531***	0.5488	0.2789	0.0193
Adressa dataset					
<i>CHAMELEON</i>	0.7926	5.3410	0.6083***	0.2123	0.0250***
<i>SR</i>	0.4604	5.4443	0.5277	0.2188	0.0235
<i>CO</i>	0.4220	5.0789	0.4748	0.2138	0.0222
<i>Item-kNN</i>	0.5314	5.4675	0.5091	0.2246	0.0228
<i>V-SkNN</i>	0.1997	4.6018	0.4112	0.2112	0.0217
<i>SR-GNN</i>	0.5197	5.1013	0.5125	0.2214	0.0241
<i>GRU4Rec</i>	0.5143	5.0571	0.3782	0.2131	0.0184
<i>RP</i>	0.0542	4.1465	0.3486	0.2139	0.0200
<i>CB</i>	0.8875***	7.6715***	0.4104	0.0960	0.0060

- **Item Coverage** - The *COV* metric is computed considering as *recommendable* articles the ones that have been clicked by any user in the last hour. For this metric, *CHAMELEON* has a much richer spectrum of articles that are included in its top-10 recommendations compared to other algorithms, suggesting a higher level of personalization. The only method with a higher coverage was the *CB* method, which however is not very accurate. This is expected for a method that is agnostic of article’s popularity. The *RP* method has the lowest item coverage, as expected, for recommending only the most popular articles;
- **Novelty** - The *CB* method also recommends the least popular, and thus more novel articles, according to the *ESI-R* metric. This effect has been observed in other works such as (CASTELLS *et al.*, 2015; CELMA; HERRERA, 2008), which is expected as this is the only method that does not take item popularity into account in any form. *CHAMELEON* ranks third on this metric for the *G1* dataset and is comparable to

the other algorithms for *Adressa*². Looking at novelty in isolation is, however, not sufficient, which is why it is included the relevance-weighted novelty metric (*ESI-RR*) as well. When novelty and relevance (accuracy) are combined in one metric, it turns out that *CHAMELEON* leads to the best values on both datasets; and

- **Diversity** - Most algorithms are quite similar in terms of the *EILD-R@10* metric. The *CB* method has the lowest diversity by design, as it always recommends articles with similar content. When article relevance is taken into account along with diversity with the *EILD-RR@10* metric, it is possible to see again that *CHAMELEON* is more successful than others in providing recommendations with both diversity and accuracy.

In general, it can be seen that *CHAMELEON*, besides being the most accurate recommendation method, was also able to provide the best combination of accuracy with novelty and diversity, and the second best in terms of item coverage.

6.2 Analyzing the Importance of Input Features for the *NAR* Module (RQ2)

CHAMELEON leverages a number of input features to provide more accurate recommendations. To understand the effects of including those features in our model, it was performed a number of experiments with feature sets (described previously in Table 5.2) combined in different Input Configurations (IC)³. Table 6.3 shows five different configurations where we start only with the article IDs (*IC1*) and incrementally add more features until we have the model with all input features (*IC5*).

TABLE 6.3 – *The Input Configurations (IC) for the NAR module*

Input config.	Feature Sets
<i>IC1</i>	Article Id
<i>IC2</i>	<i>IC1</i> + Article Context (Novelty and Recency)
<i>IC3</i>	<i>IC2</i> + the <i>Article Content Embeddings (ACE)</i> learned by the <i>supervised</i> instantiation of the <i>ACR</i> module, described in Section 5.1.1.1
<i>IC4</i>	<i>IC3</i> + Article Metadata
<i>IC5</i>	<i>IC4</i> + User Context

Table 6.4 shows the results of this analysis, also reported in (MOREIRA *et al.*, 2019a). In general, it can be seen that both accuracy (*HR@10* and *MRR@10*) and item coverage (*COV@10*) improve when more input features are considered in the *NAR* module. The

²it will be shown later, in Section 6.5, how the novelty of *CHAMELEON* can be increased based on the novelty regularization method proposed in Section 4.3.2.5.

³This process is sometimes referred to as *ablation study*.

largest improvements in terms of accuracy for both datasets can be observed when the *Article Content Embeddings (IC3)* are included. The feature sets of *User Context (IC5)* and *Article Context (IC2)* also played an important role when generating the recommendations.

TABLE 6.4 – The Effects of different input feature configurations on recommendation quality.

<i>Recommender</i>	<i>HR@10</i>	<i>MRR@10</i>	<i>COV@10</i>	<i>ESI-R@10</i>	<i>EILD-R@10</i>
G1 dataset					
<i>IC1</i>	0.5708	0.2674	0.6084	6.2597	0.4515
<i>IC2</i>	0.6073	0.2941	0.6095	6.1841	0.3736
<i>IC3</i>	0.6472	0.3366	0.6296	6.1507	0.3625
<i>IC4</i>	0.6483	0.3397	0.6316	6.1573	0.3621
<i>IC5</i>	0.6738***	0.3458*	0.6373	6.4177**	0.3620
Adressa dataset					
<i>IC1</i>	0.6779	0.3260	0.7716	5.3296	0.2190
<i>IC2</i>	0.6799	0.3273	0.8034	5.2636	0.2187
<i>IC3</i>	0.6906	0.3348	0.7820	5.2771	0.2103
<i>IC4</i>	0.6906	0.3362	0.7882	5.2900	0.2123
<i>IC5</i>	0.7018***	0.3421**	0.7926	5.3410	0.2123

It is also possible to observe cases where measures become lower with the addition of new features. For both datasets, for example, the diversity of *CHAMELEON*'s recommendations in terms of the *EILD-R* metric decreases with additional features, in particular when the *Article Content* features is included at *IC3*. This is expected, as recommendations become generally more similar when content features are used in a hybrid RS.

Looking at the *IC3* configuration, it can be observed that for the *G1* dataset the positive effect of textual content in recommendation accuracy is much more than for the *Adressa* dataset. A possible explanation for this difference can lie in the nature of the available metadata of the articles, which are used as target attributes during the *supervised* training of the *ACR* module. In the *G1* dataset, for example, we have 461 article categories, which is much more than for the *Adressa* dataset, with 41 categories. Furthermore, the distribution of articles by category is more unbalanced for *Adressa* (*Gini index* = 0.883) than for *G1* (*Gini index* = 0.820). In theory, fine-grained metadata can lead to content embeddings clustered around distinctive topics, which may be useful to recommend related content.

In the next section, it is explored in more detail the effect of different types of textual representation.

6.3 Analyzing the Effect of Textual Representation in Recommendations (RQ3)

In the particular domain of news recommendation, the use of hybrid techniques which consider the textual content of a news item, have often shown to be preferable to deal with item cold-start, see e.g., (CHU; PARK, 2009; LIU *et al.*, 2010; LI *et al.*, 2011; RAO *et al.*, 2013a; LIN *et al.*, 2014; LI *et al.*, 2014; TREVISIOL *et al.*, 2014; EPURE *et al.*, 2017).

In this section, as reported in (MOREIRA *et al.*, 2019b), it is investigated to what extent the choice of the mechanism for encoding articles’ textual content can affect the recommendation quality. For that, it was considered different types of textual representation, based on statistical and Deep NLP techniques, trained using *supervised* and *unsupervised* approaches.

For these experiments, it was used as basic inputs for the *NAR* module the following *feature sets* (described previously in Table 5.2) – *Article Context*, *Article Metadata*, and *User Context*. The *No-ACE* configuration uses only the basic inputs described above⁴. The other configurations add to the basic features the different textual representations presented in Table 6.5.

TABLE 6.5 – The alternative content processing techniques to generate *ACEs*.

<i>Technique</i>	<i>Input</i>	<i>Description</i>
Supervised		
<i>CNN</i>	<i>word2vec</i>	The <i>supervised</i> CNN-based instantiation of the <i>CHAMELEON</i> ’s <i>ACR</i> module described in Section 5.1.1.1.1.
<i>GRU</i>	<i>word2vec</i>	The <i>supervised</i> RNN-based instantiation of the <i>CHAMELEON</i> ’s <i>ACR</i> module described in Section 5.1.1.1.2.
Unsupervised		
<i>SDA-GRU</i>	Raw text	The <i>unsupervised</i> instantiation of the <i>ACR</i> module, based on Sequence Denoising <i>GRU</i> Autoencoders, as described in Section 5.1.1.2
<i>LSA</i>	Raw text	Traditional Latent Semantic Analysis (LSA) (DEERWESTER <i>et al.</i> , 1990). We used a variation based on <i>TF-IDF</i> vectors (RAMOS <i>et al.</i> , 2003) and <i>Truncated SVD</i> (HALKO <i>et al.</i> , 2011).
<i>W2V*TF-IDF</i>	<i>word2vec</i>	<i>TF-IDF</i> weighted <i>word2vec</i> (LILLEBERG <i>et al.</i> , 2015), a technique to represent a piece of text as the average of its word embeddings weighted by <i>TF-IDF</i> (RAMOS <i>et al.</i> , 2003).
<i>doc2vec</i>	Raw text	Paragraph Vector (a.k.a <i>doc2vec</i>) (LE; MIKOLOV, 2014) learns fixed-length feature representations from variable-length pieces of texts, which are trained via the distributed memory and distributed bag of words models.

Regarding to the content preprocessing, as there were some very long articles, the text was truncated after the first 12 sentences, and concatenated with the title. The *Article Content Embeddings (ACE)* produced by the selected techniques were *L2*-normalized to

⁴The *Article Id* trainable embedding was not used as input for these experiments, for a better sensitivity of the effect of different content representations on recommendation quality.

make the feature scale similar, but also to preserve high similarity scores for embeddings from similar articles.

The experiments consisted of training *NAR* module of *CHAMELEON* using the *ACE* produced by those different techniques for content representations and evaluating the provided recommendations. The results for the *G1* and *Adressa* datasets are presented in Tables 6.6 and 6.7 ⁵.

TABLE 6.6 – The Results for the *G1* dataset, with *CHAMELEON* using different *ACEs*.

<i>Recommender</i>	<i>HR@10</i>	<i>MRR@10</i>	<i>COV@10</i>	<i>ESI-R@10</i>
<i>No-ACE</i>	0.6281	0.3066	0.6429	6.3169
<i>Supervised</i>				
<i>CNN</i>	0.6585	0.3395	0.6493	6.2874
<i>GRU</i>	0.6585	0.3388	0.6484	6.2674
<i>Unsupervised</i>				
<i>SDA-GRU</i>	0.6418	0.3160	0.6481	6.4145
<i>W2V*TF-IDF</i>	0.6575	0.3291	0.6500	6.4187
<i>LSA</i>	0.6686***	0.3423	0.6452	6.3833
<i>doc2vec</i>	0.6368	0.3119	0.6431	6.4345

TABLE 6.7 – The Results for the *Adressa* dataset, with *CHAMELEON* using different *ACEs*.

<i>Recommender</i>	<i>HR@10</i>	<i>MRR@10</i>	<i>COV@10</i>	<i>ESI-R@10</i>
<i>No-ACE</i>	0.6816	0.3252	0.8185	5.2453
<i>Supervised</i>				
<i>CNN</i>	0.6860	0.3333	0.8103	5.2924
<i>GRU</i>	0.6856	0.3327	0.8096	5.2861
<i>Unsupervised</i>				
<i>SDA-GRU</i>	0.6905	0.3360	0.8049	5.3170
<i>W2V*TF-IDF</i>	0.6913	0.3402	0.7976	5.3273
<i>LSA</i>	0.6935	0.3403	0.8013	5.3347
<i>doc2vec</i>	0.6898	0.3402	0.7968	5.3417

In general, we can observe that considering content information is in fact highly beneficial in terms of recommendation accuracy. It is also possible to see that the choice of the article representation matters.

Surprisingly, the long-established *LSA* method was the best performing technique to represent the content for both datasets in terms of accuracy, even when compared to more recent techniques using pre-trained word embeddings, such as the *CNN* and *GRU*.

For the *G1* dataset, the *Hit Rates* (*HR*) were improved by around 7% and the *MRR* by almost 12% when using the *LSA* representation instead of the *No-ACE* setting. For

⁵Results for the diversity metrics are not reported for been meaningless for this comparison of different *ACE*, because the diversity metrics are computed based on *ACE* similarities.

the *Adressa* dataset, the difference between the *No-ACE* settings and the hybrid methods leveraging text are less pronounced. The improvement using *LSA* compared to the *No-ACE setting* was around 2% for *HR* and 5% for *MRR*.

Furthermore, for the *Adressa* dataset, it is possible to observe that all the *unsupervised* methods (*SDA-GRU*, *LSA*, *W2V*TF-IDF*, and *doc2vec*) for generating *ACEs* performed better than the *supervised* ones, differently from the *G1* dataset. A possible explanation can be that the *supervised* methods depend more on the *quality* and *depth* of the available article metadata information used as the target for the training.

In terms of coverage (*COV@10*) and novelty(*ESI-R@10*), it turns out that for the *G1* dataset, using some content representations can lead to slightly higher values compared to the *No-ACE* settings and to the unsupervised approaches.

6.4 Reducing the Item Cold-Start Problem for News Recommendation (RQ4)

The news domain is one of the recommendation scenarios where the item cold-start problem is more intense, as thousands of articles are published every day in a large news portal (SPANGHER, 2015), and they become obsolete in just a few hours (DAS *et al.*, 2007). If an algorithm takes too long to learn which users might be interested in a fresh article, such content might not be relevant for the majority of users anymore when it finally starts to get recommended.

In this section, it is investigated whether the proposed hybrid RNN-based architecture (*CHAMELEON*) is able to reduce the problem of item cold-start in the news domain, compared to existing approaches for session-based recommendation.

For that, it was designed and performed experiments to measure how long does it take since the article became available (first user click) until an algorithm recommends that article among the top-N items for the first time.

In our training and evaluation protocol, the recommender algorithms are processed by *mini-batches* of user sessions. In this sense, it is highly desirable that an algorithm starts recommending a fresh item after observing just a few user sessions (i.e., a low number of *batches*).

For these experiments, the item cold-start problem is measured here as the number of *training batches* between the first user click in the article and its first top-N recommendation by a given algorithm. For that, it is proposed the metric *# Batches before First*

Recommendation ($BFR@n$):

$$BFR@n(a) = \text{frb}@n(a) - \text{fcb}(a), \quad (6.1)$$

where $\text{fcb}(a)$ is the sequential number of the batch where the article a was clicked by any user for the first time (a *proxy* for article’s publishing time), and $\text{frb}@n(a)$ is the sequential number of the batch with the first top- n recommendation containing the article a , provided by a recommender algorithm.

For these experiments, it was used a subset of the *G1* and *Adressa* datasets, considering the first 9 days of user interactions. The metric $BFR@n$ was computed for all investigated session-based recommenders, using a *batch size* of **64 samples** for both datasets.

In Tables 6.8 and 6.9, it is possible to observe statistics of the distribution of the $BFR@n$ measures for each dataset and algorithm. For example, the 75% percentile column means that 75% of the first articles’ recommendation required at most that number of *training batches* to be recommended, since the article was published.

TABLE 6.8 – The analysis of the item cold-start problem by algorithm for the *G1* dataset

Algorithm	Statistics of the $BFR@n$ measures											Global Item Coverage (%)
	Min.	1%	10%	25%	50%	75%	90%	99%	Max.	Mean.	Std.	
<i>CHAMELEON</i>	0	0	0	0	0	19	57	3146	9704	102	629	0.927
<i>CB</i>	0	0	0	0	0	11	36	409	8872	35	315	0.962
<i>Item-kNN</i>	1	1	8	27	95	455	1859	7053	9869	627	1353	0.354
<i>V-SkNN</i>	1	1	18	68	289	828	2205	6643	9180	777	1291	0.175
<i>SR</i>	1	1	22	79	286	842	2455	7510	9869	856	1471	0.247
<i>CO</i>	1	1	33	116	379	1019	2864	7467	9869	977	1527	0.239
<i>RP</i>	1	1	142	646	1722	3197	4921	7523	8980	2125	1847	0.023

TABLE 6.9 – The analysis of the item cold-start problem by algorithm for *Adressa* dataset

Algorithm	Statistics of the $BFR@n$ measures											Global Item Coverage (%)
	Min.	1%	10%	25%	50%	75%	90%	99%	Max.	Mean.	Std.	
<i>CHAMELEON</i>	0	0	0	0	0	14	41	2177	8087	69	448	0.950
<i>CB</i>	0	0	0	0	0	7	19	64	7355	14	169	0.987
<i>Item-kNN</i>	1	1	3	10	62	1408	4068	7318	8600	1087	1812	0.324
<i>V-SkNN</i>	1	1	6	16	48	887	4057	7869	8804	955	1832	0.148
<i>SR</i>	1	1	6	21	231	1913	4632	7591	8625	1331	1961	0.232
<i>CO</i>	1	1	8	29	340	2366	4664	7482	8803	1451	1994	0.229
<i>RP</i>	1	1	13	30	53	96	219	2483	8204	151	540	0.040

As an exercise to simulate how the number of batches translates to time, it is possible to use the average number of sessions being clicked every minute for the datasets: **48 sessions/minute** for *G1* dataset and **44 sessions/minute** for *Adressa* dataset ⁶. For example, if *CHAMELEON* has shown a $BFR@n = 19$ at the 75% percentile, that means that for 75% of the articles it would require less than **25 minutes** ((19 batches \times

⁶In practice, the number of user sessions is much lower during dawn (12pm to 6am).

64 sessions (batch_size))/48 (sessions/minute)) to provide their first top-N recommendation after articles get published.

The column *Global Item Coverage (%)* for these tables is computed by the $COV@n$ metric (Equation 5.12), but considering as *recommendable* all previously clicked items and not only the articles clicked in the last hour, like in the experiments reported in Section 6.1.2.

For both datasets, the *CB* is the most resilient algorithm against the item cold-start problem. This algorithm, by design, can recommend an article immediately after being published, because it does not consider user behaviour for recommending, but only the articles content similarity. It has shown $BFR@n = 11$ for *G1* and $BFR@n = 7$ for *Adressa* dataset, at the 75% percentile.

The *CHAMELEON* recommender follows *CB* closely in terms of effectively combating the item cold-start problem – $BFR@n = 19$ for *G1* and $BFR@n = 14$ for *Adressa*, at the 75% percentile) – but with a much higher accuracy than *CB*, as seen in Section 6.1.1.

Additionally, at the 50% percentile, it is noticeable that both *CHAMELEON* and *CB* are able to start immediately recommending a fresh article when processing the batch where it was clicked for the first time by any user ($BFR@n = 0$).

The other algorithms are more popularity-biased and suffer with the item cold-start problem. Their $BFR@n$ measures are much higher and their *Global Item Coverage* much lower than *CHAMELEON* and *CB*.

It is also interesting to observe that, for the *G1* dataset, the *RP* is the worse algorithm in terms of the item cold-start problem. Although, for the *Adressa* dataset, the *RP* is the third best one (after *CB* and *CHAMELEON*), another indicative of that users clicks in *Adressa* news portal are more popularity-biased.

In Figures 6.5 and 6.6, it is possible to observe the temporal evolution of the item cold-start problem for the session-based algorithms measured as the $BFR@n$ metric at the 75% percentile. In general, for most algorithms, the item cold-start problem worsens as time goes and the item catalog increases. The only methods that are robust against that problem over time are the *CB* and *CHAMELEON*. For the *Adressa* dataset, the item cold-start problem also stabilizes at some point for the *RP* algorithm, but a much higher level.

With these experiments, it is possible to conclude that the proposed hybrid RNN-based architecture – *CHAMELEON* (*NAR* module) – is able to effectively combat the item cold-start problem much better than the other algorithms, and similarly to the *CB* algorithm, but with a much higher accuracy.

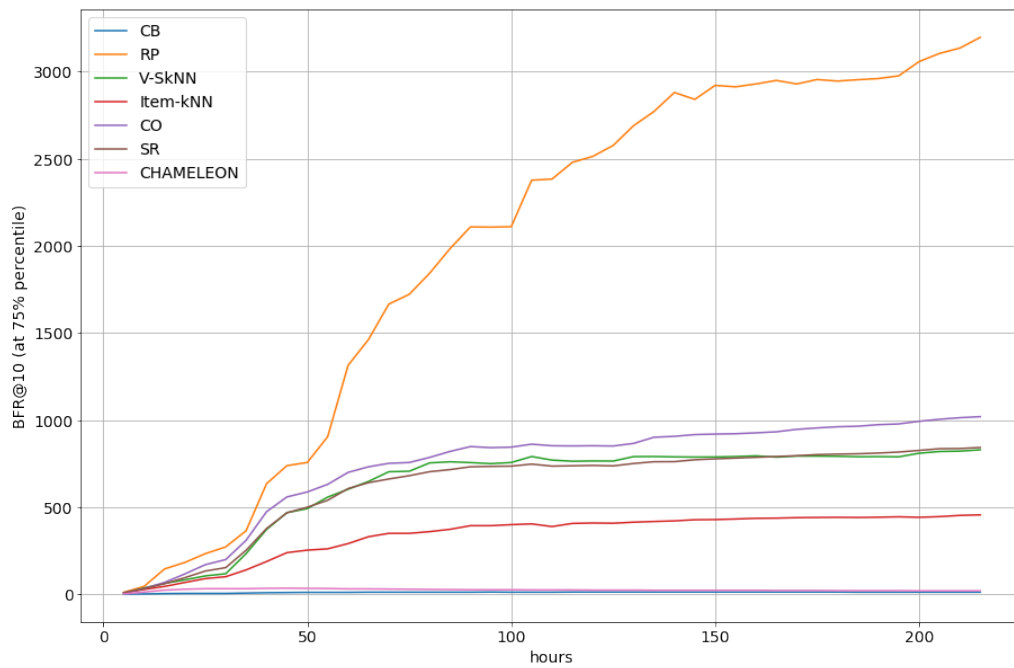

FIGURE 6.5 – *G1* dataset (9 days) - Evolution over time of the $BFR@10$ at 75% percentile of the recommendation algorithms

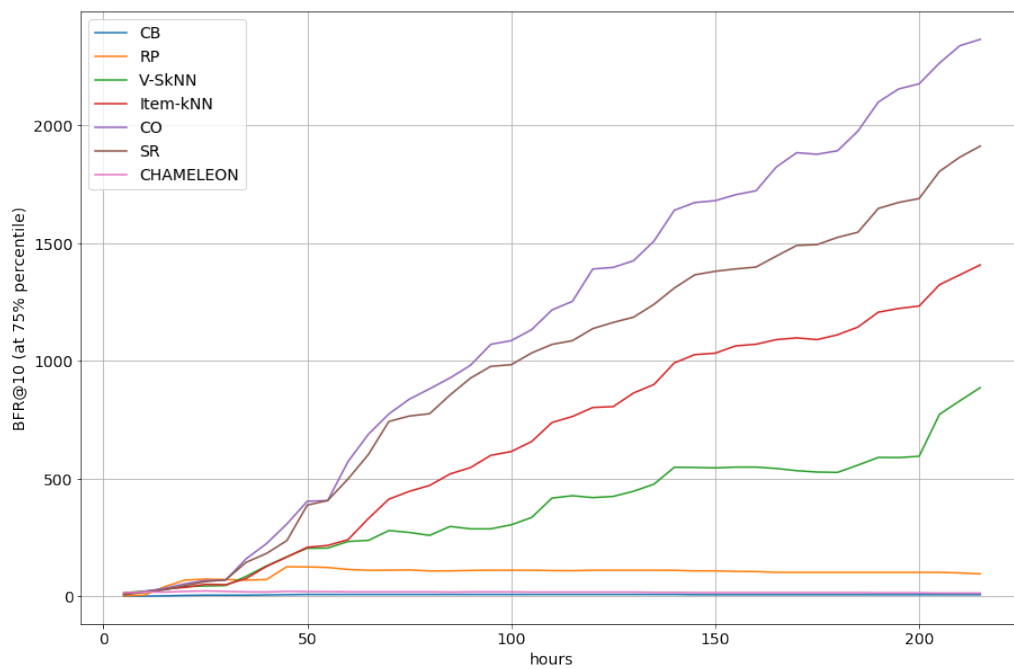

FIGURE 6.6 – *Adressa* dataset (9 days) - Evolution over time of the $BFR@10$ at 75% percentile of the recommendation algorithms

6.5 Balancing Accuracy and Novelty with *CHAMELEON* (RQ5)

As previously discussed in Section 4.4.4, it is very important to be able to provide recommendations of long-tail items and not only the most popular ones, in special in the news domain. Therefore, there is a trade-off between accuracy and novelty, as recommending popular items have usually a higher chance to match the interests of most users.

In this section, as reported in (MOREIRA *et al.*, 2019a), it is analyzed the effectiveness of our proposed approach to balance accuracy and novelty within *CHAMELEON*, as described in Section 4.3.2.5. Specifically, it was conducted a sensitivity analysis for the novelty regularization factor (β) in the proposed loss function, presented in Table 6.10.

TABLE 6.10 – The evaluation of *CHAMELEON*’s loss regularization factor for novelty (β)

<i>Reg. factors</i>	<i>ESI-R@10</i>	<i>MRR@10</i>	<i>COV@10</i>
G1 dataset			
$\beta = 0.0$	6.4177	0.3458	0.6373
$\beta = 0.1$	6.9499	0.3401	0.6785
$\beta = 0.2$	7.7012	0.3222	0.6962
$\beta = 0.3$	8.5763	0.2933	0.7083
$\beta = 0.4$	9.3054	0.2507	0.7105
$\beta = 0.5$	9.8012	0.2170	0.7123*
Adressa dataset			
$\beta = 0.0$	5.3410	0.3421	0.7926
$\beta = 0.1$	5.8279	0.3350	0.8635
$\beta = 0.2$	7.5561	0.2948	0.9237
$\beta = 0.3$	9.4709	0.2082	0.9353
$\beta = 0.4$	10.2500	0.1560	0.9376
$\beta = 0.5$	10.5184	0.1348	0.9365

As expected, increasing the value of β increases the novelty of the recommendations and also leads to higher item coverage. Correspondingly, the accuracy values decrease with higher levels of novelty. Figure 6.7 shows a scatter plot that illustrates some effects and contrasts of the obtained results in our evaluation. The trade-off between accuracy (*MRR@10*) and novelty (*ESI-R@10*) for *CHAMELEON* can be clearly identified. We also plot the results for the baseline methods there for reference. This comparison reveals that tuning β helps us to end up with recommendations that are both more accurate and more novel than the ones by the baselines.

With the proposed approach to balance accuracy and novelty within *CHAMELEON*, an administrator of a news portal have the possibility to tune the desired level of nov-

elty (β) and be assured that the negative effect on recommendation accuracy will be as minimum as possible, provided that the model is trained to optimize for both quality factors.

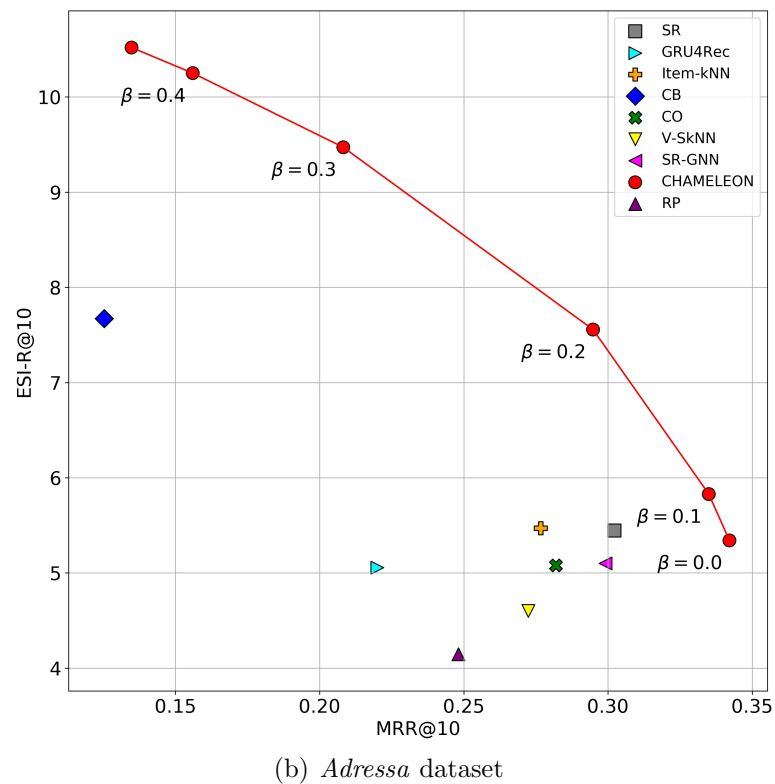
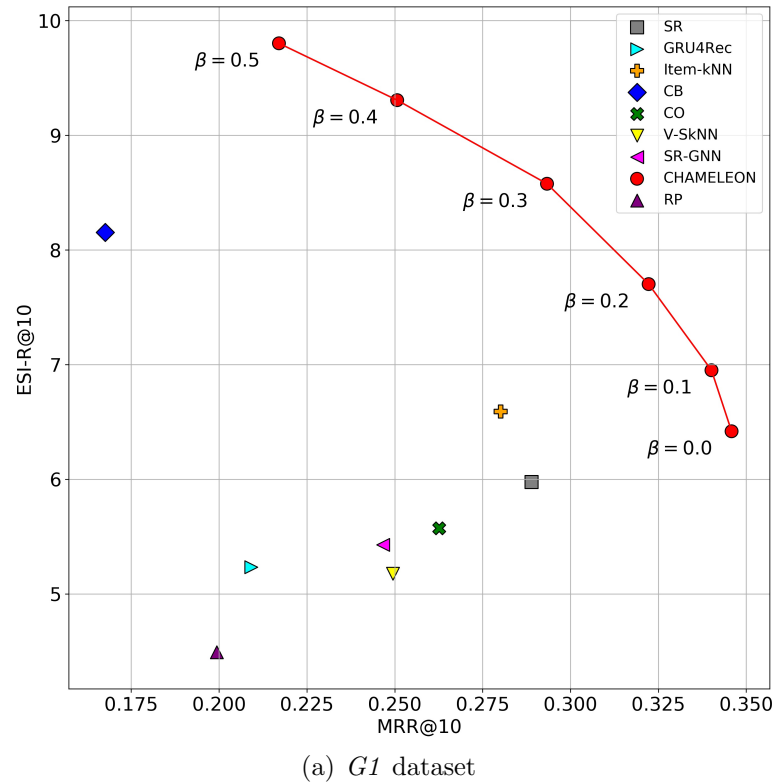

FIGURE 6.7 – The trade-off between Accuracy (MRR@10) and Novelty (ESI-R) for different values of β .

7 Conclusion

In this chapter, this research is briefly summarized and it is provided recommendations and suggestions for future works in this area.

First of all, a survey on news recommendation reported in Chapter 2 was conducted to identify the key challenges of news recommendation such as the fast flow of incoming articles and the very short lifetime of the recommended items. In general, most users are anonymous, so that the recommendations cannot be based on long-term preference profiles as in other domains.

Based in this survey, it was proposed a conceptual model of the factors that affect the news relevance for user, involving: the article context (popularity, recency); the user context (e.g. time, location, device, referrer); users' short- and long-term interests; and global factors (popular topics, seasonality, and breaking events).

In Chapter 3, it was investigated the state-of-art on Deep Learning methods and techniques applied to Recommender Systems. In a special, the main inspirations for this work were: (1) session-based recommendation with RNNs (HIDASI *et al.*, 2016); (2) scalable recommendations based on *multi-view* learning models (HUANG *et al.*, 2013; ELKAHKY *et al.*, 2015); (3) textual feature extraction using Deep Learning (BANSAL *et al.*, 2016; TUAN; PHUONG, 2017); and (4) deep learning architectures for news recommendation (SONG *et al.*, 2016; KUMAR *et al.*, 2017a).

The main objective of this research was to propose a Deep Learning meta-architecture – the *CHAMELEON* – designed to tackle the specific challenges of news recommendation and improve the recommendation quality of news portals.

The *CHAMELEON* meta-architecture (MOREIRA, 2018), described in Chapter 4, consists of a modular reference neural architecture, designed to tackle specific challenges of the news recommendation domain, in special: a) the short lifetime of the recommendable items; and b) the lack of longer-term preference profiles of users.

The main technical contribution of *CHAMELEON* lies in an effective combination of *content* and *contextual* features and a sequence modeling technique based on Recurrent Neural Networks for higher-quality session-based news recommendation.

In Chapter 5, it was proposed different instantiations of *CHAMELEON*'s *ACR* and *NAR* modules as concrete neural architectures, inspired on the state-of-art research on Deep Learning and Recommender Systems.

A temporal offline evaluation method was also proposed to address the dynamics of news readership, where articles context (recent popularity and recency) is constantly changing. Baseline recommender methods were continuously trained on streaming user clicks and the *CHAMELEON* was trained once an hour to emulate a scheduled model deployment in a production environment.

It was also proposed some adaptations on rank- and relevance-sensitive *novelty* and *diversity* metrics from (VARGAS; CASTELLS, 2011; VARGAS, 2015), which are described in Annex B.

The proposed *CHAMELEON* architecture instantiations and the selected baseline session-based recommenders were implemented for this research. A comprehensive number of experiments were performed in datasets from two real-words news portals – *Globo.com* (*G1*) and *Adressa* – to answer the stated *research questions*.

The experiments results, presented in Chapter 6, have demonstrated the effectiveness of the proposed approach for news recommendation (*CHAMELEON*) in the quality of recommendation.

The accuracy, item coverage, and novelty obtained by *CHAMELEON* were much higher than by the baseline algorithms (*RQ1*) (MOREIRA *et al.*, 2018; MOREIRA *et al.*, 2019a). It was also analyzed the effect of session sizes in the recommendation accuracy and the correlation of accuracy results among the algorithms.

It was also investigated the effect on recommendation quality of different sets of information for contextual and hybrid recommendations (*RQ2*) (MOREIRA *et al.*, 2019a). The results showed that each of the proposed features (e.g., articles popularity and recency, article content embeddings, user context) adds predictive power and helps a hybrid news recommender system to provide better recommendations.

The effect of different textual representations on news recommendation quality was also investigated (*RQ3*) (MOREIRA *et al.*, 2019b). It was possible to observe that article's textual content really improves the accuracy in a hybrid recommendation approach, in special for news portals with less popularity-bias, i.e., *G1*. Therefore, there is a small difference on the results obtained with a number of different statistical and deep learning techniques to represent textual content, which was a somewhat surprising result.

It was also analyzed the effects of the intense item cold-start problem in the news domain (*RQ4*). It was shown that popularity-biased algorithms suffer more from that problem, whereas the algorithms leveraging articles' content – *CB* and *CHAMELEON* –

showed to be much robust against the item cold-start problem.

Finally, it was evaluated our proposal to balance the competing *accuracy* and *novelty* recommendation quality factors through a parameterizable multi-task loss function, in the context of news session-based recommendations using neural networks (*RQ5*) (MOREIRA *et al.*, 2019a). A sensitivity analysis revealed that our approach is effective and can lead to recommendations that are both more novel and more accurate than the recommendations of the other algorithms in our comparison.

After the design, implementation, execution, and analysis of experiments with real world news portals datasets, it was possible to conclude that the proposed Deep Learning Meta-Architecture for News Recommendation – the *CHAMELEON* – was able to effectively surpass the recommendation quality of the other session-based algorithms in many aspects: accuracy, item coverage, novelty, and robustness against the item cold-start problem.

7.1 Contributions

In summary, the main contribution of this research work was the proposal of a Deep Learning meta-architecture – the *CHAMELEON* – designed to tackle the specific challenges of news recommendation.

Some complementary contributions of this research work were:

1. The elaboration of a conceptual model of factors that affect the relevance of news articles, based on an extensive survey on news recommender systems;
2. The instantiation of *CHAMELEON*'s *ACR* and *NAR* modules as four concrete architectures, which were used in the experiments to answer the stated research questions;
3. The implementation of the architecture instantiations of *CHAMELEON* and of the baseline methods, which were open-sourced for the reproducibility of the experiments and for supporting advances in this research line ¹;
4. A temporal offline evaluation of news recommender algorithms, to emulate a real-world scenario of continuously training a neural model with streaming user clicks and deploying a new trained model once an hour, to provide recommendations for upcoming user sessions; and
5. The adaptation of rank- and relevance-sensitive *novelty* and *diversity* metrics, originally proposed by (VARGAS; CASTELLS, 2011; VARGAS, 2015).

¹https://github.com/gabrielspmoreira/chameleon_recsys

Furthermore, one additional contribution of this research work was the preparation and sharing of two novel datasets for evaluation of hybrid recommender systems for news (*Globo.com (G1)*²) and articles (*CI&T Deskdrop*³).

7.2 Recommendations

It is recommended some extensions of this research to investigate the following aspects of news recommendation:

- To perform online evaluation (A/B tests) of *CHAMELEON* in a live news portal, to assess its performance and recommendation quality in a production scenario;
- To explore mechanisms to balance more than two quality factors, with a particular look at enhancing the diversity of the recommendations while preserving accuracy;
- To support session-aware recommendations, in which information from past user sessions is used to model his long-term interests. Some interesting starting points are the research from (QUADRANA *et al.*, 2017) and (RUOCCO *et al.*, 2017), which uses hierarchical RNNs to model both the sequences of user sessions and sequences of clicks within sessions;
- To explore different approaches to sample negative items for recommendation training, as stronger negative samples tends to force the network to capture subtle patterns for more accurate recommendations. One idea would be to sample recent and popular articles at the current geographic region of the user. Other inspirations on negative sampling for session-based recommendation can be found in (HIDASI; KARATZOGLOU, 2018); and
- To explore other recent Deep NLP techniques to produce better article content embeddings (e.g., *Transformers*, *BERT*) for hybrid recommendation.

7.3 Suggestions for Future Works

It is suggested the instantiation of *CHAMELEON*'s *NAR* module with neural network architectures different than RNNs to model the sequence of user interactions, such as CNNs, *Quasi-Recurrent Neural Network (QRNN)* (BRADBURY *et al.*, 2016), attention mechanisms (LI *et al.*, 2017) (LIU *et al.*, 2018), and graph neural networks (WU *et al.*, 2019).

²<https://www.kaggle.com/gspmoreira/news-portal-user-interactions-by-globocom>

³<https://www.kaggle.com/gspmoreira/articles-sharing-reading-from-cit-deskdrop>

Regarding attention mechanism, it is suggested their investigation as an interesting alternatives to provide recommendations explanation, as pointed out also in (ZHANG *et al.*, 2019). Explainable deep learning is important both for users, allowing them to understand the factors behind the network’s recommendations (SEO *et al.*, 2017; XIAO *et al.*, 2017), and also for practitioners, probing weights and activations to understand more about the model (SEO *et al.*, 2017; XIAO *et al.*, 2017; TAY *et al.*, 2018).

An specific challenge not particularly addressed in this research, which was not investigated to a large extent in the literature as well is that of “outliers” in the user profiles. Specifically, there might be a certain level of noise in the user profiles. In the case of news recommendation, this could be random clicks by the user or user actions that result from a click-bait rather than from genuine user interest. As proposed in previous works (SAIA *et al.*, 2016; SAID; BELLOGÍN, 2018; SAIA *et al.*, 2014), it is suggested an investigation to identify such outliers and noise in the context of session-based news recommendation to end up with a better estimate of the true user intent within a session.

It is also suggested the adaptation of *CHAMELEON* to provide contextual and hybrid session-based recommendations in other domains like e-commerce, entertainment, and media.

Annex A - The ACR Module - Training of the Supervised and Unsupervised instantiations

In this Annex, it is presented the methods for training two instantiations of the *ACR* module architecture: (1) *supervised* and (2) *unsupervised*.

The *supervised* architecture trains the *Article Content Embeddings (ACE)* to classify article's metadata attributes (e.g., category) from its textual content. This architecture depends on human-labeled articles metadata to train the *ACE*, such as the categories that are usually defined by editors of news portals.

The *unsupervised* architecture trains the *ACEs* as a Sequence Autoencoder, which encodes the input text as the *ACE* and reconstructs the original text from that representation. This method depends solely on articles' text and no other metadata.

In both cases, the *ACR* module is trained to optimize a loss function on a mini-batch of news articles. After training, the learned *ACEs* are persisted in a repository, for further usage by the *NAR* module.

A.1 The Supervised ACR Module Training Method

The *supervised* variation of the *ACR* module is trained according to the following steps:

1. The *TFR* sub-module extracts features from its input text (using a *CNN* or *RNN*-based architecture) and generates an Article Content Embedding (*ACE*) based on its inputs: the article's textual content, represented as a sequence of word embeddings; and
2. The *CET* sub-module trains the *ACE* to classify articles metadata attributes.

For inference of the *ACE* of newly published articles, only step 1 is necessary.

Articles metadata attributes may have a single label for each instance (e.g., categories) or multiple labels, when there is more than one value for an attribute (e.g., tags, entities).

For single-label classification, it is used the *softmax* function to normalize the output layer as a probability distribution that sums up to one, as follows:

$$\hat{y}_i = \sigma(x_j) = \frac{e^{x_j}}{\sum_i e^{x_i}}. \quad (\text{A.1})$$

Cross-entropy log loss is used for optimization, as follows

$$l(\theta) = -\frac{1}{N} \left(\sum_{i=1}^N y_i \cdot \log(\hat{y}_i) \right) + \lambda \|\theta\|, \quad (\text{A.2})$$

where y is a vector with the one-hot encoded label for each instance, \hat{y} is the vector with the output probabilities for each class, previously normalized by *softmax*, θ represents model parameters to be learned, and λ controls the importance of the regularization term, to avoid overfitting.

For multi-label classification, the *sigmoid* function (Equation A.3) is used instead of softmax, because in that case classes probabilities should be independent from each other:

$$s(x) = \frac{1}{1 + e^{-x}} \quad (\text{A.3})$$

When more than one article metadata attribute is available for classification (e.g. categories, tags, and entities), it is possible to use *Multi-Task Learning (MTL)*.

The *MTL* is typically done with either hard or soft parameter sharing of hidden layers. Hard parameter sharing is the most commonly used approach to *MTL* in neural networks and goes back to (CARUNA, 1993). It is generally applied by sharing hidden layers for all tasks, while keeping task-specific output layers (RUDER, 2017), like represented in Figure A.1.

By sharing representations between related tasks, the model may generalize better, as can be seen in successful MTL applications in NLP (COLLOBERT; WESTON, 2008), speech recognition (DENG *et al.*, 2013), computer vision (GIRSHICK, 2015), and recommender systems (BANSAL *et al.*, 2016).

The *MTL* is usually trained by following one of these strategies: (1) alternate optimization step of each task's parameters, or (2) summing up losses for each classification task in a single optimization step.

In the *ACR* module, strategy (2) was chosen, as it is usually recommended when you have a single dataset with multiple labels, like in a news articles domain.

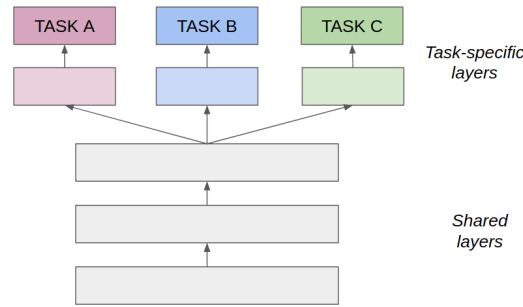
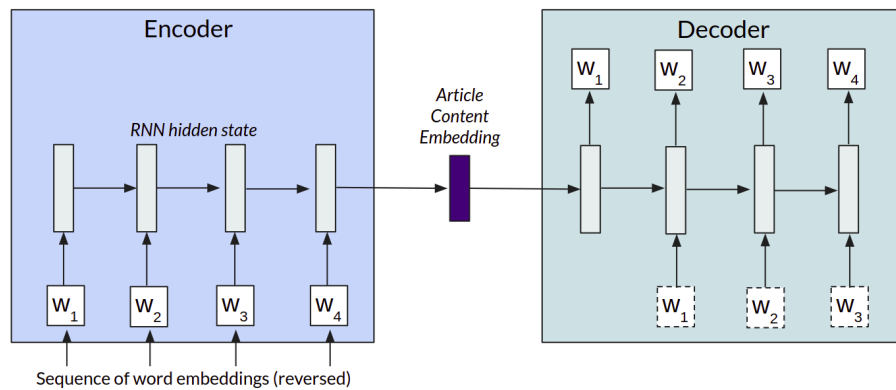

FIGURE A.1 – An illustration of a Multi-Task Learning architecture

A.2 The Unsupervised ACR Module Training Method

It is also proposed an *unsupervised* instantiation of the *ACR* module as an adaptation of the Sequence Autoencoder (DAI; LE, 2015; SRIVASTAVA *et al.*, 2015). In such Encoder-Decoder RNN-based architecture, the article text is encoded to generate a compressed representation and decoded to reconstruct the original input text.

For the *ACR* module, the *TFR* and *CET* sub-modules are the *encoder* and *decoder*, respectively, as illustrated in Figure A.2. They can be instantiated as an RNN-based architecture, such as the Gated Recurrent Units (GRU) (CHO *et al.*, 2014a; CHUNG *et al.*, 2014).

FIGURE A.2 – An illustration of a *Sequence Autoencoder*, adapted from (SRIVASTAVA *et al.*, 2015)

The training method for the *unsupervised* instantiation of the *ACR* module works as follows:

1. The *TFR* sub-module (*encoder*) compressed the input text, represented as a sequence of word embeddings, into an Article Content Embedding (*ACE*); and
2. The *CET* sub-module (*decoder*) have its RNNs hidden state initialized with a non-linear projection of the *ACE* produced by the *encoder* and tries to reconstruct the original input text word-by-word, represented as word embeddings.

This *unsupervised* instantiation of the *ACR* module is trained to minimize the *Mean Squared Error (MSE)* between the sequence of predicted words \hat{w}_i and correct words w_i , represented by their embeddings, as shown in Equation A.4.

$$MSE = \frac{1}{n} \sum_{i=1}^n (w_i - \hat{w}_i)^2 \quad (\text{A.4})$$

Annex B - Novelty and Diversity Metrics

This Annex describes our adaptation of the novelty and diversity metrics, originally proposed by (VARGAS; CASTELLS, 2011; VARGAS, 2015). They were tailored to fit the specific problem of session-based news recommendation. Generally, for the purpose of this investigation, novelty is evaluated in terms of *Long-Tail Novelty*. Items with high novelty correspond to long-tail items, i.e., items that were clicked on by few users, whilst low novelty items correspond to more popular items.

B.0.1 The ESI-R@n

The *Expected Self-Information with Rank-sensitivity* metric, presented in Equation B.2, was adapted from the *Mean Self-Information (MSI)* metric (Equation B.1) proposed by (CASTELLS *et al.*, 2015), with the addition of a rank discount.

$$\text{MSI} = \frac{1}{L} \sum_{i \in L} -\log_2 p(i | \text{known}, \theta) \quad (\text{B.1})$$

The term $-\log_2 p(i)$ represents the core of this metric, which comes from the *self-information* (also known as *surprisal*) metric of Information Theory, which quantifies the amount of information conveyed by the observation of an event (CASTELLS *et al.*, 2015). Applying the $\log(\cdot)$ function emphasizes the effect of highly novel items. It is defined $L = i_1, \dots, i_N$ as a recommendation list of size $N = |L|$.

$$\text{ESI-R}(L) = \frac{1}{\sum_{j=1}^N \text{disc}(j)} \sum_{k=1}^N -\log_2 p(i_k) \times \text{disc}(k) \quad (\text{B.2})$$

In this setting, the probability $p(i)$ of an item being part of a random user interaction under free discovery is the normalized recent popularity, i.e., $p(i) = \text{rec_norm_pop}(i)$, previously presented in Equation 4.7. In Equation B.2, $\text{disc}(\cdot)$ is a logarithmic rank discount, defined in Equation B.3, that maximizes the impact of novelty for top ranked items, under

the assumption that their characteristics will be more visible to users compared to the rest of the top- n recommendation list.

$$\text{disc}(k) = \frac{1}{\log_2(k+1)} \quad (\text{B.3})$$

B.0.2 The ESI-RR@ n

Analyzing quality factors like accuracy, novelty, and diversity in isolation can be misleading. Some Information Retrieval (IR) metrics, such as α DCG, therefore consider novelty contributions only for relevant items for a given query (CASTELLS *et al.*, 2015). As proposed by (VARGAS; CASTELLS, 2011), a relevance-sensitive novelty metric should likewise assess the novelty level based on the recommended items that are actually relevant to the user.

Thus, it was used a variation of a novelty metric to account for relevance—*Expected Self-Information with Rank- and Relevance-sensitivity (ESI-RR@ n)*. It weights the novelty contribution by the relevance of an item for a user $p(\text{rel}|i, u)$ (CASTELLS *et al.*, 2015). It was adapted the proposal from (VARGAS, 2015), as shown in Equation B.4.

$$p(\text{rel}|i, u) = \text{relevance}(i, u) = \begin{cases} 1.0, & \text{if } i \in \mathbb{I}_u \\ b, & \text{otherwise} \end{cases}, \quad (\text{B.4})$$

where \mathbb{I}_u is the set of items the user interacted within the ongoing session, and b is a background probability of an unobserved interaction (negative sample) being also somewhat relevant for a user. The lower the value of b (e.g., $b = 0$) the higher the influence of relevant items (accuracy) in this metric. The author of (VARGAS, 2015) used an empirically determined value of $b = 0.02$, based on his experiments on balancing diversity and novelty. In this study, it was arbitrarily set $b = 0.02$, so that all the 50 negative samples would sum up to the same relevance (1.0) of a positive (clicked) item.

Equation B.5 shows how the *ESI-RR@ n* metric is computed.

$$\text{ESI-RR}(L) = C_k \sum_{k=1}^N -\log_2 p(i_k) \times \text{disc}(k) \times \text{relevance}(i_k, u), \quad (\text{B.5})$$

Equation B.6 defines the term C_k , which computes the weighted average based on ranking discount.

$$C_k = \frac{1}{\sum_{k'=1}^N \text{disc}(k')} \quad (\text{B.6})$$

Like in (VARGAS, 2015), the relevance is not normalized, so that more relevant items among the top- n recommendations lead to a global higher novelty.

B.0.3 The EILD-R@ n

Diversity was measured based on the *Expected Intra-List Diversity* metric proposed by (VARGAS; CASTELLS, 2011), with variations to account for rank-sensitivity (*EILD-R@ n*) and for both rank- and relevance-sensitivity (*EILD-RR@ n*).

Intra-List Diversity measures the dissimilarity of the recommended items with respect to the other items in the recommended list. In this case, the distance metric $d(\cdot)$ defined in Equation B.7 is the cosine distance.

$$d(a, b) = (1 - \text{sim}(a, b))/2, \quad (\text{B.7})$$

Here, a and b are the *Article Content Embeddings* of two articles and $\text{sim}(a, b)$ is their cosine similarity. As the cosine similarity ranges from -1 to +1, the cosine distance is scaled to the range [0,1].

The *Expected Intra-List Diversity with Rank-sensitivity* (*EILD-R@ n*) metric, defined in Equation B.8, is the average intra-distance between items pairs weighted by a logarithmic rank discount $\text{disc}(\cdot)$, defined in Equation B.3. Given a recommendation list $L = i_1, \dots, i_N$ of size $N = |L|$, the *EILD-R@ n* metric is computed as follows.

$$\text{EILD-R}(L) = \frac{1}{\sum_{k'=1}^N \text{disc}(k')} \sum_{k=1}^N \text{disc}(k) \frac{1}{\sum_{l'=1: l' \neq k}^N \text{rdisc}(l', k)} \sum_{l=1: l \neq k}^N d(i_k, i_l) \times \text{rdisc}(l, k) \quad (\text{B.8})$$

The term $\text{rdisc}(l, k)$, defined in Equation B.9, represents a relative ranking discount, considering that an item l that is ranked before the target item k has already been discovered. In this case, items ranked after k are assumed to lead to a decreased diversity perception as the relative rank between k and l increases.

$$\text{rdisc}(l, k) = \text{disc}(\max(0, l - k)) \quad (\text{B.9})$$

B.0.4 The EILD-RR@ n

The *Expected Intra-List Diversity with Rank- and Relevance-sensitivity* finally measures the average diversity between item pairs, weighting items by rank discount and

relevance, analogously to the $ESI-RR@n$ metric, as shown in Equation B.10.

$$EILD-RR(L) = C_k \sum_{k=1}^N \text{disc}(k) \times \text{relevance}(i_k, u) C_l \sum_{l=1: l \neq k}^N d(i_k, i_l) \text{rdisc}(k, l) \times \text{relevance}(i_l, u) \quad (\text{B.10})$$

Here, C_k (Equation B.6) and C_l (Equation B.11) are normalization terms representing a weighted average based on rank discounts.

$$C_l = \frac{1}{\sum_{l'=1: l' \neq k}^N \text{rdisc}(k, l')} \quad (\text{B.11})$$

Annex C - Algorithms’

Hyper-parameters for Experiments

In Table C.1, it is presented the best hyper-parameters found for each algorithm and dataset. They were tuned for accuracy ($MRR@10$) on a hold-out validation set, by running random search within defined ranges for each hyper-parameter¹. More information about the hyper-parameters can be found in our shared code and in the papers where the baseline methods were proposed.

TABLE C.1 – The best hyper-parameters per algorithm and dataset

Method	Parameter	Description	G1	Adressa
CHAMELEON	batch_size	Number of sessions considered for each mini-batch	256	64
	learning_rate	Learning rate for each training step (mini-batch)	1e-4	3e-4
	reg_l2	L2 regularization of the network’s parameters	1e-5	1e-4
	softmax_temperature	Used to control the “temperature” of the softmax function	0.1	0.2
	CAR_embedding_size	Size of the User-Personalized Contextual Article Embedding	1024	1024
	rnn_units	Number of units in an RNN layer	255	255
	rnn_num_layers	Number of stacked RNN layers	2	2
SR	max_clicks_dist	Maximum number of clicks to walk back in the session from the currently viewed item.	10	10
	dist_between_clicks_decay	Decay function for the distance between two items clicks within a session (e.g., linear, same, div, log, quadratic)	div	div
Item-kNN	reg_lambda	Smoothing factor for the popularity distribution to normalize item vectors for co-occurrence similarity	20	20
	alpha	Balance between normalizing with the support counts of the two items. 0.5 gives cosine similarity, 1.0 gives confidence.	0.75	0.50
V-SkNN	sessions_buffer_size	Buffer size of last processed sessions	3000	3000
	candidate_sessions_sample_size	Number of candidates near the sessions to sample	1000	2000
	nearest_neighbor_session_for_scoring	Nearest neighbors to compute item scores	500	500
	similarity	Similarity function (e.g., Jaccard, cosine)	cosine	cosine
	sampling_strategy	Strategy for sampling (e.g., recent, random)	recent	recent
SR-GNN	first_session_clicks_decay	Decays the weight of first user clicks in active session when finding neighbor sessions (e.g. same, div, linear, log, quadratic)	div	div
	batch_size	Batch size	128	128
	n_epochs	Number of training epochs	10	10
	hidden_size	Number of units on hidden state	200	200
	l2_lambda	Coefficient of the L_2 regularization	1e-5	2e-5
	propagation_steps	GNN propagation steps	1	1
	learning_rate	Learning rate	1e-3	1e-3
learning_rate_decay	Learning rate decay factor	0.15	0.1	
GRU4Rec	learning_rate_decay_steps	number of steps after which the learning rate decays	3	3
	nonhybrid	Enables/disables the Hybrid mode	True	True
GRU4Rec	batch_size	Batch size	128	128
	n_epochs	Number of training epochs	3	3
	optimizer	Training optimizer	Adam	Adam
	loss	The loss type	bpr-max-0.5	bpr-max-0.5
	layers	Number of GRU units in the layers	[300]	[300]
	dropout_p_hidden	Dropout rate	0.0	0.0
	learning_rate	Learning rate	1e-4	1e-4
	l2_lambda	Coefficient of the L_2 regularization	1e-5	2e-5
	momentum	if not zero, Nesterov momentum will be applied during training with the given strength	0	0
	embedding	Size of the embedding used, 0 means not to use embedding	0	0

¹The methods *CO*, *RP*, and *CB* do not have hyper-parameters.

Appendix A - Deep Learning Background

This Appendix provides a background on Deep Learning techniques, methods, and neural architectures.

Machine learning is able to extract patterns from raw data and map input representations to outputs. Representation learning extends machine learning, in the sense that it is also able to learn the representation itself (GOODFELLOW *et al.*, 2016).

Deep Learning solves a central problem in representation learning, by introducing representations or concepts that are expressed in terms of other simpler representations (GOODFELLOW *et al.*, 2016). All deep models tries to learn good representations from observed data, in such a way that they are modeled as being generated by interactions of many hidden factors (BETRU *et al.*, 2017).

Deep models can be trained by either supervised or unsupervised approaches in neural network architectures with several layers, forming a hierarchy. Each subsequent layer extracts a progressively more abstract representation of the input data and builds upon the representation from the previous layer, typically by computing a nonlinear transformation of its input. The parameters of these transformations are optimized by training the model on a dataset (ZHENG, 2016) (DENG *et al.*, 2014).

Typical shallow neural networks consists of one or two layers. Although these models achieved good performance and were dominant in the 90's, due to its limited representation learning capacity, they have difficulties in modeling unstructured data such as text, images, and audios (ZHENG, 2016).

In 2006, (HINTON *et al.*, 2006) have shown that with a layer-wise training strategy, a Deep Belief Network (DBN) could be successfully trained to predict hand written digits. This was the first successful attempt to train a deep model. Before that, researchers had not seriously exploited deep models due to lack of data and computational power (ZHENG, 2016).

Distributed representations or embeddings form the basis of deep learning (BETRU *et*

al., 2017). Embeddings are learned real value vectors representing entities. They are also known as latent feature vectors, or latent representations. Embeddings vectors of similar entities are also similar.

Deep learning models were initially applied to the field of: Computer Vision, Audio, Speech Recognition, and Language Processing. They outperformed many state-of-the-art models, like reported in (LECUN *et al.*, 1998) (HINTON *et al.*, 2006) (BENGIO *et al.*, 2007) (LEE *et al.*, 2009).

A.1 Architectures of Deep Learning

Deep learning architectures can be composed by the combination of many different architectures. In this section, some types of deep architectures are briefly described.

A.1.1 The Restricted Boltzmann Machine (RBM)

The Boltzmann Machine is a network of symmetrically connected, neuron-like units, that make stochastic decisions about whether to be on or off.

The Restricted Boltzmann Machine (RBM) consists of a special BM, composed by a layer of visible units and a layer of hidden units with no visible-visible or hidden-hidden connections (RESNICK, 1994) (DENG *et al.*, 2014) (ZHENG, 2016) (BETRU *et al.*, 2017).

The Deep Boltzmann Machine (DBM) is a special Boltzmann Machine where the hidden units are organized in a deep layered manner, where only adjacent layers are connected, and there are no visible-visible or hidden-hidden connections within the same layer (ZHENG, 2016) (DENG *et al.*, 2014) (BETRU *et al.*, 2017).

A.1.2 The Deep Belief Network (DBN)

The Deep Belief Network (DBN) consists of probabilistic generative models composed of multiple layers of stochastic hidden variables. The top two layers have indirectly symmetric connections between them. The lower layers receive top-down, directed connections from the layer above (ZHENG, 2016) (DENG *et al.*, 2014) (BETRU *et al.*, 2017).

A DBN is formed with a stack of RBM. In its first two layers, it should be trained a two layer RBM with one visible layer and one hidden layer. Then, activation probabilities of the hidden layer forms a visible layer to learn another hidden layer. In this manner, the RBM can be stacked to learn a multi-layer DBN (ZHENG, 2016).

A.1.3 The Deep Feed-Forward Neural Network (FFNN)

The Deep Feed-Forward Neural Network (FFNN) is a multilayer perceptron network with many hidden fully connected layers. The parameters of its layers are trained with the Back-Propagation (BP) method, using gradient-based numerical optimization (CHAUVIN; RUMELHART, 1995).

Usually a FFNN is composed of a sequence of Fully Connected (FC) layers that perform affine transformations on the output of the previous layer. Generally, a non-linear activation function is applied to model complex relationships among its input features, like shown as follows

$$h_i = f(w_i \cdot h_{i-1} + b_i), \quad (\text{A.1})$$

where h_i is the output of a hidden layer, w_i and b_i are the layer's weight vector and bias vector, respectively, h_{i-1} is the previous layer, and $f(\cdot)$ is a non-linear activation function.

The Rectified Linear Units (ReLU) activation function, shown in Equation A.2, is usually preferred over other saturating non-linear functions, like hyperbolic tangent (tanh) or sigmoid, because neural networks with ReLU layers may be trained several times faster (KRIZHEVSKY *et al.*, 2012), without a significant penalty to generalization accuracy.

$$f(x) = \max(0, x) \quad (\text{A.2})$$

Other common ingredient of FFNN is a Dropout layer. Dropout is a popular regularization technique for Deep Learning, which stochastically disables a configured fraction of its neurons. This prevents neurons from co-adapting and forces them to learn individually useful features, providing better generalization.

Part of the success of FFNN is that it can accommodate a larger number of hidden units and perform better parameter initialization methods. Even when learned parameters are at local optimal, FFNN can perform much better than those with less hidden units (ZHENG, 2016) (DENG *et al.*, 2014) (BETRU *et al.*, 2017).

A.1.4 The Deep Auto Encoder (DAE)

The Deep Auto-Encoder (DAE) is a special type of DNN, which output target is the data input itself, often pre-trained with DBN or by using distorted training data to regularize the learning, using denoising auto-encoders (VINCENT *et al.*, 2008).

By forcing the input and output to be the same, the output of the middle layer can be regarded as dense representations (ZHENG, 2016). (HINTON; SALAKHUTDINOV, 2006) proposed a pre-training technique to learn deep auto encoders with multiple layers. This technique involves treating each neighboring set of two layers as an RBM. In this manner, the pre-training procedure approximates a good parameter initialization. Then, they use a back-propagation technique to fine-tune the pre-trained model (ZHENG, 2016) (DENG *et al.*, 2014).

A.1.5 The Convolutional Neural Network (CNN)

The Convolutional Neural Network (CNN) (LECUN *et al.*, 1998) architecture have achieved state-of-the-art results in computer vision, speech recognition, and have been shown to be competitive in several NLP tasks.

By applying convolution operations (known as kernels or filters) at different levels of granularity, a CNN can extract features that are useful for learning tasks and reduce the needs of manual feature engineering (TUAN; PHUONG, 2017).

The CNN is a variant of FFNN with two components: 1) convolution layer, for generating local features; and 2) pooling (or sub-sampling) layer, for representing data as more concisely by selecting only representative local features (i.e., features having the highest score, via the activation functions) from the previous layer, which is usually a convolution layer (KIM *et al.*, 2016).

In its convolutional layers, the outputs of the previous layer are fed into a set of convolutional filters and generate a set of filtered results. Then, these results are sub-sampled based on their activations in a following sub-sampling layer. Convolutional layers and sub-sampling layers can be alternatively added to build a deep CNN model, as shown in Figure A.1.

As a class of deep models for learning features, the CNN learns a hierarchy of increasingly complex features. Without building hand-crafted features, these methods utilize layers with convolving filters that are applied on top of pre-trained word embeddings.

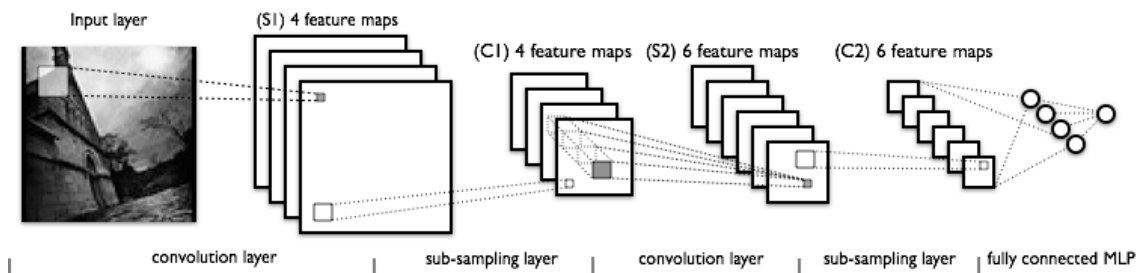

FIGURE A.1 – A typical CNN architecture

The weight sharing in the convolutional layer, together with properly chosen pooling schemes, endows the CNN with some invariance properties (HUANG *et al.*, 2007). Moreover, in benefiting from the shared weights, CNNs have fewer parameters to be learned than traditional feed-forward neural networks (ZHENG, 2016) (DENG *et al.*, 2014). Such weight sharing imposes a general assumption that the input can be decomposed into a set of local regions with then same nature , thus, could be processed with the same set of transformations.

The Meta-Architecture proposed in this research has CNNs as one of the feature extractors mechanism from news textual content.

A.1.6 The Recurrent Neural Network (RNN)

Several methods have been proposed to incorporate temporal information into RS, at some stage (CAMPOS *et al.*, 2014). In (VINAGRE *et al.*, 2015) they are differentiated as follows:

- *Time-aware RS* - considers time as a contextual feature during the training phase. Timestamps serve as an additional source of information by which the model is enriched. The rationale behind is that user behavior underlies certain habits and regularities that repeat in regular time intervals, consequently allowing a more accurate prediction of similar patterns in the future; and
- *Time-dependent RS* - consider user preference data as chronologically ordered sequences, assuming that the most intrinsic property is that time establishes an order for events. Input is required in chronological form, while exact time spans do not need to be taken into account. The algorithms consequently do not aim at modeling time as being cyclic, but rather at adapting to changes.

The RNN has been devised to model variable-length sequence data. The main difference between the RNN and the traditional DFFNN is the existence of an internal hidden state, or memory, in the units that compose the network (HIDASI *et al.*, 2016).

An RNN has a number of particular characteristics: (1) It is sensitive to sequences' order, (2) It does not require hand-engineered features to model sequences, and (3) it is easy to leverage large unlabeled datasets, by pretraining the RNN parameters with unsupervised language modeling objectives (BANSAL *et al.*, 2016).

The RNN has provided substantial performance gains in a variety of natural language processing applications such as language modeling (MIKOLOV *et al.*, 2010a) and machine translation (CHO *et al.*, 2014b).

The RNN uses gradient based methods, like Back-Propagation Through Time (BPTT) (WILLIAMS; ZIPSER, 1995), to learn its parameters. Although errors signals flowing back in time exponentially depends on the magnitude of the weights, this implies that the back-propagated error quickly either vanishes or blows up (HOCHREITER; SCHMIDHUBER, 1997). Thus, a standard RNN has a limitation in learning from longer time lags between relevant input and target events (HOCHREITER; SCHMIDHUBER, 1997) (GERS, 2001).

Gated RNN architectures (CHUNG *et al.*, 2014) are designed to overcome this limitation by including gating units trained to control information flow through the network, thereby learning to keep information over a long period of time. Gates essentially learn when and by how much to update the hidden state of the unit. Both Long Short-Term Memory (LSTM) (GERS, 2001) (HOCHREITER; SCHMIDHUBER, 1997) and Gated Recurrent Unit (GRU) (CHO *et al.*, 2014a; CHUNG *et al.*, 2014) networks have shown advantages in real-world applications (DONKERS *et al.*, 2017).

Gated RNNs architectures have not been designed with the recommendation domain in mind. In particular, they are not optimized for taking interaction between user and system into account (DONKERS *et al.*, 2017).

Figure A.2 illustrates an RNN being unfolded (or unrolled) in time for forward computation, where x_t is the input at time t , s_t is the hidden state at time step t , and o_t is the output at step t . For example, if the sequence we care about is a sentence of 5 words, the network would be unrolled into a 5-layer neural network, one layer for each word.

When the RNN is unrolled, it becomes a type of Deep Feed-Forward Neural Network (FFNN), but instead of using different parameters in each layer like in FFNN, it shares the same weights across every time step.

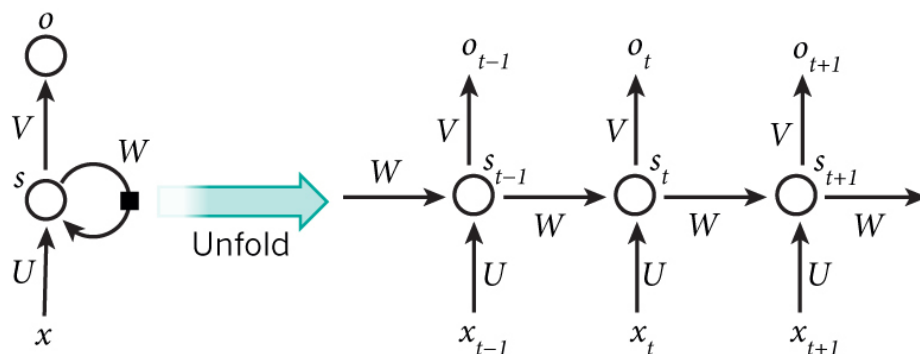

FIGURE A.2 – An RNN and its unfolding in time for forward computation

A recent research line, starting from the seminal work of (HIDASI *et al.*, 2016), have adapted RNNs for session-based recommendations, where the sequence of user interactions in a session is leveraged to predict his next interaction in that session.

The Meta-Architecture proposed in this research uses RNNs to model users sessions

in news portals.

A.1.7 The *Deep Structured Semantic Model (DSSM)*

The *Deep Semantic Structured Model (DSSM)* was proposed in (HUANG *et al.*, 2013) for ranking purpose and was later on extended to the recommendation scenarios in (ELKAHKY *et al.*, 2015), and is shown in Figure A.3.

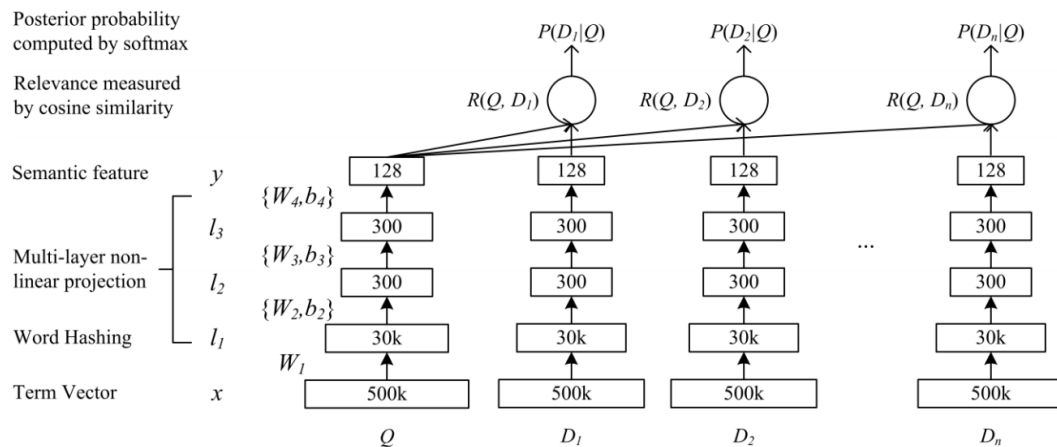

FIGURE A.3 – The *Deep Semantic Structured Model (DSSM)*, from (HUANG *et al.*, 2013)

The *DSSM* uses a FFNN to map the raw term vector (i.e., a bag-of-words textual representation) of a query or a document to its latent semantic vector, where the first layer, also known as the word hashing layer, converts the term vector to a letter-*trigram* vector to scale up the training. The final layer’s neural activities form the embedding vector representation in the semantic space. In document retrieval, the relevance score between a document and a query is the cosine similarity of their corresponding semantic concept vectors. The *DSSM* is reported to give superior IR performance to other semantic models (SHEN *et al.*, 2014).

Essentially, the *DSSM* can be seen as a multi-view learning model often composed of two or more neural networks for each individual view. In the original two-view *DSSM* model, the left network represents the query view and the right network represents the document view. The input of each neural network can be arbitrary types of features, e.g., letter-trigram used in the original paper (HUANG *et al.*, 2013), or bag of unigram features used in (ELKAHKY *et al.*, 2015).

Each input feature vector goes through non-linear transformations in the feed forward network to output an embedding vector, which is often much smaller than the original input space. The learning objective of the *DSSM* is to maximize the cosine similarity between the two output vectors. During training, a set of positive examples and randomly sampled negative examples are generated in each mini-batch to minimize the cosine simi-

larity with the positive examples. The log-likelihood loss function used to learn the model parameters follows the pair-wise learning-to-rank paradigm (LIU *et al.*, 2015; RAHIMI *et al.*, 2019).

(GAO *et al.*, 2014) demonstrate the effectiveness of the *DSSM* by using two interesting tasks: automatic highlighting and contextual entity search. These tasks outperform not only the classic document models not using semantics but also the state-of-the-art of topic models. They trained the *DSSM*, by using browsing transitions between Wikipedia documents.

(SHEN *et al.*, 2014) have proposed the *Convolutional Latent Semantic Model (CLSM)*, shown in Figure A.4.

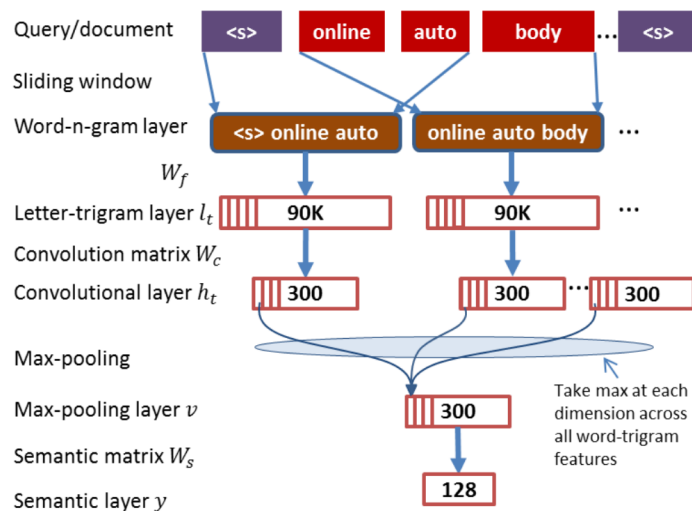

FIGURE A.4 – The *Convolutional Latent Semantic Model (CLSM)*, from (SHEN *et al.*, 2014)

This was done, based on the *DSSM* and, according to authors, it was the first successful attempt in applying CNN-like methods to Information Retrieval (IR). One main difference from the conventional CNN is that the convolution operation in the *CLSM* is implicitly applied on the letter-trigram representation space. Such convolutional architecture was more effective for IR to capture salient local features than simply summing over contributions from all words uniformly.

The *DSSM* and derived work were some of the main inspirations for the Meta-Architecture proposed in this research.

A.2 Deep Learning for NLP

The Natural Language Processing (NLP) is the use of human language by a computer. It includes applications like machine translation, entity recognition, disambiguation, parsing, part-of-speech tagging, among others. Many NLP applications are based on language models that define a probability distribution over sequences of words or characters, in a natural language (GOODFELLOW *et al.*, 2016).

Deep models based on CNN and RNN have shown their effectiveness for various NLP tasks (ZHENG, 2016), like sentence modeling (KALCHBRENNER *et al.*, 2014), machine translation (MENG *et al.*, 2015), semantic parsing (YIH *et al.*, 2014), and many other NLP tasks (SANTOS *et al.*, 2015). Many inspirations for the application of Deep Learning in Recommender Systems came from successful Deep NLP techniques.

The *Quasi-Recurrent Neural Network (QRNN)* is a NLP architecture that provides a sequence modeling that alternates convolutional layer in parallel across time-steps, and a minimalist recurrent pooling function that applies in parallel across channels (BRADBURY *et al.*, 2016). According to its authors, the *QRNN* has advantages over the RNN, in terms of increased parallelism and even better predictive accuracy.

Neural language models are designed to overcome the curse of dimensionality problem for modeling NLP sequences. Words representation, originally sparse word vectors – one-hot vectors whose dimensionality is the vocabulary size, are projected to a lower dimensional vector space, a.k.a distributed representations. They are able to recognize that two words are similar without losing the ability to encode each word representation (embedding) as distinct from the other (BENGIO *et al.*, 2003a).

Such word representations may explicitly encode many linguistic regularities and patterns. For example, the result of a vector calculation $vec("Madrid") - vec("Spain") + vec("France")$ is closer to $vec("Paris")$ than to any other word vector (MIKOLOV *et al.*, 2013a). These word embeddings have shown very good results in many NLP tasks (MIKOLOV *et al.*, 2013b; TURIAN *et al.*, 2010; COLLOBERT *et al.*, 2011; BENGIO *et al.*, 2003b; ZHENG, 2016).

Word2Vec (MIKOLOV *et al.*, 2013a) is a popular method for learning high-quality vector representations of words from large amounts of unstructured text data. It defines the context of a word as the surrounding words, based in the famous statement of the English linguist John Rupert Firth: "You shall know a word by the company it keeps" (FIRTH, 1957).

Word2Vec embeddings can be trained by using two strategies: *CBOW* and *Skip-gram*. The *CBOW* is trained to predict a target word based on their surrounding words (context). The *Skip-gram* employs an inverse strategy, trying to predict the surrounding

words based on the target word, as shown in Figure A.5. Word embeddings trained by using the Skip-gram strategy have shown to be more robust and representative, specially when trained on large text corpus.

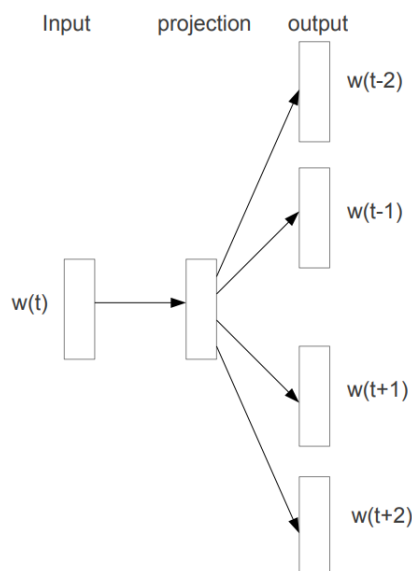

FIGURE A.5 – The Word2Vec Skip-gram model, from (MIKOLOV *et al.*, 2013a)

GloVe is another popular method to obtain vector representations for words by using unsupervised learning. Training is performed on aggregated global word-word co-occurrence statistics from a corpus, and resulting representations showcase interesting linear substructures of the word vector space (PENNINGTON *et al.*, 2014).

The *Text CNN* (KIM, 2014) offers a simple solution for sentence-level embeddings by using convolutions. The convolutions act as a form of n-gram filters, allowing the network to embed sentence-level information and specializing word embeddings to higher-order tasks such as text classification or sentiment analysis. However, the kernel size in a CNN is fixed during training. To achieve good enough performance, sometimes an ensemble of multiple CNNs with different kernel sizes has to be used. A more natural and adaptive way of modeling text sequences would be to use gated RNN models (HOCHREITER; SCHMIDHUBER, 1997; CHO *et al.*, 2014b; SUTSKEVER *et al.*, 2014).

In this research, articles' textual contents are represented as a sequence of pre-trained word embeddings, used as input for feature extraction by Deep NLP architectures.

.
.
.
.

Glossary

Accuracy A recommendation quality factor that measures the ability of an RS to provide recommendations that matches users interest, i.e., items actually interacted by users

Adressa dataset

Dataset from the Adressa (GULLA *et al.*, 2017), a Norwegian news portal which have been commonly used in news recommendation research. More details in Section 5.3.3.

Article Content Embedding (ACE)

A distributed representation (embedding) of the textual content of an article.

Article Content Representation (ACR)

The *CHAMELEON*'s module responsible to learn a distributed representation (an embedding) of articles' textual content.

Article Context

For the purpose of this work, this is a feature set composed by the dynamic features of *Novelty* and the *Recency* of an article.

Article Metadata

For the purpose of this work, this is a feature set composed by the following attributes of an article: Category and Author.

Bayesian Personalized Ranking (BPR)

A classical pairwise ranking loss proposed in (RENDLE *et al.*, 2009).

CHAMELEON

The Deep Learning Meta-Architecture for News Recommender Systems proposed in this research.

Co-Occurence (CO)

Baseline algorithm that recommends articles commonly viewed together with the last read article in previous user sessions. This algorithm is a simplified version of the association rules technique, having two as

the maximum rule size (pairwise item co-occurrences) (LUDEWIG; JANNACH, 2018; JUGOVAC *et al.*, 2018).

Cold-start problem

A well-known challenge in recommender systems research, specially for Collaborative Filtering methods. The *User cold-start problem* occurs when most users have not provided enough interactions to receive accurate recommendations. Similarly, the *Item cold-start problem* takes place when most active items have not received enough interactions to be effectively recommended.

Collaborative Filtering (CF)

Family of recommendation methods based on similar behavior among users in the system. They ignore users and item attributes. The main methods for CF are memory-based (eg. Nearest Neighbors) and model-based (e.g., Clustering, Association Rules, Matrix Factorization, Neural Networks) (JANNACH *et al.*, 2010).

Content Embeddings Training (CET)

The sub-module of *ACR* module responsible to train the *Article Content Embeddings (ACE)*, in a supervised or unsupervised approach.

Content-Based (CB)

Baseline algorithm that recommends articles with similar content to the last clicked article, based on the cosine similarity of their *Article Content Embeddings*.

Content-Based Filtering (CBF)

Family of recommendation methods that matches users and items by means of their attributes, ignoring the behaviour of other users (BURKE, 2007).

Context-Aware Recommender System (CARS)

Family of recommendation methods that try to improve the quality of recommendations by adapting them to the specific contextual situation of the user (ADOMAVICIUS *et al.*, 1).

Contextual Article Representation (CAR)

The sub-module of *NAR* module responsible to combine the inputs for the *NAR* module: (1) the pre-trained Article Content Embedding; (2) the Article Context features; and (3) the User Context features.

Convolutional Neural Network (CNN)

Type of neural network architecture that apply convolution operations (known as kernels or filters) at different levels of granularity, under

the assumption that neighbouring values are correlated in the input structure (LECUN *et al.*, 1998). They are able to reduce the number of parameters of the network, compared to MLP-only networks. CNNs have been successfully applied in Computer Vision and NLP.

Cosine similarity

A measure of similarity between two non-zero vectors of an inner product space that measures the cosine of the angle between them. The cosine similarity is particularly used in positive space, where the outcome is neatly bounded in $[0,1]$.

Deep Feed-Forward Neural Network (FFNN)

A Multilayer Perceptron Network with many hidden fully connected layers. The parameters of its layers are trained with the Back-Propagation (BP) method, using SGD optimization.

Deep Learning (DL)

A family of Representation Learning methods that express representations or concepts in terms of composition of other simpler representations (GOODFELLOW *et al.*, 2016). Deep models usually have many stacked layers, and try to learn good representations from observed data, in such a way that they are modeled as being generated by interactions of many hidden factors (BETRU *et al.*, 2017). Deep learning models have achieved super-human performance in tasks from Computer Vision, Audio, Speech Recognition, and Language Processing

Deep Structured Semantic Model (DSSM)

A deep neural network for learning semantic representations of entities in a common continuous semantic space and measuring their semantic similarities (HUANG *et al.*, 2013). More details in Appendix A.1.7.

Diversity

A recommendation quality factor that measures the ability of an RS to recommend a diversified list of items. The most common metrics for diversity are based on dissimilarity between recommended items (ZHANG *et al.*, 2002; ZIEGLER *et al.*, 2005; RODRIGUEZ *et al.*, 2012; LI *et al.*, 2014). Lack of diversity may lead to poor user experiences (LI *et al.*, 2014)

doc2vec

The Paragraph Vector (a.k.a doc2vec) (LE; MIKOLOV, 2014) learns fixed-length feature representations from variable-length pieces of texts, which are trained via the distributed memory and distributed bag of words models.

G1 dataset

Dataset provided for this research by *Globo.com*, the most popular media company in Brazil. This dataset was originally shared by us in

(MOREIRA *et al.*, 2018), with a second version shared in (MOREIRA *et al.*, 2019a). More details in Section 5.3.3.

Gated Recurrent Unit (GRU)

A Gated RNN similar to the LSTM with forget gate, but with fewer parameters than LSTM, as it lacks an output gate (CHO *et al.*, 2014a; CHUNG *et al.*, 2014).

Gini Index

The *Gini Index* measures the inequality among values of a frequency distribution (for example, levels of income). A Gini coefficient of zero expresses perfect equality, where all values are the same. A Gini coefficient of one (or 100%) expresses maximal inequality among values.

GloVe

A popular method to obtain vector representations for words by using unsupervised learning. Training is performed on aggregated global word-word co-occurrence statistics from a corpus, and resulting representations showcase interesting linear substructures of the word vector space (PENNINGTON *et al.*, 2014).

Graph Neural Networks (GNN)

Type of neural network architectures designed to generate representations for graphs (SCARSELLI *et al.*, 2008; LI *et al.*, 2016).

GRU4Rec

A landmark neural architecture using RNNs for session-based recommendation (HIDASI *et al.*, 2016), described in Section 3.3.1.

Hybrid Filtering

Family of recommendation methods that combines CF and CBF to provide recommendations with higher quality and to deal with the Cold-start problem, which usually takes place when using only CF methods (BURKE, 2002; BURKE, 2007).

Item Coverage

A recommendation quality factor that measures the percentage of active items that are ever recommended in top-N lists (MAKSAI *et al.*, 2015).

Item-kNN

Baseline algorithm that returns the most similar items to the last read article using the cosine similarity between their vectors of co-occurrence with other items within sessions. This method has been commonly used as a baseline when neural approaches for session-based recommendation were proposed, e.g., in (HIDASI *et al.*, 2016).

Latent Semantic Analysis (LSA)

A classical method of computing high-dimensional semantic vectors for words from their co-occurrence statistics (DEERWESTER *et al.*, 1990).

Long Short-Term Memory (LSTM)

A Gated RNN architecture designed to deal with the vanishing gradient problem of original RNNs (GERS, 2001; HOCHREITER; SCHMIDHUBER, 1997).

Loss function In mathematical optimization and decision theory, a loss function, cost function, or objective function is a function that maps an event or values of one or more variables onto a real number intuitively representing some "cost" associated with the event. An optimization problem seeks to minimize a loss function.

Matrix Factorization

Linear algebra methods that factorizes a matrix into a product of matrices. Traditional collaborative filtering techniques are based on Matrix Factorization of the User-Item matrix.

Mini-batch A set of data samples used for training a model using Mini-Batch Gradient Descent.

Multi-label classification

A classification problem in which there is no constraint on how many of the classes the instance can be assigned to

Multi-Task Learning (MTL)

The approach of training a model for more than one task. By sharing representations between related tasks, the model may generalize better, as can be seen in successful MTL applications in NLP (COLLOBERT; WESTON, 2008), speech recognition (DENG *et al.*, 2013), computer vision (GIRSHICK, 2015), and recommender systems (BANSAL *et al.*, 2016).

Multi-View Deep Neural Network (MV-DNN)

A Deep Learning architecture to map users and items to a latent space, where the similarity between users and their preferred items is maximized (ELKAHKY *et al.*, 2015). More details in Section 3.5.1.

Multi-View Learning

Multi-view or multi-modal learning aims to learn how to model latent factors for each view and jointly optimizes all the functions to improve the generalization performance (ZHAO *et al.*, 2017)

Natural Language Processing (NLP)

Use of human language by a computer. It includes applications like machine translation, entity recognition, disambiguation, parsing, part-of-speech tagging, among others. Many NLP applications are based on language models that define a probability distribution over sequences of

words or characters, in a natural language (GOODFELLOW *et al.*, 2016). Deep models based on CNN and RNN have shown their effectiveness for various NLP tasks (ZHENG, 2016), like sentence modeling (KALCHBRENNER *et al.*, 2014), machine translation (MENG *et al.*, 2015), semantic parsing (YIH *et al.*, 2014), and many other NLP tasks (SANTOS *et al.*, 2015).

Neural Architecture Search (NAS)

A family of techniques for automating the design of artificial neural networks.

Next-Article Recommendation (NAR)

The *CHAMELEON*'s module responsible to generate next-article recommendations for ongoing user sessions.

No-ACE

The *No-ACE* Input Configuration used in the experiments to answer (*RQ3*), that uses only features from the following feature sets: *Article Context*, *Article Metadata*, and the *User Context*, without using a textual content representation. More details in Section 6.3

Novelty

A recommendation quality factor that measures the ability of an RS to unknown or novel items for the users. For the purpose of this investigation, novelty is evaluated in terms of *Long-Tail Novelty*, i.e., the ability of an RS to recommend long-tail (non-popular) items (VARGAS; CASTELLS, 2011; VARGAS, 2015).

Pearson correlation coefficient

A measure of the linear correlation between two variables.

Predicted Next-Article Embedding

The output of the *SER* sub-module, which is the predicted representation of a news content the user would like to read next in the active session.

Recency

The recency of an item is the elapsed time since the article was initially made available for users in the system. In the news domain, for example, it is the time since an article was published.

Recent Normalized Popularity

For the purpose of this research, the Normalized Popularity is the ratio between the number of interactions an item have received divided by the sum of all user interactions in a website, during the last hour

Recent Popularity

For the purpose of this research, the recent popularity of an item is the number of user interactions an item have received in the last hour.

Recently Popular (RP)

Baseline algorithm that recommends the most viewed articles within a defined set of recently observed user interactions on the news portal (e.g., clicks during the last hour). Such a strategy proved to be very effective in the *2017 CLEF NewsREEL Challenge* (LUDMANN, 2017).

Recommendation System (RS)

A subclass of information filtering system that seeks to predict the relevance of an item for a given user. Recommender systems are utilized in a variety of domains, such as e-commerce, entertainment, media, and financial services companies.

Recommendations Ranking (RR)

The sub-module of *NAR* module responsible to recommend articles for a user session.

Recurrent Neural Network (RNN)

Type of neural network architecture that naturally deals with sequence data. The RNNs have a hidden state, or memory, which represents past information previously processed. The RNN uses Back-Propagation Through Time (BPTT) (WILLIAMS; ZIPSER, 1995), to learn its parameters. Gated RNN architectures (CHUNG *et al.*, 2014), such as LSTM and GRU, are designed to overcome the vanishing gradient problem from the original RNN, by including gating units trained to control information flow through the network, thereby learning to keep information over a longer period of time.

Representation Learning

Set of techniques that allows a system to automatically discover the representations needed for feature detection or classification from raw data. This reduces the need of manual feature engineering and allows a machine to both learn the features and use them to perform a specific task.

Sequence Denoising GRU Autoencoder (SDA-GRU)

For the purpose of this work, it is the *unsupervised* instantiation of the *ACR* module, based on Sequence Denoising *GRU* Autoencoders, as described in Section 5.1.1.2.

Sequential Rules (SR)

Baseline algorithm that uses association rules of size two. It however considers the sequence of the items within a session. A rule is created when an item q appeared after an item p in a session, even when other items were viewed between p and q . The rules are weighted by the

distance x (number of steps) between p and q in the session with a linear weighting function $w_{SR} = 1/x$ (LUDEWIG; JANNACH, 2018).

Session A sequence of user interactions that takes place within a given time frame (QUADRANA *et al.*, 2017)

Session Representation (SER)

The sub-module of *NAR* module responsible to model users' short-term preferences, based on the sequence of interactions (reading news) in user's active session.

Session-Aware Recommender System

A type of Context-Aware RS (CARS) which leverages information about both the current session and past user sessions (differently than Session-Based RS) when available, to model user's preferences (TWARDOWSKI, 2016).

Session-Based Recommender System

Is a type of a Context-Aware RS (CARS), which leverages only information available in the current session for recommendations, ignoring the behaviour of past sessions of the user (EPURE *et al.*, 2017).

SR-GNN

A recently published state-of-the-art architecture for session-based recommendation based on Graph Neural Networks (WU *et al.*, 2019), described in Section 3.3.12.

Stochastic Gradient Descent (SGD)

An iterative method for optimizing an objective function with suitable smoothness properties (e.g.m differentiable). Methods derived from SGD are commonly used for training linear and deep neural networks. They are specially useful in big data applications, because SGD allows the network to be incrementally trained in steps composed by a single sample or by a mini-batch of samples (Mini-Batch Gradient Descent).

Supervised learning

A class of machine learning tasks of learning a function that maps an input to an output (label) based on example input-output pairs.

Term Frequency-Inverse Document Frequency (TF-IDF)

A numerical statistic that is intended to reflect how important a word is to a document in a collection or corpus. A relevant word for a document is one that is frequent in that document and rare in other documents of the corpus

Textual Features Representation (TFR)

The sub-module of *ACR* module responsible to learn relevant features directly from the article textual content.

TOP1 A pairwise ranking loss function proposed for *GRU4Rec* in (HIDASI; KARATZOGLOU, 2018).

Unsupervised learning

A class of machine learning tasks that is able to find patterns in data set, without pre-existing labels.

Update Gate RNN (UGRNN)

The *UGRNN* architecture is a compromise between *LSTM/GRU* and a vanilla RNN. In the *UGRNN* architecture, there is only one additional gate, which determines whether the hidden state should be updated or carried over (COLLINS *et al.*, 2017).

User Context For the purpose of this work, this is a feature set composed by the user *Location, Device, Time, and Referrer*.

User-Personalized Contextual Article Embedding

The output of the *CAR* sub-module, which is a non-linear combination of the content of the articles with user-personalized and contextual information.

Vector Multiplication Session-Based kNN (V-SkNN)

Baseline algorithm that compares the entire active session with past (neighboring) sessions to determine items to be recommended. The similarity function emphasizes items that appear later within the session. The method proved to be highly competitive in the evaluations in (JANNACH; LUDEWIG, 2017; LUDEWIG; JANNACH, 2018; JUGOVAC *et al.*, 2018).

W2V*TF-IDF A baseline representation of textual content, created by averaging the *word2vec* embeddings of the title and first words of an article and weighing by their *TF-IDF* scores.

word2vec The most popular method for learning high-quality vector representations of words from large amounts of unstructured text data. It defines the context of a word as the surrounding words, based in the famous statement of the English linguist John Rupert Firth: "You shall know a word by the company it keeps" (FIRTH, 1957). More details in Section A.2.

Bibliography

ABADI, M.; AGARWAL, A.; BARHAM, P.; BREVDO, E.; CHEN, Z.; CITRO, C.; CORRADO, G. S.; DAVIS, A.; DEAN, J.; DEVIN, M. *et al.* Tensorflow: Large-scale machine learning on heterogeneous distributed systems. **arXiv preprint arXiv:1603.04467**, 2016.

ADAMS, R. P.; DAHL, G. E.; MURRAY, I. Incorporating side information in probabilistic matrix factorization with gaussian processes. **arXiv preprint arXiv:1003.4944**, 2010.

ADOMAVICIUS, G.; KWON, Y. Improving aggregate recommendation diversity using ranking-based techniques. **IEEE Transactions on Knowledge and Data Engineering**, IEEE, v. 24, n. 5, p. 896–911, 2011.

ADOMAVICIUS, G.; MOBASHER, B.; RICCI, F.; TUZHILIN, A. Context-aware recommender systems. **AI Magazine**, v. 32, n. 3, p. 67–80, 1 1. Disponível em: <<https://www.aaai.org/ojs/index.php/aimagazine/article/view/2364>>.

AGARWAL, D.; CHEN, B.-C. Regression-based latent factor models. In: **Proceedings of the 15th ACM SIGKDD International Conference on Knowledge Discovery and Data Mining (KDD'09)**. [S.l.: s.n.], 2009. p. 19–28.

AHMED, A.; LOW, Y.; ALY, M.; JOSIFOVSKI, V.; SMOLA, A. J. Scalable distributed inference of dynamic user interests for behavioral targeting. In: **Proceedings of the 17th ACM SIGKDD International Conference on Knowledge Discovery and Data Mining (KDD'11)**. [S.l.: s.n.], 2011. p. 114–122.

AHN, J.-w.; BRUSILOVSKY, P.; GRADY, J.; HE, D.; SYN, S. Y. Open user profiles for adaptive news systems: help or harm? In: **Proceedings of the 16th International Conference on World Wide Web (WWW'07)**. [S.l.: s.n.], 2007. p. 11–20.

ALAIN, G.; BENGIO, Y. What regularized auto-encoders learn from the data-generating distribution. **The Journal of Machine Learning Research**, JMLR.org, v. 15, n. 1, p. 3563–3593, 2014.

AMAZON.COM. **Q4 2009 Financial Results**: Earnings report q4-2009. [S.l.], 2010. Disponível em: <<http://www.sop.inria.br/science/skd.gz>>. Acesso em: 15 mar. 2015.

BADENES, H.; BENGUALID, M. N.; CHEN, J.; GOU, L.; HABER, E.; MAHMUD, J.; NICHOLS, J. W.; PAL, A.; SCHOUDT, J.; SMITH, B. A. *et al.* System u: automatically deriving personality traits from social media for people recommendation.

- In: **Proceedings of the 8th ACM Conference on Recommender systems**. [S.l.: s.n.], 2014. p. 373–374.
- BAHDANAU, D.; CHO, K.; BENGIO, Y. Neural machine translation by jointly learning to align and translate. **arXiv preprint arXiv:1409.0473**, 2014.
- BANSAL, T.; BELANGER, D.; MCCALLUM, A. Ask the gru: Multi-task learning for deep text recommendations. In: **Proceedings of the 10th ACM Conference on Recommender Systems (RecSys'16)**. [S.l.: s.n.], 2016. p. 107–114.
- BARKAN, O.; KOENIGSTEIN, N. Item2vec: neural item embedding for collaborative filtering. In: **Proceedings of 2016 IEEE 26th International Workshop on the Machine Learning for Signal Processing (MLSP'16)**. [S.l.: s.n.], 2016. p. 1–6.
- BASTIAN, M.; HAYES, M.; VAUGHAN, W.; SHAH, S.; SKOMOROCH, P.; KIM, H.; URYASEV, S.; LLOYD, C. Linkedin skills: large-scale topic extraction and inference. In: **Proceedings of the 8th ACM Conference on Recommender systems**. [S.l.: s.n.], 2014. p. 1–8.
- BEEL, J.; GENZMEHR, M.; LANGER, S.; NÜRNBERGER, A.; GIPP, B. A comparative analysis of offline and online evaluations and discussion of research paper recommender system evaluation. In: **Proceedings of the International Workshop on Reproducibility and Replication in Recommender Systems Evaluation**. [S.l.: s.n.], 2013. p. 7–14.
- BEEL, J.; LANGER, S.; GENZMEHR, M.; NÜRNBERGER, A. Introducing docear's research paper recommender system. In: **Proceedings of the 13th ACM/IEEE-CS joint Conference on Digital Libraries**. [S.l.: s.n.], 2013. p. 459–460.
- BEEL, J.; LANGER, S.; GENZMEHR, M.; GIPP, B.; BREITINGER, C.; NÜRNBERGER, A. Research paper recommender system evaluation: A quantitative literature survey. In: **Proceedings of the International Workshop on Reproducibility and Replication in Recommender Systems Evaluation**. [S.l.: s.n.], 2013. p. 15–22.
- BENGIO, Y.; DUCHARME, R.; VINCENT, P.; JAUVIN, C. A neural probabilistic language model. **Journal of machine learning research**, v. 3, n. Feb, p. 1137–1155, 2003.
- BENGIO, Y.; DUCHARME, R.; VINCENT, P.; JAUVIN, C. A neural probabilistic language model. **Journal of machine learning research**, v. 3, n. Feb, p. 1137–1155, 2003.
- BENGIO, Y.; LECUN, Y. *et al.* Scaling learning algorithms towards ai. **Large-scale kernel machines**, v. 34, n. 5, p. 1–41, 2007.
- BENGIO, Y. *et al.* Learning deep architectures for ai. **Foundations and trends® in Machine Learning**, Now Publishers, Inc., v. 2, n. 1, p. 1–127, 2009.
- BENNETT, J.; LANNING, S. The netflix prize. In: **In KDD Cup and Workshop in conjunction with KDD**. [S.l.: s.n.], 2007.

BETRU, B. T.; ONANA, C. A.; BATCHAKUI, B. Deep learning methods on recommender system: A survey of state-of-the-art. **International Journal of Computer Applications**, Foundation of Computer Science, v. 162, n. 10, 2017.

BIELIKOVÁ, M.; KOMPAN, M.; ZELENÍK, D. Effective hierarchical vector-based news representation for personalized recommendation. **Computer Science and Information Systems**, v. 9, n. 1, p. 303–322, 2012.

BILLSUS, D.; PAZZANI, M. J. A hybrid user model for news story classification. In: **User Modeling**. [S.l.]: Springer, 1999. p. 99–108.

BILLSUS, D.; PAZZANI, M. J. A personal news agent that talks, learns and explains. In: **Proceedings of the 3rd Annual Conference on Autonomous Agents**. [S.l.: s.n.], 1999. p. 268–275.

BILTON, R. **The Washington Post tests personalized "pop-up" newsletters to promote its big stories**. [S.l.]: NiemanLab, May 2016.
<http://www.niemanlab.org/2016/05/the-washington-post-tests-personalized-pop-up-newsletters-to-promote-its-big-stories/>

BLEI, D. M.; NG, A. Y.; JORDAN, M. I. Latent dirichlet allocation. **Journal of machine Learning research**, v. 3, n. Jan, p. 993–1022, 2003.

BLOOMBERG, J. **Architecture Technical Debt: The Curse of Agile?** [S.l.]: devX, July 2014. <http://www.devx.com/blog/agile/architecture-technical-debt-the-curse-of-agile.html>.

BRADBURY, J.; MERITY, S.; XIONG, C.; SOCHER, R. Quasi-recurrent neural networks. **arXiv preprint arXiv:1611.01576**, 2016.

BREESE, J. S.; HECKERMAN, D.; KADIE, C. Empirical analysis of predictive algorithms for collaborative filtering. In: **Proceedings of the 14th Conference on Uncertainty in Artificial Intelligence**. [S.l.: s.n.], 1998. p. 43–52.

BU, J.; TAN, S.; CHEN, C.; WANG, C.; WU, H.; ZHANG, L.; HE, X. Music recommendation by unified hypergraph: combining social media information and music content. In: **Proceedings of the International Conference on Multimedia**. [S.l.: s.n.], 2010. p. 391–400.

BURKE, R. Hybrid recommender systems: Survey and experiments. **User modeling and user-adapted interaction**, Springer, v. 12, n. 4, p. 331–370, 2002.

BURKE, R. The adaptive web. chapter hybrid web recommender systems. Springer-Verlag, Berlin, Heidelberg, 2007.

CALDARELLI, S.; GURINI, D. F.; MICARELLI, A.; SANSONETTI, G. A signal-based approach to news recommendation. In: **Extended Proceedings of the UMAP'16**. [S.l.: s.n.], 2016.

CAMPOS, P. G.; DÍEZ, F.; CANTADOR, I. Time-aware recommender systems: a comprehensive survey and analysis of existing evaluation protocols. **User Modeling and User-Adapted Interaction**, Springer, v. 24, n. 1-2, p. 67–119, 2014.

- CAPELLE, M.; FRASINCAR, F.; MOERLAND, M.; HOGENBOOM, F. Semantics-based news recommendation. In: **Proceedings of the 2nd International Conference on Web Intelligence, Mining and Semantics**. [S.l.: s.n.], 2012. p. 27.
- CARUNA, R. Multitask learning: A knowledge-based source of inductive bias. In: **Proceedings of the Tenth International Conference on Machine Learning**. [S.l.: s.n.], 1993. p. 41–48.
- CASTELLS, P.; HURLEY, N. J.; VARGAS, S. Novelty and diversity in recommender systems. In: RICCI, F.; ROKACH, L.; SHAPIRA, B. (Ed.). **Recommender Systems Handbook**. [S.l.]: Springer US, 2015. p. 881–918. ISBN 978-1-4899-7637-6.
- CATHERINE, R.; COHEN, W. Transnets: Learning to transform for recommendation. **arXiv preprint arXiv:1704.02298**, 2017.
- CELMA, Ò.; HERRERA, P. A new approach to evaluating novel recommendations. In: **Proceedings of the 2008 ACM Conference on Recommender Systems (RecSys'08)**. [S.l.: s.n.], 2008. p. 179–186.
- CHANG, J.; GERRISH, S.; WANG, C.; BOYD-GRABER, J. L.; BLEI, D. M. Reading tea leaves: How humans interpret topic models. In: **Proceedings of the Advances in neural information processing systems (NIPS'09)**. [S.l.: s.n.], 2009. p. 288–296.
- CHAUVIN, Y.; RUMELHART, D. E. **Backpropagation: theory, architectures, and applications**. [S.l.]: Psychology Press, 1995.
- CHEN, M.; XU, Z.; WEINBERGER, K.; SHA, F. Marginalized denoising autoencoders for domain adaptation. **arXiv preprint arXiv:1206.4683**, 2012.
- CHENG, H.-T.; KOC, L.; HARMSSEN, J.; SHAKED, T.; CHANDRA, T.; ARADHYE, H.; ANDERSON, G.; CORRADO, G.; CHAI, W.; ISPIR, M. *et al.* Wide & deep learning for recommender systems. In: **Proceedings of the 1st Workshop on Deep Learning for Recommender Systems at ACM RecSys'16**. [S.l.: s.n.], 2016. p. 7–10.
- CHO, K.; MERRIËNBOER, B. V.; BAHDANAU, D.; BENGIO, Y. On the properties of neural machine translation: Encoder-decoder approaches. **arXiv preprint arXiv:1409.1259**, 2014.
- CHO, K.; MERRIËNBOER, B. V.; GULCEHRE, C.; BAHDANAU, D.; BOUGARES, F.; SCHWENK, H.; BENGIO, Y. Learning phrase representations using rnn encoder-decoder for statistical machine translation. p. 7–10, 2014.
- CHU, W.; PARK, S.-T. Personalized recommendation on dynamic content using predictive bilinear models. In: **Proceedings of the 18th International Conference on World Wide Web (WWW'09)**. [S.l.: s.n.], 2009. p. 691–700.
- CHUNG, J.; GULCEHRE, C.; CHO, K.; BENGIO, Y. Empirical evaluation of gated recurrent neural networks on sequence modeling. **arXiv preprint arXiv:1412.3555**, 2014.

- COBA, L.; SYMEONIDIS, P.; ZANKER, M. Novelty-aware matrix factorization based on item popularity. In: **Proceedings of the International Conference of the Italian Association for Artificial Intelligence**. [S.l.: s.n.], 2018. p. 516–527.
- COLLINS, J.; SOHL-DICKSTEIN, J.; SUSSILLO, D. Capacity and trainability in recurrent neural networks. In: **Proceedings of the 5th International Conference on Learning Representations (ICLR'17)**. [S.l.: s.n.], 2017.
- COLLOBERT, R.; WESTON, J. A unified architecture for natural language processing: Deep neural networks with multitask learning. In: **Proceedings of the 25th International Conference on Machine Learning (ICML'08)**. [S.l.: s.n.], 2008. p. 160–167.
- COLLOBERT, R.; WESTON, J.; BOTTOU, L.; KARLEN, M.; KAVUKCUOGLU, K.; KUKSA, P. Natural language processing (almost) from scratch. **Journal of Machine Learning Research**, v. 12, n. Aug, p. 2493–2537, 2011.
- CREMONESI, P.; KOREN, Y.; TURRIN, R. Performance of recommender algorithms on top-n recommendation tasks. In: **Proceedings of the fourth ACM conference on Recommender systems**. [S.l.: s.n.], 2010. p. 39–46.
- DAI, A. M.; LE, Q. V. Semi-supervised sequence learning. In: **Advances in neural information processing systems**. [S.l.: s.n.], 2015. p. 3079–3087.
- DALLMANN, A.; GRIMM, A.; PÖLITZ, C.; ZOLLER, D.; HOTHO, A. Improving session recommendation with recurrent neural networks by exploiting dwell time. **arXiv preprint arXiv:1706.10231**, 2017.
- DAS, A. S.; DATAR, M.; GARG, A.; RAJARAM, S. Google news personalization: scalable online collaborative filtering. In: **Proceedings of the 16th International Conference on World Wide Web (WWW'07)**. [S.l.: s.n.], 2007. p. 271–280.
- DAVIDSON, J.; LIEBALD, B.; LIU, J.; NANDY, P.; VLEET, T. V.; GARGI, U.; GUPTA, S.; HE, Y.; LAMBERT, M.; LIVINGSTON, B. *et al.* The youtube video recommendation system. In: **Proceedings of the fourth ACM Conference on Recommender Systems (RecSys'10)**. [S.l.: s.n.], 2010. p. 293–296.
- DEERWESTER, S.; DUMAIS, S. T.; FURNAS, G. W.; LANDAUER, T. K.; HARSHMAN, R. Indexing by latent semantic analysis. **Journal of the American Society for Information Science**, v. 41, n. 6, p. 391–407, 1990.
- DENG, L.; HINTON, G.; KINGSBURY, B. New types of deep neural network learning for speech recognition and related applications: An overview. In: **Proceedings of the 2013 IEEE International Conference on Acoustics, Speech and Signal Processing (ICASSP'13)**. [S.l.: s.n.], 2013. p. 8599–8603.
- DENG, L.; YU, D. *et al.* Deep learning: methods and applications. **Foundations and Trends® in Signal Processing**, Now Publishers, Inc., v. 7, n. 3–4, p. 197–387, 2014.
- DESARKAR, M. S.; SHINDE, N. Diversifying news recommendation for privacy concerned users. In: **Proceedings of the 2014 International Conference on Data Science and Advanced Analytics (DSAA'14)**. [S.l.: s.n.], 2014. p. 135–141.

- DONKERS, T.; LOEPP, B.; ZIEGLER, J. Sequential user-based recurrent neural network recommendations. In: **Proceedings of the Eleventh ACM Conference on Recommender Systems (RecSys'17)**. [S.l.: s.n.], 2017. p. 152–160.
- DOYCHEV, D.; LAWLOR, A.; RAFTER, R.; SMYTH, B. An analysis of recommender algorithms for online news. In: **Proceedings of the CLEF 2014 Conference and Labs of the Evaluation Forum: Information Access Evaluation Meets Multilinguality, Multimodality and Interaction**. [S.l.: s.n.], 2014.
- EKSTRAND, M. D.; RIEDL, J. T.; KONSTAN, J. A. Collaborative filtering recommender systems. **Foundations and Trends in Human-Computer Interaction**, v. 4, n. 2, p. 81–173, set./nov. 2011. Disponível em: <<http://www.nowpublishers.com/article/Details/HCI-009>>. Acesso em: 15 mar. 2015.
- ELKAHKY, A. M.; SONG, Y.; HE, X. A multi-view deep learning approach for cross domain user modeling in recommendation systems. In: **Proceedings of the 24th International Conference on World Wide Web (WWW'15)**. [S.l.: s.n.], 2015. p. 278–288.
- EPURE, E. V.; KILLE, B.; INGVALDSEN, J. E.; DENECKERE, R.; SALINESI, C.; ALBAYRAK, S. Recommending personalized news in short user sessions. In: **Proceedings of the Eleventh ACM Conference on Recommender Systems (RecSys'17)**. [S.l.: s.n.], 2017. p. 121–129.
- FIRTH, J. R. A synopsis of linguistic theory, 1930-1955. **Studies in linguistic analysis**, Basil Blackwell, 1957.
- FORTUNA, B.; FORTUNA, C.; MLADENIĆ, D. Real-time news recommender system. In: **Proceedings of the Joint European Conference on Machine Learning and Knowledge Discovery in Databases**. [S.l.: s.n.], 2010. p. 583–586.
- FUENTES, A.; YOON, S.; KIM, S. C.; PARK, D. S. A robust deep-learning-based detector for real-time tomato plant diseases and pests recognition. **Sensors**, Multidisciplinary Digital Publishing Institute, v. 17, n. 9, p. 2022, 2017.
- GABRILOVICH, E.; DUMAIS, S.; HORVITZ, E. Newsjunkie: providing personalized newsfeeds via analysis of information novelty. In: **Proceedings of the 13th International Conference on World Wide Web (WWW'04)**. [S.l.: s.n.], 2004. p. 482–490.
- GAO, J.; DENG, L.; GAMON, M.; HE, X.; PANTEL, P. **Modeling interestingness with deep neural networks**. [S.l.]: Google Patents, jun. 13 2014. US Patent App. 14/304,863.
- GARCIN, F.; DIMITRAKAKIS, C.; FALTINGS, B. Personalized news recommendation with context trees. In: **Proceedings of the 7th ACM Conference on Recommender Systems (RecSys'13)**. [S.l.: s.n.], 2013. p. 105–112.
- GARCIN, F.; FALTINGS, B.; DONATSCH, O.; ALAZZAWI, A.; BRUTTIN, C.; HUBER, A. Offline and online evaluation of news recommender systems at swissinfo. ch. In: **Proceedings of the 8th ACM Conference on Recommender systems (RecSys'14)**. [S.l.: s.n.], 2014. p. 169–176.

- GE, M.; DELGADO-BATTENFELD, C.; JANNACH, D. Beyond accuracy: evaluating recommender systems by coverage and serendipity. In: **Proceedings of the 4th ACM Conference on Recommender Systems (RecSys'10)**. [S.l.: s.n.], 2010. p. 257–260.
- GERS, F. Long short-term memory in recurrent neural networks. **Unpublished PhD dissertation, Ecole Polytechnique Fédérale de Lausanne, Lausanne, Switzerland**, 2001.
- GIRSHICK, R. Fast r-cnn. In: **Proceedings of the IEEE International Conference on Computer Vision**. [S.l.: s.n.], 2015. p. 1440–1448.
- GOMEZ-URIBE, C. A.; HUNT, N. The Netflix recommender system: Algorithms, business value, and innovation. **Transactions on Management Information Systems**, v. 6, n. 4, p. 13:1–13:19, 2015.
- GOODFELLOW, I.; BENGIO, Y.; COURVILLE, A. **Deep Learning**. [S.l.]: MIT Press, 2016. <http://www.deeplearningbook.org>.
- GOPALAN, P. K.; CHARLIN, L.; BLEI, D. Content-based recommendations with poisson factorization. In: **Proceedings of the Advances in Neural Information Processing Systems (NIPS'14)**. [S.l.: s.n.], 2014. p. 3176–3184.
- GRAFF, R. **How the Washington Post used data and natural language processing to get people to read more news**. [S.l.]: Northwestern University Knight Lab, June 2015. <https://knightlab.northwestern.edu/2015/06/03/how-the-washington-posts-clavis-tool-helps-to-make-news-personal/>.
- GRBOVIC, M.; RADOSAVLJEVIC, V.; DJURIC, N.; BHAMIDIPATI, N.; SAVLA, J.; BHAGWAN, V.; SHARP, D. E-commerce in your inbox: Product recommendations at scale. In: **Proceedings of the 21th ACM SIGKDD International Conference on Knowledge Discovery and Data Mining (KDD'15)**. [S.l.: s.n.], 2015. p. 1809–1818.
- GULLA, J. A.; MARCO, C.; FIDJESTØL, A. D.; INGVALDSEN, J. E.; ÖZGÖBEK, Ö. The intricacies of time in news recommendation. In: **Extended Proceedings of the 24th Conference On User Modelling, Adaptation And Personalization (UMAP'16)**. [S.l.: s.n.], 2016.
- GULLA, J. A.; ZHANG, L.; LIU, P.; ÖZGÖBEK, Ö.; SU, X. The adressa dataset for news recommendation. In: **Proceedings of the International Conference on Web Intelligence (WI'17)**. [S.l.: s.n.], 2017. p. 1042–1048.
- GUO, H.; TANG, R.; YE, Y.; LI, Z.; HE, X. Deepfm: A factorization-machine based neural network for ctr prediction. In: **Proceedings of the Twenty-Sixth International Joint Conference on Artificial Intelligence**. [S.l.: s.n.], 2017.
- HAKIMI, A. **Meta-Architecture**. [S.l.]: MSDN - Microsoft Software Development Network, February 2013. <https://blogs.msdn.microsoft.com/zen/2013/02/20/deep-thinking-on-the-architecture-of-architecture-meta-architecture/>.
- HALKO, N.; MARTINSSON, P.-G.; TROPP, J. A. Finding structure with randomness: Probabilistic algorithms for constructing approximate matrix decompositions. **SIAM review**, SIAM, v. 53, n. 2, p. 217–288, 2011.

HE, K.; ZHANG, X.; REN, S.; SUN, J. Deep residual learning for image recognition. In: **Proceedings of the IEEE Conference on Computer Vision and Pattern Recognition (CVPR'16)**. [S.l.: s.n.], 2016. p. 770–778.

HE, X.; LIAO, L.; ZHANG, H.; NIE, L.; HU, X.; CHUA, T.-S. Neural collaborative filtering. In: **Proceedings of the 26th International Conference on World Wide Web (WWW'17)**. [S.l.: s.n.], 2017. p. 173–182.

HERLOCKER, J. L.; KONSTAN, J. A.; BORCHERS, A.; RIEDL, J. An algorithmic framework for performing collaborative filtering. In: **Proceedings of the 22nd annual International Conference on Research and Development in Information Retrieval (SIGIR'90)**. [S.l.: s.n.], 1999. p. 230–237.

HERLOCKER, J. L.; KONSTAN, J. A.; TERVEEN, L. G.; RIEDL, J. T. Evaluating collaborative filtering recommender systems. **ACM Transactions on Information Systems (TOIS)**, ACM, v. 22, n. 1, p. 5–53, 2004.

HIDASI, B. **Deep Learning for Recommender Systems**. [S.l.]: Faculdade de Engenharia da Universidade do Porto, August 2017.
<http://pro.unibz.it/projects/schoolrecsys17/DeepLearning.pdf>.

HIDASI, B.; KARATZOGLOU, A. Recurrent neural networks with top-k gains for session-based recommendations. In: **ACM. Proceedings of the 27th ACM International Conference on Information and Knowledge Management**. [S.l.], 2018. p. 843–852.

HIDASI, B.; KARATZOGLOU, A.; BALTRUNAS, L.; TIKK, D. Session-based recommendations with recurrent neural networks. In: **Proceedings of Fourth International Conference on Learning Representations (ICLR'16)**. [S.l.: s.n.], 2016.

HIDASI, B.; KARATZOGLOU, A.; SAR-SHALOM, O.; DIELEMAN, S.; SHAPIRA, B.; TIKK, D. Dlrs 2017-second workshop on deep learning for recommender systems. In: **Proceedings of the 2st Workshop on Deep Learning for Recommender Systems at ACM RecSys'17**. [S.l.: s.n.], 2017. v. 29, p. 34.

HIDASI, B.; QUADRANA, M.; KARATZOGLOU, A.; TIKK, D. Parallel recurrent neural network architectures for feature-rich session-based recommendations. In: **Proceedings of the 10th ACM Conference on Recommender Systems (RecSys'16)**. [S.l.: s.n.], 2016. p. 241–248.

HINTON, G. E.; OSINDERO, S.; TEH, Y.-W. A fast learning algorithm for deep belief nets. **Neural computation**, MIT Press, v. 18, n. 7, p. 1527–1554, 2006.

HINTON, G. E.; SALAKHUTDINOV, R. R. Reducing the dimensionality of data with neural networks. **science**, American Association for the Advancement of Science, v. 313, n. 5786, p. 504–507, 2006.

HOCHREITER, S.; SCHMIDHUBER, J. Long short-term memory. **Neural computation**, MIT Press, v. 9, n. 8, p. 1735–1780, 1997.

- HU, Y.; KOREN, Y.; VOLINSKY, C. Collaborative filtering for implicit feedback datasets. In: **Proceedings of the Eighth IEEE International Conference on Data Mining (ICDM'08)**. [S.l.: s.n.], 2008. p. 263–272.
- HU, Y.; KOREN, Y.; VOLINSKY, C. Collaborative filtering for implicit feedback datasets. In: **Proceedings of the Eighth IEEE International Conference on Data Mining, ICDM'08**. [S.l.: s.n.], 2008. p. 263–272.
- HUANG, F. J.; BOUREAU, Y.-L.; LECUN, Y. *et al.* Unsupervised learning of invariant feature hierarchies with applications to object recognition. In: **Proceedings of the IEEE Conference on Computer Vision and Pattern Recognition (CVPR'07)**. [S.l.: s.n.], 2007. p. 1–8.
- HUANG, P.-S.; HE, X.; GAO, J.; DENG, L.; ACERO, A.; HECK, L. Learning deep structured semantic models for web search using clickthrough data. In: **Proceedings of the 22nd ACM International Conference on Conference on Information & Knowledge Management**. [S.l.: s.n.], 2013. p. 2333–2338.
- IAQUINTA, L.; GEMMIS, M. D.; LOPS, P.; SEMERARO, G.; FILANNINO, M.; MOLINO, P. Introducing serendipity in a content-based recommender system. In: **Proceedings of the Eighth International Conference on Hybrid Intelligent Systems, (HIS'08)**. [S.l.: s.n.], 2008. p. 168–173.
- ILIEVSKI, I.; ROY, S. Personalized news recommendation based on implicit feedback. In: **Proceedings of the 2013 International News Recommender Systems Workshop and Challenge**. [S.l.: s.n.], 2013. p. 10–15.
- IQBAL, R.; SCOTT, M.; CLEVELAND, T. Measuring actual visitor engagement in news websites. In: **Extended Proceedings of the UMAP'16**. [S.l.: s.n.], 2016.
- ISINKAYE, F.; FOLAJIMI, Y.; OJOKOH, B. Recommendation systems: Principles, methods and evaluation. **Egyptian Informatics Journal**, Elsevier, v. 16, n. 3, p. 261–273, 2015.
- JAKOB, N.; WEBER, S. H.; MÜLLER, M. C.; GUREVYCH, I. Beyond the stars: exploiting free-text user reviews to improve the accuracy of movie recommendations. In: **Proceedings of the 1st International Workshop on Topic-sentiment Analysis for Mass Opinion at CIKM'19**. [S.l.: s.n.], 2009. p. 57–64.
- JANNACH, D.; LERCHE, L.; KAMEHKHOSH, I.; JUGOVAC, M. What recommenders recommend: an analysis of recommendation biases and possible countermeasures. **User Modeling and User-Adapted Interaction**, Springer, v. 25, n. 5, p. 427–491, 2015.
- JANNACH, D.; LUDEWIG, M. When recurrent neural networks meet the neighborhood for session-based recommendation. In: **Proceedings of the Eleventh ACM Conference on Recommender Systems (RecSys'17)**. [S.l.: s.n.], 2017. p. 306–310.
- JANNACH, D.; ZANKER, M.; FELFERNIG, A.; FRIEDRICH, G. **Recommender systems: an introduction**. [S.l.]: Cambridge University Press, 2010.
- JÄRVELIN, K.; KEKÄLÄINEN, J. Cumulated gain-based evaluation of ir techniques. **ACM Transactions on Information Systems (TOIS)**, ACM, v. 20, n. 4, p. 422–446, 2002.

- JAWAHEER, G.; WELLER, P.; KOSTKOVA, P. Modeling user preferences in recommender systems: A classification framework for explicit and implicit user feedback. **ACM Transactions on Interactive Intelligent Systems (TiiS)**, ACM, v. 4, n. 2, p. 8, 2014.
- JI, S.; XU, W.; YANG, M.; YU, K. 3d convolutional neural networks for human action recognition. **IEEE transactions on pattern analysis and machine intelligence**, IEEE, v. 35, n. 1, p. 221–231, 2013.
- JUGOVAC, M.; JANNACH, D.; KARIMI, M. Streamingrec: A framework for benchmarking stream-based news recommenders. In: **Proceedings of the Twelfth ACM Conference on Recommender Systems (RecSys '18)**. [S.l.: s.n.], 2018. p. 306–310.
- JUGOVAC, M.; JANNACH, D.; LERCHE, L. Efficient optimization of multiple recommendation quality factors according to individual user tendencies. **Expert Systems With Applications**, Elsevier BV, v. 81, p. 321–331, 2017.
- KALCHBRENNER, N.; GREFFENSTETTE, E.; BLUNSOM, P. A convolutional neural network for modelling sentences. **arXiv preprint arXiv:1404.2188**, 2014.
- KARIMI, M.; JANNACH, D.; JUGOVAC, M. News recommender systems—survey and roads ahead. **Information Processing & Management**, Elsevier, v. 54, n. 6, p. 1203–1227, 2018.
- KENTHAPADI, K.; LE, B.; VENKATARAMAN, G. Personalized job recommendation system at linkedin: Practical challenges and lessons learned. In: **Proceedings of the Eleventh ACM Conference on Recommender Systems (RecSys'17)**. [S.l.: s.n.], 2017. p. 346–347.
- KHATTAR, D.; KUMAR, V.; GUPTA, M.; VARMA, V. Neural content-collaborative filtering for news recommendation. 2018.
- KILLE, B.; HOPFGARTNER, F.; BRODT, T.; HEINTZ, T. The plista dataset. In: **Proceedings of the 2013 International News Recommender Systems Workshop and Challenge at ACM RecSys'13**. [S.l.: s.n.], 2013. p. 16–23.
- KILLE, B.; LOMMATZSCH, A.; HOPFGARTNER, F.; LARSON, M.; BRODT, T. Clef 2017 newsreel overview: Offline and online evaluation of stream-based news recommender systems. [S.l.]: CEUR, 2017.
- KIM, D.; PARK, C.; OH, J.; LEE, S.; YU, H. Convolutional matrix factorization for document context-aware recommendation. In: **Proceedings of the 10th ACM Conference on Recommender Systems (RecSys'16)**. [S.l.: s.n.], 2016. p. 233–240.
- KIM, Y. Convolutional neural networks for sentence classification. **arXiv preprint arXiv:1408.5882**, 2014.
- KIM, Y.-D.; CHOI, S. Scalable variational bayesian matrix factorization with side information. In: **Proceedings of the 17th International Conference on Artificial Intelligence and Statistics (AISTATS'14)**. [S.l.: s.n.], 2014. p. 493–502.

- KIRSHENBAUM, E.; FORMAN, G.; DUGAN, M. A live comparison of methods for personalized article recommendation at forbes. com. **Machine Learning and Knowledge Discovery in Databases**, Springer, p. 51–66, 2012.
- KNIJNENBURG, B. P.; WILLEMSSEN, M. C.; GANTNER, Z.; SONCU, H.; NEWELL, C. Explaining the user experience of recommender systems. **User Modeling and User-Adapted Interaction**, Kluwer Academic Publishers, v. 22, n. 4-5, p. 441–504, 2012.
- KONSTAN, J. A.; MILLER, B. N.; MALTZ, D.; HERLOCKER, J. L.; GORDON, L. R.; RIEDL, J. Grouplens: applying collaborative filtering to usenet news. **Communications of the ACM**, ACM, v. 40, n. 3, p. 77–87, 1997.
- KOREN, Y.; BELL, R.; VOLINSKY, C. Matrix factorization techniques for recommender systems. **IEEE Computer**, IEEE, v. 42, n. 8, 2009.
- KRESTEL, R.; FANKHAUSER, P.; NEJDL, W. Latent dirichlet allocation for tag recommendation. In: **Proceedings of the third ACM Conference on Recommender Systems (RecSys'09)**. [S.l.: s.n.], 2009. p. 61–68.
- KRIZHEVSKY, A.; SUTSKEVER, I.; HINTON, G. E. Imagenet classification with deep convolutional neural networks. In: **Proceedings of the Advances in neural information processing systems (NIPS'12)**. [S.l.: s.n.], 2012. p. 1097–1105.
- KUMAR, V.; KHATTAR, D.; GUPTA, S.; GUPTA, M.; VARMA, V. Deep neural architecture for news recommendation. In: **Working Notes of CEUR Workshop Proceedings at the 8th International Conference of the CLEF Initiative**. [S.l.: s.n.], 2017.
- KUMAR, V.; KHATTAR, D.; GUPTA, S.; GUPTA, M.; VARMA, V. User profiling based deep neural network for temporal news recommendation. In: **IEEE. 2017 IEEE International Conference on Data Mining Workshops (ICDMW)**. [S.l.], 2017. p. 765–772.
- KUMAR, V.; KHATTAR, D.; GUPTA, S.; VARMA, V. Word semantics based 3-d convolutional neural networks for news recommendation. In: **IEEE. 2017 IEEE International Conference on Data Mining Workshops (ICDMW)**. [S.l.], 2017. p. 761–764.
- LE, Q.; MIKOLOV, T. Distributed representations of sentences and documents. In: **Proceedings of the 31st International Conference on Machine Learning (ICML-14)**. [S.l.: s.n.], 2014. p. 1188–1196.
- LECUN, Y.; BOTTOU, L.; BENGIO, Y.; HAFFNER, P. Gradient-based learning applied to document recognition. **Proceedings of the IEEE**, IEEE, v. 86, n. 11, p. 2278–2324, 1998.
- LEE, D.; HOSANAGAR, K. Impact of recommender systems on sales volume and diversity. In: **Proceedings of the Thirty Fifth International Conference on Information Systems (ICIS'14)**. [S.l.: s.n.], 2014.

- LEE, H.; AHN, Y.; LEE, H.; HA, S.; LEE, S.-g. Quote recommendation in dialogue using deep neural network. In: **Proceedings of the 39th International Conference on Research and Development in Information Retrieval (ACM SIGIR'16)**. [S.l.: s.n.], 2016. p. 957–960.
- LEE, H.; GROSSE, R.; RANGANATH, R.; NG, A. Y. Convolutional deep belief networks for scalable unsupervised learning of hierarchical representations. In: **Proceedings of the 26th annual International Conference on Machine Learning**. [S.l.: s.n.], 2009. p. 609–616.
- LEE, H. J.; PARK, S. J. Moners: A news recommender for the mobile web. **Expert Systems with Applications**, Elsevier, v. 32, n. 1, p. 143–150, 2007.
- LERCHE, L.; JANNACH, D.; LUDEWIG, M. On the value of reminders within e-commerce recommendations. In: **Proceedings of the 2016 Conference on User Modeling Adaptation and Personalization, (UMAP'16)**. [S.l.: s.n.], 2016.
- LI, J.; REN, P.; CHEN, Z.; REN, Z.; LIAN, T.; MA, J. Neural attentive session-based recommendation. In: **Proceedings of the 2017 ACM on Conference on Information and Knowledge Management**. [S.l.: s.n.], 2017. (CIKM '17), p. 1419–1428.
- LI, L.; CHU, W.; LANGFORD, J.; SCHAPIRE, R. E. A contextual-bandit approach to personalized news article recommendation. In: **Proceedings of the 19th International Conference on World Wide Web (WWW'10)**. [S.l.: s.n.], 2010. p. 661–670.
- LI, L.; WANG, D.; LI, T.; KNOX, D.; PADMANABHAN, B. Scene: a scalable two-stage personalized news recommendation system. In: **Proceedings of the 34th International Conference on Research and Development in Information Retrieval (SIGIR'11)**. [S.l.: s.n.], 2011. p. 125–134.
- LI, L.; ZHENG, L.; YANG, F.; LI, T. Modeling and broadening temporal user interest in personalized news recommendation. **Expert Systems with Applications**, Elsevier, v. 41, n. 7, p. 3168–3177, 2014.
- LI, S.; KAWALE, J.; FU, Y. Deep collaborative filtering via marginalized denoising auto-encoder. In: **Proceedings of the 24th ACM International on Conference on Information and Knowledge Management**. [S.l.: s.n.], 2015. p. 811–820.
- LI, Y.; TARLOW, D.; BROCKSCHMIDT, M.; ZEMEL, R. Gated graph sequence neural networks. In: ICLR. **Proceedings of the 4th International Conference of Learning Representations - ICLR**. [S.l.], 2016.
- LIAN, J.; ZHANG, F.; XIE, X.; SUN, G. Cccfnet: a content-boosted collaborative filtering neural network for cross domain recommender systems. In: INTERNATIONAL WORLD WIDE WEB CONFERENCES STEERING COMMITTEE. **Proceedings of the 26th international conference on World Wide Web companion**. [S.l.], 2017. p. 817–818.

- LIANG, D.; KRISHNAN, R. G.; HOFFMAN, M. D.; JEBARA, T. Variational autoencoders for collaborative filtering. In: **INTERNATIONAL WORLD WIDE WEB CONFERENCES STEERING COMMITTEE. Proceedings of the 2018 World Wide Web Conference**. [S.l.], 2018. p. 689–698.
- LILLEBERG, J.; ZHU, Y.; ZHANG, Y. Support vector machines and word2vec for text classification with semantic features. In: **IEEE. 2015 IEEE 14th International Conference on Cognitive Informatics & Cognitive Computing (ICCI* CC)**. [S.l.], 2015. p. 136–140.
- LIN, C.; XIE, R.; GUAN, X.; LI, L.; LI, T. Personalized news recommendation via implicit social experts. **Information Sciences**, Elsevier, v. 254, p. 1–18, 2014.
- LIU, J.; DOLAN, P.; PEDERSEN, E. R. Personalized news recommendation based on click behavior. In: **Proceedings of the 15th International Conference on Intelligent User Interfaces**. [S.l.: s.n.], 2010. p. 31–40.
- LIU, Q.; WU, S.; WANG, D.; LI, Z.; WANG, L. Context-aware sequential recommendation. In: **Proceedings of the 2016 IEEE 16th International Conference on Data Mining (ICDM'16)**. [S.l.: s.n.], 2016. p. 1053–1058.
- LIU, Q.; ZENG, Y.; MOKHOSI, R.; ZHANG, H. STAMP: short-term attention/memory priority model for session-based recommendation. In: **Proceedings of the 24th ACM SIGKDD International Conference on Knowledge Discovery & Data Mining, KDD'18**. [S.l.: s.n.], 2018. p. 1831–1839.
- LIU, X.; GAO, J.; HE, X.; DENG, L.; DUH, K.; WANG, Y.-Y. Representation learning using multi-task deep neural networks for semantic classification and information retrieval. 2015.
- LOMMATZSCH, A. Real-time news recommendation using context-aware ensembles. In: **Proceedings of the 36th European Conference on IR Research (ECIR'14)**. [S.l.: s.n.], 2014. v. 14, p. 51–62.
- LOMMATZSCH, A.; KILLE, B.; ALBAYRAK, S. Incorporating context and trends in news recommender systems. In: **Proceedings of the International Conference on Web Intelligence (WI'17)**. [S.l.: s.n.], 2017. p. 1062–1068.
- LOMMATZSCH, A.; KILLE, B.; HOPFGARTNER, F.; LARSON, M.; BRODT, T.; SEILER, J.; OZGOBEK, O. Clef 2017 newsreel overview: A stream-based recommender task for evaluation and education. **Lecture Notes in Computer Science**, Springer, v. 10439, 2017.
- LOPEZ-PAZ, D.; BOTTOU, L.; SCHÖLKOPF, B.; VAPNIK, V. Unifying distillation and privileged information. **arXiv preprint arXiv:1511.03643**, 2015.
- LUDEWIG, M.; JANNACH, D. Evaluation of session-based recommendation algorithms. **User-Modeling and User-Adapted Interaction**, Springer, v. 28, n. 4–5, p. 331–390, 2018.
- LUDEWIG, M.; MAURO, N.; LATIFI, S.; JANNACH, D. Performance comparison of neural and non-neural approaches to session-based recommendation. In: **Proceedings**

- of the **2019 ACM Conference on Recommender Systems (RecSys 2019)**. [S.l.: s.n.], 2019.
- LUDEWIG, M.; MAURO, N.; LATIFI, S.; JANNACH, D. Performance comparison of neural and non-neural approaches to session-based recommendation. In: **Proceedings of the 2019 ACM Conference on Recommender Systems (RecSys 2019). Copenhagen**. [S.l.: s.n.], 2019.
- LUDMANN, C. A. Recommending news articles in the clef news recommendation evaluation lab with the data stream management system odysseus. In: **Working notes of the Conference and Labs of the Evaluation Forum (CLEF'17)**. [S.l.: s.n.], 2017.
- MA, H.; LIU, X.; SHEN, Z. User fatigue in online news recommendation. In: **Proceedings of the 25th International Conference on World Wide Web (WWW'16)**. [S.l.: s.n.], 2016. p. 1363–1372.
- MA, H.; ZHOU, D.; LIU, C.; LYU, M. R.; KING, I. Recommender systems with social regularization. In: **Proceedings of the fourth ACM International Conference on Web Search and Data Mining**. [S.l.: s.n.], 2011. p. 287–296.
- MAAS, A. L.; HANNUN, A. Y.; NG, A. Y. Rectifier nonlinearities improve neural network acoustic models. In: **Proceedings of the 30th International Conference on Machine Learning (ICML'13)**. [S.l.: s.n.], 2013. v. 30, p. 3–9.
- MAKSAI, A.; GARCIN, F.; FALTINGS, B. Predicting online performance of news recommender systems through richer evaluation metrics. In: **Proceedings of the 9th ACM Conference on Recommender Systems (RecSys'15)**. [S.l.: s.n.], 2015. p. 179–186.
- MALAN, R.; BREDEMEYER, D. **Meta-Architecture**. [S.l.]: Bredemeyer Consulting, April 2004.
<http://www.bredemeyer.com/ArchitectingProcess/MetaArchitecture.htm>.
- MCAULEY, J.; TARGETT, C.; SHI, Q.; HENGEL, A. V. D. Image-based recommendations on styles and substitutes. In: **Proceedings of the 38th International Conference on Research and Development in Information Retrieval (ACM SIGIR'15)**. [S.l.: s.n.], 2015. p. 43–52.
- MEDO, M.; ZHANG, Y.-C.; ZHOU, T. Adaptive model for recommendation of news. **EPL (Europhysics Letters)**, IOP Publishing, v. 88, n. 3, p. 38005, 2009.
- MELVILLE, P.; MOONEY, R. J.; NAGARAJAN, R. Content-boosted collaborative filtering for improved recommendations. In: **Proceedings of the AAAI/IAAI'02**. [S.l.: s.n.], 2002. p. 187–192.
- MENG, F.; LU, Z.; WANG, M.; LI, H.; JIANG, W.; LIU, Q. Encoding source language with convolutional neural network for machine translation. **arXiv preprint arXiv:1503.01838**, 2015.
- MIKOLOV, T.; KARAFIÁT, M.; BURGET, L.; CERNOCKÝ, J.; KHUDANPUR, S. Recurrent neural network based language model. In: **Proceedings of the Interspeech'10**. [S.l.: s.n.], 2010. v. 2, p. 3.

- MIKOLOV, T.; KARAFIÁT, M.; BURGET, L.; CERNOCKÝ, J.; KHUDANPUR, S. Recurrent neural network based language model. In: **Proceedings of the Interspeech'10**. [S.l.: s.n.], 2010. v. 2, p. 3.
- MIKOLOV, T.; SUTSKEVER, I.; CHEN, K.; CORRADO, G. S.; DEAN, J. Distributed representations of words and phrases and their compositionality. In: **Proceedings of the Advances in neural information processing systems (NIPS'13)**. [S.l.: s.n.], 2013. p. 3111–3119.
- MIKOLOV, T.; SUTSKEVER, I.; CHEN, K.; CORRADO, G. S.; DEAN, J. Distributed representations of words and phrases and their compositionality. In: **Proceedings of the Advances in neural information processing systems (NIPS'13)**. [S.l.: s.n.], 2013. p. 3111–3119.
- MISHRA, S. K.; REDDY, M. A bottom-up approach to job recommendation system. In: **Proceedings of the Recommender Systems Challenge at ACM RecSys'16**. [S.l.: s.n.], 2016. p. 4.
- MIYAHARA, K.; PAZZANI, M. J. Collaborative filtering with the simple bayesian classifier. In: **Proceedings of the Pacific Rim International Conference on Artificial Intelligence**. [S.l.: s.n.], 2000. p. 679–689.
- MNIH, A.; SALAKHUTDINOV, R. R. Probabilistic matrix factorization. In: **Proceedings of the Advances in neural information processing systems (NIPS'08)**. [S.l.: s.n.], 2008. p. 1257–1264.
- MOHALLICK, I.; ÖZGÖBEK, Ö. Exploring privacy concerns in news recommender systems. In: **Proceedings of the International Conference on Web Intelligence (WI'17)**. [S.l.: s.n.], 2017. p. 1054–1061.
- MONTES-GARCÍA, A.; ÁLVAREZ-RODRÍGUEZ, J. M.; LABRA-GAYO, J. E.; MARTÍNEZ-MERINO, M. Towards a journalist-based news recommendation system: The wesomender approach. **Expert Systems with Applications**, Elsevier, v. 40, n. 17, p. 6735–6741, 2013.
- MOREIRA, G. d. S. P. Chameleon: A deep learning meta-architecture for news recommender systems. In: **Proceedings of the Doctoral Symposium at 12th ACM Conference on Recommender Systems (RecSys'18)**. [S.l.: s.n.], 2018. p. 578–583.
- MOREIRA, G. d. S. P.; FERREIRA, F.; CUNHA, A. M. d. News session-based recommendations using deep neural networks. In: **Proceedings of the 3rd Workshop on Deep Learning for Recommender Systems (DLRS) at ACM RecSys'18**. [S.l.: s.n.], 2018. p. 15–23.
- MOREIRA, G. D. S. P.; JANNACH, D.; CUNHA, A. M. da. Contextual hybrid session-based news recommendation with recurrent neural networks. **IEEE Access**, p. 1–1, 2019. ISSN 2169-3536.
- MOREIRA, G. D. S. P.; JANNACH, D.; CUNHA, A. M. da. On the importance of news content representation in hybrid neural session-based recommender systems. In: **Proceedings of the 7th International Workshop on News Recommendation and Analytics (INRA 2019) @ RecSys 2019**. [S.l.]: [SI]: CEUR, 2019.

- MOREIRA, G. d. S. P.; SOUZA, G. A recommender system to tackle enterprise collaboration. In: **Proceedings of the 10th ACM Conference on Recommender Systems (RecSys'16)**. [S.l.: s.n.], 2016. p. 395–396.
- MOREIRA, G. d. S. P.; SOUZA, G. A. de; CUNHA, A. M. da. Comparing offline and online recommender system evaluations on long-tail distributions. In: **Proceedings of the RecSys'15 Posters**. [S.l.: s.n.], 2015.
- MUHAMMAD, K.; LAWLOR, A.; RAFTER, R.; SMYTH, B. Great explanations: Opinionated explanations for recommendations. In: **Proceedings of the International Conference on Case-Based Reasoning**. [S.l.: s.n.], 2015. p. 244–258.
- MURAKAMI, T.; MORI, K.; ORIHARA, R. Metrics for evaluating the serendipity of recommendation lists. In: **Proceedings of the Annual Conference of the Japanese Society for Artificial Intelligence**. [S.l.: s.n.], 2007. p. 40–46.
- NAKATSUJI, M.; FUJIWARA, Y.; TANAKA, A.; UCHIYAMA, T.; FUJIMURA, K.; ISHIDA, T. Classical music for rock fans?: novel recommendations for expanding user interests. In: **Proceedings of the 19th ACM International Conference on Information and Knowledge Management**. [S.l.: s.n.], 2010. p. 949–958.
- NEDELEC, T.; SMIRNOVA, E.; VASILE, F. Specializing joint representations for the task of product recommendation. In: **Proceedings of the 2st Workshop on Deep Learning for Recommender Systems at ACM RecSys'17**. [S.l.: s.n.], 2017.
- NIITANI, Y.; OGAWA, T.; SAITO, S.; SAITO, M. Chainrcv: a library for deep learning in computer vision. **arXiv preprint arXiv:1708.08169**, 2017.
- NIKOLENKO, S. Svd-lda: Topic modeling for full-text recommender systems. In: **Proceedings of the Mexican International Conference on Artificial Intelligence**. [S.l.: s.n.], 2015. p. 67–79.
- NING, X.; KARYPIS, G. Slim: Sparse linear methods for top-n recommender systems. In: **Proceedings of the IEEE 11th International Conference on Data Mining (ICDM'11)**. [S.l.: s.n.], 2011. p. 497–506.
- NIU, W.; CAVERLEE, J.; LU, H. Neural personalized ranking for image recommendation. In: ACM. **Proceedings of the Eleventh ACM International Conference on Web Search and Data Mining**. [S.l.], 2018. p. 423–431.
- NOIA, T. D.; ROSATI, J.; TOMEO, P.; SCIASCIO, E. D. Adaptive multi-attribute diversity for recommender systems. **Information Sciences**, Elsevier, v. 382, p. 234–253, 2017.
- OKURA, S.; TAGAMI, Y.; ONO, S.; TAJIMA, A. Embedding-based news recommendation for millions of users. In: ACM. **Proceedings of the 23rd ACM SIGKDD International Conference on Knowledge Discovery and Data Mining**. [S.l.], 2017. p. 1933–1942.
- OORD, A. Van den; DIELEMAN, S.; SCHRAUWEN, B. Deep content-based music recommendation. In: **Proceedings of the Advances in neural information processing systems (NIPS'13)**. [S.l.: s.n.], 2013. p. 2643–2651.

- ÖZGÖBEK, Ö.; GULLA, J. A.; ERDUR, R. C. A survey on challenges and methods in news recommendation. In: **Proceedings of the WEBIST'14**. [S.l.: s.n.], 2014. p. 278–285.
- PAIXÃO, C. Z. F. **Assessing and improving recommender systems to deal with user cold-start problem**. 2017. 113 f. Tese (Doutorado em Ciência da Computação) — Universidade Federal de Uberlândia, 2017. Disponível em: <<https://repositorio.ufu.br/handle/123456789/18778>>.
- PAN, R.; ZHOU, Y.; CAO, B.; LIU, N. N.; LUKOSE, R.; SCHOLZ, M.; YANG, Q. One-class collaborative filtering. In: **Proceedings of the Eighth IEEE International Conference on Data Mining (ICDM'08)**. [S.l.: s.n.], 2008. p. 502–511.
- PARK, K.; LEE, J.; CHOI, J. Deep neural networks for news recommendations. In: ACM. **Proceedings of the 2017 ACM on Conference on Information and Knowledge Management**. [S.l.], 2017. p. 2255–2258.
- PARK, S.; KIM, Y.-D.; CHOI, S. Hierarchical bayesian matrix factorization with side information. In: **Proceedings of the IJCAI'13**. [S.l.: s.n.], 2013. p. 1593–1599.
- PELÁEZ, J. D.; REGO, D. M.; BETANZOS, A. A.; RODRÍGUEZ, Ó. L.; RIONDA, A. B. Metrical representation of readers and articles in a digital newspaper. In: **Proceedings of the 10th ACM Conference on Recommender Systems (RecSys 2016)**. [S.l.: s.n.], 2016.
- PENNINGTON, J.; SOCHER, R.; MANNING, C. Glove: Global vectors for word representation. In: **Proceedings of the 2014 Conference on Empirical Methods in Natural Language Processing (EMNLP'14)**. [S.l.: s.n.], 2014. p. 1532–1543.
- PON, R. K.; CARDENAS, A. F.; BUTTLER, D.; CRITCHLOW, T. Tracking multiple topics for finding interesting articles. In: **Proceedings of the 13th ACM SIGKDD International Conference on Knowledge Discovery and Data Mining (KDD'17)**. [S.l.: s.n.], 2007. p. 560–569.
- PORTEOUS, I.; ASUNCION, A. U.; WELLING, M. Bayesian matrix factorization with side information and dirichlet process mixtures. In: **Proceedings of the AAI'10**. [S.l.: s.n.], 2010.
- PU, P.; CHEN, L. Trust building with explanation interfaces. In: **Proceedings of the 11th International Conference on Intelligent User Interfaces**. [S.l.: s.n.], 2006. p. 93–100.
- PU, P.; CHEN, L. Trust-inspiring explanation interfaces for recommender systems. **Knowledge-Based Systems**, Elsevier, v. 20, n. 6, p. 542–556, 2007.
- PU, P.; CHEN, L.; HU, R. A user-centric evaluation framework for recommender systems. In: **Proceedings of the fifth ACM Conference on Recommender Systems (RecSys'11)**. [S.l.: s.n.], 2011. p. 157–164.
- QUADRANA, M.; CREMONESI, P.; JANNACH, D. Sequence-aware recommender systems. **ACM Computing Surveys (CSUR)**, ACM, v. 51, n. 4, p. 66, 2018.

- QUADRANA, M.; KARATZOGLOU, A.; HIDASI, B.; CREMONESI, P. Personalizing session-based recommendations with hierarchical recurrent neural networks. In: **Proceedings of the 11th ACM Conference on Recommender Systems (RecSys'17)**. [S.l.: s.n.], 2017.
- RAHIMI, R.; MONTAZERALGHAEM, A.; ALLAN, J. Listwise neural ranking models. In: **ACM. Proceedings of the 2019 ACM SIGIR International Conference on Theory of Information Retrieval**. [S.l.], 2019. p. 101–104.
- RAMOS, J. *et al.* Using tf-idf to determine word relevance in document queries. In: **Proceedings of the 1st Instructional Conference on Machine Learning**. [S.l.: s.n.], 2003. v. 242, p. 133–142.
- RAO, J.; JIA, A.; FENG, Y.; ZHAO, D. Personalized news recommendation using ontologies harvested from the web. In: **International Conference on Web-Age Information Management**. [S.l.: s.n.], 2013. p. 781–787.
- RAO, J.; JIA, A.; FENG, Y.; ZHAO, D. Taxonomy based personalized news recommendation: Novelty and diversity. In: **Proceedings of the International Conference on Web Information Systems Engineering**. [S.l.: s.n.], 2013. p. 209–218.
- REN, H.; FENG, W. Concert: A concept-centric web news recommendation system. In: **Proceedings of the International Conference on Web-Age Information Management**. [S.l.: s.n.], 2013. p. 796–798.
- RENDLE, S.; FREUDENTHALER, C.; GANTNER, Z.; SCHMIDT-THIEME, L. Bpr: Bayesian personalized ranking from implicit feedback. In: **Proceedings of the 25th Conference on Uncertainty in Artificial Intelligence**. [S.l.: s.n.], 2009. p. 452–461.
- RENDLE, S.; FREUDENTHALER, C.; SCHMIDT-THIEME, L. Factorizing personalized markov chains for next-basket recommendation. In: **Proceedings of the 19th International Conference on World Wide Web (WWW'10)**. [S.l.: s.n.], 2010. p. 811–820.
- RESNICK, P. An open architecture for collaborative filtering of netnews. In: **Proc. of CSCW'94**. [S.l.: s.n.], 1994. p. 175–186.
- RICCI, F.; ROKACH, L.; SHAPIRA, B.; KANTOR, P. B. **Recommender systems handbook**. [S.l.]: Springer, 2011.
- RODRIGUEZ, M.; POSSE, C.; ZHANG, E. Multiple objective optimization in recommender systems. In: **Proceedings of the sixth ACM Conference on Recommender Systems (RecSys'12)**. [S.l.: s.n.], 2012. p. 11–18.
- RUDER, S. An overview of multi-task learning in deep neural networks. **arXiv preprint arXiv:1706.05098**, 2017.
- RUMELHART, D. E.; HINTON, G. E.; WILLIAMS, R. J. *et al.* Learning representations by back-propagating errors. **Cognitive modeling**, v. 5, n. 3, p. 1, 1988.

- RUOCCO, M.; SKREDE, O. S. L.; LANGSETH, H. Inter-session modeling for session-based recommendation. In: **Proceedings of the 2nd Workshop on Deep Learning for Recommender Systems at ACM RecSys'17**. [S.l.: s.n.], 2017. p. 24–31.
- SAIA, R.; BORATTO, L.; CARTA, S. Semantic coherence-based user profile modeling in the recommender systems context. In: **Proceedings of the International Conference on Knowledge Discovery and Information Retrieval (KDIR 2014)**. [S.l.: s.n.], 2014. p. 154–161.
- SAIA, R.; BORATTO, L.; CARTA, S. A semantic approach to remove incoherent items from a user profile and improve the accuracy of a recommender system. **Journal of Intelligent Information Systems**, v. 47, p. 111–134, 03 2016.
- SAID, A.; BELLOGÍN, A. Coherence and inconsistencies in rating behavior: Estimating the magic barrier of recommender systems. **User Modeling and User-Adapted Interaction**, v. 28, n. 2, p. 97–125, 2018.
- SAID, A.; LIN, J.; BELLOGÍN, A.; VRIES, A. de. A month in the life of a production news recommender system. In: **Proceedings of the 2013 Workshop on Living labs for Information Retrieval Evaluation**. [S.l.: s.n.], 2013. p. 7–10.
- SALAKHUTDINOV, R.; MNIH, A. Bayesian probabilistic matrix factorization using markov chain monte carlo. In: **Proceedings of the 25th International Conference on Machine Learning (ICML'08)**. [S.l.: s.n.], 2008. p. 880–887.
- SALAKHUTDINOV, R.; MNIH, A.; HINTON, G. Restricted boltzmann machines for collaborative filtering. In: **Proceedings of the 24th International Conference on Machine learning**. [S.l.: s.n.], 2007. p. 791–798.
- SALTON, G.; BUCKLEY, C. Term-weighting approaches in automatic text retrieval. **Information Processing & Management**, Elsevier, v. 24, n. 5, p. 513–523, 1988.
- SANTOS, C. N. d.; XIANG, B.; ZHOU, B. Classifying relations by ranking with convolutional neural networks. **arXiv preprint arXiv:1504.06580**, 2015.
- SARANYA, K.; SADHASIVAM, G. S. A personalized online news recommendation system. **International Journal of Computer Applications**, Citeseer, v. 57, n. 18, 2012.
- SARWAR, B.; KARYPIS, G.; KONSTAN, J.; RIEDL, J. Item-based collaborative filtering recommendation algorithms. In: **Proceedings of the 10th International Conference on World Wide Web (WWW'01)**. [S.l.: s.n.], 2001. p. 285–295.
- SCARSELLI, F.; GORI, M.; TSOI, A. C.; HAGENBUCHNER, M.; MONFARDINI, G. The graph neural network model. **IEEE Transactions on Neural Networks**, IEEE, v. 20, n. 1, p. 61–80, 2008.
- SCHEIN, A. I.; POPESCU, A.; UNGAR, L. H.; PENNOCK, D. M. Methods and metrics for cold-start recommendations. In: **Proceedings of the 25th annual International Conference on Research and Development in Information Retrieval (ACM SIGIR'12)**. [S.l.: s.n.], 2002. p. 253–260.

- SCHUSTER, M.; PALIWAL, K. K. Bidirectional recurrent neural networks. **IEEE Transactions on Signal Processing**, IEEE, v. 45, n. 11, p. 2673–2681, 1997.
- SEDHAIN, S.; MENON, A. K.; SANNER, S.; XIE, L. Autorec: Autoencoders meet collaborative filtering. In: **Proceedings of the 24th International Conference on World Wide Web (WWW'15)**. [S.l.: s.n.], 2015. p. 111–112.
- SELA, M.; LAVIE, T.; INBAR, O.; OPPENHEIM, I.; MEYER, J. Personalizing news content: An experimental study. **Journal of the Association for Information Science and Technology**, Wiley Online Library, v. 66, n. 1, p. 1–12, 2015.
- SEO, S.; HUANG, J.; YANG, H.; LIU, Y. Interpretable convolutional neural networks with dual local and global attention for review rating prediction. In: **Proceedings of the Eleventh ACM Conference on Recommender Systems (RecSys'17)**. [S.l.: s.n.], 2017. p. 297–305.
- SHANI, G.; GUNAWARDANA, A. Evaluating recommendation systems. In: RICCI L. ROKACH, B. S. F.; KANTOR, P. B. (Ed.). **Recommender Systems Handbook**. Springer, 2010. p. 257–297. Disponível em:
<http://dx.doi.org/10.1007/978-3-540-72079-9_11>.
- SHEN, B.; SU, X.; GREINER, R.; MUSILEK, P.; CHENG, C. Discriminative parameter learning of general bayesian network classifiers. In: **Proceedings of the 15th IEEE International Conference on Tools with Artificial Intelligence**. [S.l.: s.n.], 2003. p. 296–305.
- SHEN, Y.; HE, X.; GAO, J.; DENG, L.; MESNIL, G. A latent semantic model with convolutional-pooling structure for information retrieval. In: **Proceedings of the 23rd ACM International Conference on Information and Knowledge Management**. [S.l.: s.n.], 2014. p. 101–110.
- SHI, J.; WANG, N.; XIA, Y.; YEUNG, D.-Y.; KING, I.; JIA, J. Scmf: Sparse covariance matrix factorization for collaborative filtering. In: **Proceedings of the IJCAI'13**. [S.l.: s.n.], 2013. p. 2705–2711.
- SHI, Y.; KARATZOGLOU, A.; BALTRUNAS, L.; LARSON, M.; OLIVER, N.; HANJALIC, A. Climf: learning to maximize reciprocal rank with collaborative less-is-more filtering. In: **Proceedings of the sixth ACM Conference on Recommender Systems (RecSys'12)**. [S.l.: s.n.], 2012. p. 139–146.
- SIMONYAN, K.; ZISSERMAN, A. Very deep convolutional networks for large-scale image recognition. **arXiv preprint arXiv:1409.1556**, 2014.
- SINHA, R.; SWEARINGEN, K. The role of transparency in recommender systems. In: **Proceedings of the Eighth IEEE International Conference on the Human factors in computing systems (CHI'02)**. [S.l.: s.n.], 2002. p. 830–831.
- SKREDE, O. S. L. **Inter-/Intra-session Recurrent Neural Network for Session-based Recommender Systems**. Dissertaçãõ 1/2õ 1/2õ (Mestrado) — NTNU, 2017.

- SMIRNOVA, E.; VASILE, F. Contextual sequence modeling for recommendation with recurrent neural networks. In: **Proceedings of the 11th ACM Conference on Recommender Systems (RecSys'17)**. [S.l.: s.n.], 2017. p. 2–9.
- SMITH, B.; LINDEN, G. Two decades of recommender systems at amazon. com. **IEEE Internet Computing**, IEEE, v. 21, n. 3, p. 12–18, 2017.
- SONG, B.; YANG, X.; CAO, Y.; XU, C. Neural collaborative ranking. In: **ACM. Proceedings of the 27th ACM International Conference on Information and Knowledge Management**. [S.l.], 2018. p. 1353–1362.
- SONG, Y.; ELKAHKY, A. M.; HE, X. Multi-rate deep learning for temporal recommendation. In: **Proceedings of the 39th International Conference on Research and Development in Information Retrieval (SIGIR'16)**. [S.l.: s.n.], 2016. p. 909–912.
- SONG, Y.; ZHANG, L.; GILES, C. L. Automatic tag recommendation algorithms for social recommender systems. **ACM Transactions on the Web (TWEB)**, ACM, v. 5, n. 1, p. 4, 2011.
- SPANGHER, A. **Building the Next New York Times Recommendation Engine**. [S.l.]: New York Times blog, Aug 2015. <https://open.blogs.nytimes.com/2015/08/11/building-the-next-new-york-times-recommendation-engine/>.
- SRIVASTAVA, N.; MANSIMOV, E.; SALAKHUDINOV, R. Unsupervised learning of video representations using lstms. In: **International conference on machine learning**. [S.l.: s.n.], 2015. p. 843–852.
- STRUB, F.; MARY, J. Collaborative filtering with stacked denoising autoencoders and sparse inputs. In: **NIPS workshop on machine learning for eCommerce**. [S.l.: s.n.], 2015.
- SUN, S. A survey of multi-view machine learning. **Neural Computing and Applications**, Springer, v. 23, n. 7-8, p. 2031–2038, 2013.
- SUTSKEVER, I.; VINYALS, O.; LE, Q. V. Sequence to sequence learning with neural networks. In: **Proceedings of Advances in neural information processing systems (NIPS'14)**. [S.l.: s.n.], 2014. p. 3104–3112.
- SZEGEDY, C.; LIU, W.; JIA, Y.; SERMANET, P.; REED, S.; ANGUELOV, D.; ERHAN, D.; VANHOUCHE, V.; RABINOVICH, A. Going deeper with convolutions. In: **Proceedings of the IEEE Conference on Computer Vision and Pattern Recognition (CVPR'15)**. [S.l.: s.n.], 2015. p. 1–9.
- SZEGEDY, C.; VANHOUCHE, V.; IOFFE, S.; SHLENS, J.; WOJNA, Z. Rethinking the inception architecture for computer vision. In: **Proceedings of the IEEE Conference on Computer Vision and Pattern Recognition (CVPR'16)**. [S.l.: s.n.], 2016. p. 2818–2826.
- TAMIR, I.; BASS, R.; KOBRINSKY, G.; BRUTMAN, B.; LEMPEL, R.; DAYAGI, Y. Powering content discovery through scalable, realtime profiling of users' content preferences. In: **Proceedings of the 10th ACM Conference on Recommender Systems**. [S.l.: s.n.], 2016. (RecSys '16), p. 399–400.

- TAN, Y. K.; XU, X.; LIU, Y. Improved recurrent neural networks for session-based recommendations. In: **Proceedings of the 1st Workshop on Deep Learning for Recommender Systems at ACM RecSys'16**. [S.l.: s.n.], 2016. p. 17–22.
- TAVAKOLIFARD, M.; GULLA, J. A.; ALMERTH, K. C.; INGVALDESN, J. E.; NYGREEN, G.; BERG, E. Tailored news in the palm of your hand: a multi-perspective transparent approach to news recommendation. In: **Proceedings of the 22nd International Conference on World Wide Web (WWW'13)**. [S.l.: s.n.], 2013. p. 305–308.
- TAY, Y.; LUU, A. T.; HUI, S. C. Multi-pointer co-attention networks for recommendation. In: **ACM. Proceedings of the 24th ACM SIGKDD International Conference on Knowledge Discovery & Data Mining**. [S.l.], 2018. p. 2309–2318.
- THORAT, P. B.; GOUDAR, R.; BARVE, S. Survey on collaborative filtering, content-based filtering and hybrid recommendation system. **International Journal of Computer Applications**, Foundation of Computer Science, v. 110, n. 4, 2015.
- TRAN, D.; BOURDEV, L.; FERGUS, R.; TORRESANI, L.; PALURI, M. Learning spatiotemporal features with 3d convolutional networks. In: **Proceedings of the IEEE International Conference on Computer Vision**. [S.l.: s.n.], 2015. p. 4489–4497.
- TREVISIOL, M.; AIELLO, L. M.; SCHIFANELLA, R.; JAIMES, A. Cold-start news recommendation with domain-dependent browse graph. In: **Proceedings of the 8th ACM Conference on Recommender systems (RecSys'14)**. [S.l.: s.n.], 2014. p. 81–88.
- TUAN, T. X.; PHUONG, T. M. 3d convolutional networks for session-based recommendation with content features. In: **Proceedings of the Eleventh ACM Conference on Recommender Systems (RecSys'17)**. [S.l.: s.n.], 2017. p. 138–146.
- TURIAN, J.; RATINOV, L.; BENGIO, Y. Word representations: a simple and general method for semi-supervised learning. In: **Proceedings of the 48th annual meeting of the association for computational linguistics**. [S.l.: s.n.], 2010. p. 384–394.
- TURIAN, J.; RATINOV, L.; BENGIO, Y.; ROTH, D. A preliminary evaluation of word representations for named-entity recognition. In: **Proceedings of the Workshop on Grammar Induction, Representation of Language and Language Learning at NIPS**. [S.l.: s.n.], 2009. p. 1–8.
- TWARDOWSKI, B. Modelling contextual information in session-aware recommender systems with neural networks. In: **Proceedings of the 10th ACM Conference on Recommender Systems (RecSys'16)**. [S.l.: s.n.], 2016. p. 273–276.
- VAPNIK, V.; VASHIST, A. A new learning paradigm: Learning using privileged information. **Neural networks**, Elsevier, v. 22, n. 5, p. 544–557, 2009.
- VARGAS, S. **Novelty and Diversity Evaluation and Enhancement in Recommender Systems**. 2015. Tese (PhD thesis) — Universidad Autónoma de Madrid, 2015.

- VARGAS, S.; CASTELLS, P. Rank and relevance in novelty and diversity metrics for recommender systems. In: **Proceedings of the fifth ACM Conference on Recommender Systems (RecSys'11)**. [S.l.: s.n.], 2011. p. 109–116.
- VASILE, F.; SMIRNOVA, E.; CONNEAU, A. Meta-prod2vec: Product embeddings using side-information for recommendation. In: **Proceedings of the 10th ACM Conference on Recommender Systems (RecSys'16)**. [S.l.: s.n.], 2016. p. 225–232.
- VINAGRE, J.; JORGE, A. M.; GAMA, J. An overview on the exploitation of time in collaborative filtering. **Wiley Interdisciplinary Reviews: Data Mining and Knowledge Discovery**, Wiley Online Library, v. 5, n. 5, p. 195–215, 2015.
- VINCENT, P.; LAROCHELLE, H.; BENGIO, Y.; MANZAGOL, P.-A. Extracting and composing robust features with denoising autoencoders. In: **Proceedings of the 25th International Conference on Machine Learning (ICML'08)**. [S.l.: s.n.], 2008. p. 1096–1103.
- VINCENT, P.; LAROCHELLE, H.; LAJOIE, I.; BENGIO, Y.; MANZAGOL, P.-A. Stacked denoising autoencoders: Learning useful representations in a deep network with a local denoising criterion. **Journal of Machine Learning Research**, v. 11, n. Dec, p. 3371–3408, 2010.
- WANG, C.; BLEI, D. M. Collaborative topic modeling for recommending scientific articles. In: **Proceedings of the 17th ACM SIGKDD International Conference on Knowledge Discovery and Data Mining (KDD'11)**. [S.l.: s.n.], 2011. p. 448–456.
- WANG, H.; WANG, N.; YEUNG, D.-Y. Collaborative deep learning for recommender systems. In: **Proceedings of the 21th ACM SIGKDD International Conference on Knowledge Discovery and Data Mining (KDD'15)**. [S.l.: s.n.], 2015. p. 1235–1244.
- WANG, H.; XINGJIAN, S.; YEUNG, D.-Y. Collaborative recurrent autoencoder: Recommend while learning to fill in the blanks. In: **Proceedings of the Advances in Neural Information Processing Systems (NIPS'16)**. [S.l.: s.n.], 2016. p. 415–423.
- WANG, H.; ZHANG, F.; XIE, X.; GUO, M. Dkn: Deep knowledge-aware network for news recommendation. In: INTERNATIONAL WORLD WIDE WEB CONFERENCES STEERING COMMITTEE. **Proceedings of the 2018 World Wide Web Conference**. [S.l.], 2018. p. 1835–1844.
- WANG, P.; GUO, J.; LAN, Y.; XU, J.; WAN, S.; CHENG, X. Learning hierarchical representation model for next basket recommendation. In: **Proceedings of the 38th International Conference on Research and Development in Information Retrieval (SIGIR'15)**. [S.l.: s.n.], 2015. p. 403–412.
- WANG, X.; HE, X.; NIE, L.; CHUA, T.-S. Item silk road: Recommending items from information domains to social users. In: ACM. **Proceedings of the 40th International ACM SIGIR conference on Research and Development in Information Retrieval**. [S.l.], 2017. p. 185–194.

- WANG, X.; WANG, Y. Improving content-based and hybrid music recommendation using deep learning. In: **Proceedings of the 22nd ACM International Conference on Multimedia**. [S.l.: s.n.], 2014. p. 627–636.
- WERBOS, P. J. Backpropagation through time: what it does and how to do it. **Proceedings of the IEEE**, IEEE, v. 78, n. 10, p. 1550–1560, 1990.
- WESTON, J.; BENGIO, S.; USUNIER, N. Wsabie: Scaling up to large vocabulary image annotation. In: **Proceedings of the IJCAI'11**. [S.l.: s.n.], 2011. v. 11, p. 2764–2770.
- WILLIAMS, R. J.; ZIPSER, D. Gradient-based learning algorithms for recurrent networks and their computational complexity. **Backpropagation: Theory, architectures, and applications**, Lawrence Erlbaum Publ, v. 1, p. 433–486, 1995.
- WU, C.; WANG, J.; LIU, J.; LIU, W. Recurrent neural network based recommendation for time heterogeneous feedback. **Knowledge-Based Systems**, Elsevier, v. 109, p. 90–103, 2016.
- WU, C.-Y.; AHMED, A.; BEUTEL, A.; SMOLA, A. J.; JING, H. Recurrent recommender networks. In: **Proceedings of the Tenth ACM International Conference on Web Search and Data Mining**. [S.l.: s.n.], 2017. p. 495–503.
- WU, S.; TANG, Y.; ZHU, Y.; WANG, L.; XIE, X.; TAN, T. Session-based recommendation with graph neural networks. In: **Proceedings of the AAAI Conference on Artificial Intelligence**. [S.l.: s.n.], 2019. v. 33, p. 346–353.
- WU, Y.; DUBOIS, C.; ZHENG, A. X.; ESTER, M. Collaborative denoising auto-encoders for top-n recommender systems. In: **Proceedings of the Ninth ACM International Conference on Web Search and Data Mining**. [S.l.: s.n.], 2016. p. 153–162.
- XIAO, J.; YE, H.; HE, X.; ZHANG, H.; WU, F.; CHUA, T.-S. Attentional factorization machines: Learning the weight of feature interactions via attention networks. **arXiv preprint arXiv:1708.04617**, 2017.
- XU, C.; TAO, D.; XU, C. A survey on multi-view learning. **arXiv preprint arXiv:1304.5634**, 2013.
- XU, M.; ZHU, J.; ZHANG, B. Fast max-margin matrix factorization with data augmentation. In: **Proceedings of the International Conference on Machine Learning (ICML'13)**. [S.l.: s.n.], 2013. p. 978–986.
- XUE, H.-J.; DAI, X.; ZHANG, J.; HUANG, S.; CHEN, J. Deep matrix factorization models for recommender systems. In: **IJCAI**. [S.l.: s.n.], 2017. p. 3203–3209.
- YEUNG, K. F.; YANG, Y.; NDZI, D. Context-aware news recommender in mobile hybrid p2p network. In: **Proceedings of the 2010 Second International Conference on Computational Intelligence, Communication Systems and Networks (CICSyN'10)**. [S.l.: s.n.], 2010. p. 54–59.
- YIH, S. W.-t.; HE, X.; MEEK, C. Semantic parsing for single-relation question answering. 2014.

- YU, K.; ZHANG, B.; ZHU, H.; CAO, H.; TIAN, J. Towards personalized context-aware recommendation by mining context logs through topic models. **Advances in knowledge discovery and data mining**, Springer, p. 431–443, 2012.
- ZHANG, L.; LIU, P.; GULLA, J. A. A deep joint network for session-based news recommendations with contextual augmentation. In: **ACM. Proceedings of the 29th on Hypertext and Social Media**. [S.l.], 2018. p. 201–209.
- ZHANG, M.; HURLEY, N. Avoiding monotony: improving the diversity of recommendation lists. In: **Proceedings of the 2008 ACM Conference on Recommender systems (RecSys'08)**. [S.l.: s.n.], 2008. p. 123–130.
- ZHANG, R.; LIU, Q.-d.; GUI, C.; WEI, J.-X.; MA, H. Collaborative filtering for recommender systems. In: **Proceedings of the Advanced Cloud and Big Data (CBD), 2014 Second International Conference on**. [S.l.: s.n.], 2014. p. 301–308.
- ZHANG, S.; YAO, L.; SUN, A.; WANG, S.; LONG, G.; DONG, M. Neurec: On nonlinear transformation for personalized ranking. **arXiv preprint arXiv:1805.03002**, 2018.
- ZHANG, S.; YAO, L.; SUN, A.; TAY, Y. Deep learning based recommender system: A survey and new perspectives. **ACM Computing Surveys (CSUR)**, ACM, v. 52, n. 1, p. 5, 2019.
- ZHANG, Y.; CALLAN, J.; MINKA, T. Novelty and redundancy detection in adaptive filtering. In: **Proceedings of the 25th annual International Conference on Research and Development in Information Retrieval (SIGIR'02)**. [S.l.: s.n.], 2002. p. 81–88.
- ZHAO, J.; XIE, X.; XU, X.; SUN, S. Multi-view learning overview: Recent progress and new challenges. **Information Fusion**, Elsevier, v. 38, p. 43–54, 2017.
- ZHAO, T.; MCAULEY, J.; KING, I. Leveraging social connections to improve personalized ranking for collaborative filtering. In: **Proceedings of the 23rd ACM International Conference on Conference on Information and Knowledge Management**. [S.l.: s.n.], 2014. p. 261–270.
- ZHENG, G.; ZHANG, F.; ZHENG, Z.; XIANG, Y.; YUAN, N. J.; XIE, X.; LI, Z. Drn: A deep reinforcement learning framework for news recommendation. In: **Proceedings of the 2018 World Wide Web Conference**. [S.l.: s.n.], 2018. (WWW '18), p. 167–176.
- ZHENG, L. A survey and critique of deep learning on recommender systems. 2016.
- ZHENG, L.; LI, L.; HONG, W.; LI, T. Penetrate: Personalized news recommendation using ensemble hierarchical clustering. **Expert Systems with Applications**, Elsevier, v. 40, n. 6, p. 2127–2136, 2013.
- ZHENG, L.; NOROOZI, V.; YU, P. S. Joint deep modeling of users and items using reviews for recommendation. In: **Proceedings of the Tenth ACM International Conference on Web Search and Data Mining**. [S.l.: s.n.], 2017. p. 425–434.

ZHOU, T.; KUSCSIK, Z.; LIU, J.-G.; MEDO, M.; WAKELING, J. R.; ZHANG, Y.-C. Solving the apparent diversity-accuracy dilemma of recommender systems.

Proceedings of the National Academy of Sciences, National Acad Sciences, v. 107, n. 10, p. 4511–4515, 2010.

ZIEGLER, C.-N.; MCNEE, S. M.; KONSTAN, J. A.; LAUSEN, G. Improving recommendation lists through topic diversification. In: **Proceedings of the 14th International Conference on World Wide Web (WWW'05)**. [S.l.: s.n.], 2005. p. 22–32.

ŽLIOBAITĖ, I.; PECHENIZKIY, M.; GAMA, J. An overview of concept drift applications. In: **Big data analysis: new algorithms for a new society**. [S.l.]: Springer, 2016. p. 91–114.

FOLHA DE REGISTRO DO DOCUMENTO

1. CLASSIFICAÇÃO/TIPO TD	2. DATA 17 de dezembro de 2019	3. DOCUMENTO N° DCTA/ITA/TD-035/2019	4. N° DE PÁGINAS 186
5. TÍTULO E SUBTÍTULO: CHAMELEON: A Deep Learning Meta-Architecture for News Recommender Systems			
6. AUTOR(ES): Gabriel de Souza Pereira Moreira			
7. INSTITUIÇÃO(ÕES)/ÓRGÃO(S) INTERNO(S)/DIVISÃO(ÕES): Instituto Tecnológico de Aeronáutica – ITA			
8. PALAVRAS-CHAVE SUGERIDAS PELO AUTOR: Recommender Systems; Deep Learning; News Recommender Systems; Session-based Recommender Systems			
9. PALAVRAS-CHAVE RESULTANTES DE INDEXAÇÃO: Sistemas de recomendação; Notícias; Aprendizagem (inteligência artificial); Redes neurais; Computação.			
10. APRESENTAÇÃO: <input checked="" type="checkbox"/> Nacional <input type="checkbox"/> Internacional ITA, São José dos Campos. Curso de Doutorado. Programa de Pós-Graduação em Engenharia Eletrônica e Computação. Área de Informática. Orientador: Prof. Dr. Adilson Marques da Cunha. Defesa em 09/12/2019. Publicada em 2019.			
11. RESUMO: Recommender Systems (RS) have been increasingly popular in assisting users with their choices, thus enhancing their engagement and overall satisfaction with online services. RS have become a popular research topic and, since 2016, Deep Learning methods and techniques have been increasingly explored in this area. News RS are aimed to personalize users experiences and help them discover relevant articles from a large and dynamic search space. Therefore, it is a challenging scenario for recommendations. Large publishers release hundreds of news daily, implying that they must deal with fast-growing numbers of items that get quickly outdated and irrelevant to most readers. News readers exhibit more unstable consumption behavior than users in other domains such as entertainment. External events, like breaking news, affect readers interests. In addition, the news domain experiences extreme levels of sparsity, as most users are anonymous, with no past behavior tracked. The main contribution of this research was named <i>CHAMELEON</i> , a Deep Learning meta-architecture designed to tackle the specific challenges of news recommendation. It consists of a modular reference architecture which can be instantiated using different neural building blocks. As information about users' past interactions is scarce in the news domain, the user context can be leveraged to deal with the <i>user cold-start problem</i> . Articles' content is also important to tackle the <i>item cold-start problem</i> . Additionally, the temporal decay of items (articles) relevance is very accelerated in the news domain. Furthermore, external breaking events may temporally attract global readership attention, a phenomenon generally known as <i>concept drift</i> in machine learning. All those characteristics are explicitly modeled on this research by a contextual hybrid session-based recommendation approach using Recurrent Neural Networks. The task addressed by this research is session-based news recommendation, i.e., next-click prediction using only information available in the current user session. A method is proposed for a realistic temporal offline evaluation of such task, replaying the stream of user clicks and fresh articles being continuously published in a news portal. Experiments performed with two large datasets have shown the effectiveness of the <i>CHAMELEON</i> for news recommendation on many quality factors such as accuracy, item coverage, novelty, and reduced item cold-start problem, when compared to other traditional and state-of-the-art session-based recommendation algorithms.			
12. GRAU DE SIGILO: <input checked="" type="checkbox"/> OSTENSIVO <input type="checkbox"/> RESERVADO <input type="checkbox"/> SECRETO			