

# contextual: Evaluating Contextual Multi-Armed Bandit Problems in R

**Robin van Emden**  
JADS

**Maurits Kaptein**  
Tilburg University

---

## Abstract

Over the past decade, contextual bandit algorithms have been gaining in popularity due to their effectiveness and flexibility in solving sequential decision problems—from online advertising and finance to clinical trial design and personalized medicine. At the same time, there are, as of yet, surprisingly few options that enable researchers and practitioners to simulate and compare the wealth of new and existing bandit algorithms in a standardized way. To help close this gap between analytical research and empirical evaluation the current paper introduces the object-oriented R package **contextual**: a user-friendly and, through its object-oriented design, easily extensible framework that facilitates parallelized comparison of contextual and context-free bandit policies through both simulation and offline analysis.

*Keywords:* contextual multi-armed bandits, simulation, sequential experimentation, R.

---

## 1. Introduction

There are many real-world situations in which we have to decide between multiple options, yet are only able to learn the best course of action by testing each option sequentially. In such situations, the underlying concept remains the same for each and every renewed decision: Do you stick to what you know and receive an expected result ("exploit") or choose an option you do not know all that much about and potentially learn something new ("explore")? As we all encounter such dilemma's on a daily basis (Wilson, Geana, White, Ludvig, and Cohen 2014), it is easy to come up with examples - for instance:

- When going out to dinner, do you explore new restaurants, or choose a favorite?
- As a website editor, do you place popular or new articles at the top of your frontpage?
- As a doctor, do you prescribe tried and tested medication, or do you also provide promising experimental drugs?
- When visiting a casino, do you stay with the slot machine that just paid out, or do you try some of the other slot machines?

Although people seem to navigate such explore-exploit problems with relative ease, this type of decision problem has proven surprisingly difficult to solve analytically<sup>1</sup> and has been studied extensively

---

<sup>1</sup>As Dr. Peter Whittle famously stated "[the problem] was formulated during the [second world] war, and efforts to solve it so sapped the energies and minds of Allied analysts that the suggestion was made that the problem be dropped over Germany, as the ultimate instrument of intellectual sabotage." (Whittle 1979)

since the 1930s (Robbins 1952; Bubeck, Cesa-Bianchi *et al.* 2012) under the umbrella of the "multi-armed bandit" (MAB) problem. The origin of the name is related to the casino example above: a one armed bandit is an old name for a slot machine in a casino, as they used to have one arm and tended to steal your money. A multi-armed bandit can then be understood as a set of one-armed bandit slot machines in a casino—in that respect, "many one-armed bandits problem" might have been a better fit (Gelman 2018). Just like in the casino example, the crux of a multi-armed bandit problem is that you only receive a reward for the arm you pull—you remain in the dark about what rewards the other arms might have offered. Consequently, you need some strategy or "policy" that helps you balance the exploration and exploitation of arms to optimize your rewards over repeated pulls. One option would, for instance, be to pull every available arm once and from then on exploit the arm that offered you the highest reward. This reward might, however, be nothing more than a lucky fluke. On the other hand, if you decide to keep exploring other arms, you may lose out on the winnings you might have received from the arm that had been doing so well.

This active exploration of information gathered one step at a time makes multi-armed bandit problems a subset of reinforcement learning type problems—together with supervised and unsupervised learning one of three main classes of machine learning. Where supervised algorithms learn mappings from input values to fully specified class labels and unsupervised learning looks for patterns in data without any such labels, reinforcement learning policies live somewhere in between: they are able to make use of labels or "rewards" to minimize their loss—but in contrast to their supervised siblings, this information has to be actively acquired (Jordan and Mitchell 2015). Bandit policies then constitute that subset of reinforcement learning algorithms that either do not take further contextual information into account or, otherwise, assume that their choices do not affect this context (Steenwinckel, De Backere, Nelis, Ongenaes, and De Turck 2018; Sutton and Barto 1998).

Where the latter brings us to a MAB generalization generally known as the *contextual* multi-armed bandit (CMAB) problem. CMAB problems extend on basic "context-free" MABs by adding one crucial element: contextual information (Langford and Zhang 2008). Contextual multi-armed bandits are known by many different names in about as many different fields of research (Tewari and Murphy 2017)—for example as "bandit problems with side observations" (Wang, Kulkarni, and Poor 2005), "bandit problems with side information" (Lu, Pál, and Pál 2010), "associative reinforcement learning" (Kaelbling, Littman, and Moore 1996), "reinforcement learning with immediate reward" (Abe, Biermann, and Long 2003), "associative bandit problems" (Strehl, Mesterharm, Littman, and Hirsh 2006b), or "bandit problems with covariates" (Sarkar 1991). However, the term "contextual multi-armed bandit," as conceived by Langford and Zhang (2008), is the most used—so that is the term we will use in the current paper.

However named, in contextual bandit problems, CMAB policies differentiate themselves, by definition, from their MAB cousins in that they are able to make use of features that reflect the current state of the world—features that can then be mapped onto available arms or actions<sup>2</sup>. This access to side information makes CMAB algorithms yet more relevant to many real-life decision problems than their MAB progenitors (Langford and Zhang 2008). To follow up on our previous examples: do you choose the same type of restaurants in your hometown and when on vacation? Do you prescribe the same treatment to male and female patients? Do you place the same news story on the frontpage of your website for both young and old visitors? Probably not—it makes sense to make use of any additional contextual information that can help you make a better decision. So it may be no surprise that

---

<sup>2</sup>That is, before making a choice, the learner receives information on the state of the world or "context" in the form of a  $d$ -dimensional feature vector. After making a choice the learner is then able to combine this contextual information with the reward received to make a more informed decision in the next round.

CMAB algorithms have found applications in many different areas: from recommendation engines (Lai and Robbins 1985) to advertising (Tang, Rosales, Singh, and Agarwal 2013) and (personalized) medicine (Katehakis and Derman 1986; Tewari and Murphy 2017), healthcare (Rabbi, Aung, Zhang, and Choudhury 2015), and portfolio choice (Shen, Wang, Jiang, and Zha 2015)—inspiring a multitude of new bandit algorithms or policies.

However, although CMAB algorithms have found more and more applications, comparisons on both synthetic, and, importantly, real-life, large-scale offline datasets (Li, Chu, Langford, and Wang 2011) have relatively lagged behind<sup>3</sup>. To this end, the current paper introduces the R package **contextual**, to facilitate the development, evaluation, and comparison the of (contextual) multi-armed bandit policies by offering an easily extensible, class-based, modular architecture.

In that respect, **contextual** differentiates itself from several other types of bandit oriented software applications and services, such as:

- 1) Online A/B and basic, out-of-the-box MAB test services such as **Google Analytics** (Google 2018), **Optimizely** (Optimizely 2018), **Mix Panel** (Mixpanel 2018), **AB Tasty** (ABTasty 2018), **Adobe Target** (Adobe 2018), and more.
- 2) More advanced online CMAB test services and software, such as the flexible online evaluation platform **StreamingBandit** (Kruijswijk, Parvinen, van Emden, and Kaptein 2018) and Microsoft’s **Custom Decision Service** (Agarwal, Bird, Cozowicz, Hoang, Langford, Lee, Li, Melamed, Oshri, and Ribas 2016).
- 3) Predominantly context-free simulation oriented projects such as **Yelp MOE** (Yelp 2018), which runs sequential A/B tests using Bayesian optimization, and the mainly MAB focused Python packages **Striatum** (NTUCSIE-CLLab 2018) and **SMPyBandits** (Besson 2018).
- 4) Software that facilitates the evaluation of bandit policies on offline data, such as **Vowpal Wabbit** (Langford, Li, and Strehl 2007), **Jubatus** (Hido, Tokui, and Oda 2013), and **TensorFlow** (Abadi, Barham, Chen, Chen, Davis, Dean, Devin, Ghemawat, Irving, and Isard 2016).

Though each of these applications and services may share certain features with **contextual**, overall, **contextual** clearly distinguishes itself in several respects. First, it focusses on the evaluation of bandit policies on simulated and offline datasets, which discriminates it from the online evaluation oriented packages listed under items 1 and 2. Second, though **contextual** is perfectly capable of simulating and comparing context-free MAB policies, its emphasis lies on the simulation of contextual policies, distinguishing it from the projects listed under item 3. Finally, though **contextual** is closely related to the projects listed under item 4, it also, again, differentiates itself in several key respects:

- a) **contextual** offers a diverse, open and extensible library of common MAB and CMAB policies.
- b) **contextual** is developed in R, opening the door to a lively exchange of code, data, and knowledge between scientists and practitioners trained in R.
- c) **contextual** focusses on ease of conversion of existing and new algorithms into clean, readable and shareable source code.

---

<sup>3</sup>Here, a **synthetic** data generator (or **Bandit**, in **contextual** parlance) compares policies against some simulated environment, usually seeking to model or emulate some online bandit scenario—whereas an **offline Bandit** compares policies against a previous collected data set—generally logged with a completely different policy than the one(s) under evaluation (Li, Chu, Langford, Moon, and Wang 2012).

- d) In building on R’s **doParallel** package, **contextual**’s simulations are parallelized by default—and can easily be run on different parallel architectures, from cluster (such as on Microsoft Azure, Amazon ec2 or Hadoop backends) to GPU based.

All in all, though there are some alternatives, there was, as of yet, no extensible and widely applicable R package to analyze and compare, respectively, basic multi-armed, continuum (Agrawal 1995) and contextual multi-armed bandit algorithms on both simulated and offline data—outside of single-use scripts or basic or isolated code repositories (Gandrud 2016).

In making our latest CMAB R package **contextual** openly available at <https://github.com/Nth-iteration-labs/contextual>, we hope to remedy this situation, focussing on two goals:

- 1) Easing the implementation, evaluation, and dissemination of (C)MAB policies.
- 2) Introducing a wider audience to (C)MAB policies’ advanced sequential decision strategies.

The current paper pays heed to both these goals, in introducing the **contextual** package through basic CMAB simulations, running simple policies on bandits with just a few arms—leading up to a partial replication of Li, Chu, Langford, and Schapire (2010) that puts all introduced elements together in a demonstration of how **contextual** is able to efficiently compare seven policies in parallel on 45,811,883 separate events with a continually shifting pool of active arms for six levels of sparsity, therein uncovering some interesting new findings, all within 24 hours (see Section 8, Figure 12).

Specifically, Section 2 starts out by presenting a formal definition of the contextual multi-armed bandit problem, shows how this formalization can be transformed into a clear and concise object-oriented architecture, and then describes how to set up a minimal simulation. Section 3 gives an overview of **contextual**’s predefined `Bandit` and `Policy` subclasses and demonstrates how to run a very basic `Simulation`. Section 4 delves a little deeper into the implementation of each of **contextual**’s core superclasses. Section 5 shows how to extend **contextual**’s superclasses to create your own custom `Bandit` and `Policy` subclasses. Section 6 demonstrates how to further subclass existing `Bandit` and `Policy` implementations. Section 7 focusses on how a `Bandit` subclass can make use of offline datasets. Section 8 brings all of the previous sections together in a partial replication of a frequently cited contextual bandit paper. In Section 9 we conclude with some comments on the current state of the package and potential future enhancements.

This organization offers the reader several ways to peruse the current paper. Readers with a passing knowledge of R who are seeking to run simulations based on **contextual**’s default bandits and policies should be able to get up and running by reading the current introduction plus Section 3. For a more formal introduction, include Section 2. For readers who know their way around R and who are seeking to extend **contextual** to run custom bandits and policies, it is probably best to read the whole paper—with a focus on Sections 4, 5 and 6. Finally, add Sections 8 and possibly 9 for those readers interested in the implementation of custom offline bandits.

## 2. Formalization and implementation

In the current section, we first introduce a more formal definition of the contextual multi-armed bandit problem. Next, we present our concise implementation and demonstrate how to put together a minimal MAB simulation.

## 2.1. Formalization

### *Bandit*

Bandit  $B$  can be defined as a set of arms  $k \in \{1, \dots, K\}$ , where each arm is described by some reward function mapping  $d$  dimensional context vector  $x_{t,k}$  to some reward  $r_{t,k}$  (Auer, Cesa-Bianchi, and Fischer 2002; Langford and Zhang 2008) for every time step  $t$  until horizon  $T$ .

### *Policy*

Policy  $\pi$  seeks to maximize its cumulative reward  $\sum_{t=1}^T r_t$  (or minimize its cumulative regret—see equations 1, 2) by sequentially selecting one of bandit  $B$ 's currently available arms (Bubeck *et al.* 2012), here defined as taking action  $a_t$  in  $\mathcal{A}_t \subseteq K$  for  $t = \{1, \dots, T\}$ .<sup>4</sup>

### *Arm-selection process*

At each time step  $t$  policy  $\pi$  first observes the current state of the world as related to  $B$ , represented by  $d$ -dimensional context feature vectors  $x_{t,a}$ <sup>5</sup> for  $a_t \in \mathcal{A}_t$ . Making use of some arm-selection strategy, policy  $\pi$  then selects one of the available actions in  $\mathcal{A}_t$ . As a result of selecting action  $a_t$ , policy  $\pi$  then receives reward  $r_{a_t,t}$ . With observation  $(x_{t,a_t}, a_t, r_{t,a_t})$ , the policy can now update its arm-selection strategy. This cycle is then repeated  $T$  times.

Additionally, policies generally also summarize historical interactions  $D_{t'} = (x_{t'}, a_{t'}, r_{t'})$  over  $t = \{1, \dots, t'\}$  by use of a limited set of parameters  $\theta_t$  (Kruijswijk *et al.* 2018). This ensures a policy's action-selection process remains computationally tractable in keeping the dimensionality of  $\theta_{t'} \ll D_{t'}$ .

---

<sup>4</sup>In other words: Every  $t$  a policy makes a choice  $a_t$  from a set of  $\mathcal{A}_t$  actions, which is often equal to—but can be a subset of—the set of  $K$  arms of bandit  $B$ .

<sup>5</sup>Some formalizations describe this vector as  $x_t$  (see, for example, Slivkins (2014) or May, Korda, Lee, and Leslie (2012)). This formalization fits bandit scenario's where contextual information at each  $t$  is the same for each arm. For instance, a user feature vector  $x_t$  comprising the  $d$  features of a visitor to a news site, with articles for arms. Yet when arm-specific features are taken into account as well, formalizations generally describe the feature vector at each  $t$  as  $x_{t,a}$  (e.g. Chu, Park, Beaupre, Motgi, Phadke, Chakraborty, and Zachariah (2009), Li *et al.* (2010))—thereby summarizing, for example, information on both a user  $u_t$  and article  $k$ . To facilitate both approaches, **contextual** expects its bandits to generate a  $d \times k$  dimensional context feature matrix  $X_t$  at each  $t$ .

Schematically, for each round  $t = \{1, \dots, T\}$ :

- 1) Policy  $\pi$  observes current context feature vectors  $x_{t,a}$  for  $\forall a \in \mathcal{A}_t$  in bandit  $B$
- 2) Based on all  $x_{t,a}$  and  $\theta_{t-1}$ , policy  $\pi$  now selects an action  $a_t \in \mathcal{A}_t$
- 3) Policy  $\pi$  receives a reward  $r_{t,a_t,x_t}$  from bandit  $B$
- 4) Policy  $\pi$  updates arm-selection strategy parameters  $\theta_t$  with  $(x_{t,a_t}, a_t, r_{t,a_t})$

### Goal and performance measure

The goal of the policy  $\pi$  is to optimize its *cumulative reward* over  $t = \{1, \dots, T\}$

$$R_T = \sum_{t=1}^T (r_{t,a_t,x_t}) \quad (1)$$

The most popular performance measure for bandit policies is *expected cumulative regret* (Kuleshov and Precup 2014)—defined as the sum of rewards that would have been received by choosing optimal action  $a^*$  at every  $t$  subtracted by the sum of rewards awarded to the chosen action  $a$  at every  $t$  over  $t = \{1, \dots, T\}$ :

$$\mathbb{E}[R_T] = \mathbb{E} \left[ \max_{a^*=1,\dots,\mathcal{A}_t} \sum_{t=1}^T (r_{t,a^*,x_t}) - \sum_{t=1}^T (r_{t,a_t,x_t}) \right] \quad (2)$$

Where expectation  $\mathbb{E}[\cdot]$  is taken with respect to random draws of both rewards assigned by a bandit and arms as selected by a policy (Zheng and Hua 2016).

## 2.2. Implementation

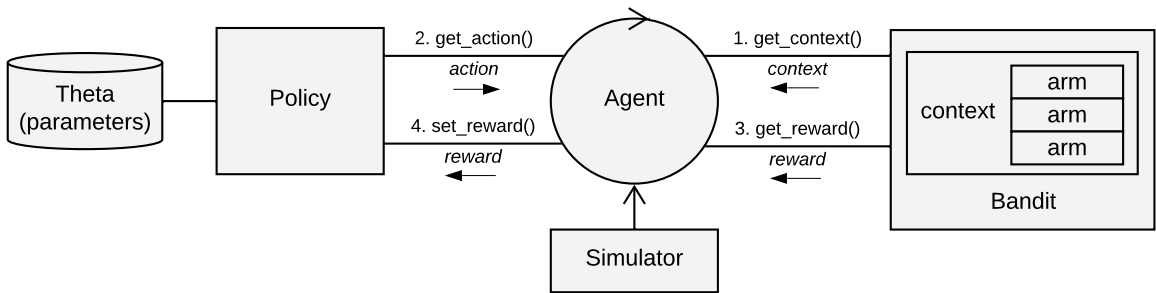

Figure 1: Diagram of **contextual**'s basic structure. The context feature matrix returned by `get_context()` is only taken into account by CMAB policies, and may be ignored by MAB policies.

The package's **Bandit** and **Policy** centered class structure stays close to the previous formalization, while offering a clean, developer oriented interface. The following six classes form the backbone of the package (see also Figure 1):

- **Bandit**: R6 class `Bandit` is the parent class of all **contextual** `Bandit` subclasses. It is responsible for the generation of contexts and rewards.
- **Policy**: R6 class `Policy` is the parent class of all **contextual**'s `Policy` implementations. For each  $t = \{1, \dots, T\}$  it has to choose one of a `Bandit`'s  $k$  arms, and update its parameters  $\theta$  in response to the resulting reward.
- **Agent**: R6 class `Agent` is responsible for the running of one `Bandit/Policy` pair. As such, multiple `Agents` can be run in parallel with each separate `Agent` keeping track of  $t$  for its assigned `Policy` and `Bandit` pair. To be able to fairly evaluate and compare each agent's performance, and to make sure that simulations are replicable, seeds are set equally and deterministically for each agent over all horizon times simulations time steps of each agent's simulation.
- **Simulator**: R6 class `Simulator` is the entry point of any **contextual** simulation. It encapsulates one or more `Agents` (running in parallel to each other, by default), creates an `Agent` clone (each with its own deterministic seed) for each to be repeated simulation, runs the `Agents`, and saves the log of all `Agent` interactions to a `History` object.
- **History**: R6 class `History` keeps a log of all `Simulator` interactions. It allows several ways to interact with the data, provides summaries of the data, and can save and load simulation data in several different (`data.table`, `data.frame` and CSV) formats.
- **Plot**: R6 class `Plot` generates plots from `History` logs. It is usually invoked by calling the generic `plot(h)` function, where  $h$  is an `History` class instance.

### 2.3. Putting it together: a first MAB simulation

#### *Running a simulation*

Building on the introduction of **contextual**'s core classes in the previous section, we can now put together the following five line MAB simulation to examine the performance of an  $\epsilon$ -greedy policy (covered in Section 5.3) on a three-armed bandit:

```
> library(contextual)
>
> bandit <- ContextualBernoulliBandit$new(matrix(c(0.5, 0.2, 0.1), 1))
> policy <- EpsilonGreedyPolicy$new(0.1)
> agent <- Agent$new(policy, bandit)
> sim <- Simulator$new(agent, simulations = 10000, horizon = 100)
> history <- sim$run()
```

In these lines we start out by instantiating the `Bandit` subclass `ContextualBernoulliBandit` (covered in Section 5) as `bandit`, with three Bernoulli arms, each offering a reward of one with reward probability  $\theta$ , and otherwise a reward of zero. For the current simulation, we have set the `bandit` arm probabilities of reward to respectively 0.5, 0.2 and 0.1 through the policy's `weights` parameter. In `ContextualBernoulliBandit`, the number of bandit arms equals number of columns of

weight matrix. That is, the bandit instance's number of arms `bandit$k` now equals 3, and, for this context-free setting, its number of feature dimension `bandit$d` remains NULL.

Next, we instantiate the Policy subclass `EpsilonGreedyPolicy` as object `policy`, with its `epsilon` parameter set to 0.1.

We then assign both our `bandit` and our `policy` to `Agent` instance `agent`. This `agent` is added to a `Simulator` that is set to ten thousand simulations, each with a horizon of one hundred—that is, `simulator` runs ten thousand simulations<sup>6</sup> for one hundred time steps `t`.

In anticipation of Section 4: For a policy to be able to initialize its parameters, during initialisation, an agent instance makes `bandit$k` (number of arms) and `bandit$d` (number of dimensions) available to its policy through calls to `policy$set_parameters(context_initial_params)` and `policy$initialize_theta(context_initial_params$k)`. On starting the simulation, the (potentially changing) number of arms and features dimension remain available for each time step `t` through respectively `context$k` and `context$d`.

Running the `Simulator` instance then starts several (by default, the number of CPU cores minus one) worker processes, dividing simulations over all parallel worker. For each simulation, for every time step `t`, agents runs through each of the four function calls that constitute their main loop.

A main loop that relates one on one to the four steps defined in our CMAB formalization from Section 2.1.4:

- 1) `agent` calls `bandit$get_context(t)`. The `bandit` returns a named list that contains the current  $d \times k$  dimensional feature matrix `context$X`, the number of arms `context$k` and the number of features per arm `context$d`.
- 2) `agent` calls `policy$get_action(t, context)`. The `policy` computes which arm to play based on the current values in named lists `theta` and `context`. The `policy` returns a named list containing `action$choice`, which holds the index of the arm to play.
- 3) `agent` calls `bandit$get_reward(t, context, action)`. The `bandit` returns a named list containing the reward for the action chosen in [2] and, optionally, an `optimal_reward`—when computable.
- 4) `agent` calls `policy$set_reward(t, context, action, reward)`. The `policy` uses the action taken, the reward received, and the current `context` to update its set of parameter values in `theta`.

### *Results of the simulation*

On completion of all of its agents' simulation runs, the `Simulator` instance returns a `History` instance containing a complete log of all interactions. This history log can then, for example, be summarized and plotted:

```
> summary(history)
```

Agents:

---

<sup>6</sup>Each starting with a deterministically set random seed.



EpsilonGreedy

Cumulative regret:

agent	t	sims	cum_regret	cum_regret_var	cum_regret_sd
EpsilonGreedy	100	10000	9.115	101.4203	10.07077

Cumulative reward:

agent	t	sims	cum_reward	cum_reward_var	cum_reward_sd
EpsilonGreedy	100	10000	40.816	119.8215	10.9463

Cumulative reward rate:

agent	t	sims	cur_reward	cur_reward_var	cur_reward_sd
EpsilonGreedy	100	10000	0.40816	1.198215	0.109463

`> plot(history, type = "arms")`

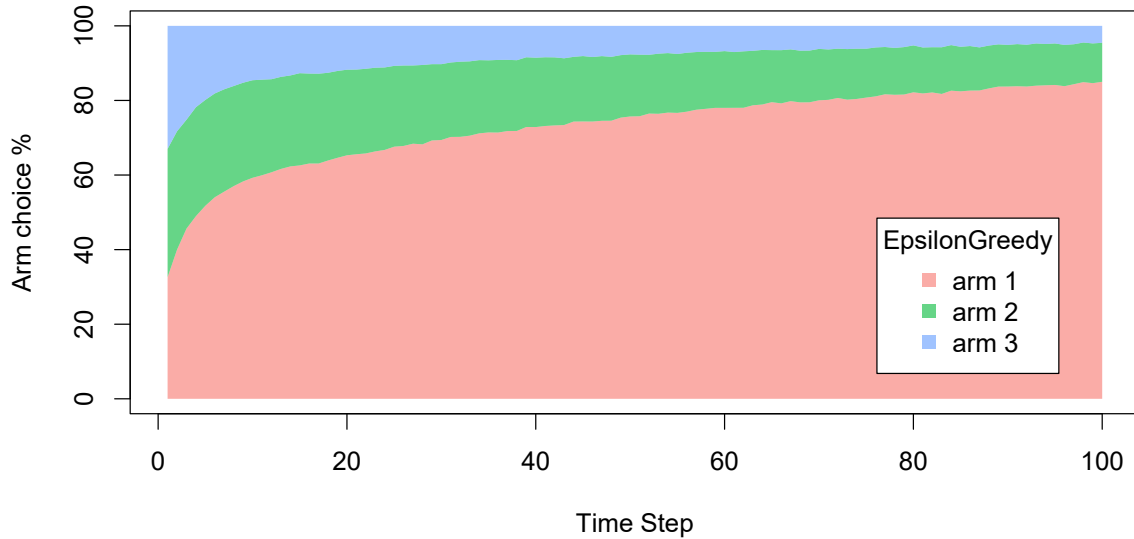

Figure 2: The percentage each of the three arms of the bandit was chosen by the policy over all simulations per time step  $t$ . The plot represents the progression of this percentage for each time step from 1 to 100.

### 3. Basic usage

The current section offers an overview of **contextual**'s predefined bandits and policies and further demonstrates how to run them.

### 3.1. Implemented policies and bandits

Though **contextual** was designed to make it easy to develop custom bandit and policy classes, it is also possible to run basic simulations with just its built-in bandits and policies. See Table 1 for an overview of all available policies and Table 2 for an overview of all bandits implemented up until december 2018—where possible referencing their original papers.

	$\epsilon$ -Greedy	UCB	Thomson Sampling	Other	Special
MAB	$\epsilon$ -Greedy <sup>1</sup> $\epsilon$ -First	UCB1 <sup>2</sup> UCB-tuned <sup>3</sup>	Thompson Sampling <sup>4</sup> BootstrapTS <sup>5</sup>	Softmax <sup>6</sup> Gittins <sup>7</sup>	Random Oracle LiF <sup>8</sup>
CMAB	Epoch-Greedy <sup>9</sup>	LinUCB <sup>10</sup>	LinTS <sup>11</sup> LogitBTS <sup>12</sup>		

Table 1: An overview of **contextual**'s predefined contextual and context-free policy classes.

<sup>1</sup> Sutton and Barto (1998) <sup>2</sup> Auer *et al.* (2002) <sup>3</sup> Auer *et al.* (2002) <sup>4</sup> Agrawal and Goyal (2011) <sup>5</sup> Eckles and Kaptein (2014) <sup>6</sup> Vermorel and Mohri (2005) <sup>7</sup> Brezzi and Lai (2002) <sup>8</sup> Kaptein *et al.* (2016) <sup>9</sup> Langford and Zhang (2008) <sup>10</sup> Li *et al.* (2010) <sup>11</sup> Agrawal and Goyal (2012) <sup>12</sup> Eckles and Kaptein (2014)

MAB	CMAB	Offline	Continuous
BasicBernoulliBandit	ContextualBernoulli	ReplayEvaluator <sup>2</sup>	ContinuumBandit
BasicGaussianBandit	ContextualLogit	Bootstrap Replay <sup>3</sup>	
	ContextualHybrid	PropensityWeighting <sup>4</sup>	
	ContextualLinear	Direct Method <sup>4</sup>	
	ContextualWheel <sup>1</sup>	Doubly Robust <sup>4</sup>	

Table 2: An overview of **contextual**'s predefined synthetic and offline bandit classes.

<sup>1</sup> Riquelme *et al.* (2018) <sup>2</sup> Li *et al.* (2011) <sup>3</sup> Nicol (2014) <sup>4</sup> Dudík *et al.* (2011)

### 3.2. Running basic simulations

In the current subsection we demonstrate how to run simulations with **contextual**'s predefined `Bandit` and `Policy` subclasses on the basis of a familiar bandit scenario.

#### *The scenario*

Since online advertising is one of the areas where bandit policies have found widespread application, we will use it as the setting for our basic bandit example. Generally, the goal in online advertising is to determine which out of several ads to serve a visitor to a particular web page. Translated to a bandit setting, in online advertising:

- The context is usually determined by visitor and web page characteristics.

- Arms are represented by the pool of available ads.
- An action equals a shown ad.
- Rewards are determined by a visitor clicking (a reward of 1) or not clicking (a reward of 0) on the shown ad.

For the current example, we limit the number of advertisements we want to evaluate to three, and set ourselves the objective of finding which policy would offer us the highest total click-through rate<sup>7</sup> over four hundred impressions.

### *Evaluating context-free policies*

Before we are able to evaluate any policies, we first need to model our three ads—each with a different probability of generating a click—as the arms of a bandit. For our current simulation we choose to model the ads with the weight-based `ContextualBernoulliBandit`, as this allows us to set weights determining the average reward probability of each arm. As we are comparing context-free bandits, here, we specify only one row in `ContextualBernoulliBandit`'s weight-matrix, representing average reward probabilities or theta's per arm (in the following section we will add rows to the matrix, each additional row representing one context feature's weight per arm). As can be observed in the source code below, for the current simulation, we set the weights of the arms to respectively  $\theta_1 = 0.8$ ,  $\theta_2 = 0.4$  and  $\theta_3 = 0.2$ .

We also choose two context-free policies to evaluate and compare:

- `EpsilonFirstPolicy`: explores the three ads uniformly at random for a preset period and from thereon exploits the ad with the best click-through rate<sup>8</sup>. For our current scenario, we set the exploration period to one hundred impressions. A formal definition and implementation of the algorithm can be found in Section 5.2.
- `EpsilonGreedyPolicy`: explores one of the ads uniformly at random  $\epsilon$  of the time and exploits the ad with the best current click-through rate  $1 - \epsilon$  of the time. For our current scenario, we set  $\epsilon = 0.4$ . For a formal definition and implementation see Section 5.3.

Next, we assign the bandit and our two policy instances to two agents. Finally, we assign a list holding both agents to a `Simulator` instance, set the simulator's horizon to four hundred and the number of repeats to ten thousand, run the simulation, and `plot()` its results:

```
# Load and attach the contextual package.
library(contextual)
# Define for how long the simulation will run.
horizon <- 400
# Define how many times to repeat the simulation.
simulations <- 10000
# Define the probability that each ad will be clicked.
click_probabilities <- matrix(c(0.6, 0.4, 0.2), nrow = 1, ncol = 3, byrow = TRUE)
```

<sup>7</sup>Click-through rate (CTR) is the ratio of users who click on a specific link or ad to the number of total users who view it (Briggs and Hollis 1997).

<sup>8</sup>A type of policy also known as an A/B test (Kohavi, Henne, and Sommerfield 2007).

```

# Initialize a SyntheticBandit, which takes probabilities per arm for an argument.
bandit <- ContextualBernoulliBandit$new(weights = click_probabilities)
# Initialize EpsilonGreedyPolicy with a 40 percent exploration rate.
eg_policy <- EpsilonGreedyPolicy$new(epsilon = 0.4)
# Initialize EpsilonFirstPolicy with a .25 x 400 = 100 step exploration period.
ef_policy <- EpsilonFirstPolicy$new(epsilon = 0.25, N = horizon)
# Initialize two Agents, binding each policy to a bandit.
ef_agent <- Agent$new(ef_policy, bandit)
eg_agent <- Agent$new(eg_policy, bandit)
# Assign both agents to a list.
agents <- list(ef_agent, eg_agent)
# Initialize a Simulator with the agent list, horizon, and number of simulations.
simulator <- Simulator$new(agents, horizon, simulations, do_parallel = TRUE)
# Now run the simulator.
history <- simulator$run()
# Finally, plot the average reward per time step t
plot(history, type = "average", regret = FALSE)
# And the cumulative reward rate, which equals the Click Through Rate)
plot(history, type = "cumulative", regret = FALSE, rate = TRUE)

```

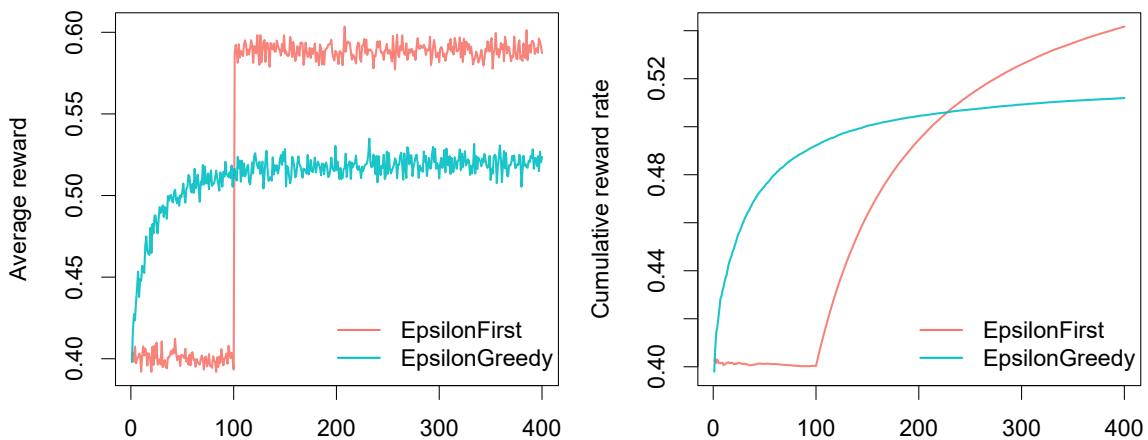

Figure 3: Average reward (left) and cumulative reward rate (equaling click-through rate, right) of  $\epsilon$ -first and  $\epsilon$ -greedy policies.

As can be observed in Figure 3, within our horizon of  $T = 400$ , `EpsilonFirstPolicy` has accumulated more rewards than `EpsilonGreedyPolicy`. It is easy to see why: The winning arm is better than the other two—by a margin. So `EpsilonFirstPolicy` has no difficulty in finding the optimal arm within its exploration period of one hundred impressions. Up to that point, `EpsilonGreedyPolicy` had the advantage of a headstart, as it was already able to exploit for  $1 - \epsilon$  or sixty percent of the time. But from one hundred impressions on, `EpsilonFirstPolicy` switches from full exploration to full exploitation mode. In contrast to `EpsilonGreedyPolicy`, it is now able to exploit the arm that proved best during exploration all of the time. As a result, it catch up with (and

then surpass) the rewards accumulated by `EpsilonGreedyPolicy` within less than one hundred and fifty impressions.

### *Adding context*

If that is all we know of our visitors, we expect the results to be stationary over time, and these are the only policies available, the choice is clear: for this scenario, you would pick `EpsilonFirstPolicy`<sup>9</sup>. However, if we have contextual information on our visitors—for instance, their age—we might be able to do better. Let us suggest that we expect that some of our ads are more effective for older visitors, and other ads more effective for younger visitors.

To incorporate this expectation in our simulation, we need to change the way our bandit generates its rewards. Fortunately, in the case of our `ContextualBernoulliBandit`, the introduction of two contextual features only requires the addition of a single row to its weight matrix—as `ContextualBernoulliBandit` parses each of the  $d$  rows of its weight matrix as a binary contextual feature randomly selected or sampled  $1/d$  of the time.

We took care to set the combined weight per arm such that each arm generates the same average rewards as previously. So we do not expect a substantial difference with the last simulation’s outcome for our context-free policies `EpsilonFirstPolicy` and `EpsilonGreedyPolicy`.

We therefore now also include the contextual `LinUCBDisjointPolicy` (Li *et al.* 2010), which, in assuming its reward function is a linear function of the context, should be able to incorporate our new contextual information into its decision-making process. See 5.4 for a detailed description and implementation details of this policy. Now let us rerun the simulation:

```
#          +-----+-----+-----> arms:  three ads
#          |       |       |
click_probs <- matrix(c(0.5, 0.7, 0.1, # -> context 1: older (p=.5)
                      0.7, 0.1, 0.3), # -> context 2: young (p=.5)

                      nrow = 2, ncol = 3, byrow = TRUE)

# Initialize a SyntheticBandit with contextual weights
context_bandit <- ContextualBernoulliBandit$new(weights = click_probs)
# Initialize LinUCBDisjointPolicy
lucb_policy    <- LinUCBDisjointPolicy$new(0.6)
# Initialize three Agents, binding each policy to a bandit.
ef_agent      <- Agent$new(ef_policy,  context_bandit)
eg_agent      <- Agent$new(eg_policy,  context_bandit)
lucb_agent     <- Agent$new(lucb_policy, context_bandit)
# Assign all agents to a list.
agents <- list(ef_agent, eg_agent, lucb_agent)
# Initialize a Simulator with the agent list, horizon, and nr of simulations
simulator <- Simulator$new(agents, horizon, simulations)
# Now run the simulator.
history <- simulator$run()
```

<sup>9</sup>Also: if our bandit represents our visitors’ click behavior realistically, if our policies’ parameters are optimal, etcetera.

```
# Finally, plot the average reward..
plot(history, type = "average", regret = FALSE)
# And the cumulative reward rate again.
plot(history, type = "cumulative", regret = FALSE, rate = TRUE)
```

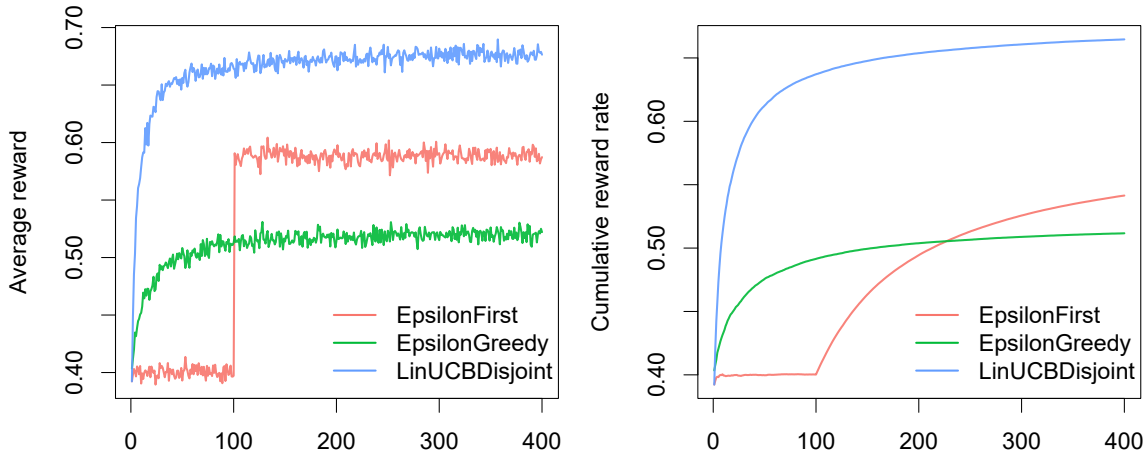

Figure 4: Average reward (left) and cumulative reward rate (equaling click-through rate, right) of LinUCB,  $\epsilon$ -first and  $\epsilon$ -greedy policies.

As can be observed in Figure 4, both context-free bandit's results do indeed not do better than before. On the other hand, `LinUCBDisjointPolicy` does very well, as it indeed proves able to map its rewards to the available contextual features.

Of course, the simulations in the current section are not very realistic. One way of creating more realistic simulations would be to write a `Bandit` subclass with a more complex generative model. Section 6 shows how to get started with that. Another option would be to evaluate policies on an offline dataset—more on how to go about that in Section 7.

## 4. Core classes

The current section offers additional background information on `contextual`'s class structure—both on the R6 class system [Chang \(2017\)](#) and on each of the six previously introduced core `contextual` classes. Together with the information in the next section, on bandit and policy implementation, this should be able to get you up and running with developing your own custom `Bandit` and `Policy` subclasses.

### 4.1. Choice for the R6 class system

Though widely used as a procedural language, R offers several Object Oriented (OO) systems, which can significantly help in structuring the development of more complex packages. Out of the OO systems available (S3, S4, R5 and R6), we settled on R6, as it offered several advantages compared

to the other options. Firstly, it implements a mature object-oriented<sup>10</sup> design when compared to S3. Secondly, its classes can be accessed and modified by reference—which offers the added advantage that R6 classes are instantly recognizable for developers with a background in programming languages such as Java or C++. Finally, when compared to the older R5 reference class system, R6 classes are much lighter-weight and, as they do not make use of S4 classes, do not require the **methods** package.

## 4.2. Main classes

In this section, we go over each of **contextual**'s six main classes in some more detail—with an emphasis on the **Bandit** and **Policy** classes. To clarify **contextual**'s class structure, we also include two UML diagrams (UML, or "unified modeling language" presents a standardized way to visualize the overall class structure and general design of a software application or framework (Rumbaugh, Jacobson, and Booch 2004)). The UML class diagram shown in Figure 13 on page 54 visualizes **contextual**'s static object model, showing how its classes inherit from, and interface with, each other. The UML sequence diagram in figure Figure 14 on page 55, on the other hand, illustrates how **contextual**'s classes interact dynamically over time.

### Simulator

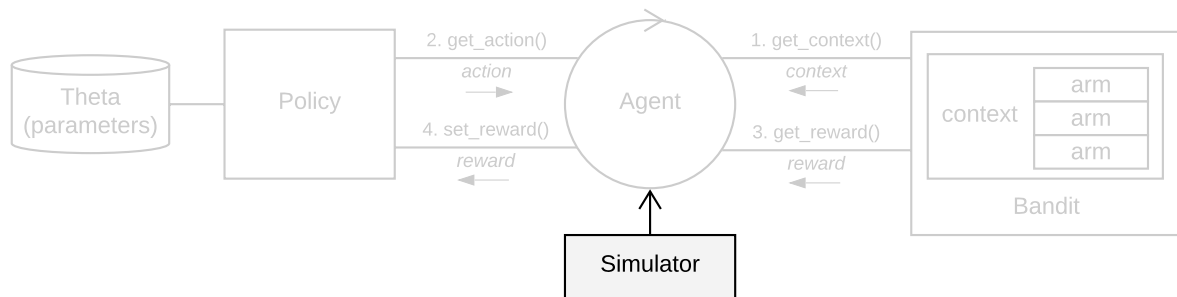

A **Simulator** instance is the entry point of any **contextual** simulation. It encapsulates one or more **Agents**, clones them if necessary, runs the **Agents** (in parallel, by default), and saves the log of all of the **Agents** interactions to a **History** object:

```
history <- Simulator$new(agents = agent, horizon = 10, simulations = 10)$run()
```

By default, for performance reasons, a **Simulator** does not save **context** matrices and the (potentially deeply nested) **theta** list to its **History log**—though this can be changed by setting either **save\_context** and **save\_theta** arguments set to **TRUE**.

To specify how to run a simulation and which data is to be saved to a **Simulator** instance's **History log**, a **Simulator** object can be configured through, among others, the following arguments:

- **agents** [NULL] An **Agent** instance, or a list of **Agent** instances to be run by the instantiated **Simulator**.
- **horizon** [100] The **T** time steps to run the instantiated **Simulator**.

<sup>10</sup>In object-oriented programming, the developer compartmentalizes data into objects, whose behavior and contents are described through the declaration of classes. Its benefits include reusability, refactoring, extensibility, ease of maintenance and efficiency. See, for instance, Wirfs-Brock, Wilkerson, and Wiener (1990) for a general introduction to the principles of Object Oriented software design, and Wickham (2014) for more information of the use of OOP in R.

- `simulations` [100] How many times to repeat each agent's simulation with a new seed on each repeat (itself deterministically derived from `set_seed`).
- `save_context` [FALSE] Save context matrices `X` to the History log during a simulation?
- `save_theta` [FALSE] Save the parameter list `theta` to the History log during a simulation?
- `do_parallel` [TRUE] Run Simulator processes in parallel?
- `worker_max` [NULL] Specifies how many parallel workers are to be used, when `do_parallel` is TRUE. If unspecified, the amount of workers defaults to `max(workers_available)-1`.
- `set_seed` [0] Sets the seed of R's random number generator for the current Simulator.
- `progress_file` [FALSE] If TRUE, Simulator writes `progress.log` and `doparallel.log` files to the current working directory, allowing you to keep track of workers, iterations, and potential errors when running a Simulator in parallel.
- `include_packages` [NULL] List of packages that (one of) the policies depend on. If a Policy requires an R package to be loaded, this option can be used to load that package on each of the workers. Ignored if `do_parallel` is FALSE.
- `reindex` [FALSE] If TRUE, removes empty rows from the History log, re-indexes the `t` column, and truncates the resulting data to the shortest simulation grouped by agent and simulation.

The `Simulator` class has been designed to make it as easy as possible to replace its default parallel backend for other `foreach` type backends. In the `alt_par_backend_examples` subdirectory of `contextual`'s root demo directory we offer working examples of `doAzureParallel`, `doRedis` and `doMPI` Simulator subclasses. As a result of `contextual`'s object oriented structure, such Simulator subclasses can be implemented in just a few lines of code, for instance in the case of the `doMPI` subclass:

```

MPISimulator <- R6::R6Class(
  inherit = Simulator,
  public = list(
    # Register a foreach parallel backend.
    register_parallel_backend = function() {
      super$cl <- doMPI::startMPIcluster()
      doMPI::registerDoMPI(super$cl)
      # Also make sure to set Simulator's super$workers.
      super$workers = foreach::getDoParWorkers()
      message(paste0("MPI workers: ", super$workers))
    },
    # If necessary, clean up.
    stop_parallel_backend = function() {
      try({
        doMPI::closeCluster(super$cl)
      })
    }
  )

```



```

    }
  )
)

```

### Agent

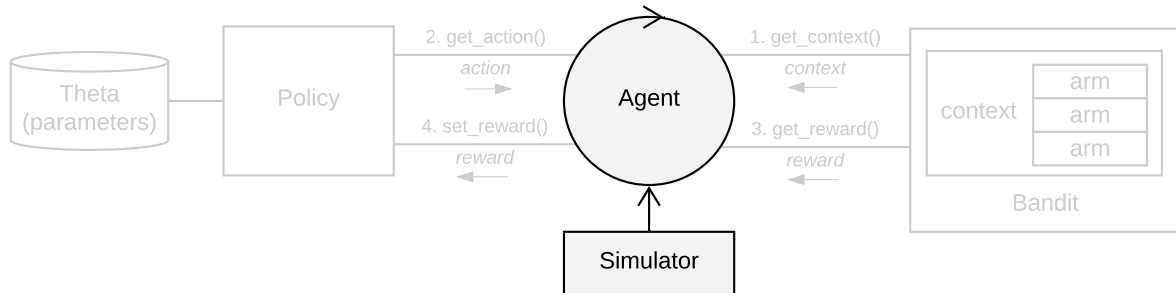

To ease the encapsulation of parallel Bandit and Policy simulations, Agent is responsible for the flow of information between and the running of one Bandit and Policy pair, for example:

```

policy      <- EpsilonGreedyPolicy$new(epsilon = 0.1)
bandit     <- ContextualBernoulliBandit$new(weights = c(0.9, 0.1, 0.1))
agent      <- Agent$new(policy,bandit, name = "EG Agent One")

```

It keeps track of agent and policy related timesteps  $t$  and makes sure that, at each agent time step  $agent\_t$ , the four main Bandit and Policy CMAB methods are called in correct order, one after the other:

# Abstracted skeleton code representation of Agent class

```

Agent <- R6::R6Class(
  public = list(
    agent_t = 0,
    policy_t = 0,
    #...
    do_step = function() {
      agent_t <<- agent_t + 1L
      context <- bandit$get_context(agent_t)
      action <- policy$get_action(policy_t, context)
      reward <- bandit$get_reward(agent_t, context, action)
      if (is.null(reward)) {
        theta <- NULL
      } else {
        theta <- policy$set_reward(policy_t, context, action, reward)
        policy_t <<- policy_t + 1L
      }
      list(context, action, reward, theta, policy_t)
    }
  )
  #...
)
)

```

Its main function is `do_step()`, generally called by a `Simulator` object (or, more specifically, by the `Simulator`-started parallel worker that is responsible for this particular `Agent`):

- `do_step()` Completes one time step  $t$  by consecutively calling `bandit$get_context()`, `policy$get_action()`, `bandit$get_reward()` and `policy$set_reward()`.

### *Bandit*

In **contextual**, any bandit implementation is expected to subclass and extend the `Bandit` superclass. It is then up to these subclasses themselves to provide an implementation for each of its abstract methods.

`Bandits` are responsible for the generation of (either synthetic or offline) contexts and rewards. On initialisation, a `Bandit` subclass has to define the number of arms `self$k` and the number of contextual feature dimensions `self$d`. For each  $t = \{1, \dots, T\}$  a `Bandit` then generates a list containing current context as either a  $d$  dimensional context vector, or a  $d \times k$  dimensional matrix<sup>11</sup> `context$X`, the number of arms in `context$k` and the number of features in `context$d` (Note: in context-free scenario's, `context$X` can be omitted):

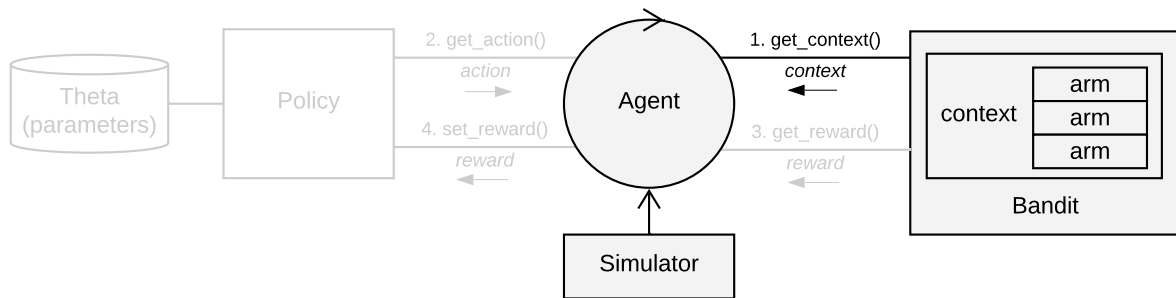

On receiving the index of a `Policy`-chosen arm through `action$choice`, `Bandit` is expected to return a named list containing at least `reward$reward` and, where computable, `reward$optimal`:

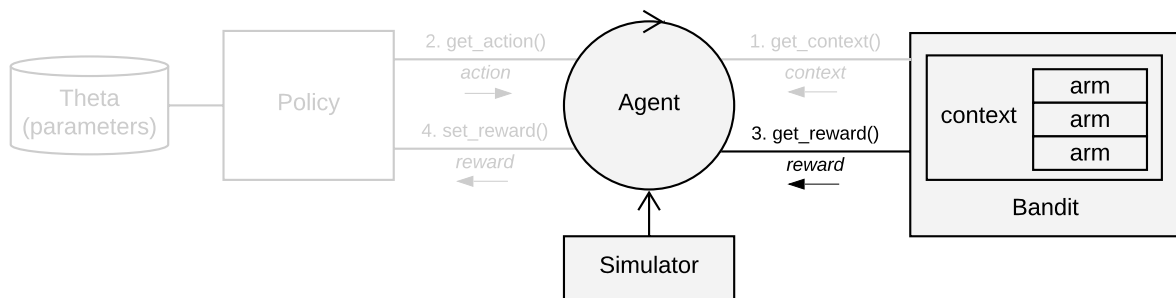

<sup>11</sup>For each  $t$ , a `Bandit` generated matrix describes both features shared by all arms and features that differ per arm. In other words, each column of this matrix represents a single arm's feature vector—combining, for instance, overall user and arm specific article weights. See also Section 2.1.4.

The following skeleton code gives an overview of how the above is implemented in **contextual**'s Bandit superclass:

```
Bandit <- R6::R6Class(
  class    = FALSE,
  public   = list(
    k       = NULL, # Number of arms (integer, required)
    d       = NULL, # Dimensions of context vector (integer, required)
    ..
    class_name = "Bandit", # Bandit name - required (character)
    initialize = function() {
      # Initialize Bandit. Set self$d and self$k here.
    },
    get_context = function(t) {
      stop("Bandit subclass needs to implement get_context()", call. = FALSE)
      # Return a list with number of arms self$k, number of feature dimensions
      # self$d and, where applicable, a self$d dimensional context vector or
      # self$d x self$k dimensional context matrix X.
      list(X = context, k = arms, d = features) # nocov
    },
    get_reward = function(t, context, action) {
      stop("Bandit subclass needs to implement get_reward()", call. = FALSE)
      # Return a list with the reward of the chosen arm and, if available,
      # optimal arm reward and index
      list(reward = reward_for_choice_made, optimal_reward = optimal_reward, optimal_arm =
    },
    ...
  )
)
```

The main Bandit functions can be further detailed as follows:

- `new()` generates and instantializes a new Bandit instance.
- `get_context(t)`
  - `t`: [integer], time step `t`.

Returns a named list containing the current `d x k` dimensional matrix `context$X`, the number of arms `context$k` and the number of features `context$d`.
- `get_reward(t, context, action)`
  - `t`: [integer], time step `t`.
  - `context`: [list], containing the current `context$X` (`d x k` context matrix), `context$k` (number of arms) and `context$d` (number of context features) (as set by `bandit`).
  - `action`: [list], containing `action$choice` (as set by policy).

Returns a named list containing `reward$reward` and, where computable, `reward$optimal` (used by "oracle" policies and to calculate regret).

- `post_initialization()` Called after class and seed initialisation, but before the start of the simulation. Set random values that remain available throughout the life of a `Bandit` here.
- `generate_bandit_data(n = horizon)` Called after class and seed initialisation, but before the start of a simulation. Only called when `bandit$precaching` is set to `TRUE` (default `FALSE`). Pre-generate  $n$  contexts and rewards here.

As already previously indicated in Table 2 in Section 3.1 `Bandit`, **contextual** already contains several predefined Bandits, such as:

- `BasicBernoulliBandit`: This basic (context-free)  $k$ -armed bandit synthetically generates rewards based on a weight vector.
- `BasicGaussianBandit`: Context-free Gaussian multi-armed bandit.
- `ContextualBernoulliBandit`: An example of a more complex and versatile synthetic bandit. It pre-generates both a randomized context matrix and reward vectors
- `ContextualLinearBandit`: Samples data from linearly parameterized arms.
- `ContextualWheelBandit`: The Wheel bandit game offers an artificial problem where the need for exploration is smoothly parameterized through an exploration parameter (Riquelme *et al.* 2018).
- `ContextualLogitBandit`: Samples data from a basic logistic regression model.
- `ContinuumBandit`: Bandit where arm(s) are chosen from a subset of the real line and mean rewards are assumed to be a continuous function of the arms.
- `OfflineReplayEvaluatorBandit`: Replays offline data to generate its contexts and rewards. Li *et al.* (2010).

Each of these bandits can either be run directly or serve as templates or superclasses for custom `Bandit` implementation(s).

### *Policy*

`Policy` is another often subclassed contextual superclass. Just like the `Bandit` superclass, `Policy` is an abstract class that declares methods without itself offering an implementation. Any `Policy` subclass is therefore expected to implement `get_action()` and `set_reward()`. Also, any parameters that keep track or summarize context, action and reward values are required to be saved to `Policy`'s named list `theta`.

On every  $t = \{1, \dots, T\}$ , a policy receives either a  $d$ -dimensional vector or a  $d \times k$  dimensional matrix `context$X`. To make sure a policy supports both contextual feature vectors and matrices in `context$X`, it is suggested any contextual policy makes use of **contextual**'s `get_arm_context(context$X, arm)` utility function to obtain the current context for a particular arm, and `get_full_context(X, d, k)` where a policy needs to obtain of the full  $d \times k$  matrix.

Next to the context vector or matrix, a policy also receives, at least, the current number of `Bandit` arms in `context$k`, and the current number of contextual features in `context$d`. It has to compute which of the  $k$  `Bandit` arms to pull by taking into account this contextual information plus the policy's current parameter values stored in the named list `theta`. On selecting an arm, the policy then returns its index as `action$choice`:

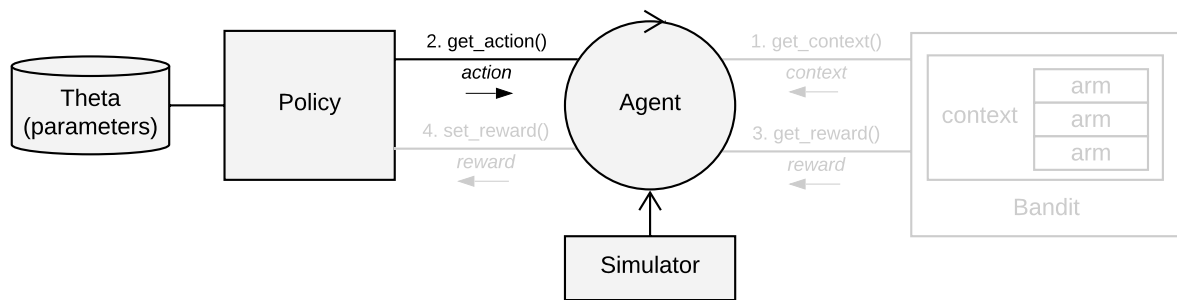

On pulling a `Bandit` arm the policy receives a `Bandit` reward through `reward$reward`. In combination with the current `context$X` and `action$choice`, this reward can then be used to update to the policy's parameters as stored in list `theta`:

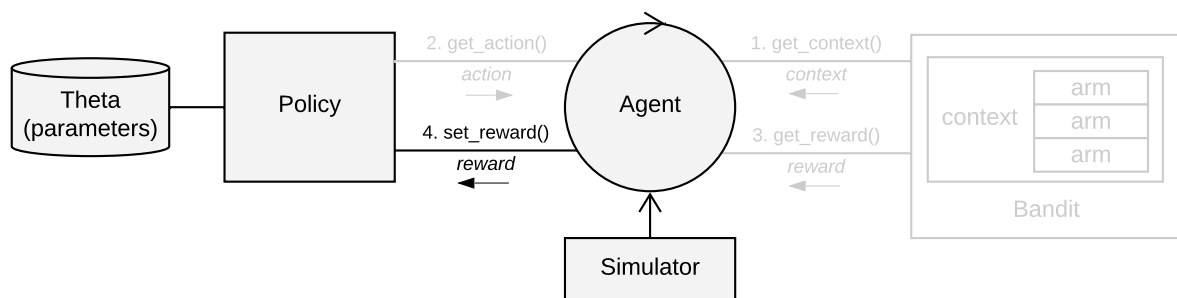

Note: in context-free scenario's, `context$X` can be omitted.

The following skeleton code gives an overview of how the above is implemented in **contextual**'s `Policy` superclass:

```
Policy <- R6::R6Class(
  portable = FALSE,
  class = FALSE,
  public = list(
    action      = NULL,      # action results (list)
    theta       = NULL,      # policy parameters theta (list)
    theta_to_arms = NULL,    # theta to arms "helper" (list)
    class_name  = "Policy",  # policy name - required (character)
    initialize = function() {
      self$theta <- list()   # initializes theta list
      self$action <- list()  # initializes action list
    },
    ...
    get_action = function(t, context) {
      # Selects arm based on theta & context, returns it in action$choice
      stop("Policy$get_action() has not been implemented.")
    },
    set_reward = function(t, context, action, reward) {
      # Updates parameters in theta based on reward awarded by bandit
      stop("Policy$set_reward() has not been implemented.")
    },
    ...
  )
)
```

)  
)

Policy's main functions can be further detailed as follows:

- `new()` Generates and initializes a new Policy object.
- `get_action(t, context)`
  - `t`: [integer], time step `t`.
  - `context`: [list], containing the current `context$X` ( $d \times k$  context matrix), `context$k` (number of arms) and `context$d` (number of context features).

Computes which arm to play based on the current values in named list `theta` and the current `context`.

Returns a named list containing `action$choice`, which holds the index of the arm to play.

- `set_reward(t, context, action, reward)`
  - `t`: [integer], time step `t`.
  - `context`: [list], containing the current `context$X` ( $d \times k$  context matrix), `context$k` (number of arms) and `context$d` (number of context features).
  - `action`: [list], containing `action$choice` (as set by policy).
  - `reward`: [list], containing `reward$reward` and, if available, `reward$optimal` (as set by bandit).

Returns the set of updated parameters in list `theta`.

- `set_parameters()` Helper function, called during a Policy's initialisation, assigns the values it finds in list `self$theta_to_arms` to each of the Policy's `k` arms. The parameters defined here can then be accessed by arm index in the following way: `theta[[index_of_arm]]$parameter_name`.

### History

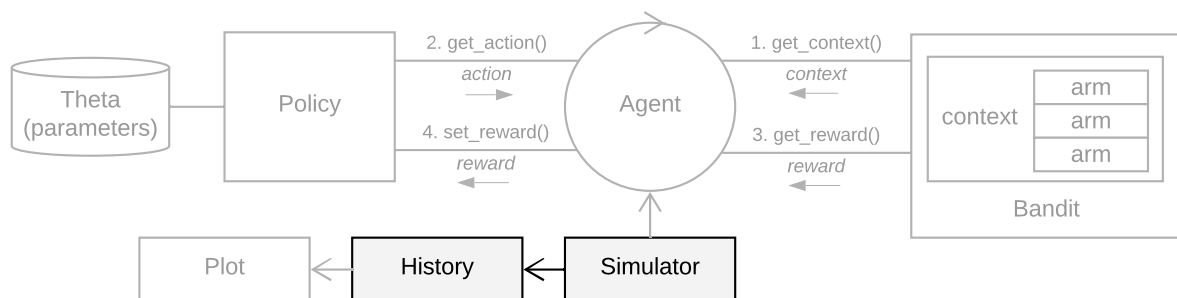

A Simulator aggregates the data acquired during a simulation in a History object's private `data.table` log. It also calculates per agent average cumulative reward, and, when the optimal outcome per `t` is known, per agent average cumulative regret. It is furthermore possible to `plot()` a History object, `summarize()` it, or obtain, for example, a `data.frame()` or a `data.table()` from any History instance:

```
history      <- Simulator$new(agent)$run()
dt           <- history$get_data_table()
df           <- history$get_data_frame()
cumulative_regret <- history$cumulative(regret = TRUE)
```

Some other History functions:

- `set(index, t, action, reward, policy_name, simulation_index, context_value = NA, theta_value = NA)` Stores one row of simulation data. Generally not called directly, but rather through a Simulator instance.
- `save(filename = NA)` Writes History to a file with name filename.
- `load(filename, interval = 0)` Reads a History log file with name filename. If interval is larger than 0, every other interval row of data is read instead of the full data file.
- `reindex(truncate = TRUE)` Removes empty rows from the History log, reindexes the t column, and, when truncate is TRUE, truncates the resulting data to the number of rows of the shortest simulation.

### Plot

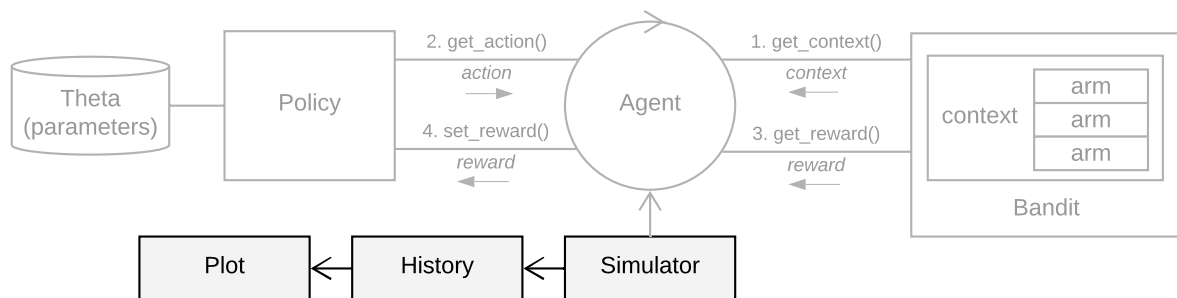

The Plot class takes an History object and offers several ways to plot it, each optimized to be able to plot gigabytes worth of data, quickly:

- **average**: plots the average reward or regret over all simulations per Agent instance (that is, over each Bandit and Policy instance combo) over time.
- **cumulative**: plots the average reward or regret over all simulations per Agent instance over time.
- **arms**: plots ratio of arms chosen on average at each time step, in percentages, totaling 100

Plot objects can be instantiated directly, or, more commonly, by calling the `plot()` function. In either case, make sure to specify a History instance and one of the plot types specified above:

```
# plot a history object through default generic plot() function
plot(history, type = "arms")
```

```
# or call the Plot() directly
p1 <- Plot$new()$cumulative(history)
p2 <- Plot$new()$average(history)
```

Multiple Agent instances can be displayed within one Plot, and multiple plots can themselves again be combined into one graph<sup>12</sup>. Some example plots that illustrate many of Plot()'s features:

<sup>12</sup>To do so, call `plot()` with `no_par = TRUE`. This enables the setting of custom plotting parameters through R's default `par()` functionality, allowing the formatting, layout and combination of single or multiple plots.

```
weights <- matrix(c(0.7, 0.2, 0.2), 1, 3)

bandit <- ContextualBernoulliBandit$new(weights = weights)

agents <- list(Agent$new(RandomPolicy$new(), bandit),
              Agent$new(OraclePolicy$new(), bandit),
              Agent$new(ThompsonSamplingPolicy$new(1.0, 1.0), bandit),
              Agent$new(Exp3Policy$new(0.1), bandit),
              Agent$new(GittinsBrezziLaiPolicy$new(), bandit),
              Agent$new(UCB1Policy$new(), bandit))

history <- Simulator$new(agents, horizon = 100, simulations = 1000)$run()

plot(history, type = "cumulative", use_colors = FALSE, legend_border = FALSE,
      limit_agents = c("GittinsBrezziLai", "UCB1", "ThompsonSampling"))

plot(history, type = "cumulative", regret = FALSE, legend = FALSE,
      limit_agents = c("Exp3"), traces = TRUE, no_par = TRUE)

plot(history, type = "cumulative", regret = FALSE, rate = TRUE,
      limit_agents = c("Exp3", "ThompsonSampling"), disp = "sd",
      legend_position = "bottomright", legend_border = FALSE)

plot(history, type = "cumulative", rate = TRUE, plot_only_disp = TRUE,
      disp = "var", smooth = TRUE, legend_position = "bottomleft",
      limit_agents = c("Exp3", "ThompsonSampling"), legend_border = FALSE)

plot(history, type = "average", disp = "ci", regret = FALSE, interval = 10,
      smooth = TRUE, legend_position = "bottomright", legend = FALSE)

plot(history, limit_agents = c("ThompsonSampling"), type = "arms",
      interval = 20)
```



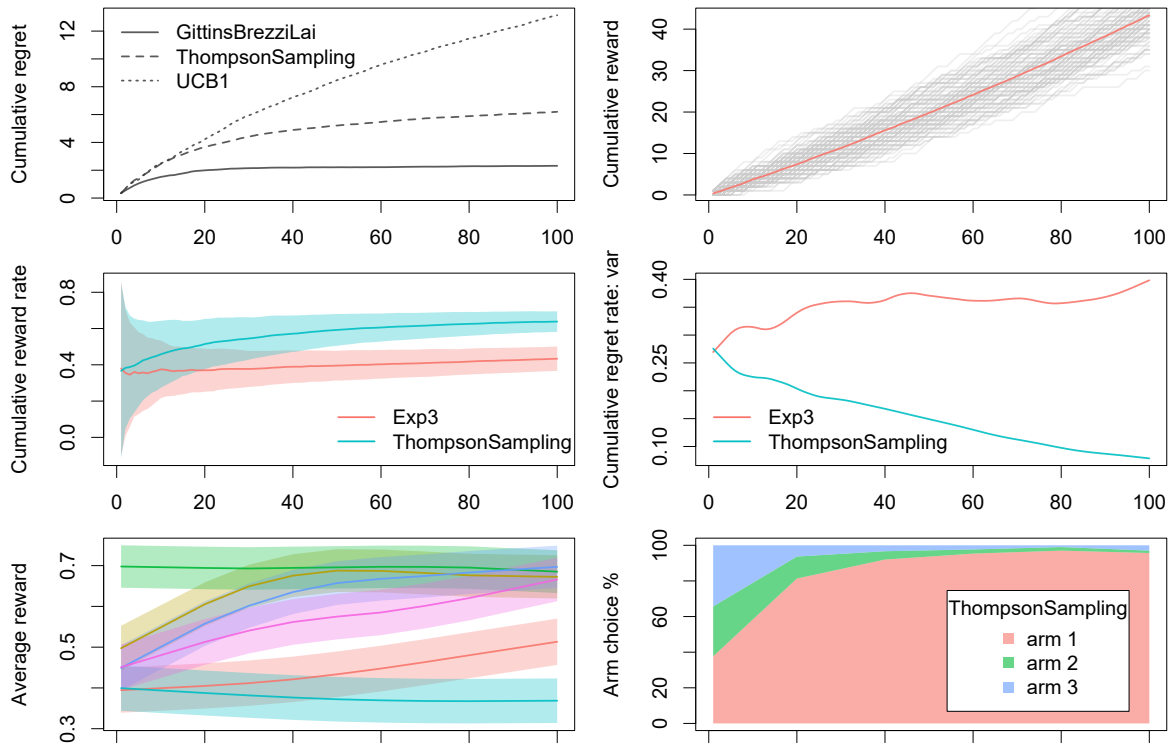

Figure 5: Overview highlighting the versatility of contextual’s Plot() class. From left to right, and top to bottom: 1. Grayscale plot 2. Plotting individual simulation traces 3. Cumulative reward with standard deviation over simulations 4. Dispersion plot (here, variance) 5. Color plot with 95% confidence interval 6. Arm choice percentage plot.

## 5. Custom bandits and policies

The current section illustrates how to develop custom Bandit and Policy subclasses through an exploration of **contextual**’s ContextualBernoulliBandit and its EpsilonFirst, EpsilonGreedy, and LinUCB policy implementations.

### 5.1. ContextualBernoulliBandit: a minimal contextual Bernoulli bandit

Where not otherwise noted, all Bandit implementations in the current paper refer to (or will be configured as) multi-armed Bandits with Bernoulli rewards. For Bernoulli Bandits, the reward received is either a zero or a one: on each  $t$  they offer either a reward of 1 with probability  $p$  or a reward of 0 with probability  $1 - p$ . In other words, a Bernoulli bandit has a finite set of arms  $k \in \{1, \dots, K\}$  where the rewards for each arm  $k$  is distributed Bernoulli with parameter  $\theta_k$  for the expected reward of the arm.

One example of a very simple contextual Bernoulli bandit is **contextual**’s basic weight-based contextual Bandit implementation, ContextualBernoulliBandit:

```
ContextualBernoulliBandit <- R6::R6Class(
  inherit = Bandit,
```

```

class = FALSE,
public = list(
  weights = NULL,
  class_name = "ContextualBernoulliBandit",
  initialize = function(weights) {
    self$weights      <- weights      # d x k weight matrix
    self$d            <- nrow(weights) # d features
    self$k            <- ncol(weights) # k arms
  },
  get_context = function(t) {
    # generate d dimensional feature vector, one random feature active at a time
    Xa <- sample(c(1,rep(0,self$d-1)))
    # convert to d x k matrix: one feature vector, recycled to every arm
    X <- matrix(Xa, self$d, self$k)
    context <- list(
      X = X,
      k = self$k,
      d = self$d
    )
  },
  get_reward = function(t, context, action) {
    # which arm was selected?
    arm <- action$choice
    # d dimensional feature vector for chosen arm
    Xa <- context$X
    # weights of active context
    weight <- Xa %*% self$weights
    # assign rewards for active context with weighted probs
    rewards <- as.double(weight > runif(self$k))
    optimal_arm <- which_max_tied(weight)
    reward <- list(
      reward = rewards[arm],
      optimal_arm = optimal_arm,
      optimal_reward = weight[optimal_arm]
    )
  }
)
)
)

```

`ContextualBernoulliBandit` expects a  $d \times k$  weights matrix, where every element in `weights` represents the average probability of `ContextualBernoulliBandit` returning a reward of 1 over each of its  $k$  arms as dependent on the currently active contextual feature.

## 5.2. EpsilonFirstPolicy

An important feature of **contextual** is that it eases the conversion from formal and pseudocode policy descriptions to clean R6 classes. We will give several examples of such conversions in the current

paper, starting with the implementation of the  $\epsilon$ -first algorithm. In this context-free, "naive" policy, also known as AB(C) testing, a pure exploration phase is followed by a pure exploitation phase.

In that respect, the  $\epsilon$ -first algorithm is equivalent to a randomized controlled trial (RCT). An RCT, generally referred to as the gold standard clinical research paradigm, is a study design where subjects are allocated at random to receive one of several clinical interventions. On completion of an RCT, the interventions are compared. If one intervention proves significantly better than the others, that intervention is suggested to be the superior "evidence-based" option from then on.

In other words: an  $\epsilon$ -first policy starts out by exploring arms at random during the first  $\epsilon \cdot N$  time steps. The following  $(1 - \epsilon) \cdot N$  steps,  $\epsilon$ -first fully exploits the arm that proved the best during the previous  $\epsilon \cdot N$  exploration phase. In pseudocode:

---

**Algorithm 1**  $\epsilon$ -first
 

---

**Require:**  $N \in \mathbb{Z}^+$  - horizon of the experiment.

**Require:**  $\epsilon \in [0, 1]$  - exploration tuning parameter

$n_k \leftarrow 0$  for all actions  $a \in \{1, \dots, \mathcal{A}\}$  (count how many times an arm has been chosen)

$\hat{\mu}_k \leftarrow 0$  for all actions  $a \in \{1, \dots, \mathcal{A}\}$  (estimate of expected reward per arm)

**for**  $t = 1, \dots, T$  **do**

**if**  $t \leq \epsilon \cdot N$  **then**

    play a random arm out of all actions  $a \in \{1, \dots, \mathcal{A}\}$

**else**

    play action  $a_t = \arg \max_a \hat{\mu}_{t-1,a}$  with ties broken arbitrarily

**end if**

  observe real-valued payoff  $r_t$

$n_{a_t} \leftarrow n_{a_{t-1}} + 1$  // Update count

$\hat{\mu}_{t,a_t} \leftarrow \frac{r_t - \hat{\mu}_{t-1,a_t}}{n_{a_t}}$  // Update expected reward

**end for**

---

And the above pseudocode converted to an EpsilonFirstPolicy class:

```
EpsilonFirstPolicy <- R6::R6Class(
  portable = FALSE,
  class = FALSE,
  inherit = Policy,
  public = list(
    first = NULL,
    class_name = "EpsilonFirstPolicy",
    initialize = function(epsilon = 0.1, N = 1000, time_steps = NULL) {
      super$initialize()
      self$first <- ceiling(epsilon*N)
      if (!is.null(time_steps)) self$first <- time_steps
    },
    set_parameters = function(context_params) {
      self$theta_to_arms <- list('n' = 0, 'mean' = 0)
      # Here we define a list with 'n' and 'mean' theta parameters to each
      # arm through helper variable self$theta_to_arms. That is, when the
```

```

# number of arms is 'k', the above would equal:

# self$theta <- list(n = rep(list(0,k)), 'mean' = rep(list(0,k)))

# ... which would also work just fine, but is much less concise.

# When assigning both to self$theta directly & via self$theta_to_arms,
# make sure to do it in that particular order.
},
get_action = function(t, context) {
  if (sum_of(self$theta$n) < self$first) {
    action$choice      <- sample.int(context$k, 1, replace = TRUE)
    action$propensity  <- (1/context$k)
  } else {
    action$choice      <- which_max_list(self$theta$mean)
    action$propensity  <- 1
  }
  action
},
set_reward = function(t, context, action, reward) {
  arm          <- action$choice
  reward       <- reward$reward
  inc(self$theta$n[[arm]]) <- 1
  if (sum_of(self$theta$n) < self$first - 1) {
    inc(self$theta$mean[[arm]]) <-
      (reward - self$theta$mean[[arm]]) / self$theta$n[[arm]]
  }
  self$theta
}
)
)

```

To evaluate this policy, instantiate both an `EpsilonFirstPolicy` and a `ContextualBernoulliBandit`. Then add the `Bandit/Policy` pair to an `Agent`. Next, add the `Agent` to a `Simulator`. Finally, run the `Simulator`, and `plot()` the its `History` log:

```

horizon          <- 100
simulations      <- 1000
weights          <- matrix(c(0.6, 0.2, 0.2), 1, 3)

policy           <- EpsilonFirstPolicy$new(epsilon = 0.5, N = horizon)
bandit           <- ContextualBernoulliBandit$new(weights = weights)

agent            <- Agent$new(policy,bandit)

simulator        <- Simulator$new(agents = agent,
                                horizon = horizon,

```

```

simulations = simulations)

history           <- simulator$run()

plot(history, type = "cumulative")
plot(history, type = "arms")

```

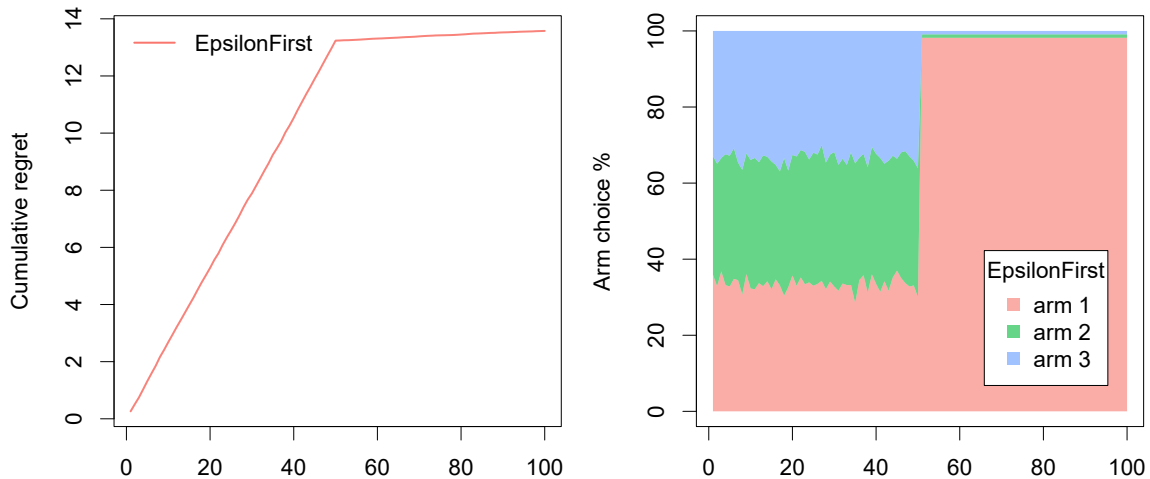

Figure 6: To the left, Epsilon First policy's cumulative regret over time. To the right, the percentage of simulations per time step for which each of the bandit's three arms were chosen. As can be observed in the arm choice plot, after fifty steps of exploration, the policy has settled overwhelmingly on arm one. On exploiting this arm, from thereon, it suffers significantly less regret than before.

### 5.3. EpsilonGreedyPolicy

Contrary to the previously introduced  $\epsilon$ -first policy, an  $\epsilon$ -greedy algorithm (Sutton and Barto 1998) does not divide exploration and exploitation into two strictly separate phases—it explores with a probability of  $\epsilon$  and exploits with a probability of  $1 - \epsilon$ , right from the start. That is, an  $\epsilon$ -greedy policy with an  $\epsilon$  of 0.1 explores arms at random 10% of the time. The other  $1 - \epsilon$ , or 90% of the time, the policy "greedily" exploits the currently best-known arm.

This can be formalized in pseudocode as follows:

**Algorithm 2**  $\epsilon$ -greedy**Require:**  $\epsilon \in [0, 1]$  - exploration tuning parameter $n_a \leftarrow 0$  for all actions  $a \in \{1, \dots, \mathcal{A}\}$  (count how many times an action has been chosen) $\hat{\mu}_a \leftarrow 0$  for all actions  $a \in \{1, \dots, \mathcal{A}\}$  (estimate of expected reward per action)**for**  $t = 1, \dots, T$  **do**  **if** sample from  $\text{unif}(0, 1) > \epsilon$  **then**    play action  $a_t = \arg \max_a \hat{\mu}_{t-1, a}$  with ties broken arbitrarily  **else**    play a random action out of all actions  $a \in \{1, \dots, \mathcal{A}\}$   **end if**  observe real-valued payoff  $r_t$    $n_{a_t} \leftarrow n_{a_{t-1}} + 1$  // Update count   $\hat{\mu}_{t, a_t} \leftarrow \frac{r_t - \hat{\mu}_{t-1, a_t}}{n_{a_t}}$  // Update expected reward**end for**

Converted to an EpsilonGreedyPolicy class:

```

#' @export
EpsilonGreedyPolicy      <- R6::R6Class(
  portable = FALSE,
  class = FALSE,
  inherit = Policy,
  public = list(
    epsilon = NULL,
    class_name = "EpsilonGreedyPolicy",
    initialize = function(epsilon = 0.1) {
      super$initialize()
      self$epsilon <- epsilon
    },
    set_parameters = function(context_params) {
      self$theta <- list('exploit' = 0)
      self$theta_to_arms <- list('n' = 0, 'mean' = 0)
    },
    get_action = function(t, context) {
      if (runif(1) > self$epsilon) {
        # exploit best arm
        self$theta$exploit <- 1
        self$action$choice <- which_max_list(self$theta$mean)
        self$action$propensity <- 1 - self$epsilon
      } else {
        # explore any arm
        self$theta$exploit <- 0
        self$action$choice <- sample.int(context$k, 1, replace = TRUE)
        self$action$propensity <- self$epsilon*(1/context$k)
      }
    }
  )

```

```

    self$action
  },
  set_reward = function(t, context, action, reward) {
    arm          <- action$choice
    reward       <- reward$reward
    self$theta$n[[arm]] <- self$theta$n[[arm]] + 1
    self$theta$mean[[arm]] <- self$theta$mean[[arm]] +
      (reward - self$theta$mean[[arm]]) / self$theta$n[[arm]]
    self$theta
  }
)
)

```

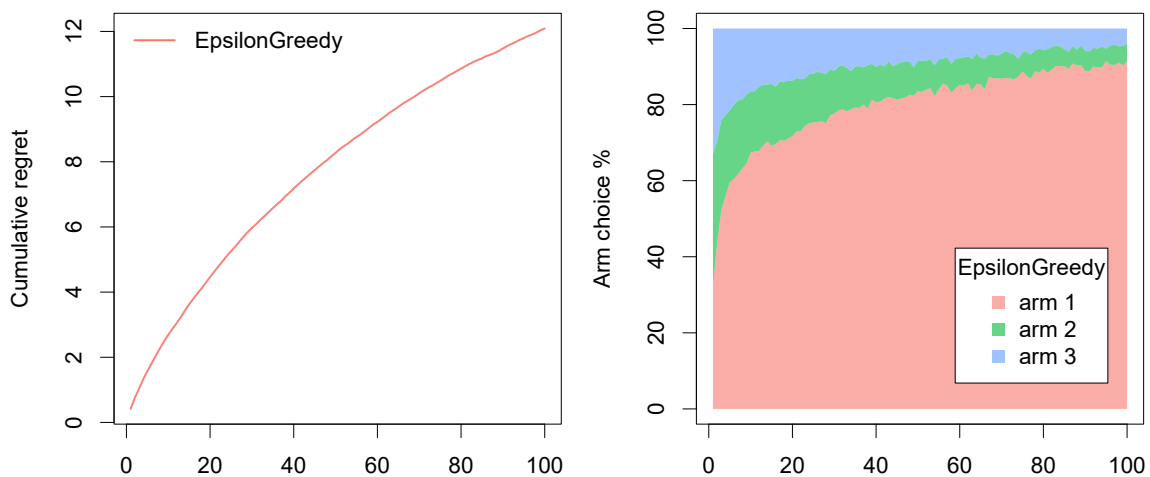

Figure 7: To the left, Epsilon Greedy policy’s cumulative regret over time. To the right, the percentage of simulations per time step for which each of the bandit’s three arms where chosen. The Epsilon Greedy policy starts to both explore and exploit right from the start, gradually choosing the best arm more and more.

Assign the new class, together with `ContextualBernoulliBandit`, to an `Agent`. Again, assign the `Agent` to a `Simulator`. Then run the `Simulator` and `plot()`:

```

horizon          <- 100
simulations      <- 1000
weights          <- matrix(c(0.8, 0.2, 0.2), 1, 3)

policy           <- EpsilonGreedyPolicy$new(epsilon = 0.1)
bandit           <- ContextualBernoulliBandit$new(weights = weights)

agent            <- Agent$new(policy, bandit)

simulator        <- Simulator$new(agents = agent,
                                  horizon = horizon,

```

```

simulations = simulations)

history          <- simulator$run()

plot(history, type = "cumulative")
plot(history, type = "arms")

```

#### 5.4. Contextual Bandit: LinUCB with linear disjoint models

As a final example of how to subclass **contextual**'s `Bandit` superclass, we move from context-free algorithms to a contextual one. As described in Section 1, contextual bandits make use of side information to help them choose the current best arm to play. For example, contextual information such as a website visitors' location may be related to which article's headline (or arm) on the frontpage of the website will be clicked on most.

Here, we show how to implement and evaluate probably one of the most cited out of all contextual policies, the LinUCB algorithm with Linear Disjoint Models [Li et al. \(2010\)](#). The policy is more complicated than the previous two bandits, but when following its pseudocode description to the letter, it translates nicely to yet another `Bandit` subclass.

The LinUCB algorithm employs ridge regression with feature vectors and rewards per arm to predict rewards using the trials performed so far. Importantly, the algorithm also generates a confidence interval for this predicted payoff. The policy then chooses the arm with the highest upper confidence bound. In pseudocode, following Algorithm 1 from [Li et al. \(2010\)](#):

---

#### Algorithm 3 LinUCB with linear disjoint models

---

**Require:**  $\alpha \in \mathbb{R}^+$ , exploration tuning parameter

```

for  $t = 1, \dots, T$  do
  Observe features of all actions  $a \in \mathcal{A}_t : x_{t,a} \in \mathbb{R}^d$ 
  for  $a \in \mathcal{A}$  do
    if  $a$  is new then
       $A_a \leftarrow I_d$  (d-dimensional identity matrix)
       $b_a \leftarrow 0_{d \times 1}$  (d-dimensional zero vector)
    end if
     $\hat{\theta}_a \leftarrow A_a^{-1} b_a$ 
     $p_{t,a} \leftarrow \hat{\theta}_a^T + \alpha \sqrt{x_{t,a}^T A_a^{-1} x_{t,a}}$ 
  end for
  Play action  $a_t = \arg \max_a p_{t,a}$  with ties broken arbitrarily and observe real-valued payoff  $r_t$ 
   $A_{a_t} \leftarrow A_{a_t} + x_{t,a_t} x_{t,a_t}^T$ 
   $b_{a_t} \leftarrow b_{a_t} + r_t x_{t,a_t}$ 
end for

```

---

Next, translating the above pseudocode into a well organized `Bandit` subclass:

```

LinUCBDisjointPolicy <- R6::R6Class(
  portable = FALSE,
  class = FALSE,

```



```

inherit = Policy,
public = list(
  alpha = NULL,
  class_name = "LinUCBDisjointPolicy",
  initialize = function(alpha = 1.0) {
    super$initialize()
    self$alpha <- alpha
  },
  set_parameters = function(context_params) {
    ul <- length(context_params$unique)
    self$theta_to_arms <- list('A' = diag(1,ul,ul), 'b' = rep(0,ul))
  },
  get_action = function(t, context) {
    expected_rewards <- rep(0.0, context$k)
    for (arm in 1:context$k) {
      Xa      <- get_arm_context(context, arm, context$unique)
      A      <- self$theta$A[[arm]]
      b      <- self$theta$b[[arm]]
      A_inv  <- inv(A)
      theta_hat <- A_inv %*% b
      mu_hat  <- Xa %*% theta_hat
      sigma_hat <- sqrt(tcrossprod(Xa %*% A_inv, Xa))
      expected_rewards[arm] <- mu_hat + self$alpha * sigma_hat
    }
    action$choice <- which_max_tied(expected_rewards)
    action
  },
  set_reward = function(t, context, action, reward) {
    arm <- action$choice
    reward <- reward$reward
    Xa <- get_arm_context(context, arm, context$unique)
    inc(self$theta$A[[arm]]) <- outer(Xa, Xa)
    inc(self$theta$b[[arm]]) <- reward * Xa
    self$theta
  }
)
)

```

Let us now evaluate the above `LinUCBDisjointPolicy` using a Bernoulli ContextualBernoulliBandit with three arms and three context features. In the code below we define each of `ContextualBernoulliBandit`'s arms to be, on average, equally probable to return a reward. As can be confirmed in the two plots to the right below, where `EpsilonGreedyPolicy` and `LinUCBDisjointPolicy` actually show no difference in their overall arm preference. Yet `LinUCBDisjointPolicy`'s awareness of the changing context allows it to learn the relationships between arms, rewards, and features, and select the right arm in the right context—as can be observed in the bottom row of Figure 8.

```
horizon      <- 100L
simulations  <- 1000L

# k=1 k=2 k=3          -> columns represent arms
weights      <- matrix(c(0.6, 0.2, 0.2,      # d=1 -> rows represent
                        0.2, 0.6, 0.2,      # d=2   context features,
                        0.2, 0.2, 0.6),      # d=3
                       nrow = 3, ncol = 3, byrow = TRUE)

bandit       <- ContextualBernoulliBandit$new(weights = weights)

eg_policy    <- EpsilonGreedyPolicy$new(0.1)
lucb_policy  <- LinUCBDisjointPolicy$new(0.6)

agents       <- list(Agent$new(eg_policy, bandit, "EGreedy"),
                    Agent$new(lucb_policy, bandit, "LinUCB"))

simulation   <- Simulator$new(agents, horizon, simulations, save_context = TRUE)
history      <- simulation$run()

plot(history, type="cumulative", legend_border = FALSE)
plot(history, type="arms", limit_agents = c("LinUCB"))
plot(history, type="arms", limit_agents = c("EGreedy"))

plot(history, type="arms", limit_agents = c("LinUCB"), limit_context = c("X.1"))
plot(history, type="arms", limit_agents = c("LinUCB"), limit_context = c("X.2"))
plot(history, type="arms", limit_agents = c("LinUCB"), limit_context = c("X.3"))
```

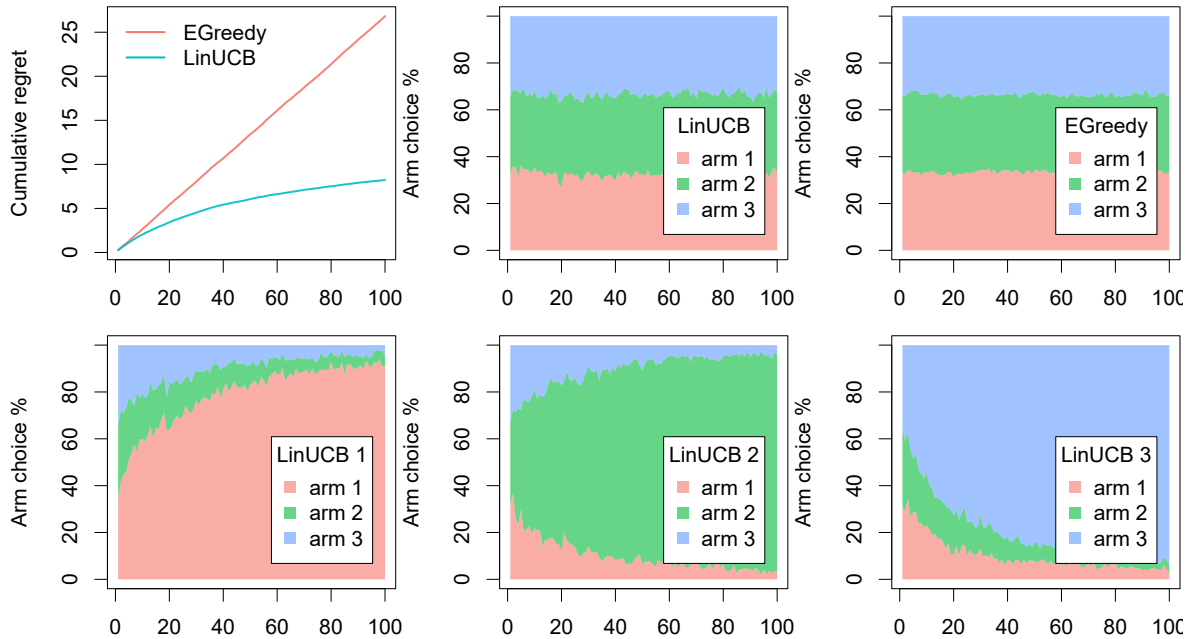

Figure 8: Top left a plot of Epsilon Greedy versus LinUCB policies' cumulative regret over time. Top middle and right, Epsilon Greedy and LinUCB policies' average arm choice percentage per  $t$ , which indicate that, overall, both policies choose each arm about equally often. To see why LinUCB is able to do better than Epsilon Greedy, we need to look at the bottom row, whose three plots represent LinUCB's average arm choice percentage by context feature. These bottom row plots show how LinUCB is able to make use of contextual features to map actions to rewards.

## 6. Subclassing bandits and policies

The **contextual** package's extensibility does not limit itself to the subclassing of Policy classes. Through its R6 based object system it is easy to extend and override any **contextual** super- or subclass. Below, we demonstrate how to apply that extensibility to sub-subclass one Bandit and one Policy subclass. First, we extend **contextual**'s context-free **BasicBernoulliBandit**, replacing its Bernoulli based reward function with a Poisson based one (Presman 1991). Next, we implement an **EpsilonGreedyAnnealingPolicy** version of the  $\epsilon$ -greedy policy introduced in Section 5.3—where its **EpsilonGreedyAnnealingPolicy** subclass introduces a gradual reduction ("annealing") of the policy's *epsilon* parameter over  $T$  (Cesa-Bianchi and Fischer 1998; Kirkpatrick, Gelatt, and Vecchi 1983), in effect making the policy more exploitative over time.

```
BasicPoissonBandit <- R6::R6Class(
  inherit = BasicBernoulliBandit,
  class = FALSE,
  public = list(
    weights = NULL,
    class_name = "BasicPoissonBandit",
    # Override get_reward & generate Poisson based rewards
```

```

get_reward = function(t, context, action) {
  reward_means = rep(2,self$k)
  rpm <- rpois(self$k, reward_means)
  rewards <- matrix(rpm < self$weights, self$k, 1)*1
  optimal_arm <- which_max_tied(self$weights)
  reward <- list(
    reward = rewards[action$choice],
    optimal_arm = optimal_arm,
    optimal_reward = rewards[optimal_arm]
  )
}
)
)
)

EpsilonGreedyAnnealingPolicy <- R6::R6Class(
  # Class extends EpsilonGreedyPolicy
  inherit = EpsilonGreedyPolicy,
  portable = FALSE,
  public = list(
    class_name = "EpsilonGreedyAnnealingPolicy",
    # Override EpsilonGreedyPolicy's get_action, use annealing epsilon
    get_action = function(t, context) {
      self$epsilon <- 1/(log(100*t+0.001))
      super$get_action(t, context)
    }
  )
)

weights <- c(7,1,2)
horizon <- 200
simulations <- 1000
bandit <- BasicPoissonBandit$new(weights)
ega_policy <- EpsilonGreedyAnnealingPolicy$new()
eg_policy <- EpsilonGreedyPolicy$new(0.2)
agents <- list(Agent$new(ega_policy, bandit, "EG Annealing"),
              Agent$new(eg_policy, bandit, "EG"))
simulation <- Simulator$new(agents, horizon, simulations, do_parallel = FALSE)
history <- simulation$run()

par(mfrow = c(1, 3), mar = c(2, 4, 1, 0.1), cex=1.3) #bottom, left, top, and right.

plot(history, type = "cumulative", no_par = TRUE, legend_border = FALSE,
      legend_position = "bottomright")
plot(history, type = "arms", limit_agents = c("EG Annealing"), no_par = TRUE,
      interval = 25)
plot(history, type = "arms", limit_agents = c("EG"), no_par = TRUE,

```

interval = 25)

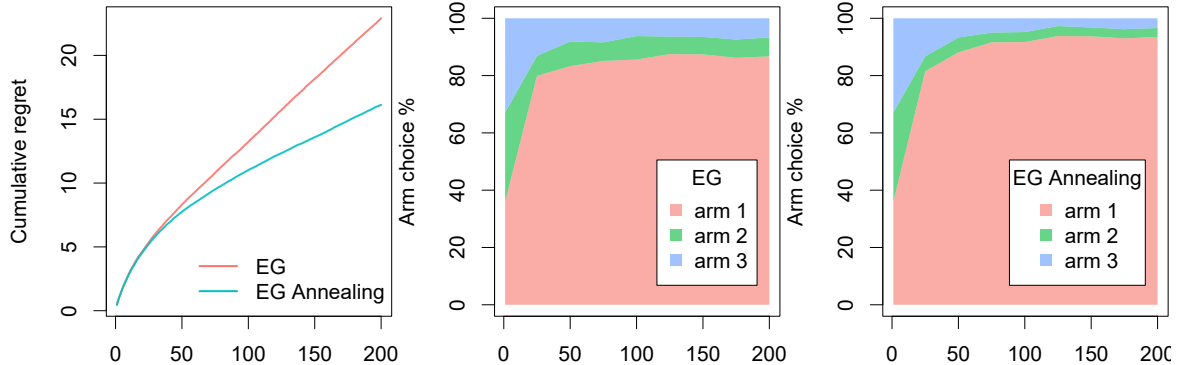

Figure 9: To the left, both policies’ cumulative regret over time. Middle and right, the percentage of simulations per time step for which each of the bandit’s three arms were chosen. In the rightmost plot, it can be observed that, in contrast to its non-annealing cousin, the annealing policy is able to explore the sub-optimal arms less and less over time.

## 7. Offline evaluation

As demonstrated in the previous section, it is relatively easy to evaluate MAB and CMAB policies against basic synthetic bandits. Still, the creation of more elaborate synthetic bandits can become very difficult very fast (Strehl, Li, Wiewiora, Langford, and Littman 2006a). Moreover, even when these technical hurdles are surmounted, synthetic bandits generally remain biased with respect to the real world interactions they aim to model (Li *et al.* 2012, 2011).

One way to overcome these limitations would be to evaluate policies in a live setting. Online evaluations can deliver unbiased, realistic estimates of a policy’s effectiveness. They are, however, generally much slower than synthetic evaluation, as online evaluations are dependent on active user interventions (Mandel, Liu, Brunskill, and Popovic 2016; Tewari and Murphy 2017). Also, testing of potentially suboptimal policies on live audiences, such as patients or customers, can be dangerous, expensive, or even unethical (Bastani and Bayati 2015).

Fortunately, there is a third option: the evaluation of policies on logged bandit feedback. Such logs are widely available to little or no cost<sup>13</sup>, and their use in the "offline" or "batched" evaluation of policies does not have any of the potential adverse effects of online testing. There is a catch, however: With logged interaction data, we only have access to rewards awarded to actions that were chosen by some other policy at a previous time—but we are interested in the rewards for choices made by the policy under evaluation right now. In other words, such logs only contain partial feedback with respect to the policy under evaluation (Strehl, Langford, Li, and Kakade 2010).

So we need some bandit that can evaluate policies on interaction logs that were generated by another policy at another time. Such a bandit would need to be:

<sup>13</sup>Generally, interaction logs already generated by default in many types of interactive systems, from online search to news recommendation and online advertising.

- Off-policy: The bandit has to be able to compare the policy under evaluation against data generated by another policy at another time (Li *et al.* 2012, 2011).
- Counterfactual: The bandit needs some strategy for when the policy under evaluation chooses a different, "counterfactual" action from the one chosen by the logged policy (Bottou, Peters, Quiñero-Candela, Charles, Chickering, Portugaly, Ray, Simard, and Snelson 2013; Swaminathan and Joachims 2015).

In the next section, we introduce **contextual**'s implementation of Li *et al.* (2011)'s offline, off-policy "replay" (Nicol 2014) evaluator as a first example of such a "counterfactual" bandit.

### 7.1. The replay method

One approach to the use of offline data in off-policy evaluation is to recognize that we need to limit our evaluation to those rows of data where the action taken by the original logging policy equals the action suggested by the policy under evaluation (Li *et al.* 2012, 2011). Such a so-called "replay" type bandit goes over every logged row  $(x_t, a_t, r_t)$ , and only uses those (on average)  $1/K$  rows where the action chosen by the policy under evaluation is the same as the original, off-policy action (Nicol 2014).

In other words, for each  $t$  in  $T$ , a replay bandit:

- Retrieves initially logged context  $x_t$  from  $D$  and makes it available to the policy under evaluation.
- Tests whether the action  $a_t$  as chosen by the policy under evaluation equals the one that was logged in  $D$ .
- If both actions are the same, the bandit makes the originally logged reward available to the policy under evaluation. If not, the current row of  $D$  is not taken into account.

In pseudocode, following Algorithm 2 from Li *et al.* (2011):

---

#### Algorithm 4 Replay Policy Evaluator

---

**Require:** Policy  $\pi$

Data stream of randomly allocated events  $S$  of length  $T$

$h_0 \leftarrow \emptyset$  An initially empty history log

$R_\pi \leftarrow 0$  An initially zero total cumulative reward

$L \leftarrow 0$  An initially zero length counter of valid events

**for**  $t = 1, \dots, T$  **do**

  Get the  $t$ -th event  $(x_{t,a_t}, a_t, r_{t,a_t})$  from  $S$

**if**  $\pi(h_{t-1}, x_{t,a_t}) = a_t$  **then**

$h_t \leftarrow \text{CONCATENATE}(h_{t-1}, (x_{t,a_t}, a_t, r_{t,a_t}))$

$R_\pi = R_\pi + r_{t,a_t}$

$L = L + 1$

**else**

$h_t \leftarrow h_{t-1}$

**end if**

**end for**

Output: rate of cumulative regret  $R_\pi/L$

---

Below, an implementation of this algorithm (a version of **contextual**'s `OfflineReplayEvaluatorBandit`), followed by an offline evaluation and comparison of **contextual**'s `LinUCBDisjointPolicy` for four different values of its  $\alpha$  parameter. We feed the replay bandit a personalization dataset<sup>14</sup> consisting of a text file with 10000 rows, each row consisting of 102 space separated columns. The first of these columns represents which out of ten actions was performed. The second of the columns is a binary reward, and the remaining columns constitute the  $x_t \in \mathbb{R}^{100}$  context vector, stored as integers for numerical efficiency (Lebera 2018).

```
library(contextual)
library(data.table)

# Define Replay Bandit
OfflineReplayEvaluatorBandit <- R6::R6Class(
  inherit = Bandit,
  private = list(
    S = NULL
  ),
  public = list(
    class_name = "OfflineReplayEvaluatorBandit",
    initialize = function(offline_data, k, d) {
      self$k <- k # Number of arms
      self$d <- d # Context feature vector dimensions
      private$S <- offline_data # Logged events
    },
    get_context = function(index) {
      context <- list(
        k = self$k,
        d = self$d,
        X = private$S$context[[index]]
      )
      context
    },
    get_reward = function(index, context, action) {
      if (private$S$choice[[index]] == action$choice) {
        list(
          reward = as.double(private$S$reward[[index]])
        )
      } else {
        NULL
      }
    }
  )
)

# Import personalization data-set
```

<sup>14</sup>Made available by T. Lebera's for use in his "Machine Learning for Personalization" course at <http://www.cs.columbia.edu/~jebara/6998/>

```

url      <- "http://d1ie9wlkzugsxr.cloudfront.net/data_cmab_basic/dataset.txt"
datafile <- fread(url)

# Clean up datafile
datafile[, context := as.list(as.data.frame(t(datafile[, 3:102])))]
datafile[, (3:102) := NULL]
datafile[, t := .I]
datafile[, sim := 1]
datafile[, agent := "linucb"]
setnames(datafile, c("V1", "V2"), c("choice", "reward"))

# Set simulation parameters.
simulations <- 1
horizon     <- nrow(datafile)

# Initiate Replay bandit with 10 arms and 100 context dimensions
log_S      <- datafile
bandit     <- OfflineReplayEvaluatorBandit$new(log_S, k = 10, d = 100)

# Define agents.
agents     <-
  list(Agent$new(LinUCBDisjointOptimizedPolicy$new(0.01), bandit, "alpha = 0.01"),
        Agent$new(LinUCBDisjointOptimizedPolicy$new(0.05), bandit, "alpha = 0.05"),
        Agent$new(LinUCBDisjointOptimizedPolicy$new(0.1), bandit, "alpha = 0.1"),
        Agent$new(LinUCBDisjointOptimizedPolicy$new(1.0), bandit, "alpha = 1.0"))

# Initialize the simulation.
simulation <-
  Simulator$new(
    agents      = agents,
    simulations  = simulations,
    horizon     = horizon,
    save_context = TRUE
  )

# Run the simulation.
linucb_sim <- simulation$run()

# Plot the results.
# plot the results
plot(linucb_sim, type = "cumulative", legend_title = "LinUCB",
     rate = TRUE, regret = FALSE, legend_position = "bottomright")

```

See Figure 10 for a plot of the resulting cumulative reward rate over time.



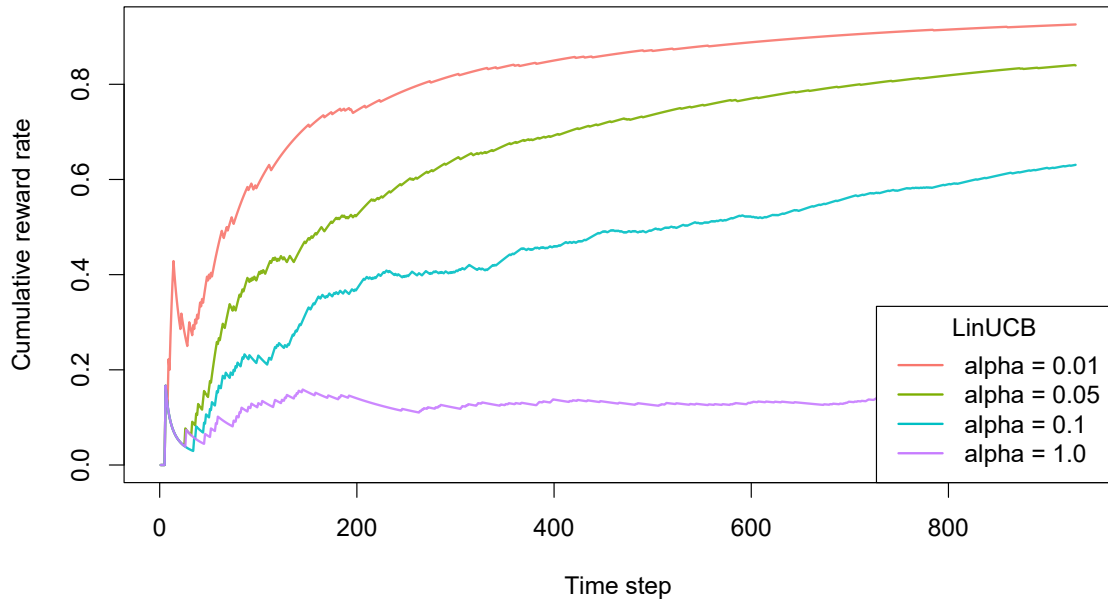

Figure 10: LinUCBHybridPolicy evaluated with OfflineReplayEvaluatorBandit. As the original logging policy randomly allocated actions to each of ten available arms, the logged and evaluated policy’s actions correspond to each other about  $1/K = 1/10$  or 1,000 out of the original 10,000 events.

The replay method works well for logs where the original logging policy randomly allocated actions over the available arms,  $p(a) = 1/K$ . Where this is not the case, however, data generating policies can additionally calculate probabilities  $p_{t,a_t}$  of selecting an action, returning it as `action$propensity`, in addition to `action$choice` in its `get_action()` call. For instance, in **contextual**’s  $\epsilon$ -greedy implementation:

```
EpsilonGreedyPolicy      <- R6::R6Class(
  ...
  get_action = function(t, context) {
    if (runif(1) > self$epsilon) {
      self$action$choice      <- which_max_list(self$theta$mean)
      self$action$propensity  <- 1 - self$epsilon
    } else {
      self$action$choice      <- sample.int(context$k, 1, replace = TRUE)
      self$action$propensity  <- self$epsilon*(1/context$k)
    }
    self$action
  },
  ...
)
```

This propensity can then:

- Be used for inverse propensity matching or weighting [Austin \(2011\)](#) to estimate the action’s causal effect by accounting for contextual covariates ([Imbens and Rubin 2015](#); [Pearl 2009](#)).

- Stored in the log, resulting in  $D = (x_{t,a_t}, a_t, r_{t,a_t}, p_{t,a_t})$ , and then be used to estimate average rewards using inverse propensity scoring (Horvitz and Thompson 1952) by computing:

$$\text{ips}(\pi) = \frac{1}{N} \sum_{t=1}^N \mathbb{1}\{\pi(x_t) = a_t\} r_t / p_t \quad (3)$$

where the indicator is 1 when  $\pi$ 's action matches the action in the logs (Kruijswijk *et al.* 2018). See **contextual**'s `OfflinePropensityWeightingBandit` for a basic implementation of this mechanism.

The current section is but a short introduction to offline policy evaluation. For more information on inverse propensity scoring, doubly robust evaluation, and other batch or offline evaluation methods, see for example Agarwal, Hsu, Kale, Langford, Li, and Schapire (2014), Dudík *et al.* (2011) and Swaminathan and Joachims (2015).

## 8. Replication of Li et al 2010

In the current section, we demonstrate how **contextual** facilitates the comparison of bandit policies on big offline datasets by running a partial replication of Li *et al.* (2010). This paper describes how the authors made use of offline Yahoo! click-through rate data to evaluate and compare the effectiveness of several context-free and contextual policies—therein introducing both the offline policy evaluator outlined in the previous section and the LinUCB algorithm introduced in Section 5.4.

### 8.1. Description of the data

The dataset used in the Li *et al.* (2010) paper has been made available at the Yahoo! lab's website<sup>15</sup>. It contains the click-through rate from the Today news module on Yahoo!'s homepage over the course of several days in May 2009, totaling 45,811,883 separate events.

Each row in the dataset describes an interaction event (click or no click) of users shown a randomly chosen article. Each of these events contains the following information:

1. The ID's of each of a varying subset of 19 to 25 articles selected by human editors from a pool of 217 articles.
2. The ID of an article randomly chosen from the subset defined in 1. and positioned at the story position (that is, at the top of the Yahoo!'s website's "Today" segment).
3. Six features per article for each of the articles shown.
4. Six user features (with a distinct user for each event).
5. Whether or not a user clicked on the article at the story position.

That is, for each event  $t$  an article represents one of  $A$  actions (that is, one of the 271 articles observed within the course of the 10 days covered by the dataset) with  $\mathbb{R}^6$  features  $X_{t,a}$  per arm, and another  $\mathbb{R}^6$  features  $X_{t,u}$  per unique visitor. Together, the flattened outer product of the user and article feature

<sup>15</sup>At <https://webscope.sandbox.yahoo.com/catalog.php?datatype=r&did=49>

vector creates a  $\mathbb{R}^{36}$  feature vector  $X_t$  for each user and article pair with outcome value or reward  $r_t$  click (1) or no click (0). For the further details on the data structure and the general setup of the experiment, we refer the reader to [Chu \*et al.\* \(2009\)](#) and to the original [Li \*et al.\* \(2010\)](#) paper.

## 8.2. Data import

As the Yahoo data is too large to fit into memory, we imported most<sup>16</sup> of the dataset’s CSV files into a **MonetDB** ([Idreos, Groffen, Nes, Manegold, Mullender, and Kersten 2012](#)) instance—a fast, open source column-oriented database management system with excellent R support<sup>17</sup>. The import script, example import scripts for several other databases (**MySQL**, **SQLite**, **Postgresql**) and all other source code related to this replication can be found in the package’s `demo/replication_li_2010` directory.

## 8.3. Custom bandit and policies

With the Yahoo! data imported into the MonetDB server, the next step was to create a custom offline YahooBandit plus seven Policy subclasses implementing the policies described in the [Li \*et al.\* \(2010\)](#) paper. Though most of these policies were already implemented in **contextual**, the fact that only a subset of all 271 articles or arms are shown to a visitor at a time meant we needed to make some minor changes to **contextual**’s existing classes to make the policies run smoothly on a continually shifting pool of active arms.

To facilitate these shifting arms, YahooBandit makes use of an `self$arm_lookup` table listing all 271 arms. This table enables the bandit to look up the currently active arms’ indexes from the shifting set of article ID’s as specified in the dataset for each time step  $t$ , and return these indexes to the policies under evaluation:

```
get_context = function(index) {
  ...
  # Retrieve the index of all arms this row/event.
  arm_indices_this_event <- seq(10, 184, by = 7)
  article_ids             <- row[arm_indices_this_event]
  article_ids             <- article_ids[!is.na(article_ids)]
  article_ids             <- match(article_ids, self$arm_lookup)
  ...
  context <- list(
    k = self$k,
    d = self$d,
    unique = self$unique, # Indexes of disjoint arms (user features)
    shared = self$shared, # Indexes of shared arms (article features)
    arms = article_ids,   # Indexes of arms this event.
    X = X
  )
}
```

<sup>16</sup>The first two CSV files representing the first two days of the Yahoo! dataset are somewhat irregular, as they contain articles with more than six features. We, therefore, decided to leave these two CSV files out of our import, resulting in 37,450,196 imported events, instead of the 45,811,883 events used in the original paper.

<sup>17</sup>MonetDB can be downloaded at <https://www.monetdb.org/>

The policy classes then use this information to select and update only the currently active subset of arms. For instance, in `YahooEpsilonGreedyPolicy`'s `get_action()`:

```
get_action = function(t, context) {
  if (runif(1) > self$epsilon) {
    # get the max of context$arms *currently in play*
    max_index      <- context$arms[max_in(theta$mean[context$arms])]
    self$action$choice <- max_index
  } else {
    # sample from the arms *currently in play*
    self$action$choice <- sample(context$arms, 1)
  }
  self$action
}
```

On completing the implementation of the aforementioned seven custom policy subclasses (`Random`, `EGreedy`, `EGreedySeg`, `LinUCBDis`, `LinUCBHyb`, `UCB1` and `UCB1Seg`<sup>18</sup>) we then assigned them to six simulations—one for each of the six (0, 30, 20, 10, 5 and 1 percent) levels of sparsity defined in the original paper. This resulted in  $7 \times 6 = 42$  Agents, which were then run on the offline dataset as follows:

```
simulations      <- 1
horizon          <- 37.45e6
...
con <- DBI::dbConnect(MonetDB.R(), host=monetdb_host, dbname=monetdb_dbname,
                      user=monetdb_user, password=monetdb_pass)

message(paste0("MonetDB: connection to '", dbListTables(con), "' succesful!"))

arm_lookup_table <-
  as.matrix(DBI::dbGetQuery(con, "SELECT DISTINCT article_id FROM yahoo"))

arm_lookup_table <- rev(as.vector(arm_lookup_table))

bandit <- YahooBandit$new(k = 217L, unique = c(1:6), shared = c(7:12),
                          arm_lookup = arm_lookup_table, host = monetdb_host,
                          dbname = monetdb_dbname, user = monetdb_user,
                          password = monetdb_pass, buffer_size = buffer_size)

agents <-
  list (Agent$new(YahooLinUCBDisjointPolicy$new(0.2),
                 bandit, name = "LinUCB Dis", sparse = 0.99),
        Agent$new(YahooLinUCBHybridPolicy$new(0.2),
                 bandit, name = "LinUCB Hyb", sparse = 0.99),
```

---

<sup>18</sup>`EGreedyDis` and `EGreedyHyb` policies were too summarily described for us to be able to replicate them with confidence.

```

Agent$new(YahooEpsilonGreedyPolicy$new(0.3),
          bandit, name = "EGreedy",    sparse = 0.99),
Agent$new(YahooEpsilonGreedySegPolicy$new(0.3),
          bandit, name = "EGreedySeg", sparse = 0.99),
Agent$new(YahooUCB1AlphaPolicy$new(0.4),
          bandit, name = "UCB1",      sparse = 0.99),
Agent$new(YahooUCB1AlphaSegPolicy$new(0.4),
          bandit, name = "UCB1Seg",   sparse = 0.99),
...
Agent$new(YahooRandomPolicy$new(),
          bandit, name = "Random"))

simulation <- Simulator$new(
  agents,
  simulations = simulations,
  horizon = horizon,
  do_parallel = TRUE,
  worker_max = worker_max,
  reindex = TRUE,
  progress_file = TRUE,
  include_packages = c("MonetDB.R"))

history <- simulation$run()
...

```

## 8.4. Results

We were able to complete the full  $7 \times 6 = 42$  agent simulation over all of the 37,450,196 events in our database within 22 hours on a 64 core Intel Xeon Ubuntu server with 256GB of memory. We then proceeded to analyse the results of the first 4.7 million events (following the original paper, representing about a day worth of events) to reproduce [Li \*et al.\* \(2010\)](#)'s Figure 4b: "CTRs in evaluation data with varying data sizes in the learning bucket.". Just like the original paper, the replicated Figure 11 reports each algorithm's relative CTR for all of the defined data sparsity levels, that is, each algorithm's CTR divided by the random policy's CTR.

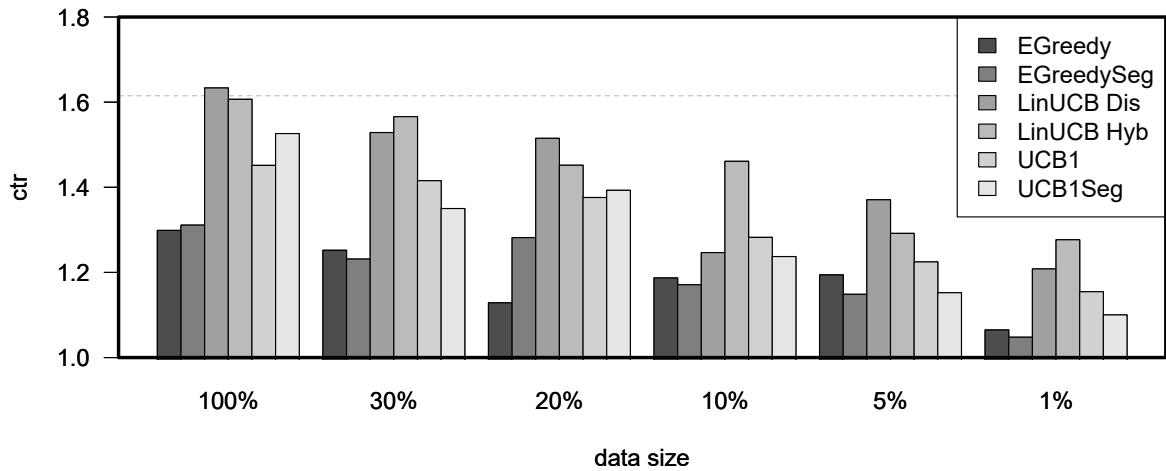

Figure 11: Replication of Figure 4b "CTRs in evaluation data with varying data sizes in the learning bucket." from Li *et al.* (2010). The plots represent the click through rates for different policies after one day of learning for each of six different levels of sparsity.

As can be observed in Figure 11, after one day of learning (on the Yahoo! dataset's day three), the conclusions of the original paper still stand. First, features again prove to be of use at all levels of sparsity, as LinUCB policies outperform the others consistently. Second, UCB policies generally outperform  $\epsilon$ -greedy ones. And third, Hybrid LinUCB again shows benefits when the data is small, as can be deduced from it doing better in the 1% bucket. Still, as we started our simulation on the third day instead of the first, our results are close to, but not quite the same as those reported in the original paper. Particularly the third conclusion, that of the relative advantage of Hybrid LinUCB with sparse data, seems to be slightly less convincing in our Figure 11.

So we decided to run a simulation that continued to learn beyond the first day for the sparse (1%) data condition to test whether Hybrid LinUCB's reported relative advantage would prove stable over time.

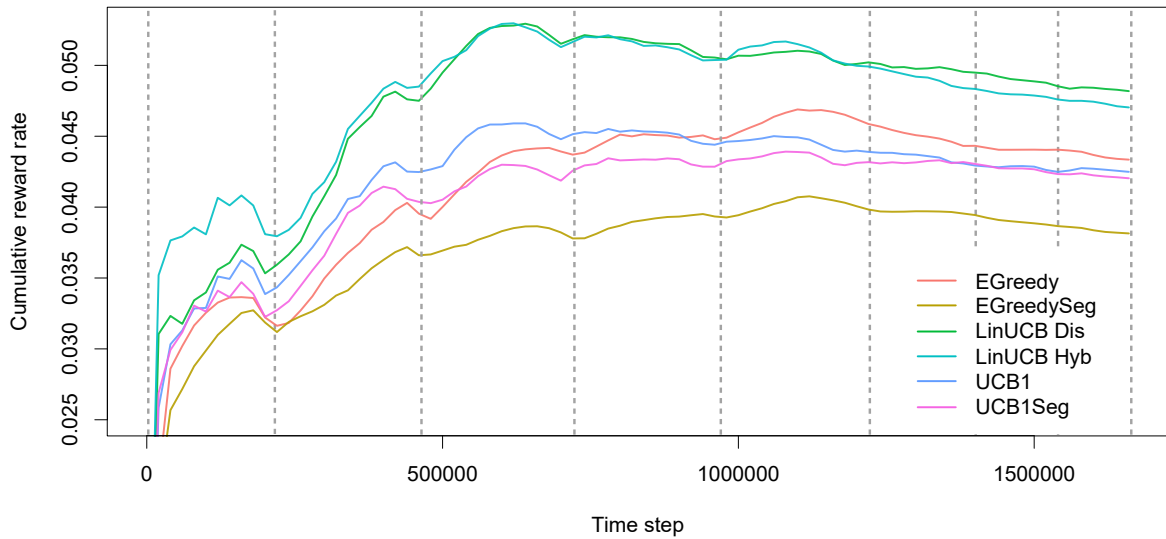

Figure 12: A plot of the cumulative reward rate (equals click-through rate) for EGreedy, EGreedySeg, LinUCB Dis, LinUCB Hyb, UCB1, and UCB1Seg policies over eight days of events from the Yahoo dataset at 1% sparsity. The dotted lines represent blocks consisting of 24 hours worth of data—the lines are not equidistant as the number of data points of these 24 hours differs per block. The plot’s sinusoidal wave pattern reflects visitors’ overall average cyclical daily waxing and waning click-through tendency.

On closer examination of the resulting plot in Figure 12, it becomes clear that the policies did not settle after one day of training. For one, on inspection of the full span of about eight days of learning, Hybrid LinUCB’s advantage over Disjoint LinUCB gradually diminishes and then reverses into an advantage for the Disjoint version. Also, surprisingly, over the full eight days, the  $\epsilon$ -greedy policy goes from the worst to third best policy overall, becoming the best context-free policy—clearly outperforming both context-free UCB policies. Though we intend to further analyze these discrepancies, for now, these results seem to pose questions for two out of three conclusions drawn in the original paper—leaving only the first outcome, the superiority of the contextual LinUCB in comparison to several context-free ones. Underlining the benefits of **contextual**, as it enabled us to replicate and confirm the original Li *et al.* (2010) paper, and then explore it further: extending Bandit and Policy classes, running simulations in parallel on an offline dataset and plotting and analyzing the results—within 48 hours.

## 9. Discussion and future work

Statistical computational methods, in R or otherwise, are regularly made available through single-use scripts or basic, isolated code packages (Gandrud 2016). Usually, such code examples are meant to give a basic idea of a statistical method, technique or algorithm in the context of a scientific paper (Stodden, Guo, and Ma 2013). Such code examples offer their scientific audience a first inroad towards the comparison and further implementation of their underlying methods (Buckheit and Donoho 1995). However, when a set of well-researched interrelated algorithms, such as MAB and CMAB policies, find growing academic, practical and commercial adoption, it becomes crucial to offer a more standardized and more accessible way to compare such methods and algorithms (Mesirov 2010).

It is on that premise that we decided to develop the **contextual** R package—a package that would offer

an open bandit framework with easily extensible bandit and policy libraries. To us, it made the most sense to create such a package in R (R Core Team 2018), as R is currently the de facto language for the dissemination of new statistical methods, techniques, and algorithms (Tippmann 2015)—while it is at the same time finding ever-growing adoption in industry (Muenchen 2012). The resulting lively exchange of R related code, data, and knowledge between scientists and practitioners offers precisely the kind of cross-pollination that **contextual** intends to facilitate.

As the package is intended to be usable by practitioners, scientists and students alike, we started our paper with a general introduction to the (contextual) multi-armed bandit problem, followed by a compact formalization. We then demonstrated how our implementation flows naturally from this formalization, with Agents that cycle Bandits and Policies through four function calls: `get_context()`, `get_action()`, `get_reward()` and `set_reward()`. Next, we evaluated some of **contextual**'s built-in policies, delved deeper into **contextual**'s class structure, extended **contextual**'s Bandit and Policy superclasses, demonstrated how to evaluate Policies on offline datasets, and, finally replicated a frequently cited CMAB paper.

Though the package is fully functional and we expect no more changes to its core architecture and API, there is ample room to further improve and extend **contextual**. We intend to further expand **contextual**'s documentation and tests. We expect to include more bandit paradigms, such as dueling and combinatorial bandits. We expect to add other offline bandit types, such as a doubly robust bandit (Dudík *et al.* 2011). We are interested in growing our policy library—possibly by creating a separate repository where both existing and new CMAB policies are shared, evaluated and compared. Finally, we hope that the package will find an active community of users and developers, thereby introducing more and more people to the refined sequential decision strategies offered by contextual bandit policies and algorithms.

## References

- Abadi M, Barham P, Chen J, Chen Z, Davis A, Dean J, Devin M, Ghemawat S, Irving G, Isard M (2016). “Tensorflow: A System for Large-scale Machine Learning.” In *OSDI*, volume 16, pp. 265–283.
- Abe N, Biermann AW, Long PM (2003). “Reinforcement Learning with Immediate Rewards and Linear Hypotheses.” *Algorithmica*, 37(4), 263–293. doi:10.1007/s00453-003-1038-1.
- ABTasty (2018). “Ab Tasty.” [Online; accessed 27. Aug. 2018], URL <https://www.abtasty.com>.
- Adobe (2018). “Adobe Target.” [Online; accessed 27. Aug. 2018], URL <https://www.adobe.com/marketing/target.html>.
- Agarwal A, Bird S, Cozowicz M, Hoang L, Langford J, Lee S, Li J, Melamed D, Oshri G, Ribas O (2016). “Making Contextual Decisions with Low Technical Debt.” *arXiv preprint arXiv:1606.03966*.
- Agarwal A, Hsu D, Kale S, Langford J, Li L, Schapire R (2014). “Taming the Monster: A Fast and Simple Algorithm for Contextual Bandits.” In *International Conference on Machine Learning*, pp. 1638–1646.
- Agrawal R (1995). “The Continuum-armed Bandit Problem.” *SIAM journal on control and optimization*, 33(6), 1926–1951. doi:10.1137/s0363012992237273.



- Agrawal S, Goyal N (2011). “Analysis of Thompson Sampling for the Multi-armed Bandit Problem.” *arXiv*. <http://arxiv.org/abs/1111.1797v3>.
- Agrawal S, Goyal N (2012). “Thompson Sampling for Contextual Bandits with Linear Payoffs.” *arXiv*. <http://arxiv.org/abs/1209.3352v4>.
- Auer P, Cesa-Bianchi N, Fischer P (2002). “Finite-time Analysis of the Multiarmed Bandit Problem.” *Machine learning*, **47**(2-3), 235–256.
- Austin PC (2011). “An Introduction to Propensity Score Methods for Reducing the Effects of Confounding in Observational Studies.” *Multivariate behavioral research*, **46**(3), 399–424.
- Bastani H, Bayati M (2015). “Online Decision-making with High-dimensional Covariates.” *SSRN*.
- Besson L (2018). “Smpybandits: An Open-source Research Framework for Single and Multi-players Multi-arms Bandits (mab) Algorithms in Python.” Online at: [github.com/SMPyBandits/SMPyBandits](https://github.com/SMPyBandits/SMPyBandits). Code at <https://github.com/SMPyBandits/SMPyBandits/>, documentation at <https://smpybandits.github.io/>, URL <https://github.com/SMPyBandits/SMPyBandits/>.
- Bottou L, Peters J, Quiñonero-Candela J, Charles DX, Chikering DM, Portugaly E, Ray D, Simard P, Snelson E (2013). “Counterfactual Reasoning and Learning Systems: The Example of Computational Advertising.” *The Journal of Machine Learning Research*, **14**(1), 3207–3260.
- Brezzi M, Lai TL (2002). “Optimal Learning and Experimentation in Bandit Problems.” *Journal of Economic Dynamics and Control*, **27**(1), 87–108. doi:10.1016/s0165-1889(01)00028-8.
- Briggs R, Hollis N (1997). “Advertising on the Web: Is There Response before Click-through?” *Journal of Advertising research*, **37**(2), 33–46.
- Bubeck S, Cesa-Bianchi N, *et al.* (2012). “Regret Analysis of Stochastic and Nonstochastic Multi-armed Bandit Problems.” *Foundations and Trends® in Machine Learning*, **5**(1), 1–122. doi:10.1561/22000000024.
- Buckheit JB, Donoho DL (1995). “Wavelab and Reproducible Research.” In *Wavelets and statistics*, pp. 55–81. Springer. doi:10.1007/978-1-4612-2544-7\_5.
- Cesa-Bianchi N, Fischer P (1998). “Finite-Time Regret Bounds for the Multiarmed Bandit Problem.” In *ICML*, pp. 100–108. Citeseer.
- Chang W (2017). *R6: Classes with Reference Semantics*. R package version 2.2.2, URL <https://CRAN.R-project.org/package=R6>.
- Chu W, Park ST, Beaupre T, Motgi N, Phadke A, Chakraborty S, Zachariah J (2009). “A Case Study of Behavior-driven Conjoint Analysis on Yahoo!: Front Page Today Module.” In *Proceedings of the 15<sup>th</sup> ACM SIGKDD international conference on Knowledge discovery and data mining*, pp. 1097–1104. ACM. doi:10.1145/1557019.1557138.
- Dudík M, Langford J, Li L (2011). “Doubly Robust Policy Evaluation and Learning.” *arXiv preprint arXiv:1103.4601*.
- Eckles D, Kaptein M (2014). “Thompson Sampling with the Online Bootstrap.” *arXiv*. <http://arxiv.org/abs/1410.4009v1>.

- Gandrud C (2016). *Reproducible Research with R and R Studio*. Chapman and Hall/CRC.
- Gelman A (2018). “Don’t Call It a Bandit.” URL <https://andrewgelman.com/2018/08/04/dont-call-bandit/>.
- Google (2018). “Google Analytics.” [Online; accessed 26. Aug. 2018], URL <https://marketingplatform.google.com/about/analytics>.
- Hido S, Tokui S, Oda S (2013). “Jubatus: An Open Source Platform for Distributed Online Machine Learning.” In *NIPS 2013 Workshop on Big Learning, Lake Tahoe*.
- Horvitz DG, Thompson DJ (1952). “A Generalization of Sampling without Replacement from a Finite Universe.” *Journal of the American statistical Association*, **47**(260), 663–685.
- Idreos S, Groffen F, Nes N, Manegold S, Mullender KS, Kersten ML (2012). “Monetdb: Two Decades of Research in Column-oriented Database Architectures.” *IEEE Data Engineering Bulletin*, **35**(1), 40–45.
- Imbens GW, Rubin DB (2015). *Causal Inference in Statistics, Social, and Biomedical Sciences*. Cambridge University Press. ISBN 9780521885881. Google-Books-ID: Bf1tBwAAQBAJ.
- Jordan MI, Mitchell TM (2015). “Machine Learning: Trends, Perspectives, and Prospects.” *Science*, **349**(6245), 255–260.
- Kaelbling LP, Littman ML, Moore AW (1996). “Reinforcement Learning: A Survey.” *Journal of artificial intelligence research*, **4**, 237–285. doi:10.1613/jair.301.
- Kaptein MC, Van Emden R, Iannuzzi D (2016). “Tracking the Decoy: Maximizing the Decoy Effect through Sequential Experimentation.” *Palgrave Communications*, **2**, 16082. doi:10.1057/palcomms.2016.82.
- Katehakis MN, Derman C (1986). “Computing Optimal Sequential Allocation Rules in Clinical Trials.” *Lecture notes-monograph series*, pp. 29–39.
- Kirkpatrick S, Gelatt CD, Vecchi MP (1983). “Optimization by Simulated Annealing.” *science*, **220**(4598), 671–680.
- Kohavi R, Henne RM, Sommerfield D (2007). “Practical Guide to Controlled Experiments on the Web.” In *Proceedings of the 13th ACM SIGKDD international conference on Knowledge discovery and data mining*, pp. 959–967. ACM.
- Kruijswijk J, Parvinen P, van Emden R, Kaptein MC (2018). “Streamingbandit; Experimenting with Bandit Policies.” *Journal of Statistical Software*.
- Kuleshov V, Precup D (2014). “Algorithms for Multi-armed Bandit Problems.” *arXiv preprint arXiv:1402.6028*.
- Lai TL, Robbins H (1985). “Asymptotically Efficient Adaptive Allocation Rules.” *Advances in applied mathematics*, **6**(1), 4–22. doi:10.1016/0196-8858(85)90002-8.
- Langford J, Li L, Strehl A (2007). “Vowpal Wabbit.”

- Langford J, Zhang T (2008). “The Epoch-greedy Algorithm for Multi-armed Bandits with Side Information.” In *Advances in neural information processing systems*, pp. 817–824.
- Lebera T (2018). “Machine Learning for Personalization.” Online. URL <http://www.cs.columbia.edu/~jebara/6998/>.
- Li L, Chu W, Langford J, Moon T, Wang X (2012). “An Unbiased Offline Evaluation of Contextual Bandit Algorithms with Generalized Linear Models.” In *Proceedings of the Workshop on On-line Trading of Exploration and Exploitation 2*, pp. 19–36.
- Li L, Chu W, Langford J, Schapire RE (2010). “A Contextual-bandit Approach to Personalized News Article Recommendation.” In *Proceedings of the 19<sup>th</sup> international conference on World wide web*, pp. 661–670. ACM. doi:10.1145/1772690.1772758.
- Li L, Chu W, Langford J, Wang X (2011). “Unbiased Offline Evaluation of Contextual-bandit-based News Article Recommendation Algorithms.” In *Proceedings of the Fourth ACM International Conference on Web Search and Data Mining, WSDM '11*, pp. 297–306. ACM, New York, NY, USA. ISBN 9781450304931. doi:10.1145/1935826.1935878.
- Li S (2016). *The Art of Clustering Bandits*. Ph.D. thesis, Università degli Studi dell’Insubria. URL <http://insubriaspace.cineca.it/handle/10277/729>.
- Lu T, Pál D, Pál M (2010). “Contextual Multi-armed Bandits.” In *Proceedings of the Thirteenth international conference on Artificial Intelligence and Statistics*, pp. 485–492.
- Mandel T, Liu YE, Brunskill E, Popovic Z (2016). “Offline Evaluation of Online Reinforcement Learning Algorithms.” In *AAAI*, pp. 1926–1933.
- May BC, Korda N, Lee A, Leslie DS (2012). “Optimistic Bayesian Sampling in Contextual-bandit Problems.” *Journal of Machine Learning Research*, **13**(Jun), 2069–2106.
- Mesirov JP (2010). “Accessible Reproducible Research.” *Science*, **327**(5964), 415–416. doi:10.1126/science.1179653.
- Mixpanel (2018). “Mixpanel.” [Online; accessed 26. Aug. 2018], URL <https://mixpanel.com>.
- Muenchen RA (2012). “The Popularity of Data Science Software.” URL <http://r4stats.com/articles/popularity/>.
- Nicol O (2014). *Data-driven Evaluation of Contextual Bandit Algorithms and Applications to Dynamic Recommendation*. PhD Thesis, Université de Lille I.
- NTUCSIE-CLLab (2018). “Striatum: Contextual Bandit in Python.” URL <https://github.com/ntucllab/striatum>.
- Optimizely (2018). “Optimizely.” [Online; accessed 26. Aug. 2018], URL <https://www.optimizely.com>.
- Pearl J (2009). *Causality*. Cambridge University Press. ISBN 9780521895606. Google-Books-ID: f4nuexsNVZIC.
- Presman EL (1991). “Poisson Version of the Two-armed Bandit Problem with Discounting.” *Theory of Probability & Its Applications*, **35**(2), 307–317.

- R Core Team (2018). “R: A Language and Environment for Statistical Computing.” URL <https://www.R-project.org>.
- Rabbi M, Aung MH, Zhang M, Choudhury T (2015). “MyBehavior: Automatic Personalized Health Feedback from User Behaviors and Preferences Using Smartphones.” In *Proceedings of the 2015 ACM International Joint Conference on Pervasive and Ubiquitous Computing*, pp. 707–718. ACM.
- Riquelme C, Tucker G, Snoek J (2018). “Deep Bayesian Bandits Showdown: An Empirical Comparison of Bayesian Deep Networks for Thompson Sampling.” *arXiv preprint arXiv:1802.09127*.
- Robbins H (1952). “Some Aspects of the Sequential Design of Experiments.” *Bulletin of the American Mathematical Society*, **58**(5), 527–535. ISSN 0002-9904, 1936-881X. URL <https://projecteuclid.org/euclid.bams/1183517370>.
- Rumbaugh J, Jacobson I, Booch G (2004). *Unified Modeling Language Reference Manual*. Pearson Higher Education.
- Sarkar J (1991). “One-armed Bandit Problems with Covariates.” *The Annals of Statistics*, pp. 1978–2002. doi:10.1214/aos/1176348382.
- Shen W, Wang J, Jiang YG, Zha H (2015). “Portfolio Choices with Orthogonal Bandit Learning.” In *IJCAI*, volume 15, pp. 974–980.
- Slivkins A (2014). “Contextual Bandits with Similarity Information.” *The Journal of Machine Learning Research*, **15**(1), 2533–2568.
- Steenwinckel B, De Backere F, Nelis J, Ongenaë F, De Turck F (2018). “Self-learning Algorithms for the Personalised Interaction with People with Dementia.” In *Workshops of the Thirty-Second AAAI Conference on Artificial Intelligence*, pp. 153–158.
- Stodden V, Guo P, Ma Z (2013). “Toward Reproducible Computational Research: An Empirical Analysis of Data and Code Policy Adoption by Journals.” *PloS one*, **8**(6), e67111. doi:10.1371/journal.pone.0067111.
- Strehl A, Langford J, Li L, Kakade SM (2010). “Learning from Logged Implicit Exploration Data.” In *Advances in Neural Information Processing Systems*, pp. 2217–2225.
- Strehl AL, Li L, Wiewiora E, Langford J, Littman ML (2006a). “PAC Model-free Reinforcement Learning.” In *Proceedings of the 23rd international conference on Machine learning*, pp. 881–888. ACM.
- Strehl AL, Mesterharm C, Littman ML, Hirsh H (2006b). “Experience-efficient Learning in Associative Bandit Problems.” In *Proceedings of the 23<sup>rd</sup> international conference on Machine learning*, pp. 889–896. ACM. doi:10.1145/1143844.1143956.
- Sutton RS, Barto AG (1998). “Reinforcement Learning: An Introduction.” *IEEE Transactions on Neural Networks*, **9**(5), 1054. ISSN 1045-9227. doi:10.1109/TNN.1998.712192.
- Swaminathan A, Joachims T (2015). “Batch Learning from Logged Bandit Feedback through Counterfactual Risk Minimization.” *Journal of Machine Learning Research*, **16**(1), 1731–1755.

- Tang L, Rosales R, Singh A, Agarwal D (2013). “Automatic Ad Format Selection Via Contextual Bandits.” In *Proceedings of the 22<sup>nd</sup> ACM international conference on Conference on information & knowledge management*, pp. 1587–1594. ACM.
- Tewari A, Murphy SA (2017). “From Ads to Interventions: Contextual Bandits in Mobile Health.” In *Mobile Health*, pp. 495–517. Springer. doi:10.1007/978-3-319-51394-2\_25.
- Tippmann S (2015). “Programming Tools: Adventures with R.” *Nature News*, **517**(7532), 109.
- Vermorel J, Mohri M (2005). “Multi-armed Bandit Algorithms and Empirical Evaluation.” In *European conference on machine learning*, pp. 437–448. Springer. doi:10.1007/11564096\_42.
- Wang CC, Kulkarni SR, Poor HV (2005). “Arbitrary Side Observations in Bandit Problems.” *Advances in Applied Mathematics*, **34**(4), 903–938. doi:10.1016/j.aam.2004.10.004.
- Whittle P (1979). “Discussion on “bandit Processes and Dynamic Allocation Indices”.” *J. Roy. Statist. Soc. Ser. B*, **41**, 165.
- Wickham H (2014). *Advanced R*. Chapman and Hall/CRC. doi:10.1201/b17487.
- Wilson RC, Geana A, White JM, Ludvig EA, Cohen JD (2014). “Humans Use Directed and Random Exploration to Solve the Explore–exploit Dilemma.” *Journal of Experimental Psychology: General*, **143**(6), 2074. doi:10.1037/a0038199.
- Wirfs-Brock R, Wilkerson B, Wiener L (1990). *Designing Object-oriented Software*. CUMINCAD.
- Yelp (2018). “MOE: A Global, Black Box Optimization Engine for Real World Metric Optimization.” Original-date: 2014-02-24T21:55:56Z, URL <https://github.com/Yelp/MOE>.
- Zheng R, Hua C (2016). “Stochastic Multi-armed Bandit.” In *Sequential Learning and Decision-Making in Wireless Resource Management*, pp. 9–25. Springer. doi:10.1007/978-3-319-50502-2\_2.

## 10. Appendix A: UML diagrams

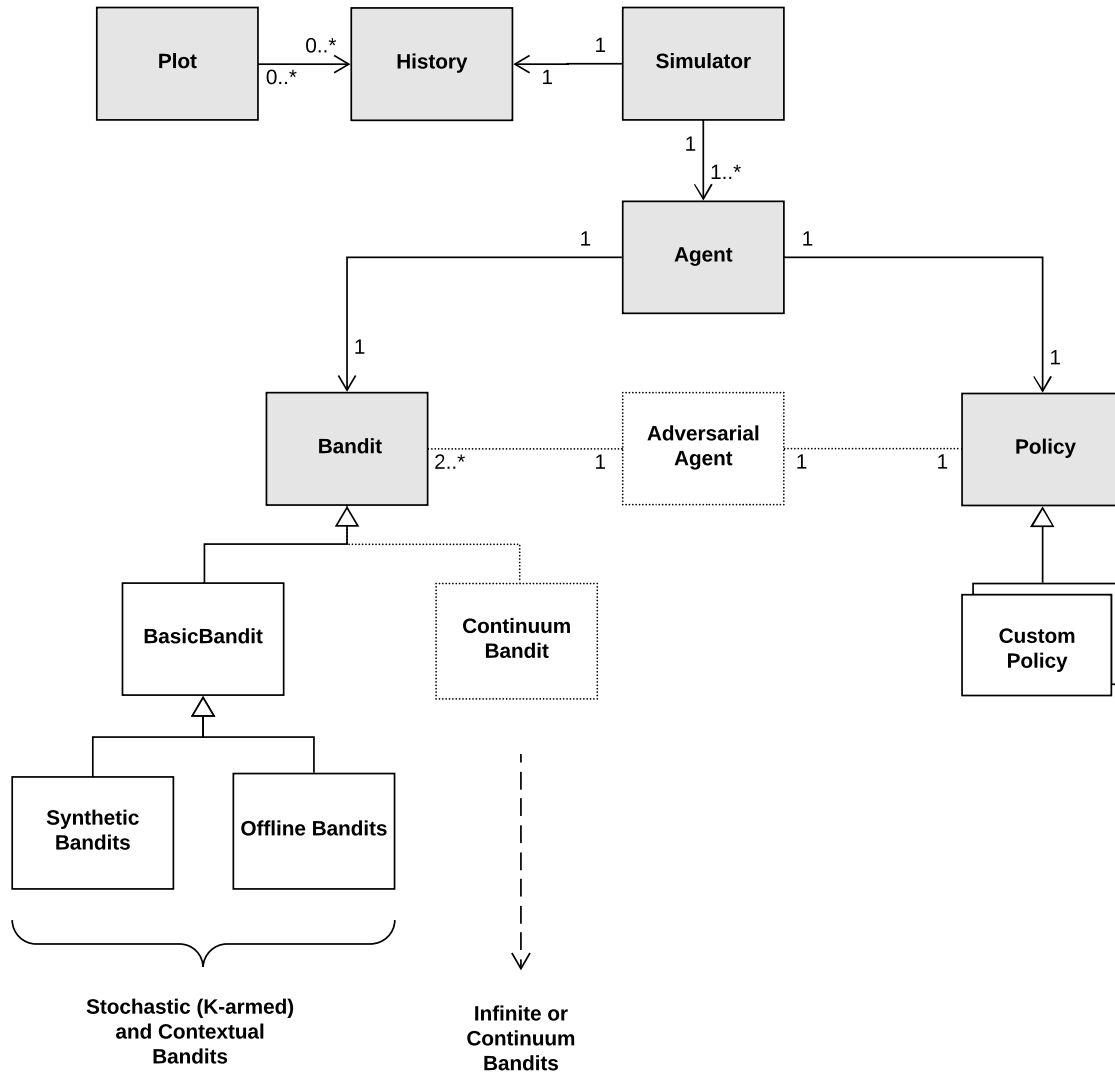
Figure 13: **contextual** UML Class Diagram

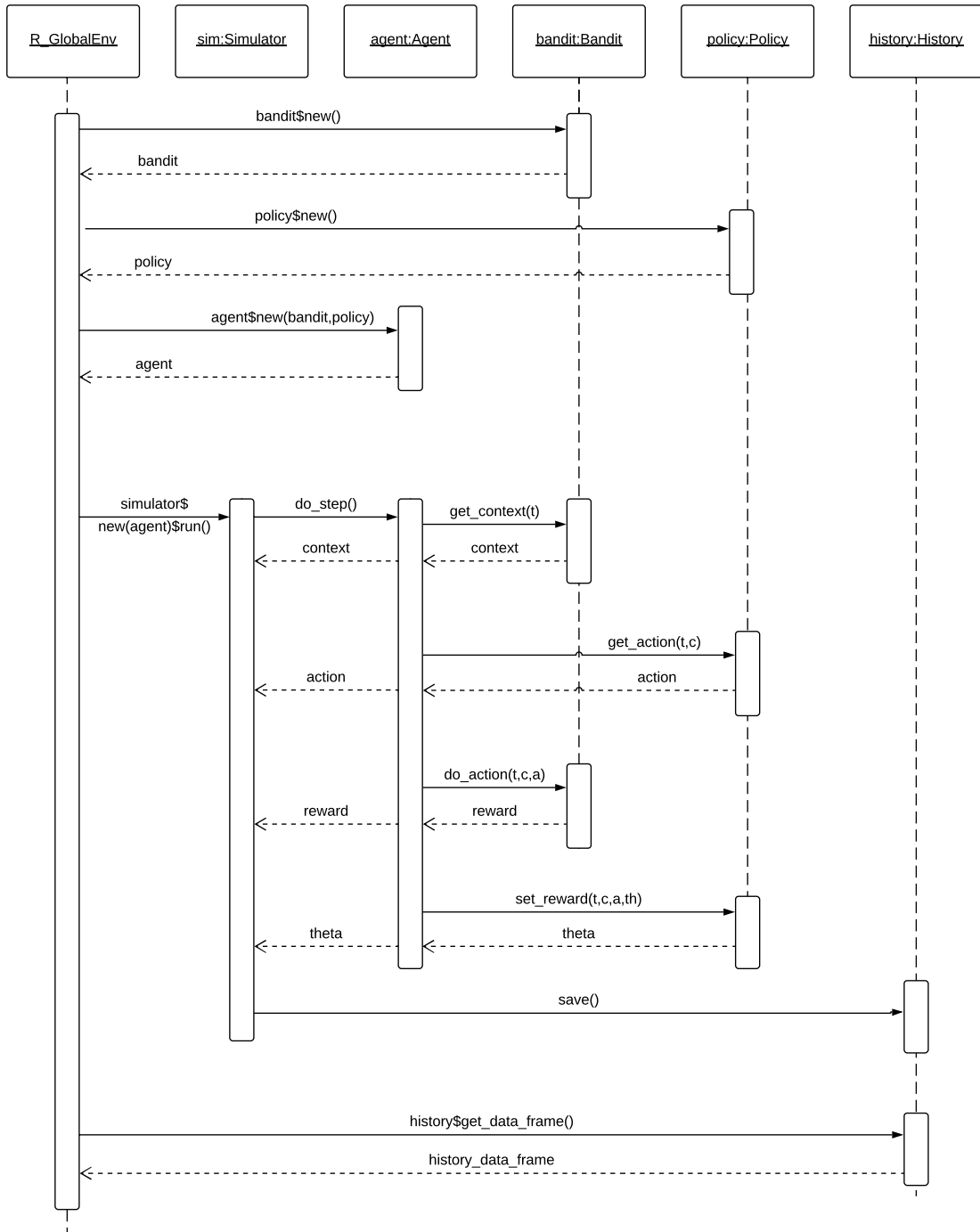

Figure 14: contextual UML Sequence Diagram

**Affiliation:**

Robin van Emden  
Jheronimus Academy of Data Science  
Den Bosch, the Netherlands  
E-mail: [robinvanemden@gmail.com](mailto:robinvanemden@gmail.com)  
URL: [pavlov.tech](http://pavlov.tech)

Maurits C. Kaptein  
Tilburg University  
Statistics and Research Methods  
Tilburg, the Netherlands  
E-mail: [m.c.kaptein@uvt.nl](mailto:m.c.kaptein@uvt.nl)  
URL: [www.mauritskaptein.com](http://www.mauritskaptein.com)