The Application of Atmospheric Pressure Dielectric Barrier Discharge Plasma on the Cleaning of Photovoltaic Panels

Weisheng Cui¹, Wenzheng Liu^{1,*}, Tahan Wang¹, chuanlong Ma¹

¹School of Electrical Engineering, Beijing Jiaotong University, Beijing 100044, China

Abstract—Plasma surface modification plays a significant role in the field of surface treatment and the dielectric barrier discharge (DBD) in air is an important method to generate plasma. With the widespread use of photovoltaic (PV) power generation, the impact of PV panel dust deposition had on power generation efficiency could not be ignored. The traditional method of cleaning PV panel is a waste of water and not environmental, which makes it urgent to find a simple and effective cleaning method. Based on the specific scene of PV generation and the structure of PV panel, a special uneven electrode was designed to discharge and generate plasma to treat the PV panel. Meanwhile, to treat the PV panel with stubborn dusts adhering on the surface for a long time, a method that discharges in wet condition was proposed. The simulation in wet condition confirms the enhancement of electric field strength and the experiment verified its treatment effect. The treatment on clean PV panels made it the property of preventing dust from adhering; the treatment in wet condition removed most of the dusts; eventually, the experiment under sunshine proved that the electrodes designed had little impacts on PV panels' generation.

Index Terms: DBD, Photovoltaic Power Generation, Plasma, Dust deposition

I. INTRODUCTION

¹ Plasma treatment is an environmental process technology, and it is extensively researched by people around the world. The dielectric barrier discharge (DBD) can produce non-equilibrium plasma with high electron energy under atmospheric pressure in air condition. Compared with the method in industrial production that equipped with expensive low pressure equipment or using inert gas to generate plasma, it is simple to use and the cost is reduced obviously. But the discharge pattern of DBD at atmospheric pressure is mostly filamentary discharge, make it not ideal for

the homogeneous treatment of the material surface. Therefore, people have been trying to get uniform and stable DBD at atmospheric pressure. [1-5] Photovoltaic (PV) generation, as currently the most promising new energy, has been developed extensively. Whereas, dust deposition on the PV panel surface, in the actual application process, is affecting the generation efficiency increasingly [6-11]. The traditional method of cleaning PV panel is washing the surface of PV panel using water and detergent, which wastes much water and is not environmental. A method of using DBD to generate plasma and treat the PV panel to keep it sanitary, therefore, is a promising solution.

PV panels have three types including monocrystalline silicon PV panels, polycrystalline silicon PV panels and amorphous silicon PV panels. The monocrystalline silicon PV panels were taken to experiment as they are the widely used because of low cost. According to the discharge characteristic of atmospheric pressure DBD, an electrode structure of keeping PV panel clean was presented. The discharge condition was changed to further discuss its discharge effect and make it possible to achieve the quasi-glow discharge characteristics under atmospheric pressure.

II. EXPERIMENT SETUP

PV panel consists of PV-layer and Ultra Clear Glass. As is shown in **Fig.1**, the PV-layer in PV panel is used as ground electrode and the high voltage electrode is placed on PV panel which is copper electrode and firmly coated with a layer of Polytetrafluoroethylene (PTFE) dielectric. When alternating current (AC) high voltage is applied between high voltage electrode and PV layer, the tiny space near contact points of Ultra Clear Glass and PTFE layer discharges and the plasma generated can treat the surface of PV panel.

In the study, a power with frequency of 20 kHz and output voltage of 10kV is adopted and connected to the electrode. As is shown in **Fig.2**, the discharge voltage U is

measured with a Tektronix P6015A high-voltage probe and discharge current is acquired by measuring the voltage across a resistor R in series with the electrode. The waveforms of the discharge voltage and current are recorded by a Tektronix digital oscilloscope (TDS1012B-SC). The discharge phenomena are captured by SLR camera (Coolpix P100). The discharge power is calculated basing on Lissajous Figure^[12] which is acquired from oscilloscope through replacing the resistance R with a capacitance C.

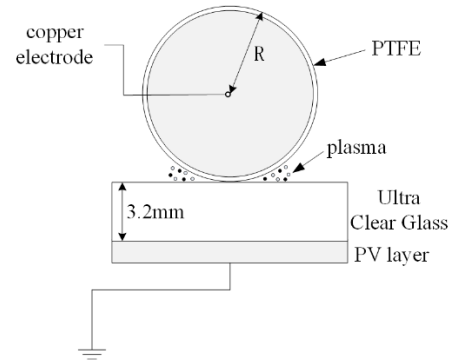

Fig.1 Electrode structure diagram

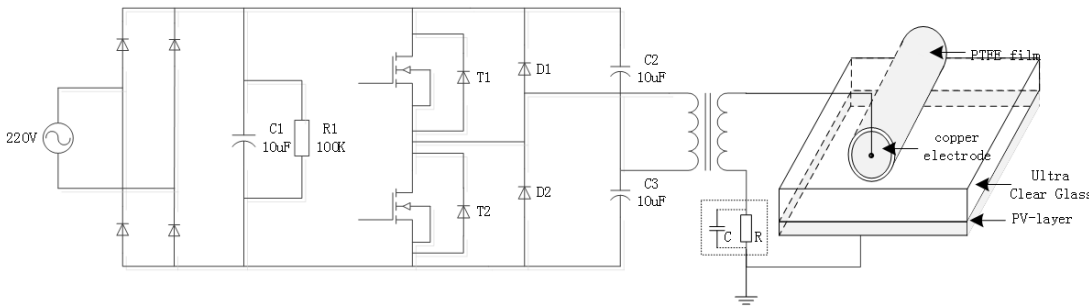

Fig.2 main circuit diagram

III. THE ELECTRODE DISCHARGE CHARACTERISTIC AND PARAMETER ANALYSIS

The discharge characteristic of electrode was closely related to its parameters. The electrode designed in this paper had a special structure that PV panel was part of the discharge electrode, and the parameters of the high voltage electrode had a great influence on discharge and plasma generation.

A. The analysis of electrode structure character

Electrodes discharging to generate plasma require strong electric field and the electric field generated by Electrode relates directly to the curvature radius of the high voltage electrode. The electric field strength of the designed electrode was simulated by MAXWELL 3D software, in which the thickness of Ultra Clear Glass was 3.2 millimeter (mm), the thickness of the PTFE film was 0.2mm, and the voltage of high voltage electrode was set to 5kV. When the curvature radii of the cylindrical high voltage electrode R was 40mm, 20mm, 10mm and 5mm, the electric field strength distribution of the electrodes were shown in Fig.3.

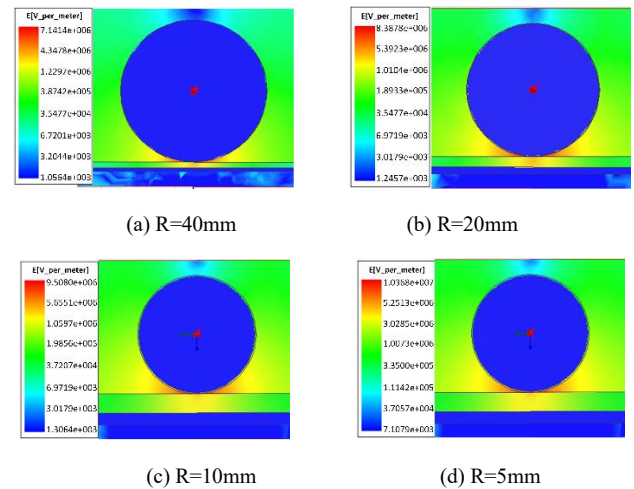

Fig.3 The electric field simulation distribution for different curvature radii of high voltage electrode

As was shown in Fig.3, the maximum electric field strength appeared near both sides of the contact points of high voltage electrode and PV panel. The generation area of plasma is less than electrode's projection on PV panel and they varies with the change of electrode radius. The **Electrode Field Strength Utilization Factor** is proposed to describe the treatment area percentage of electrode. It was defined as the ratio of strong electric field region and the region occupied by electrode. The strong electric field region was the region where the electric field strength was larger

than 3×10^6 V/m and the region occupied by electrode was electrode's projection on PV panel.

Table.1 The electric field simulation and analysis for different curvature radii of high voltage electrode

Curvature radius (mm)	40	20	10	5
Maximum of electric field strength (V/m)	7.14×10^6	8.39×10^6	9.51×10^6	1.04×10^7
Electrode Field Strength Utilization Factor (%)	9.7	14.6	20.5	29.8

The simulation result is listed in **Table.1**. It can be seen from data in **Table.1**, the smaller the electrode radius is, the greater the electric strength is. The result can be concluded from principle below: the integral of electric field in any closed surface is proportional to the total quantity of electric charges enclosed. When the applied voltage remains unchanged, the high voltage electrode surface charge density increases with the decrease of electrode curvature radii, so is the same minimal enclosed space of the total charges. Therefore, the maximum of electric field strength increases with the reduction of high voltage electrode curvature radius, which is in accord with the simulation results. The increase of electrode field strength could reduce the discharge voltage threshold and avoid severely development of discharge. Meanwhile, the **Electrode Electric Strength Utilization Factor** improves significantly with the decrease of the curvature radius, which indicates that smaller electrode radius could lead to a greater extent utilization of electrode.

B. Electrode discharge characteristics and the influence factors

It can be inferred in preceding research that the smaller high voltage electrode will have more strong electric strength and higher discharge efficiency in the same condition. The high voltage electrode with radii of 10mm and 5mm was chosen in the following experiments. With the increase of voltage, both ends of the electrode first start to discharge, and the discharge area gradually extends to the full electrode. In order to simplify the narrative, the (peak) voltage that both ends of high voltage electrode begin to discharge is called **initial discharge voltage**, and that the whole high voltage electrode completely discharges is called **full discharge voltage**. The discharge for both electrodes was repeated 5

times to obtain the mean value of initial discharge voltage and full discharge voltage. The results were shown in **Table.2**.

Table.2 Mean value of discharge voltage for different curvature radii of high voltage electrode

curvature radius	initial discharge voltage	full discharge voltage
5mm	4.60kV	5.15kV
10mm	4.95kV	5.45kV

Compared to 10mm high voltage electrode, the initial discharge voltage and full discharge voltage of 5mm high voltage electrode both decreased, in accord with the theoretical analyses. The phenomena of electrodes discharge at full discharge voltage were shown in **Fig.4**, where both discharge phenomena presented light blue diffusion type, and there are no bright filaments between the electrodes. The discharge of 5mm high voltage electrode is more homogeneous than that of 10mm high voltage electrode.

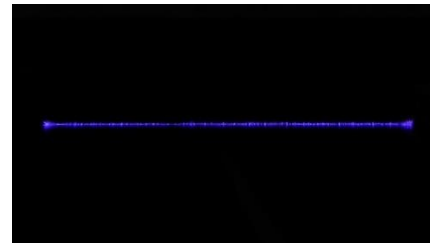

(a) R=10mm

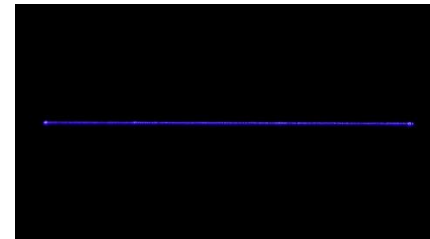

(b) R=5mm

Fig.4 Discharge phenomena with different high voltage electrode radii (exposure time: 0.77s)

The discharge voltage and current of electrode were shown in **Fig.5**, which were correspond with the discharge phenomena. There were less pulses current in 5mm high voltage electrode, which proved that the smaller radius high voltage electrode could reduce discharge voltage threshold and prevent dielectric barrier discharge from transitioning to filamentary discharge.

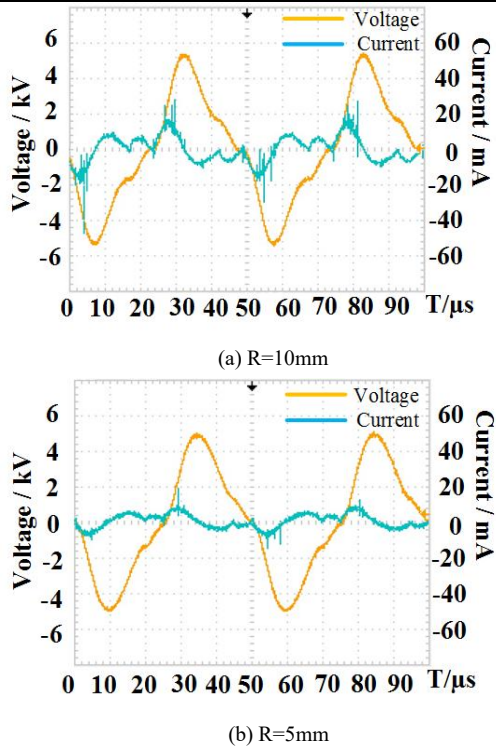
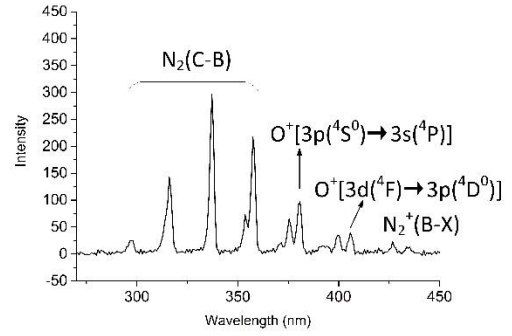
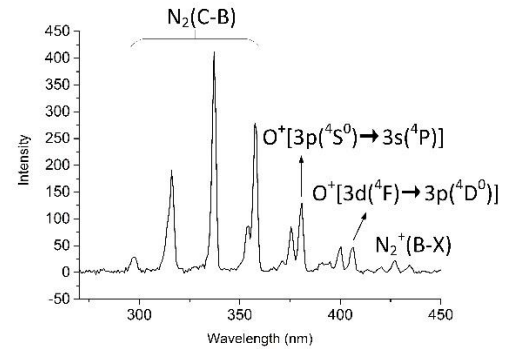

Fig.5 Discharge voltage and current waveform

Generally speaking, the inert gas glow discharge at atmospheric pressure conditions is homogeneous, diffuse and stable form, which reflected in the current waveform is no visible sharp pulse current^[13-15]. It is difficult to generate glow discharge in air under atmospheric pressure. The reason is that the discharge is easy to transform into a filamentous mode and the uneven dielectric barrier is a possible method to prevent the formation of filamentary discharge. The electrode we propose in the paper has a structure of narrow gap which is formed by high voltage electrode and PV panel and grows from submicron to millimeter. The electrode shape could form intensive electric field in narrow gap and weak electric field in wide gap, and both can limit the production of a large number of charges and inhibit the appearance of filamentary discharge. The plasma generated in the discharge has diffusion characteristics, and discharges happening in submicron gap can supply many free electrons for outer gap to make discharge happen at lower voltage. Because of the relatively low electric field, the possibility of discharge at outer gap transform into filamentary discharge is reduced. The plasma generated by this electrode structure is uniform in space and presents the characteristics of quasi-glow discharge. The 5mm electrode discharge current in Fig.5 has little long pulse currents which evidently certify the theoretical analysis.



(a) R=10mm



(b) R=5mm

Fig.6 Electrode discharge spectrum analysis

To further investigate the actual discharge intensity, the Ocean Optics QE65000 spectrometer is used to obtain spectral distribution of 10mm and 5mm radius high voltage electrode discharge at full discharge voltage, and the results are shown in Fig.6. The higher intensity spectral line appeared from 300nm to 500nm, and they represent some species such as N_2 ($C^3\Pi_u \rightarrow B^3\Pi_g$), N^+ ($3p(^1P^0) \rightarrow 3s(^1P^0)$), N_2^+ ($B^2\Sigma_u^+ \rightarrow X^2\Sigma_g^+$), O^+ ($3p(^4S^0) \rightarrow 3s(^4P)$, $3d(^4F) \rightarrow 3p(^4D^0)$). It can be seen from Fig.6 that the higher intensity spectral line of 5mm electrode is generally greater than that of 10mm electrode. That is to say, in the case that the full discharge voltage of 5mm electrode is lower than that of 10mm electrode, the 5mm electrode discharge spectra has the better intensity.

In conclusion, the discharge characteristics of 5mm electrode is superior to 10mm electrode, which is consistent with the previous analysis. Considering the experiment and practical application, the 5mm electrode is adopted for later optimization and experiment.

IV. DISCHARGE CHARACTERISTICS OF ELECTRODE ON PV PANEL SURFACE WITH WATER FILM

The electrode proposed in this paper could form relatively homogeneous quasi-glow discharge at atmospheric pressure conditions, but the plasma generated could not take effect on PV panel with dusts adhering for a long time. A thin layer of water film will be formed when PV panel surface dusts are in wet state and the discharge with a coating of water film is studied in the following chapter.

A. The structure characteristics of electrode with water film

The PTFE is a hydrophobic material, and it will form a constant contact angle with the water. Without considering the solid surface roughness and other factors, the contact angle can be approximately expressed as Young formula:

$\gamma_{SG} - \gamma_{SL} - \gamma_{LG} \cos \theta = 0$. Referring to the research of relating researchers, the contact angle of 115° is adapted in the simulation [16-18]. When the water film thickness is very small, the high voltage electrode and water still form a micro gap, so that the discharge characteristic of the electrode maintains.

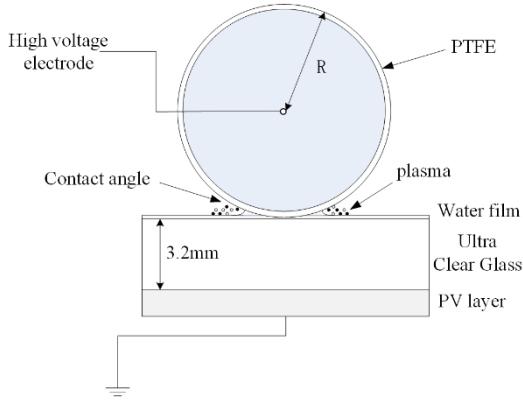

Fig.7 Electrode structure with water film

When there is a layer of water film on the surface of PV panel, the narrow gap between the high voltage electrode and the water film is discharge area, which is shown in Fig.7. The salt solution (0.427mol/L) is prepared and there exists free electric charges in the solution. When there are dusts on the PV panel, the solution will wet the dusts and form a very thin water film on the surface of PV panel. When high voltage is applied between electrodes, the electric field produced will make the positive and negative charges approach to the down and up surface respectively, which will weaken the electric

field in the water and lead to the reduce of water surface potential. Therefore, the potential difference between the high voltage electrode and water surface increases and so is the electric field which is beneficial to discharge. The dusts are insulator and the thick is so small that it has little impact on the electric field between the electrodes. The simulation method is used to analyze the variation of the field strength. The conductivity of salt solution is calculated and set to 4 s/m [19]. The radius of the high voltage electrode is 5mm, the voltage is set to 5kV and the thickness of the water film is 0.1mm. The result is shown in Fig.8.

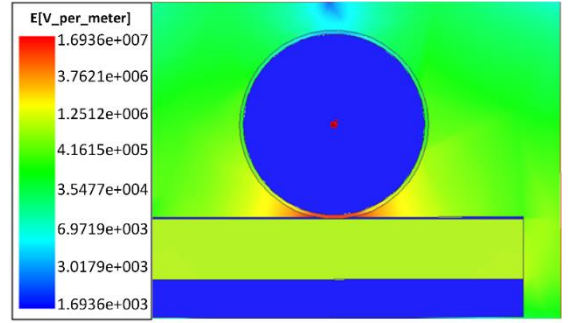

Fig.8 The electric field simulation distribution for electrode with water film

Table.3 Simulation results for electrode with water film

Electrode structure	Electrode (without water film)	Electrode (with water film)
Maximum electric field strength (V/m)	1.04×10^7	1.69×10^7
Electrode Field Strength Utilization Factor (%)	29.8	29.6

Table.3 is the result concluded from preceding simulation. It shows that when the applied voltage between electrodes is 5kV, the maximum electric field intensity with PV panel coated with a layer of water film is increased by about 62% compared to PV panel without water film and the **Electrode Field Strength Utilization Factor** remains nearly unchanged.

B. Electrode discharge characteristics

Through theoretical analysis, it is obtained that the electric field outside of water film is enhanced when there is a coating of water film on PV panel, so that the discharge voltage decreased. The 5mm high voltage electrode was used in discharge experiment, and the results were obtained that the initial discharge voltage reduced to 3.83 kV and the full discharge voltage reduced to 4.34 kV. When the discharge

voltage was 5kV, the discharge phenomenon and the discharge voltage and current waveforms were shown in Fig.9. Fig.9 (a) shows that the discharge is relatively homogeneous and show no visible filaments. In Fig.9 (b), the capacitive current increased and the pulse current amplitude became smaller.



(a) Discharge phenomenon (exposure time: 0.77s)

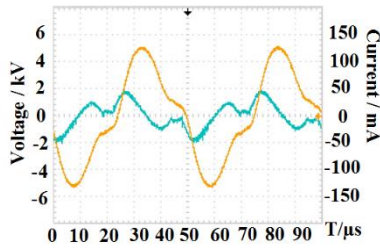

(b) Waveforms of voltage and current

Fig.9 discharge phenomenon and waveforms of voltage and current when Electrode discharges with water film

The electrode discharge power with and without water film on PV panel at 5kV were measured. The discharge Lissajous Figures were shown in Fig.10 and the parallelogram area represented the discharge power.

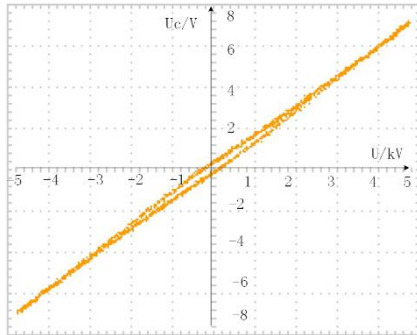

(a) Electrode without water film

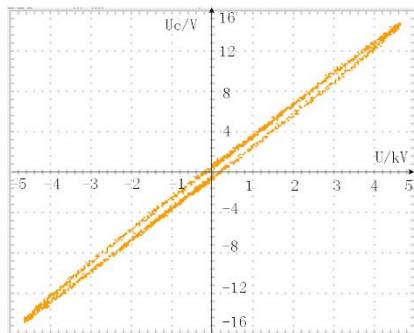

(b) Electrode with water film

Fig.10 Discharge power of electrode in different condition

According to the calculation formula of the Lissajous Figure, on condition that the discharge voltage was 5kV, the discharge power was 0.56W when the surface of PV panel was dry and the discharge power was 1.68W when the surface of PV panel was coated with water film. It was evident that PV panel coating with water film could significantly increase the electrode discharge power and enhance the plasma treatment effect.

V. STUDY ON THE APPLICATION OF PV PANEL SURFACE CLEANING

Through simulation and experimental analysis, the electrode with and without water film could generate plasma and achieve quasi-glow discharge at atmospheric pressure. The application of plasma on PV panel was studied in the following section, which consists of PV panel surface treatment and influence on the PV panel power generation. The dusts used in the experiment are collected from the emission dusts of coal-fired power plant, and the particle diameter covers from several hundred nanometers to tens of microns, which has the most significant impact on the PV panel generation [20].

A. The effect of preventing the dusts from adhering to PV panel

PV panels will accumulate deposits composed of mainly dusts and reduce the generating efficiency of PV panels severely. The electrode designed in the paper could generate plasma by discharge and treat the surface of PV panel to make it the property of strong hydrophilicity which is like self-clean glass [21-23]. The PV panel is treated with 5mm high voltage electrode at 5.2 kV for 1 minute and the change of contact angle is detected with angle measurement instrument (Dataphysics OCA15EC)

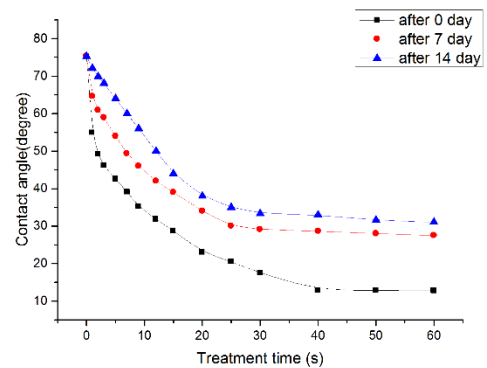

Fig.11 Surface hydrophilic change trend of PV panel

Fig.11 shows the change of contact angle of PV panel surface. It can be concluded that the contact angle drops from 73° to 12° when the treatment time lasts 40 seconds and remains unchanged after that. The contact angle increases a little 7 days after the treatment and maintains a level of about 32° after 14 days.

A thin layer of water film will be formed on the surface of PV panel as the water affinity is much larger than that of dusts when PV panel surface has property of strong hydrophilicity. And it will make the dusts float and slip, namely, the PV panel is capable of preventing dust adhesion.

An experiment was carried out to verify the effect of preventing dust from adhering when the PV panel was treated by electrode. In the experiment, a dry and clean PV panel was selected. The right side of it was processed for 1 minute, while its left side is untreated to compare. A layer of dusts was evenly placed on the surface of PV panel 5 minutes after the treatment. And 1 minute after the dusts were placed a stream of clear water flowed over the PV panel to take away the dusts. It can be seen from **Fig.12** that the region processed by electrode is clean and the region unprocessed is covered by the residual dust. The dust remained and accumulated over a long time will form stubborn stains which are difficult to remove. The electrode designed in the paper can generate plasma and change the property of PV panel to make it the strong hydrophilicity and prevent dust from adhering.

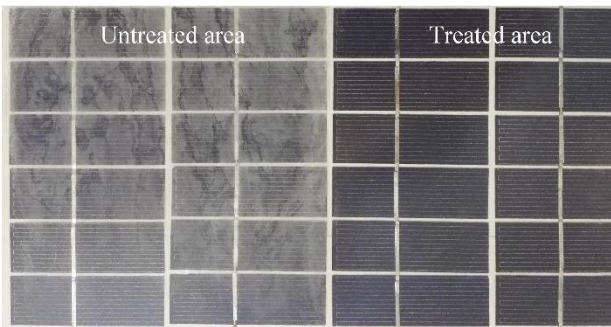

Fig.12 The effect of preventing the dusts from adhering to PV panel

B. Stubborn stains clearing

The dusts adhering for a long time has a strong relationship with PV panel, which is hard to remove with regular method. Use electrode to treat it when the dusts are in wet condition.

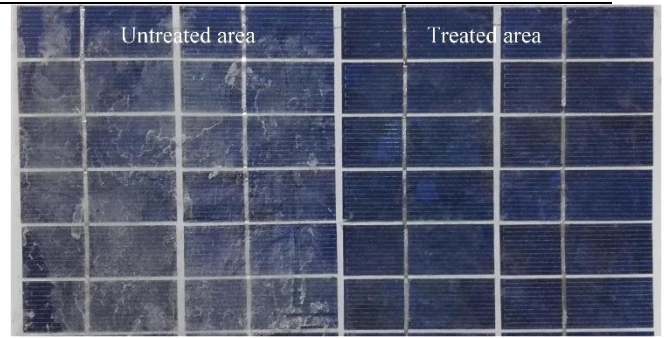
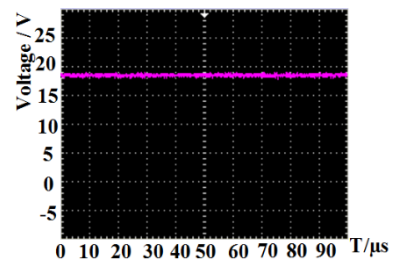

Fig.13 effects of stubborn stains clearing

A PV panel with stubborn stains was selected and its right side was processed for 5 minutes in wet condition and its left side got wetted but untreated for comparison. A stream of clear water flowed over the PV panel to take away the dusts after the treatment. It could be seen in **Fig.13** that most dust on the right side of PV panel was cleaned while many parts are covered by residual dust on the left side of PV panel.

C. Influence on PV panel generation

The PV panel is used as the ground electrode in the paper, and an experiment is carried out to test the influence of electrode discharges on the PV panel generation. The PV panel of rated output voltage being 19V and rated power being 5W is selected for experiment and the load is 75ohm resistance to ensure it work in rated power. Put the PV panel under sunshine to make it work normally and record the PV panel output voltage when electrode is discharging. The result is shown in **Fig.14**.



(a) The normal output voltage of PV panel

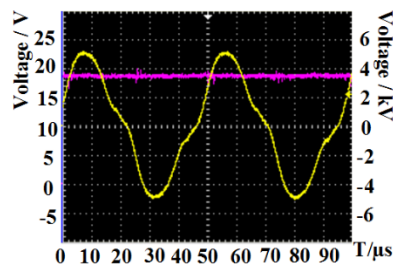

(b) The output voltage of PV panel when discharging

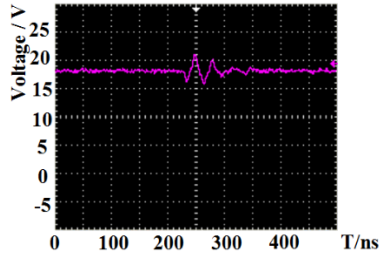

(c). Enlarged time scale of PV panel output voltage when discharging

Fig.14 Effect of electrode discharges on the output voltage of PV panel

Fig.14 (a) shows that the PV panel output voltage is relatively smooth DC voltage; in **Fig.14 (b)**, the PV panel output voltage remains the same except a little tiny fluctuation when discharge happens; it is amplified in **Fig.14(c)** that the period of fluctuation is only 40ns which is considered to be related to the development of electron avalanche. In the actual power generation process, the output voltage of the PV panel is not stable and it will be affected by the light intensity, light angle, temperature and other factors. The voltage fluctuation of the experiment in nanosecond scale has almost no effect on the normal operation of PV panel generation.

In power system, the harmonic interference is usually eliminated by capacity or inductance. In PV power generation system, the output side of the PV panel is paralleled with electrolytic capacitor to stabilize the voltage and is paralleled with a film capacitor to shield accidental voltage fluctuations. The general filter capacitor selection principle is $RC \geq (3 \sim 5) \frac{T}{2}$, in which T is the ripple period and R is the load resistance. Based on the parameters in the article $C \geq \frac{2.5T}{R} \approx 1.3nF$ and the simulation in MATLAB certified the filtering effect. In the actual PV power generation system, the support capacitor and film capacitor can eliminate the fluctuation, so the PV power generation system is nearly not affected by the electrode.

VI. CONCLUSION AND FURTHER STUDY

The surface cleaning of PV panels is becoming increasingly important, whereas the traditional method of washing the surface using chemical reagent is inefficient and costly. The method of generating plasma at atmosphere to treat the PV panel has the advantages of simplicity,

effectiveness and no additional pollution. Through theoretical analysis and experiment, the following conclusions are obtained:

- (1) PV panel could be part of a discharge electrode for its particular structure, and through the optimization of high voltage electrode parameters, the quasi-glow discharge effect at atmospheric pressure is obtained.
- (2) The clean PV panel processed by electrode has a significant property of preventing dust from adhering compared to untreated PV panel.
- (3) The electric field strength and discharge power both increased when PV panel surface is in wet condition, which makes the stubborn stains easily to be removed.
- (4) The proposed electrode almost has no influence on the normal operation of PV panel, which indicates that it has the possibility of practical application.

The discharge voltage of electrode will be lowered because of the water film covering on the PV panel. Whereas, the existing water film evaporation problem will also affect the actual effects of discharge in long time processing. The optimized water film condition and better treatment is another important aspect of this research and will be analyzed in the following experiments.

REFERENCES

- [1] Yu, L., Laux, C. O., Packan, D. M., & Kruger, C. H. Direct-current glow discharges in atmospheric pressure air plasmas. *J APPL PHYS*, 91(5), pp. 2678-2686, 2002.
- [2] Sismanoglu B N, Amorim J, Souza-Corrêa J A, et al. Optical emission spectroscopy diagnostics of an atmospheric pressure direct current microplasma jet[J]. *Spectrochimica Acta Part B: ATOM SPECTROSC*, 64(11), pp. 1287-1293, 2009.
- [3] Liu W, Sun G, Li C, et al. A study of the glow discharge characteristics of contact electrodes at atmospheric pressure in air[J]. *PHYS PLASMAS*, 21(4), pp. 043514, 2014.
- [4] Kunhardt E E. Generation of large-volume, atmospheric-pressure, nonequilibrium plasmas[J]. *IEEE T PLASMA SCI*, 28(1), pp. 189-200, 2000.
- [5] Bazhenov V Y, Kuzmichev A I, Tsiolko V V, et al. Experimental and Theoretical Study of Transition Between Glow Modes of Planar Barrier Capacitive RF Discharge in Argon at One Atmosphere Pressure[J]. *IEEE T PLASMA SCI*, 43(3), pp. 760-764, 2015.
- [6] Goossens D, Offer Z Y. Comparisons of day-time and night-time dust

- accumulation in a desert region[J]. *J ARID ENVIRON*, 31(31), pp. 253-281, 1995.
- [7] Boyle L, Flinchpaugh H, Hannigan M P. Natural soiling of photovoltaic cover plates and the impact on transmission[J]. *RENEW ENERG*, 77, pp. 166-173, 2015.
- [8] Sulaiman S A, Hussain H H, Nik Leh N S H, et al. Effects of Dust on the Performance of PV Panels[J]. *World Academy of Science Engineering & Technology*, 2011.
- [9] Kaldellis J K, Kapsali M. Simulating the dust effect on the energy performance of photovoltaic generators based on experimental measurements[J]. *ENERGY*, 36(8), pp. 5154-5161, 2011.
- [10] Jiang H, Lu L, Sun K. Experimental investigation of the impact of airborne dust deposition on the performance of solar photovoltaic (PV) modules[J]. *ATMOS ENVIRON*, 45(45), pp. 4299-4304, 2011.
- [11] Klugmann-Radziemska E. Degradation of electrical performance of a crystalline photovoltaic module due to dust deposition in northern Poland[J]. *RENEW ENERG*, 78, pp. 418-426, 2015.
- [12] Kriegseis J, Möller B, Grundmann S, et al. Capacitance and power consumption quantification of dielectric barrier discharge (DBD) plasma actuators[J]. *J ELECTROSTAT*, 69(4), pp. 302-312, 2011.
- [13] Kanazawa S, Kogoma M, Moriwaki T, et al. Stable glow plasma at atmospheric pressure[J]. *J PHYS D APPL PHYS*, 21(5), pp. 838-840, 1988.
- [14] Massines F, Rabeji A, Decomps P, et al. Experimental and theoretical study of a glow discharge at atmospheric pressure controlled by dielectric barrier[J]. *J APPL PHYS*, 83(6), pp. 2950-2957, 1998.
- [15] Yokoyama T, Kogoma M, Moriwaki T, et al. The mechanism of the stabilisation of glow plasma at atmospheric pressure[J]. *J PHYS D APPL PHYS*, 23(8), pp. 1125, 1990.
- [16] Zhou Z H, Zhang Q, Wang H Z, et al. Wettability of a PTFE surface by aqueous solutions of zwitterionic surfactants: Effect of molecular structure[J]. *Colloids & Surfaces A Physicochemical & Engineering Aspects*, 489, pp. 370-377, 2016.
- [17] Liu C Z, Wu J Q, Ren L Q, et al. Comparative study on the effect of RF and DBD plasma treatment on PTFE surface modification[J]. *Materials Chemistry & Physics*, 85(2-3), pp. 340-346, 2004.
- [18] Zhi, F., Hao, L., Hao, Y., et al. Polytetrafluoroethylene surface modification by filamentary and homogeneous dielectric barrier discharges in air. *IEEE Transactions on Plasma Science*, 255(16), pp. 7279-7285, 2009.
- [19] Buck N L. Calibration of dielectric constant probes using salt solutions of unknown conductivity[J]. *IEEE T INSTRUM MEAS*, 45(1), pp. 84-88, 1996.
- [20] El-Shobokshy M S, Hussein F M. Effect of dust with different physical properties on the performance of photovoltaic cells[J]. *SOL ENERGY*, 51(6), pp. 505-511, 1993.
- [21] Yu J, Zhao X. Effect of surface microstructure on the super-hydrophilic property of the sol-gel derived porous TiO₂ thin films[J]. *J MATER SCI LETT*, 20(7), pp. 671-673, 2001.
- [22] Polakiewicz A, Dodiuk H, Kenig S. Super-hydrophilic coatings based on silica nanoparticles[J]. *J ADHES SCI TECHNOL*, 28(5), pp. 466-478, 2014.
- [23] Lien S, Nautiyal A, Jhu J, et al. Surface Chemistry of Super-Hydrophilic SiO₂-Doped TiO₂ Photo-Catalysts for Self-Cleaning Glass[J]. *ASIAN J CHEM*, 25(11), pp. 6071, 2013.