

MONOTONE LAGRANGIAN FLOER THEORY IN SMOOTH DIVISOR COMPLEMENTS: I

ALIAKBAR DAEMI, KENJI FUKAYA

ABSTRACT. In this paper, Floer homology for Lagrangian submanifolds in an open symplectic manifold given as the complement of a smooth divisor is discussed. The main new feature of this construction is that we do not make any assumption on positivity or negativity of the divisor. To achieve this goal, we use a compactification of the moduli space of pseudo-holomorphic discs into the divisor complement satisfying Lagrangian boundary condition that is stronger than the stable map compactification and is inspired by the compactifications that are used in relative Gromov–Witten theory. This is the first of a series of three papers, this compactification is introduced and some of its fundamental properties as a topological space, essential for the definition of Lagrangian Floer homology, are established.

CONTENTS

1. Introduction	1
1.1. Statement of Results	2
2. Main idea of the construction	3
3. RGW Compactification of the Moduli Space of Disks and Strips in $X \setminus \mathcal{D}$	9
3.1. Partial \mathbb{C}_* -actions and divisors	9
3.2. Symplectic and Complex Structures on a Projective Space Bundle	10
3.3. RGW Compactification in a Neighborhood of the Divisor	11
3.4. RGW Compactification: a Single Disk or Strip Component	20
3.5. RGW Compactification in the General Case	28
4. Stable Map Topology and RGW Topology	36
4.1. Review of Stable Map Topology	36
4.2. RGW Topology	39
References	57

1. INTRODUCTION

Lagrangian Floer theory plays a central role in recent developments in symplectic topology; it has been used to study symplectic rigidity of Lagrangian submanifolds [ALP94] and it lies at the heart of the homological mirror symmetry program [Kon95b]. This theory associates a homology group to a pair of Lagrangians in a symplectic manifold. In order to define this invariant, one needs to make some restrictive assumptions on the Lagrangians and the underlying symplectic manifold. Hence, there are various flavors of Lagrangian Floer homology in the literature [Flo88, Oh93, FOO09a, FOO09b, AJ10].

In this paper, we study Floer homology for Lagrangians in open symplectic manifolds obtained by removing a divisor from a closed symplectic manifold. The novelty of our construction is that we do not make any convexity assumption about the ends of such open manifolds. The main application that we have in mind is in gauge theory.

Motivated by [MW12], we are planning to use the construction of the present article and its subsequents to define symplectic instanton Floer homology for arbitrary $U(N)$ -bundles over 3-manifolds. As it is discussed in the last section of [DF18c], it is plausible that the construction of this paper can be useful in various other contexts.

1.1. Statement of Results. Let (X, ω) be a compact symplectic manifold and \mathcal{D} be a codimension two symplectic submanifold of X . We call any such submanifold \mathcal{D} of X a *smooth divisor* in (X, ω) .

Definition 1.1. Let L be a compact Lagrangian submanifold of $X \setminus \mathcal{D}$. We say L is *monotone in $X \setminus \mathcal{D}$* , if there exists $c > 0$ such that the following holds for any $\beta \in \text{Im}(\pi_2(X \setminus \mathcal{D}, L) \rightarrow \pi_2(X, L))$:

$$\omega(\beta) = c\mu(\beta).$$

Here $\mu : H_2(X, L; \mathbb{Z}) \rightarrow \mathbb{Z}$ is the Maslov index associated to the Lagrangian submanifold L . (See, for example, [FOOO15, Subsection 2.1.1].) The minimal *Maslov number* of a Lagrangian L in $X \setminus \mathcal{D}$ is defined to be:

$$\inf\{\mu(\beta) \mid \beta \in \text{Im}(\pi_2(X \setminus \mathcal{D}, L) \rightarrow \pi_2(X, L)), \omega(\beta) > 0\}.$$

Definition 1.2. Let L_0, L_1 be compact subspaces of $X \setminus \mathcal{D}$. We say L_0 is *Hamiltonian isotopic to L_1 in $X \setminus \mathcal{D}$* if there exists a compactly supported time dependent Hamiltonian $H : (X \setminus \mathcal{D}) \times [0, 1] \rightarrow \mathbb{R}$ such that the Hamiltonian diffeomorphism $\psi_H : X \setminus \mathcal{D} \rightarrow X \setminus \mathcal{D}$ maps L_0 to L_1 . Here ψ_H is defined as follows. Let $H_t(x) = H(x, t)$ and X_{H_t} be the Hamiltonian vector field associated to H_t . We define ψ_t^H by

$$\psi_0^H(x) = x, \quad \frac{d}{dt}\psi_t^H = X_{H_t} \circ \psi_t^H.$$

Then $\psi_H := \psi_1^H$. We say that ψ_H is the *Hamiltonian diffeomorphism associated to the (non-autonomous) Hamiltonian H* .

The main result of this series of papers is the following.

Theorem 1. *Let $L_0, L_1 \subset X \setminus \mathcal{D}$ be compact, oriented and spin Lagrangian submanifolds such that they are monotone in $X \setminus \mathcal{D}$. Suppose one of the following conditions holds:*

- (a) *The minimal Maslov numbers of L_0 and of L_1 are both strictly greater than 2.*
- (b) *L_1 is Hamiltonian isotopic to L_0 .*

Then there is a Floer homology group $HF(L_1, L_0; X \setminus \mathcal{D})$, which is a vector space over a Novikov ring depending only on the Hamiltonian isotopy classes of L_0 and L_1 . If L_0 is transversal to L_1 then we have:

$$\dim(HF(L_1, L_0; X \setminus \mathcal{D})) \leq \#(L_0 \cap L_1).$$

and if $L_0 = L_1 = L$, then there exists a spectral sequence whose E^2 page is the singular homology group of L and which converges to $HF(L, L; X \setminus \mathcal{D})$.

See [DF18c] for a more detailed and slightly stronger version of this theorem.

In [Flo88], Floer proved the analogue of Theorem 1 in the case that $\pi_2(X, L_i) = 0$ and the coefficient ring is $\mathbb{Z}/2\mathbb{Z}$. In this case, the analogue of the spectral sequence for the Floer homology of the pair (L, L) collapses in the second page and the Floer homology is isomorphic to singular homology of L [Flo88, Flo89]. Oh generalizes Floer's construction to the case that L_0 and L_1 are monotone in X [Oh93]. He also constructed a spectral sequence from the homology of L to the Lagrangian Floer homology of the pair (L, L) in [Oh96]. (See also [FOOO09a, Chapter 2] and [BC09].)

The main new feature of Theorem 1 is that we assume monotonicity of L_0 and L_1 only in $X \setminus \mathcal{D}$. Roughly speaking, the Floer homology $HF(L_1, L_0; X \setminus \mathcal{D})$ is defined using only holomorphic disks which 'do not intersect' \mathcal{D} . Therefore, Theorem 1 can be regarded

as an extension of Oh’s monotone Floer homology [Oh93] to open manifolds where the geometry at infinity is controlled by a smooth divisor. As we mentioned earlier, this extension of Floer homology is partly motivated by monotone Lagrangian submanifolds in divisor complements which are constructed by gauge theory [MW12, DF18a].

There are various other special cases of Theorem 1 which already appear in the literature. In the case that $X \setminus \mathcal{D}$ is convex at infinity, the methods of [FOOO09a, FOOO09b] can be used to define a Floer homology group $HF(L_1, L_0; X \setminus \mathcal{D})$ satisfying the properties mentioned in Theorem 1. In particular, this setup can be applied to the case that each component of \mathcal{D} is a positive multiple of the Poincaré dual of $[\omega]$, the cohomology class of the symplectic form. Starting with the remarkable work of Seidel [Sei02, Sei15], such Floer homology groups have been used to study Fukaya category of X and to verify homological mirror symmetry for some special examples.

As in any other versions of Lagrangian Floer homology, the main geometrical input in the definition of the Floer homology of Theorem 1 is the moduli space of holomorphic maps from the standard disc to X (equipped with appropriate almost complex structures), which satisfy Lagrangian boundary conditions. There is a standard compactification of this moduli space called the *stable map compactification*, which plays an essential role in the definition of previous versions of Lagrangian Floer homology. This compactification, however, is not suitable for our purposes.

A key observation for this series of papers is that this issue can be resolved by a different and stronger compactification of the above moduli space of holomorphic discs, which we call *RGW compactification*. The definition of this compactification is inspired by the theory of *Relative Gromov–Witten* invariants, where one uses the moduli spaces of holomorphic maps from a closed surface to X , which intersect a divisor \mathcal{D} in a prescribed way, to construct numerical invariants of (X, \mathcal{D}) . There are also formal similarities between the RGW compactification and the compactification of the moduli spaces used in symplectic field theory.

In Section 2 of the present paper, we explain in more detail why stable map compactification comes short for our purposes, and how our work is related to several approaches to Relative Gromov–Witten theory. The definition of RGW compactification as a set is given in Section 3, and in Section 4 after defining the topology of this set we prove the compactness of this topological space. In our second paper of this series [DF18b], we study the analytical features of the RGW compactification. In particular, we show that this space admits a Kuranishi structure with boundary and corners. We believe that the analytical methods of [DF18b] provide an approach to address some of the foundational questions for relative Gromov–Witten invariants for a pair of a symplectic manifold and a smooth divisor. In the third paper [DF18c], we use the results of the present paper and [DF18b] to prove Theorem 1.

Acknowledgements. We thank Paul Seidel, Mark Gross, Mohammad Tehrani and Aleksey Zinger for helpful conversations. We also thank the anonymous referee for giving several helpful comments on an earlier version of this series of papers. We are grateful to the Simons Center for Geometry and Physics for providing a stimulating environment for our collaboration on this project.

2. MAIN IDEA OF THE CONSTRUCTION

Suppose (X, ω) is a closed symplectic manifold. Any flavor of Lagrangian Floer homology of two Lagrangians L_0 and L_1 in a symplectic manifold (X, ω) is defined using holomorphic strips into X satisfying Lagrangian boundary conditions where the holomorphic curve equation is defined with respect to a tame almost complex structure J

on X . To be more specific, let $p, q \in L_0 \cap L_1$, and consider maps

$$u : \mathbb{R} \times [0, 1] \rightarrow X$$

that are J -holomorphic and

$$(2.1) \quad u(\tau, 0) \in L_0, \quad u(\tau, 1) \in L_1, \quad \lim_{\tau \rightarrow -\infty} u(\tau, t) = p, \quad \lim_{\tau \rightarrow +\infty} u(\tau, t) = q.$$

Any such map represents a homology class in the following sense.

Definition 2.2. We say (not necessarily holomorphic) maps $u, u' : \mathbb{R} \times [0, 1] \rightarrow X$ satisfying (2.1) are *homologous* to each other if there exists $v : \Sigma \rightarrow X$ with the following properties.

- (1) Σ is an oriented 3 dimensional manifold with corners. $\partial\Sigma$ is identified with $(\mathbb{R} \times [0, 1] \times \{0, 1\}) \cup S_0 \cup S_1$, where $\partial S_0 \cong \mathbb{R} \times \{0\} \times \{0, 1\}$ and $\partial S_1 \cong \mathbb{R} \times \{1\} \times \{0, 1\}$.
- (2) $v : \Sigma \rightarrow X$ is a continuous map.
- (3) $v(\tau, t, 0) = u(\tau, t)$ and $v(\tau, t, 1) = u'(\tau, t)$.
- (4) $v(S_0) \subset L_0, v(S_1) \subset L_1$.
- (5) Complement of a compact subspace of Σ is identified with $((-\infty, -C] \times [0, 1]^2) \cup ([C, \infty) \times [0, 1]^2)$ and

$$\lim_{\tau \rightarrow -\infty} v(\tau, x) = p, \quad \lim_{\tau \rightarrow +\infty} v(\tau, x) = q.$$

The set of such homology classes is denoted by $\Pi_2(X; L_1, L_0; p, q)$.

For $\beta \in \Pi_2(X; L_1, L_0; p, q)$, we define $\mathcal{M}^{\text{reg}}(L_1, L_0; p, q; \beta)$ to be the set of all equivalence classes of J -holomorphic maps $u : \mathbb{R} \times [0, 1] \rightarrow X$ satisfying (2.1) and representing β with respect to the equivalence relation given by translation along the \mathbb{R} factor of $\mathbb{R} \times [0, 1]$. Namely, $u \sim u'$, if there exists τ_0 such that $u'(\tau, t) = u(\tau + \tau_0, t)$.

The Lagrangian Floer homology group $HF(L_1, L_0; X)$ is the homology of a chain complex $(CF(L_1, L_0), \partial)$ where $CF(L_1, L_0)$ is the vector space generated by the elements of $L_0 \cap L_1$ and $\partial : CF(L_1, L_0) \rightarrow CF(L_1, L_0)$ is defined as

$$(2.3) \quad \partial([p]) = \sum_{q, \beta} \# \mathcal{M}^{\text{reg}}(L_1, L_0; p, q; \beta)[q].$$

Here the sum on the right hand side is taken over all (q, β) such that the *virtual dimension* of $\mathcal{M}^{\text{reg}}(L_1, L_0; p, q; \beta)$ is 0.

As the next step, moduli spaces $\mathcal{M}^{\text{reg}}(L_1, L_0; p, q; \beta)$ of virtual dimension 1 are used to show that ∂ is a differential. In fact, one first compactifies these moduli spaces and then characterizes the coefficient of $[q]$ in $\partial \circ \partial([p])$ in terms of the boundary points of the compactified moduli spaces. The foundational issue is that one should also expect other contributions to the boundary of the moduli spaces in correspondence to the *disc bubbles*.

To spell this out in more detail, we need to consider other types of moduli spaces of holomorphic curves. First let $\mathcal{M}_{0,1}^{\text{reg}}(L_1, L_0; p, q; \beta)$ and $\mathcal{M}_{1,0}^{\text{reg}}(L_1, L_0; p, q; \beta)$ be the J -holomorphic maps $u : \mathbb{R} \times [0, 1] \rightarrow X$ satisfying (2.1) and representing β . Thus these spaces agree with each other and their quotient with respect to the translation action is $\mathcal{M}^{\text{reg}}(L_1, L_0; p, q; \beta)$. We define the evaluation maps $\text{ev}_{0,1} : \mathcal{M}_{0,1}^{\text{reg}}(L_1, L_0; p, q; \beta) \rightarrow L_0$ and $\text{ev}_{1,0} : \mathcal{M}_{1,0}^{\text{reg}}(L_1, L_0; p, q; \beta) \rightarrow L_1$ by

$$\text{ev}_{0,1}(u) = u(0, 0), \quad \text{ev}_{1,0}(u) = u(0, 1).$$

The set $\mathcal{M}_{0,1}^{\text{reg}}(L_1, L_0; p, q; \beta)$ can be regarded as the moduli space of marked holomorphic strips (u, z_0) modulo the translation action where z_0 is a marked point on $\mathbb{R} \times \{0\}$. Any such marked strip has a unique representative where $z_0 = (0, 0)$. Similarly, $\mathcal{M}_{1,0}^{\text{reg}}(L_1, L_0; p, q; \beta)$ can be regarded as a moduli space of marked strips (u, z_1) modulo

the translation action where z_1 is a marked point on $\mathbb{R} \times \{1\}$. See Definition 3.80 for the generalization where we allow more marked points on $\mathbb{R} \times \{0\}$ and $\mathbb{R} \times \{1\}$.

For any α in the image $\Pi_2(X, L; \mathbb{Z})$ of the Hurewicz homomorphism $\pi_2(X, L) \rightarrow H_2(X, L; \mathbb{Z})$, we define $\mathcal{M}_1^{\text{reg}}(L; \alpha)$ to be the set of all equivalence classes of J -holomorphic maps $u : (D^2, \partial D^2) \rightarrow (X, L)$ in the homotopy class α , where $u \sim u'$ if there exists a bi-holomorphic map $v : D^2 \rightarrow D^2$ such that $u \circ v = u'$ and $v(1) = 1$. We also define the evaluation map $\text{ev} : \mathcal{M}_1^{\text{reg}}(L; \alpha) \rightarrow L$ by $\text{ev}(u) = u(1)$. When the choice of L is clear from the context, we write $\mathcal{M}_1^{\text{reg}}(\alpha)$ for $\mathcal{M}_1^{\text{reg}}(L; \alpha)$.

There is a topology, called the stable map topology, on the spaces

$$(2.4) \quad \mathcal{M}^{\text{reg}}(L_1, L_0; p, q; \beta), \quad \mathcal{M}_{0,1}^{\text{reg}}(L_1, L_0; p, q; \beta), \quad \mathcal{M}_{1,0}^{\text{reg}}(L_1, L_0; p, q; \beta), \quad \mathcal{M}_1^{\text{reg}}(L; \alpha).$$

See Subsection 4.1 for a review of the stable map topology. There are also compactifications of these topological spaces denoted by

$$(2.5) \quad \mathcal{M}(L_1, L_0; p, q; \beta), \quad \mathcal{M}_{0,1}(L_1, L_0; p, q; \beta), \quad \mathcal{M}_{1,0}(L_1, L_0; p, q; \beta), \quad \mathcal{M}_1(L; \alpha).$$

These compactifications are metrizable. The evaluation maps ev naturally extends to maps to the compactified spaces. We use the same notation to denote these extensions.

In the compactification $\mathcal{M}(L_1, L_0; p, q; \beta)$ of $\mathcal{M}^{\text{reg}}(L_1, L_0; p, q; \beta)$ we add J -holomorphic maps where disc and sphere bubbles and broken strips are allowed. In particular, included in this compactification we can identify three types of *boundary* points. The first type corresponds to the products

$$(2.6) \quad \mathcal{M}(L_1, L_0; p, r; \beta_1) \times \mathcal{M}(L_1, L_0; r, q; \beta_2),$$

where $r \in L_0 \cap L_1$, $\beta_1 \in \Pi_2(L_1, L_0; p, r)$ and $\beta_2 \in \Pi_2(L_1, L_0; r, q)$ such that $\beta_1 \# \beta_2 = \beta$. Here $\#$ denotes the concatenation maps

$$\Pi_2(X; L_1, L_0; p, r) \times \Pi_2(X; L_1, L_0; r, q) \rightarrow \Pi_2(X; L_1, L_0; p, q).$$

The second and the third types correspond to

$$(2.7) \quad \mathcal{M}_{0,1}(L_1, L_0; p, q; \beta_0) \times_{L_0} \mathcal{M}_1(L_0; \alpha_0), \quad \mathcal{M}_{1,0}(L_1, L_0; p, q; \beta_1) \times_{L_1} \mathcal{M}_1(L_1; \alpha_1),$$

where $\beta_0, \beta_1 \in \Pi_2(L_1, L_0; p, q)$, $\alpha_0 \in \Pi_2(X, L_0; \mathbb{Z})$ and $\alpha_1 \in \Pi_2(X, L_1; \mathbb{Z})$ satisfy $\beta_0 \# \alpha_0 = \beta$ and $\beta_1 \# \alpha_1 = \beta$. Here we use the concatenation maps

$$(2.8) \quad \begin{aligned} \# &: \Pi_2(X; L_1, L_0; p, q) \times \Pi_2(X, L_0; \mathbb{Z}) \rightarrow \Pi_2(X; L_1, L_0; p, q), \\ \# &: \Pi_2(X; L_1, L_0; p, q) \times \Pi_2(X, L_1; \mathbb{Z}) \rightarrow \Pi_2(X; L_1, L_0; p, q). \end{aligned}$$

See Figures 1, 2 and 3 for schematic pictures of the three types of boundary points.

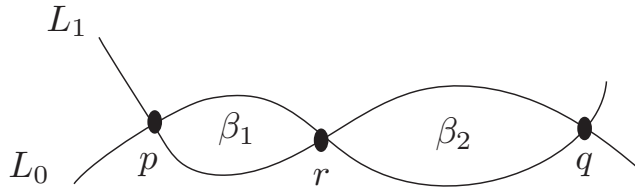

FIGURE 1. A boundary element of type (1)

In order to use the above moduli spaces in the construction of Lagrangian Floer homology, we need some sort of smooth structures on them. A general approach to achieve this is to show that there is a structure of a Kuranishi structure on any of these moduli spaces. Roughly speaking, a Kuranishi structure on a topological space M implies that M is locally homeomorphic to the zero set of a smooth map defined on a manifold (or more generally an orbifold), and the transition maps between such charts are well-behaved with respect to this structure. All of the moduli spaces in (2.5) admit Kuranishi structures with boundary and corners. In the case of $\mathcal{M}(L_1, L_0; p, q; \beta)$, the

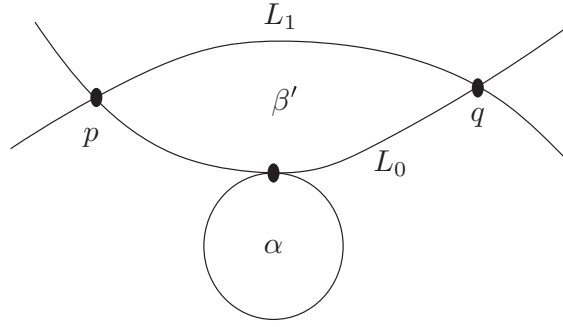

FIGURE 2. A boundary element of type (2)

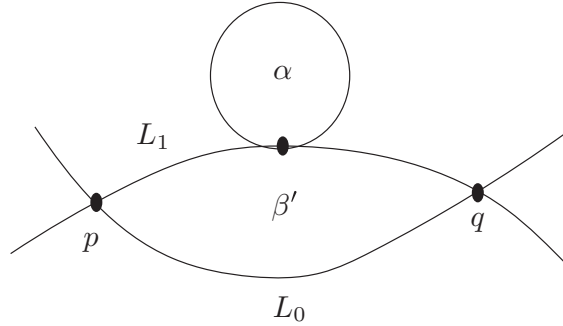

FIGURE 3. A boundary element of type (3)

(normalized) boundary¹ of this space as a Kuranishi space is the union of the three types of Kuranishi spaces given in (2.6) and (2.7). Moreover, if the above Lagrangians are (relatively) spin, then all of the above Kuranishi structures are orientable. See [FOOO09b] for the proofs of the above claims.

Now, we turn back to showing that the operator ∂ in (2.3) is a differential of a chain complex. The count of boundary elements of the first type in (2.6) gives the coefficient of $[q]$ in $\partial \circ \partial([p])$. Since the signed count of the boundary elements of a Kuranishi space of dimension 1 is zero, this implies that $\partial \circ \partial = 0$, assuming the boundary elements of the second the third types in (2.7) are empty. However, this does not happen in general and ∂ might not be a differential. In the special case that L_0, L_1 are monotone in X with minimal Maslov number greater than 2, the contribution of the boundary points in (2.7) is trivial. This gives rise to the Oh's construction of Floer homology of monotone Lagrangians [Oh93].

In order to prove Theorem 1 where the Lagrangians L_i are monotone only in $X \setminus \mathcal{D}$, we may try to restrict β to the classes which satisfy the following additional condition.

Condition 2.9. We say $\alpha \in \Pi_2(X, L)$ has vanishing algebraic intersection with \mathcal{D} , if

$$(2.10) \quad [\alpha] \cdot \mathcal{D} = 0.$$

Similarly, $\beta \in \Pi_2(X; L_1, L_0; p, q)$ has vanishing algebraic intersection with \mathcal{D} , if

$$(2.11) \quad [\beta] \cdot \mathcal{D} = 0.$$

In the definition of (2.3), suppose we only use homology classes $\beta \in \Pi_2(X; L_1, L_0; p, q)$ satisfying Condition 2.9. Then we might hope that the monotonicity of L_0, L_1 in $X \setminus \mathcal{D}$ allows us to repeat Oh's argument and avoid boundary elements of the second and the third types in (2.7). This idea, however, does not work in general. Suppose β has

¹See [FOOO15, Definition 8.4] for the definition of normalized boundary.

vanishing algebraic intersection with \mathcal{D} , and $\mathcal{M}(L_1, L_0; p, q; \beta)$ has virtual dimension 1. Then this space could have boundary elements of the first type as in (2.6) associated to homology classes β_1, β_2 such that $\beta_1 \# \beta_2 = \beta$, $[\beta_1] \cdot \mathcal{D} < 0$ and $[\beta_2] \cdot \mathcal{D} > 0$. (See Figure 4 below.) Therefore, we would face again with a similar issue to show that $\partial \circ \partial = 0$. (See Figure 4 below.)

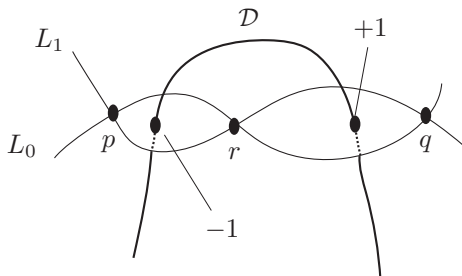

FIGURE 4. Monotonicity is broken

The arrangement in Figure 4 can be avoided by picking an appropriate almost complex structures on X . For instance, if J is integrable in a neighborhood of \mathcal{D} and \mathcal{D} is a complex submanifold, then any J -holomorphic curve has a positive intersection with \mathcal{D} , which implies the claim in the following lemma. (See Subsection 3.2 for a more flexible family of almost complex structures on X that satisfy a similar property.)

Lemma 2.12. *Suppose the almost complex structure J on X is integrable in a neighborhood of \mathcal{D} . If $\mathcal{M}^{\text{reg}}(L_1, L_0; p, q; \beta)$ (resp. $\mathcal{M}_1^{\text{reg}}(L; \alpha)$) is nonempty, then $\beta \cdot \mathcal{D} \geq 0$ (resp. $\alpha \cdot \mathcal{D} \geq 0$).*

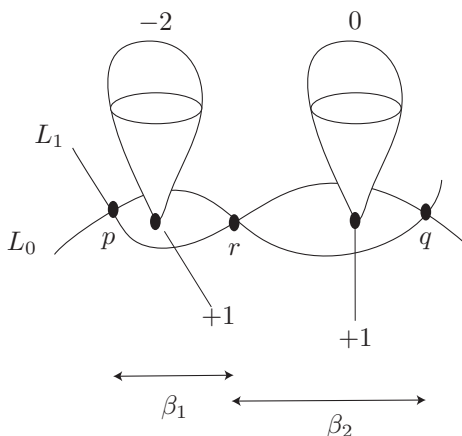

FIGURE 5. Monotonicity is broken: 2

Even if J satisfies the assumption in Lemma 2.12, we may still have an arrangement as in Figure 5 that causes the issue we raised above. In Figure 5 two sphere bubbles are completely contained in the divisor \mathcal{D} . The numbers 0 and -2 written at the top of the sphere components are the intersection numbers of those sphere bubbles with \mathcal{D} . (Note that under the assumption in Lemma 2.12, the intersection numbers can be nonpositive only when the spheres are contained in the divisor.) The two strips (joining p to r and r to q) intersect with \mathcal{D} at the roots of the sphere bubbles. The intersection number of the strips with \mathcal{D} are both $+1$ as drawn in the figure. (This number is necessarily positive because of Lemma 2.12.) In this case, β_1 and β_2 are homology classes of the strips together with sphere bubbles on them. Therefore, $\beta_1 \cdot [\mathcal{D}] = -1$ and $\beta_2 \cdot [\mathcal{D}] = +1$.

The key idea to resolve this issue is to replace stable map topology with a stronger topology, called RGW topology. The main issue with the stable map compactification (and its Kuranishi structure) is its insensitivity with respect to the assumption that \mathcal{D} is a divisor and the almost complex structure J has a special behavior in a neighborhood of this submanifold of X . The compactified moduli spaces with respect to RGW topology admit Kuranishi structures that take into account the special geometry of X around the divisor \mathcal{D} . In particular, an analogue of Lemma 2.12 is built into the definition of the RGW topology. In the rest of this paper, we introduce the RGW topology and discuss the compactification of the moduli spaces with respect to this topology. Kuranishi structures on these moduli spaces are constructed in [DF18b, DF18c] and then we explain there how we can use the monotonicity of L_i in $X \setminus \mathcal{D}$ to adapt Oh's argument to prove Theorem 1.

Before closing this section, we explain how the method of this paper compares with the existing works on relative Gromov–Witten invariants. Relative Gromov–Witten theory provides invariants of a pair (X, \mathcal{D}) of a symplectic manifold together with a divisor using the moduli spaces of pseudo-holomorphic curves u from a Riemann surface of surface Σ_g with k marked points $\{w_1, \dots, w_k\} \subset \Sigma_g$ into X such that $u^{-1}(\mathcal{D})$ is equal to $\{w_1, \dots, w_k\}$ and the multiplicity of the intersection of u at the point w_i with the divisor \mathcal{D} is a fixed positive integer m_i . (More generally, one can consider the case that \mathcal{D} is a normal crossing divisor.) One can approach this theory with the methods of algebraic geometry (assuming integrability of the pair (X, \mathcal{D})) and symplectic geometry. On the algebro-geometric side, such a theory is developed and studied in J. Li [Li01, Li02], Gross and Siebert [GS13] and others. In the category of symplectic manifolds, relative Gromov–Witten invariants were defined in several works under various assumptions in the works of Li and Ruan [LR01], Ionel and T. Parker [IP03, IP04], B. Parker [Par12, Par15, Par19a, Par13, Par19b], Tehrani and Zinger [TZ16] and Tehrani [Teh22]. (See also [Teh13] on open Gromov–Witten invariants.) A review of some of these works can be found in [TZ14].

As it was mentioned in the introduction, relative Gromov–Witten theory is an important source of inspiration for parts of our construction. In particular, the basic idea of the notion of RGW topology and its compactification already appears in [IP03, Proposition 7.3], [Par15, Theorem 6.1] and [Teh22, Definition 3.7]. However, we decided to give a self-contained review of the definition of the RGW compactification and the RGW topology on this space in our present setup. One reason is that the above works on relative Gromov–Witten invariants concern moduli of pseudo-holomorphic maps from source curves that have empty boundary. In the case of pseudo-holomorphic curves satisfying Lagrangian boundary condition on the boundary of the source curve, several new points about our moduli spaces need to be further studied. For instance, our construction of Floer theory requires an explicit understanding of codimension one boundary, where there is a new feature in our situation which does not appear in the previous works on Lagrangian Floer theory (see [DF18c, Subsection 2.2] for more details).

In order to construct the version of Floer homology promised in Theorem 1, we use virtual fundamental chain techniques. In the case of relative Gromov–Witten theory, the relevant moduli spaces are expected to be manifolds without boundary (more precisely Kuranishi spaces without boundary), and one needs to associate a virtual fundamental cycle to any of them. On the other hand, the moduli spaces relevant for us are expected to have boundary and hence the construction of virtual fundamental chains in this setup would be a more delicate task. To achieve this goal, we need a detailed description of the strata of the RGW compactification. In Section 3, we use some combinatorial data in the form of graphs with additional decorations to give such descriptions.

To the best of our understanding, a detailed construction of virtual fundamental cycles for relative Gromov–Witten invariants in the symplectic category (without any

semi-positivity assumption on the divisor) appears only in the works of B. Parker on exploded manifolds. Parker constructs such virtual fundamental cycles using techniques from toric geometry and sheaf theory. It seems reasonable to expect that one can approach the construction of the virtual fundamental chains required for the proof of Theorem 1 from the same approach.

3. RGW COMPACTIFICATION OF THE MODULI SPACE OF DISKS AND STRIPS IN $X \setminus \mathcal{D}$

As we explained in the last section, the stable map compactification is not suitable for the proof of Theorem 1. In this section, we start the task of defining the alternative RGW compactification. In particular, we define the sets

$$(3.1) \quad \begin{aligned} \mathcal{M}^{\text{RGW}}(L_1, L_0; p, q; \beta), & \quad \mathcal{M}_{0,1}^{\text{RGW}}(L_1, L_0; p, q; \beta), \\ \mathcal{M}_{1,0}^{\text{RGW}}(L_1, L_0; p, q; \beta), & \quad \mathcal{M}_1^{\text{RGW}}(L; \alpha). \end{aligned}$$

that contain the spaces in (2.4). In the next section, we define a topology on this sets that agree with the standard topology on the subspaces given in (2.4). Moreover, we shall show that the spaces in (3.1) are compact and metrizable.

Remark 3.2. In [DF18b, DF18c], we show that the RGW compactifications admit Kuranishi structures. Moreover, the normalized boundary of $\mathcal{M}^{\text{RGW}}(L_1, L_0; p, q; \beta)$ can be split into three types similar to (but not exactly in the same way as in) the case of the stable compactification of moduli spaces of holomorphic strips into a compact symplectic manifold, which was reviewed in the previous section.

Remark 3.3. We do not need the monotonicity assumption to prove the above claims (including the existence of Kuranishin structures) about the spaces in (3.1). We use the monotonicity to derive Theorem 1 from the above claims on the structure of the spaces in (3.1).

3.1. Partial \mathbb{C}_* -actions and divisors. Given a smooth divisor \mathcal{D} in X , there is a partially defined \mathbb{C}_* action in a regular neighborhood of \mathcal{D} . This action plays a central role in our construction of the RGW compactification. So we take a moment to formalize the notion of a partial \mathbb{C}_* action on a manifold with an almost complex structure.

Definition 3.4. Let (Y, J) be an almost complex manifold and D a codimension 2 submanifold of Y . A partial \mathbb{C}_* action on (Y, D) is a pair $(\mathcal{U}, \mathfrak{m})$ where:

- (1) \mathcal{U} is an open neighborhood of $\mathbb{C} \times D$ in $\mathbb{C} \times Y$.
- (2) $\mathfrak{m} : \mathcal{U} \rightarrow Y$ is a smooth map. For $(c, p) \in \mathcal{U}$ we write $c \cdot p$ for $\mathfrak{m}(c, p)$. We say $c \cdot p$ is defined if $(c, p) \in \mathcal{U}$.
- (3) If $c_2 \cdot p$ and $c_1 c_2 \cdot p$ are defined, then $c_1 \cdot (c_2 \cdot p)$ is also defined and is equal to $c_1 c_2 \cdot p$.
- (4) If $c \cdot p$ is defined and $c \neq 0$, then $c^{-1} \cdot (c \cdot p)$ is defined and is p .
- (5) If $p \in D$, then for any c , $c \cdot p$ is defined and is equal to p .
- (6) If $0 \cdot p$ is defined, then $0 \cdot p \in D$.
- (7) For $c \neq 0$, the map $p \mapsto c \cdot p$ preserves almost complex structure on the domain where it is defined.

Definition 3.5. Let D be an almost complex manifold and $\pi : L \rightarrow D$ be a complex line bundle over D . Suppose also $\theta \in \Omega^1(L)$ is a connection 1-form on L . Then for any $p \in L$, the horizontal subspace $H_p := \ker(\theta_p)$ of $T_p L$ can be equipped with a complex structure by requiring that the derivative of π is complex linear as an isomorphism from H_p to $T_{\pi(p)} D$. Thus we obtain a complex structure J on L by requiring that the tangent space to the fiber at p with its standard complex structure and H_p are complex subspaces of $T_p L$. With respect to this complex structure, scaling in the fiber direction provides a partial \mathbb{C}_* action on (L, D) in the sense of Definition 3.4.

Example 3.6. We can generalize Definition 3.5 in the following way. Let Y be an almost complex submanifold and D be a codimension 2 submanifold of Y such that for a neighborhood U of D there is a map $\Phi : U \rightarrow L$ that is a diffeomorphism into its image preserving the almost complex structures and the restriction of Φ to $D \subset U$ is the identity map into the zero section of L . Then we may pull back the partial \mathbb{C}_* action on (L, D) to obtain a partial \mathbb{C}_* action on (Y, D) .

Now suppose (L, J) be as in Definition 3.5 and $u : (\Sigma, j) \rightarrow (L, J)$ be a pseudo-holomorphic map from a Riemann surface to L . Thus $v := \pi \circ u$ is a pseudo-holomorphic map into D , and $\theta_u := v^*\theta$ defines a connection on the pulled back bundle $L_u := v^*L$. Applying Definition 3.5 to L_u and θ_u determines a complex structure J_u on the total space of L_u . The map u induces a section $s_u : \Sigma \rightarrow L_u$ that is pseudo-holomorphic with respect to j and J_u . We may also use the $(0, 1)$ component $\bar{\partial}_\theta$ of θ_v to define a holomorphic structure on L_u : a local holomorphic section of L_u is given by a solution of $\bar{\partial}_\theta v = 0$. Since Σ is a Riemann surface, there is no integrability obstruction to solve this equation to find local holomorphic charts for L_u . The connection θ_u with respect to a holomorphic chart for L_u over some open subspace V of Σ has the form $d + \alpha$ where $\alpha \in \Omega^{(1,0)}(V)$. In particular, the underlying complex structure on the holomorphic bundle L_u agrees with J_u , and s_u is a holomorphic section of L_u . We summarize this discussion in the following lemma.

Lemma 3.7. *Suppose (L, J) is given as in Definition 3.5. For any pseudo-holomorphic map $u : (\Sigma, j) \rightarrow (L, J)$, the induced section s_u of the line bundle L_u over Σ is holomorphic.*

3.2. Symplectic and Complex Structures on a Projective Space Bundle. We turn back to our setup where \mathcal{D} is a divisor in (X, ω) . In this subsection, we determine almost complex structures that are used in our main construction. Let $\omega_{\mathcal{D}}$ denote the induced symplectic structure on \mathcal{D} , and let $\mathcal{N}_{\mathcal{D}}(X)$ be the normal bundle of \mathcal{D} in X . Fix an $\omega_{\mathcal{D}}$ -compatible almost complex structure $J_{\mathcal{D}}$ on \mathcal{D} . Fix a compatible almost structure on the symplectic vector bundle $\mathcal{N}_{\mathcal{D}}(X)$ to turn it into a Hermitian line bundle. Let also θ be a $U(1)$ -connection on $\mathcal{N}_{\mathcal{D}}(X)$. Then Definition 3.5 allows us to fix a complex structure on $\mathcal{N}_{\mathcal{D}}(X)$.

One of the ingredients of our RGW compactification are pseudo-holomorphic maps into the *projective bundle* $\mathbf{P}(\mathcal{N}_{\mathcal{D}}(X) \oplus \mathbb{C})$. This space consists of equivalence classes of $(a, b) \in (\mathcal{N}_{\mathcal{D}}(X) \times \mathbb{C}) \setminus \mathcal{D} \times \{0\}$ such that $(a, b) \sim (a', b')$ if there exists $\lambda \in \mathbb{C}_*$ with $(a, b) = (\lambda a', \lambda b')$. This space is a \mathbf{P}^1 -bundle, which determines a compactification of the normal bundle $\mathcal{N}_{\mathcal{D}}(X) \rightarrow \mathcal{D}$. The complex structure on $\mathcal{N}_{\mathcal{D}}(X)$ determines an almost complex structure $J_{\mathbf{P}}$ on $\mathbf{P}(\mathcal{N}_{\mathcal{D}}(X) \oplus \mathbb{C})$. There is an action of \mathbb{C}_* on $\mathbf{P}(\mathcal{N}_{\mathcal{D}}(X) \oplus \mathbb{C})$ where $\lambda \in \mathbb{C}$ maps the equivalence class $[a, b]$ to $[\lambda a, b]$. The complex structure $J_{\mathbf{P}}$ is invariant with respect to the action of \mathbb{C}_* .

We also fix a symplectic structure on $\mathbf{P}(\mathcal{N}_{\mathcal{D}}(X) \oplus \mathbb{C})$, invariant with respect to the action of $S^1 \subset \mathbb{C}_*$. Let $\varphi : [0, \infty) \rightarrow [0, 2)$ be a smooth function satisfying the following properties:

- (i) $\varphi(r) = \frac{r^2}{2}$ for $r \in [0, 1]$;
- (ii) $\varphi(r) = 2 - \frac{1}{r}$ for $r \in [2, \infty)$;
- (iii) $\varphi'(r) > 0$.

The Hermitian structure on $\mathcal{N}_{\mathcal{D}}(X)$ determines a length function $r : \mathcal{N}_{\mathcal{D}}(X) \rightarrow [0, \infty)$. The exact 2-form $d(\varphi(r)\theta)$ on $\mathcal{N}_{\mathcal{D}}(X) \setminus \mathcal{D}$ extends to a smooth closed 2-form on the projective bundle $\mathbf{P}(\mathcal{N}_{\mathcal{D}}(X) \oplus \mathbb{C})$ which is S^1 -invariant and whose restriction to each \mathbf{P}^1 -fiber is a volume form. Therefore, if K is a large enough constant, then the following

form defines an S^1 -invariant symplectic form on $\mathbf{P}(\mathcal{N}_{\mathcal{D}}(X) \oplus \mathbb{C})$:

$$\omega_{\mathbf{P}} := \pi^* \omega_{\mathcal{D}} + \frac{1}{K} d(\varphi(r)\theta).$$

By choosing K large enough, we may also assume that $J_{\mathbf{P}}$ is tame with respect to ω .

Darboux's Theorem for symplectic submanifolds implies that there is a symplectomorphism Φ from a neighborhood of the zero section in $\mathbf{P}(\mathcal{N}_{\mathcal{D}}(X) \oplus \mathbb{C})$ to a neighborhood of \mathcal{D} in X that restricts to the identity map on the zero section [MS98, Theorem 3.30]. We use one such symplectomorphism to push forward $J_{\mathbf{P}}$ to a tame almost complex structure on a neighborhood of \mathcal{D} in X . Then we extend this almost complex structure into a tame almost complex structure J on X . With this choice of almost complex structure on X , there is a partial \mathbb{C}_* action on (X, \mathcal{D}) . The moduli spaces of pseudo-holomorphic curves in X and $\mathbf{P}(\mathcal{N}_{\mathcal{D}}(X) \oplus \mathbb{C})$ in the rest of the paper are defined with respect to J and $J_{\mathbf{P}}$. The following lemma about such pseudo-holomorphic curves is crucial for our construction.

Lemma 3.8. *Suppose $u : (\Sigma, j) \rightarrow (X, J)$ is a pseudo-holomorphic curve. Then the multiplicity of any intersection point of u and \mathcal{D} is a positive integer. A similar claim holds if (X, J) is replaced with $(\mathbf{P}(\mathcal{N}_{\mathcal{D}}(X) \oplus \mathbb{C}, \mathcal{D}_0 \cup \mathcal{D}_{\infty})$ where \mathcal{D}_0 and \mathcal{D}_{∞} are given by the sections at zero and infinity.*

Proof. It suffices to consider the pseudo-holomorphic maps u that are mapped to a tubular neighborhood of \mathcal{D} where the almost complex structure has the form given in Definition 3.5. In this case, the claim follows from Lemma 3.7 and the corresponding positivity result in the holomorphic category. \square

Remark 3.9. The almost complex structures J and $J_{\mathbf{P}}$ depend on $J_{\mathcal{D}}$, the compatible complex structure on the symplectic vector bundle $\mathcal{N}_{\mathcal{D}}(X)$, the connection θ , the symplectomorphism Φ and the extension of $\Phi_*(J_{\mathcal{D}})$ into a tame almost complex structure on X . The space of all such choices has trivial homotopy groups. This fact will be used in [DF18c] to show that our version of Lagrangian Floer homology does not depend on the choices of almost complex structures.

Remark 3.10. We use the partial \mathbb{C}_* action on (X, \mathcal{D}) in the definition of the RGW topology and the gluing analysis. To carry this out, it is important for us that our almost complex structure is invariant with respect to this partial \mathbb{C}_* action. We believe that a similar construction can be carried out for a slightly more general family of almost complex structures at the expense of more work on the analysis part. In fact, it is reasonable to expect that similar assumptions on almost complex structures as in the literature on relative Gromov-Witten theory, where one does not require invariance with respect to a partial \mathbb{C}_* action, would be sufficient for our purposes. For instance, [IP03] works with almost complex structures that satisfy an infinitesimal integrability in the normal direction to \mathcal{D} , and \mathcal{D} is an almost complex submanifold [IP03, Definition 3.2]. The almost complex structure J constructed above satisfies these conditions. On the other hand, integrable almost complex structures are often not invariant with respect to any partial \mathbb{C}_* action, but still fits into the framework of [IP03, Definition 3.2]. Since we do not gain anything from working in such generality and the analytical aspects of partially \mathbb{C}_* -invariant almost complex structures are simpler, we content ourselves with this more restricted family of almost complex structures.

3.3. RGW Compactification in a Neighborhood of the Divisor. Fix non-zero integers $m_0, m_1, \dots, m_{\ell} \in \mathbb{Z} \setminus \{0\}$ and let $\mathbf{m} = (m_0, m_1, \dots, m_{\ell})$. Let also $\Pi_2(\mathcal{D}) = \text{Im}(\pi_2(\mathcal{D}) \rightarrow H_2(\mathcal{D}))$. For $\alpha \in \Pi_2(\mathcal{D}; \mathbb{Z})$, the moduli space $\mathcal{M}^0(\mathcal{D} \subset X; \alpha; \mathbf{m})$ is defined as follows:

Definition 3.11. An element of $\mathcal{M}^0(\mathcal{D} \subset X; \alpha; \mathbf{m})$ is an isomorphism class of a triple $((\Sigma, \vec{w}); u; s)$ with the following properties:

- (1) (Σ, \vec{w}) is a nodal curve of genus zero with $\ell + 1$ marked points $\vec{w} = (w_0, \dots, w_\ell)$. The marked points w_i are not nodal points.
- (2) $u : \Sigma \rightarrow \mathcal{D}$ is a holomorphic map representing the homology class α .
- (3) s is a section of $u^*\mathcal{N}_{\mathcal{D}}(X)$ on $\Sigma \setminus \vec{w}$ and is extended to a meromorphic section on Σ .
- (4) For $i = 0, 1, \dots, \ell$, the section s has a zero of multiplicity m_i at w_i if $m_i > 0$, and it has a pole of multiplicity $-m_i$ at w_i if $m_i < 0$. s is nonzero on $\Sigma \setminus \{w_0, \dots, w_\ell\}$.
- (5) The stability condition defined in Definition 3.13 holds.

The definition of isomorphism between two such elements are given in Definition 3.12.

Definition 3.12. Let $\mathbf{x} = ((\Sigma, \vec{w}); u; s)$ and $\mathbf{x}' = ((\Sigma', \vec{w}'); u'; s')$ be as in Definition 3.11. An *isomorphism* from \mathbf{x} to \mathbf{x}' is a pair (v, c) such that:

- (1) $v : \Sigma \rightarrow \Sigma'$ is a biholomorphic map such that $u' \circ v = u$,
- (2) c is a nonzero complex number such that $s' \circ v = cs$.

We say \mathbf{x} is *isomorphic* to \mathbf{x}' if there exists an isomorphism between them. We say \mathbf{x} is *strongly isomorphic* to \mathbf{x}' if we can additionally assume $c = 1$. We denote by $\widetilde{\mathcal{M}}^0(\mathcal{D} \subset X; \alpha; \mathbf{m})$ the set of all strong isomorphism classes.

Definition 3.13. We say an element $\mathbf{x} = [(\Sigma, \vec{w}); u; s]$ as in Definition 3.11 is *stable* if the set of isomorphisms from \mathbf{x} to itself is a finite set.

Note that there exists a \mathbb{C}_* action on $\widetilde{\mathcal{M}}^0(\mathcal{D} \subset X; \alpha; \mathbf{m})$ such that

$$(3.14) \quad \widetilde{\mathcal{M}}^0(\mathcal{D} \subset X; \alpha; \mathbf{m})/\mathbb{C}_* = \mathcal{M}^0(\mathcal{D} \subset X; \alpha; \mathbf{m}).$$

Remark 3.15. The holomorphic structure on $u^*\mathcal{N}_{\mathcal{D}}(X)$ used in Definition 3.11 is the one discussed in Subsection 3.1.

Remark 3.16. We define:

$$d(\alpha) := [\mathcal{D}] \cdot \alpha.$$

In the right hand side, we regard $[\mathcal{D}]$ and α as homology classes in X . We call d the *degree* of (Σ, u) . If $\mathcal{M}^0(\mathcal{D} \subset X; \alpha; \mathbf{m})$ is non-empty, then the definition implies that

$$(3.17) \quad d(\alpha) = \sum_{i=0}^{\ell} m_i.$$

Definition 3.18. We define evaluation maps

$$\text{ev} = (\text{ev}_0, \dots, \text{ev}_\ell) : \mathcal{M}^0(\mathcal{D} \subset X; \alpha; \mathbf{m}) \rightarrow \mathcal{D}^{\ell+1}$$

by

$$(3.19) \quad \text{ev}_i((\Sigma, \vec{w}); u; s) = u(w_i).$$

Let $((\Sigma, \vec{w}); u; s)$ represent an element of $\mathcal{M}^0(\mathcal{D} \subset X; \alpha; \mathbf{m})$. Define the map U from Σ to the \mathbf{P}^1 -bundle $\mathbf{P}(\mathcal{N}_{\mathcal{D}}(X) \oplus \mathbb{C})$ over \mathcal{D} as follows (see Figure 6):

$$(3.20) \quad U(z) = [s(z) : 1] \in \mathbf{P}(\mathcal{N}_{\mathcal{D}}(X) \oplus \mathbb{C}).$$

The discussion of Subsection 3.1 shows that U is $J_{\mathbf{P}}$ -holomorphic. The homology class of this map in $H_2(\mathbf{P}(\mathcal{N}_{\mathcal{D}}(X) \oplus \mathbb{C}); \mathbb{Z})$, denoted by $\hat{\alpha}$, is uniquely determined by the following two properties:

- (i) Projection of $\hat{\alpha}$ to $H_2(\mathcal{D})$ is α . Here $\mathcal{D} \subset \mathbf{P}(\mathcal{N}_{\mathcal{D}}(X) \oplus \mathbb{C})$ is identified with the zero section.
- (ii) The algebraic intersection of the infinity section \mathcal{D}_∞ and $\hat{\alpha}$ is given by:

$$\hat{\alpha} \cap [\mathcal{D}_\infty] = - \sum_{m_i < 0} m_i.$$

Therefore, $((\Sigma, \vec{w}); U)$ defines an element of $\mathcal{M}_{\ell+1}(\mathbf{P}(\mathcal{N}_{\mathcal{D}}(X) \oplus \mathbb{C}); \hat{\alpha})$, the moduli space of stable maps of genus zero in $\mathbf{P}(\mathcal{N}_{\mathcal{D}}(X) \oplus \mathbb{C})$ of homology class $\hat{\alpha}$ and with $\ell+1$ marked points. In particular, the stability in Definition 3.13 implies the stability of U (as a holomorphic map from a nodal Riemann surface with marked points). The \mathbb{C}_* action $c[a : b] = [ca : b]$ on $\mathbf{P}(\mathcal{N}_{\mathcal{D}}(X) \oplus \mathbb{C})$ induces a \mathbb{C}_* action on $\mathcal{M}_{\ell+1}(\mathbf{P}(\mathcal{N}_{\mathcal{D}}(X) \oplus \mathbb{C}); \hat{\alpha})$. The element $[((\Sigma, \vec{w}); U)]$ in the quotient space $\mathcal{M}_{\ell+1}(\mathbf{P}(\mathcal{N}_{\mathcal{D}}(X) \oplus \mathbb{C}); \hat{\alpha})/\mathbb{C}_*$ is independent of the choices of the representative $((\Sigma, \vec{w}); u; s)$ and so we may define a map

$$(3.21) \quad \mathcal{M}^0(\mathcal{D} \subset X; \alpha; \mathbf{m}) \rightarrow \mathcal{M}_{\ell+1}(\mathbf{P}(\mathcal{N}_{\mathcal{D}}(X) \oplus \mathbb{C}); \hat{\alpha})/\mathbb{C}_*,$$

which is injective.

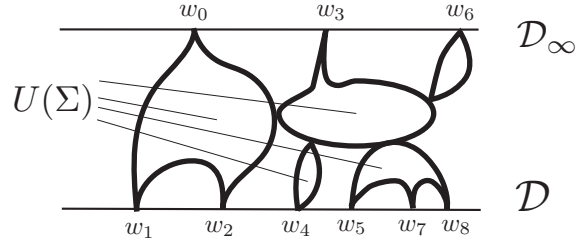

FIGURE 6. An element of $\mathcal{M}^0(\mathcal{D} \subset X; \alpha; \mathbf{m})$

Let $\mathcal{M}_{\ell+1}(\mathcal{D}; \alpha)$ be the moduli space of stable $J_{\mathcal{D}}$ -holomorphic maps of genus 0 in the manifold \mathcal{D} with $\ell+1$ marked points and of homology class α . We define a map

$$(3.22) \quad \mathcal{M}^0(\mathcal{D} \subset X; \alpha; \mathbf{m}) \rightarrow \mathcal{M}_{\ell+1}(\mathcal{D}; \alpha)$$

by sending $[((\Sigma, \vec{w}); u; s)]$ to $[((\Sigma, \vec{w}); u)]$, namely, we forget s in $((\Sigma, \vec{z}); u; s)$. (Note that stability is preserved by this process.)

We denote by $\mathcal{M}^{00}(\mathcal{D} \subset X; \alpha; \mathbf{m})$ (resp. $\mathcal{M}_{\ell+1}^0(\mathcal{D}; \alpha)$) the subset of $\mathcal{M}^0(\mathcal{D} \subset X; \alpha; \mathbf{m})$ (resp. $\mathcal{M}_{\ell+1}(\mathcal{D}; \alpha)$) consisting of elements such that Σ is a sphere, namely, it consists of elements without nodal points.

Lemma 3.23. *The map (3.22) is injective. Moreover, (3.22) induces a bijection*

$$(3.24) \quad \mathcal{M}^{00}(\mathcal{D} \subset X; \alpha; \mathbf{m}) \rightarrow \mathcal{M}_{\ell+1}^0(\mathcal{D}; \alpha)$$

if (3.17) holds.

Proof. Suppose $[((\Sigma, \vec{w}); u; s)]$, $[((\Sigma, \vec{w}); u; s')]$ are two elements of $\mathcal{M}^0(\mathcal{D} \subset X; \alpha; \mathbf{m})$ mapped to the same element of $\mathcal{M}_{\ell+1}^0(\mathcal{D}; \alpha)$. Then the ratio s'/s defines a holomorphic function on Σ which is nonzero everywhere. Therefore, s'/s is constant. Thus $[((\Sigma, \vec{w}); u; s)] = [((\Sigma, \vec{w}); u; s')]$ in $\mathcal{M}^0(\mathcal{D} \subset X; \alpha; \mathbf{m})$. It is also easy to see that (3.24) is surjective when (3.17) holds. \square

In the same way, we can prove:

Lemma 3.25. *(3.22) is a bijection onto an open subset of $\mathcal{M}_{\ell+1}(\mathcal{D}; \alpha)$ (with respect to the stable map topology).*

Proof. Let $((\Sigma, \vec{z}), u)$ be an element of $\mathcal{M}_{\ell+1}(\mathcal{D}; \alpha)$. We decompose Σ into irreducible components as

$$\Sigma = \bigcup_a \Sigma_a.$$

We can easily show that $[((\Sigma, \vec{w}), u)]$ is in the image of (3.22) if and only if the next equalities hold for each a .

$$(3.26) \quad \mathcal{D} \cdot u_*[\Sigma_a] = \sum_{z_i \in \Sigma_a} m_i.$$

Condition (3.26) is an open condition with respect to the stable map topology. Therefore, the image of (3.22) is open. \square

If we topologize $\mathcal{M}^0(\mathcal{D} \subset X; \alpha; \mathbf{m})$ using the bijection in Lemma 3.25, the resulting space is not compact. This issue stems from non-compactness of \mathbb{C}_* . Our next task is to compactify $\mathcal{M}^0(\mathcal{D} \subset X; \alpha; \mathbf{m})$. The compactification has a stratification and each stratum is described by an appropriate fiber product of the spaces of the form $\mathcal{M}^0(\mathcal{D} \subset X; \alpha'; \mathbf{m}')$ for various choices of α' , \mathbf{m}' . The strata of our compactification are labeled with *decorated rooted trees*. They also encode the data of how to take fiber products:

Definition 3.27. A decorated rooted tree is a quadruple $\mathcal{T} = (T, \alpha, m, \lambda)$ with the following properties:

- (1) T is a tree with the set of vertices $C_0(T)$ and the set of edges $C_1(T)$. We are given a decomposition of $C_0(T)$ into the disjoint union of two subsets $C_0^{\text{out}}(T)$ and $C_0^{\text{ins}}(T)$. We call an element of $C_0^{\text{out}}(T)$ (resp. $C_0^{\text{ins}}(T)$) *an outside vertex* (resp. *inside vertex*).
- (2) All the outside vertices have valency one. We call an edge incident to an outside vertex an *outside edge*. Any of the remaining edges is called an *inside edge*.
- (3) There is a distinguished outside vertex v^0 of T . Let e^0 be the unique edge which contains v^0 . We call v^0 and e^0 the *root vertex* and the *root edge*, respectively. We call them root if it is clear from the context whether we mean the root vertex or the root edge. We also fix a labeling $\{v^0, v^1, \dots, v^\ell\}$ of the outside vertices.
- (4) $\alpha : C_0^{\text{ins}}(T) \rightarrow \Pi_2(\mathcal{D}; \mathbb{Z})$ is a map from the set of the inside vertices to $\Pi_2(\mathcal{D}; \mathbb{Z})$. We call $\alpha(v)$ the *homology class of v* .
- (5) $m : C_1(T) \rightarrow \mathbb{Z} \setminus \{0\}$ is a $\mathbb{Z} \setminus \{0\}$ -valued function which assigns a nonzero integer to each edge. We call $m(e)$ the *multiplicity of e* .
- (6) $\lambda : C_0^{\text{ins}}(T) \rightarrow \mathbb{Z}_+$ is a \mathbb{Z}_+ valued function. For a vertex v , we call $\lambda(v)$ the *level of v* . There exists $|\lambda| \in \mathbb{Z}_+$ such that the image of λ is $\{1, 2, \dots, |\lambda|\}$, namely, λ is a surjective map to $\{1, 2, \dots, |\lambda|\}$. We call $|\lambda|$ the *number of levels*.
- (7) For each vertex $v \in C_0^{\text{ins}}(T)$, there exists a unique edge of v which is contained in the same connected component as the root in $T \setminus v$. We call it the *first edge of v* and denote it by $e(v)$. We then require the following *balancing condition*:

$$(3.28) \quad m(e(v)) + \alpha(v) \cdot [\mathcal{D}] = \sum_{e \in C_1(T): v \in e, e \neq e(v)} m(e).$$

(This condition is the analogue of (3.17).)

- (8) (Stability condition) Each vertex $v \in C_0^{\text{ins}}(T)$ satisfies at least one of the following conditions:
 - (a) v contains at least 3 edges.
 - (b) $\alpha(v) \cap [\omega_{\mathcal{D}}] > 0$.
 - (9) Let e be an inside edge incident to the vertices v, v' . We assume e is $e(v')$, the first edge of v' .
 - (a) If $m(e) > 0$, then $\lambda(v) < \lambda(v')$.
 - (b) If $m(e) < 0$, then $\lambda(v) > \lambda(v')$.
- In particular, $\lambda(v) \neq \lambda(v')$.

For a decorated rooted tree \mathcal{T} , we define the *homology class of \mathcal{T}* by

$$(3.29) \quad \alpha(\mathcal{T}) = \sum_{v \in C_0^{\text{ins}}(T)} \alpha(v)$$

We say $m(e^0)$ is the *input multiplicity of \mathcal{T}* and the set $\{m(e^i) \mid e^i \in C_1^{\text{out}}(T)\}$ gives the *output multiplicities of \mathcal{T}* .

Let e belong to the set of inside edges $C_1^{\text{ins}}(T)$. The two vertices incident to e are the *target vertex* $t(e)$ and *source vertex* $s(e)$ of e , if e is the first edge of $t(e)$.

Remark 3.30. We orient the edges so that it starts from the vertex $s(e)$ and ends at the vertex $t(e)$. (See Figure 7.) Then for given vertex v all the edges other than the first edge $e(v)$ goes from v to other vertices. This is consistent with the convention in (3.28) only $e(v)$ is on the left hand side.

Example 3.31. An example of a decorated rooted tree \mathcal{T} is given in Figure 7. In the figure, the outside vertices are drawn by black circles and inside vertices are drawn by white circles. The input multiplicity of \mathcal{T} is 3 and its output multiplicity is -1 . The number of levels is 4. We also have

$$e(v_1) = e_0, \quad e(v_2) = e_1, \quad e(v_3) = e_2, \quad e(v_4) = e_3, \quad e(v_5) = e_4,$$

$$\alpha(v_2) \cdot \mathcal{D} = -3, \quad \alpha(v_3) \cdot \mathcal{D} = -2, \quad \alpha(v_4) \cdot \mathcal{D} = -1, \quad \alpha(v_5) \cdot \mathcal{D} = 2,$$

and

$$\alpha(v_1) = 0.$$

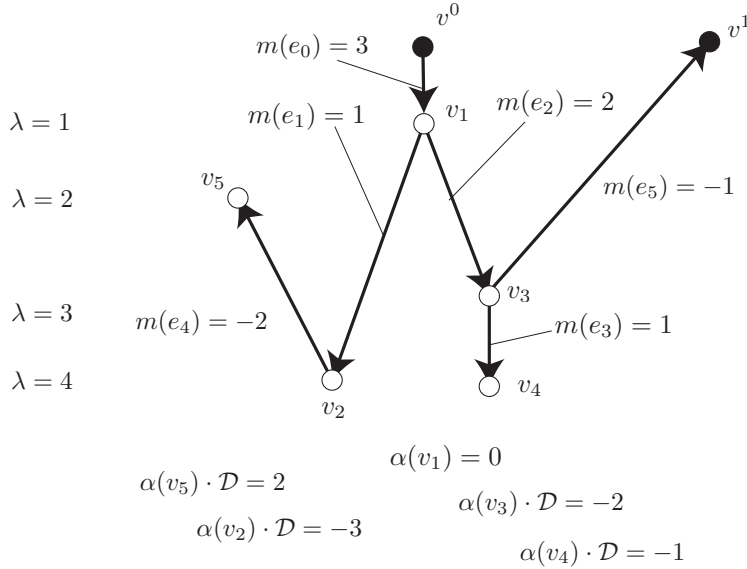

FIGURE 7. Decorated rooted tree

Remark 3.32. The notion of level here is similar to the one appearing in the compactification of the moduli space of pseudo-holomorphic curves in symplectic field theory [BEH⁺03] and its generalization to stable Hamiltonian structures [CV15].

Definition 3.33. To each decorated rooted tree $\mathcal{T} = (T, \alpha, m, \lambda)$, we associate a moduli space $\widetilde{\mathcal{M}}^0(\mathcal{D}; \mathcal{T})$ as follows. Fix an inside vertex $v \in C_0^{\text{ins}}(T)$. Define m_0^v to be $-m(e(v))$ where $e(v)$ is the first edge of v defined in Definition 3.27 (7). Let $e_1^v, \dots, e_{\ell(v)}^v$ be the remaining edges of v , $m_i^v = m(e_i^v)$ and $\mathbf{m}^v = (m_0^v, m_1^v, \dots, m_{\ell(v)}^v)$. Define:

$$(3.34) \quad \widetilde{\mathcal{M}}^0(\mathcal{D}; \mathcal{T}; v) = \widetilde{\mathcal{M}}^0(\mathcal{D} \subset X; \alpha(v); \mathbf{m}^v).$$

Note that the right hand side is independent of the order of the edges $e_1^v, \dots, e_{\ell(v)}^v$.

Consider the evaluation map

$$(3.35) \quad \text{EV} : \prod_{v \in C_0^{\text{ins}}(T)} \widetilde{\mathcal{M}}^0(\mathcal{D}; \mathcal{T}; v) \rightarrow \prod_{e \in C_1^{\text{ins}}(T)} (\mathcal{D} \times \mathcal{D})$$

defined as follows. Let $\vec{\mathbf{x}} = (\mathbf{x}_v; v \in C_0^{\text{ins}}(T))$ be an element of the domain of EV. The e -th component $\text{EV}(\vec{\mathbf{x}})_e$ of $\text{EV}(\vec{\mathbf{x}})$ is by definition:

$$(3.36) \quad \text{EV}(\vec{\mathbf{x}})_e = (\text{ev}_0(\mathbf{x}_{t(e)}), \text{ev}_i(\mathbf{x}_{s(e)})) \in \mathcal{D} \times \mathcal{D}.$$

Here ev_0 and ev_i are as in Definition 3.18 and i is taken so that e is the i -th edge of $s(e)$. ($s(e)$ and $t(e)$ are defined at the end of Definition 3.27.) Let $\Delta \subset \mathcal{D} \times \mathcal{D}$ be the diagonal. We now define

$$(3.37) \quad \widetilde{\mathcal{M}}^0(\mathcal{D}; \mathcal{T}) = \prod_{v \in C_0^{\text{ins}}(T)} \widetilde{\mathcal{M}}^0(\mathcal{D}; \mathcal{T}; v) \underset{\text{EV}}{\times} \star \prod_{e \in C_1^{\text{ins}}(T)} \Delta.$$

Here we take the fiber product over the space $\prod_{e \in C_1^{\text{ins}}(T)} (\mathcal{D} \times \mathcal{D})$ and \star denotes the inclusion of $\prod \Delta$ into $\prod (\mathcal{D} \times \mathcal{D})$. The other map in the definition of the fiber product is given in (3.35). We topologize $\widetilde{\mathcal{M}}^0(\mathcal{D}; \mathcal{T}; v)$ with the fiber product topology.

Example 3.38. Figure 8 sketches an element of $\widetilde{\mathcal{M}}^0(\mathcal{D}; \mathcal{T}; v)$ for the decorated ribbon tree \mathcal{T} given in Figure 8. Each of the vertical lines (4 of them) in the figure corresponds to a “trivial cylinder” that is a map to a single fiber of $\mathbf{P}(\mathcal{N}_{\mathcal{D}}(X) \oplus \mathbb{C})$. (More precisely, it is an $|m(e)|$ fold covering to a fiber.) The number assigned to a vertical edge or a double point is the multiplicity of the corresponding edge of our tree. The map $u : \Sigma \rightarrow \mathcal{D}$ in Figure 8 corresponding to \mathbf{x}_{v_1} has homology class 0 and is a constant map to a point p of \mathcal{D} . So the image of the map U corresponding to \mathbf{x}_{v_1} is contained in a fiber of the normal bundle $\mathcal{N}_{\mathcal{D}}(X)$ at p .

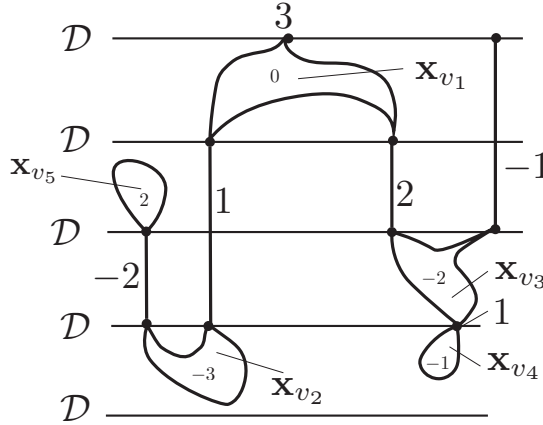

FIGURE 8. Configuration associated to the decorated rooted tree in Figure 7

Definition 3.39. Let $|\lambda|$ be the number of the levels of \mathcal{T} . We define a $\mathbb{C}_*^{|\lambda|}$ action on $\widetilde{\mathcal{M}}^0(\mathcal{D}; \mathcal{T})$ as follows. For $\vec{\rho} = (\rho_1, \dots, \rho_{|\lambda|}) \in \mathbb{C}_*^{|\lambda|}$ and $\vec{\mathbf{x}} = (\mathbf{x}_v) \in \prod_{v \in C_0^{\text{ins}}(T)} \widetilde{\mathcal{M}}(\mathcal{D}; \mathcal{T}; v)$. We have:

$$(3.40) \quad \vec{\rho} \cdot \vec{\mathbf{x}} = (\rho_{\lambda(v)} \mathbf{x}_v).$$

Note that $\lambda(v)$ is the level of the vertex v and $\rho_{\lambda(v)} \in \mathbb{C}_*$. The \mathbb{C}_* action on $\widetilde{\mathcal{M}}(\mathcal{D}; \mathcal{T}; v)$ is defined as in (3.14). The quotient space of this action is denoted by

$$\widehat{\mathcal{M}}^0(\mathcal{D}; \mathcal{T}) = \widetilde{\mathcal{M}}^0(\mathcal{D}; \mathcal{T}) / \mathbb{C}_*^{|\lambda|}.$$

We use the quotient topology to topologize this space.

Next, we take the quotient of $\widehat{\mathcal{M}}^0(\mathcal{D}; \mathcal{T})$ with respect to the action of the group of automorphisms of the decorated rooted tree \mathcal{T} .

Definition 3.41. An automorphism of the decorated rooted tree \mathcal{T} is an automorphism of the tree T which fixes all the outside vertices and commutes with α , m and λ . The group of automorphisms of \mathcal{T} , which is a finite group, is denoted by $\text{Aut}(\mathcal{T})$.

An element of $\text{Aut}(\mathcal{T})$ exchanges the vertices of T . Thus it induces an automorphism of $\widetilde{\mathcal{M}}^0(\mathcal{D}; \mathcal{T})$. This action is compatible with the $\mathbb{C}_*^{|\lambda|}$ action. Therefore, we obtain an action of $\text{Aut}(\mathcal{T})$ on $\widehat{\mathcal{M}}^0(\mathcal{D}; \mathcal{T})$. We denote the quotient space by

$$\mathcal{M}^0(\mathcal{D}; \mathcal{T}) = \widehat{\mathcal{M}}^0(\mathcal{D}; \mathcal{T}) / \text{Aut}(\mathcal{T}).$$

We say decorated rooted trees $\mathcal{T} = (\mathcal{T}, \alpha, m, \lambda)$ and $\mathcal{T}' = (\mathcal{T}', \alpha', m', \lambda')$ are isomorphic, if there exists an isomorphism of the underlying trees T, T' which sends root to root, outside vertices to outside vertices, α to α' , m to m' , λ to λ' , and preserves the ordering of the outside vertices. From now on, we do not distinguish between a decorated rooted tree and its isomorphism class.

We now define a compactification of $\mathcal{M}^0(\mathcal{D} \subset X; \alpha; \mathbf{m})$ as a set.

Definition 3.42. Given $\mathbf{m} = (m_0, m_1, \dots, m_\ell)$, we say that \mathcal{T} is of type $(\alpha; \mathbf{m})$ if the homology class of \mathcal{T} is α , its input multiplicity is m_0 and output multiplicities are $\{m_1, \dots, m_\ell\}$. Define $\mathcal{M}(\mathcal{D} \subset X; \alpha; \mathbf{m})$ to be the disjoint union

$$\coprod_{\mathcal{T}} \mathcal{M}^0(\mathcal{D}; \mathcal{T})$$

where \mathcal{T} runs over all the decorated rooted trees of type $(\alpha; \mathbf{m})$.

Proposition 3.43. *There exists a topology on $\mathcal{M}(\mathcal{D} \subset X; \alpha; \mathbf{m})$ which is compact and metrizable. The induced topology on each subspace $\mathcal{M}^0(\mathcal{D}; \mathcal{T})$ coincides with the one defined above.*

The topology in Proposition 3.43 is called the *RGW topology*. This proposition is proved in Section 4.

Remark 3.44. We can also take the following fiber product.

$$(3.45) \quad \prod_{v \in C_0^{\text{ins}}(T)} \mathcal{M}^0(\mathcal{D}; \mathcal{T}; v)_{\text{EV} \times \star} \prod_{e \in C_1^{\text{ins}}(T)} \Delta$$

instead of (3.37), where $\widetilde{\mathcal{M}}^0(\mathcal{D}; \mathcal{T}; v)$ is replaced by $\mathcal{M}^0(\mathcal{D}; \mathcal{T}; v)$, which is by definition $\widetilde{\mathcal{M}}^0(\mathcal{D}; \mathcal{T}; v) / \mathbb{C}_*$. Let $h = \#C_0^{\text{ins}}(T) - |\lambda|$. Then there exists an action of the group

$$\prod_{i=1}^{|\ell|} \frac{\mathbb{C}_*^{h_i}}{\mathbb{C}_*} \cong \mathbb{C}_*^h$$

on $\widehat{\mathcal{M}}^0(\mathcal{D}; \mathcal{T})$ with $h_i = \#\{v \mid \lambda(v) = i\}$ such that (3.45) is the quotient space. This \mathbb{C}_*^h action and the space (3.45) are not used in this paper. In fact, the disjoint union of the spaces (3.45) for various \mathcal{T} with the natural quotient topology does not carry a Kuranishi structure, because this disjoint union is not Hausdorff. We can, however, shrink it by a finite-to-one map and obtain a Hausdorff space. The *log compactification* by [Teh22] seems to be related to this space. For the proof of some of the conjectures in [DF18c, Section 6] (but not for the proof of Theorem 1), it seems necessary to construct a Kuranishi structure on $\mathcal{M}(\mathcal{D} \subset X; \alpha; \mathbf{m})$ and perturbations in a way that are invariant under these strata-wise \mathbb{C}_*^h actions.

Example 3.46. Consider a decorated rooted tree \mathcal{T} of type $(\alpha; \mathbf{m})$ such that \mathcal{T} has exactly one inside vertex v , $\alpha(v) = \alpha$, and $\lambda(v) = 1$. There exists a unique such decorated rooted tree. (The multiplicities of outside edges are determined by \mathbf{m} and there is no inside edge. The balancing condition (7) in Definition 3.27 is a consequence of (3.17).) We call

this decorated rooted tree the *minimal tree* of type $(\alpha; \mathbf{m})$ and denote it by $\mathcal{T}_{\alpha; \mathbf{m}}^0$. It is easy to see from the definition that

$$(3.47) \quad \mathcal{M}^0(\mathcal{D}, \mathcal{T}_{\alpha; \mathbf{m}}^0) = \mathcal{M}^0(\mathcal{D} \subset X; \alpha; \mathbf{m}).$$

Next, we define the notion of level shrinking of decorated rooted trees. This notion will be useful to describe the ‘closure’ of a stratum $\mathcal{M}^0(\mathcal{D}; \mathcal{T})$ in $\mathcal{M}(\mathcal{D} \subset X; \alpha; \mathbf{m})$.

Definition 3.48. Let $\mathcal{T} = (T, \alpha, m, \lambda)$ be a decorated rooted tree as in Definition 3.27 and $|\lambda|$ be the number of levels of \mathcal{T} . Let $1 \leq i < i+1 \leq |\lambda|$. We define the *decorated rooted tree obtained by $(i, i+1)$ level shrinking from \mathcal{T}* as follows.

We first define a tree T' . We shrink each of the edges e in T such that $(\lambda(s(e)), \lambda(t(e))) = (i, i+1)$ or $(\lambda(s(e)), \lambda(t(e))) = (i+1, i)$, to a point. We thus obtain a tree T' together with a map $\pi : T \rightarrow T'$. This map π is an isomorphism on the outside edges. The outside edges of T' are by definition the images of the outside edges of T .

We define $\alpha' : C_0^{\text{ins}}(T') \rightarrow \Pi_2(\mathcal{D}; \mathbb{Z})$ as follows:

$$(3.49) \quad \alpha'(v') = \sum_{v \in C_0^{\text{ins}}(T) \cap \pi^{-1}(v')} \alpha(v).$$

We observe that for any edge e' of T' , the inverse image $\pi^{-1}(e' \setminus \partial e')$ is $e \setminus \partial e$ for some edge e of T . We define $m' : C_1^{\text{ins}}(T') \rightarrow \mathbb{Z} \setminus \{0\}$ by:

$$(3.50) \quad m'(e') = m(e).$$

We finally define a level function $\lambda' : C_1^{\text{ins}}(T') \rightarrow \{1, \dots, |\lambda| - 1\}$ as follows. Let $v' = \pi(v)$ with $v \in C_0^{\text{ins}}(T)$, $v' \in C_0^{\text{ins}}(T')$.

$$(3.51) \quad \lambda'(v') = \begin{cases} \lambda(v) & \text{if } \lambda(v) < i, \\ i & \text{if } \lambda(v) = i \text{ or } i+1, \\ \lambda(v) - 1 & \text{if } \lambda(v) > i+1. \end{cases}$$

It is easy to see that, in the second case, the right hand side is independent of the choice of v and it only depends on v' . It is also easy to show that $(T'; \alpha', m', \lambda')$ has the properties of Definition 3.27. We say \mathcal{T}' is obtained from \mathcal{T} by *level shrinking* and write $\mathcal{T} < \mathcal{T}'$ if \mathcal{T}' is obtained from \mathcal{T} by a finite number of $(i, i+1)$ level shrinkings, possibly for different choices of i . We write $\mathcal{T} \leq \mathcal{T}'$ if $\mathcal{T} < \mathcal{T}'$ or $\mathcal{T} = \mathcal{T}'$.

Figure 9 below is obtained from Figure 7 by (3, 4) level shrinking.

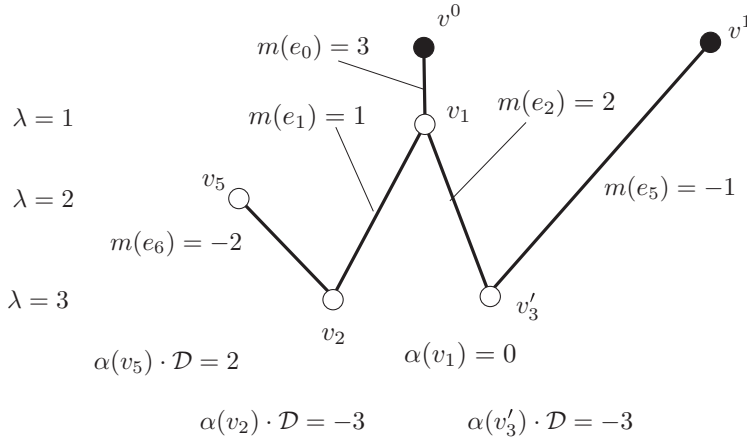

FIGURE 9. level shrinking

The following definition gives a notion of isotropy group for the elements of $\mathcal{M}^0(\mathcal{D}; \mathcal{T})$.

Definition 3.52. Let $\mathfrak{x} \in \mathcal{M}^0(\mathcal{D}; \mathcal{T})$. By definition, \mathfrak{x} is the equivalence class of an element $\widehat{\mathfrak{x}} = ([\mathbf{x}_v] : v \in C_0^{\text{ins}}(T))$ of $\widehat{\mathcal{M}}^0(\mathcal{D}; \mathcal{T})$ by the action of $\text{Aut}(\mathcal{T})$ where $\mathbf{x}_v \in \widetilde{\mathcal{M}}^0(\mathcal{D}; \mathcal{T}; v)$. We also fix a representative $((\Sigma_v, \vec{w}_v); u_v; s_v)$ for \mathbf{x}_v . The isotropy group $\Gamma_{\mathfrak{x}}$ of \mathfrak{x} consists of the elements $(g, \{I_v\}_{v \in C_0^{\text{ins}}(T)})$ where $g \in \text{Aut}(\mathcal{T})$ and $I_v : (\Sigma_v, \vec{w}_v) \rightarrow (\Sigma_{g(v)}, \vec{w}_{g(v)})$ such that $u_{g(v)} \circ I_v = u_v$. Moreover, if $1 \leq i \leq |\lambda|$ with $|\lambda|$ being the number of the levels of \mathcal{T} , then there is a constant number $a_i \in \mathbb{C}_*$ such that for any v with $\lambda(v) = i$ we have:

$$s_{g(v)} \circ I_v = a_i \cdot s_v.$$

Projection of $(g, \{I_v\}_{v \in C_0^{\text{ins}}(T)})$ to g induces a map to $\text{Aut}(\mathcal{T})$ and the kernel of this map is equal to $\prod_{v \in C_0^{\text{ins}}(T)} \text{Aut}(\mathbf{x}_v)$. In particular, if we define:

$$\text{Aut}(\mathcal{T}; \mathfrak{x}) = \{g \in \text{Aut}(\mathcal{T}) \mid g\widehat{\mathfrak{x}} = \widehat{\mathfrak{x}}\}.$$

then we have the short exact sequence

$$(3.53) \quad 1 \rightarrow \text{Aut}(\widehat{\mathfrak{x}}) \rightarrow \Gamma_{\mathfrak{x}} \rightarrow \text{Aut}(\mathcal{T}; \mathfrak{x}) \rightarrow 1.$$

Remark 3.54. In [DF18b], we construct a Kuranishi structures on $\mathcal{M}(\mathcal{D} \subset X; \alpha; \mathbf{m})$. Each element of a Kuranishi structure has an isotropy group by definition and we may assume that the Kuranishi structure on $\mathcal{M}(\mathcal{D} \subset X; \alpha; \mathbf{m})$ is chosen such that the isotropy group of $\mathfrak{x} \in \mathcal{M}^0(\mathcal{D}; \mathcal{T}) \subset \mathcal{M}(\mathcal{D} \subset X; \alpha; \mathbf{m})$ is $\Gamma_{\mathfrak{x}}$.

We finally explain an alternative way to specify the level function. This alternative approach shall be useful in [DF18b, DF18c]. See [Teh22, Lemma 4.3] for a related notion.

Definition 3.55. A binary relation \leq on a set A defines a *quasi partial order* if the following properties hold:

- (1) $a \leq b$ and $b \leq c$ imply $a \leq c$.
- (2) $a \leq a$.

A *quasi order* on A is a quasi partial order such that for any two elements $a, b \in A$, at least one of the relations $a \leq b$ or $b \leq a$ holds. For a quasi partial order, we write $a < b$ if $a \leq b$ but not $b \leq a$.

Let \leq, \leq' be two quasi partial orders on A . We say that \leq' is *finer* than \leq if the following holds.

- (*) If $a < b$ then $a <' b$.

The similar notion is defined for quasi orders in an obvious way.

Let $\mathcal{T}_0 = (T, \alpha, m)$ be an object, which has the properties of Definition 3.27 except (6) and (9). In particular, \mathcal{T}_0 is equipped with the decomposition of the set of vertices as in part (1) of Definition 3.27, the choice of the root and the enumeration of outside vertices as in part (3) of Definition 3.27.

We then obtain a quasi partial order \leq_0 on $C_0^{\text{ins}}(T)$ as follows:

- (1) Suppose $v_1 \neq v_2$. We write $v_1 \leq_0 v_2$ if and only if there exists an edge of e such that $\partial e = \{v_1, v_2\}$ and one of the following holds.
 - (a) $s(e) = v_1$ and $m(e) > 0$.
 - (b) $s(e) = v_2$ and $m(e) < 0$.
- (2) Suppose $v \neq v'$. We write $v \leq_0 v'$ if and only if there exists v_1, \dots, v_n such that $v_1 = v, v_n = v'$ and $v_i \leq_0 v_{i+1}$.
- (3) We also require $v \leq_0 v$.

It is easy to see that \leq_0 defines a quasi partial order on $C_0(T)$.

Lemma 3.56. *Let \mathcal{T}_0 be as above. There is a one to one correspondence between the following two objects:*

- (1) The map $\lambda : C_0^{\text{ins}}(T) \rightarrow \mathbb{Z}_+$ satisfying parts (6) and (9) of Definition 3.27.
- (2) A quasi order on $C_0^{\text{ins}}(T)$ which is finer than \leq_0 .

In particular, \mathcal{T}_0 together with a quasi-order \leq finer than \leq_0 determines a decorated rooted tree.

Proof. Suppose λ is given. We define \leq by $v \leq v'$ if and only if $\lambda(v) \leq \lambda(v')$. Definition 3.27 (9) implies that \leq is finer than \leq_0 .

Suppose we are given a quasi order \leq on $C_0^{\text{ins}}(T)$ which is finer than \leq_0 . We define a relation \sim on $C_0^{\text{ins}}(T)$ by $v \sim v'$ if and only if $v \leq v'$, $v' \leq v$. It is easy to see that \sim is an equivalence relation. \leq induces an order on $C_0^{\text{ins}}(T)/\sim$. Then $C_0^{\text{ins}}(T)/\sim$, as an ordered set, is isomorphic to $(\{1, \dots, |\lambda|\}, \leq)$. We thus obtain $\lambda : C_0^{\text{ins}}(T) \rightarrow \{1, \dots, |\lambda|\}$. Definition 3.27 (9) follows from the assumption that \leq is finer than \leq_0 . \square

3.4. RGW Compactification: a Single Disk or Strip Component. Next, we describe a part of the construction of the RGW compactification of the moduli space of pseudo-holomorphic disks and strips in $X \setminus \mathcal{D}$ where there is only one disk (or strip) component involved. The story of strips is very similar to the case of disks. So we discuss the case of moduli space of pseudo-holomorphic disks in detail and then we explain how the case of strips should be modified.

Let $L \subset X \setminus \mathcal{D}$ be a compact Lagrangian submanifold and $\beta \in \Pi_2(X, L; \mathbb{Z})$, $\alpha \in \Pi_2(X; \mathbb{Z})$. Let $\mathbf{m} = (m_1, \dots, m_\ell)$ be an ℓ -tuple of positive integers and $k \geq 0$.

Definition 3.57. We denote by $\mathcal{M}_{k+1}^{\text{reg,d}}(\beta; \mathbf{m})$ the set of all the isomorphism classes of $((\Sigma, \vec{z}, \vec{w}), u)$ with the following properties.

- (1) Σ is the union of a disk D^2 and trees of spheres rooted on $\text{Int}(D^2)$. (We require that any singularity of Σ is a nodal singularity.)
- (2) $\vec{z} = (z_0, \dots, z_k)$ and $z_i \in \partial\Sigma$. The points z_0, \dots, z_k are distinct and respect the counter clockwise cyclic order on $S^1 = \partial\Sigma$.
- (3) $\vec{w} = (w_1, \dots, w_\ell)$ and $w_i \in \text{Int}(\Sigma)$. The points w_1, \dots, w_ℓ are distinct and away from the nodes of Σ .
- (4) $u : \Sigma \rightarrow X$ is a pseudo-holomorphic map, $u(\partial\Sigma) \subset L$, and the homology class of u is β .
- (5) $u(w_i) \in \mathcal{D}$. Moreover, $u^{-1}(\mathcal{D}) = \{w_1, \dots, w_\ell\}$.
- (6) The order of tangency of u to \mathcal{D} at w_i is m_i .
- (7) $((\Sigma, \vec{z}, \vec{w}), u)$ is stable in the sense of stable maps. (See, for example, [FOOO09b, Subsection 2.1].)

We say $((\Sigma, \vec{z}, \vec{w}), u)$ is isomorphic to $((\Sigma', \vec{z}', \vec{w}'), u')$ if there exists a biholomorphic map $v : \Sigma \rightarrow \Sigma'$ such that $v(z_i) = z'_i$, $v(w_i) = w'_i$ and $u' \circ v = u$. We define evaluation maps

$$(3.58) \quad \text{ev}_i : \mathcal{M}_{k+1}^{\text{reg,d}}(\beta; \mathbf{m}) \rightarrow \mathcal{D}, \quad i = 1, \dots, \ell$$

at w 's as follows:

$$(3.59) \quad \text{ev}_i((\Sigma, \vec{z}, \vec{w}), u) = u(w_i).$$

Note that we include the case that $\ell = 0$. In this case, we require that $u(\Sigma) \cap \mathcal{D} = \emptyset$ and write $\mathcal{M}_{k+1}^{\text{reg,d}}(\beta; \emptyset)$ for the corresponding moduli space.

Definition 3.60. We denote by $\mathcal{M}^{\text{reg,s}}(\alpha; \mathbf{m})$ the set of the isomorphism classes of objects $((\Sigma, \vec{w}), u)$ with the following properties.

- (1) Σ is a connected nodal curve of genus 0.
- (2) $\vec{w} = (w_1, \dots, w_\ell)$, $w_i \in \Sigma$. The points w_1, \dots, w_ℓ are distinct and away from nodes.

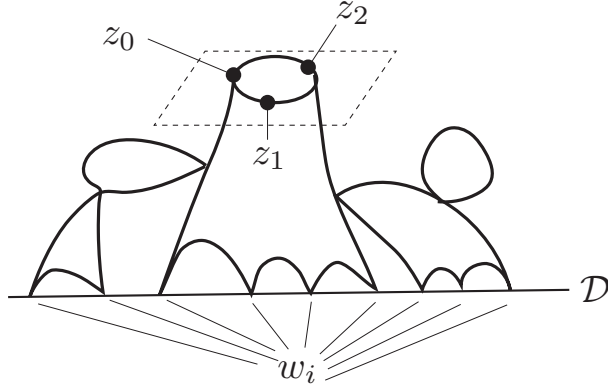
FIGURE 10. An element of $\mathcal{M}_{k+1}^{\text{reg,d}}(\beta; \mathbf{m})$.

- (3) $u : \Sigma \rightarrow X$ is a holomorphic map. The homology class of u is α .
- (4) $u(w_i) \in \mathcal{D}$. Moreover, $u^{-1}(\mathcal{D}) = \{w_1, \dots, w_\ell\}$.
- (5) The order of tangency of u to \mathcal{D} at w_i is m_i .
- (6) $((\Sigma, \vec{w}), u)$ is stable in the sense of stable maps.

The definition of isomorphisms of such objects is similar to Definition 3.57. We also define the following evaluation maps in the same way:

$$(3.61) \quad \text{ev}_i : \mathcal{M}^{\text{reg,s}}(\beta; \mathbf{m}) \rightarrow \mathcal{D}$$

To obtain our RGW compactification, we consider fiber products of the above defined moduli spaces $\mathcal{M}_{k+1}^{\text{reg,d}}(\beta; \mathbf{m})$, $\mathcal{M}^{\text{reg,s}}(\alpha; \mathbf{m})$, and the moduli spaces of the form $\mathcal{M}^0(\mathcal{D}; \mathcal{T})$, which we defined in the previous subsection. The combinatorial objects to describe these fiber products are given in the following definition:

Definition 3.62. Suppose L is a compact Lagrangian submanifold in the complement of the smooth divisor \mathcal{D} in X . A *disk-divisor describing tree*, or a *DD-tree* for short, is an object $\mathcal{S} = (S, c, m, \alpha, \mathcal{T}, \leq)$ with the following properties:

- (1) S is a tree. The set of the vertices and the edges of S are respectively denoted by $C_0(S)$ and $C_1(S)$.
- (2) $c : C_0(S) \rightarrow \{d, s, D\}$ assigns one of the symbols d, s or D to each vertex v . We call $c(v)$ the *color* of v .²
- (3) There exists exactly one vertex whose color is d. Here d stands for disk. We call this vertex the *root* of S . There is also a number k associated to the root³. (The root will correspond to a moduli space of the form $\mathcal{M}_{k+1}^{\text{reg,d}}(\beta; \mathbf{m})$.)
- (4) The root or a vertex with color s is joined⁴ only to vertices with color D. (Here s and D stand for sphere and divisor, respectively. A vertex with color s will correspond to a moduli space $\mathcal{M}^{\text{reg,s}}(\alpha; \mathbf{m})$. A vertex with color D will correspond to a moduli space $\mathcal{M}^0(\mathcal{D}; \mathcal{T}(v))$.)
- (5) There is no edge joining two vertices of color D.
- (6) $m : C_1(S) \rightarrow \mathbb{Z}_+$ assigns a positive number to each edge of S . We call it the *multiplicity function*: The number $m(e)$ is called the *multiplicity of the edge* e .
- (7) If $c(v)$ is equal to d, s, or D, then $\alpha(v)$ is respectively an element of $\Pi_2(X, L; \mathbb{Z})$, $\Pi_2(X; \mathbb{Z})$ or $\Pi_2(\mathcal{D}; \mathbb{Z})$. We call $\alpha(v)$ the *homology class* of v .

²We use roman letters v and e to denote the vertices and the edges of S . In the case of decorated rooted trees, we use italic letters v and e .

³ $k + 1$ is the number of boundary marked points.

⁴We say a vertex v is joined to a vertex v' if and only if there exists an edge which contains both v and v' .

- (8) For each vertex v with color D or s , there exists a unique edge $e_0(v)$ in $S \setminus \{v\}$ which lies in the same connected component of $S \setminus \{v\}$ as the root. This edge is called the *first edge* of v .
- (9) Let v be a vertex with color D with the first edge $e_0(v)$. Let the other edges incident to v be denoted by $e_1(v), \dots, e_{\ell(v)}(v)$. (Here $\ell(v) + 1$ is the valency of v .) Then \mathcal{T} assigns to v a decorated rooted tree $\mathcal{T}(v)$ such that
- (a) The homology class of $\mathcal{T}(v)$ is $\alpha(v)$.
 - (b) Its input multiplicity is $m(e_0(v))$.
 - (c) Its output multiplicities are $m(e_i(v))$, $i = 1, \dots, \ell(v)$.
- (10) \leq is a quasi order on

$$(3.63) \quad C_0^{\text{ins}}(\mathcal{S}) = \bigcup_{v \in C_0(\mathcal{S})} C_0^{\text{ins}}(\mathcal{T}(v)),$$

We require that the restriction of \leq to $C_0^{\text{ins}}(\mathcal{T}(v))$ coincides with \leq_v , which is induced by the level function of $\mathcal{T}(v)$ using Lemma 3.56. We call any element of $C_0^{\text{ins}}(\mathcal{S})$ an *inside edge* of \mathcal{S} .

If we want to specify the Lagrangian submanifold L , then we say \mathcal{S} is a DD-tree for L .

Definition 3.64. The homology class of a DD-tree $\mathcal{S} = (S, c, m, \alpha, \mathcal{T}, \leq)$ is defined as:

$$(3.65) \quad \beta(\mathcal{S}) = \sum_{v \in C_0(\mathcal{S})} \alpha(v) \in \Pi_2(X, L; \mathbb{Z}).$$

In the above expression, if v has color s or D we use the homomorphisms $\Pi_2(X; \mathbb{Z}) \rightarrow \Pi_2(X, L; \mathbb{Z})$ and $\Pi_2(\mathcal{D}; \mathbb{Z}) \rightarrow \Pi_2(X, L; \mathbb{Z})$ to define the right hand side. We say \mathcal{S} is a DD-tree of type $(\beta(\mathcal{S}), k)$.

Example 3.66. In Figure 11 a DD tree S is sketched. The symbols d, s, D denote the vertices of colors d, s, D . The number written near each edge is the multiplicity of that edge.

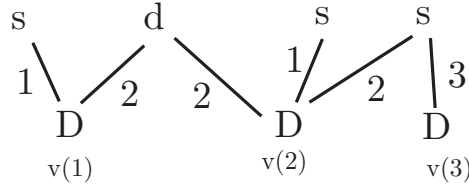

FIGURE 11. An example of graph S

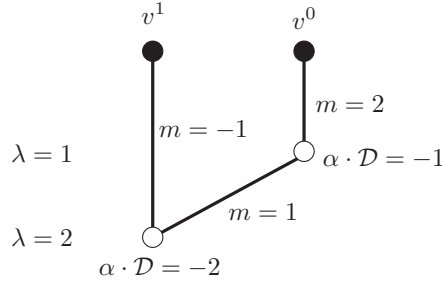
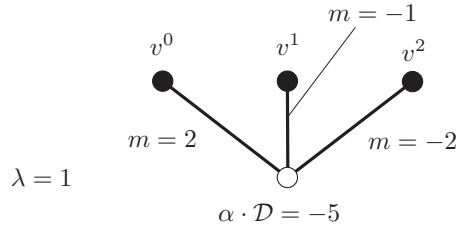
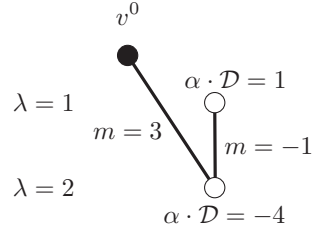
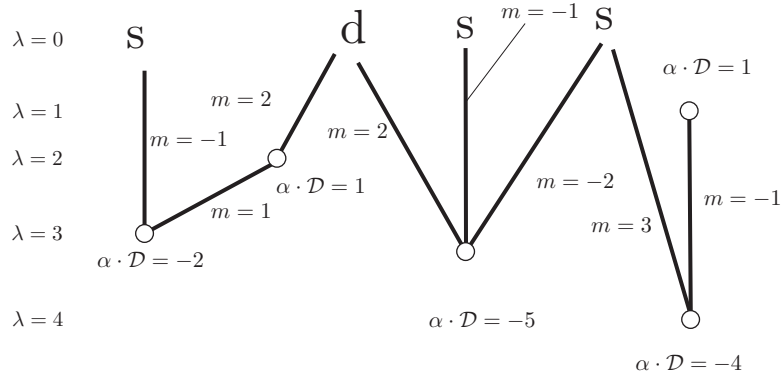
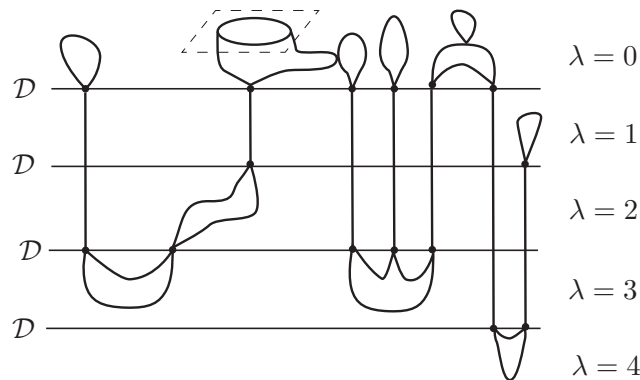

FIGURE 12. $\mathcal{T}(v(1))$

FIGURE 13. $\mathcal{T}(v(2))$ FIGURE 14. $\mathcal{T}(v(3))$

We associate the decorated rooted trees $\mathcal{T}(v(1))$, $\mathcal{T}(v(2))$, $\mathcal{T}(v(3))$ given in Figures 12, 13, 14 to the vertices $v(1)$, $v(2)$, $v(3)$, respectively. We put these trees on the position of the corresponding vertices of S and then identify the outside edges of $\mathcal{T}(v(i))$ with the corresponding edges of S . We thus obtain the tree \hat{S} in Figure 15. We call \hat{S} the

FIGURE 15. Detailed tree \hat{S} FIGURE 16. object corresponding to \hat{S} in Figure 15.

detailed tree associated to \mathcal{S} . The level function λ in Figure 15 is defined using the quasi order on $C_0^{\text{ins}}(\mathcal{S})$. Figure 15 describes a configuration of pseudo-holomorphic curves as in Figure 16. (See (3.75).) We summarize the properties of the detailed tree associated to \mathcal{S} in the following lemma.

Lemma 3.67. *We can associate $(\hat{S}, c, \alpha, m, \lambda)$ to \mathcal{S} which satisfies the following properties in addition to (1)-(4) and (7), (8) in Definition 3.62.*

- (i) $m : C_1(\hat{S}) \rightarrow \mathbb{Z} \setminus \{0\}$ assigns a nonzero integer to each edges of S . We call it the multiplicity function. The number $m(e)$ is called the multiplicity of the edge e .
- (ii) The balancing condition (3.28) is satisfied at the vertices with color D .
- (iii) The stability condition in part (8) of Definition 3.27 is satisfied at vertices with color D .
- (iv) We require

$$\alpha(v) \cdot \mathcal{D} = \sum_{v \in e} m(e)$$

for vertices with color d . We also require

$$\alpha(v) \cdot \mathcal{D} = -m(e_0(v)) + \sum_{v \in e} m(e)$$

for vertices with color s . Here $e_0(v)$ is the edge containing v such that $e_0(v)$ is contained in the same connected component of $S \setminus \{v\}$ as the root.

- (v) $\lambda : C_0(\hat{S}) \rightarrow \mathbb{Z}_{\geq 0}$ is a map such that:
 - (a) If v has color d or s then $\lambda(v) = 0$.
 - (b) If v has color D then $\lambda(v) > 0$.
 - (c) Part (9) of Definition 3.27 holds.
 - (d) The image of λ is $\{0, \dots, |\lambda|\}$ for some $|\lambda| > 0$.

Proof. Suppose \hat{S} is the detailed tree associated to the DD tree \mathcal{S} . A level function can be defined on the set of the inside vertices of \hat{S} by the quasi order \leq as in Lemma 3.56. For vertices with color s or d , we define its level to be 0. The rest of the proof is straightforward. \square

Remark 3.68. Let e be an edge which joins a level 0 vertex v and a vertex v' of positive level. Part (v) of Lemma 3.67 implies that $m(e) > 0$, if $c(v) = d$. On the other hand, if $c(v) = s$, then $m(e) > 0$ if and only if $e \neq e_0(v)$.

Remark 3.69. The restriction of λ to $C_0^{\text{ins}}(\mathcal{T}(v))$ may not coincide with the level function λ_v of $\mathcal{T}(v)$ as it can be seen in Example 3.66.

Definition 3.70. We call $(\hat{S}, c, \alpha, m, \lambda)$ the *detailed DD-tree* associated to the DD-tree \mathcal{S} .

Let \mathcal{S} be a DD-tree and $(\hat{S}, c, \alpha, m, \lambda)$ be its associated detailed DD-tree. For each vertex v of \hat{S} , we associate a moduli space $\widetilde{\mathcal{M}}^0(\mathcal{S}; v)$ as follows. Let $c(v) = d$ and $e_1^v, \dots, e_{\ell(v)}^v$ be the edges incident to v . We then define:

$$(3.71) \quad \widetilde{\mathcal{M}}^0(\mathcal{S}; v) = \mathcal{M}_{k+1}^{\text{reg}, d}(\alpha(v); \mathbf{m}^v),$$

where $\mathbf{m}^v = (m(e_1^v), \dots, m(e_{\ell(v)}^v))$ and k is the non-negative integer associated to the root.

Let $c(v) = s$, e_0^v be the first edge of v , and e_1^v, \dots, e_{ℓ}^v be the other edges of v . We define:

$$(3.72) \quad \widetilde{\mathcal{M}}^0(\mathcal{S}; v) = \mathcal{M}^{\text{reg}, s}(\alpha(v); \mathbf{m}^v),$$

where $\mathbf{m}^v = (-m(e_0^v), m(e_1^v), \dots, m(e_{\ell(v)}^v))$. Finally, suppose $c(v) = D$ with the first edge e_0^v , and the remaining edges $e_1^v, \dots, e_{\ell(v)}^v$. We define:

$$(3.73) \quad \widetilde{\mathcal{M}}^0(\mathcal{S}; v) = \widetilde{\mathcal{M}}^0(\mathcal{D} \subset X; \alpha(v); \mathbf{m}^v),$$

where $\mathbf{m}^v = (-m(e_0^v), m(e_1^v), \dots, m(e_{\ell(v)}^v))$. This is similar to (3.34).

We can also define a map:

$$\text{EV} : \prod_{v \in C_0(\hat{S})} \widetilde{\mathcal{M}}^0(\mathcal{S}; v) \rightarrow \prod_{e \in C_1(\hat{S})} (\mathcal{D} \times \mathcal{D})$$

similar to the map (3.35) as follows: Let $e \in C_1(\hat{S})$. Let $\vec{\mathbf{x}} = (\mathbf{x}_v; v \in C_0(\hat{S}))$ be an element of the domain of EV. Then $\text{EV}(\vec{\mathbf{x}})_e$, the component of $\text{EV}(\vec{\mathbf{x}})$ corresponding to the edge e , is defined as follows:

$$(3.74) \quad \text{EV}(\vec{\mathbf{x}})_e = (\text{ev}_0(\mathbf{x}_{t(e)}), \text{ev}_i(\mathbf{x}_{s(e)})) \in \mathcal{D} \times \mathcal{D}.$$

Here ev_0 and ev_i are given in Definition 3.18, (3.58) or (3.61), and i is chosen such that e is the i -th edge of $s(e)$. Note that $t(e)$ has color either s or D . Therefore, the first edge of $t(e)$ is defined and is e .

We define $\widetilde{\mathcal{M}}^0(\mathcal{S})$ to be the following fiber product:

$$(3.75) \quad \widetilde{\mathcal{M}}^0(\mathcal{S}) = \prod_{v \in C_0(\hat{S})} \widetilde{\mathcal{M}}^0(\mathcal{S}; v)_{\text{EV}} \times_{\star} \prod_{e \in C_1(\hat{S})} \Delta$$

where \star denotes the diagonal inclusion of $\prod_{e \in C_1(\hat{S})} \Delta$ into $\prod_{e \in C_1(\hat{S})} \mathcal{D} \times \mathcal{D}$ with Δ being the diagonal in $\mathcal{D} \times \mathcal{D}$. We also define a $\mathbb{C}_*^{|\lambda|}$ action on $\widetilde{\mathcal{M}}^0(\mathcal{S})$ by

$$(3.76) \quad \vec{\rho} \cdot \vec{\mathbf{x}} = (\rho_{\lambda(v)} \mathbf{x}_v),$$

where $\vec{\rho} = (\rho_1, \dots, \rho_{|\lambda|}) \in \mathbb{C}_*^{|\lambda|}$ and $\vec{\mathbf{x}} = (\mathbf{x}_v) \in \prod_{v \in C_0^{\text{int}}(\hat{S})} \widetilde{\mathcal{M}}(\mathcal{S}; v)$. In (3.76), if $\lambda(v) = 0$, then $\rho_{\lambda(v)} \mathbf{x}_v$ is defined to be \mathbf{x}_v .

Next, we define:

$$(3.77) \quad \widehat{\mathcal{M}}^0(\mathcal{S}) = \widetilde{\mathcal{M}}^0(\mathcal{S}) / \mathbb{C}_*^{|\lambda|}.$$

Let $\text{Aut}(\mathcal{S})$ be the group of automorphisms of the tree \hat{S} which preserves c, α, m, λ . The group $\text{Aut}(\mathcal{S})$ acts on $\widehat{\mathcal{M}}^0(\mathcal{S})$. We finally define

$$(3.78) \quad \mathcal{M}^0(\mathcal{S}) = \widehat{\mathcal{M}}^0(\mathcal{S}) / \text{Aut}(\mathcal{S}).$$

Definition 3.79. For $k \in \mathbb{Z}_{\geq 0}$ and $\beta \in \Pi_2(X; L; \mathbb{Z})$ define $\mathcal{M}_{k+1}^{0, \text{RGW}}(L; \beta)$ to be the disjoint union of all the spaces $\mathcal{M}^0(\mathcal{S})$, where \mathcal{S} is a DD-tree with homology class β such that k is the nonnegative integer associated to the root.

We next consider the case of holomorphic strips. Let $L_0, L_1 \subset X \setminus \mathcal{D}$ be a pair of compact Lagrangian submanifolds. We assume L_0 is transversal to L_1 . Let $p, q \in L_0 \cap L_1$ and $\beta \in \Pi_2(X; L_1, L_0; p, q)$ (See Definition 2.2.) and k_0, k_1 be nonnegative integers.

Definition 3.80. We denote by $\mathcal{M}_{k_1, k_0}^{\text{reg}}(L_1, L_0; p, q; \beta; \mathbf{m})$ the set of all isomorphism classes of $((\Sigma, \vec{z}_0, \vec{z}_1, \vec{w}), u)$ with the following properties.

- (1) Σ is a strip $\mathbb{R} \times [0, 1]$ together with trees of spheres rooted in $\mathbb{R} \times (0, 1)$. (We require that the singularities of Σ to be nodal singularities.)
- (2) $\vec{z}_i = (z_{i,1}, \dots, z_{i,k_i})$ and $z_{i,j} \in \mathbb{R} \times \{i\}$, for $i = 0, 1$. The points $z_{i,1}, \dots, z_{i,k_i}$ are distinct, $z_{1,1} > \dots > z_{1,k_1}$ and $z_{0,1} < \dots < z_{0,k_0}$.
- (3) $\vec{w} = (w_1, \dots, w_\ell)$, $w_i \in \text{Int}(\Sigma)$. w_1, \dots, w_ℓ are distinct points in the interior of Σ and are away from the nodal singularities.

(4) $u : \Sigma \rightarrow X$ is a holomorphic map, $u(\mathbb{R} \times \{i\}) \subset L_i$,

$$(3.81) \quad \lim_{\tau \rightarrow -\infty} u(\tau, t) = p, \quad \lim_{\tau \rightarrow +\infty} u(\tau, t) = q,$$

and the homology class of u is β .

- (5) $u^{-1}(\mathcal{D}) = \{w_1, \dots, w_\ell\}$.
(6) The order of tangency of u to \mathcal{D} at w_i is m_i .
(7) $((\Sigma, \vec{z}_0, \vec{z}_1, \vec{w}), u)$ is stable in the sense of stable maps.

The definition of an isomorphism between two objects as above is similar to Definition 3.57.

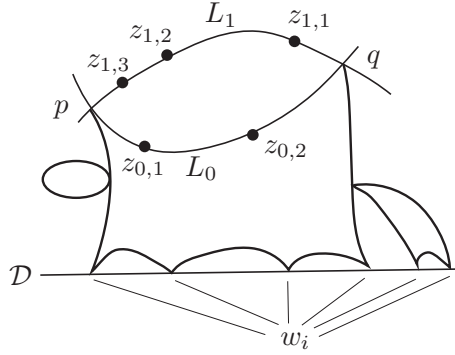

FIGURE 17. An element of $\mathcal{M}_{k_1, k_0}^{\text{reg}}(L_1, L_0; p, q; \beta; \mathbf{m})$.

Definition 3.82. We define evaluation maps:

$$\text{ev}_i : \mathcal{M}_{k_1, k_0}^{\text{reg}}(L_1, L_0; p, q; \beta; \mathbf{m}) \rightarrow \mathcal{D} \quad i = 1, \dots, \ell$$

by:

$$(3.83) \quad \text{ev}_i((\Sigma, \vec{z}_0, \vec{z}_1, \vec{w}), u) = u(w_i).$$

Definition 3.84. A *strip-divisor describing tree*, or an *SD-tree* for short, is an object $\mathcal{S} = (S, c, m, \alpha, \mathcal{T}, \leq)$ which satisfies the same properties as in Definition 3.62 except that we replace (2), (3) and (7) by :

- (2)' $c : C_0(S) \rightarrow \{\text{str}, \text{s}, \text{D}\}$ assigns one of the symbols str, s or D to each vertex v . We call it the *color* of v and denote it by $c(v)$.
(3)' There exists exactly one vertex whose color is str. The label “str” stands for strip. We call the unique vertex with color str the *root* of S . There are also integers k_0 and k_1 associated to the vertex v_0 . (The root will correspond to a moduli space of the form $\mathcal{M}_{k_1, k_0}^{\text{reg}}(L_1, L_0; p, q; \beta; \mathbf{m})$.)
(7)' If $c(v)$ is equal to str, s, or D, then $\alpha(v)$ respectively belongs to $\Pi_2(X; L_1, L_0; \mathbb{Z})$, $\Pi_2(X; \mathbb{Z})$ or $\Pi_2(\mathcal{D}; \mathbb{Z})$. We call $\alpha(v)$ the *homology class* of v .

Analogous to DD-trees, we can associate a detailed SD-tree to an SD-tree.

The definition of the moduli space in (3.75) can be modified to define $\widetilde{\mathcal{M}}^0(\mathcal{S})$ for an SD-tree. If $c(v) = \text{str}$ the moduli space $\widetilde{\mathcal{M}}^0(\mathcal{S}; v)$ is defined to be

$$(3.85) \quad \widetilde{\mathcal{M}}^0(\mathcal{S}; v) = \mathcal{M}_{k_1, k_0}^{\text{reg}}(L_1, L_0; p, q; \beta; \mathbf{m}^v)$$

where $\mathbf{m}^v = (m(e_1^v), m(e_2^v), \dots, m(e_{\ell(v)}^v))$ with $e_1^v, \dots, e_{\ell(v)}^v$ being the edges incident to the root v . If $c(v) = \text{s}$ or D , then $\widetilde{\mathcal{M}}^0(\mathcal{S}; v)$ is defined as in (3.72), (3.73). We define $\widetilde{\mathcal{M}}^0(\mathcal{S})$, $\widehat{\mathcal{M}}^0(\mathcal{S})$ and $\mathcal{M}^0(\mathcal{S})$ by (3.75), (3.77) and (3.78), respectively. Finally we define:

Definition 3.86. For $k_0, k_1 \in \mathbb{Z}_{\geq 0}$, $p, q \in L_0 \cap L_1$ and $\beta \in \Pi_2(X; L_1, L_0; \mathbb{Z})$, the set $\mathcal{M}_{k_1, k_0}^{0, \text{RGW}}(L_1, L_0; p, q; \beta)$ is the disjoint union of all $\mathcal{M}^0(\mathcal{S})$, where \mathcal{S} is an SD-tree of type $(\beta; k_0, k_1)$.

In the next subsection, we define *compactifications* of the sets $\mathcal{M}_{k+1}^{0, \text{RGW}}(L; \beta)$ and $\mathcal{M}_{k_1, k_0}^{0, \text{RGW}}(L_1, L_0; p, q; \beta)$. The definition of these compactifications uses the notion of level shrinking for DD-trees and SD-trees. We discuss this notion for DD-trees. The case of SD-trees is completely similar.

Definition 3.87. Let $(\hat{S}, c, \alpha, m, \lambda)$ be the detailed DD-tree associated to a DD-tree \mathcal{S} . Let $i \in \{0, \dots, |\lambda|\}$. If $i > 0$, then $(i, i+1)$ -level shrinking of \mathcal{S} is defined as in Definition 3.48. We define $(0, 1)$ -level shrinking of \mathcal{S} below.

Let $v \in C_0(\hat{S})$ with $\lambda(v) = 1$. Then $c(v)$ is equal to D. There are two cases.

Case 1: There is no vertex \hat{v} with $\lambda(\hat{v}) = 0$, which is joined to v . In this case, after $(0, 1)$ level shrinking, v will have the color s and its level is equal to 0.

Case 2: There exists a vertex \hat{v} with $\lambda(\hat{v}) = 0$ which is joined to v . Let $C \subset \hat{S}$ be the maximal connected subgraph of \hat{S} which contains v and whose vertices have level 0 or 1. We shrink C to a new vertex v' . The color of v' is d if the root of \hat{S} is in C . Otherwise, the color of v' is s. All the edges e , which are joined to a vertex of C , but are not in C , will be joined to v' . We also define:

$$\alpha(v') = \sum_{\hat{v} \in C} \alpha(\hat{v}), \quad \lambda(v') = 0.$$

We perform this operation to all the vertices of level 1. We change the level of all the vertices v with $\lambda(v) > 1$ to $\lambda(v) - 1$. The resulting tree together with c, α, m and λ is the detailed DD-tree associated to a DD-tree. We say this DD-tree is obtained from \mathcal{S} by $(0, 1)$ level shrinking.

Example 3.88. In Figure 18, we sketch the detailed tree for a DD-tree \mathcal{S} together with its level function. Figure 19 gives the detailed tree obtained from \mathcal{S} by $(0, 1)$ level shrinking.

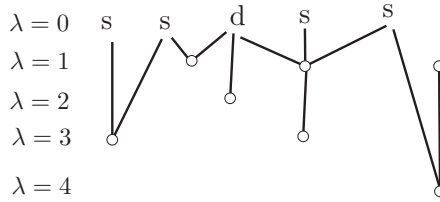

FIGURE 18. Before $(0,1)$ level shrinking.

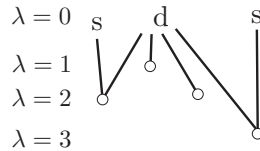

FIGURE 19. After $(0,1)$ level shrinking.

Definition 3.89. We write $\mathcal{S} > \mathcal{S}'$ if \mathcal{S} is obtained from \mathcal{S}' by a finite number of $(i, i+1)$ level shrinkings, possibly for different choices of i . We also write $\mathcal{S} \geq \mathcal{S}'$ if $\mathcal{S} > \mathcal{S}'$ or $\mathcal{S} = \mathcal{S}'$.

We define

$$(3.90) \quad \mathcal{M}(\mathcal{S}) = \bigcup_{\mathcal{S}' \leq \mathcal{S}} \mathcal{M}^0(\mathcal{S}').$$

We will define a topology on $\mathcal{M}(\mathcal{S})$ in Section 4. As an immediate consequence of the definition we have the following: If an element of $\mathcal{M}^0(\mathcal{S}')$ is obtained as a limit of a sequence of elements of $\mathcal{M}^0(\mathcal{S})$, then $\mathcal{S} \geq \mathcal{S}'$.

3.5. RGW Compactification in the General Case. We now describe the compactifications $\mathcal{M}_{k_1, k_0}^{\text{RGW}}(L_1, L_0; p, q; \beta)$, $\mathcal{M}_{k+1}^{\text{RGW}}(L; \beta)$. These compactifications are obtained by taking the union of fiber products of various spaces of the forms $\mathcal{M}_{k_1, k_0}^{0, \text{RGW}}(L_1, L_0; p, q; \beta)$, $\mathcal{M}_{k+1}^{0, \text{RGW}}(L; \beta)$. Those fiber products are defined using evaluation maps at the boundary marked points. In the following definition we describe combinatorial objects which keep track of these fiber products:

Definition 3.91. A *Disk-Divisor describing rooted ribbon tree*, or a *DD-ribbon tree* for short, is $\mathcal{R} = (R; \mathbf{v}^0; \mathcal{S}, \alpha, \leq)$ with the following properties:

- (1) R is a ribbon tree.
- (2) The set of vertices $C_0(R)$ is divided into disjoint union of two subsets $C_0^{\text{int}}(R)$ and $C_0^{\text{ext}}(R)$, the set of all *interior* and *exterior* vertices. The valency of any exterior vertex is one.
- (3) We fix one exterior vertex \mathbf{v}^0 , which we call the *root vertex*. We require that the number of exterior vertices to be equal to $k+1$. We enumerate them as $\mathbf{v}^0, \dots, \mathbf{v}^k$ so that it respects the counter clockwise orientation, induced by the ribbon structure.
- (4) α is a map from $C_0^{\text{int}}(R)$ to $\Pi_2(X, L; \mathbb{Z})$.
- (5) To each interior vertex \mathbf{v} , we associate $\mathcal{S}(\mathbf{v})$, which is a DD-tree of type $(\alpha(\mathbf{v}), k_{\mathbf{v}})$. Here $k_{\mathbf{v}} + 1$ is the valency of the vertex \mathbf{v} .
- (6) Let $\hat{\mathcal{S}}(\mathbf{v})$ denote the detailed DD-tree associated to $\mathcal{S}(\mathbf{v})$. We define:

$$(3.92) \quad C_0^{\text{ins}}(\hat{R}) = \bigcup_{\mathbf{v} \in C_0^{\text{int}}(R)} C_0^{\text{ins}}(\hat{\mathcal{S}}(\mathbf{v})).$$

We call $C_0^{\text{ins}}(\hat{R})$ the set of inside vertices of the detailed tree associated to \mathcal{R} . The relation \leq is a quasi order on $C_0^{\text{ins}}(\hat{R})$. We require that the restriction of \leq to $C_0^{\text{ins}}(\hat{\mathcal{S}}(\mathbf{v}))$ coincides with the partial order determined by the structure of $\mathcal{S}(\mathbf{v})$.

The homology class $\alpha(\mathcal{R})$ of \mathcal{R} is the sum of the homology classes $\alpha(\mathbf{v})$ for all the interior vertices. We also call $(\alpha(\mathcal{R}); k)$ the *type* of \mathcal{R} .

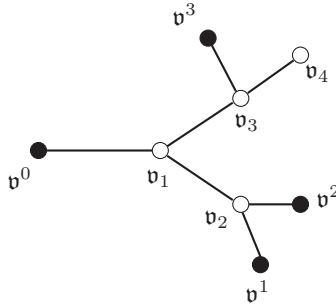

FIGURE 20. A Disk-Divisor Describing Rooted Ribbon Tree.

Example 3.93. A DD-ribbon tree R is given in Figure 20. Here black circles are exterior vertices and white circles are interior vertices. The ribbon tree in Figure 20 corresponds to the configuration of the disks drawn in Figure 21. The tree R has four interior vertices v_1, v_2, v_3, v_4 . The corresponding DD-trees are given in Figure 22.

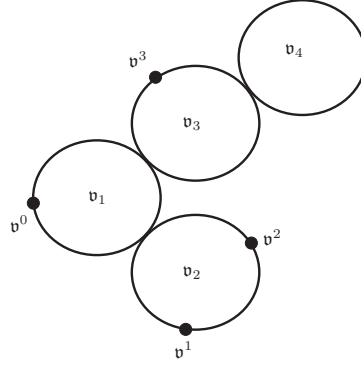

FIGURE 21. Configuration of disks corresponding to Figure 20.

To each \mathcal{R} as in Definition 3.91, we can associate a detailed tree \hat{R} by forming the following disjoint union and identifying each interior vertex v of R with the root of $\hat{S}(v)$:

$$R \sqcup \bigcup_{v \in C_0^{\text{int}}(R)} \hat{S}(v).$$

The detailed tree associated to Example 3.93 is given in Figure 22. In this figure we omit the exterior vertices of R and the edges incident to them. Nevertheless, they are part of the detailed tree. The edges of level 0 are also drawn by dotted lines.⁵ The level function on $\hat{S}(v_i)$ induced by \leq is given in Figure 22.

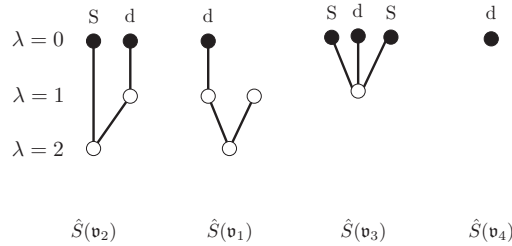

FIGURE 22. $\hat{S}(v_i)$.

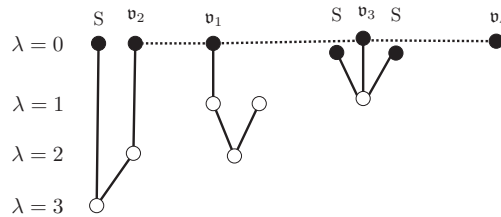

FIGURE 23. The detailed tree \hat{R} associated to Figures 20 and 22.

The detailed tree for DD-ribbon trees and DD-trees have the following differences:

⁵It is probably more natural to draw 3-dimensional figures. However, we content ourselves to a 2 dimension figure for simplicity.

- (1) For detailed trees of DD-ribbon trees, the vertices of level 0 have one of the colors d, s or ext. d stands for disks, and there is one vertex with this color for each interior vertex of R . s stands for spheres, which appear in $\hat{S}(\mathbf{v})$ for interior vertices \mathbf{v} . There is a vertex with color ext for each exterior vertex of R .
- (2) We fix a root among the vertices with color ext.
- (3) There may be level 0 edges that join level 0 vertices of color d.

Definition 3.94. Let L_0, L_1 be compact Lagrangian submanifolds of $X \setminus \mathcal{D}$ which intersect transversally, and $p, q \in L_0 \cap L_1$. A *Strip-Divisor describing rooted ribbon tree*, or an *SD-ribbon tree* for short, is a 7-tuple $\mathcal{R} = (R; \mathbf{v}_l, \mathbf{v}_r; \mathcal{S}, \text{pt}, \alpha, \leq)$ with the following properties (see Figure 24.):

- (1) R is a ribbon tree.
- (2) The set of vertices $C_0(R)$ is divided into disjoint union of two subsets $C_0^{\text{int}}(R)$ and $C_0^{\text{ext}}(R)$, the set of all *interior* and *exterior* vertices. The valency of exterior vertices are one.
- (3) $\mathbf{v}_l, \mathbf{v}_r$ are exterior vertices of R , which we call *the left most vertex and the right most vertex*. There is a subgraph C , which is a path that starts from \mathbf{v}_l and ends at \mathbf{v}_r . We call a vertex and an edge of C a *strip vertex* and a *strip edge*. We do not regard \mathbf{v}_l or \mathbf{v}_r as a strip vertex. In particular, all the strip vertices are interior. We require C contains at least one strip vertex.
- (4) The complement $R \setminus C$ is split into R_0 and R_1 , as follows. We orient C so that it starts from \mathbf{v}_l and ends with \mathbf{v}_r . Then R_0 lies to the right and R_1 lies to the left of C . (We use the embedding of R in \mathbb{R}^2 associated to its ribbon structure here.) The vertices or edges in R_0 (resp. R_1) are called d_0 -type (resp. d_1 -type) vertices or edges. The graph R_0 (resp. R_1) has exactly k_0 (resp. k_1) exterior edges.
- (5) pt assigns to each strip edge \mathbf{e} an element of $L_0 \cap L_1$. If \mathbf{e} contains \mathbf{v}_l then $\text{pt}(\mathbf{e}) = p$ if \mathbf{e} contains \mathbf{v}_r then $\text{pt}(\mathbf{e}) = q$.
- (6) If \mathbf{v} is a strip vertex then $\alpha(\mathbf{v}) \in \Pi_2(L_1, L_0; \text{pt}(\mathbf{e}_l(\mathbf{v})), \text{pt}(\mathbf{e}_r(\mathbf{v})))$. Here $\mathbf{e}_l(\mathbf{v})$ (resp. $\mathbf{e}_r(\mathbf{v})$) is the edge of C containing \mathbf{v} which lies in the same connected component of $C \setminus \{\mathbf{v}\}$ as \mathbf{v}_l (resp. \mathbf{v}_r).
- (7) If \mathbf{v} is an interior d_0 vertex (resp. an interior d_1 vertex) then $\alpha(\mathbf{v}) \in \Pi_2(X, L_0; \mathbb{Z})$ (resp. $\alpha(\mathbf{v}) \in \Pi_2(X, L_1; \mathbb{Z})$).
- (8) If \mathbf{v} is a strip vertex, then $\mathcal{S}(\mathbf{v})$ is an SD-tree of type $(\alpha(\mathbf{v}); k_0, k_1)$ where k_i is the number of edges in R_i incident to \mathbf{v} . If \mathbf{v} is a d_0 vertex then $\mathcal{S}(\mathbf{v})$ is a DD-tree for the Lagrangian L_0 of type $(\alpha(\mathbf{v}); k)$ where $k + 1$ is the number of edges incident to \mathbf{v} . If \mathbf{v} is a d_1 vertex then $\mathcal{S}(\mathbf{v})$ is a DD-tree for the Lagrangian L_1 of type $(\alpha(\mathbf{v}); k)$ where $k + 1$ is the number of edges incident to \mathbf{v} .
- (9) \leq is a quasi partial order on

$$(3.95) \quad C_0^{\text{ins}}(\hat{R}) = \bigcup_{\mathbf{v} \in C_0^{\text{int}}(R)} C_0^{\text{ins}}(\hat{S}(\mathbf{v})).$$

The set $C_0^{\text{ins}}(\hat{R})$ is called the set of inside vertices of the detailed tree associated to R . \leq is a quasi partial order on $C_0^{\text{ins}}(\hat{R})$. The restriction of \leq to $C_0^{\text{ins}}(\hat{S}(\mathbf{v}))$ coincides with the quasi order coming from the structure of $\mathcal{S}(\mathbf{v})$.

The homology class $\alpha(\mathcal{R})$ of \mathcal{R} is the sum of the homology classes $\alpha(\mathbf{v})$ for all interior vertices \mathbf{v} . We say the *type* of \mathcal{R} is $(p, q; \alpha(\mathcal{R}); k_0, k_1)$.

We can define the notion of the detailed tree \hat{R} associated to \mathcal{R} in the same way as in the case of DD-ribbon trees. We omit the details here. The main differences are:

- (1) The vertices of level 0 have one of the colors $d_0, d_1, \text{str}, \text{le}, \text{ri}, \text{s}, \text{mk}_0, \text{mk}_1$.

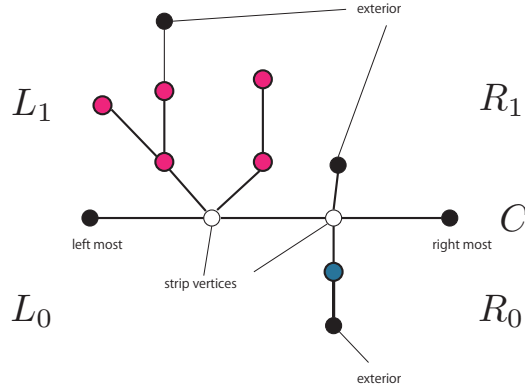

FIGURE 24. Strip-Divisor describing ribbon tree.

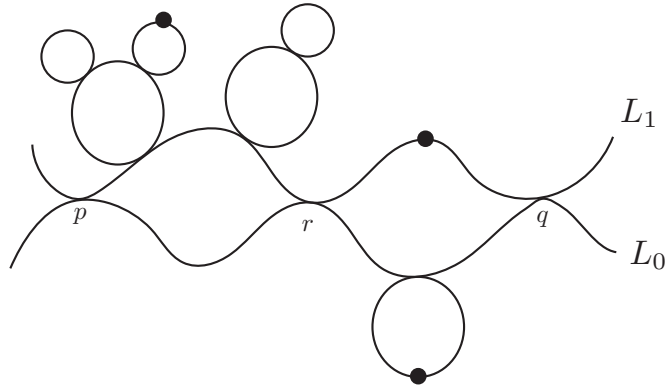

FIGURE 25. Configuration corresponding to Figure 24.

- (2) d_0 (resp. d_1) stands for disks with boundary condition L_0 (resp. L_1). The vertices with color d_0 (resp. d_1) correspond to the interior vertices of R_0 (resp. R_1).
- (3) mk_0 (resp. mk_1) labels the exterior vertices of R_0 (resp. R_1) and corresponds to the k_0 (resp. k_1) boundary marked points in L_0 (resp. L_1). The vertices with color str correspond to the interior vertices \mathbf{v} of C .
- (4) le , ri correspond to the left most and the right most vertices of C .

Now we are ready to describe the moduli spaces associated to the DD- or SD- ribbon trees. We first define evaluation maps at boundary marked points:

$$\text{ev}_j^{\partial} : \mathcal{M}_{k+1}^{\text{reg},d}(\beta; \mathbf{m}) \rightarrow L$$

for $j = 0, \dots, k$ by

$$(3.96) \quad \text{ev}_j^{\partial}((\Sigma, \vec{z}, \vec{w}), u) = u(z_j)$$

and

$$\text{ev}_{i,j}^{\partial} : \mathcal{M}_{k_1, k_0}^{\text{reg}}(L_1, L_0; p, q; \beta; \mathbf{m}) \rightarrow L_i$$

for $i = 0, 1$ and $j = 1, \dots, k_i$ by:

$$(3.97) \quad \text{ev}_{i,j}^{\partial}((\Sigma, \vec{z}_0, \vec{z}_1, \vec{w}), u) = u(z_{i,j}).$$

Definition 3.98. Let $\mathcal{R} = (R; \mathbf{v}_0; \mathcal{S}, \alpha, \leq)$ be a DD-ribbon tree, \hat{R} the associated detailed tree and λ the level function of \hat{R} . For an interior vertex \mathbf{v} of R , let $v \in C_0^{\text{int}}(\mathcal{S}(\mathbf{v}))$. We

then define:

$$(3.99) \quad \widetilde{\mathcal{M}}^0(\mathcal{R}; v) = \widetilde{\mathcal{M}}^0(\mathcal{S}(v))$$

where the right hand side is defined as in (3.71), (3.72) or (3.73).

Let $C_1^{\text{int}, \lambda=0}(\hat{R})$ be the set of all interior edges of \hat{R} of level 0 and $C_1^{\lambda>0}(\hat{R})$ be the set of all edges with positive level. We define:

$$\text{EV} : \prod_{v \in C_0^{\text{ins}}(\hat{R})} \widetilde{\mathcal{M}}^0(\mathcal{R}; v) \rightarrow \prod_{e \in C_1^{\lambda>0}(\hat{R})} (\mathcal{D} \times \mathcal{D}) \times \prod_{e \in C_1^{\text{int}, \lambda=0}(\hat{R})} (L \times L)$$

as follows. Let $e \in C_1^{\lambda>0}(\hat{R})$. Then there exists a unique $\mathbf{v} \in C_0^{\text{int}}(\hat{R})$ such that $e \in C_1(\mathcal{S}(\mathbf{v}))$. We define the e -component of $\prod_{e \in C_1^{\lambda>0}(\hat{R})} (\mathcal{D} \times \mathcal{D})$ by (3.74). Let $e \in C_1^{\text{int}, \lambda=0}(\hat{R})$. We define $s(e), t(e) \in C_0^{\text{int}}(\hat{R})$ the vertices incident to e such that $s(e)$ is in the same connected component of $\hat{R} \setminus \{e\}$ as the root. We label the edges of $\mathbf{v} = t(e)$ as $e_0(\mathbf{v}), \dots, e_{k_v}(\mathbf{v})$ such that $t(e_0(\mathbf{v})) = \mathbf{v}$. (See Figure 26 below.) Suppose e is

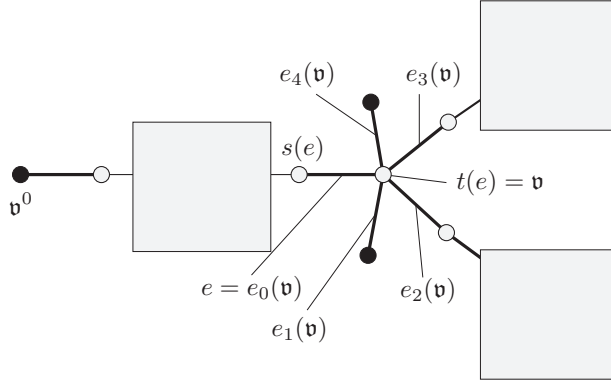

FIGURE 26. $e_i(\mathbf{v})$.

the k_e -th edge of $s(e)$. Now we define the e -component of $\prod_{e \in C_1^{\lambda=0}(\hat{R})} (L \times L)$ by

$$\text{EV}_e(\mathbf{x}_v; v \in C_0^{\text{ins}}(\hat{R})) = (\text{ev}_0^\partial(\mathbf{x}_{t(e)}), \text{ev}_{k_e}^\partial(\mathbf{x}_{s(e)})).$$

We now define:

$$(3.100) \quad \widetilde{\mathcal{M}}^0(\mathcal{R}) = \prod_{v \in C_0^{\text{ins}}(\hat{R})} \widetilde{\mathcal{M}}^0(\mathcal{R}; v) \\ \text{EV} \times_\star \left(\left(\prod_{e \in C_1^{\lambda>0}(\hat{R})} \Delta_{\mathcal{D}} \right) \times \left(\prod_{e \in C_1^{\text{int}, \lambda=0}(\hat{R})} \Delta_L \right) \right),$$

where \star is the inclusion map:

$$\left(\prod_{e \in C_1^{\lambda>0}(\hat{R})} \Delta_{\mathcal{D}} \right) \times \left(\prod_{e \in C_1^{\text{int}, \lambda=0}(\hat{R})} \Delta_L \right) \\ \rightarrow \prod_{e \in C_1^{\lambda>0}(\hat{R})} (\mathcal{D} \times \mathcal{D}) \times \prod_{e \in C_1^{\text{int}, \lambda=0}(\hat{R})} (L \times L).$$

Let $|\lambda|$ be the total number of positive levels, namely, the image of λ is $\{0, 1, \dots, |\lambda|\}$. We define an action of $\mathbb{C}_\star^{|\lambda|}$ on $\widetilde{\mathcal{M}}^0(\mathcal{R})$ by the same formula as (3.76). (This action is trivial on the components \mathbf{x}_v with $\lambda(v) = 0$.)

We define

$$(3.101) \quad \widehat{\mathcal{M}}^0(\mathcal{R}) = \widetilde{\mathcal{M}}^0(\mathcal{R})/\mathbb{C}_*^{|\lambda|}$$

The group of automorphisms $\text{Aut}(\mathcal{R})$ is the direct product

$$\prod_{\mathfrak{v} \in C_0^{\text{int}}(R)} \text{Aut}(\mathcal{S}(\mathfrak{v})).$$

We also define:

$$(3.102) \quad \mathcal{M}^0(\mathcal{R}) = \widehat{\mathcal{M}}^0(\mathcal{R})/\text{Aut}(\mathcal{R}).$$

The RGW compactification $\mathcal{M}_{k+1}^{\text{RGW}}(L; \beta)$ of $\mathcal{M}_{k+1}^{\text{reg}}(L; \beta)$, as a set, is defined to be:

$$(3.103) \quad \mathcal{M}_{k+1}^{\text{RGW}}(L; \beta) = \bigcup_{\mathcal{R}} \mathcal{M}^0(\mathcal{R})$$

where the disjoint union in the right hand side is taken over all DD-ribbon trees \mathcal{R} of type $(\beta, k+1)$.

The $(i, i+1)$ level shrinking of a DD-ribbon tree is defined as in Definition 3.48 for $i > 0$ and as in Definition 3.87 for $i = 0$. We say \mathcal{R}' is obtained from \mathcal{R} by level shrinking and write $\mathcal{R}' > \mathcal{R}$ if \mathcal{R}' is obtained from \mathcal{R} by finitely many iterations of the level shrinking operations.

We also need shrinkings of level 0 edges.

Definition 3.104. Let \hat{R} be the detailed tree associated to a DD-ribbon tree \mathcal{R} and e be an interior level 0 edge. We remove the edge e and identify its two vertices v' , v'' to obtain v . All the edges other than e which contains one of v' or v'' will be incident to the new vertex. The homology class of v is $\mathfrak{v} \beta(v) = \beta(v') + \beta(v'')$. We obtain a detailed tree associated to a new DD-ribbon tree of the same type. We say $\mathcal{R}' > \mathcal{R}$ if \mathcal{R}' is obtained from \mathcal{R} by applying the above process finitely many times. We also say \mathcal{R}' is obtained from \mathcal{R} by *level 0 edge shrinkings*.

We write $\mathcal{R}' > \mathcal{R}$ if \mathcal{R}' is obtained from \mathcal{R} by finitely many iterations of level shrinkings and level 0 edge shrinkings.

We sketch some of the basic properties of the compactification in (3.103) which will be proved in the rest of this paper and the sequels. In Section 4, we define a topology on $\mathcal{M}_{k+1}^{\text{RGW}}(L; \beta)$, called the RGW topology, that is compact and metrizable. Moreover, for any RD-ribbon tree \mathcal{R} , the space

$$\mathcal{M}(\mathcal{R}) := \mathcal{M}^0(\mathcal{R}) \cup \bigcup_{\mathcal{R}' < \mathcal{R}} \mathcal{M}^0(\mathcal{R}').$$

is a closed subset of $\mathcal{M}_{k+1}^{\text{RGW}}(L; \beta)$. In [DF18b], we define a Kuranishi structure on $\mathcal{M}_{k+1}^{\text{RGW}}(L; \beta)$ with corners such that the underlying subset of the codimension n corner is the union of all moduli spaces $\mathcal{M}^0(\mathcal{R})$, where R has at least $n+1$ interior vertices. A more detailed description of the boundary, which is important for our purposes, will be given in [DF18c, Subsection 2.2].

Next, we define the moduli space associated to an SD-ribbon tree.

Definition 3.105. Let $\mathcal{R} = (R; \mathfrak{v}_l, \mathfrak{v}_r; \mathcal{S}, \text{pt}, \alpha, \leq)$ be an SD-ribbon tree, \hat{R} be the associated detailed tree and λ be the level function of \mathcal{R} . For an interior vertex \mathfrak{v} of R , let $v \in C_0^{\text{int}}(\mathcal{S}(\mathfrak{v}))$. We define:

$$(3.106) \quad \widetilde{\mathcal{M}}^0(\mathcal{R}; v) = \widetilde{\mathcal{M}}^0(\mathcal{S}(\mathfrak{v}); v)$$

where the right hand side is as in (3.71), (3.72), (3.73) or (3.85).

Let $C_1^{\text{int},\lambda=0}(R_i)$ be the set of all interior edges of R_i of level 0 that are not strip edges ($i = 0, 1$), and $C_1^{\lambda>0}(\hat{R})$ be the set of the edges of level > 0 . We define

$$\begin{aligned} \text{EV} : & \prod_{v \in C_0^{\text{ins}}(\hat{R})} \tilde{\mathcal{M}}^0(\mathcal{R}; v) \\ & \rightarrow \prod_{e \in C_1^{\lambda>0}(\hat{R})} (\mathcal{D} \times \mathcal{D}) \times \prod_{e \in C_1^{\text{int},\lambda=0}(R_0)} (L_0 \times L_0) \times \prod_{e \in C_1^{\text{int},\lambda=0}(R_1)} (L_1 \times L_1) \end{aligned}$$

as follows. Let $e \in C_1^{\lambda>0}(\hat{R})$. Then there exists a unique $\mathbf{v} \in C_0^{\text{ins}}(R)$ such that $e \in C_1(\mathcal{S}(\mathbf{v}))$. We define the e -component of $\prod_{e \in C_1^{\lambda>0}(\hat{R})} (\mathcal{D} \times \mathcal{D})$ by (3.74).

Let $e \in C_1^{\text{int},\lambda=0}(R_1)$ and $s(e), t(e) \in C_0^{\text{int}}(R)$ be the vertices incident to e , such that $s(e)$ is in the same connected component of $R \setminus \{e\}$ as C . We enumerate the edges of $\mathbf{v}' = t(e)$ as $e_0(\mathbf{v}'), \dots, e_{k_{\mathbf{v}'}}(\mathbf{v}')$ such that $s(e_0(\mathbf{v}'))$ is $\mathbf{v} = s(e)$. (See Figure 27 below.)

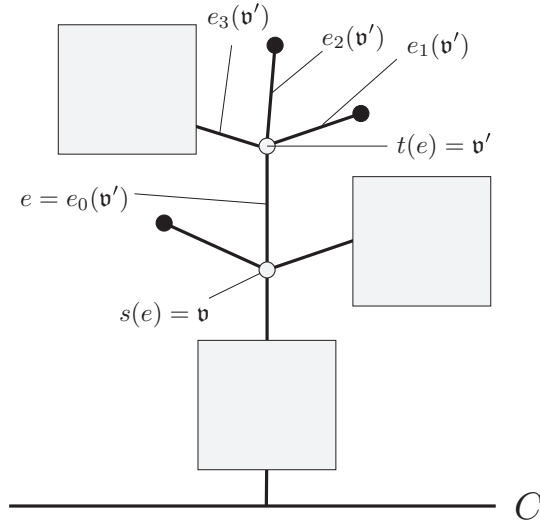

FIGURE 27. $e_i(\mathbf{v}')$.

If $s(e) \in R_1$, we enumerate the edges incident to e using the ribbon structure such that the first edge of $s(e)$ is labeled by 0. Suppose e is the k_e -th edge of $s(e)$. Now we define the e -th component of the product space $\prod_{e \in C_1^{\text{int},\lambda=0}(R_1)} (L_1 \times L_1)$ by

$$\text{EV}_e(\mathbf{x}_v; v \in C_0^{\text{int},\lambda=0}(\hat{R})) = (\text{ev}_0^\partial(\mathbf{x}_{t(e)}), \text{ev}_{k_e}^\partial(\mathbf{x}_{s(e)})).$$

If $s(e) \in C$, then we enumerate the edges of $s(e)$ in R_1 in the counter clockwise order. Let e be the k_e -th edge among them. (See Figure 28 below). We then define e -th component of $\prod_{e \in C_1^{\text{int},\lambda=0}(R_1)} (L_1 \times L_1)$ by

$$\text{EV}_e(\mathbf{x}_v; v \in C_0^{\text{int},\lambda=0}(\hat{R})) = (\text{ev}_0^\partial(\mathbf{x}_{t(e)}), \text{ev}_{1,k_e}^\partial(\mathbf{x}_{s(e)})).$$

The case $e \in C_1^{\text{int},\lambda=0}(R_0)$ can be defined in the same way.

We define:

$$(3.107) \quad \tilde{\mathcal{M}}^0(\mathcal{R}) = \prod_{v \in C_0^{\text{ins}}(\hat{R})} \tilde{\mathcal{M}}^0(\mathcal{R}; v)_{\text{EV} \times \star} \left(\left(\prod_{e \in C_1^{\lambda>0}(\hat{R})} \Delta \right) \times \left(\prod_{e \in C_1^{\text{int},\lambda=0}(R_1)} \Delta \right) \times \left(\prod_{e \in C_1^{\text{int},\lambda=0}(R_0)} \Delta \right) \right),$$

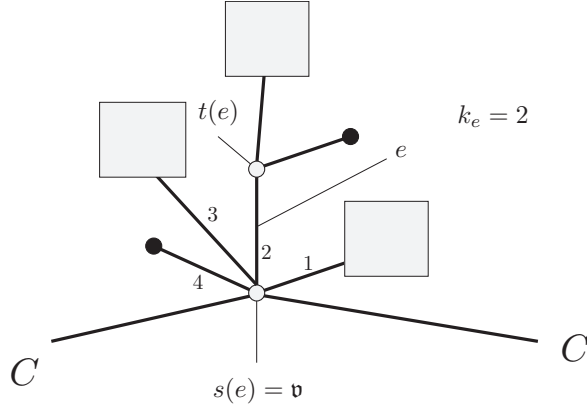
FIGURE 28. k_e .

where \star is the inclusion map. Let $|\lambda|$ be the total number of positive levels. We define an action of $\mathbb{C}_*^{|\lambda|}$ on $\widetilde{\mathcal{M}}^0(\mathcal{R})$ by the same formula as (3.76). We define

$$\widehat{\mathcal{M}}^0(\mathcal{R}) = \widetilde{\mathcal{M}}^0(\mathcal{R})/\mathbb{C}_*^{|\lambda|}$$

The group of automorphisms $\text{Aut}(\mathcal{R})$ is given as the direct product

$$\prod_{\mathfrak{v} \in C_0^{\text{int}}(\mathcal{R})} \text{Aut}(\mathcal{S}(\mathfrak{v})).$$

We define:

$$\mathcal{M}^0(\mathcal{R}) = \widehat{\mathcal{M}}^0(\mathcal{R})/\text{Aut}(\mathcal{R}).$$

Now the RGW compactification $\mathcal{M}_{k_1, k_0}^{\text{RGW}}(L_1, L_0; p, q; \beta)$ of $\mathcal{M}_{k_1, k_0}^{\text{reg}}(L_1, L_0; p, q; \beta; \emptyset)$ is defined as

$$(3.108) \quad \mathcal{M}_{k_1, k_0}^{\text{RGW}}(L_1, L_0; p, q; \beta) = \bigcup_{\mathcal{R}} \mathcal{M}^0(\mathcal{R})$$

where the disjoint union in the right hand side is taken over all RD-ribbon trees \mathcal{R} of type $(p, q; \beta; k_0, k_1)$.

We define the notion of level shrinking and level 0 edge shrinking for SD-ribbon trees in the same way as in the case of DD-ribbon trees and write $\mathcal{R}' < \mathcal{R}$, if \mathcal{R} is obtained from \mathcal{R}' by a composition of finitely many iterations of these two operations.

As in the disc case, we list some of the basic properties of the compactification in (3.108) which will be proved later. In Section 4, we define a topology on the set $\mathcal{M}_{k_1, k_0}^{\text{RGW}}(L_1, L_0; p, q; \beta)$, called the RGW topology, that is compact and metrizable. For any RD-ribbon tree \mathcal{R} , the space

$$\mathcal{M}(\mathcal{R}) := \mathcal{M}^0(\mathcal{R}) \cup \bigcup_{\mathcal{R}' < \mathcal{R}} \mathcal{M}^0(\mathcal{R}').$$

is a closed subset of $\mathcal{M}_{k_1, k_0}^{\text{RGW}}(L_1, L_0; p, q; \beta)$. In [DF18b], we define a Kuranishi structure on $\mathcal{M}_{k_1, k_0}^{\text{RGW}}(L_1, L_0; p, q; \beta)$ with corners such that the underlying subset of the codimension n corner is the union of all moduli spaces $\mathcal{M}^0(\mathcal{R})$, where \mathcal{R} has at least $n + 1$ interior vertices. A more detailed description of the boundary, which is important for our purposes, will be given in [DF18c, Subsection 2.2].

4. STABLE MAP TOPOLOGY AND RGW TOPOLOGY

4.1. Review of Stable Map Topology. We first review the definition of stable map topology, which plays an essential role in the definition of the RGW topology. The idea of compactifying moduli spaces of pseudo-holomorphic curves goes back to the groundbreaking work of Gromov in [Gro85]. It was pointed out in [Kon95a] that the notion of stable maps, which is an adaptation of the notion of stable curves due to Mumford, provides a suitable compactification of the moduli space of pseudo-holomorphic curves. The definition of stable map topology in the form that we use in this paper was introduced in [FO99, Definition 10.3].

Let $\mathcal{M}_{k+1,\ell}^d$ be the compactified moduli space of disks with $k+1$ boundary marked points and ℓ interior marked points. This space is the compactification of the space $\mathcal{M}_{k+1,\ell}^{0,d} = \{(D^2, \vec{z}, \vec{z}^+)\} / \sim$. Here $\vec{z} = (z_0, \dots, z_k)$, $\vec{z}^+ = (z_1^+, \dots, z_\ell^+)$ are distinct points such that $z_i \in \partial D^2$, $z_i^+ \in \text{Int} D^2$, and (z_0, \dots, z_k) respects the counter clockwise orientation of ∂D^2 . The equivalence relation \sim is defined by the action of $PSL(2, \mathbb{R}) = \text{Aut}(D^2)$. An element of the compactification $\mathcal{M}_{k+1,\ell}^d$ is an equivalence class of $(\Sigma, \vec{z}, \vec{z}^+)$, where Σ is a tree like union of disks with double points plus trees of sphere components attached to interior points of the disks. The tuples $\vec{z} = (z_0, \dots, z_k)$ and $\vec{z}^+ = (z_1^+, \dots, z_\ell^+)$ are respectively boundary and interior marked points. The object $(\Sigma, \vec{z}, \vec{z}^+)$ representing an element of $\mathcal{M}_{k+1,\ell}^d$ is also required to satisfy a stability condition. See [FOOO09a, Definition 2.1.18] for more details. Hereafter with a slight abuse of notation, we say $(\Sigma, \vec{z}, \vec{z}^+)$ is an element of $\mathcal{M}_{k+1,\ell}^d$. Note that the symmetric group S_ℓ of order $\ell!$ acts on $\mathcal{M}_{k+1,\ell}^d$ by exchanging the order of interior marked points.

The moduli space $\mathcal{M}_{k+1,\ell}^d$ has the structure of a smooth manifold with boundary and corner. Its codimension m corner consists of the elements $(\Sigma, \vec{z}, \vec{z}^+)$ such that Σ has at least $m+1$ disk components. (See [FOOO09a, Theorem 7.1.44].)

For any pair of injective and order preserving maps $\mathbf{i}_{k,k'} : \{1, \dots, k\} \rightarrow \{1, \dots, k'\}$ and $\mathbf{i}_{\ell,\ell'}^+ : \{1, \dots, \ell\} \rightarrow \{1, \dots, \ell'\}$, we define the forgetful map:

$$(4.1) \quad \mathbf{fg}_{\mathbf{i}_{k,k'}, \mathbf{i}_{\ell,\ell'}^+} : \mathcal{M}_{k'+1,\ell'}^d \rightarrow \mathcal{M}_{k+1,\ell}^d$$

as follows. Let $(\Sigma', \vec{z}', \vec{z}'^+) \in \mathcal{M}_{k'+1,\ell'}^d$. Define $\vec{z} = (z_0, z_{\mathbf{i}_{k,k'}(1)}, \dots, z_{\mathbf{i}_{k,k'}(k)})$ and $\vec{z}^+ = (z_{\mathbf{i}_{\ell,\ell'}^+(1)}^+, \dots, z_{\mathbf{i}_{\ell,\ell'}^+(\ell)}^+)$. The triple $(\Sigma', \vec{z}, \vec{z}^+)$ may not represent an element of $\mathcal{M}_{k+1,\ell}^d$ if it does not satisfy the stability condition. By shrinking all unstable components of $(\Sigma', \vec{z}, \vec{z}^+)$, we obtain $(\Sigma, \vec{z}, \vec{z}^+)$, which satisfies the stability condition. This element $(\Sigma, \vec{z}, \vec{z}^+)$ represents $\mathbf{fg}_{\mathbf{i}_{k,k'}, \mathbf{i}_{\ell,\ell'}^+}(\Sigma', \vec{z}', \vec{z}'^+)$. See [FOOO09b, page 419] for more details.

If $\mathbf{i}_{k,k'}$ or $\mathbf{i}_{\ell,\ell'}^+$ is the identity map, we omit it from the notation $\mathbf{fg}_{\mathbf{i}_{k,k'}, \mathbf{i}_{\ell,\ell'}^+}$. If $\mathbf{i}_{k,k'}$ is the identity map and $\mathbf{i}_{\ell,\ell'}^+(i) = i$, for $i = 1, \dots, \ell$, then we write $\mathbf{fg}_{\ell',\ell}$ instead of $\mathbf{fg}_{\mathbf{i}_{\ell,\ell'}^+}$.

We consider the map

$$(4.2) \quad \mathbf{fg}_{\ell+1,\ell} : \mathcal{M}_{k+1,\ell+1}^d \rightarrow \mathcal{M}_{k+1,\ell}^d.$$

As proved in [FOOO09b, Lemma 7.1.45], the fiber $(\mathbf{fg}_{\ell+1,\ell})^{-1}(\Sigma, \vec{z}, \vec{z}^+)$ is diffeomorphic to $\tilde{\Sigma}$ where $\tilde{\Sigma}$ is obtained from Σ by replacing each boundary node by an interval. (See Figure 29.) The space $\mathcal{C}_{k+1,\ell}$ is given by shrinking all such intervals to a point. In other words, there exists:

$$(4.3) \quad \pi : \mathcal{C}_{k+1,\ell}^d \rightarrow \mathcal{M}_{k+1,\ell}^d$$

such that the fiber over $(\Sigma, \vec{z}, \vec{z}^+)$ is identified with Σ . Note that $\mathcal{C}_{k+1,\ell}^d$ is merely a topological space and does not carry the structure of a manifold or an orbifold. Let

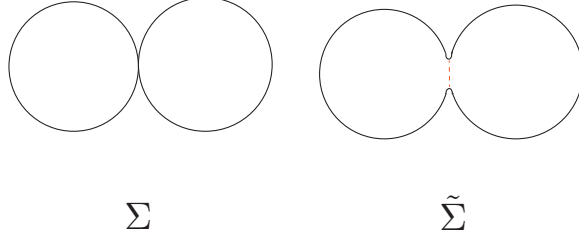
FIGURE 29. $\tilde{\Sigma}$

$\mathcal{SC}_{k+1,\ell}^d$ be the subset of $\mathcal{C}_{k+1,\ell}^d$ consisting of $x \in \mathcal{C}_{k+1,\ell}^d$ such that if $\pi(x) = (\Sigma, \vec{z}, \vec{z}^+)$, then x corresponds to a boundary or interior node of Σ .

Lemma 4.4. *The subspace $\mathcal{C}_{k+1,\ell}^d \setminus \mathcal{SC}_{k+1,\ell}^d$ has the structure of a smooth manifold with corners. Moreover, the restriction of (4.3) to $\mathcal{C}_{k+1,\ell}^d \setminus \mathcal{SC}_{k+1,\ell}^d$ is a smooth submersion.*

Proof. By construction $\mathcal{C}_{k+1,\ell}^d \setminus \mathcal{SC}_{k+1,\ell}^d$ is an open subset of $\mathcal{M}_{k+1,\ell+1}^d$. This verifies the first part. The second part also follows from the corresponding results about $\mathcal{M}_{k+1,\ell+1}^d$, which is a consequence of a similar result about the moduli space of marked spheres. (The later is classical. See, for example, [ACG11].) \square

The symmetry group S_ℓ of order $\ell!$ acts on $\mathcal{C}_{k+1,\ell}^d$ and $\mathcal{M}_{k+1,\ell}^d$ such that (4.2), (4.3) are S_ℓ -equivariant. Moreover, the S_ℓ action on $\mathcal{C}_{k+1,\ell}^d \setminus \mathcal{SC}_{k+1,\ell}^d$ is smooth.

The spaces $\mathcal{C}_{k+1,\ell}^d$, $\mathcal{M}_{k+1,\ell}^d$ are all metrizable. We fix metrics on them and use these metrics throughout the paper. (The whole construction is independent of the choice of metrics.)

Let $\zeta = (\Sigma, \vec{z}, \vec{z}^+) \in \mathcal{M}_{k+1,\ell}^d$. We define $\Gamma_\zeta = \{\gamma \in S_\ell \mid \gamma\zeta = \zeta\}$. The group Γ_ζ has a biholomorphic action on Σ which permutes interior marked points \vec{z}^+ . This action is necessarily trivial on the disk components. In the following definition, $S\Sigma$ denotes $\pi^{-1}(\zeta) \cap \mathcal{SC}_{k+1,\ell}^d$. This set consists of boundary and interior nodes of Σ .

Definition 4.5. An ε -trivialization of the universal family (4.3) at ζ is the following object.

- (1) A Γ_ζ -invariant relatively compact open subset $K \subset \Sigma \setminus S\Sigma$.
- (2) A Γ_ζ -invariant neighborhood \mathcal{U} of ζ in $\mathcal{M}_{k+1,\ell}^d$.
- (3) A smooth open embedding $\Phi : K \times \mathcal{U} \rightarrow \mathcal{C}_{k+1,\ell}^d \setminus \mathcal{SC}_{k+1,\ell}^d$, which is Γ_ζ -invariant.
- (4) The following diagram commutes.

$$\begin{array}{ccc} K \times \mathcal{U} & \xrightarrow{\Phi} & \mathcal{C}_{k+1,\ell}^d \\ \downarrow & & \downarrow \pi \\ \mathcal{U} & \longrightarrow & \mathcal{M}_{k+1,\ell}^d \end{array}$$

Here the left vertical arrow is the projection map and the second horizontal arrow is the inclusion map.

- (5) The image of Φ contains $\pi^{-1}(\mathcal{U}) \setminus B_\varepsilon(S\Sigma)$. Here $B_\varepsilon(S\Sigma)$ is the ε neighborhood of $S\Sigma$ in $\mathcal{C}_{k+1,\ell}^d$.

The existence of ε -trivialization for any ε is a consequence of Lemma 4.4.

Remark 4.6. If Σ is a disk then $S\Sigma$ is an empty set. In this case, an ε -trivialization of the universal family is a local trivialization. Note that (4.3) is a fiber bundle in the C^∞ category in a neighborhood of such elements of $\mathcal{M}_{k+1,\ell}^d$.

Remark 4.7. A similar ‘trivialization of the universal family’ is described in [FO99, Section 9] or [DF18b, Section 4]. This notion is employed to define a topology in [FO99, Definition 10.2]. In [FO99] and subsequent works such as [FOOO12, Section 16] and [FOOO16, Section 8], more specific choices of trivializations are used. Namely, a particular choice of coordinate charts are used at the nodes and the gluing construction is exploited to obtain a nearby element of $\mathcal{M}_{k+1,\ell}^d$ and a coordinate of the gluing parameter. Such a choice would be useful to study gluing analysis of pseudo-holomorphic curves and to construct Kuranishi neighborhoods, as it was done in [FO99,FOOO12,FOOO16]. See also [DF18b]. To define stable map topology, we do not need these specific choices and can work with any ε -trivialization of the universal family in the above sense.

Next, we review the stable map compactification $\mathcal{M}_{k+1,\ell}^d(\beta)$ of $\mathcal{M}_{k+1,\ell}^{0,d}(\beta)$ for $\beta \in \Pi_2(X, L)$. The space $\mathcal{M}_{k+1,\ell}^{0,d}(\beta)$ consists of $((D^2, \vec{z}, \vec{z}^+), u)$ where $(D^2, \vec{z}, \vec{z}^+) \in \mathcal{M}_{k+1,\ell}^{0,d}$ and $u : (D^2, \partial D^2) \rightarrow (X, L)$ is a pseudo-holomorphic map. An element of $\mathcal{M}_{k+1,\ell}^d(\beta)$ is an isomorphism class of $((\Sigma, \vec{z}, \vec{z}^+), u)$, where Σ is a tree like union of disks with double points plus trees of sphere components attached to the interior points of the disks, \vec{z} and \vec{z}^+ are boundary and interior marked points, and $u : (\Sigma, \partial \Sigma) \rightarrow (X, L)$ is a pseudo-holomorphic map. The object $((\Sigma, \vec{z}, \vec{z}^+), u)$ is required to satisfy the stability condition. (See [FOOO09a, Definition 2.1.24] for more details.) We say an element $((\Sigma, \vec{z}, \vec{z}^+), u) \in \mathcal{M}_{k+1,\ell}^d(\beta)$ is *source stable* if $(\Sigma, \vec{z}, \vec{z}^+) \in \mathcal{M}_{k+1,\ell}^d$ is stable.

Definition 4.8. Let $((\Sigma, \vec{z}, \vec{z}^+), u), ((\Sigma_a, \vec{z}_a, \vec{z}_a^+), u_a)$ ($a = 1, 2, 3, \dots$) belong to $\mathcal{M}_{k+1,\ell}^d(\beta)$. We assume they are all source stable. We say $((\Sigma_a, \vec{z}_a, \vec{z}_a^+), u_a)$ converges to $((\Sigma, \vec{z}, \vec{z}^+), u)$ in the stable map topology and write

$$\lim_{a \rightarrow \infty} ((\Sigma_a, \vec{z}_a, \vec{z}_a^+), u_a) = ((\Sigma, \vec{z}, \vec{z}^+), u)$$

if the following holds. For each ε , there exist $\varepsilon' > 0$ and an ε' -trivialization of the universal family at $\zeta = (\Sigma, \vec{z}, \vec{z}^+)$, denoted by (K, \mathcal{U}, Φ) , with the following properties:

- (1) Let $\xi_a = (\Sigma_a, \vec{z}_a, \vec{z}_a^+)$. This sequence converges to ξ in $\mathcal{M}_{k+1,\ell}^d$.
- (2) If a is large, then for any connected component C of $\pi^{-1}(\xi_a) \setminus \Phi(K \times \{\xi_a\})$, the diameter of $u_a(C)$ is smaller than ε .
- (3) We define $u'_a : K \rightarrow X$ by $u'_a(z) = u_a(\Phi(z, \xi_a))$. Then the C^2 distance between u'_a and u is smaller than ε for sufficiently large values of a .

In the same way as in (4.1), we define:

$$(4.9) \quad \mathfrak{fg}_{\mathbf{i}_{k,k'}, \mathbf{i}_{\ell,\ell'}^+} : \mathcal{M}_{k'+1,\ell'}^d(\beta) \rightarrow \mathcal{M}_{k+1,\ell}^d(\beta).$$

We shall use this map in the case $k = k'$, $\mathbf{i}_{k,k'}(i) = i$ and $\mathbf{i}_{\ell,\ell'}^+(i) = i$ for $i \leq \ell$. In this case, this map is denoted by the simplified notation $\mathfrak{fg}_{\ell,\ell'}$.

Definition 4.10. Let $\zeta_a = ((\Sigma_a, \vec{z}_a, \vec{z}_a^+), u_a), \zeta = ((\Sigma, \vec{z}, \vec{z}^+), u)$ be elements of $\mathcal{M}_{k+1,\ell}^d(\beta)$. We say that ζ_a converges to ζ in the *stable map topology* and write

$$\lim_{a \rightarrow \infty} \zeta_a = \zeta$$

if there exists $\zeta'_a, \zeta' \in \mathcal{M}_{k+1,\ell'}^d(\beta)$ ($\ell' \geq \ell$) with the following properties:

- (1) ζ'_a, ζ' are source stable.
- (2) $\mathfrak{fg}_{\ell,\ell'}(\zeta'_a) = \zeta_a$. $\mathfrak{fg}_{\ell,\ell'}(\zeta') = \zeta$.
- (3) $\lim_{a \rightarrow \infty} \zeta'_a = \zeta'$ in the sense of Definition 4.8.

Related to this definition, we have the following lemma, whose proof is given in [Fuk17, Lemma 12.13]. It is also a consequence of [FOOO18, Lemma 4.14].

Lemma 4.11. *Let $\zeta, \zeta_a \in \mathcal{M}_{k+1, \ell}^d(\beta)$. We assume $\lim_{a \rightarrow \infty} \zeta_a = \zeta$. Suppose $\zeta' \in \mathcal{M}_{k+1, \ell}^d(\beta)$ such that*

- (a) ζ' is source stable.
- (b) $\mathfrak{fg}_{\ell, \ell'}(\zeta') = \zeta$.

Then there exists $\zeta'_a \in \mathcal{M}_{k+1, \ell'}^d(\beta)$ such that Definition 4.10 (1), (2) and (3) hold.

Remark 4.12. Lemma 4.11 implies that for source stable objects, Definition 4.10 coincides with Definition 4.8.

We define the closure operator c for subsets of $\mathcal{M}_{k+1, \ell}^d(\beta)$ as follows. If $A \subset \mathcal{M}_{k+1, \ell}^d(\beta)$, then A^c is the set of all limits of sequences of elements of A . Here the limit is taken in the sense of Definition 4.10.

Lemma 4.13. *The closure operator c satisfies the Kuratowsky's axioms. Namely, we have: (a) $\emptyset^c = \emptyset$, (b) $A \subseteq A^c$, (c) $(A^c)^c = A^c$, (d) $(A \cup B)^c = A^c \cup B^c$.*

See [Fuk17, Lemma 12.15] for the proof. This closure operator allows us to define a topology on $\mathcal{M}_{k+1, \ell}^d(\beta)$, called the *stable map topology*. In the same way as in [FO99, Lemma 10.4], we can prove that the stable map topology is Hausdorff. In the same way as in [FO99, Lemma 11.1], we can prove that the stable map topology is compact. We can define the stable map topology for moduli spaces of pseudo-holomorphic spheres or strips in the same way.

4.2. RGW Topology. In the rest of this section, we define the RGW topology and study some of its properties. In this subsection, we define limits of sequences of pseudo-holomorphic disks, spheres and strips in the RGW topology, and then we prove sequential compactness for the RGW topology. As a part of the definition of the RGW topology, we explain when two elements of compactified moduli spaces are ε -close to each other. The way that this notion is defined makes it clear that Kuranishi neighborhoods of points of the moduli space (to be constructed in [DF18b]) contains a neighborhood of that point in the moduli space. We shall also show that the compactified moduli spaces are metrizable. In particular, they are Hausdorff and their sequential compactness imply that RGW moduli spaces are compact. Since the definitions and proofs are mostly similar in the case of strips and spheres, we mainly focus on the case of disks and then make some comments on how they should be adapted to the case of strips and spheres.

4.2.1. RGW Topology for Disks 1: Introducing Interior Marked Points. We first generalize the RGW compactification in Section 3 to the case of the moduli space of pseudo-holomorphic disks equipped with interior marked points. We modify the moduli space $\mathcal{M}_{k+1}^{\text{reg}, d}(\beta; \mathbf{m})$ of Definition 3.57 and define $\mathcal{M}_{k+1, h}^{\text{reg}, d}(\beta; \mathbf{m})$ as follows.

Definition 4.14. The set $\mathcal{M}_{k+1, h}^{\text{reg}, d}(\beta; \mathbf{m})$ consists of isomorphism classes of $((\Sigma, \vec{z}, \vec{z}^+, \vec{w}), u)$ such that (1)-(6) of Definition 3.57 and the following conditions are satisfied.

- (i) $\vec{z}^+ = (z_1^+, \dots, z_h^+)$, where $z_i^+ \in \text{Int } \Sigma$. These points are distinct and away from \vec{w} .
- (ii) $((\Sigma, \vec{z}, \vec{z}^+ \cup \vec{w}), u)$ is stable in the sense of stable maps.

We define $\mathcal{M}_h^{\text{reg}, s}(\alpha; \mathbf{m})$ by modifying $\mathcal{M}_h^{\text{reg}, s}(\alpha; \mathbf{m})$ of Definition 3.60 in a similar way. Namely, an element of $\mathcal{M}_h^{\text{reg}, s}(\alpha; \mathbf{m})$ has the form $((\Sigma, \vec{z}^+, \vec{w}), u)$ which satisfies Definition 3.60 (1)-(5), \vec{z}^+ is an h -tuple of distinct marked points away from \vec{w} , and $((\Sigma, \vec{z}^+ \cup \vec{w}), u)$ is stable.

Let $\mathbf{m} = (m_0, \dots, m_\ell)$. We define $\widetilde{\mathcal{M}}_h^0(\mathcal{D} \subset X; \alpha; \mathbf{m})$ as the set of strong isomorphism classes of $((\Sigma, \vec{z}^+, \vec{w}); u; s)$ such that $((\Sigma, \vec{w}); u; s)$ satisfies Definition 3.11 (1)-(4) and \vec{z}^+

is an h -tuple of additional distinct marked points disjoint from \vec{w} . We also require stability of $((\Sigma, \vec{w} \cup \vec{z}^+); u)$ instead of Definition 3.11 (5).

Using these spaces as in Section 3, we may define a compactification of $\mathcal{M}_{k+1,h}^{\text{reg,d}}(\beta)$ as follows. We consider a generalization of the notion of detailed DD-ribbon trees of homology class β , where one such detailed DD-ribbon tree \hat{R} is required to satisfy the additional conditions:

(DD+.1) We have a map $\text{mk} : \{1, \dots, h\} \rightarrow C_0^{\text{int}}(\hat{R})$, that describes each element of \vec{z}^+ on which component lies. Define:

$$h_v = \#\{i \in \{1, \dots, h\} \mid \text{mk}(i) = v\}.$$

(DD+.2) We modify stability as follows. For each interior vertex v of \hat{R} we assume one of the following holds.

- (a) The homology class of v is nonzero.
- (b) If the color of v is s or D, then the number of edges containing v plus h_v is not smaller than 3.
- (c) If the color of v is d, then the following inequality holds:

$$\begin{aligned} & 2(\text{the number of edges of positive level}) \\ & + (\text{the number of edges of level 0}) + 2h_v \geq 3. \end{aligned}$$

We denote by \mathcal{R}^+ the pair (\mathcal{R}, mk) . We then modify the fiber product (3.100) as follows. Firstly we need to replace $\widetilde{\mathcal{M}}^0(\mathcal{R}, v)$ with $\widetilde{\mathcal{M}}^0(\mathcal{R}^+, v)$, defined as below. If we are in the situation of (3.71), where the color of v is d, then:

$$(4.15) \quad \widetilde{\mathcal{M}}^0(\mathcal{R}^+, v) = \mathcal{M}_{k+1,h_v}^{\text{reg,d}}(\alpha(v); \mathbf{m}^v).$$

Here \mathbf{m}^v is defined as in (3.71). If we are in the situation of (3.72), where the color of v is s, then:

$$(4.16) \quad \widetilde{\mathcal{M}}^0(\mathcal{R}^+, v) = \mathcal{M}_{h_v}^{\text{reg,s}}(\alpha(v); \mathbf{m}^v).$$

Here \mathbf{m}^v is defined as in (3.72). If we are in the situation of (3.73), where the color of v is D, then:

$$(4.17) \quad \widetilde{\mathcal{M}}^0(\mathcal{R}^+, v) = \widetilde{\mathcal{M}}_{h_v}^0(\mathcal{D} \subset X; \alpha(v); \mathbf{m}^v).$$

Here \mathbf{m}^v is defined as in (3.73).

Thus we modify (3.100), (3.101) and (3.102) to obtain, $\widetilde{\mathcal{M}}^0(\mathcal{R}^+)$, $\widehat{\mathcal{M}}^0(\mathcal{R}^+)$, and $\mathcal{M}^0(\mathcal{R}^+)$. We finally modify (3.103) to:

$$(4.18) \quad \mathcal{M}_{k+1,h}^{\text{RGW}}(L; \beta) = \bigcup_{\mathcal{R}^+} \mathcal{M}^0(\mathcal{R}^+).$$

4.2.2. *RGW Topology for Disks 2: Definition of Convergence.* In our definition of the RGW topology, we use the obvious forgetful map

$$(4.19) \quad \text{forget} : \mathcal{M}_{k+1,h}^{\text{RGW}}(L; \beta) \rightarrow \mathcal{M}_{k+1,h}(L; \beta)$$

from the RGW compactification to the stable map compactification. Namely, for each factor $\widetilde{\mathcal{M}}^0(\mathcal{R}^+, v)$, we forget various parts of the information associated to that element (such as the section s_v in the case that the color of v is D) and glue them according to the detailed DD-ribbon tree \hat{R}^+ . (Note that in the case that the color of v is D, the target of the map u_v is \mathcal{D} which is a subset of X . So we can regard it as a map to X .)

Situation 4.20. *We consider the following situation.*

- (1) $\zeta_a = ((\Sigma(a), \vec{z}(a), \vec{z}^+(a)), u_a) \in \mathcal{M}_{k+1,h}^{\text{reg,d}}(\beta; \emptyset)$.
- (2) $\zeta \in \mathcal{M}^0(\mathcal{R}^+) \subset \mathcal{M}_{k+1,h}^{\text{RGW}}(L; \beta)$ where $\zeta = (\zeta(v); v \in C_0^{\text{int}}(\hat{R}^+))$ and:

- (a) $\zeta(v) \in \mathcal{M}_{k+1, h_v}^{\text{reg}, d}(\alpha(v); \mathbf{m}_+^v)$ when the color of v is d . We write $\zeta(v) = ((\Sigma(v), \vec{z}(v), \vec{z}^+(v), \vec{w}(v)), u_v)$.
- (b) $\zeta(v) \in \mathcal{M}_{h_v}^{\text{reg}, s}(\alpha(v); \mathbf{m}^v)$ when the color of v is s , and $\zeta(v)$ is given by $((\Sigma(v), \vec{z}^+(v), \vec{w}(v)), u_v)$.
- (c) $\zeta(v) \in \widetilde{\mathcal{M}}_{h_v}^0(\mathcal{D} \subset X; \beta(v); \mathbf{m}^v)$ when the color of v is D . We write $\zeta(v) = ((\Sigma(v), \vec{z}^+(v), \vec{w}(v)); u_v; s_v)$.
- (3) We assume

$$\lim_{a \rightarrow \infty} \text{forget}(\zeta_a) = \text{forget}(\zeta).$$

Here the convergence is given by the stable map topology.

- (4) We assume $\text{forget}(\zeta_a)$ and $\text{forget}(\zeta)$ are source stable.

We firstly define when a sequence ζ_a as in Situation 4.20 converges to ζ in the RGW topology. Later, we reduce the definition of the RGW topology in the general case to this special situation. Let ξ_a and ξ be source curves of $\text{forget}(\zeta_a)$ and $\text{forget}(\zeta)$, respectively. By assumption (Situation 4.20 (3) and (4)), ξ_a converges to ξ in $\mathcal{M}_{k+1, h}^d$. For each sufficiently small ε , we take an ε -trivialization of the universal family in the sense of Definition 4.8, which we denote by (K, \mathcal{U}, Φ) . We also define:

$$(4.21) \quad K(v) = K \cap \Sigma(v).$$

By Definition 4.8 (3), $u'_a(z) = u_a(\Phi(z, \zeta_a))$ converges to u in the C^2 topology on each $K(v)$. We denote by $u'_{a,v}$ the restriction of u'_a to $K(v)$.

Let v be a vertex with color D . Then for sufficiently large a , we may assume

$$(4.22) \quad u'_{a,v}(z) \in \mathcal{N}_{\mathcal{D}}^{\leq c}(X).$$

for $z \in K(v)$. Here $\mathcal{N}_{\mathcal{D}}^{\leq c}(X)$ is the set of $(p, x) \in \mathcal{N}_{\mathcal{D}}(X)$ such that $p \in \mathcal{D}$ and x is in the fiber of $\mathcal{N}_{\mathcal{D}}(X)$ with $\|x\| \leq c$, which is also identified with a regular neighborhood of \mathcal{D} in X using an almost complex structure preserving symplectomorphism. (See Subsection 3.2.) We use this symplectomorphism to make sense of (4.22). Therefore, we can use (4.22), to obtain maps:

$$(4.23) \quad u'_{a,v} : K(v) \rightarrow \mathcal{N}_{\mathcal{D}}(X).$$

The data of ζ include a section s_v of $u_v^* \mathcal{N}_{\mathcal{D}}(X)$. We use this section to obtain the map

$$(4.24) \quad U_v : \Sigma(v) \setminus \vec{w}(v) \rightarrow \mathcal{N}_{\mathcal{D}}(X) \setminus \mathcal{D}.$$

Recall that the definition of $\mathcal{M}^0(\mathcal{R}) \subset \mathcal{M}_{k+1, h}^{\text{RGW}}(L; \beta)$ involves taking the quotient by the $\mathbb{C}_*^{|\lambda|}$ -action and $\text{Aut}(\mathcal{R})$. (See (3.101) and (3.102).) Here we fix one representative for these quotients.

The main requirement that we need to define is how the sections s_v are related to the objects ζ_a . Let $|\lambda|$ be the number of levels of \hat{R} . We have the identification:

$$(4.25) \quad \mathcal{N}_{\mathcal{D}}(X) \setminus \mathcal{D} = \mathbb{R} \times S(\mathcal{N}_{\mathcal{D}}(X))$$

where $S\mathcal{N}_{\mathcal{D}}(X)$ is the unit S^1 -bundle associated to $\mathcal{N}_{\mathcal{D}}(X)$.

Definition 4.26. Suppose we are in Situation 4.20. We say that ζ_a converges to ζ in the RGW topology and write

$$\lim_{a \rightarrow \infty} \zeta_a = \zeta,$$

if for each $j \in \{1, \dots, |\lambda|\}$, there exists a sequence $\rho_{a,j} \in \mathbb{C}_*$ and for each $\varepsilon > 0$ there are an ε -trivialization (K, \mathcal{U}, Φ) as above and an integer $N(\varepsilon)$ such that the following properties hold:

(1) For $a \geq N(\varepsilon)$ and any v , we have $\xi_a \in \mathcal{U}$ and:

$$d_{C^2} \left(\text{Dil}_{1/\rho_{a,\lambda(v)}} \circ u'_{a,v}, U_v \right) < \varepsilon$$

We use the product metric on (4.25) to define the C^2 distance for the maps with domain $K(v)$. The map Dil_c is given by dilation in the fiber direction of $\mathcal{N}_{\mathcal{D}}(X)$.

In particular, it is an isometry with respect to the product metric.

(2) If $j < j'$ then

$$\lim_{a \rightarrow \infty} \frac{\rho_{a,j}}{\rho_{a,j'}} = \infty.$$

Roughly speaking, Item (1) says that on $K(v)$, the sequence of maps u_a converges to U_v after scaling by $\rho_{a,\lambda(v)}$. Item (2) asserts that the distance between $u_a(K(v'))$ and \mathcal{D} goes to zero faster than the distance between $u_a(K(v))$ and \mathcal{D} if $\lambda(v) < \lambda(v')$. The idea of using dilation in the above definition of convergence goes back to [LR01].

Remark 4.27. As we mentioned before, there is an ambiguity of the choice of the representative of ζ_a because of the $\mathbb{C}_*^{|\lambda|}$ -action. If we take another choice, we can change $\rho_{a,j}$ to $\rho_{a,j}c_j$ where $c_j \in \mathbb{C}_*$. Therefore, Definition 4.26 is independent of the choice of representatives.

In Definition 4.26, we define the RGW convergence in the case that source curves are stable. We can define the general case analogous to the stable map topology as follows. Firstly note that we can define a forgetful map

$$\mathbf{fg}_{h',h} : \mathcal{M}_{k+1,h'}^{\text{RGW}}(L; \beta) \rightarrow \mathcal{M}_{k+1,h}^{\text{RGW}}(L; \beta)$$

of interior marked points for $h' > h$. Namely, we forget the marked points with labels $(h+1), \dots, h'$ and shrink the components which become unstable. In this process, the level function λ may not be preserved because all the components in a certain level may be shrunk. In the case that this happens, we remove such a level, say m , and decrease the value of the level function for each vertex of level $> m$. In other words, the quasi order \leq is preserved by this shrinking process. In particular, this construction is similar to the forgetful map (4.9) in the discussion of stable map topology. See also [DF18c, Subsection 4.2] on the forgetful map of the boundary marked points.

Definition 4.28. Let $\zeta_a \in \mathcal{M}_{k+1,h}^{\text{reg,d}}(L; \beta; \emptyset)$ and $\zeta \in \mathcal{M}_{k+1,h}^{\text{RGW}}(L; \beta)$. We say that ζ_a converges to ζ and write

$$\lim_{a \rightarrow \infty} \zeta_a = \zeta,$$

if there are source stable elements $\zeta'_a \in \mathcal{M}_{k+1,h'}^{\text{reg,d}}(L; \beta; \emptyset)$ and $\zeta' \in \mathcal{M}_{k+1,h'}^{\text{RGW}}(L; \beta)$ as in Situation 4.20 such that

- (1) $\mathbf{fg}_{h',h}(\zeta'_a) = \zeta_a$, $\mathbf{fg}_{h',h}(\zeta') = \zeta$.
- (2) $\lim_{a \rightarrow \infty} \zeta'_a = \zeta'$.

4.2.3. *RGW Topology for Disks 3: Compactness.* The next proposition provides the main part in showing that the space $\mathcal{M}_{k+1,h}^{\text{RGW}}(L; \beta)$ is compact:

Proposition 4.29. *For any sequence $\zeta_a \in \mathcal{M}_{k+1,h'}^{\text{reg,d}}(L; \beta)$, there exists a subsequence which converges in the sense of Definition 4.28.*

As a preparation for the proof of this proposition, we need two lemmas. The first one is a standard exponential decay result.

Lemma 4.30. *There is a positive constant ε and for any positive integer k , there are constants C_k, e_k such that the following holds. Let $A_T := [-T, T] \times S^1$ and $u : A_T \rightarrow \mathcal{D}$ be a $J_{\mathcal{D}}$ -holomorphic map such that*

$$\int_{A_T} u^* \omega_{\mathcal{D}} < \varepsilon.$$

Then

$$\sum_{\ell=1}^k |(\nabla^{\ell} u)(\tau, t)| \leq C_k e^{-e_k(T-|\tau|)}$$

for $(\tau, t) \in [-T+1, T-1] \times S^1$. Here the left hand side is the C^{k-1} norm of the first derivative of u with respect to the standard coordinates on $[-T, T] \times S^1$.

The following lemma is a standard fact about conformal maps between annuli.

Lemma 4.31. *Let $A(c_1, c_2)$ be the annulus given as*

$$\{z \in \mathbb{C} \mid c_1 \leq |z| \leq c_2\}.$$

Let $u : [-T, T] \times S^1 \rightarrow A(c_1, c_2)$ be a holomorphic map that

$$|u(-T, t)| = c_1 \quad |u(T, t)| = c_2.$$

Then there exist a complex number z_0 and a positive integer m such that:

$$(4.32) \quad u(\tau, t) = \exp(2\pi m(\tau + \sqrt{-1}t) - z_0).$$

Proof of Proposition 4.29. Suppose $\zeta_a = ((\Sigma(a), \vec{z}(a), \vec{z}^+(a)), u_a)$ is an element of the moduli space $\mathcal{M}_{k+1, h'}^{\text{reg, d}}(L; \beta)$. Using compactness of the stable map compactification [FO99, Theorem 11.1], we may assume that there exist ζ'_a and ζ' which are source stable, ζ'_a converges to ζ' in the stable map topology (Definition 4.8) and $\text{fg}(\zeta'_a) = \zeta_a$. Here fg is the forgetful map of interior marked points. Without loss of generality, we can replace ζ_a by ζ'_a . We also assume that $\zeta = ((\Sigma, \vec{z}, \vec{z}^+), u)$. Let G be the set of irreducible components of Σ . We will write Σ_w and u_w for the irreducible component associated to $w \in G$ and the restriction of the map u to this component. The set G can be divided into two parts:

$$G = G_0 \cup G_{>0},$$

where $w \in G_{>0}$ if and only if $u(\Sigma_w)$ is contained in \mathcal{D} .

We need to find $\hat{\zeta} \in \mathcal{M}_{k+1, h}^{\text{RGW}}(L; \beta)$ with $\text{forget}(\hat{\zeta}) = \zeta$ and show that, after passing to a subsequence of $\{\zeta_a\}_{a \in \mathbb{N}}$, the properties of Definition 4.26 hold. In particular, we need to find the following objects:

- (I) A meromorphic section s_w of $u_w^*(\mathcal{N}_{\mathcal{D}}(X))$ for each $w \in G_{>0}$.
- (II) A level function $\lambda : G \rightarrow \{0, 1, \dots, |\lambda|\}$.
- (III) A multiplicity function m associated to any intersection point of two irreducible components Σ_w and $\Sigma_{w'}$ such that $\lambda(w) \neq \lambda(w')$.
- (IV) An element $\rho_{a, j} \in \mathbb{C}_*$ for each $j \leq |\lambda|$ and a .

We construct the objects in (I)-(IV) in an inductive way. Let

$$\Sigma(0) = \bigcup_{w \in G_0} \Sigma_w \quad \Sigma'(0) = \bigcup_{w \in G_{>0}} \Sigma_w$$

In other words, $\Sigma(0)$ is the union of the irreducible components Σ_w of Σ that $u(\Sigma_w)$ is *not* contained in \mathcal{D} , and $\Sigma'(0)$ is the union of all the remaining components. The intersection $S(0) := \Sigma(0) \cap \Sigma'(0)$ consists of finitely many nodal points. For each point $p \in S(0)$, we fix a small neighborhood U_p (resp. U'_p) in $\Sigma(0)$ (resp. $\Sigma'(0)$). Let $\mathfrak{U}(0)$ (resp. $\mathfrak{U}'(0)$) denote the union of the open sets U_p (resp. U'_p). For each $p \in S(0)$, we

also fix an open neighborhood of $u(p) \in \mathcal{D}$ that is contained in the subspace⁶ $\mathcal{N}_{\mathcal{D}}^{\leq 1}(X)$ of X . We may assume that this open set has the form $B(1) \times V_p$ with respect to a local unitary trivialization of $\mathcal{N}_{\mathcal{D}}(X)$ where $B(r)$ is the ball of radius r and V_p is the open ball of radius 1 in $\mathbb{C}^{\dim(\mathcal{D})}$. After modifying the choice of U_p , we can also assume that u maps U_p to $B(\sigma) \times V_p$, the boundary of U_p to $S(\sigma) \times V_p$, U'_p to $\{0\} \times V_p$ and p to $(0, 0)$. Here $S(r) \subset \mathbb{C}$ is the circle of radius r and $\sigma < \frac{1}{2}$ is a positive real number, independent of p . Finally, let $K(0)$ and $K^+(0)$ denote the subspaces $\Sigma'(0) \setminus \mathcal{U}'(0)$ and $\overline{\Sigma'(0)} \cup \mathcal{U}(0)$. (See Figure 30.)

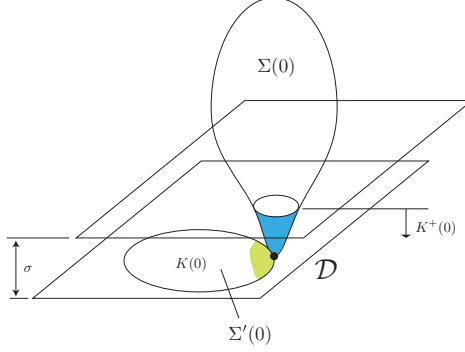

FIGURE 30. $K(0)$ and $K^+(0)$

Let $U(\xi)$ be a small neighborhood of $\xi = (\Sigma, \bar{z}, \bar{z}^+)$ in $\mathcal{M}_{k+1,h}^d$. We fix $\mathcal{K}(0), \mathcal{K}^+(0) \subset \mathcal{C}_{k+1,h}^d$ with the following properties: (See Figure 31.)

- (1) $\mathcal{K}(0), \mathcal{K}^+(0)$ are manifolds with boundary and $\mathcal{K}(0) \setminus \partial\mathcal{K}(0), \mathcal{K}^+(0) \setminus \partial\mathcal{K}^+(0)$ are open subsets of $\mathcal{C}_{k+1,h}^d$.
- (2) $\mathcal{K}(0) \cap \pi^{-1}(\xi) = K(0)$ and $\mathcal{K}^+(0) \cap \pi^{-1}(\xi) = K^+(0)$.
- (3) $\mathcal{K}(0), \mathcal{K}^+(0)$ are closed subsets of $\pi^{-1}(U(\xi))$.

If a is large enough, then $\xi_a = (\Sigma(a), \bar{z}(a), \bar{z}^+(a))$ is an element of $U(\xi)$. For such a , we denote $\mathcal{K}(0) \cap \pi^{-1}(\xi_a)$ and $\mathcal{K}^+(0) \cap \pi^{-1}(\xi_a)$ by $K_a(0)$ and $K_a^+(0)$. For large enough values of a , $u_a(K_a^+(0))$ is a subset of $\mathcal{N}_{\mathcal{D}}^{\leq 2\sigma}(X)$ and the intersection $u_a(K_a^+(0)) \cap \mathcal{N}_{\mathcal{D}}^{\leq \sigma/2}(X)$ is non-empty. Moreover, $K_a^+(0) \setminus K_a(0)$ has one connected component for each $p \in S(0)$. We write $K_{a,p}$ for the interior of this connected component which is an annulus. If we only consider large enough values of a , then u_a maps $K_{a,p}$ to $B(2\sigma) \times V_p$.

We define:

$$\rho_{a,1} = \sup\{\|u_a(z)\| \mid z \in K_a(0)\}.$$

where $\|\cdot\|$ denotes the fiber norm of elements of $\mathcal{N}_{\mathcal{D}}(X)$. Note that the supremum may be achieved either on the boundary of $K_a(0)$ or at a point on an irreducible component which does not intersect $S(0)$. (See Figure 32.) By definition $\lim_{a \rightarrow \infty} \rho_{a,1} = 0$. The composition:

$$(4.33) \quad u'_a := \text{Dil}_{1/\rho_{a,1}} \circ u_a : K_a^+(0) \rightarrow \mathcal{N}_{\mathcal{D}}^{\leq 2\sigma/\rho_{a,1}}(X),$$

is a holomorphic map, which sends $K_a(0)$ to $\mathcal{N}_{\mathcal{D}}^{\leq 1}(X)$.

We pick $d_1 \in (1, 2)$ and $d_{2,a} \in (\frac{\sigma}{2\rho_{a,1}} - 1, \frac{\sigma}{2\rho_{a,1}})$ such that they are regular values of the function:

$$z \in K_a^+(0) \mapsto \|u'_a(z)\|.$$

⁶Here we assume that after a rescaling of the hermitian metric on the bundle $\mathcal{N}_{\mathcal{D}}(X)$, the disk bundle $\mathcal{N}_{\mathcal{D}}^{\leq 1}(X)$ can be identified with a neighborhood of \mathcal{D} in X .

FIGURE 31. $\mathcal{K}(0)$ and $\mathcal{K}^+(0)$ 

FIGURE 32. where sup is taken

For $p \in S(0)$, we define:

$$U_{a,p} = \{z \in K_{a,p} \mid \|u'_a(z)\| \in [d_1, d_{2,a}]\}.$$

The domain $U_{a,p}$ is conformally equivalent to an annulus $[-T_{a,p}, T_{a,p}] \times S^1$. Otherwise, there exists a domain $D \subset K_{a,p} \setminus U_{a,p}$, which is a connected component of $D \subset K_{a,p} \setminus U_{a,p}$ and its boundary lies on $U_{a,p}$. (See Figure 33.) Then one of the following occurs:

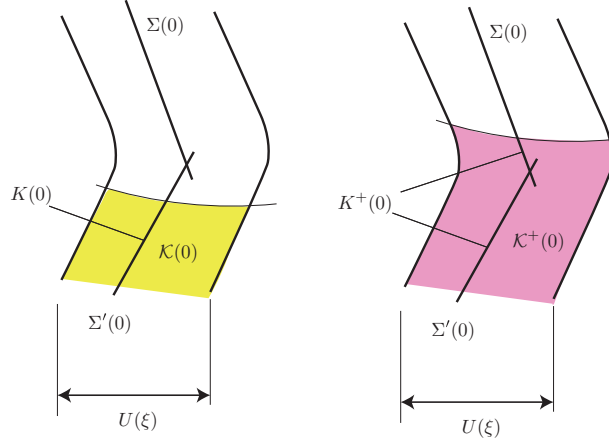
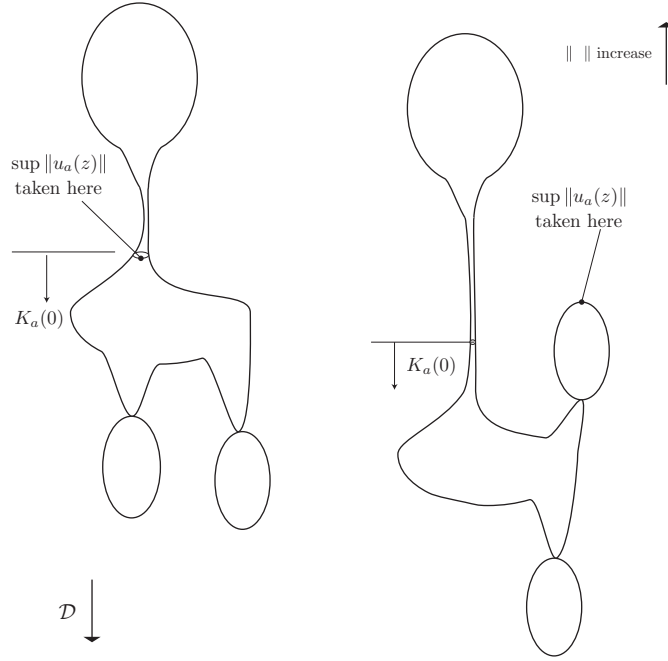
- (1) $\|u'_a(z)\| = d_1$ for $z \in \partial D$ and $\|u'_a(z)\| \leq d_1$ for $z \in D$.
- (2) $\|u'_a(z)\| = d_{2,a}$ for $z \in \partial D$ and $\|u'_a(z)\| \geq d_{2,a}$ for $z \in D$.

Both cases are impossible, because of the maximum principle.

Let $\bar{u}'_a : [-T_{a,p}, T_{a,p}] \times S^1 \rightarrow V_p$ be the composition of a conformal isomorphism from $[-T_{a,p}, T_{a,p}] \times S^1$ to $U_{a,p}$, the map u'_a and the projection $\mathcal{N}_{\mathcal{D}}(X) \rightarrow \mathcal{D}$. If a is large enough, then we may assume that the assumption of Lemma 4.30 is satisfied and hence we have the exponential decay result of this lemma.

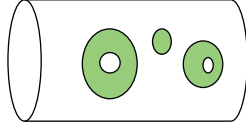

FIGURE 33. Subdomain D

We next discuss almost complex structure of the pull back bundle $(\bar{u}'_a)^*\mathcal{N}_{\mathcal{D}}(X)$. The chosen unitary trivialization of $\mathcal{N}_{\mathcal{D}}(X)$ in a neighborhood of $u(p)$ (which identifies this neighborhood with the direct product $D(1) \times V_p$) induces a unitary trivialization of the bundle $(\bar{u}'_a)^*\mathcal{N}_{\mathcal{D}}(X)$. We may consider two connections on this bundle over $U_{a,p}$: the connection θ_0 given by the trivialization and the connection θ given by pulling back the connection on $\mathcal{N}_{\mathcal{D}}(X)$ that is used in the definition of the almost complex structure J on X in a neighborhood of \mathcal{D} . (See Subsection 3.2.) After fixing a large enough positive integer k ($k = 2$ will be sufficient for our purposes), we can apply Lemma 4.30 to obtain constants c and δ such that

$$(4.34) \quad \sum_{\ell=1}^k |\nabla^{\ell}(\theta - \theta_0)(\tau, t)| \leq ce^{-\delta(T-|\tau|)}$$

holds for any $(\tau, t) \in [-T_{a,p}, T_{a,p}] \times S^1$. Here by letting ε go to zero and keeping δ fixed, we may assume that c is arbitrarily small.

We use θ to obtain the structure of a holomorphic line bundle on $(\bar{u}'_a)^*\mathcal{N}_{\mathcal{D}}(X)$, which we denote by \mathcal{L} . We denote by \mathcal{L}_0 the holomorphic line bundle $(\bar{u}'_a)^*\mathcal{N}_{\mathcal{D}}(X)$ with direct product holomorphic structure, that is induced by θ_0 . We will construct an isomorphism of holomorphic line bundles $g : \mathcal{L}_0 \rightarrow \mathcal{L}$. Regarding g as a \mathbb{C}_* -valued function on $[-T_{a,p}, T_{a,p}] \times S^1$, we need to solve

$$(4.35) \quad \bar{\partial}g = (\theta_0 - \theta)^{(0,1)}g,$$

In fact, if $(\theta_0 - \theta)^{(0,1)} = \alpha(d\tau - idt)$, then $g = \exp(f)$ for any solution f of the equation

$$(4.36) \quad \frac{df}{d\tau} + i\frac{df}{dt} = 2\alpha$$

gives a solution of (4.35). Lemma 4.40 implies that there is a solution f of (4.36) such that the C^k norm of f over $[-T_{a,p} + 1, T_{a,p} - 1] \times S^1$ is bounded by a constant ε' that depends only on the constants C and δ in (4.34). In particular, we have the following bound for $g = \exp(f)$:

$$(4.37) \quad |g - 1|_{C^k([-T_{a,p}+1, T_{a,p}-1] \times S^1)} < \varepsilon',$$

after possibly increasing the value of ε' .

The pseudo-holomorphic map u'_a induces a holomorphic section $\hat{u}'_a : [-T_{a,p}, T_{a,p}] \times S^1 \rightarrow \mathcal{L}$. In particular,

$$g^{-1} \cdot \hat{u}'_a : [-T_{a,p}, T_{a,p}] \times S^1 \rightarrow \mathcal{L}_0 \cong [-T_{a,p}, T_{a,p}] \times S^1 \times \mathbb{C}$$

is holomorphic, where the complex structure of the codomain is the direct product of the complex structures $[-T_{a,p}, T_{a,p}] \times S^1$ and \mathbb{C} . Since g is a bundle isomorphism it preserves the \mathbb{C}_* action and projection. Although it does not preserve norm, we have the following inequality for any $v \in \mathcal{L}_0$:

$$1 - \varepsilon' < |g(v)/v| < 1 + \varepsilon'.$$

We define

$$U'_{a,b} = \{z \in [-T_{a,p} + 1, T_{a,p} - 1] \mid (g^{-1} \circ \hat{u}'_a)(z) \in [(1 + \varepsilon')d_1, (1 - \varepsilon')d_{2,a}]\}.$$

In the same way as before, $U'_{a,b}$ is conformal to an annulus $[-T'_{a,p}, T'_{a,p}] \times S^1$.

Compose a conformal isomorphism from $[-T'_{a,p}, T'_{a,p}] \times S^1$ to $U'_{a,p}$ with the map $g^{-1} \circ u'_a$ to define

$$u''_{a,p} = (u''_{a,p,1}, u''_{a,p,2}) : [-T'_{a,p}, T'_{a,p}] \times S^1 \rightarrow A((1 + \varepsilon')d_1, (1 - \varepsilon')d_{2,a}) \times V_p.$$

Lemma 4.31 asserts that there are a positive integer $m_{a,p}$ and a complex number $z_{a,p}$ such that

$$(4.38) \quad u''_{a,p,1}(\tau, t) = \exp(2\pi m_{a,p}(\tau + \sqrt{-1}t) - z_{a,p}).$$

The convergence of ζ_a to ζ in the stable map topology implies that $m_{a,j}$ is independent of a for sufficiently large values of a . In fact, this common value, denoted by m_p , is the order of tangency of $u(\Sigma(0))$ to \mathcal{D} at p . Consequently, $\lim_{a \rightarrow \infty} d_{2,a} = \infty$ implies that

$$\lim_{a \rightarrow \infty} T'_{a,p} = \infty.$$

The functions $g \cdot u''_{a,p}$ can be perturbed and extended into functions $v_{a,p} : [-T_{a,p}, \infty) \times S^1 \rightarrow \mathbb{C} \times V_p$. Firstly let $\chi : \mathbb{R} \rightarrow [0, 1]$ be a smooth function satisfying the following properties:

- (i) $\chi(\tau) = 1$ for $\tau \in (-\infty, 0]$;
- (ii) $\chi(\tau) = 0$ on $\tau \in [1, \infty)$.

Then we define

$$v_{a,p}(\tau, t) = ((\chi(\tau)(g - 1) + 1)u''_{a,p,1}(\tau, t), \chi(\tau)(u''_{a,p,2}(\tau, t) - u''_{a,p,2}(0, 0)) + u''_{a,p,2}(0, 0))$$

if $(t, \tau) \in [-T'_{a,p}, T'_{a,p}] \times S^1$, and

$$v_{a,p}(\tau, t) = (\exp(2\pi m_{a,p}(\tau + \sqrt{-1}t) - z_{a,p}), u''_{a,p,1}(\tau, t), u''_{a,p,2}(0, 0))$$

if $(t, \tau) \in [1, \infty) \times S^1$. We may regard $v_{a,p}$ as a map into $\mathbf{P}(\mathcal{N}_{\mathcal{D}}(X) \oplus \mathbb{C})$ by identifying $\mathbb{C} \times V_p$ with the open subset of $\mathcal{N}_{\mathcal{D}}(X) \subset \mathbf{P}(\mathcal{N}_{\mathcal{D}}(X) \oplus \mathbb{C})$, given by fibers of $\mathcal{N}_{\mathcal{D}}(X)$ over V_p . Lemma 4.31 and the shape of the symplectic form $\omega_{\mathbf{P}}$ on $\mathbf{P}(\mathcal{N}_{\mathcal{D}}(X) \oplus \mathbb{C})$ given in Subsection 3.2. implies that there is a positive constant C , independent of a , such that:

$$(4.39) \quad \int_{[0,1] \times S^1} (v_{a,p})^* \omega_{\mathbf{P}} > -C \quad \int_{[0,1] \times S^1} |dv_{a,p}|^2 < C.$$

where $[0, 1] \times S^1 \subset [-T_{a,p}, \infty) \times S^1$ is the cylinder where the map $u''_{a,p,2}$ is not necessarily holomorphic anymore. The norm of the differential $dv_{a,p}$ is defined using the metric associated to $\omega_{\mathbf{P}}$ and $J_{\mathbf{P}}$.

Suppose $\Sigma(a; 1)$ is a sphere given by gluing the cylinders $[-T_{a,p}, \infty) \times S^1$ to $K_a^+(0)$ and then adding a point for each p . The maps u'_a and $v_{a,p}$ can be used to define a map

$$u'''_a : \Sigma(a; 1) \rightarrow \mathbf{P}(\mathcal{N}_{\mathcal{D}}(X) \oplus \mathbb{C}).$$

The map u'''_a is equal to u'_a on the subspace of $K_a^+(0)$ where $\|u'_a\|$ is at most d_1 and is equal to $v_{a,p}$ on the cylinder $[-T_{a,p}, \infty) \times S^1$. In particular, u'''_a is holomorphic except on the cylinders $[0, 1] \times S^1 \subset [-T_{a,p}, \infty) \times S^1$.

The convergence of ζ_a to ζ in the stable map topology implies that $\pi \circ u'''_a$ is convergent to $u|_{\Sigma'(0)}$. This observation and the behavior of u'''_a on each cylinder $[-T_{a,p}, \infty) \times S^1$ allows us to conclude that the maps u'''_a represent the same homology class in $\mathbf{P}(\mathcal{N}_{\mathcal{D}}(X) \oplus \mathbb{C})$. Thus we can use (4.39) to conclude that there is a uniform constant M such that

$$\int_{\Sigma'(a,1)} |du'''_a|^2 < M$$

where $|\cdot|$ is defined with respect to $\omega_{\mathbf{P}}$ and $J_{\mathbf{P}}$. Gromov compactness implies that after passing to a subsequence, the sequence $(\Sigma(a; 1), u'''_{a,1})$ together with the marked points converges as a stable map. Let $u_{\infty,1} : \Sigma(\infty, 1) \rightarrow \mathbf{P}(\mathcal{N}_{\mathcal{D}}(X) \oplus \mathbb{C})$ be the limit.

Any irreducible component $\Sigma(\infty, 1)_h$ of $\Sigma(\infty, 1)$ such that $u_{\infty, 1}(\Sigma(\infty, 1)_h)$ is not contained in a fiber of $\mathbf{P}(\mathcal{N}_{\mathcal{D}}(X) \oplus \mathbb{C})$ corresponds to an irreducible component of Σ_w with $w \in G_{>0}$. This follows from convergence of ζ_a to ζ in the stable map topology. Therefore, if $\Sigma(\infty, 1)_h$ does not correspond to an irreducible component of Σ , then $(\pi \circ u_{\infty, 1})(\Sigma(\infty, 1)_h)$ should be a point where $\pi : \mathbf{P}(\mathcal{N}_{\mathcal{D}}(X) \oplus \mathbb{C}) \rightarrow \mathcal{D}$ is the projection map. Convergence of ζ_a to ζ in the stable map topology also implies that any irreducible component Σ_w with $w \in G_{>0}$ is in correspondence with a unique component $\Sigma(\infty, 1)_h$ of $\Sigma(\infty, 1)$.

Let $\Sigma(\infty, 1)_h$ be an irreducible component of $\Sigma(\infty, 1)$ with $u_{\infty, 1}(\Sigma(\infty, 1)_h)$ being not contained in a fiber of $\mathbf{P}(\mathcal{N}_{\mathcal{D}}(X) \oplus \mathbb{C})$. Let Σ_w , for $w \in G_{>0}$, be the corresponding component. We also assume that $u_{\infty, 1}(\Sigma(\infty, 1)_h)$ is not included in the zero section \mathcal{D}_0 of $\mathbf{P}(\mathcal{N}_{\mathcal{D}}(X) \oplus \mathbb{C})$. Then we define the level of w to be 1. We can also use the restriction of $u_{\infty, 1}$ to Σ_w to define a meromorphic section s_w of $\mathcal{N}_{\mathcal{D}}(X)$. Let G_1 be the set of all elements w of G with $\lambda(w) = 1$. Our choices of the constants $\rho_{a, 1}$ guarantee that G_1 is not an empty set.

We also write $G_{>1}$ for $G_{>0} \setminus G_1$. If $w \in G_{>1}$, then there is a corresponding component $\Sigma(\infty, 1)_h$ of $\Sigma(\infty, 1)$ whose image under $u_{\infty, 1}$ is contained in the section \mathcal{D}_0 . Let $w' \in G_1$ be chosen such that Σ_w and $\Sigma_{w'}$ share a nodal point p . Then the image of $\Sigma_{w'}$ by the map $u_{\infty, 1}$ intersects \mathcal{D}_0 at the point p . The value of the multiplicity function m at the point p is defined to be the order of tangency of this intersection. Thus we partially obtained the required objects in (I)-(IV). We repeat a similar construction to obtain a partition of $G_{>0}$ as follows:

$$G_{>0} = G_1 \sqcup G_2 \sqcup \dots$$

Since each G_i is non-empty, this process terminates in finitely many steps. Therefore, we construct the objects claimed in (I)-(IV). Using them, it is straightforward to construct an element $\hat{\zeta} \in \mathcal{M}_{k+1, h}^{\text{RGW}}(L; \beta)$ such that ζ_a are convergent to $\hat{\zeta}$. \square

Lemma 4.40. *For any integer k , there is a constant c such that the following claim holds. Suppose $h : [-T, T] \times S^1 \rightarrow \mathbb{C}$ satisfies*

$$(4.41) \quad \sum_{\ell=1}^k |\nabla^{\ell} h(\tau, t)| \leq C e^{-\delta(T-|\tau|)}.$$

Then there is a function $f : [-T, T] \times S^1 \rightarrow \mathbb{C}$ such that

$$(4.42) \quad \frac{df}{d\tau} + i \frac{df}{dt} = h$$

and

$$(4.43) \quad \sum_{\ell=1}^k |\nabla^{\ell} f(\tau, t)| \leq c \cdot C^2 \left(1 + \frac{1}{\delta^2}\right),$$

for any $\tau \in [-T + 1, T - 1]$.

Proof. Throughout the proof c is a positive constant which might increase from each line to the next one. Suppose that we have the following Fourier series presentation for the function h :

$$h(\tau, t) = \sum_{n=-\infty}^{\infty} \varphi_n(\tau) e^{2\pi i n t}.$$

The assumption implies that for any τ , we have

$$(4.44) \quad \sum_{n=-\infty}^{\infty} |\varphi_n(\tau)|^2 \leq c \cdot C^2 e^{-2\delta(T-|\tau|)}$$

Then we can take the function f to be

$$f(\tau, t) = \sum_{n=-\infty}^{\infty} \psi_n(\tau) e^{2\pi i n t}$$

where

$$\psi_n(\tau) := \begin{cases} -\int_{\tau}^T e^{2\pi n(\tau-s)} \varphi_n(s) ds & n > 0, \\ \int_0^{\tau} \varphi_0(s) ds & n = 0, \\ \int_{-T}^{\tau} e^{2\pi n(\tau-s)} \varphi_n(s) ds & n < 0. \end{cases}$$

One can easily see that for non-zero integer n , we have

$$\|\psi_n\|_{L^2([-T, T])}^2 \leq \frac{1}{4\pi|n|} \|\varphi_n\|_{L^2([-T, T])}^2,$$

and as a consequence of (4.44), we have

$$\|\psi_0\|_{L^2([-T, T])}^2 \leq c_0 \frac{C^2}{\delta^2}.$$

In summary, we have

$$\|f\|_{L^2} \leq c_0 C^2 \left(1 + \frac{1}{\delta^2}\right)$$

Now for any point $(\tau, t) \in [-T+1, T-1]$, the cylinder $(-\tau-1, \tau+1) \times S^1$ is a subspace of $[-T, T] \times S^1$, and we can use elliptic regularity to obtain the desired claim. \square

4.2.4. RGW Topology : Strips and Spheres. In this part, we give the definition of the RGW topology in several other cases. Since the definition is similar to the case of discs, we skip the details of the construction.

We first consider the case of strips. Let L_0, L_1 be Lagrangian submanifolds of $X \setminus D$ which intersect transversally. Let $p, q \in L_0 \cap L_1$, and form $\mathcal{M}_{k_1, k_0}^{\text{reg}}(L_1, L_0; p, q; \beta; \emptyset)$ as in Definition 3.80. We also consider the case that the pseudo-holomorphic strips have h interior marked points and denote the resulting moduli space by $\mathcal{M}_{k_1, k_0; h}^{\text{reg}}(L_1, L_0; p, q; \beta; \emptyset)$. The stable map compactification of this space, denoted by $\mathcal{M}_{k_1, k_0; h}(L_1, L_0; p, q; \beta; \emptyset)$, is defined in [FOOO09a, Subsection 3.8.8].

An element of the compactification is represented by $((\Sigma, \bar{z}^{(1)}, \bar{z}^{(0)}, \bar{z}^+), u)$ where Σ is the union of a line of strips, trees of disks attached to the sides of the strips, and trees of spheres attached to the interior of strips or disks. (See Figure 34.) The points $\bar{z}^{(1)} = (z_1^{(1)}, \dots, z_{k_1}^{(1)})$ are boundary marked points on one side of the boundary of strips, and $\bar{z}^{(0)} = (z_1^{(0)}, \dots, z_{k_0}^{(0)})$ are boundary marked points on the other side of the boundary of strips. (See Figure 34.) Moreover, \bar{z}^+ is an h -tuple of interior marked points, which lie on the interior of the disks, the strips and the spheres of Σ . Such configurations are described by an SD-tree \mathcal{R} as in Figure 24. The only difference is that we also need to include a marking map $\text{mk} : \{1, \dots, h\} \rightarrow C_0^{\text{ins}}(\mathcal{R})$. As in the previous subsection, we denote the pair (\mathcal{R}, mk) by \mathcal{R}^+ . The definition of the stable map topology is essentially the same as Definitions 4.8 and 4.10, and we omit it here.

Situation 4.45. *We consider the following situation.*

- (1) $\zeta_a = ((\Sigma(a), \bar{z}^{(1)}(a), \bar{z}^{(0)}(a), \bar{z}^+(a)), u_a) \in \mathcal{M}_{k_1, k_0; h}^{\text{reg}}(L_1, L_0; p, q; \beta; \emptyset)$.
- (2) $\zeta = (\zeta(v); v \in C_0^{\text{int}}(\hat{R})) \in \mathcal{M}^0(\mathcal{R}^+) \subset \mathcal{M}_{k_1, k_0; h}^{\text{RGW}}(L_1, L_0; p, q; \beta)$. *with the following components:*

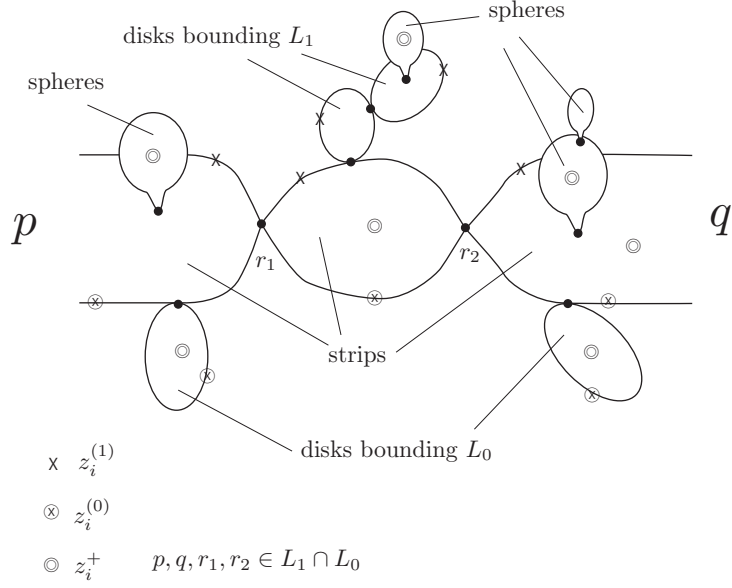
FIGURE 34. $((\Sigma, \bar{z}^{(1)}, \bar{z}^{(0)}, \bar{z}^+), u)$

- (a) If $c(v) = \text{str}$, then $\zeta(v) \in \mathcal{M}_{k_1, k_0; h_v}^{\text{reg}}(L_1, L_0; r(v), r'(v); \beta; \mathbf{m}_+^v)$. Here $r(v), r'(v) \in L_1 \cap L_0$ are points assigned to the two edges of C containing v .
- (b) If $c(v) = d_j$ ($j = 0, 1$), then $\zeta(v) \in \mathcal{M}_{k+1, h_v}^{\text{reg, d}}(L_j; \alpha(v); \mathbf{m}_+^v)$. We write $\zeta(v) = ((\Sigma(v), \bar{z}(v), \bar{z}^+(v), \bar{w}(v)), u_v)$.
- (c) If $c(v) = s$, then $\zeta(v)$ is an element of $\mathcal{M}_{h_v}^{\text{reg, s}}(\alpha(v); \mathbf{m}^v)$. We write $\zeta(v) = ((\Sigma(v), \bar{z}(v), \bar{z}^+(v), \bar{w}(v)), u_v)$.
- (d) If $c(v) = D$, then $\zeta(v) \in \widetilde{\mathcal{M}}_{h_v}^0(\mathcal{D} \subset X; \beta(v); \mathbf{m}^v)$. We write $\zeta(v) = ((\Sigma(v), \bar{z}^+(v), \bar{w}(v)); u_v; s_v)$.
- (3) We assume

$$\lim_{a \rightarrow \infty} \text{forget}(\zeta_a) = \text{forget}(\zeta).$$

Here the convergence is by the stable map topology.

- (4) We assume $\text{forget}(\zeta_a)$ and $\text{forget}(\zeta)$ are source stable.

We take an ε -trivialization (K, \mathcal{U}, Φ) in the same way as in Definition 4.2 and obtain the map $u'_{a,v}$ in the same way as in (4.23) for $a \in \mathbb{Z}_+$ and a vertex v with color D. We can also define a map $U_v : \Sigma_v \setminus \bar{w}(v) \rightarrow \mathcal{N}_{\mathcal{D}}(X) \setminus \mathcal{D}$ for any such vertex v in the same way as in (4.24). Now we define the notion of convergence $\lim_{a \rightarrow \infty} \zeta_a = \zeta$ analogous to Definition 4.26, and generalize this definition as in Definition 4.28 to define $\lim_{a \rightarrow \infty} \zeta_a = \zeta$ using forgetful maps. Finally we can prove the analogue of Proposition 4.29 for strips using a similar argument.

We next consider $\mathcal{M}_h^{\text{reg, s}}(\alpha; \emptyset)$ for $\alpha \in \Pi_2(X)$. We did not define the RGW compactification of this space in Section 3. However, by following an essentially the same construction as in the definition of $\mathcal{M}_{k+1, h}^{\text{RGW}}(L; \beta)$, we can define this RGW compactification denoted by $\mathcal{M}_h^{\text{RGW}}(\alpha; \emptyset)$. The main difference is that the root vertex has color s instead of d. The definition of the RGW topology is also similar. We can prove an the analogue of Proposition 4.29 in this case, too.

We finally define the RGW convergence of a sequence of elements of $\mathcal{M}^0(\mathcal{D} \subset X; \alpha; \emptyset)$ to an element of $\mathcal{M}(\mathcal{D} \subset X; \alpha; \emptyset)$. Let $X' = \mathbf{P}(\mathcal{N}_{\mathcal{D}}(X) \oplus \mathbb{C})$ and $\mathcal{D}' = \mathcal{D}_0 \cup \mathcal{D}_\infty$. Then $\mathcal{M}^0(\mathcal{D} \subset X; \alpha; \emptyset)$ (resp. $\mathcal{M}(\mathcal{D} \subset X; \alpha; \emptyset)$) can be identified with the quotient of the moduli space $\mathcal{M}^{\text{reg, s}}(\hat{\alpha}; \emptyset)$ associated to the pair (X', \mathcal{D}') (resp. $\mathcal{M}^{\text{RGW}}(\hat{\alpha}; \emptyset)$

associated to the pair (X', \mathcal{D}') with respect to the obvious \mathbb{C}_* action. Here $\hat{\alpha}$ is defined as in Subsection 3.3. Given a sequence $\zeta_a \in \mathcal{M}^0(\mathcal{D} \subset X; \alpha; \emptyset)$, represented by elements $\tilde{\zeta}_a \in \mathcal{M}^{\text{reg},s}(\hat{\alpha}; \emptyset)$, we say ζ_a converges to $\zeta \in \mathcal{M}(\mathcal{D} \subset X; \alpha; \emptyset)$, represented by $\tilde{\zeta} \in \mathcal{M}^{\text{RGW}}(\hat{\alpha}; \emptyset)$, if there are complex numbers z_a such that $z_a \cdot \zeta_a$ converges to ζ with respect to the notion of the convergence of the last paragraph. As in the previous cases, an analogue of Proposition 4.29 holds in this case. We can also generalize the discussion of this paragraph to the case that we include interior marked points and define the moduli space $\mathcal{M}_h(\mathcal{D} \subset X; \alpha; \emptyset)$.

Remark 4.46. In all three cases that we have discussed so far, we can replace \emptyset with \mathbf{m} without much change. That is to say, we can discuss convergence of a sequence of holomorphic maps which intersects the divisor in a prescribed way in all three cases and prove the analogues of Proposition 4.29.

4.2.5. *RGW topology: General Case.* We are ready to define the RGW convergence in the general case. We focus on the moduli space $\mathcal{M}_{k+1,h}^{\text{RGW}}(L; \beta)$. A similar discussion applies to the case of strips.

Suppose $\mathcal{R}^+ = (\mathcal{R}, \text{mk})$ and $(\mathcal{R}')^+ = (\mathcal{R}', \text{mk}')$ are DD-ribbon trees with interior marked points. We can define level shrinking and level 0 edge shrinking of such DD-ribbons as in Section 3. We write $(\mathcal{R}')^+ \geq \mathcal{R}^+$ if $(\mathcal{R}')^+$ is obtained from \mathcal{R}^+ by finitely many iterations of these operations.

Lemma 4.47. *Suppose $(\mathcal{R}')^+ \geq \mathcal{R}^+$, and $|\lambda|, |\lambda'|$ are the total numbers of levels of $\mathcal{R}^+, (\mathcal{R}')^+$. Suppose \hat{R}, \hat{R}' denote the detailed trees of $\mathcal{R}^+, (\mathcal{R}')^+$. Then there are a surjective and non-decreasing map $\text{levsh} : \{0, 1, \dots, |\lambda|\} \rightarrow \{0, 1, \dots, |\lambda'|\}$ and a surjective simplicial map $\text{treesh} : \hat{R} \rightarrow \hat{R}'$ with the following properties:*

(1) *If $v \in C_0^{\text{int}}(\hat{R})$, then*

$$\lambda'(\text{treesh}(v)) = \text{levsh}(\lambda(v)).$$

(2) *The inverse image of each vertex by treesh is connected.*

(3) *Let $v \in C_0^{\text{int}}(\hat{R}')$ be a vertex of level 0. If $\text{treesh}^{-1}(v)$ contains a vertex of color d , then the color of v is d . Otherwise, the color of v is s .*

(4) *treesh is bijective on the subset of exterior vertices and exterior edges.*

Proof. This is obvious in the case of $(i, i+1)$ level shrinking and shrinking of a single level 0 edge. For a composition of level shrinking and level 0 edge shrinking operations, we can also use the composition of the corresponding maps treesh and levsh . Moreover, the properties in (1)-(4) are preserved by the composition. \square

Now we consider the following situation:

Situation 4.48. *Suppose $(\mathcal{R}')^+ \geq \mathcal{R}^+$ and $\text{treesh}, \text{levsh}$ are as in Lemma 4.47. Let $\zeta_a \in \mathcal{M}^0((\mathcal{R}')^+)$ be a sequence and $\zeta \in \mathcal{M}^0(\mathcal{R}^+)$. Let $\tilde{\zeta}_a \in \tilde{\mathcal{M}}^0((\mathcal{R}')^+)$ and $\tilde{\zeta} \in \tilde{\mathcal{M}}^0(\mathcal{R}^+)$ denote elements representing ζ_a and ζ , respectively. We write*

$$\tilde{\zeta} = (\zeta(v)), \quad \tilde{\zeta}_a = (\zeta_a(v')),$$

where v belongs to $C_0^{\text{int}}(\hat{R})$ (resp. v' belongs to $C_0^{\text{int}}(\hat{R}')$) and $\zeta(v) \in \tilde{\mathcal{M}}^0(\mathcal{R}^+, v)$ (resp. $\zeta_a(v') \in \tilde{\mathcal{M}}^0((\mathcal{R}')^+, v')$). We require that $\text{forget}(\zeta_a)$ converges to $\text{forget}(\zeta)$ in the stable map topology. Furthermore, we assume ζ_a, ζ are source stable.

For ζ_a and ζ as in Situation 4.48, we wish to explain when ζ_a converges to ζ in the RGW topology. We firstly need to introduce some notations:

- (1) For $v \in C_0^{\text{int}}(\hat{R})$, if $c(v) = \text{d}$, then $\zeta(v) \in \mathcal{M}_{k+1, h_v}^{\text{reg, d}}(\alpha(v); \mathbf{m}^v)$, and we write $\zeta(v) = ((\Sigma(v), \bar{z}(v), \bar{z}^+(v), \bar{w}(v)), u_v)$. For $v' \in C_0^{\text{int}}(\hat{R}')$, if $c(v') = \text{d}$, then $\zeta_a(v') \in \mathcal{M}_{k+1, h_{v'}}^{\text{reg, d}}(\alpha(v'); \mathbf{m}^{v'})$, and we write $\zeta_a(v') = ((\Sigma_a(v'), \bar{z}_a(v'), \bar{z}_a^+(v'), \bar{w}_a(v')), u_{a, v'})$.
- (2) For $v \in C_0^{\text{int}}(\hat{R})$, if $c(v) = \text{s}$, then $\zeta(v) \in \mathcal{M}_{h_v}^{\text{reg, s}}(\alpha(v); \mathbf{m}^v)$, and we write $\zeta(v) = ((\Sigma(v), \bar{z}(v), \bar{z}^+(v), \bar{w}(v)), u_v)$. For $v' \in C_0^{\text{int}}(\hat{R}')$, if $c(v') = \text{s}$, then $\zeta_a(v') \in \mathcal{M}_{h_{v'}}^{\text{reg, s}}(\alpha(v'); \mathbf{m}^{v'})$, and we write $\zeta_a(v') = ((\Sigma_a(v'), \bar{z}_a(v'), \bar{z}_a^+(v'), \bar{w}_a(v')), u_{a, v'})$.
- (3) For $v \in C_0^{\text{int}}(\hat{R})$, if $c(v) = \text{D}$, then $\zeta(v) \in \widetilde{\mathcal{M}}_{h_v}^0(\mathcal{D} \subset X; \beta(v); \mathbf{m}^v)$, and we write $\zeta(v) = ((\Sigma(v), \bar{z}^+(v), \bar{w}(v)); u_v; s_v)$. For $v' \in C_0^{\text{int}}(\hat{R}')$, if $c(v') = \text{D}$, then $\zeta_a(v')$ is an element of $\widetilde{\mathcal{M}}_{h_{v'}}^0(\mathcal{D} \subset X; \beta(v'); \mathbf{m}^{v'})$, and we write $\zeta_a(v') = ((\Sigma_a(v'), \bar{z}_a^+(v'), \bar{w}_a(v')); u_{a, v'}; s_{a, v'})$.
- (4) For $v' \in C_0^{\text{int}}(\hat{R}')$, we define:

$$\hat{R}(v') = \text{treesh}^{-1}(v') \subset \hat{R}.$$

For a sufficiently small ε , we take an ε -trivialization (K, \mathcal{U}, Φ) of the universal family at the source curve ξ of ζ in the sense of Definition 4.8. For $v \in C_0^{\text{int}}(\hat{R})$, we define

$$K(v) = K \cap \Sigma(v).$$

Suppose $v \in \hat{R}(v')$ with $v' \in C_0^{\text{int}}(\hat{R}')$. If a is large enough, then we may regard $K(v) \subset \Sigma_a(v')$ by $z \mapsto \Phi(z, \xi_a)$, where ξ_a is the source curve of $\text{forget}(\zeta_a)$. (See Figure 35.) By Definition 4.8 (3), $\tilde{u}_{a, v}(z) := u_{a, v'}(\Phi(z, \xi_a))$ converges to u_v in C^2 topology on $K(v)$. We denote by $\tilde{u}_{a, v}$ the restriction of $\tilde{u}_{a, v'}$ to $K(v)$.

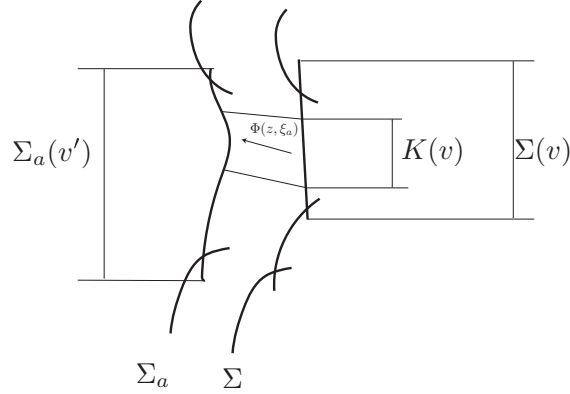

FIGURE 35. $K(v)$ and $\Sigma_a(v')$

Suppose $c(v) = \text{D}$ and $c(v') = \text{s}$ or d . Then for sufficiently large a , we may assume that for any z in $K(v)$, we have $\tilde{u}_{a, v}(z) \in \mathcal{N}_{\mathcal{D}}^{\leq c}(X)$ in the same sense as in (4.22). Thus $\tilde{u}_{a, v}$ may be regarded as a map of the following form

$$(4.49) \quad \tilde{u}_{a, v} : K(v) \rightarrow \mathcal{N}_{\mathcal{D}}(X).$$

We also regard the section s_v of $u_v^* \mathcal{N}_{\mathcal{D}}(X)$ as a map

$$(4.50) \quad U_v : \Sigma_v \setminus \bar{w}(v) \rightarrow \mathcal{N}_{\mathcal{D}}(X) \setminus \mathcal{D}$$

If $c(v') = \text{D}$, then we use $s_{a, v'}$ and $\tilde{u}_{a, v}$ to obtain

$$(4.51) \quad \tilde{U}_{a, v} : K(v) \rightarrow \mathcal{N}_{\mathcal{D}}(X).$$

Note that in this case $c(v) = \text{D}$ automatically.

Definition 4.52. We say that ζ_a converges to ζ and write

$$\lims_{a \rightarrow \infty} \zeta_a = \zeta,$$

if for each $j \in \{1, \dots, |\lambda|\}$, there is a sequence $\rho_{a,j} \in \mathbb{C}_*$ and for each $\varepsilon > 0$, there exist an ε -trivialization as above and an integer $N(\varepsilon)$ such that the following properties hold for any $v \in C_0^{\text{int}}(\hat{R})$ and $a \geq N(\varepsilon)$:

(1) Suppose $c(v) = D$ and $c(v') = s$ or d with $\text{treesh}(v) = v'$. Then:

$$d_{C^2} \left(\text{Dil}_{1/\rho_{a,\lambda(v)}} \circ \tilde{u}_{a,v}, U_v \right) < \varepsilon.$$

(2) Suppose $c(v) = D$ and $c(v') = D$ with $\text{treesh}(v) = v'$. Then:

$$d_{C^2} \left(\text{Dil}_{1/\rho_{a,\lambda(v)}} \circ \tilde{U}_{a,v}, U_v \right) < \varepsilon.$$

(3) If $j < j'$ and $\text{levsh}(j) = \text{levsh}(j')$, then

$$\lim_{a \rightarrow \infty} \frac{\rho_{a,j}}{\rho_{a,j'}} = \infty.$$

This definition is very similar to Definition 4.26. The only difference is $\zeta_a \in \mathcal{M}^0(\mathcal{R}')$ and it may have several levels. We need to define convergence for each level. In Definition 4.52, we use the identification in (4.25) and the product metric on $\mathcal{N}_{\mathcal{D}}(X) \setminus \mathcal{D}$ to define C^2 norms in Items (1) and (2).

Analogous to Definition 4.28, we can extend the definition of convergence to the case that the source curves of ζ_a and ζ may not be stable. Finally we can include the case when $\zeta_a \in \mathcal{M}^0(\mathcal{R}'_a)$ where \mathcal{R}'_a varies, using the fact that there is only a finite number of \mathcal{R}' with $\mathcal{R}' \geq \mathcal{R}$. This completes the definition of convergence with respect to the RGW topology. If ζ_a converges to ζ in this topology, we write:

$$(4.53) \quad \lim_{a \rightarrow \infty} \zeta_a = \zeta.$$

Lemma 4.54. For any sequence $\zeta_a \in \mathcal{M}_{k+1,h}^{\text{RGW}}(L; \beta)$, there exists a subsequence which converges in the sense of (4.53).

Proof. This is a consequence of Proposition 4.29 and similar results for strips and spheres. \square

Definition 4.55. Let $A \subset \mathcal{M}_{k+1,h}^{\text{RGW}}(L; \beta)$. Define the closure of A , denoted by A^c , to be the set of all the limits of sequences of elements of A in the sense of (4.53).

Lemma 4.56. The closure operator c satisfies the Kuratowsky's axioms. Namely, (a) $\emptyset^c = \emptyset$, (b) $A \subseteq A^c$, (c) $(A^c)^c = A^c$ and (d) $(A \cup B)^c = A^c \cup B^c$.

Proof. (a), (b) and (d) are obvious. In order to check (c), let $\zeta_{a,b}, \zeta_a, \zeta \in \mathcal{M}_{k+1,h}^{\text{RGW}}(L; \beta)$ for $a, b \in \mathbb{Z}_+$. We assume

$$(4.57) \quad \lim_{b \rightarrow \infty} \zeta_{a,b} = \zeta_a, \quad \lim_{a \rightarrow \infty} \zeta_a = \zeta.$$

It suffices to prove that there exists $b(a)$ such that $\lim_{a \rightarrow \infty} \zeta_{a,b(a)} = \zeta$.

Using a result similar to Lemma 4.11 (which can be proved in the same way), we may assume that $\zeta_{a,b}, \zeta_a, \zeta$ are all source stable and replace \lim by \lims . Since for each DD-ribbon tree \mathcal{R}^+ , there are only finitely many DD-ribbon trees $(\mathcal{R}')^+$ with $(\mathcal{R}')^+ \geq \mathcal{R}^+$, we may also assume that there are DD-ribbon trees $\mathcal{R}, \mathcal{R}', \mathcal{R}''$ such that $\mathcal{R}'' \geq \mathcal{R}' \geq \mathcal{R}$ and

$$\zeta_{a,b} \in \mathcal{M}^0(\mathcal{R}''), \quad \zeta_a \in \mathcal{M}^0(\mathcal{R}'), \quad \zeta \in \mathcal{M}^0(\mathcal{R}).$$

Moreover, Lemma 4.47 provides us with $\text{levsh} : \{0, \dots, |\lambda|\} \rightarrow \{0, \dots, |\lambda'|\}$, $\text{levsh}' : \{0, \dots, |\lambda'|\} \rightarrow \{0, \dots, |\lambda''|\}$, $\text{treesh} : \hat{R} \rightarrow \hat{R}'$ and $\text{treesh}' : \hat{R}' \rightarrow \hat{R}''$.

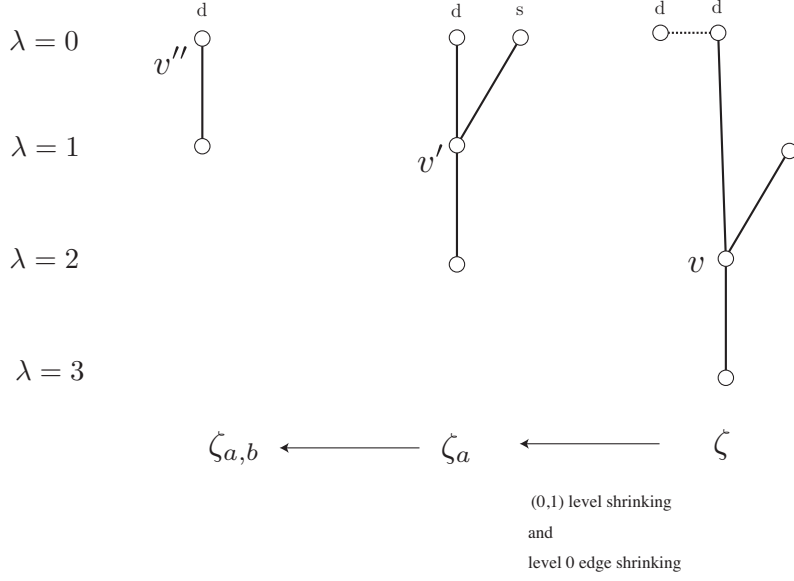

FIGURE 36. $\zeta_{a,b}, \zeta_a, \zeta$ (graph)

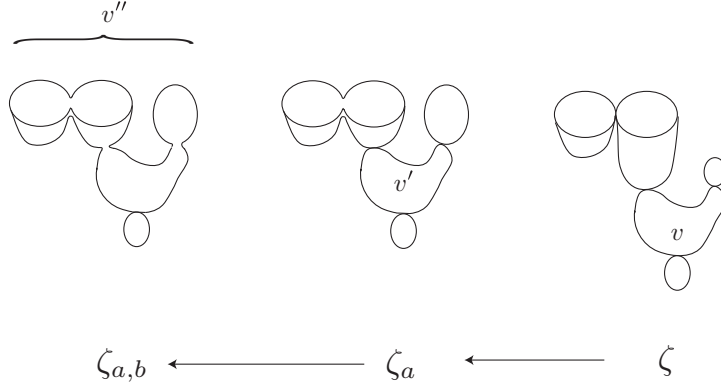

FIGURE 37. $\zeta_{a,b}, \zeta_a, \zeta$

The assumptions in (4.57) gives us non-zero complex numbers $\rho_{a,j}$ and $\rho_{ab,j'}$ where $1 \leq j \leq |\lambda|$ and $1 \leq j' \leq |\lambda'|$. We denote these numbers with $\rho_{a,\emptyset;j}$ and $\rho_{ab,a;j'}$ to distinguish them from $\rho_{ab,\emptyset;j}$ which shall be introduced momentarily to prove $\lim_{a \rightarrow \infty} \zeta_{a,b(a)} = \zeta$. We extend these constants to the case that $j = 0$ and $j' = 0$ by setting $\rho_{a,\emptyset;0} = \rho_{ab,a;0} = 1$.

Now we define

$$(4.58) \quad \rho_{ab,\emptyset;j} = \rho_{a,\emptyset;j} \cdot \rho_{ab,a;\text{levsh}(j)} \in \mathbb{C}_*.$$

For each a , there is an integer $N(a)$ such that if $b \geq N(a)$, then for any k, k' with $0 \leq k < k' \leq |\lambda'|$ and $\text{levsh}'(k) = \text{levsh}'(k')$, we have:

$$\left| \frac{\rho_{ab,a;k}}{\rho_{ab,a;k'}} \right| \geq a \cdot \max_{0 \leq j' < j \leq |\lambda|} \left(\left| \frac{\rho_{a,\emptyset;j}}{\rho_{a,\emptyset;j'}} \right| \right)$$

Thus it is easy to see that if $b(a) \geq N(a)$, then we can conclude for $j < j'$ with $\text{levsh}' \circ \text{levsh}(j) = \text{levsh}' \circ \text{levsh}(j')$ that:

$$\lim_{a \rightarrow \infty} \frac{\rho_{ab(a),\emptyset;j}}{\rho_{ab(a),\emptyset;j'}} = \infty.$$

Next, we show that Definition 4.52 (1) and (2) are satisfied for appropriate choices of $b(a) \geq N(a)$.

Let $v \in C_0^{\text{int}}(\hat{R})$, $v' = \text{treesh}(v)$, $v'' = \text{treesh}'(v')$, $j = \lambda(v)$ and $j' = \lambda'(v')$. We also assume that $c(v) = D$, $c(v') = D$ and $c(v'') = d$. We also fix an ε -trivialization (K, \mathcal{U}, Φ) of the universal family in the sense of Definition 4.8 at the source curve ξ of ζ . Let $U_v : \Sigma(v) \rightarrow \mathcal{N}_{\mathcal{D}}(X)$ be defined from the data of ζ in the same way as in (4.50). We define $\tilde{U}_{a,v} : K(v) \rightarrow \mathcal{N}_{\mathcal{D}}(X)$ analogous to (4.51). Finally, we define $\tilde{u}_{ab,v} : K(v) \rightarrow \mathcal{N}_{\mathcal{D}}(X)$ from the data of ζ_{ab} as in (4.49).

By assumption

$$(4.59) \quad d_{C^2} \left(\text{Dil}_{1/\rho_{a,\emptyset;j}} \circ \tilde{U}_{a,v}, U_v \right) < \delta$$

for sufficiently large a and

$$(4.60) \quad d_{C^2} \left(\text{Dil}_{1/\rho_{ab,a;j'}} \circ \tilde{u}_{ab,v}, U'_{a,v'} \right) < \frac{1}{a}$$

if b is a large integer depending on a . We denote one such b by $b(a)$, which is also greater than $N(a)$. Since Dil_c is an isometry, these two inequalities imply

$$d_{C^2} \left(\text{Dil}_{1/\rho_{ab(a),\emptyset;j}} \circ \tilde{u}_{ab(a),v}, U_v \right) < 2\delta$$

if a is large enough so that (4.59) and (4.60) hold and $\frac{1}{a} < \delta$. This verifies Definition 4.52 (1) in the case $c(v) = D$, $c(v') = D$ and $c(v'') = d$. The other cases and Definition 4.52 (2) can be proved in the same way. \square

The above lemma completes the definition of the RGW topology. The following theorem asserts that the RGW topology has the desired properties in the case of moduli spaces of discs.

Theorem 4.61. *The topological space $\mathcal{M}_{k+1,h}^{\text{RGW}}(L; \beta)$ is compact and metrizable. Evaluation at any of the boundary marked points (resp. interior marked points) determines a continuous map $\mathcal{M}_{k+1,h}^{\text{RGW}}(L; \beta) \rightarrow L$ (resp. $\mathcal{M}_{k+1,h}^{\text{RGW}}(L; \beta) \rightarrow X$). Moreover, for any DD-ribbon tree \mathcal{R}^+ , the space*

$$(4.62) \quad \mathcal{M}(\mathcal{R}^+) := \mathcal{M}^0(\mathcal{R}^+) \cup \bigcup_{(R')^+ \prec \mathcal{R}^+} \mathcal{M}^0((R')^+).$$

is a closed subset of $\mathcal{M}_{k+1,h}^{\text{RGW}}(L; \beta)$.

Proof. Suppose \mathcal{R} is a DD-ribbon tree of type (β, k) with detailed ribbon tree \hat{R} . Suppose also $\text{mk} : \{1, \dots, h\} \rightarrow C_0^{\text{int}}(\hat{R})$ is a marking map for interior points. Then $\mathcal{R}^+ := (\mathcal{R}, \text{mk})$ describes a stratum of $\mathcal{M}_{k+1,h}^{\text{RGW}}(L; \beta)$, and we assume that ζ_0 is a source stable element of this stratum. We wish to construct a countable neighborhood basis for ζ_0 .

We fix a $\frac{1}{n}$ -trivialization (K, \mathcal{U}, Φ) of the universal family at ζ_0 . We define $B_n(\zeta_0)$ to be the set of the elements ζ of $\mathcal{M}_{k+1,h}^{\text{RGW}}(L; \beta)$, which satisfy the following properties:

- (i) There is a DD-ribbon tree $(\mathcal{R}')^+$ such that $\zeta \in \mathcal{M}^0((\mathcal{R}')^+)$ and $(\mathcal{R}')^+ \geq \mathcal{R}^+$. Suppose a representative $\tilde{\zeta} = (\zeta(v'))$ is fixed for ζ .
- (ii) The source curve of ζ belongs to \mathcal{U} .
- (iii) The distance between the stable maps $\text{forget}(\zeta_0)$ and $\text{forget}(\zeta)$ with respect to a fixed metric representing the stable map topology is less than $\frac{1}{n}$.
- (iv) For each $v \in C_0^{\text{int}}(\hat{R}^+)$, we define $K(v)$ in the same way as in (4.21). Let $|\lambda|$ be the number of the levels of \mathcal{R}^+ . Then for each $0 \leq j \leq |\lambda|$, there is a constant ρ_j such that the following conditions are satisfied.

- (1) Let $c(v) = \mathbb{D}$, $c(v') = \mathbb{s}$ or \mathbb{d} with $\text{treesh}(v) = v'$. We define $\tilde{u}_v : K(v) \rightarrow \mathcal{N}_{\mathcal{D}}(X)$ and $U_v : \Sigma(v) \rightarrow \mathcal{N}_{\mathcal{D}}(X)$ as in (4.49) and (4.50). Then the C^2 -distance of $\text{Dil}_{1/\rho_{\lambda(v)}} \circ \tilde{u}_v$ and U_v is less than $\frac{1}{n}$.
- (2) Let $c(v) = \mathbb{D}$, $c(v') = \mathbb{D}$ with $\text{treesh}(v) = v'$. We define $\tilde{U}_v : K(v) \rightarrow \mathcal{N}_{\mathcal{D}}(X)$ and $U_v : \Sigma(v) \rightarrow \mathcal{N}_{\mathcal{D}}(X)$ as in (4.51) and (4.50). Then the C^2 -distance of $\text{Dil}_{1/\rho_{\lambda(v)}} \circ \tilde{U}_v$ and U_v is less than $\frac{1}{n}$.
- (3) $\rho_0 = 1$ and for $1 \leq j \leq |\lambda|$ with $\text{levsh}(j) = \text{levsh}(j-1)$, we have $\rho_j > n \cdot \rho_{j-1}$.

It is easy to see that $B_n(\zeta_0)$ is an open set containing ζ . Moreover, any open neighborhood of ζ_0 contains $B_n(\zeta_0)$ for large values of n . Using the by now familiar trick of forgetting interior marked points, we can extend this construction for any point $\zeta_0 \in \mathcal{M}_{k+1,h}^{\text{RGW}}(L; \beta)$. Thus $\mathcal{M}_{k+1,h}^{\text{RGW}}(L; \beta)$ is a first countable topological space.

The topology of each stratum of $\mathcal{M}_{k+1,h}^{\text{RGW}}(L; \beta)$ is given by the stable map topology. In particular, it is a separable metric space. Since there are also countably many strata, we can form a sequence $\{\zeta_i\}$ of the elements such that the subsequence of the elements belonging to a given stratum forms a dense subset. Then it is easy to see that $\{B_n(\zeta_i)\}$ gives a countable basis for the RGW topology of $\mathcal{M}_{k+1,h}^{\text{RGW}}(L; \beta)$. Since $\mathcal{M}_{k+1,h}^{\text{RGW}}(L; \beta)$ is sequentially compact (Lemma 4.54) and second countable, it is a compact topological space.

Next we show that $\mathcal{M}_{k+1,h}^{\text{RGW}}(L; \beta)$ is Hausdorff. Since the first axiom of countability is satisfied, it suffices to show that any convergent sequence has a unique limit. Let ζ_a be a sequence which converges to both ζ and ζ' . The stable maps $\text{forget}(\zeta)$ and $\text{forget}(\zeta')$ are equal to each other, because the stable map topology is Hausdorff ([FO99, Lemma 10.4]). Using a lemma similar to Lemma 4.11, we may assume that ζ_a, ζ, ζ' are all source stable. In this case, it is straightforward to see that $\zeta = \zeta'$.

The space $\mathcal{M}_{k+1,h}^{\text{RGW}}(L; \beta)$ is compact and Hausdorff, hence it is a regular space. Therefore, Urysohn's metrization theorem implies that $\mathcal{M}_{k+1,h}^{\text{RGW}}(L; \beta)$ is metrizable.

The claim about continuity of evaluation maps at the marked points follows from the facts that the RGW topology is stronger than the stable map topology and these evaluation maps are continuous with respect to the stable map topology. Finally it is an immediate consequence of the definition that the space in (4.64) is closed. \square

One can prove similar results as in the above theorem for the case of strips and spheres with the same arguments.

Theorem 4.63. *The topological space $\mathcal{M}_{k_1, k_0, h}^{\text{RGW}}(L_1, L_0; p, q; \beta)$ is compact and metrizable. Evaluation at any of the boundary or interior marked points determines a continuous map. Moreover, for any SD-ribbon tree \mathcal{R}^+ , the space*

$$(4.64) \quad \mathcal{M}(\mathcal{R}^+) := \mathcal{M}^0(\mathcal{R}^+) \cup \bigcup_{(R')^+ < \mathcal{R}^+} \mathcal{M}^0((R')^+).$$

is a closed subspace of $\mathcal{M}_{k_1, k_0, h}^{\text{RGW}}(L_1, L_0; p, q; \beta)$.

Theorem 4.65. *The topological space $\mathcal{M}(\mathcal{D} \subset X; \alpha; \mathbf{m})$ is compact and metrizable. Evaluation at any of the (interior) marked points determines a continuous map from the moduli space to \mathcal{D} . There also exists a continuous map*

$$(4.66) \quad \text{forget} : \mathcal{M}(\mathcal{D} \subset X; \alpha; \mathbf{m}) \rightarrow \mathcal{M}_{\ell+1}(\mathcal{D}; \alpha).$$

such that it coincides with (3.22) on $\mathcal{M}^0(\mathcal{T}_{\alpha; \mathbf{m}}^0)$ via the identification (3.47). Moreover, for any decorated rooted tree \mathcal{T} , the space

$$(4.67) \quad \mathcal{M}(\mathcal{D}; \mathcal{T}) := \mathcal{M}^0(\mathcal{D}; \mathcal{T}) \cup \bigcup_{\mathcal{T}' < \mathcal{T}} \mathcal{M}^0(\mathcal{D}; \mathcal{T}')$$

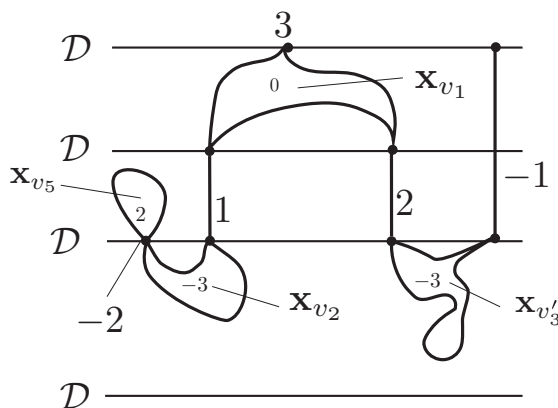

FIGURE 38. Configuration associated to the decorated rooted tree in Figure 9

is a closed subspace of $\mathcal{M}(\mathcal{D} \subset X; \alpha; \mathbf{m})$.

Proof. To prove existence of (4.66), let $(\mathbf{x}_v; v \in C_0^{\text{ins}}(T)) \in \widetilde{\mathcal{M}}^0(D; \mathcal{T})$ where $\mathbf{x}_v = [(\Sigma_v, \vec{w}_v); u_v; s_v]$. We glue (Σ_v, \vec{w}_v) along the tree T in an obvious way to obtain a marked Riemann surface (Σ, \vec{w}) . Since an element $(\mathbf{x}_v; v \in C_0^{\text{ins}}(T))$ lies in the fiber product (3.37), various maps u_v can be glued to define a continuous map $u : \Sigma \rightarrow \mathcal{D}$. We thus obtain an element of $\mathcal{M}_{\ell+1}(\mathcal{D}; \alpha)$. It is easy to see that this construction induces a map as in (4.66). The continuity of the map (4.66) is immediate from the definition of the RGW topology. The remaining claims can be verified in the same way as in Theorem 4.61. \square

Example 4.68. Figure 38 sketches an element of $\mathcal{M}^0(D; \mathcal{T})$ corresponding to the decorated rooted tree in Figure 9. This element of the moduli space is obtained from Figure 8 by resolving the double point which is the intersection of \mathbf{x}_{v_3} and \mathbf{x}_{v_4} . The new component $\mathbf{x}_{v'_3}$ in Figure 38 is obtained by this gluing construction.

Remark 4.69. Using Lemma 3.25, the restriction of the map in (4.66) gives an open embedding from $\mathcal{M}^0(\mathcal{D} \subset X; \alpha; \mathbf{m})$ into $\mathcal{M}_{\ell+1}^0(\mathcal{D}; \alpha)$. A standard dimension formula from Gromov-Witten theory shows that the virtual dimension of $\mathcal{M}_{\ell+1}^0(\mathcal{D}; \alpha)$ is equal to

$$(4.70) \quad c_1(\mathcal{D}) \cdot \alpha + 2 \dim_{\mathbb{C}} X + 2(\ell + 1) - 8.$$

To be more precise, the compact space $\mathcal{M}_{\ell+1}(\mathcal{D}; \alpha)$ admits a Kuranishi structure (without boundary) whose dimension is given in (4.70) [FO99]. In the subsequent paper of this series, we define a Kuranishi structure on $\mathcal{M}(\mathcal{D} \subset X; \alpha; \mathbf{m})$ such that its restriction to the open subspace $\mathcal{M}^0(\mathcal{D} \subset X; \alpha; \mathbf{m})$ agrees with the Kuranishi structure of $\mathcal{M}_{\ell+1}(\mathcal{D}; \alpha)$ via the homeomorphism **forget** in (4.66). (The relationship between the map **forget** and the Kuranishi structures on the compactifications is more delicate.) In particular, the dimension of $\mathcal{M}(\mathcal{D} \subset X; \alpha; \mathbf{m})$ is also given by the formula in (4.70).

REFERENCES

- [ACG11] Enrico Arbarello, Maurizio Cornalba, and Phillip A. Griffiths, *Geometry of algebraic curves. Volume II*, Grundlehren der mathematischen Wissenschaften [Fundamental Principles of Mathematical Sciences], vol. 268, Springer, Heidelberg, 2011. With a contribution by Joseph Daniel Harris. MR2807457 [↑37](#)
- [AJ10] Manabu Akaho and Dominic Joyce, *Immersed Lagrangian Floer theory*, J. Differential Geom. **86** (2010), no. 3, 381–500. MR2785840 [↑1](#)

- [ALP94] Michèle Audin, François Lalonde, and Leonid Polterovich, *Symplectic rigidity: Lagrangian submanifolds*, Holomorphic curves in symplectic geometry, 1994, pp. 271–321. MR1274934 ↑1
- [BC09] Paul Biran and Octav Cornea, *Rigidity and uniruling for Lagrangian submanifolds*, *Geom. Topol.* **13** (2009), no. 5, 2881–2989. MR2546618 ↑2
- [BEH⁺03] F. Bourgeois, Y. Eliashberg, H. Hofer, K. Wysocki, and E. Zehnder, *Compactness results in symplectic field theory*, *Geom. Topol.* **7** (2003), 799–888. MR2026549 ↑15
- [CV15] Kai Cieliebak and Evgeny Volkov, *First steps in stable Hamiltonian topology*, *J. Eur. Math. Soc. (JEMS)* **17** (2015), no. 2, 321–404. MR3317746 ↑15
- [DF18a] Aliakbar Daemi and Kenji Fukaya, *Atiyah-Floer conjecture: a formulation, a strategy of proof and generalizations*, *Modern geometry: a celebration of the work of Simon Donaldson*, 2018, pp. 23–57. MR3838878 ↑3
- [DF18b] ———, *Monotone Lagrangian Floer theory in smooth divisor complements: II*, arXiv, 2018. ↑3, 8, 9, 19, 33, 35, 38, 39
- [DF18c] ———, *Monotone Lagrangian Floer theory in smooth divisor complements: III*, 2018. ↑2, 3, 8, 9, 11, 17, 19, 33, 35, 42
- [Flo88] Andreas Floer, *Morse theory for Lagrangian intersections*, *J. Differential Geom.* **28** (1988), no. 3, 513–547. MR965228 ↑1, 2
- [Flo89] ———, *Witten’s complex and infinite-dimensional Morse theory*, *J. Differential Geom.* **30** (1989), no. 1, 207–221. MR1001276 ↑2
- [FO99] Kenji Fukaya and Kaoru Ono, *Arnold conjecture and Gromov-Witten invariant*, *Topology* **38** (1999), no. 5, 933–1048. MR1688434 ↑36, 38, 39, 43, 56, 57
- [FOOO09a] Kenji Fukaya, Yong-Geun Oh, Hiroshi Ohta, and Kaoru Ono, *Lagrangian intersection Floer theory: anomaly and obstruction. Part I*, *AMS/IP Studies in Advanced Mathematics*, vol. 46, American Mathematical Society, Providence, RI; International Press, Somerville, MA, 2009. MR2553465 ↑1, 2, 3, 36, 38, 49
- [FOOO09b] ———, *Lagrangian intersection Floer theory: anomaly and obstruction. Part II*, *AMS/IP Studies in Advanced Mathematics*, vol. 46, American Mathematical Society, Providence, RI; International Press, Somerville, MA, 2009. MR2548482 ↑1, 3, 6, 20, 36
- [FOOO12] ———, *Technical details on Kuranishi structure and virtual fundamental chain*, arXiv, 2012. ↑38
- [FOOO15] ———, *Kuranishi structure, pseudo-holomorphic curve, and virtual fundamental chain: Part 1*, arXiv, 2015. ↑2, 6
- [FOOO16] ———, *Exponential decay estimates and smoothness of the moduli space of pseudoholomorphic curves*, to appear in *Memoirs of the AMS*, arXiv, 2016. ↑38
- [FOOO18] ———, *Construction of Kuranishi structures on the moduli spaces of pseudo holomorphic disks: I*, *Surveys in differential geometry 2017. Celebrating the 50th anniversary of the Journal of Differential Geometry*, 2018, pp. 133–190. MR3838117 ↑38
- [Fuk17] Kenji Fukaya, *Unobstructed immersed Lagrangian correspondence and filtered A_∞ functor*, arXiv, 2017. ↑38, 39
- [Gro85] M. Gromov, *Pseudo holomorphic curves in symplectic manifolds*, *Invent. Math.* **82** (1985), no. 2, 307–347. MR809718 ↑36
- [GS13] Mark Gross and Bernd Siebert, *Logarithmic Gromov-Witten invariants*, *J. Amer. Math. Soc.* **26** (2013), no. 2, 451–510. MR3011419 ↑8
- [IP03] Eleny-Nicoleta Ionel and Thomas H. Parker, *Relative Gromov-Witten invariants*, *Ann. of Math. (2)* **157** (2003), no. 1, 45–96. MR1954264 ↑8, 11
- [IP04] ———, *The symplectic sum formula for Gromov-Witten invariants*, *Ann. of Math. (2)* **159** (2004), no. 3, 935–1025. MR2113018 ↑8
- [Kon95a] Maxim Kontsevich, *Enumeration of rational curves via torus actions*, *The moduli space of curves (Texel Island, 1994)*, 1995, pp. 335–368. MR1363062 ↑36
- [Kon95b] ———, *Homological algebra of mirror symmetry*, *Proceedings of the International Congress of Mathematicians, Vol. 1, 2 (Zürich, 1994)*, 1995, pp. 120–139. MR1403918 ↑1
- [Li01] Jun Li, *Stable morphisms to singular schemes and relative stable morphisms*, *J. Differential Geom.* **57** (2001), no. 3, 509–578. MR1882667 ↑8
- [Li02] ———, *A degeneration formula of GW-invariants*, *J. Differential Geom.* **60** (2002), no. 2, 199–293. MR1938113 ↑8
- [LR01] An-Min Li and Yongbin Ruan, *Symplectic surgery and Gromov-Witten invariants of Calabi-Yau 3-folds*, *Invent. Math.* **145** (2001), no. 1, 151–218. MR1839289 ↑8, 42

- [MS98] Dusa McDuff and Dietmar Salamon, *Introduction to symplectic topology*, Second, Oxford Mathematical Monographs, The Clarendon Press, Oxford University Press, New York, 1998. MR1698616 ↑11
- [MW12] Ciprian Manolescu and Christopher Woodward, *Floer homology on the extended moduli space*, Perspectives in analysis, geometry, and topology, 2012, pp. 283–329. MR2884041 ↑2, 3
- [Oh93] Yong-Geun Oh, *Floer cohomology of Lagrangian intersections and pseudo-holomorphic disks. I*, Comm. Pure Appl. Math. **46** (1993), no. 7, 949–993. MR1223659 ↑1, 2, 3, 6
- [Oh96] ———, *Floer cohomology, spectral sequences, and the Maslov class of Lagrangian embeddings*, Internat. Math. Res. Notices **7** (1996), 305–346. MR1389956 ↑2
- [Par12] Brett Parker, *Exploded manifolds*, Adv. Math. **229** (2012), no. 6, 3256–3319. MR2900440 ↑8
- [Par13] ———, *Holomorphic curves in exploded manifolds: Kuranishi structure*, arXiv, 2013. ↑8
- [Par15] ———, *Holomorphic curves in exploded manifolds: compactness*, Adv. Math. **283** (2015), 377–457. MR3383807 ↑8
- [Par19a] ———, *Holomorphic curves in exploded manifolds: regularity*, Geom. Topol. **23** (2019), no. 4, 1621–1690. MR3988088 ↑8
- [Par19b] ———, *Holomorphic curves in exploded manifolds: virtual fundamental class*, Geom. Topol. **23** (2019), no. 4, 1877–1960. MR3981319 ↑8
- [Sei02] Paul Seidel, *Fukaya categories and deformations*, Proceedings of the International Congress of Mathematicians, Vol. II (Beijing, 2002), 2002, pp. 351–360. MR1957046 ↑3
- [Sei15] ———, *Homological mirror symmetry for the quartic surface*, Mem. Amer. Math. Soc. **236** (2015), no. 1116, vi+129. MR3364859 ↑3
- [Teh13] Mohammad F. Tehrani, *Open Gromov-Witten theory on symplectic manifolds and symplectic cutting*, Adv. Math. **232** (2013), 238–270. MR2989982 ↑8
- [Teh22] ———, *Pseudoholomorphic curves relative to a normal crossings symplectic divisor: compactification*, Geometry & Topology **26** (2022aug), no. 3, 989–1075. ↑8, 17, 19
- [TZ14] Mohammad F. Tehrani and Aleksey Zinger, *On symplectic sum formulas in gromov-witten theory*, arXiv, 2014. ↑8
- [TZ16] ———, *Absolute vs. relative Gromov-Witten invariants*, J. Symplectic Geom. **14** (2016), no. 4, 1189–1250. MR3601888 ↑8

DEPARTMENT OF MATHEMATICS AND STATISTICS, WASHINGTON UNIVERSITY IN ST. LOUIS, MO 63130

Email address: `adaemi@wustl.edu`

SIMONS CENTER FOR GEOMETRY AND PHYSICS, STATE UNIVERSITY OF NEW YORK, STONY BROOK, NY 11794-3636, USA

Email address: `kfukaya@scgp.stonybrook.edu`