

Simulation of minimal effective dynamical systems on the Cantor sets by minimal \mathbb{Z}^3 -SFT

Silvère Gangloff, Mathieu Sablik

November 1, 2021

Abstract

In this text, we prove then that any minimal effective dynamical system on a Cantor set $\mathcal{A}^{\mathbb{N}}$ can be simulated by a minimal \mathbb{Z}^3 -SFT, in a sense that we explicit here. This notion is a generalization of simulation by factor and sub-action defined [Hoc09].

1 Introduction

1.1 Embedding computations into multidimensional SFT

A subshift of finite type (SFT) is a discrete dynamical system defined as the shift action on a set of layouts of symbols in a finite set on an infinite regular grid (\mathbb{Z}^d) and local rules on symbols. Subshifts of finite type are central objects in the symbolic dynamics field and are studied through various dynamical properties: possible values of topological invariants, existence of periodic orbits, possible periods, etc. When $d = 1$ their properties are related to algebra. Many results provided evidence that the properties of multidimensional SFT ($d \geq 2$) are related to computability theory. This evidence comes from characterization results of topological invariants using embedding Turing computations in multidimensional SFT [HM10] [Mey11], using methods developed by R. Berger [Ber66] and R. Robinson [Rob71] in order to prove undecidability results.

A notable result by M. Hochman [Hoc09] states the shift actions obtained by factor and one-dimensional projective sub-action of tridimensional SFT are exactly the effective \mathbb{Z} -subshifts. This result was proved to be still true for bidimensional SFT independently by N. Aubrun and M. Sablik [AS10] and B. Durand and A. Romashchenko [DRS10]. Intuitively, multidimensional subshifts can simulate any effective \mathbb{Z} -subshift, by factor and sub-action.

1.2 Effect of dynamical constraints

This result was proved more recently to be robust under the constraint of minimality by B. Durand and A. Romashchenko [DR17]: they proved that any minimal effective \mathbb{Z} -subshift can be simulated in the same way by minimal multidimensional SFT. This is not however a characterization, since the sub-action of a minimal SFT is not forced to be minimal. This result follows a recent trend in symbolic dynamics which consists in understanding to which extent the constructions embedding Turing computations in multidimensional SFT are robust under dynamical constraints. This question originates in [HM10], where the authors wonder if their result is still true under transitivity constraint. The effect of a stronger constraint, block gluing, was notably studied by R. Pavlov and M. Schraudner [PS15], who provided a realization of a sub-class of the computable numbers as entropy of block gluing multidimensional subshift. This constraint imposes that any two patterns in the language of the subshift appear on any couple of positions in some configuration, provided that the space between the two patterns is greater than a constant. The characterization of these numbers is still an open problem. On the other hand, the authors of the present text provided some method in order to prove the robustness of the characterization in [HM10] to a linear version

(where the minimal distance imposed between the pattern depends linearly on the size of these patterns) of the block gluing [GS17a].

1.3 Extended abstract and statement of the result

In this text, we define a notion of simulation of an effective dynamical system on the Cantor sets $\mathcal{A}^{\mathbb{N}}$ by a multidimensional SFT in order to study the possible effective dynamical systems (not only subshifts) that multidimensional SFT can simulate. This definition consists in the existence of a computable map which commutes with the shift action in only one direction. It was proved in [Hoc09] that tridimensional subshifts simulate effective dynamical systems on the Cantor sets $\mathcal{A}^{\mathbb{N}}$. We prove here that this statement is robust to the minimality property:

Theorem 1. *Any minimal effective dynamical system (Z, f) on a Cantor set $\mathcal{A}^{\mathbb{N}}$, where \mathcal{A} is a finite set, can be simulated by a minimal \mathbb{Z}^3 -SFT.*

1.4 Specific information processing phenomena

The construction involved in the proof of this theorem relies on R. Robinson's and M. Hochman, T. Meyerovitch's constructions. However, it exhibits specific information processing phenomena.

Some of them can be observed already in the literature. In particular, the computing units in which are embedded Turing computations are decomposed in sub-units used for specific functions, as in B. Durand and A. Romashchenko's constructions. Thus the construction exhibits functional specialisation of the computing units. However, this functional specialisation does not rely on a universal machine.

Some others are specific to the construction presented here:

1. The natural way to support effective dynamical systems implies specific degenerated behaviors which consist of the presence of a full shift supported by some infinite computing units. A significant part of the construction is devoted to the simulation of these degenerated behaviors.
2. As in the authors' construction in [GS17a], the density of information exchanges is higher than in the constructions of B. Durand and A. Romashchenko. This density imposes that the information exchanges between the sub-units can not follow a tight "U" shape, in order to avoid breaking the minimality property.
3. For the same reason, some information characterizing the behavior of the computing units are determined by a hierarchical signaling process which is *imposed to avoid some regions* of the construction.
4. We also provide to some computing sub-units the choice of direction of transport of information. In [GS17b], this phenomenon appears for the propagation of an error signal triggered by the machines. Here it is used for the attribution of a value to some bits related to the simulation of the system. This information has to be transported through "random" channels.
5. Moreover, we use, as in [GS17b], Fermat numbers in order to desynchronize some counters involved in the construction. This time we have to include counters having different functions.

1.5 Comparison with existing constructions

It is noteworthy that the construction of [GS17b] and the construction of this present text are really different, although using common mechanisms for the machines and the linear counters ruling the machines. Thus, they exhibit a strong difference with constructions of [AS10] and [DRS10], in which the characterization of the possible values of the entropy derives from the simulation of effective subshifts by factor and sub-action. The reason is that these deal with different degenerated

behaviors. We don't know if there is a method from which derive the simulation theorem and the characterization of the entropy dimensions under constraint of minimality.

Moreover, the specificity of the proof of Theorem 1 is the simulation of any effective system on a Cantor set (not only subshifts), with the cost of increasing the dimension. However, it seems reasonable that the same principles of simulation of degenerated behaviors and suspended counters can be applied on Hochman's reformulation of B. Durand, A. Romashchenko's and N. Aubrun, M. Sablik's result in [?] to recover the result of [DR17]. At least it is direct to recover the simulation of minimal effective one-dimensional subshifts by minimal \mathbb{Z}^3 -SFT by factor and projective sub-action (instead of \mathbb{Z}^2 -SFT).

Remark 1. *Another consequence of Theorem 1, is that one can not decide if a \mathbb{Z}^3 -SFT is minimal or not.*

2 Definitions

In this section we recall some definitions on \mathbb{Z}^d -subshifts dynamics. Denote $\mathbf{e}^1, \dots, \mathbf{e}^d$ the canonical generators of \mathbb{Z}^d .

2.1 Subshifts as dynamical systems

Let $d \geq 1$. Let \mathcal{A} be a finite set (alphabet). A **configuration** x is an element of $\mathcal{A}^{\mathbb{Z}^d}$. The space $\mathcal{A}^{\mathbb{Z}^d}$ is endowed with the product topology derived from the discrete topology on \mathcal{A} . For this topology, $\mathcal{A}^{\mathbb{Z}^d}$ is a compact space. This **shift action** of \mathbb{Z}^d on $\mathcal{A}^{\mathbb{Z}^d}$ is defined, for all $\mathbf{u} \in \mathbb{Z}^d$ and $x \in \mathcal{A}^{\mathbb{Z}^d}$, by

$$\sigma^{\mathbf{u}}(x)_{\mathbf{v}} = x_{\mathbf{u}+\mathbf{v}}.$$

For all $N \geq 1$, the **N th subaction of the shift** is the action σ_N defined for all $\mathbf{u} \in \mathbb{Z}^d$ and $x \in \mathcal{A}^{\mathbb{Z}^d}$, by

$$\sigma_N^{\mathbf{u}}(x)_{\mathbf{v}} = x_{N \cdot \mathbf{u} + \mathbf{v}}.$$

For any finite subset \mathbb{U} of \mathbb{Z}^d , we denote $x_{\mathbb{U}}$ the **restriction** of $x \in \mathcal{A}^{\mathbb{Z}^d}$ to \mathbb{U} . A **pattern** P on **support** \mathbb{U} is an element of $\mathcal{A}^{\mathbb{U}}$. The support of the pattern P is denoted $\text{supp}(P)$. A block P **appears** in a configuration x when there exists some $\mathbf{u} \in \mathbb{Z}^d$ such that $x_{\mathbf{u}+\text{supp}(P)} = P$. Let us denote, for all n , $\mathbb{U}_n^d = \llbracket 0; n-1 \rrbracket^d$. A pattern on support \mathbb{U}_n^d is called a **n -block**. A n -block P appears at position $\mathbf{u} \in \mathbb{Z}^d$ in a configuration $x \in \mathcal{A}^{\mathbb{Z}^d}$ when $x_{\mathbf{u}+\mathbb{U}_n^d} = P$. We denote this $P \sqsubset x$. A pattern P on support \mathbb{U} is a **sub-pattern** of a pattern Q on support \mathbb{V} when $\mathbb{U} \subset \mathbb{V}$ and $Q_{\mathbb{U}} = P$.

A **d -dimensional subshift** (or \mathbb{Z}^d -subshift) X is a closed subset of $\mathcal{A}^{\mathbb{Z}^d}$ which is invariant under the action of the shift. This means that $\sigma(X) \subset X$. The couple (X, σ) is a dynamical system. Any subshift X can be defined by a set of **forbidden patterns**: this means that X is the set of configurations where none of the forbidden patterns appears. Formally, there exists \mathcal{F} a set of patterns such that :

$$X = X_{\mathcal{F}} := \left\{ x \in \mathcal{A}^{\mathbb{Z}^d} : \text{for all } P \in \mathcal{F}, P \not\sqsubset x \right\}.$$

We also use the term **local rule** (or rule) the act of forbidding a pattern. Sometimes we forbid patterns by imposing the rule that patterns on a given support are in a restricted set of patterns on this support.

If the subshift can be defined by a finite set of forbidden patterns, it is called a **subshift of finite type** (SFT for short). The **order** of a SFT is the smallest r such that it can be defined by forbidden r -blocks.

A pattern **appears** in a subshift X if there is a configuration of X in which it appears. The set of patterns which appear in X is called the **language** of X , denoted $\mathcal{L}(X)$. As well, the alphabet of the subshift X is often denoted \mathcal{A}_X .

A subshift is said to be **minimal** if every pattern in the language of X appears in every configuration of X . This means that the trajectory of any point of the subshift under the shift action is dense in the subshift.

In this article, we construct subshifts on some alphabet \mathcal{A} which is a product of alphabets $\mathcal{A} = \mathcal{A}_1 \times \dots \times \mathcal{A}_k$. We call informally the i^{th} layer of this subshift the space of the projections of a configuration written on the i^{th} alphabet \mathcal{A}_i , and we describe the subshifts layer by layer, giving the symbols, the rules that are internal to the layer, and the rules making interact the layer with the previous ones. Sometimes, for clarity of the construction, a layer is described as a product of layers : we call it a sublayer of the product subshift.

We say that a **symbol** on a position $\mathbf{u} \in \mathbb{Z}^d$ is transmitted through a rule to a neighbor when the rule impose that the symbol on this neighbor is the same.

2.2 Simulation of effective dynamical systems on the Cantor set

A Cantor set is a set $\mathcal{A}^{\mathbb{N}}$, where \mathcal{A} is some finite set, that we consider here as a topological space with the power of the discrete topology. A **cylinder** is some set

$$\{x \in \mathcal{A}^{\mathbb{N}} : \forall i \leq n-1, x_i = p_i\},$$

where $n \geq 1$ and p is some length n word on the alphabet \mathcal{A} . This set is denoted $[p]$.

Definition 1. Let Z be a closed subset of $\mathcal{A}^{\mathbb{N}}$ and f a continuous function $f : Z \rightarrow Z$. The dynamical system (Z, f) is said to be **minimal** when for any

1. configuration $x \in Z$,
2. $[q]$ a cylinder such that $[q] \cap Z \neq \emptyset$,

there exists some $n \geq 0$ such that

$$f^n(x) \cap [q] \neq \emptyset.$$

Definition 2. Let Z be a closed subset of $\mathcal{A}^{\mathbb{N}}$. This set is said to be **effective** when there is a Turing machine which on input n outputs some word p_n on alphabet \mathcal{A} such that

$$Z^c = \bigcup_n [p_n].$$

Definition 3. Let Z be an effective closed subset of $\mathcal{A}^{\mathbb{N}}$ and f be a continuous function $Z \rightarrow Z$. The dynamical system (Z, f) is said to be **effective** when there exists a Turing machine which on input n outputs some word p_n such that

$$\{(x_i, f(x)_i)_i : x \in Z\}^c = \bigcup_n [p_n].$$

Let us choose for the following an effective encodings of patterns on an alphabet \mathcal{A} on \mathbb{Z}^d into \mathbb{N} . Any algorithm manipulating patterns (when taken as input or output) manipulates their representation in \mathbb{N} .

Definition 4. Let φ be a function $X \rightarrow X'$, where X, X' are two effective subshifts respectively on \mathbb{Z}^d and $\mathbb{Z}^{d'}$. We say that φ is **computable** when there exists an algorithm that taking as input an integer k computes some $\psi(k)$ and outputs $\varphi(x)_{[-k, k]^{d'}}$ out of knowledge of the pattern $x_{[-\psi(k), \psi(k)]^d}$.

Definition 5. Let (Z, f) be an effective dynamical system such that f is onto, and X be a \mathbb{Z}^d -SFT. We say that X **simulates** the dynamical system (Z, f) if there exists some computable onto

function $\varphi : X \rightarrow \mathcal{A}^{\mathbb{N}}$ such that the following diagram commutes :

$$\begin{array}{ccc} X & \xrightarrow{\sigma^{\mathbf{e}^d}} & X \\ \varphi \downarrow & & \downarrow \varphi \\ Z & \xrightarrow{f} & Z \end{array}$$

The function φ is called the **simulation function**.

Example 1. A factor map between two subshifts is a map which commutes with the shift action. The projective sub-action on $\mathbb{Z}^{d'}$, $d' \leq d$ of a \mathbb{Z}^d -subshift X is the projection of X on the subshift Z of $\mathcal{A}^{\mathbb{Z}^{d'}}$, where \mathcal{A} is the alphabet of X , and

$$Z = \left\{ z \in \mathcal{A}^{\mathbb{Z}^{d'}} : \exists x \in X : \forall i \leq d', z_i = x_i \right\}$$

Both factor and projective sub-action are simulation functions for f the shift map.

As a consequence, one can formulate the following theorem:

Theorem 2 ([Hoc09],[AS10],[DRS10]). *Let $d \geq 2$. The subshifts that can be simulated by a \mathbb{Z}^d -SFT by factor and projective sub-action are the effective subshifts on \mathbb{Z}^k for some $k \leq d - 1$.*

3 Simulation of minimal effective dynamical systems on the Cantor sets by minimal \mathbb{Z}^3 -SFT.

The aim of this section is to give an outline of the proof of Theorem 1.

3.1 Statement and outline

Theorem 1. *Let \mathcal{A} be some finite set, and $f : \mathcal{A}^{\mathbb{N}} \rightarrow \mathcal{A}^{\mathbb{N}}$ any effective function, such that the dynamical system $(f, \mathcal{A}^{\mathbb{N}})$ is minimal. Then there exists some minimal \mathbb{Z}^3 -SFT X which simulates this system.*

The structure of the subshifts constructed for the proof is an infinite stack, in direction \mathbf{e}^3 , of a rigid version of the Robinson subshift presented earlier in [GS17a]. Most of the mechanisms are described in sections of \mathbb{Z}^3 orthogonal to this direction, since this is the direction of time for the simulated system.

The idea is to encode configurations of $\mathcal{A}^{\mathbb{N}}$ into the hierarchical structures of the Robinson subshift in each section of \mathbb{Z}^3 orthogonal to \mathbf{e}^3 : each level n of the hierarchy supports the n th bit of the configuration. We implement Turing computations in each of the copies in order to ensure that the configuration y in any copy is equal to $f(x)$, where x is the configuration in the copy just below in the direction $\sigma^{\mathbf{e}^d}$. Moreover, it verifies that x is in Z . Both these tasks are possible since the dynamical system (Z, f) is effective.

There are two obstacles to the minimality property in this scheme. The first one comes from the implementation of the machines. This is solved as in [GS17b]: we use counters that alternate all the possible computations and use error signals in order to take into account only well initialized ones. The main difference with construction of [GS17b] is that the counters and machines are implemented in a two dimensional section. Since we can not superimpose the counters and computations of the machines without breaking the minimality, we subdivide the computing units into a finite set of sub-units. Each of the sub-units has a specific function: information transport, incrementation of the counter, computations, etc. This decomposition is illustrated on Figure 1.

The main other obstacle, which is specific to this construction, comes from the encoding of configurations in $\mathcal{A}^{\mathbb{N}}$. The bits supported by infinite computing units are not under control of the

computing machines. This implies that an infinite stack of these computing units supports a full shift on the alphabet \mathcal{A} . We use the idea of simulation of degenerated behaviors used previously in [GS17a] and [GS17b] and underlying the construction of [DR17] and simulate the one dimensional full shift on a larger alphabet \mathcal{E} on the computing units having odd levels. The simulated effective dynamical system is supported by the even ones. Since the information of simulation can not meet the bits generating the full shift or the effective dynamical system, we use an avoiding hierarchical signaling process in order to give access to each of the computing units to the information of the parity of its level. Moreover, a sub-unit of each computing unit supports a counter which is incremented in direction \mathbf{e}^3 and synchronized in the other directions. We choose the cardinality of \mathcal{E} so that this counter has a Fermat number has period in order to keep the minimality property, in the same spirit as in [GS17b]. This counter is used to determine the system bits in odd levels, through transport of information to the location of the system bits. We need two possible channels for this transport, only one of them being used, so that over infinite computing units, even if no information flux is detected locally through the border, it is still possible to see this area as part of a computing unit where the bits are simulated by the counter. The choice of the channel is done according to the class of the level modulo 4, which is transported to the counter area in the same way as the parity. Moreover, this counter is synchronized over each section of \mathbb{Z}^3 orthogonal to \mathbf{e}^3 . The same channels are used for this purpose, in order to synchronize these bits, which is sufficient to ensure the synchronization of the counters. We do not synchronize these counters by transporting their values since this is not possible to guarantee that the values of this counter along direction \mathbf{e}^3 are coherent along the transport.

Another noteworthy aspect of this construction is that the counters used to simulate the degenerated behaviors that appear here are incremented in a more compact way than it was in [GS17b]. In this setting, the counter is not robust to the minimality, because of the suspension mechanism. We thus naturally interpret this version of the mechanism as *dominant* with respect to the other one, since it can replace it in the construction of [GS17b].

3.2 Description of the layers

Let \mathcal{A} be a finite set and (Z, f) a minimal effective dynamical system on $\mathcal{A}^{\mathbb{N}}$. Let us construct a minimal \mathbb{Z}^3 -SFT $X_{(Z,f)}$ which simulates this system.

This subshift is constructed as a product of various layers, as follows :

- **Structure layer [4]:** This layer has a first sublayer having alphabet \mathcal{A}_R , the alphabet of X_R , the rigid version of the Robinson subshift, whose description can be found in Annex A.1. The symbols are transported along \mathbf{e}^3 and follow the rules of the subshift X_R in the other directions.

When not specified, the configurations in the other layers are described in a section

$$\mathbb{Z}_c^2 := \mathbb{Z} \cdot \mathbf{e}^1 + \mathbb{Z} \cdot \mathbf{e}^2 + c \cdot \mathbf{e}^3$$

of \mathbb{Z}^3 , with $c \in \mathbb{Z}$, and identified on \mathbb{Z}_{c+1}^2 and \mathbb{Z}_c^2 for all $c \in \mathbb{Z}$, using local rules.

Moreover, in all the sections, the order $n \geq 3$ cells are subdivided into 64 parts, using a hierarchical signaling process, in a second sublayer. These subcells (or organites) are coded by two elements of $\mathbb{Z}/8\mathbb{Z}$, thought as projective coordinates: the first element of this pair corresponds to the position of the sub-unit in the unit in direction \mathbf{e}^1 . The other one corresponds to the position in direction \mathbf{e}^2 . Each of the sub-units is attributed with specific functions amongst the following ones:

- computations,
- incrementation of the linear counter,
- information transport,
- deviation of the information transfer, or extraction of some information (demultiplexers),

- support the system counter.

See Figure 1 for an illustration. The linear counter is the counter which codes for the behaviors of the computing machines. Its mechanism is similar to the linear counter in [GS17b]. The system counter is the one which is used to simulate the full shift on \mathcal{A} on odd levels. The symbols in this layer are identified in the direction \mathbf{e}^3 .

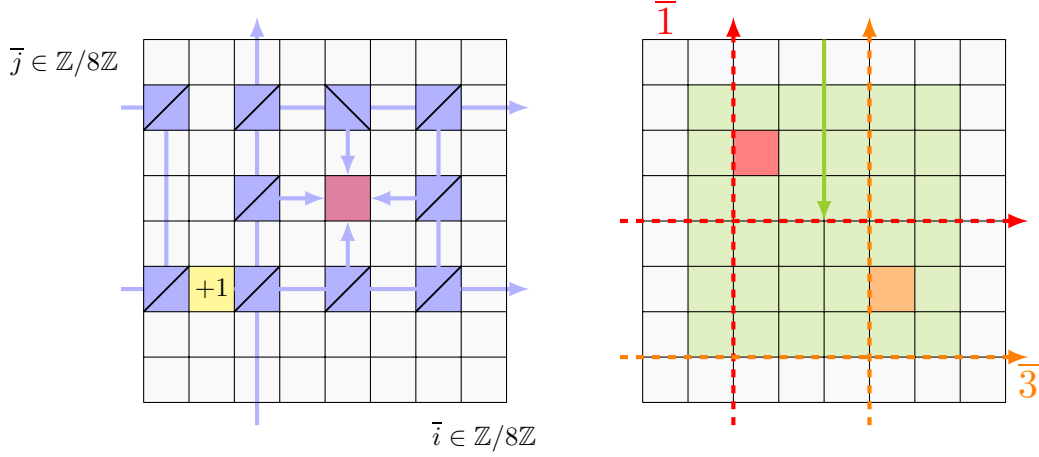

Figure 1: Illustration of the subdivision of a computing unit into sub-units and preview of the functional diagram. The arrows designate information transports: the blue ones correspond to the linear counter, the orange ones to the system counters in order to synchronize them, and the green ones to the transport of the modularity mark. The colored sub-units execute specific functions: the yellow one $((\bar{i}, \bar{j}) = (\bar{2}, \bar{3}))$ supports the incrementation of the linear counter, the purple one $((\bar{i}, \bar{j}) = (\bar{6}, \bar{5}))$ supports computations. The blue ones are demultiplexers (extracting information). On the right, the orange area (sub-units $(\bar{2}, \bar{5}), (\bar{5}, \bar{2})$) is the support of the incrementation of the system counter. The dashed arrows are potential transports of information. The green area is the localisation of the modularity mark inside the cell.

- **System bits layer [5]:** This layer supports the system bits, which generate the full shift or the simulated effective dynamical system. These bits are synchronized over a level. We use only two sides of the computing units in order to transport these bits for the synchronization, as illustrated on Figure 2.

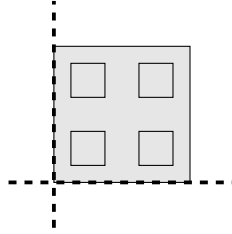

Figure 2: Preview of the synchronization mechanism of system bits. The gray square designates a computing units and the dashed lines the locations of the system bits.

- **Functional areas layer [7]:** In this layer, we attribute a function to the proper positions of the computing units: transport of information, step of computation. This allows the

localization of the various information processes in the cells, outside the machine sub-unit. For this purpose, we use a hierarchical signaling process. Another process, similar to the one used in [Rob71], is used to separate inside the machine sub-unit the columns and lines into two sets: active and inactive ones. Only the active ones are allowed to transport information. We use this in order to ensure the minimality.

- **Modularity marks [6]:** In this layer, we superimpose marks on some parts of the border of the computing units. This mark is $\bar{n}[4]$, the arithmetic class of n modulo 4, where n is the level of the computing unit. The hierarchical signaling process which allows this marking is different from the one used for the functional areas since the information transport is permitted only from some unit to the one just above in the hierarchy, amongst those who share this one as parent. See an illustration on Figure 3. Moreover, we impose the mark $\bar{0}$ on order 0 units. All the other marks are determined by the hierarchical process. The modularity mark serves to impose the presence of the system counter when the level is odd. It prevents this counter when the level is even. When the level is odd, it also serves to determine the channels by which the value of the counter is transported.

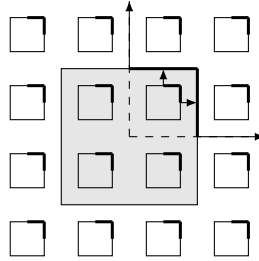

Figure 3: Preview of the hierarchical signaling process which allows modularity marking. The thick lines designates the location of the marking and the arrows designate the direction of communication.

- **Linear counter layer [C]:** This layer supports the incrementation mechanism of the linear counter. The value of this counter is a word on the alphabet

$$\mathcal{A}_c = \mathcal{A}' \times \mathcal{Q}^3 \times \{\rightarrow, \leftarrow\} \times \mathcal{D},$$

where \mathcal{A}' is the alphabet of the Turing machine used in the construction, after completing this alphabet so that its cardinality is 2^{2^l} for some integer l . The set \mathcal{Q} is the state set of the machine after similar completion, so that its cardinality is 2^{2^l} . We complete these two sets so that the states and letters of the initial machine can not be transformed into the additional letters and states. We need this so that the machine behaves as the initial one when it is initialized in the initial state and with empty tape. The arrows designate the propagation direction of an error signal triggered by the machine when it has a head ending computation in error state. The last set has cardinality $2^{4 \cdot 2^l - 2}$. This set is included in the product so that \mathcal{A}_c has cardinality a double power of 2: $2^{8 \cdot 2^l} = 2^{2^{l+3}}$.

The incrementation mechanism of this counter consists of an adding machine. This incrementation goes in direction \mathbf{e}^1 , and the counter is synchronized in direction \mathbf{e}^2 , \mathbf{e}^3 . It is suspended for one step when the counter reaches its maximal value. As a consequence the period of the counter attached to level $n \geq 3$ computing units is

$$2^{2^{l+3+n+1-3}} + 1 = 2^{2^{l+n+1}} + 1.$$

Thus these periods are different Fermat numbers. We use this fact in order to ensure the minimality property.

- **System counter layer [8]:** This layer supports the incrementation mechanism of the system counter, supported by the system counter areas when the level is odd. When the modularity mark is $\bar{1}$ the sub-unit is $(\bar{2}, \bar{5})$ and it is $(\bar{5}, \bar{2})$ when the mark is $\bar{3}$.

The value of this counter is the product of two words on an alphabet \mathcal{E}^2 , where \mathcal{E} has cardinality 2^{2^m} and is such that such that $\mathcal{A} \subset \mathcal{E}$ and $m \geq 0$.

In direction \mathbf{e}^3 from each \mathbb{Z}_c^2 to \mathbb{Z}_{c+1}^2 , the first word is incremented by an adding machine. The second word is considered as a word on a discrete torus which consists of the concatenation of two words on \mathcal{E} , and is at each step rotated as on Figure 4.

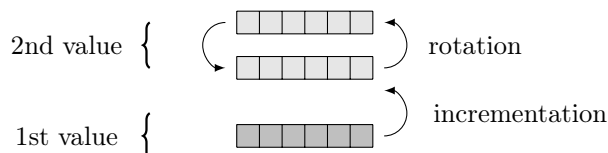

Figure 4: Preview of the system counter mechanism.

Moreover, it is incremented as the concatenation of the two words on a segment each time the first value reaches its maximal value. When the two values are maximal at the same time, the rotation and the incrementation mechanisms are suspended for one step.

The values of this counter are synchronized over a level, using channels which depend on the value of the modularity mark. They are designated by orange arrows on Figure 1. These channels transport the first bit of the second value only.

Like the linear counters, the period of these counters are different Fermat numbers.

Moreover, the first bit of the second value is identified to the system bit after transport through another random channel. As a consequence, between times when the first value reaches its maximal value in direction \mathbf{e}^3 , the bits of the second value are listed in this direction along the direction of rotation. This means that the sequence of system bits over odd levels consists of a concatenation of blocks of the same word, where these words form a complete lists of all the words on alphabet \mathcal{E} and having length 2^n where n is the level.

The construction of these counters implies that any sequence of bits in \mathcal{E} appears in the sequence of system bits of any odd and sufficiently great level. This fact is used to prove the minimality property.

- **Machines layer [D]:** This layer supports the computations of the machines. Here we use a model of computing machines which includes multiple heads [GS17b]: the machine starts computation with multiple heads on its tape and any machine head can enter on the two sides of the tape and at any time in any state. We manage collisions between the machine heads by fusion of the heads into a head in error state. If there are machine heads in error state, an error signal is triggered in the direction specified in the value of the linear counter. This signal propagates towards one end of the initial tape, where signaling mechanisms verify if the tape was well initialized and that no head enters in one of the two sides of the tape for all time. When this is the case, we forbid the error signal to reach its destination. In this case, the machine have the aimed behaviors, which means that the sequence of systems bits of **even levels** to be in Z and that the two sequence in a section \mathbb{Z}_{c+1}^2 is the image by f of the sequence in the section \mathbb{Z}_c^2 .
- **Information transport layer [9]:** This layer supports all the information transports:
 1. transport of the linear counter value between incrementation regions;
 2. extraction of information from the linear counter to the machine area;
 3. transport of the first bit of the rotating part of the system counter

4. and of information between cells having the same level.

These transports follow fixed roads through the sub-units, except for the fourth one, which is done according to the modularity mark.

The main arguments in the proof of the minimality property of this subshift are the following ones:

1. Any pattern P can be completed into a pattern P' which is a stack of two-dimensional cells in direction \mathbf{e}^3 . Hence it is sufficient to prove that any such pattern appears in any configuration. Such a pattern is characterized by the values of the linear counters of a sequence of two-dimensional cells included in its support, intersecting all the intermediate levels, the sequences of simulated system bits in direction \mathbf{e}^3 for the same sequence of two-dimensional cells, and the sequence of non-simulated ones.
2. Considering any configuration x of the SFT, one can find back any sequence of values for the linear counters starting from any stack of two-dimensional cells, by jumping from one stack to the next one having the same level in direction \mathbf{e}^1 . This is possible since the periods of the counters are co-prime. The system bits are preserved.
3. For the same reason, by jumping in direction \mathbf{e}^3 , one can find back any sequences of simulated system bits. At this point the sequence of non simulated system bits are changed, but the linear counter are preserved.
4. Moreover, from the fact that a factor of a minimal dynamical system is also minimal, and using Lemma 2 with integer N equal to the product of Fermat numbers of the system counters, one can find back the sequences of non simulated system bits without changing the other bits.

This is illustrated on Figure 15. On this figure, \mathcal{T} is the shift to the next stack of cells having the same level in direction \mathbf{e}^1 .

In the following, we describe the mechanisms specific to this construction. Some mechanisms are well known or already described in other articles written by the authors. Since these mechanisms are although not standard, they are described in annexes for completeness.

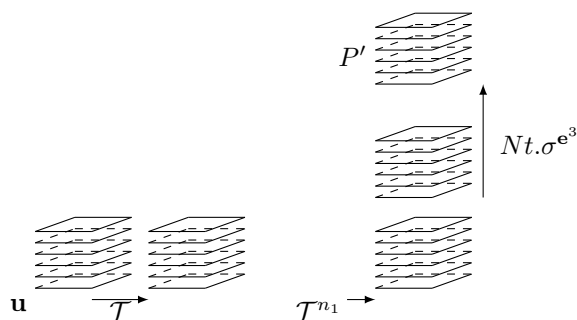

Figure 5: Schema of the proof for the minimality property of $X_{(Z,f)}$.

4 Structure layer

This layer is composed of two sublayers. The first one is the three-dimensional rigid version of the Robinson subshift presented briefly in the abstract of the construction. With the second one, we subdivide the cells in the copies of the Robinson subshift orthogonal to \mathbf{e}^3 into 64 similar parts,

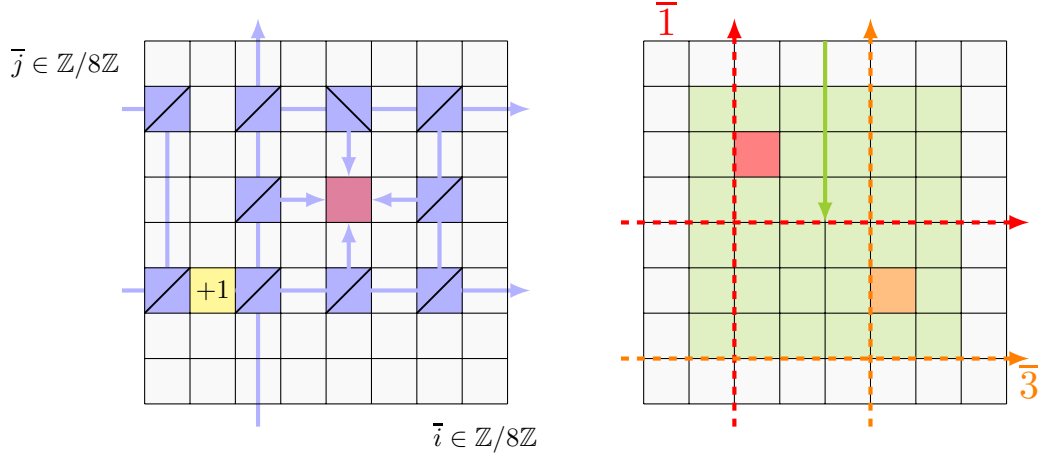

Figure 6: Functional diagram of odd level $n \geq 3$ cells.

called **organites**, by analogy with the functional division of living cells. This sublayer is described as follows.

This sublayer creates the subdivision of the cells.

Symbols:

Elements of $\mathbb{Z}/4\mathbb{Z}$, $\mathbb{Z}/4\mathbb{Z}^2$, $\mathbb{Z}/4\mathbb{Z}^3$, and symbols \blacksquare , \square .

Local rules:

- **Localization:** the petals are superimposed with non blank symbols, and other positions with blank one.
- **Transmission:** the symbols are transmitted through the petals except on **transformation positions**, defined to be the positions where a support petal intersects the transmission petal just above in the hierarchy.
- **Transformation:**
 - On a transformation position which is not in an order ≤ 2 cell, the symbol on the position is equal to the positions in the same support petal in the neighborhood. Moreover, if the symbol in the first sublayer is

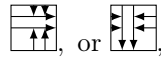

meaning that the position is in the north west part of the cell, then color of the transmission petal positions in the neighborhood is according to the following rules :

1. if the orientation symbol is \blacksquare , then the symbol of this layer is transformed into $\bar{0}$.
2. if the orientation symbol is \square , then the transformed symbol is \square .
3. if the orientation symbol is \blacksquare , and the symbol on the position is \square , then it is transformed into \square . If the symbol is $i \in \mathbb{Z}/4\mathbb{Z}$, then it is transformed into $(i, \bar{0}) \in \mathbb{Z}/4\mathbb{Z}^2$. If the symbol is $(i_1, i_2) \in \mathbb{Z}/4\mathbb{Z}^2$, it is transformed into $(i_1, i_2, \bar{0}) \in \mathbb{Z}/4\mathbb{Z}^3$ (see Figure 7 for these rules). If in $\mathbb{Z}/4\mathbb{Z}^3$, the symbol is transmitted (see Figure 8).
4. if the orientation symbol is \square , then the symbol is transformed into \square .

Similar rules are imposed for the other types of transformation positions.

- When the transformation position is in an order ≤ 2 cell, then we change the last set of rules by that \blacksquare can not be transformed, even when re-entering inside the cell.

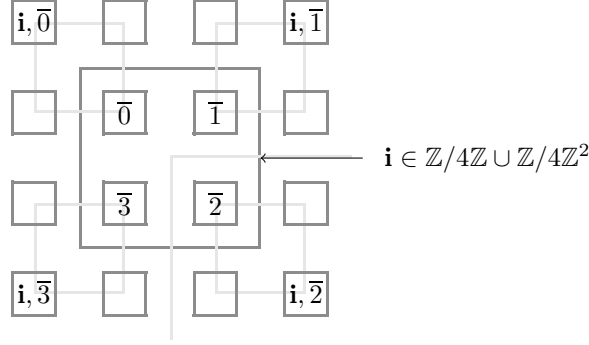

Figure 7: Schematic illustration of the transformation rules when the symbol is $\mathbf{i} \in \mathbb{Z}/4\mathbb{Z}$ or $\mathbf{i} \in \mathbb{Z}/4\mathbb{Z}^2$.

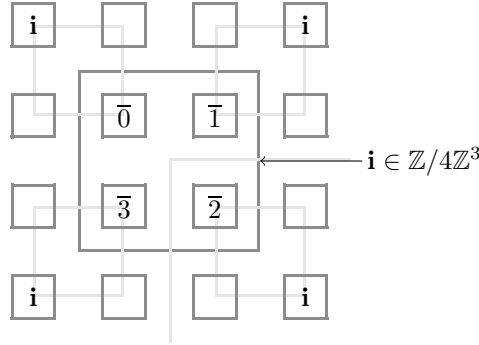

Figure 8: Schematic illustration of the transformation rules when the symbol is $\mathbf{i} \in \mathbb{Z}/4\mathbb{Z}^3$.

Global behavior:

As a consequence of the local rules, each position with a blue corner is in an order ≥ 3 cell is marked with an element of $\mathbb{Z}/4\mathbb{Z}^3$ or with \blacksquare . The positions with an element of $\mathbb{Z}/4\mathbb{Z}^3$ are exactly the functional positions, presented later in this text. In an order ≤ 2 cell, all the positions with a blue corner in the first sublayer are marked with \blacksquare (we won't use these cells since they are too small and can not be subdivided into 64 parts). Moreover, the areas where a triplet can appear in an order ≥ 3 cell are shown on Figure 9. For simplicity we recode these marks into pairs $(i, j) \in \mathbb{Z}/8\mathbb{Z}^2$, where i corresponds to the horizontal coordinate and j to the vertical one. These two coordinates are oriented from west to east and from south to north.

To each sub-unit correspond functions, as follows:

1. The sub-unit having coordinates $(\bar{6}, \bar{5})$ supports computations of the machines.
2. The sub-units $(\bar{1}, \bar{3}), (\bar{3}, \bar{3}), (\bar{6}, \bar{3}), (\bar{3}, \bar{7}), (\bar{6}, \bar{7})$ are demultiplexers. This means that they allow the extraction of information contained in the linear counter.
3. The sub-unit $(\bar{2}, \bar{3})$ supports the incrementation of the linear counter.
4. The sub-units $(\bar{3}, \bar{3}), (\bar{3}, \bar{4}), (\bar{4}, \bar{3})$ and $(\bar{4}, \bar{4})$ support the incrementation of the system counter.

$\bar{7}$	$\bar{000}$	$\bar{001}$	$\bar{010}$	$\bar{011}$	$\bar{100}$	$\bar{101}$	$\bar{110}$	$\bar{111}$
$\bar{6}$	$\bar{003}$	$\bar{002}$	$\bar{013}$	$\bar{012}$	$\bar{103}$	$\bar{102}$	$\bar{113}$	$\bar{112}$
$\bar{5}$	$\bar{030}$	$\bar{031}$	$\bar{020}$	$\bar{021}$	$\bar{130}$	$\bar{131}$	$\bar{120}$	$\bar{121}$
$\bar{4}$	$\bar{033}$	$\bar{032}$	$\bar{023}$	$\bar{022}$	$\bar{133}$	$\bar{132}$	$\bar{123}$	$\bar{122}$
$\bar{3}$	$\bar{300}$	$\bar{301}$	$\bar{310}$	$\bar{311}$	$\bar{200}$	$\bar{201}$	$\bar{210}$	$\bar{211}$
$\bar{2}$	$\bar{303}$	$\bar{302}$	$\bar{313}$	$\bar{312}$	$\bar{203}$	$\bar{202}$	$\bar{213}$	$\bar{212}$
$\bar{1}$	$\bar{330}$	$\bar{331}$	$\bar{320}$	$\bar{321}$	$\bar{230}$	$\bar{231}$	$\bar{220}$	$\bar{221}$
$\bar{0}$	$\bar{333}$	$\bar{332}$	$\bar{323}$	$\bar{322}$	$\bar{233}$	$\bar{232}$	$\bar{223}$	$\bar{222}$
	$\bar{0}$	$\bar{1}$	$\bar{2}$	$\bar{3}$	$\bar{4}$	$\bar{5}$	$\bar{6}$	$\bar{7}$

Figure 9: Schema of the correspondence between areas in a cell and triplets and recoding the addresses of the areas.

5. The ones specified by arrows on Figure 6 are used for information transport.
6. The other ones have no function.

A schema of these functions is shown on Figure 6.

5 System bits layer

Symbols: elements of $(\mathcal{A} \cup \{\square\})^2$.

Local rules:

- **Transmission:**
 1. The first coordinate of the ordered pair is transmitted horizontally. This means that the symbols of positions \mathbf{u} and $\mathbf{u} + \mathbf{e}^1$ have the same first coordinate for all $\mathbf{u} \in \mathbb{Z}^3$.
 2. The second coordinate is transmitted vertically.
- **Synchronization:** on a corner symbol in the structure layer, the two coordinates are equal.
- **Localization:** when the corner has 0,1-counter value equal to 0, then the two coordinates are blank. When it is equal to 1, the two coordinates are non blank.

Global behavior:

In each of the sections \mathbb{Z}_c^2 and each n , the order n cells and the lines connecting their corners are attached with the same bit, called system bit. The sequence of these bits, denoted $(s_c^{(n)})_n$ depends on the section \mathbb{Z}_c^2 . The transmission petals are superimposed with the blank symbol.

See Figure 10.

6 Modularity marks

In this section, we describe how to give access to each cell to the class of its level modulo 4 so that the road followed to transport this information never meet the location of system bits. This layer has two sub-layers. The first one is described in the annexes, in Section B.1. Let us describe the second one.

Symbols: elements of $\mathbb{Z}/4\mathbb{Z}$, $\{(\bar{n}, \bar{n} + \bar{1}), n \in \mathbb{Z}/4\mathbb{Z}\}$ and a blank symbol.

Local rules:

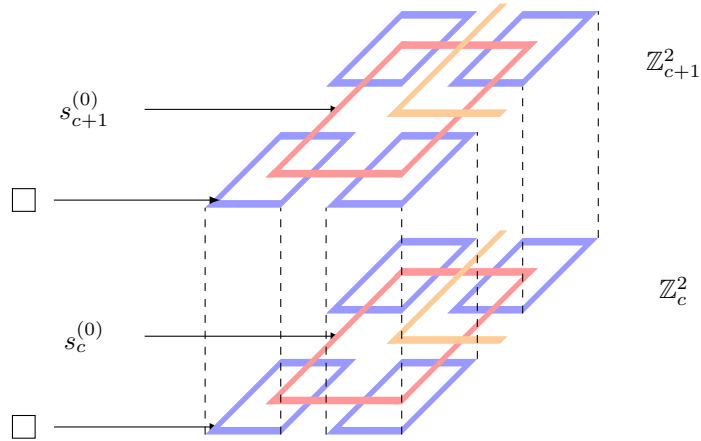

Figure 10: Illustration of the basis layer rules

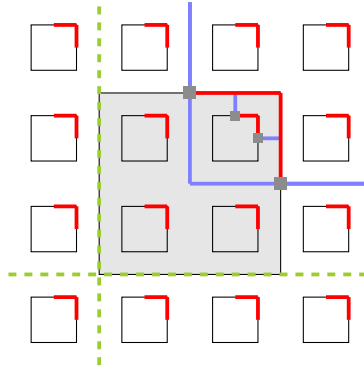
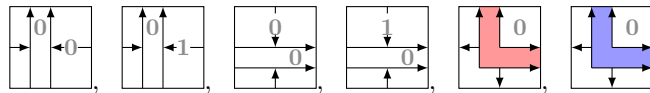

Figure 11: Localization of the modularity marks. Here level n cells and the level $n + 1$ cell above are represented. The locations of level $n + 1$ system bits are colored green and the locations of parity marks are colored blue and red. Observation: the system bits never cross parity marks for the same level $n + 1$.

1. **Localization:** the non-blank symbols are superimposed on and only on the east half of the north side of a cell, the north half of the east side of a cell, and the segments of transmission petals connecting them. See an illustration on Figure 11. Formally, this corresponds to positions having the following symbols in the structure layer:

(a) the symbols



superimposed with the orientation symbol \blacksquare . These positions are colored blue on Figure 11 and are superimposed with an element of $\mathbb{Z}/4\mathbb{Z}$ in the present layer.

(b) the symbols

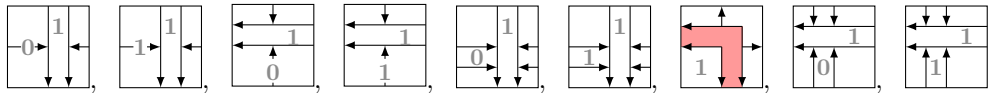

on which are superimposed symbols in $\mathbb{Z}/4\mathbb{Z}$. These positions are colored red on Figure 11.

(c) the symbols

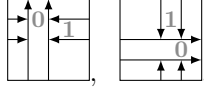

These ones are the **transformation positions**, and are superimposed with an element of $\{(\bar{n}, \bar{n} + \bar{1}) : \bar{n} \in \mathbb{Z}/4\mathbb{Z}\}$. They are designated by dark gray squares on Figure 11.

2. **Initialization of the process:**

3. **Transformation:** On the transformation positions, the first symbol of the ordered pair is equal to the symbol of the position below (respectively on the left) when the structure symbol is

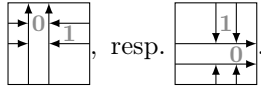

The second symbol is equal to the symbol of the position on the right (resp. above).

Global behavior:

A hierarchical signaling process is implemented which allows the coloration of north east quarter of each cell's border with the class of its level modulo 4. In order to avoid this information to cross the system bit of the same level, the communication is allowed only from the north east order n cell inside an order $n + 1$ cell to this cell. The signal is transmitted only through the south west quarter of the transmission petal connecting them.

7 Functional areas

In the construction, we use a functional division of the cytoplasm of each of the computing units. We use two different mechanisms. The first one works on the whole cells and is a hierarchical signaling process similar to a substitution. This mechanism is described in Section B.2. It allows the recognition of the free columns and free lines of the cytoplasm in order to localize the information and its transports outside the machine areas, so that there is no possible error in the process. The second one works on the machine areas and allows the localization of information transport inside them. This mechanism is similar to the one used in [Rob71] and uses signals from border to border of the area. Errors are allowed in the process, that trigger error signals along the border of the area. When these error occur, the computations of the machine are not taken into account. The freedom in the constitution of the functional areas is used to ensure the minimality property. In this section, we describe the second mechanism.

Symbols:

Elements of $\{\text{on}, \text{off}\}^2$, of $\{\text{on}, \text{off}\}$ and a blank symbol.

Local rules:

• **Localization rules:**

- the non-blank symbols are superimposed on the positions having a blue symbol in the Robinson layer, and a blue or arrow symbol in the first sublayer of the present layer, and are in the $(\bar{0}, \bar{5})$ sub-unit, corresponding to the machines.

- the ordered pairs are superimposed on the positions having a blue symbol in the first sublayer.
- **Transmission rule:** the symbol is transmitted along lines/columns. On the intersections the second symbol is equal to the symbol on the column. The first one is equal to the symbol on the line.

Global behavior:

In the cytoplasm of each computing unit in the machine area, the free columns and free lines are colored with a symbol in $\{\text{on}, \text{off}\}$. We call columns (resp. lines) colored with **on computation-active** columns (resp. lines).

8 System counter

In this section, we explain how the system counter works. The corresponding layer is subdivided into two sublayers. The first one supports the transport of the modularity mark to the system counter area 8.1. The second one supports the incrementation of the system counter 8.2.

8.1 Transport of the modularity mark

Symbols:

The symbols of this first sublayer are the elements of $\mathbb{Z}/4\mathbb{Z}$ and a blank symbol.

Local rules:

- **Localization:** the non-blank symbols are superimposed on and only on the cytoplasm positions in the sub-units that are not on the border, meaning the sub-units (\bar{k}, \bar{l}) with $k, l \in \llbracket 1, 6 \rrbracket$, and $(\bar{4}, \bar{7})$.
- **Transport of information:** two adjacent such positions have the same symbol.
- **Nature of the information:** on the top line of the $(\bar{4}, \bar{7})$ sub-unit, the symbol of this layer is equal to the modularity mark on the line just above.

Global behavior:

The consequence of local rules is that the information of the modularity mark is transported through a path avoiding the system bit location to the system counter area to the surrounding of the system counter area.

8.2 Incrementation of the system counter

Recall that \mathcal{A} is the alphabet of the simulated system. Let us complete this alphabet into an alphabet \mathcal{E} having cardinality 2^{2^m} for some $m \geq 0$.

Let us fix t some cyclic permutation of the set \mathcal{E} , and e_{\max} some element of \mathcal{E} . As well, we consider \bar{t} a permutation of \mathcal{E}^2 and \bar{e}_{\max} an element of \mathcal{E}^2 .

Symbols:

The elements of the sets

$$(\mathcal{E}^2 \times \{0, 1\} \times \{\rightarrow\}) \times (\mathcal{E} \times \{0, 1\} \times \{\rightarrow\}) \times (\mathcal{E} \times \{0, 1\} \times \{\leftarrow\}) \times (\{\color{red}\square, \color{green}\square}\})^3,$$

$$(\mathcal{E}^2 \times \{0, 1\} \times \{\rightarrow\}) \times (\mathcal{E} \times \{0, 1\} \times \{\rightarrow\}) \times (\mathcal{E} \times \{0, 1\} \times \{\leftarrow\}) \times (\{\color{red}\square, \color{green}\square}\})^3 \times \{\color{lightgray}\square, \color{maroon}\square}\}$$

and

$$\{0, 1\}^3 \times (\{\color{red}\square, \color{green}\square}\})^3.$$

The elements of $(\mathcal{E} \times \{0, 1\} \times \{\rightarrow\})$ are thought as the following tiles. The first symbol represents the south symbol in the tile, and the second one representing the west symbol in the tile. The arrow represent the direction of propagation of the increment signal.

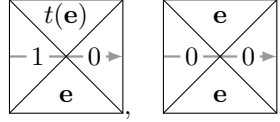

for $e \neq e_{\max}$, and

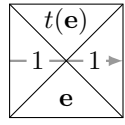

for $e = e_{\max}$.

The elements of $\mathcal{E} \times \{0, 1\} \times \{\leftarrow\}$ are thought as similar tiles, with reversed arrow and pairs of west and east symbols:

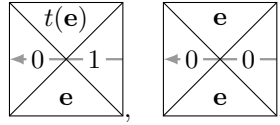

for $e \neq e_{\max}$, and

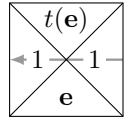

for $e = e_{\max}$.

The elements of $(\mathcal{E}^2 \times \{0, 1\} \times \{\rightarrow\})$ are thought as similar tiles, except that elements of \mathcal{E} are replaced by elements of \mathcal{E}^2 , e_{\max} by \bar{e}_{\max} and the permutation t by \bar{t} .

Let us note that the arrow is, as the tile, not necessary but aimed to make the construction more readable. The elements of $\{\color{red}\square, \color{green}\square}\}$ are thought as the symbols of a detecting signal, aimed to detect when all the south symbols of the tiles are e_{\max} or \bar{e}_{\max} . The symbols in $\{\color{lightgray}\square, \color{maroon}\square}\}$ are called the **freezing symbols**. The freezing symbol serves to suspend the incrementation mechanism for one step.

Local rules:

- **Localization rules:**

- The non-blank symbols are superimposed on positions of bottom line of the sub-unit $(\bar{2}, \bar{5})$ of order ≥ 3 cells when the modularity mark is $\bar{1}$.
- When the modularity mark is $\bar{3}$ the support sub-unit is $(\bar{2}, \bar{5})$.
- For the other modularity marks, the symbols over these lines are blank.

- The elements of the set

$$(\mathcal{E}^2 \times \{0, 1\} \times \{\rightarrow\}) \times (\mathcal{E} \times \{0, 1\} \times \{\rightarrow\}) \times (\mathcal{E} \times \{0, 1\} \times \{\leftarrow\}) \times \{\square, \blacksquare\}^3$$

appear on the computation positions of the line except the leftmost one. On this one, the symbol is in the set

$$(\mathcal{E}^2 \times \{0, 1\} \times \{\rightarrow\}) \times (\mathcal{E} \times \{0, 1\} \times \{\rightarrow\}) \times (\mathcal{E} \times \{0, 1\} \times \{\leftarrow\}) \times \{\square, \blacksquare\}^3 \times \{\square, \blacksquare\}.$$

- The other positions have a symbol in the set

$$\{0, 1\}^3 \times \{\square, \blacksquare\}^3.$$

See a schema of these rules on Figure 12.

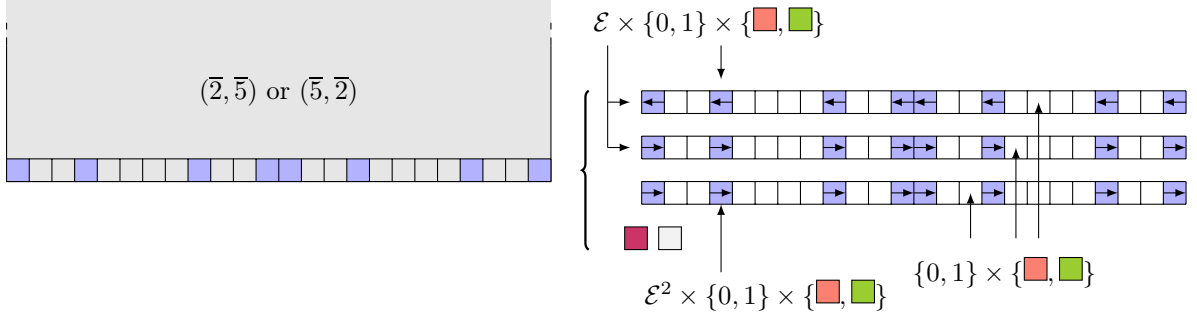

Figure 12: Schema of the localization rules for the system counter. The pattern on the bottom line of the sub-unit is considered as the superposition of three words and a symbol on the leftmost position.

A **value** of the counter is a possible sequence of symbols of the alphabet \mathcal{E}^4 that can appear on these lines, on the computation positions. A value is thought as the superposition of three words and a letter in $\{\square, \blacksquare\}$ on the leftmost position. The first word has alphabet

$$\mathcal{E} \times \{0, 1\} \times \{\leftarrow\} \times \{\square, \blacksquare\}$$

on the computation positions and alphabet $\{0, 1\} \times \{\square, \blacksquare\}$ on the others. The other two words are similar, except for the orientation of the arrows, and the alphabet \mathcal{E} is replaced by \mathcal{E}^2 in the third one.

- **Detection signals:**

- 1. On the third word, on the rightmost position, the detecting symbol is \blacksquare if and only if the south symbol of the tile is \bar{e}_{\max} .
- 2. The symbol \blacksquare propagates to the right while on the support line and propagates to the left until meeting a tile with south symbol different from \bar{e}_{\max} . In this case, the symbol on the left is \square . Moreover, the symbol \blacksquare can appear on a tile only if the south symbol is \bar{e}_{\max} .
- 3. The symbol \square propagates to the left.
- On the second word, the rules are similar, except that the orientation of the line is reversed.

- On the first word, the orientation is not reversed, but the first rule of the set of rules is changed: the rightmost symbol is ■ if the rightmost symbol of the second word is also ■ or if the south symbol on the corresponding tile is not e_{\max} . Else it is ■. As a consequence, one can think the two first words, from the point of view of the detecting signal, as a unique word. This word is the concatenation of the two words on the right side.
- **Coherence rule:** If the symbol on a position \mathbf{u} of the line in the first word is ■, then the corresponding symbol in the second word is also ■.

Here is a typical configuration of the detecting signals:

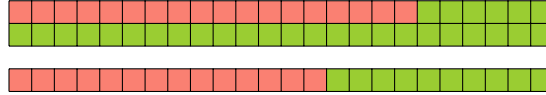

- **Freezing signal:**

Recall that the freezing symbol is localized on the leftmost position of the line, denoted in this rule \mathbf{u} .

- If the detecting signal on this position is ■ for the three words, then the freezing symbol on positions \mathbf{u} and $\mathbf{u} + \mathbf{e}^3$ are different, meaning that if the symbol on \mathbf{u} is ■, then it is changed into ■ on the next position in direction \mathbf{e}^3 , and the symbol ■ is changed into ■.
- In the other case, meaning when one of the detecting signals is ■, then the freezing symbol is not changed.
- **Coherence rule:** The symbol freezing symbol can be ■ only if the three detecting signals are ■.

- **Incrementation of the counter:**

- **Triggering the incrementation:**

- * **For the third word:** On the leftmost position of the line, the west symbol of the tile in the third word is 0 if and only if the freezing signal is ■ and the detecting signals are all ■.
- * **For the other two words:** On the leftmost position of the line, the west symbol of the tile in the second word is 1 only when the detecting signal of the third word is ■ and the one on the first one is ■, or the freezing signal is ■. This rule means that the value which consists of the two first words is incremented exactly when the third word reaches its maximal value, except when the whole counter is suspended.

- **Transmission of increment:**

- * On a computation position except the leftmost, the west symbol of the tile is equal to the symbol in $\{0, 1\}$ of the position on the left. A similar rule is true for the east symbol.
- * Between two computation positions, the symbol in $\{0, 1\}$ is transported.
- * On the rightmost position of the line, the east symbols of the two tiles of the first and second words are equal. This means that the increment is transmitted from the second to the first word.

- **Transfer the transformed value in direction \mathbf{e}^3 :** On each of the positions \mathbf{u} in the line, for the third word, the north (resp. south) symbol is equal to the south (resp. north) symbol of the position $\mathbf{u} + \mathbf{e}^3$ (resp. $\mathbf{u} - \mathbf{e}^3$) of the same word.

- **Rotation mechanism:**

- For all \mathbf{u} in the line, except the rightmost (resp. leftmost) one, the south symbol of the tile in the first (resp. second) word on position $\mathbf{u} + \mathbf{e}^3$ is equal to the north symbol of the first (resp. second) word on position $\mathbf{u} + \mathbf{e}^1$ (resp. $\mathbf{u} - \mathbf{e}^1$).
- When \mathbf{u} is the rightmost (resp. leftmost) position of the line, the south symbol of the tile in the first (resp. second) word is equal to the north symbol of the tile in the second (resp. first) word on position \mathbf{u} .

Global behavior:

In some particular sub-units of the odd order cells is supported a counter called system counter. The localization of this sub-unit depends on the class of the level modulo 4: if this class is $\bar{1}$, the sub-unit is $(\bar{2}, \bar{5})$ and $(\bar{5}, \bar{2})$ when the class is $\bar{3}$.

The value of the counter is the product of three words on the same alphabet \mathcal{E} . The third word is incremented in direction \mathbf{e}^3 in each of the sections (except for the suspension step) and when it reaches the maximal value, it triggers the incrementation of the second value, which consists in the concatenation of the two other words. Moreover, this value is rotated between each couple of sections \mathbb{Z}_c^2 and \mathbb{Z}_{c+1}^2 . Since the number of column in each of the sub-units is 2^{n-3} , the period of the system counter is

$$2^{4 \cdot 2^m \cdot 2^{n-3}} + 1 = 2^{2^{m+n-1}} + 1.$$

9 Information transports

In this section we describe the various information transfers in this construction. In Section 9.1 we describe how to color the diagonal of some of the sub-units, in order to change the direction of information transport. This mechanism will be used in the following subsections. In Section 9.2 we describe how the system counter information is transported to the walls of each cell. Section 9.3.1 is devoted to the description of information transfers relative to the linear counter inside the cells and Section 9.4 to information transfers between cells having the same level.

9.1 Structure for direction changes of information transport

Symbols:



The symbols of this sublayer are \square and \square .



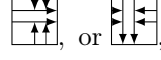

Local rules:

- **Localization:** the petals are superimposed with non blank symbols, and other positions with blank one.
- **Transmission:** the symbols are transmitted through the petals except on **transformation positions**, defined to be the positions where a support petal intersects the transmission petal just above in the hierarchy.
- **Transformation:**
 - When the symbol in the functional specialization sublayer is in $\mathbb{Z}/4\mathbb{Z}$ or $\mathbb{Z}/4\mathbb{Z}^2$, the symbol in the present layer is \square . When it is \blacksquare , the symbol in this layer is \square .
 - When the symbol is in $\mathbb{Z}/4\mathbb{Z}^3$, the symbol can be \square or \square . On a transformation position, the symbol on the position is equal to the positions in the same support petal in the neighborhood. If both the symbol on this position and on the neighbors positions in the transmission petal in the functional specialization sublayer is in $\mathbb{Z}/4\mathbb{Z}^3$, then the symbol on the transformation position is as follows:

1. If the symbol in the Robinson layer is



meaning that the transformation position is in the north west part of the support petal, and the orientation symbol is , then the symbol on the transmission petal is . For the orientations, the transformation is already determined by the first rule.

2. When the transformation position is in the south east part and the orientation is , the symbol on the transmission petal is also .
3. When the transformation position is in the south west part and the orientation is  (or north east and ) then the symbol on the transmission petal is . See an illustration of these rules on Figure 13.

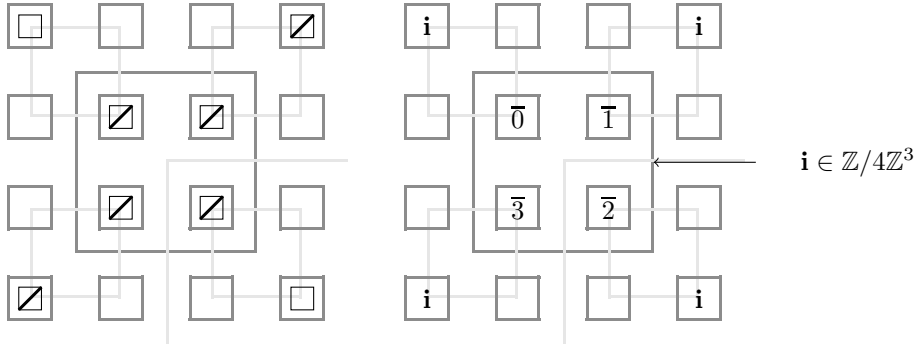



Figure 13: Schematic illustration of special case of the transformation rules for the structures of direction changes when the order of the central cell is ≥ 3 .

Global behavior:

As a consequence of the hierarchical signaling process described by the local rules, each position superimposed with a blue corner in the Robinson layer is superimposed with  or . The positions having the first symbol are on the diagonal of a sub-unit of an order ≥ 3 cell.

9.2 Random channels

In this section we give details on the transport of the system counter symbols through channels which depend on the modularity of the level of cells.

We describe in Section 9.2.1 how the information is transported to the border of the green area on Figure 6. In Section 9.2.2 we describe the transport to the border of the cell. This is where the transport depends on the modularity mark.

9.2.1 Transport of the simulating bit to the border of the modularity mark area

Symbols:

This sublayer has symbols in \mathcal{E} and a blank symbol.

Local rules:

- **Localization:**

- The non-blank symbols are superimposed on and only on sub-units $(\bar{k}, \bar{4})$ for $k \in \llbracket 1, 6 \rrbracket$ and $(\bar{2}, \bar{k})$ for $k \in \llbracket 1, 6 \rrbracket$ when the modularity mark is $\bar{1}$. When the modularity mark is $\bar{3}$, these sub-units are $(\bar{k}, \bar{1})$ for $k \in \llbracket 1, 6 \rrbracket$ and $(\bar{5}, \bar{k})$ for $k \in \llbracket 1, 6 \rrbracket$. When the modularity mark is $\bar{0}$ or $\bar{2}$, all the symbols are blank.
- On the sub-units $(\bar{k}, \bar{4})$ or $(\bar{k}, \bar{1})$ the non-blank symbols are on the leftmost column. On sub-units $(\bar{2}, \bar{k})$ or $(\bar{5}, \bar{k})$ they are on the bottommost row.
- **Transmission:** The symbol is transmitted through sub-units $(\bar{k}, \bar{4})$ or $(\bar{k}, \bar{1})$ and through sub-units $(\bar{2}, \bar{k})$ or $(\bar{5}, \bar{k})$.
- **Synchronization:** On the sub-unit $(\bar{5}, \bar{2})$ or $(\bar{2}, \bar{5})$, on the leftmost and bottommost position, the symbol is equal to the symbols on the top, bottom, left and right in this layer, and to the first bit of the second value of the system counter.

9.2.2 Transport to the border of the cell

In this layer we describe how this simulating bit is transported to the border of the cells. This transport use channels which depend on the modularity mark, so that it is 'not known' locally, on the location of the system bits, if these bits are simulated by the system counter, since while the counter is not 'seen' locally it is still possible that the counter undertook the other channel.

Symbols:

This sublayer has symbols in \mathcal{E} and a blank symbol.

Local rules:

- **Localization:** The non-blank symbols can be superimposed only on the bottom line of sub-units $(\bar{0}, \bar{1})$, $(\bar{0}, \bar{4})$, $(\bar{7}, \bar{1})$, $(\bar{7}, \bar{4})$ and the leftmost column of sub-units $(\bar{2}, \bar{0})$, $(\bar{2}, \bar{7})$, $(\bar{5}, \bar{0})$, $(\bar{5}, \bar{7})$.
- **Transmission:** Through the border of these sub-units with the modularity mark area, the symbol is transmitted.
- **Evaluation:** Through the border with the cell, the symbol is equal to the system bit if not blank.

9.2.3 Global behavior

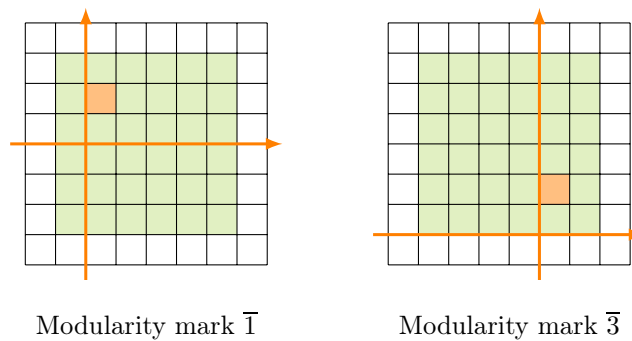

Figure 14: Random channels and communication of the system counter information to the border of the cell

The consequence of the local rules is that the symbols of the system counter layer are transported through channels depending on the modularity mark, as on Figure 14. Moreover, when crossing the location of the system bit, meaning the south or the west border of the cell, the system bit is determined by the counter value, according to the specified position in the counter.

9.3 Transport of the linear counter

In this section we describe the transport of information relative to the linear counter: simple transport in Section 9.3.1 and extraction towards the machine area in Section 9.3.2.

9.3.1 Transmission of the counter information

Symbols:

The symbols in this layer are elements of the sets $\mathcal{A}_c \times \{\blacksquare, \square\}$, $\mathcal{A}_c^2 \times \{\blacksquare, \square\}$ and $\{\blacksquare, \square\}$ and a blank symbol. The set \mathcal{A}_c is described in Annex C.

Local rules:

- **Localization:**

- The non-blank symbols are superimposed on sub-units $(\bar{0}, \bar{3}), (\bar{0}, \bar{7}), (\bar{1}, \bar{3}), (\bar{1}, \bar{4}), (\bar{1}, \bar{5}), (\bar{1}, \bar{6}), (\bar{1}, \bar{7}), (\bar{3}, \bar{k})$ for all $k \in \llbracket 0, 7 \rrbracket$, $(\bar{4}, \bar{3}), (\bar{5}, \bar{3}), (\bar{6}, \bar{3}), (\bar{7}, \bar{3}), (\bar{7}, \bar{4}), (\bar{7}, \bar{5}), (\bar{7}, \bar{6}), (\bar{7}, \bar{7}), (\bar{6}, \bar{7}), (\bar{5}, \bar{7})$ and $(\bar{4}, \bar{7})$.
- On these sub-units, all the positions of the cytoplasm are superimposed with a color in $\{\blacksquare, \square\}$.
- On sub-units $(\bar{0}, \bar{3}), (\bar{0}, \bar{7}), (\bar{4}, \bar{3}), (\bar{4}, \bar{7}), (\bar{6}, \bar{3}), (\bar{6}, \bar{7})$, the information transfer lines are superimposed also with an element of \mathcal{A}_c .
- On sub-units $(\bar{1}, \bar{3}), (\bar{1}, \bar{7}), (\bar{3}, \bar{3}), (\bar{3}, \bar{5}), (\bar{3}, \bar{7}), (\bar{5}, \bar{3}), (\bar{5}, \bar{7}), (\bar{7}, \bar{3}), (\bar{7}, \bar{5}), (\bar{7}, \bar{7})$ the computation positions are superimposed with an element of \mathcal{A}_c^2 and the other information transfer lines and columns are superimposed with an element of \mathcal{A}_c .
- On the other sub-units in the first localization rule, the information transfer columns are superimposed with an element of \mathcal{A}_c .

- **Transmission:**

- The symbols in \mathcal{A}_c are transmitted along the information transfer lines and columns. In sub-units of the third localization rule, the propagation is stopped at computation positions.
- On these positions, the first symbol of \mathcal{A}_c^2 is transmitted vertically and the other one horizontally.
- Across the border of two horizontally (resp. vertically) adjacent of these sub-units, the second (resp. first symbol) or the unique symbol in \mathcal{A}_c is transmitted.

- **Deviation:** On the positions marked with \square , on the sub-units of the third localization rule, the two elements of the pair \mathcal{A}_c^2 are equal.

Global behavior:

The information of the linear counter is transported through a circuit in all the cells, which is represented by blue arrows on Figure 6.

9.3.2 Extraction mechanism

Symbols:

Elements of $\mathcal{A}' \times \mathcal{Q} \times \{\text{on}, \text{off}\}$, of $\mathcal{Q} \times \{\text{on}, \text{off}\}$, of \mathcal{Q} , of $\{\rightarrow, \leftarrow\}$ and a blank symbol.

Local rules:

- **Localization:** the non-blank symbols are superimposed on information transfer lines of sub-units $(\overline{4}, \overline{5})$ (elements of $\mathcal{Q} \times \{\text{on}, \text{off}\}$) and $(\overline{6}, \overline{5})$ (elements of \mathcal{Q}) and on the information transfer columns of sub-units $(\overline{5}, \overline{4})$ (elements of $\mathcal{A}' \times \mathcal{Q} \times \{\text{on}, \text{off}\}$) and $(\overline{5}, \overline{6})$ (elements of $\{\rightarrow, \leftarrow\}$).
- **Transmission:** Across the border of these sub-units with sub-units of the last sub-layer, the symbol is equal to the corresponding part of \mathcal{A}_c in the first (resp. second) symbol of the pair for sub-units $(\overline{5}, \overline{4})$ and $(\overline{5}, \overline{6})$ (resp. $(\overline{4}, \overline{5})$ and $(\overline{6}, \overline{5})$).

9.4 Intercellular transport

The last transport mechanism to describe is the intercellular transport, which allows the counters values to be synchronized between cells having the same level and in the same section \mathbb{Z}_c^2 .

Symbols:

The symbols of this layer are symbols in \mathcal{G} or \mathcal{G}^2 , where symbols of \mathcal{G} are pairs of a symbol in the alphabet of the linear counter together with symbol in the simulating bit layer. We add also a blank symbol.

Local rules:

- **Localization:** The non blank symbols are superimposed on and only on positions with a blue corner in the structure layer and a non-blue symbol in the functional areas layer [Annex B.2], meaning non-computation positions. On the positions with an arrow, the symbol is in \mathcal{G} , and on the position with a light gray symbol, \square , the symbol is in \mathcal{G}^2 .
- **Transmission:**
 - On the positions with \square , the first (resp. second) symbol is transmitted to the next functional positions vertically (resp. horizontally).
 - On positions with arrow symbol, the symbol is transmitted to the next position in direction orthogonal to the arrow.

Global behavior:

The consequence of the local rules is that the information of the linear counter of each cell, as well as the simulating bit if any, is transmitted to the next cells having the same order in directions \mathbf{e}^1 and \mathbf{e}^2 . Thus, these informations are synchronized for cells having the same level over a section.

10 Proof of Theorem 1

10.1 Simulation

In this section we prove that for any of the dynamical systems (Z, f) , the subshift $X_{(Z, f)}$ simulates (Z, f) , by defining a function φ .

Given a configuration x of $X_{(Z, f)}$, $\varphi(x)$ is the sequence $(\epsilon_n)_n$ such that for all n , ϵ_n is the system bit written on order $2n$ two-dimensional cells in section \mathbb{Z}_0^2 .

This function is **computable**: in order to compute $\varphi(x)$, consider successively the patterns $x_{\llbracket -N, N \rrbracket^3 \cap \mathbb{Z}_0^2}$ for all N and for all $n \geq N$ search for a complete order $2n$ two-dimensional cell. If there is one, then $\varphi(x)_n$ is the system bit with which the border of the cell is colored.

Moreover, this function is **onto**. Indeed, from any configuration z in Z , one can construct some configuration x in $X_{(Z, f)}$ whose image by φ is z , by writing the sequences $f^c(z)$ in sections \mathbb{Z}_c^2 . This is possible since f is onto.

10.2 Minimality

10.2.1 Completing patterns

Proposition 1. *Any pattern in the language of $X_{(Z,f)}$ is sub-pattern of a pattern on some $\llbracket n_1, m_1 \rrbracket \times \llbracket n_2, m_2 \rrbracket \times \llbracket n_3, m_3 \rrbracket$ in the language of $X_{(Z,f)}$ whose projection on a section \mathbb{Z}_c^2 is a cell of the Robinson subshift.*

Let P some n block in the language of $X_{(Z,f)}$ which appears in some configuration x . Let us prove that it can be completed into a stack of two-dimensional cells. We follow some order in the layers for the completion. First we complete the pattern in the structure layer, then in the functional areas layer, the linear counter and machine layers and then the system counter.

10.2.1.1 Completion of the structure and functional areas When the projection of the pattern P on a section \mathbb{Z}_c^2 and on the Robinson sublayer is a sub-pattern of an infinite supertile of x in \mathbb{Z}_c^2 , this is clear that the projection of P into the structure layer can be completed into a finite supertile in the configuration x .

When this projection crosses the separating area between the supports of the infinite supertiles, as in the proof of Proposition 6, we can still complete the projection of P over the structure layer into great enough supertile, this time the supertile does not appear directly in the configuration x .

This supertile can be completed then into a cell. The order of this cell is denoted n_0 . When the part of the cell containing the modularity mark of this cell is known, we choose n_0 according to this mark (there is no contradiction with other information since the system bits are not known in this part). When this is not the case, we choose n_0 to be odd, and the modularity is chosen according to the location of the random channel if there is any in the pattern P .

Then we complete the functional areas layer according to the hierarchical signaling process.

At this point, we have a completion of the pattern P in the structure layer and functional areas layer as a stack of cells.

10.2.1.2 Completion of the counters and machines computations In the following paragraphs, we tell how to complete the pattern over this stack of cells in the linear counter, system counter and machines layers. For the order $n < n_0$ cell, these layers can be completed according to the configuration x . The difficulty comes from completing these layers over the proper positions of the order n_0 cell.

The projection of the pattern P over a section \mathbb{Z}_c^2 intersects at most four sub-units. We have to explain how to complete the pattern in a section according to the cases when it intersects (with increasing difficulty) information transport sub-units, demultiplexers, counters incrementation sub-units, machine sub-units. We can consider these intersections independently since when the pattern intersects two adjacent sub-units, the connection rule between the sub-units is verified inside the pattern P and we complete the two sub-units so that the rules are verified.

10.2.1.3 Intersection with information transfer areas In the case when the pattern intersects information transfer areas, the only restriction is that the added symbols in the direction of transfer agree with the symbols in P , which is always possible.

10.2.1.4 Intersection with a demultiplexer When the pattern intersects a demultiplexer, there are two possible cases: the pattern intersects the synchronizing diagonal or not. Let us consider the second case first. In this case, we can consider without loss of generality that the known part of the demultiplexer is the south east part. In this case, we have to complete the leftmost columns and the topmost rows according to the pattern P . This is possible since P does not intersect these columns and rows. All the other symbols can be chosen freely. In the first case, one the only restriction is that the added columns and rows agree on the diagonal, and again this is possible since the pattern P does not intersect them.

10.2.1.5 Intersection with the linear counter incrementation sub-unit Considering the intersection with the linear counter incrementation sub-unit, the completion depends on where the pattern intersects it.

1. when the pattern intersects the east part or only the inside of the area, the completion is as for information transfer areas;
2. when knowing a part of the west, the symbols are added according to the freezing signal and the incrementation signal. If the freezing signal on the two sides of the leftmost column is different, the freezing signal is imposed to be ■ all along the column and the symbols are forced to be c_{\max} . When this is not the case, the symbols can be chosen freely except that one of them has to be different from c_{\max} . On the bottom however, if there is a freezing signal ■ in the known part, the symbols have to be c_{\max} , which is coherent with the knowledge the pattern has. If not, then these symbols can also be chosen freely.

The completion of the system counter area is similar. The main difference is the rotation mechanism which implies no difficulty for the completion.

10.2.1.6 Intersection with the machine area This part is similar to the corresponding part in [GS17b] and we refer to Annex E.

10.2.1.7 Intersection with the system bits When the pattern intersects the system bits location, these bits are chosen according to the configuration x . When this is not the case, n_0 is chosen odd and we choose the bits for the order n_0 cell according to the value of the system counter.

10.2.2 Recovering system bits and counter values

In this section we prove that the subshift $X_{(Z,f)}$ is minimal. This proof relies first on the following lemma:

Lemma 1 (Globach's theorem). *The numbers $F_i = 2^{2^i} + 1$, $n \geq 0$ are coprime.*

Proof. Let $i > j \geq 0$. Then

$$\begin{aligned} F_i = 2^{2^i} + 1 &= (2^{2^j} + 1 - 1)^{2^{i-j}} + 1 = \sum_{k=0}^{2^{i-j}} \binom{2^{i-j}}{k} (-1)^{-k} F_n^k + 1 \\ &= F_j \sum_{k=1}^{2^{i-j}} \binom{2^{i-j}}{k} (-1)^k F_n^{k-1} + 2 \end{aligned}$$

This means that a common divisor of F_j and F_i divide 2, but 2 does not divide F_j , so F_j and F_i are coprime. \square

Consider some block P in the language of X , and complete it into a pattern P' using Proposition 1. Pick some configuration $x' \in X$ and some stack of order n_0 cells in this configuration having the same height as P' .

Let \mathcal{T} be the following application:

$$\begin{aligned} \mathcal{T} : \mathbb{Z}/p_1\mathbb{Z} \times \dots \times \mathbb{Z}/p_k\mathbb{Z} &\rightarrow \mathbb{Z}/p_1\mathbb{Z} \times \dots \times \mathbb{Z}/p_k\mathbb{Z} \\ (i_1, \dots, i_k) &\mapsto (i_1 + 4^{(2^k-1)p}, \dots, i_k + 1) \end{aligned}$$

where p_1, \dots, p_k are the periods of k linear counters contained in the order n_0 cell. This is a minimal application, meaning that for all $\mathbf{i}, \mathbf{j} \in \mathbb{Z}/p_1\mathbb{Z} \times \dots \times \mathbb{Z}/p_k\mathbb{Z}$, there exists some n such that

$\mathcal{T}^n(\mathbf{i}) = \mathbf{j}$. Indeed, considering some \mathbf{i} , denote n_1 the smallest positive integer such that $\mathcal{T}^{n_1}(\mathbf{i}) = \mathbf{i}$. This means that p_j divides $n_1 4^{(2^k - 2^j)p}$ for all j , and because p_j is a Fermat number, it is odd, and this implies that p_j divides n_1 . For the numbers p_j are coprime (Lemma 1), this implies that $p_1 \times \dots \times p_j$ divides n_1 . Because this number is a period of the application \mathcal{T} , this means that $p_1 \times \dots \times p_j$ is the smallest period of every element of $\mathbb{Z}/p_1\mathbb{Z} \times \dots \times \mathbb{Z}/p_k\mathbb{Z}$ under the application \mathcal{T} .

As a consequence, for all \mathbf{i} , the finite sequence $(\mathcal{T}^n(\mathbf{i}))$, for n going from 0 to $p_1 \times \dots \times p_k - 1$, takes all the possible values in $\mathbb{Z}/p_1\mathbb{Z} \times \dots \times \mathbb{Z}/p_k\mathbb{Z}$.

By jumping from one order n_0 cell to the next one in direction \mathbf{e}^2 multiple time one can find in x' a stack of cells so that the values of the linear counters in this pattern are those of P' .

By jumping in direction \mathbf{e}^3 , and since the application

$$\mathcal{T}' : \mathbb{Z}/q_1\mathbb{Z} \times \dots \times \mathbb{Z}/q_{k'}\mathbb{Z} \rightarrow \mathbb{Z}/q_1\mathbb{Z} \times \dots \times \mathbb{Z}/q_{k'}\mathbb{Z} \\ (i_1, \dots, i_{k'}) \mapsto (i_1 + 1, \dots, i_{k'} + 1) ,$$

where $q_1, \dots, q_{k'}$ are the periods of the system counters contained in the pattern P' is also minimal, one can find a stack of n_0 order cells with the same values for the system counters as in P' . Since the linear counters are synchronized in this direction, the values of the linear counters are also those of P' .

Now we make use of the following lemma:

Lemma 2 ([DR17]). *Let W be a minimal \mathbb{Z} -subshift, w one of its elements and p some pattern that appears in w on position $u \in \mathbb{Z}$. For all integer $N > 0$, there exists some t integer such that p appears in x on position $u + Nt$.*

We take $N = q_1 \dots q_k$, and denote h the height of P' , and r the number of even level of cells included in P' . Let us consider W the subshift on $(\mathcal{A}^r)^h$ such that for a position $\mathbf{u} \in \mathbb{Z}$, the symbol on $\mathbf{u} + 1$ has its $h - 1$ first r -uplets equal to the $h - 1$ last ones of the one on position \mathbf{u} . Moreover, two consecutive of r -uplets have to be possibly completed into elements of Z such that the second one is the image by f of the first one. In other words, W is obtained from (Z, f) by factoring onto the r first bits and then by concatenating h consecutive of sequences of r bits.

The subshift W is minimal. By applying Lemma 2 to the sequence in W obtained by restricting to the non simulated system bits in the columns of x' containing the pattern P' , such that the position $\mathbf{0} \in \mathbb{Z}$ corresponds to the bottom section of P' , one can recover the non-simulated system bits of P' by shifting Nt times in direction \mathbf{e}^3 , where t the integer given by the lemma. This does not change the linear counter values or the system counter values, since N is a multiple of all the periods of the system counters contained in the stack of cells.

As a consequence, P' appears in x' . This proves the minimality.

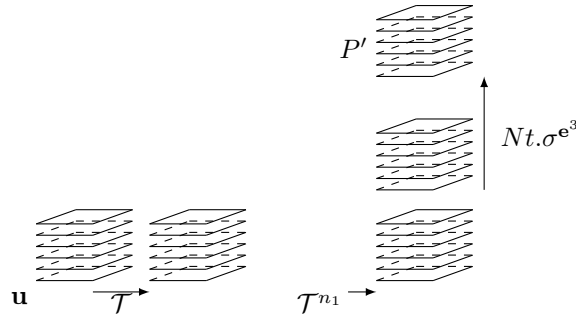

Figure 15: Schema of the proof for the minimality property of $X_{(Z,f)}$.

A A rigid three-dimensional version of the Robinson subshift

The Robinson subshift was constructed by R. Robinson [Rob71] in order to prove undecidability results. It has been used by in other constructions of subshifts of finite type as a structure layer [PS15].

In this section, we present a version of this subshift which is adapted to constructions under the dynamical constraints that we consider. In order to understand this section, it is preferable to read before the description of the Robinson subshift done in [Rob71]. The results of this section are well known. We refer to [Rob71] and [GS17b].

Let us denote X_R this subshift, which is constructed as the product of two layers. We present the first layer in Section A.1, and then describe some hierarchical structures appearing in this layer in Section A.2. In Section A.3, we describe the second layer. This layer allows adding rigidity to the first layer, in order to enforce dynamical properties.

A.1 Robinson subshift

The first layer has the following *symbols*, and their transformation by rotations by $\frac{\pi}{2}$, π or $\frac{3\pi}{2}$:

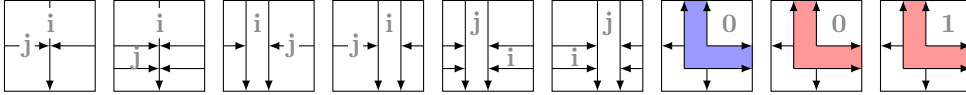

The symbols i and j can have value 0, 1 and are attached respectively to vertical and horizontal arrows. In the text, we refer to this value as the value of the 0, 1-**counter**. In order to simplify the representations, these values will often be omitted on the figures.

In the text we will often designate as **corners** the two last symbols. The other ones are called **arrows symbols** and are specified by the number of arrows in the symbol. For instance a six arrows symbols are the images by rotation of the fifth and sixth symbols.

The *rules* are the following ones:

1. the outgoing arrows and incoming ones correspond for two adjacent symbols. For instance, the pattern

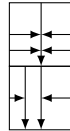

is forbidden, but the pattern

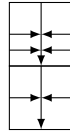

is allowed.

2. in every 2×2 square there is a blue symbol and the presence of a blue symbol in position $\mathbf{u} \in \mathbb{Z}^2$ forces the presence of a blue symbol in the positions $\mathbf{u} + (0, 2)$, $\mathbf{u} - (0, 2)$, $\mathbf{u} + (2, 0)$ and $\mathbf{u} - (2, 0)$.
3. on a position having mark (i, j) , the first coordinate is transmitted to the horizontally adjacent positions and the second one is transmitted to the vertically adjacent positions.

4. on a six arrows symbol, like



or a five arrow symbol, like



the marks i and j are different.

The Figure 16 shows some pattern in the language of this layer. The subshift on this alphabet and generated by these rules is denoted X_R : this is the Robinson subshift.

In the following, we state some properties of this subshift. The proofs of these properties can also be found in [Rob71].

A.2 Hierarchical structures

In this section we describe some observable hierarchical structures in the elements of the Robinson subshift.

Let us recall that for all $d \geq 1$ and $k \geq 1$, we denote $\mathbb{U}_k^{(d)}$ the set $[[0, k - 1]]^d$.

A.2.1 Finite supertiles

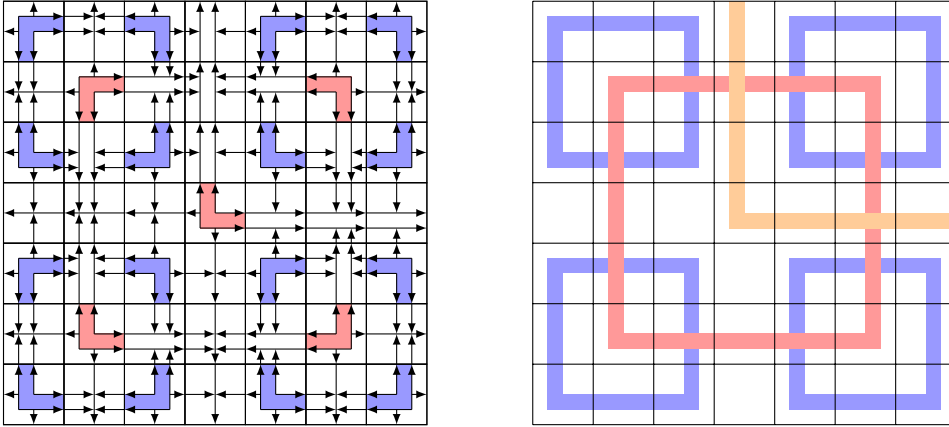

Figure 16: The south west order 2 supertile denoted $St_{sw}(2)$ and petals intersecting it.

Let us define by induction the south west (resp. south east, north west, north east) **supertile of order** $n \in \mathbb{N}$. For $n = 0$, one has

$$St_{sw}(0) = \begin{array}{|c|} \hline \uparrow \\ \hline \leftarrow \downarrow \rightarrow \\ \hline \end{array}, \quad St_{se}(0) = \begin{array}{|c|} \hline \uparrow \\ \hline \leftarrow \downarrow \rightarrow \\ \hline \end{array}, \quad St_{nw}(0) = \begin{array}{|c|} \hline \uparrow \\ \hline \leftarrow \downarrow \rightarrow \\ \hline \end{array}, \quad St_{ne}(0) = \begin{array}{|c|} \hline \uparrow \\ \hline \leftarrow \downarrow \rightarrow \\ \hline \end{array}.$$

For $n \in \mathbb{N}$, the support of the supertile $St_{sw}(n+1)$ (resp. $St_{se}(n+1)$, $St_{nw}(n+1)$, $St_{ne}(n+1)$) is $\mathbb{U}_{2^{n+2}-1}^{(2)}$. On position $\mathbf{u} = (2^{n+1} - 1, 2^{n+1} - 1)$ write

$$St_{sw}(n+1)_{\mathbf{u}} = \begin{array}{|c|} \hline \uparrow \\ \hline \leftarrow \downarrow \rightarrow \\ \hline \end{array}, \quad St_{se}(n+1)_{\mathbf{u}} = \begin{array}{|c|} \hline \uparrow \\ \hline \leftarrow \downarrow \rightarrow \\ \hline \end{array}, \quad St_{nw}(n+1)_{\mathbf{u}} = \begin{array}{|c|} \hline \uparrow \\ \hline \leftarrow \downarrow \rightarrow \\ \hline \end{array}, \quad St_{ne}(n+1)_{\mathbf{u}} = \begin{array}{|c|} \hline \uparrow \\ \hline \leftarrow \downarrow \rightarrow \\ \hline \end{array}.$$

Then complete the supertile such that the restriction to $\mathbb{U}_{2^{n+1}-1}^{(2)}$ (resp. $(2^{n+1}, 0) + \mathbb{U}_{2^{n+1}-1}^{(2)}$, $(0, 2^{n+1}) + \mathbb{U}_{2^{n+1}-1}^{(2)}$, $(2^{n+1}, 2^{n+1}) + \mathbb{U}_{2^{n+1}-1}^{(2)}$) is $St_{sw}(n)$ (resp. $St_{se}(n)$, $St_{nw}(n)$, $St_{ne}(n)$).
 Then complete the cross with the symbol



or with the symbol



in the south vertical arm with the first symbol when there is one incoming arrow, and the second when there are two. The other arms are completed in a similar way. For instance, Figure 16 shows the south west supertile of order two.

Proposition 2 ([Rob71]). *For all configuration x , if an order n supertile appears in this configuration, then there is an order $n + 1$ supertile, having this order n supertile as sub-pattern, which appears in the same configuration.*

A.2.2 Infinite supertiles

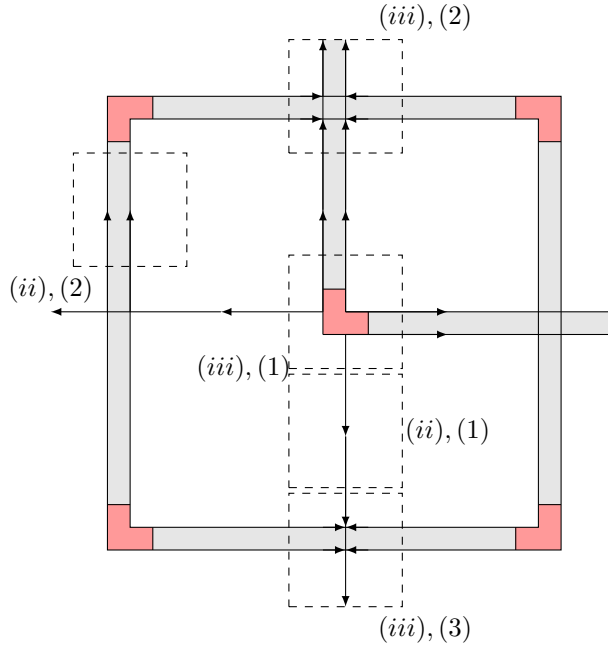

Figure 17: Correspondence between infinite supertiles and sub-patterns of order n supertiles. The whole picture represents a schema of some finite order supertile.

Let x be a configuration in the first layer and consider the equivalence relation \sim_x on \mathbb{Z}^2 defined by $\mathbf{i} \sim_x \mathbf{j}$ if there is a finite supertile in x which contains \mathbf{i} and \mathbf{j} . An **infinite order** supertile is an infinite pattern over an equivalence class of this relation. Each configuration is amongst the following types (with types corresponding with types numbers on Figure 17):

- (i) A unique infinite order supertile which covers \mathbb{Z}^2 .

- (ii) Two infinite order supertiles separated by a line or a column with only three-arrows symbols (1) or only four arrows symbols (2). In such a configuration, the order n finite supertiles appearing in the two infinite supertiles are not necessary aligned, whereas this is the case in a type (i) or (iii) configuration.
- (iii) Four infinite order supertiles, separated by a cross, whose center is superimposed with:
 - a red symbol, and arms are filled with arrows symbols induced by the red one. (1)
 - a six arrows symbol, and arms are filled with double arrow symbols induced by this one. (2)
 - a five arrow symbol, and arms are filled with double arrow symbols and simple arrow symbols induced by this one. (3)

Informally, the types of infinite supertiles correspond to configurations that are limits (for type (ii) infinite supertiles this will be true after alignment [Section A.3]) of a sequence of configurations centered on particular sub-patterns of finite supertiles of order n . This correspondence is illustrated on Figure 17. We notice this fact so that it helps to understand how patterns in configurations having multiple infinite supertiles are sub-patterns of finite supertiles.

We say that a pattern p on support \mathbb{U} appears periodically in the horizontal (resp. vertical) direction in a configuration x of a subshift X when there exists some $T > 0$ and $\mathbf{u}_0 \in \mathbb{Z}^2$ such that for all $k \in \mathbb{Z}$,

$$x_{\mathbf{u}_0 + \mathbb{U} + kT(1,0)} = p$$

(resp. $x_{\mathbf{u}_0 + \mathbb{U} + kT(0,1)} = p$). The number T is called the period of this periodic appearance.

Lemma 3 ([Rob71]). *For all n and m integers such that $n \geq m$, any order m supertile appears periodically, horizontally and vertically, in any supertile of order $n \geq m$ with period 2^{m+2} . This is also true inside any infinite supertile.*

A.2.3 Petals

For a configuration x of the Robinson subshift some finite subset of \mathbb{Z}^2 which has the following properties is called a **petal**.

- this set is minimal with respect to the inclusion,
- it contains some symbol with more than three arrows,
- if a position is in the petal, the next position in the direction, or the opposite one, of the double arrows, is also in it,
- and in the case of a six arrows symbol, the previous property is true only for one pair of arrows.

These sets are represented on the figures as squares joining four corners when these corners have the right orientations.

Petals containing blue symbols are called order 0 petals. Each one intersect a unique greater order petal. The other ones intersect four smaller petals and a greater one: if the intermediate petal is of order $n \geq 1$, then the four smaller are of order $n - 1$ and the greatest one is of order $n + 1$. Hence they form a hierarchy, and we refer to this in the text as the **petal hierarchy** (or hierarchy).

We usually call the petals valued with 1 **support petals**, and the other ones are called **transmission petals**.

Lemma 4 ([Rob71]). *For all n , an order n petal has size $2^{n+1} + 1$.*

We call order n **two dimensional cell** the part of \mathbb{Z}^2 which is enclosed in an order $2n + 1$ petal, for $n \geq 0$. We also sometimes refer to the order $2n + 1$ petals as the cells borders.

In particular, order $n \geq 0$ two-dimensional cells have size $4^{n+1} + 1$ and repeat periodically with period 4^{n+2} , vertically and horizontally, in every cell or supertile having greater order.

See an illustration on Figure 16.

A.3 Alignment positioning

If a configuration of the first layer has two infinite order supertiles, then the two sides of the column or line which separates them are non dependent. The two infinite order supertiles of this configuration can be shifted vertically (resp. horizontally) one from each other, while the configuration obtained stays an element of the subshift. This is an obstacle to dynamical properties such as minimality or transitivity, since a pattern which crosses the separating line can not appear in the other configurations. In this section, we describe additional layers that allow aligning all the supertiles having the same order and eliminate this phenomenon.

Here is a description of the second layer:

Symbols: nw, ne, sw, se , and a blank symbol.

The *rules* are the following ones:

- **Localization:** the symbols nw, ne, sw and se are superimposed only on three arrows and five arrows symbols in the Robinson layer.
- **Induction of the orientation:** on a position with a three arrows symbol such that the long arrow originate in a corner is superimposed a symbol corresponding to the orientation of the corner.
- **Transmission rule:** on a three or five arrows symbol position, the symbol in this layer is transmitted to the position in the direction pointed by the long arrow when the Robinson symbol is a three or five arrows symbol with long arrow pointing in the same direction.
- **Synchronization rule:** On the pattern

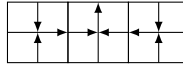

or

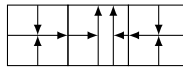

in the Robinson layer, if the symbol on the left side is ne (resp. se), then the symbol on the right side is nw (resp. sw). On the images by rotation of these patterns, we impose similar rules.

- **Coherence rule:** the other pairs of symbols are forbidden on these patterns.

Global behavior: the symbols ne, nw, sw, se designate orientations: north east, north west, south west and south east. We will re-use this symbolisation in the following. The localization rule implies that these symbols are superimposed on and only on straight paths connecting the corners of adjacent order n cells for some integer n .

The effect of transmission and synchronization rules is stated by the following lemma:

Lemma 5 ([GS17b]). *In any configuration x of the subshift X_R , any order n supertile appears periodically in the whole configuration, with period 2^{n+2} , horizontally and vertically.*

A.4 Completing blocks

Let $\chi : \mathbb{N}^* \rightarrow \mathbb{N}^*$ such that for all $n \geq 1$,

$$\chi(n) = \lceil \log_2(n) \rceil + 4.$$

Let us also denote χ' the function such that for all $n \geq 1$,

$$\chi'(n) = \left\lceil \frac{\lceil \log_2(n) \rceil}{2} \right\rceil + 2.$$

The following lemma will be extensively used in the following of this text, in order to prove dynamical properties of the constructed subshifts:

Lemma 6 ([GS17b]). *For all $n \geq 1$, any n -block in the language of X_R is sub-pattern of some order $\chi(n)$ supertile, and is sub-pattern of some order $\chi'(n)$ order cell.*

B Some hierarchical signaling processes

In this section, we present a layer whose purpose is to attribute to the blue corners in the Robinson layer a function relative to the counters and machines.

B.1 Orientation in the hierarchy

The purpose of the first sublayer is to give access, to the support petal of each colored face, to the orientation of this petal relatively to the support petal just above in the hierarchy.

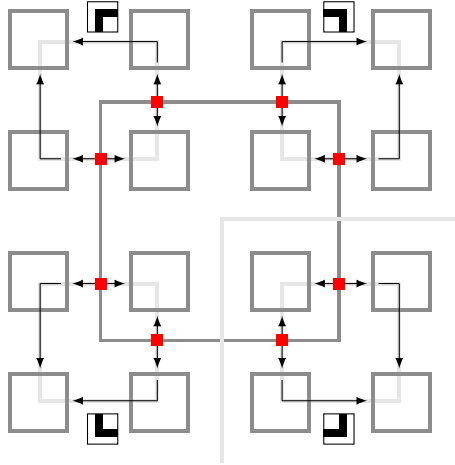

Figure 18: Schematic illustration of the orientation rules, showing a support petal and the support petals just under this one in the hierarchy, all of them colored dark gray. The transmission petals connecting them are colored light gray. Transformation positions are colored with a red square. The arrows give the natural interpretation of the propagation direction of the signal transmitting the orientation information.

Symbols:

The symbols are elements of

$$\left\{ \square, \begin{array}{|c|} \hline \blacksquare \\ \hline \end{array}, \begin{array}{|c|} \hline \blacksquare \\ \hline \end{array}, \begin{array}{|c|} \hline \blacksquare \\ \hline \end{array}, \begin{array}{|c|} \hline \blacksquare \\ \hline \end{array} \right\},$$

$$\{\square, \blacksquare, \blacktriangleright, \blacktriangleleft, \blacklozenge\} \times \{\blacksquare, \blacktriangleright, \blacktriangleleft, \blacklozenge\},$$

and a blank symbol.

Local rules:

- **Localization:** the non blank symbols are superimposed on and only on positions with petal symbols of the gray faces. The symbol is transmitted through the petals, except on transformation positions, defined just below.
- **Transformation positions:** the **transformation positions** are the positions where the transformation rule occurs (meaning that the signal is transformed). These positions depend on the (sub)layer. In this sublayer, these are the positions where a support petal intersects a transmission petal just under in the hierarchy. On these positions is superimposed a **couple of symbols**, in

$$\{\square, \blacksquare, \blacktriangleright, \blacktriangleleft, \blacklozenge\} \times \{\blacksquare, \blacktriangleright, \blacktriangleleft, \blacklozenge\},$$

while the other petal positions are superimposed with a **simple symbol**, in

$$\{\square, \blacksquare, \blacktriangleright, \blacktriangleleft, \blacklozenge\}.$$

On the transmission positions, the first symbol corresponds to outgoing arrows (this is the direction from which the signal comes, that is to say the support petal), and the second one to incoming arrows (this is the direction where the signal is transmitted, after transformation).

- **Transformation:** on a transformation position, the second bit of the couple is \blacksquare if the six arrows symbol is

$$\begin{array}{|c|c|} \hline \blacktriangledown & \blacktriangledown \\ \hline \blacktriangledown & \blacktriangledown \\ \hline \blacktriangleup & \blacktriangleup \\ \hline \blacktriangleup & \blacktriangleup \\ \hline \end{array}, \text{ or } \begin{array}{|c|c|} \hline \blacktriangleright & \blacktriangleright \\ \hline \blacktriangleright & \blacktriangleright \\ \hline \blacktriangleleft & \blacktriangleleft \\ \hline \blacktriangleleft & \blacktriangleleft \\ \hline \end{array}.$$

These positions correspond to the intersection of an order $n+1$ support petal with the **north west** order n transmission petal just under in the hierarchy. *There are similar rules for the other orientations.*

- **Border rule:** on the border of a gray face, the symbol is blank if not on a transmission position. On a transmission position, the first symbol of the couple is blank.

Global behavior:

This layer supports a signal that propagates through the petal hierarchy on the colored faces. This signal is transmitted through the petals except on the intersections of a support petal and a transmission petal just above in the hierarchy. On these positions, the symbol transmitted by the signal is transformed into a symbol representing the orientation of the transmission petal with respect to the support petal.

As a consequence, the support petals just under the transmission petal are colored with this orientation symbol. See the schema on Figure 18.

B.2 Hierarchical constitution of functional areas

We present here the second sublayer.

Symbols:

$$\blacksquare, \square, (\blacksquare, \rightarrow), (\blacksquare, \uparrow), \square \text{ and } \{\blacksquare, \square, (\blacksquare, \rightarrow), (\blacksquare, \uparrow)\}^2.$$

Local rules:

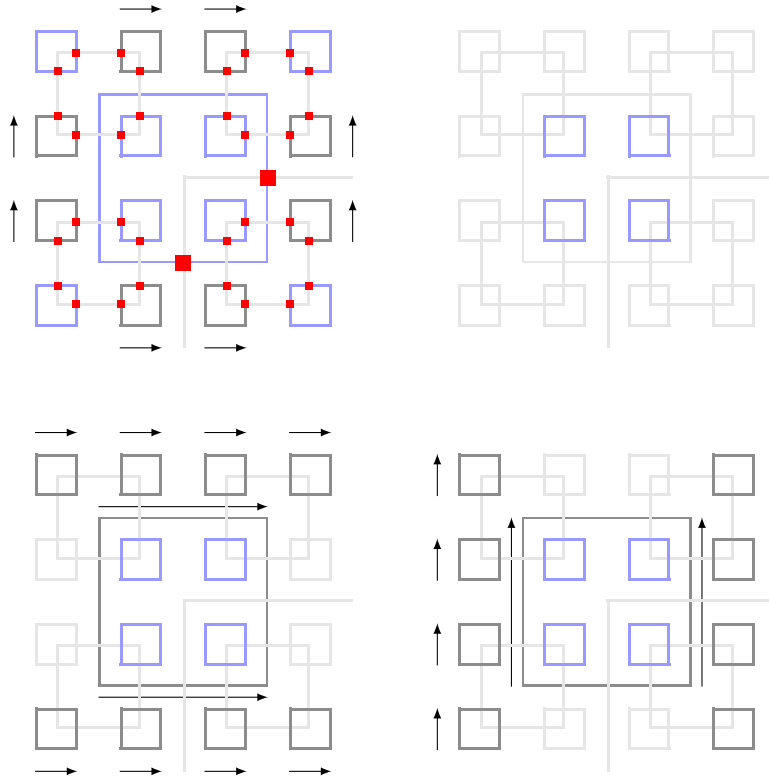

Figure 19: Schematic illustration of the transmission rules of the functional areas sublayer. The transformation positions are marked with red squares on the first schema.

- **Localization:** the non blank symbols are superimposed on and only on petal positions of the colored faces.
- the ordered pairs of symbols are superimposed on six arrows symbols positions where the border of a cell intersects the petal just above in the hierarchy (**transformation positions**).
- the symbols are transmitted through the petals except on transformation positions.
- **Transformation through hierarchy.** On the transformation positions, if the first symbol is \square , then the second one is equal. For the other cases, if the symbol is

$$\begin{array}{|c|c|} \hline \blacktriangledown & \blacktriangledown \\ \hline \blacktriangledown & \blacktriangledown \\ \hline \blacktriangledown & \blacktriangledown \\ \hline \blacktriangledown & \blacktriangledown \\ \hline \end{array}, \text{ or } \begin{array}{|c|c|} \hline \blacktriangledown & \blacktriangledown \\ \hline \blacktriangledown & \blacktriangledown \\ \hline \blacktriangledown & \blacktriangledown \\ \hline \blacktriangledown & \blacktriangledown \\ \hline \end{array},$$

then second color is according to the following rules. The condition on the symbol above corresponds to positions where a support petal intersects the transmission petal just above in the hierarchy and being oriented **north west** with respect to this transmission petal (examples of such positions are represented with large squares on Figure 19).

1. if the orientation symbol is $\begin{array}{|c|c|} \hline \blacksquare & \blacksquare \\ \hline \blacksquare & \blacksquare \\ \hline \blacksquare & \blacksquare \\ \hline \blacksquare & \blacksquare \\ \hline \end{array}$, the second symbol is equal to the first one.
2. if the orientation symbol is $\begin{array}{|c|c|} \hline \blacksquare & \blacksquare \\ \hline \blacksquare & \blacksquare \\ \hline \blacksquare & \blacksquare \\ \hline \blacksquare & \blacksquare \\ \hline \end{array}$, the second symbol is a function of the first one:
 - if the first symbol of the ordered pair is \blacksquare , then the second symbol is $(\blacksquare, \rightarrow)$.
 - if the first symbol is $(\blacksquare, \rightarrow)$, then the second one is equal.
 - if the first symbol is (\blacksquare, \uparrow) , then the second symbol is \square .
3. if the orientation symbol is $\begin{array}{|c|c|} \hline \blacksquare & \blacksquare \\ \hline \blacksquare & \blacksquare \\ \hline \blacksquare & \blacksquare \\ \hline \blacksquare & \blacksquare \\ \hline \end{array}$, the second color is \blacksquare .

4. if the orientation symbol is \square , the second symbol is a function of the first one:
 - if the first symbol of the ordered pair is or \square , then the second symbol is (\square, \rightarrow) .
 - if the first symbol is (\square, \rightarrow) , then the second one is \square .
 - if the first symbol is (\square, \uparrow) , then the second symbol is equal.

For the other orientations of the support petal with respect to the transmission petal just above, the rules are obtained by rotation.

See Figure 19 for an illustration of these rules.

- **Coherence rules:** We impose rules that allow the infinite areas to be coherent with the finite ones. For instance, the nearest blue corner to the corner of a cell and which is inside this cell has to be colored blue in this sublayer. The other rules impose similar constraints on middles and quarters of the cell's walls.

Global behavior:

The result of the process presented in the local rules is that the borders of the order zero cells are colored with a color which represents a **function** of the blue corners positions - called **functional positions** - included in the zero order petal just under this petal in the petal hierarchy. These symbols and functions are as follows:

- **blue** if the set of columns and the set of lines in which it is included do not intersect larger order two-dimensional cells. The associated function is to **support a step of computation** (which can be just to transfer the information in the case when the face support a counter), and the corresponding positions are called **computation positions**.
- an **horizontal** (resp. vertical) **arrow** directed to the right (resp. to the top) when the set of columns (resp. lines) containing this petal intersects larger order two-dimensional cells but not the set of lines (resp. columns) containing it. The associated function is to **transfer information** in the direction of the arrow (this information can be trivial in the case when the face support a counter. This means that the symbol transmitted is the blank symbol), and the corresponding positions are called **information transfer positions**.
- when the two sets intersect larger order cells, the petal is colored **light gray**. These positions have no function.

C Linear counter layer

The construction model of M. Hochman and T. Meyerovitch [HM10] implies degenerated behaviors of the Turing machines. For this reason, in order to preserve the minimality property, we use a counter which alternates all the possible behaviors of these machines. We describe this counter here.

In Section C.0.1 we give some notations used in the construction of this layer. In Section C.0.2 we describe the incrementation mechanism of the linear counter. The rules for the information transport will be described later.

C.0.1 Alphabet of the linear counter

Let $l \geq 1$ be some integer, and \mathcal{A}' , \mathcal{Q} and \mathcal{D} some finite alphabets such that $|\mathcal{A}'| = |\mathcal{Q}| = 2^{2^l}$, and $|\mathcal{D}| = 2^{4 \cdot 2^{l-2}}$. Denote \mathcal{A}_c the alphabet $\mathcal{A}' \times \mathcal{Q}^3 \times \mathcal{D} \times \{\leftarrow, \rightarrow\} \times \{\text{on}, \text{off}\}^2$.

The alphabet \mathcal{A}' will correspond to the alphabet of the working tape of the Turing machine after completing it such that it has cardinality equal to 2^{2^l} (this is possible by adding letters

that interact trivially with the machine heads, and taking l great enough). The alphabet \mathcal{Q} will correspond to the set of states of the machine (after similar completion). The arrows will give the direction of the propagation of the error signal. The elements of the set $\{\text{on}, \text{off}\}^2$ are a coefficients telling which ones of the lines and columns are active for computation (which has an influence on how each computation positions work), and the alphabet \mathcal{D} is an artifact so that the cardinality of \mathcal{A}_c is $2^{2^{l+3}}$, in order for the counter to have a period equal to a Fermat number.

Let us fix s some cyclic permutation of the set \mathcal{A}_c , and \mathbf{c}_{\max} some element of \mathcal{A}_c .

C.0.2 Incrementation

Symbols:

The elements of $(\mathcal{A}_c \times \{0, 1\}) \times \{\blacksquare, \square\}$. The elements of $(\mathcal{A}_c \times \{0, 1\})$ are thought as the following tiles. The first symbol represents the south symbol in the tile, and the second one representing the west symbol in the tile:

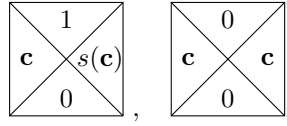

for $\mathbf{c} \neq \mathbf{c}_{\max}$, and

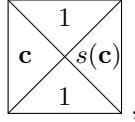

for $\mathbf{c} = \mathbf{c}_{\max}$.

The second is called the **freezing symbol**. The other symbols are the elements of the following sets: $\mathcal{A}_c \times \{\blacksquare, \square\}$, $\{\blacksquare, \square\}, \mathcal{A}_c$, $\{0, 1\} \times \{\blacksquare, \square\}$

Local rules:

- **Localization rules:**

- The non-blank symbols are superimposed on positions of the cytoplasm in the $(\bar{2}, \bar{3})$ sub-units, in order $n \geq 4$ cells.
- The elements of $\mathcal{A}_c \times \{0, 1\} \times \{\blacksquare, \square\}$ appear on the leftmost column of the sub-unit having a blue symbol in the functional areas layer.
- The elements of $\{0, 1\} \times \{\blacksquare, \square\}$ appear on the other positions of the leftmost column.
- The elements $\mathcal{A}_c \times \{\blacksquare, \square\}$, appear on the positions of the sub-unit having a blue symbol or an horizontal arrow symbol in the functional areas layer and are outside the leftmost column.
- The elements of $\{\blacksquare, \square\}$ are superimposed on the other positions of the cytoplasm. See an illustration of these rules on Figure 20.

A **value** of the counter is a possible sequence of symbols of the alphabet \mathcal{A}_c that can appear on a column, on the position having a blue symbol in the functional areas layer.

- **Freezing signal:**

- **On the leftmost column:**

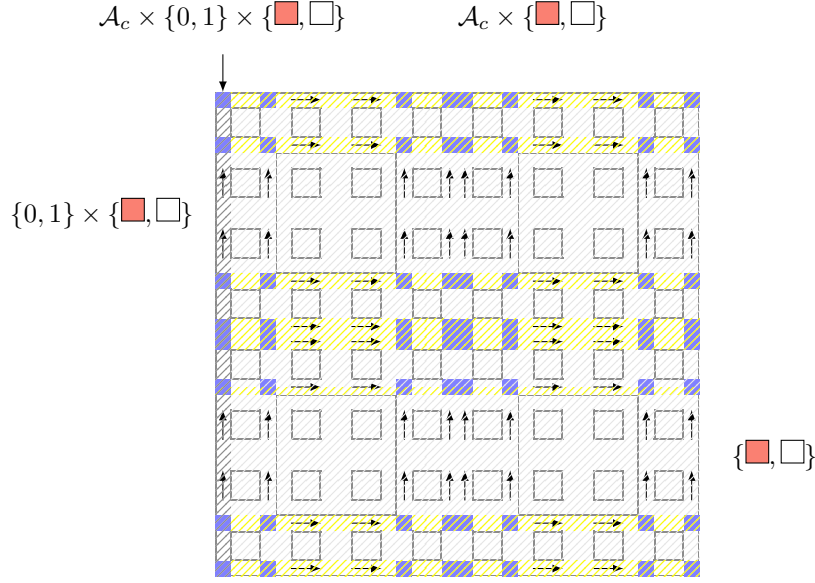

Figure 20: Localization of the linear counter symbols on face 1.

1. on the leftmost upmost position, the color is ■ if and only if the east symbol in the tile is \mathbf{c}_{\max} .
2. this color propagates towards bottom while the east symbol in the tile is \mathbf{c}_{\max} . When this is not true, the color becomes white.
3. the white symbol propagates to the top.

– **Other positions:**

1. the color part of the symbol propagates on the gray area on Figure 20.
2. on the bottommost leftmost position of this area, the color is white if the color of the position on left is white. When this color is salmon (meaning the value of the counter is maximal) then, if the bottommost rightmost position of the $(\bar{1}, \bar{3})$ sub-unit is salmon, then the considered position is colored white. If not, then it is colored salmon. See Figure 21 for an illustration of possible freezing symbol configuration.

• **Incrementation of the counter:**

On the leftmost column of the area:

- On the topmost position of the leftmost column, if the freezing signal of the position on the left is white, then the north symbol in the tile is 1 (meaning that the counter value is incremented in the line). Else it is 0 (meaning this is not incremented).
- On a computation position of this line, the part in $\{0, 1\}$ of symbol of the position on the bottom is the south symbol of the tile. The symbol on the top position is the north symbol of the tile. The symbol on the right position is the east symbol of the tile, and the symbol of the position on the left is equal to the south symbol of the tile.
- between two computation positions, the symbol in $\{0, 1\}$ is transported.

- **Transfer of state and letter:** on the positions with a blue symbol or an horizontal arrow symbol in the functional areas layer, the coefficient is transported.

Global behavior:

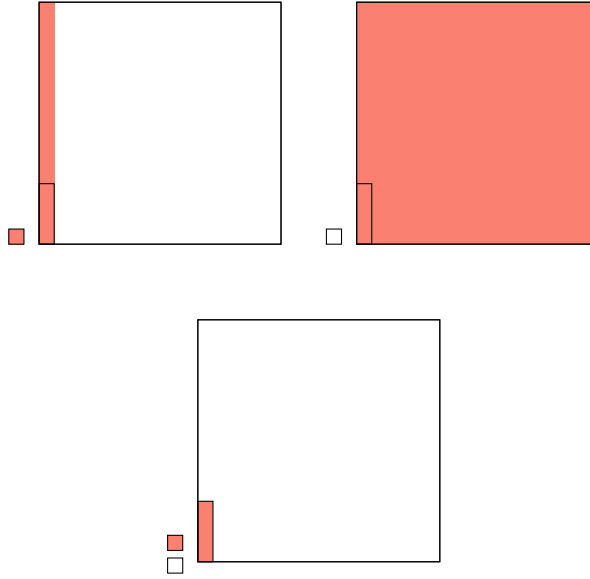

Figure 21: Possible freezing symbol configurations on face 1.

On each of the $(\bar{2}, \bar{3})$ sub-units of the order ≥ 4 cells, the counter value is incremented on the leftmost column using an adding machine coded with local rules, except when the freezing signal on the $(\bar{1}, \bar{3})$ sub-unit is \blacksquare . Then the value is transmitted through this sub-unit in direction \mathbf{e}^1 . As a consequence of the information transport rules, presented after, the counter value is incremented cyclically in direction \mathbf{e}^1 each time going through a cell. The freezing signal happens each time that the counter reaches its maximal value and stops the incrementation for one step, since during this step, the freezing signal is changed into \square . Since the number of lines in this sub-unit is 2^{n-4} and the alphabet \mathcal{A}_c has cardinal $2^{2^{t+2}}$, this counter has period $2^{2^{t+n-2}} + 1$.

D Machines layer

In this section, we present the implementation of Turing machines.

The support of this layer is the bottom face of three-dimensional cells having order qp for some $q \geq 0$, according to direction \mathbf{e}^3 .

In order to preserve minimality, simulate each possible degenerated behavior of the machines, we use an adaptation of the Turing machine model as follows. The bottom line of the face is initialized with symbols in $\mathcal{A} \times \mathcal{Q}$ (we allow multiple heads). The sides of the face are "initialized" with elements of \mathcal{Q} (we allow machine heads to enter at each step on the two sides). As usual in this type of constructions, the tape is not connected. Between two computation positions, the information is transported. In our model, each computation position takes as input up to four symbols coming from bottom and the sides, and outputs up to two symbols to the top and sides. Moreover, we add special states to the definition of Turing machine, in order to manage the presence of multiple machine heads. We describe this model in Section D.0.2, and then show how to implement it with local rules in Section D.0.3.

In Section D.0.1 we describe signals which activate or deactivate lines and columns of the computation areas. These lines and columns are used by the machine if and only if they are active. These signals are determined by the value of the linear counter.

The machine has to take into account only computations starting on well initialized tape and no machine head entering during computation. For this purpose, we use error signals, described in Section D.1.

D.0.1 Computation-active lines and columns

In this section we describe the first sublayer.

Symbols:

Elements of $\{\text{on}, \text{off}\}^2$, of $\{\text{on}, \text{off}\}$ and a blank symbol.

Local rules:

- **Localization rules:**

- the non-blank symbols are superimposed on active lines and active columns positions on a the bottom face according to direction \mathbf{e}^3 , with p -counter equal to $\bar{0}$ and border bit equal to 1.
- the couples are superimposed on intersections of an active line and an active column, the simple symbols are superimposed on the other positions.

- **Transmission rule:** the symbol is transmitted along lines/columns. On the intersections the second symbol is equal to the symbol on the column. The first one is equal to the symbol on the line.

- **Connection rule:** Across the line connecting type 6, 7 (resp. 2, 3) face and the machine face, and on positions where the bottom line intersects with active columns, the symbol in $\{\text{on}, \text{off}\}$ is equal to the first (resp. second) element of the couple in $\{\text{on}, \text{off}\}$ in this layer.

Global behavior:

On the machine face of any order qp three-dimensional cell, the active columns and lines are colored with a symbol in $\{\text{on}, \text{off}\}$ which is determined by the value of the counter on this cell. We call columns (resp.lines) colored with on **computation-active** columns (resp. lines).

D.0.2 Adaptation of computing machines model to minimality property

In this section we present the way computing machines work in our construction. The model we use is adapted in order to have the minimality property, and is defined as follows:

Definition 6. A *computing machine* \mathcal{M} is some tuple $= (\mathcal{Q}, \mathcal{A}, \delta, q_0, q_e, q_s, \#)$, where \mathcal{Q} is the state set, \mathcal{A} the alphabet, q_0 the initial state, and $\#$ is the blank symbol, and

$$\delta : \mathcal{A} \times \mathcal{Q} \rightarrow \mathcal{A} \times \mathcal{Q} \times \{\leftarrow, \rightarrow, \uparrow\}.$$

The other elements q_e, q_s are states in \mathcal{Q} , such that for all $q \in \{q_e, q_s\}$, and for all a in \mathcal{A} , $\delta(a, q) = (a, q, \uparrow)$.

The special states q_e, q_s in this definition have the following meaning:

- the error state q_e : a machine head enters this state when it detects an error, or when it collides with another machine head.

This state is not forbidden in the subshift, but this is replaced by the sending of an error signal, and forbidding the coexistence of the error signal with a well initialized tape. The machine stops moving when it enters this state.

- shadow state q_s : because of multiple heads, we need to specify some state which does not act on the tape and does not interact with the other heads (acting thus as a blank symbol). The initial tape will have a head in initial state on the leftmost position and shadow states on the other ones.

Any Turing machine can be transformed in such a machine by adding some state q_s verifying the corresponding properties listed above.

Moreover, we add elements to the alphabet which interact trivially with the machine states. This means that for any added letter a and any state q , $\delta(a, q) = (a, q, \uparrow)$, and then machines states which interact trivially with the new alphabet, so that the cardinality of the state set and the alphabet are 2^{2^l} .

When the machine is well initialized, none of these states and letters will be reached. Hence the computations are the ones of the initial machine. As a consequence, one can consider that the machine we used has these properties.

In this section, we use a machine which does the following operations for all n

- write 1 on position p_n if $n = 2^k$ for some k and 0 if not.
- write $a_k^{(n)}$ on positions p_k , $k = 1 \dots n$.

The sequence a is the Π_1 -computable sequence defined at the beginning of the construction. The sequence $(a_k^{(n)})$ is a computable sequence such that for all k , $a_n = \inf_n a_k^{(n)}$. For all n , the position p_n is defined to be the number of the first a active column from left to right which is just on the right of an order n two dimensional cell on a face, amongst active columns.

D.0.3 Implementation of the machines

In this section, we describe the second sublayer of this layer.

Symbols:

The symbols are elements of the sets $\mathcal{A} \times \mathcal{Q}$, in \mathcal{A} , \mathcal{Q}^2 , and a blank symbol.

Local rules:

- **Localization:** the non-blank symbols are superimposed on the bottom faces of the three-dimensional cells, according to direction \mathbf{e}^3 . On these faces, they are superimposed on positions of computation-active columns and rows with p -counter value equal to $\bar{0}$ and border bit equal to 1. More precisely:
 - the possible symbols for computation active columns are elements of the sets \mathcal{A} , $\mathcal{A} \times \mathcal{Q}$ and elements of $\mathcal{A} \times \mathcal{Q}$ are on the intersection with computation-active rows.
 - other positions are superimposed with an element of \mathcal{Q}^2 . See an illustration on Figure 22.
- **along the rows and columns, the symbol is transmitted while not on intersections of computation-active columns and rows.**
- **Connection with the counter:** On active computation positions that are in the bottom line of this area, the symbols are equal to the corresponding subsymbol in $\mathcal{A} \times \mathcal{Q}$ on face 2 of the linear counter. On the leftmost (resp. rightmost) column of the area that are in a computation-active line, the symbol is equal to the corresponding symbol on face 7 (resp. 6) of the linear counter.

- **Computation positions rules:**

Consider some computation position which is the intersection of a computation-active row and a computation-active column.

For such a position, the **inputs** include:

1. the symbols written on the south position (or on the corresponding position on face 2 when on the bottom line),
2. the first symbol written on the west position (or the symbol on the corresponding position on face 7 when on the west border of the machine face),

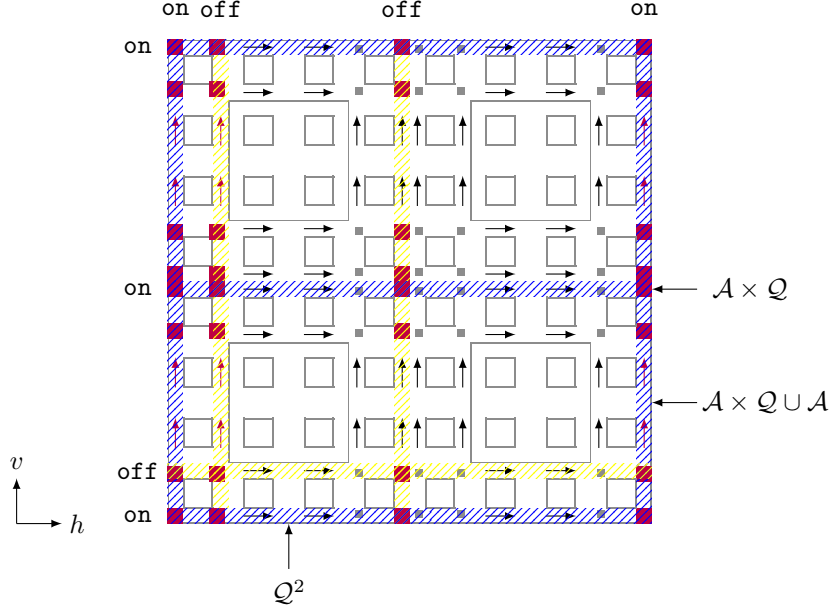

Figure 22: Localization of the machine symbols on the bottom faces of the cubes, according to the direction \mathbf{e}^3 . Blue columns (resp. rows) symbolize computation-active columns (resp. rows).

3. and the second symbol on the east position (or the symbol on the corresponding position on face 6 when on the west border of the machine face).

The **outputs** include:

1. the symbols written on the north position (when not in the topmost row),
2. the second symbol of the west position (when not in the leftmost column),
3. and the first symbol on the east position (when not on the rightmost column).

Moreover, on the bottom line, the inputs from inside the area are always the shadow state q_s .

See Figure 23 for an illustration.

On the first row, all the inputs are determined by the counter and by the above rule. Then, each computation-active row is determined from the adjacent one on the bottom and the value of the linear counter on faces 6 and 7, by the following rules. These rules determine, on each computation position, the outputs from the inputs:

1. **Collision between machine heads:** if there are at least two elements of $\mathcal{Q} \setminus \{q_s\}$ in the inputs, then the computation position is superimposed with (a, q_e) . The output on the top (when this exists) is (a, q_e) , where a is the letter input below. The outputs on the sides are q_s . When there is a unique symbol in $\mathcal{Q} \setminus \{q_s\}$ in the inputs, this symbol is called the machine head state (the symbol q_s is not considered as representing a machine head).
2. **Standard rule:**
 - (a) when the head input comes from a side, then the functional position is superimposed with (a, q) . The above output is the couple (a, q) , where a is the letter input under, and q the head input. The other outputs are q_s . See Figure 24 for an illustration of this rule.

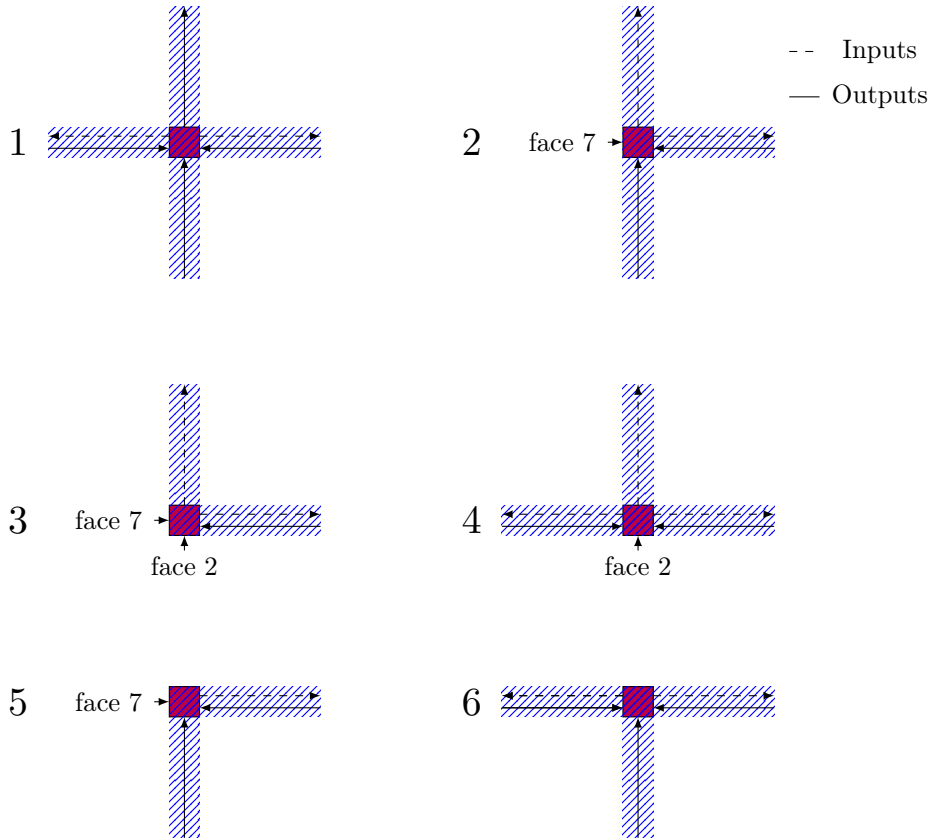

Figure 23: Schema of the inputs and outputs directions when inside the area (1) and on the border of the area (2,3,4,5,6).

(b) when the head input comes from under, the above output is:

- $\delta_1(a, q)$ when $\delta_3(a, q)$ is in $\{\rightarrow, \leftarrow\}$
- and $(\delta_1(a, q), \delta_2(a, q))$ when $\delta_3(a, q) = \uparrow$.

The head output is in the direction of $\delta_3(a, q)$ (when this output direction exists) and equal to $\delta_2(a, q)$ when it is in $\{\rightarrow, \leftarrow\}$. The other outputs are q_s . See Figure 25 for an illustration.

3. **Collision with border:** When the output direction does not exist, the output is (a, q_e) on the top, and the outputs on the side is q_s . The computation position is superimposed with (a, q) .
4. **No machine head:** when all the inputs in \mathcal{Q} are q_s , and the above output is in \mathcal{A} and equal to its input a .

Global behavior:

On the bottom faces according to e^3 of order qp three-dimensional cells, we implemented some computations using our modified Turing machine model. This model allows multiple machine heads on the initial tape and entering in each row. When there is a unique machine head on the leftmost position of the bottom line and only blank letters on the initial tape, and all the lines and columns are computation-active, then the computations are as intended. This means that the machine write successively the bits $a_k^{(n)}$ on the p_k th column of its tape (in order to impose the value of the frequency bits), and moreover writes 1 if k is a power of two, and 0 if not, in order to impose the value of the grouping bits. It enters in the error state q_e when it detects an error.

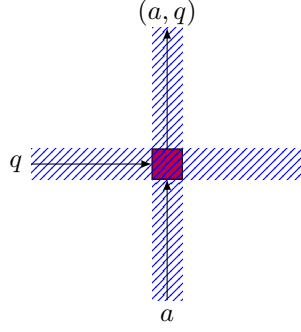

Figure 24: Illustration of the standard rules (1).

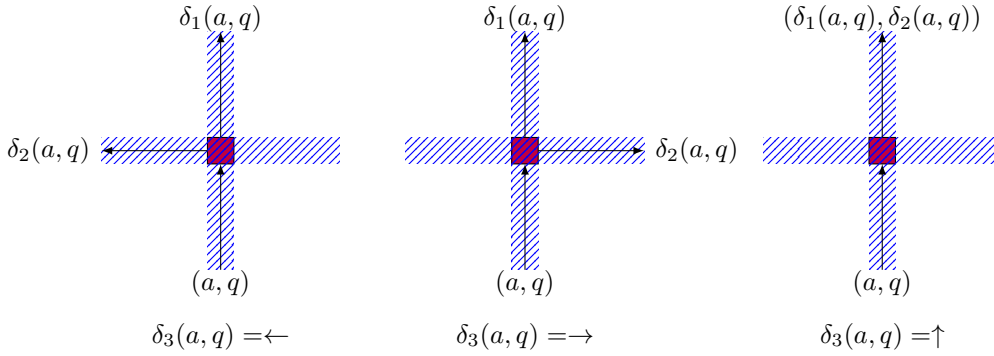

Figure 25: Illustration of the standard rules (2).

When this is not the case, the computations are determined by the rules giving the outputs on computation positions from the inputs. When there is a collision of a machine head with the border, it enters in state q_e . When heads collide, they fusion into a unique head in state q_e . In Section D.1, we describe signal errors that helps us to take into account the computations only when the initial tape is empty, all the lines and columns are computation-active, and there is no machine head entering on the sides of the area.

D.1 Error signals



In order to simulate any behavior that happens in infinite areas in finite ones, we need error signals. This means that when the machine detects an error (enters a halting state), it sends a signal to the initialization line to verify it was well initialized: that the tape was empty, that no machine head enters on the sides, and that the machine was initially in the leftmost position of the line, and in initialization state. Moreover, for the reason that we need to compute precisely the number of possible initial tape contents, we allow initialization of multiple heads. The first error signal will detect the first position from left to right in the top row of the area where there is a machine head in error state or the active column is **off**. This position only will trigger an error signal (described in Section D.1.3, according to the direction specified just above when it is in the top line of the area (the word of arrows specifying the direction is a part of the counter). The empty tape signal detects if the initial tape was empty, and that there was a unique machine head on the leftmost position in initialization state q_0 . The empty tape and first error signals are described in Section D.1.1. The empty sides signal, described in Section D.1.2 detects if there is no machine head entering on the sides, and that the **on/off** signals on the sides are all equal to **on**. The error signal is taken into account (meaning forbidden) when the empty tape, and empty sides signals

are detecting an error.





D.1.1 Empty tape, first error signals

Symbols:





The first sublayer has the following symbols:

, , symbols in $\{\text{red square}, \text{green square}\}^2$, and a blank symbol \square .





Local rules:

- **Localization:** non blank symbols are superimposed on the top line and bottom line of the border of the machine face as a two-dimensional cell.
- **First error signal:** this signal detects the first error on the top of the functional area, from the left to the right, where an error means a symbol **off** or q_e . The rules are:
 - the topmost leftmost position of the top line of the cell is marked with .
 - the symbol  propagates to the left, and propagates to the right while the position under is not in error state q_e and the symbol in $\{\text{on}, \text{off}\}$ is **on**.
 - when on position in the top row with an error, the position on the top right is colored .
 - the symbol  propagates to the right, and propagates to the left while the positions under is not in error state.



Empty tape signal: this signal detects if the initial tape of the machine is empty. This means that it is filled with the symbol $(\#, q_s)$ except on the leftmost position where it has to be $(\#, q_0)$. The signal detects the first symbol which is different from $(\#, q_s)$ or $(\#, q_0)$ when on the left, from left to right (first color), and from left to right (second color). Concerning the first color:

- on the bottom row, the leftmost position is colored with .
- The symbol  propagates to the right unless when on a position under a symbol different from:
 - * $(\#, q_0)$ when on the leftmost functional position,
 - * $(\#, q_s)$ on another functional position.
- When on these positions, the symbol on the right is .
- the symbol  propagates to the right.

for the second one:



- on the bottom row, the rightmost position is colored with .
- The symbol  propagates to the left except when on a position under a symbol different from:
 - * $(\#, q_0)$ when on the leftmost functional position,
 - * $(\#, q_s)$ on another computation position.
- When on these positions, the symbol on the right is .
- the symbol  propagates to the left.

Global behavior:

The top row is separated in two parts: before and after (from left to right) the first error. The left part is colored , and the right part . The bottom row is colored with a couple of color. The first one separates the row in two parts. The limit between the two parts is the first occurrence *from left to right* of a symbol different from $(\#, q_s)$ or $(\#, q_0)$ when on the leftmost computation position above. The second color of the couple separates two similar parts *from right to left*.

See Figure 26 for an illustration.



D.1.2 Empty sides signals

This second sublayer has the same symbols as the first sublayer. The principle of the local rules is similar: the leftmost (resp. rightmost) column is splitted in two parts, the top one colored  and the bottom one colored . The limit is the first position from top to bottom where the corresponding symbol across the limit with face 7 (resp. face 6) is (q_s, on) (resp. q_s). Moreover, the bottom row of the machine face is colored with a couple of colors. This couple is constant over the row. The first one of the colors is equal to the color at the bottom of the leftmost column. The second one is the color at the bottom of the rightmost one.









See an illustration on Figure 26.

D.1.3 Error signals

Symbols:

 (error signal), .

Local rules:

- **Localization:** the non-blank symbols are superimposed on the right, left and top sides of the border of machine faces in three-dimensional cells.
- **Propagation:** each of the two symbols propagates when inside one of these two areas:
 - the union of the left side of the face and positions colored  in the top side of the face.
 - the union of the right side of the face and positions colored  in the top side of the face.
- **Induction:**
 - on a position of the top side of the face which is colored  and the position on the right is , if the symbol above in the information transfers layer is \rightarrow (resp. \leftarrow), then there is an error signal  on this position and none on the right (resp. there is no error signal on this position and there is one on the right).
 - on the rightmost topmost position of the face, if the first machine signal is , then there is no error signal.
- **Forbidding wrong configurations:**
 - there can not be four symbols  and an error signal  on the same position.

Global behavior:

When there is a machine head in error state in the top row, the first one (from left to right) sends an error signal to the bottom row (see Figure 26) in the direction indicated by the arrow on the corresponding position on face 3. This signal is forbidden if the machine is well initialized. This means that the working tape of the machine is empty in the bottom row. Moreover, there is a unique machine in state q_0 in the leftmost position of the bottom row, all the lines and columns are on and there is no machine entering on the sides. This means that the error signal is taken into account only when the computations have the intended behavior.

Because for any n and any configuration, there exists some three-dimensional cell in which the machine is well initialized (because of the presence of counters). For any k , there exists some n such that the machine has enough time to check the k th frequency bit and grouping bit. This means that in any configuration of the subshift, the k th frequency bit is equal to a_k , and the 2^k th grouping bit is 1, and the other ones are 0.

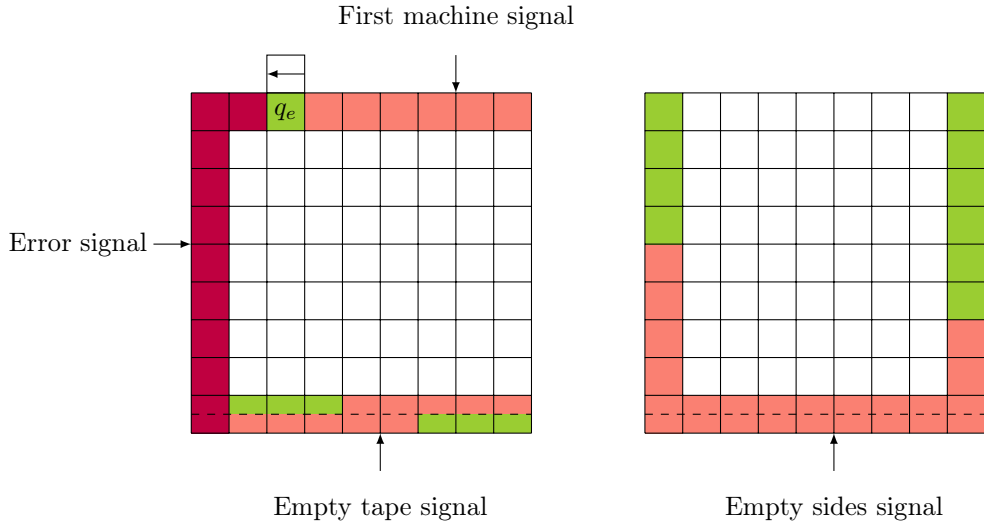

Figure 26: Illustration of the propagation of an error signal, where are represented the empty tape, first machine and empty sides signals.

E Completing the machines areas

When completing the machine face, there are two types of difficulties. The first one is managing the various signals : machine signals, first error, empty tape, empty side signals, and error signals. The second one is managing the space-time diagram of the machine. When the machine face is all known, there is no completion to make. Hence we describe the completion according to the parts of the face that are known (meaning that they appear in the initial pattern). Since there is strictly less difficulty to complete knowing only a part inside the face than on the border (since the difficulties come from completing the space-time diagram of the machine, in a similar way than for the border), we describe the completion only when a part of the border is known.

- When knowing the top right corner of the machine face:

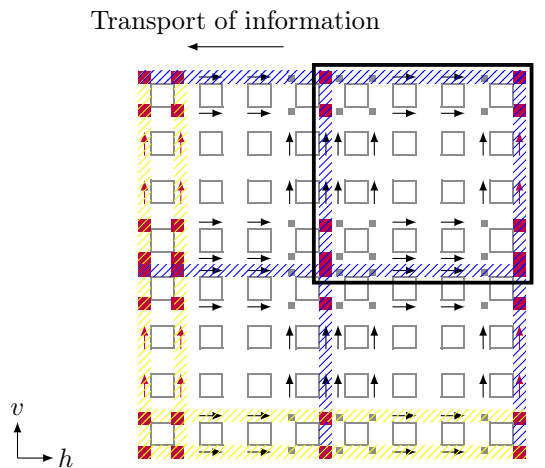

Figure 27: Illustration of the completion of the on/off signals and the space-time diagram of the machine. The known part is surrounded by a black square.

1. if the signal detects the first machine in error state from left to right (becomes \blacksquare after being \blacksquare), then we already know the propagation direction of the error signal. Then we complete the first machine signal and the error signal according to what is known. For completing the space-time diagram of the machine, the difficulty comes from the fact that this is possible that when completing the trajectory of two machine heads according to the local rules, they have to collide reversely in time. This is not possible in our model. This is where we use the **on/off** signals. We complete first the non already determined signals using only the symbol **off**, as illustrated on Figure 27. Then the space-time diagram is completed by only transporting the information. In the end, we completed with any symbols in \mathcal{Q} or $\mathcal{A} \times \mathcal{Q}$ where the symbols are not determined. We can do this since they do not interact with the known part of the space-time diagram. Then we complete empty tape and empty side signals according to the determined symbols.
2. if the signal is all \blacksquare , then one can complete the face without wondering about the error signal.
3. if the signal is all \blacksquare , we complete in the same way as for the first point, and the **off** signals contribute to the first machine signal being all \blacksquare . If there is no error signal on the right side, one can complete so that the first machine in error state has above the arrow \leftarrow indicating that the error signal has to propagate to the left. If there is an error signal on the right, then we set this arrow as \rightarrow . This is illustrated on Figure 28.

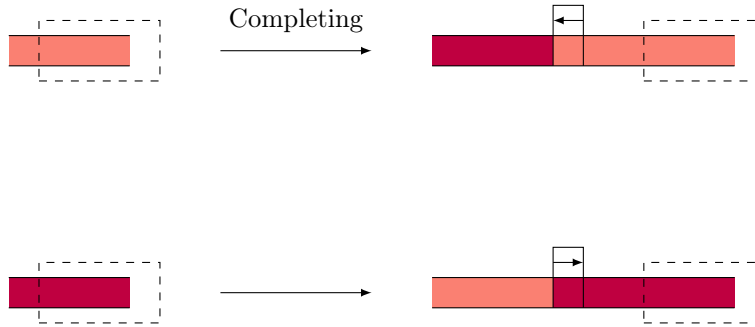

Figure 28: Illustration of the completion of the arrows according to the error signal in the known part of the area, designated by a dashed rectangle.

- when knowing the top left corner, the difficulty comes from the direction of propagation of the error signal. This is ruled in a similar way as point 3 of the last case.
- when knowing the bottom right corner or bottom left corner: the completion is similar as in the last points, except that we have to manage the empty tape and sides signals. The difficult point comes from the signal, whose propagation direction is towards the known corner. If this signal detects an error before entering in the known area, we complete so that the added symbols in $\{\mathbf{on}, \mathbf{off}\}$ are all **off**: this induces the error. When this signal enters without detecting an error, we complete all the symbols so that they do not introduce any error. A particular difficulty comes from the case when the bottom right corner is known. Indeed, when the signal enters without having detecting an error, this means we have to complete the pattern so that a machine head in initial state is initialized in the leftmost position of the bottom row. Since the pattern is completed in the structure layer into a great enough cell, this head can not enter in the known pattern.
- when the pattern crosses only a edge or the center of the face, the completion is similar (but easier since these parts have less information, then we need to add less to the pattern).

References

- [AS14] N. Aubrun and M. Sablik. Multidimensional effective s-adic subshift are sofic. *Uniform Distribution Theory*, 9, 2014.
- [Bal09] A. Ballier. *Propriétés structurelles, combinatoires et logiques des pavages*. PhD thesis, Aix-Marseille Université, 2009.
- [DR17] B. Durand and A. Romashchenko. On the expressive power of quasiperiodic sft. *Discrete Mathematics*, 2017.
- [GS17a] S. Gangloff and M. Sablik. Block gluing intensity of bidimensional sft: computability of the entropy and periodic points. *Dynamical systems*, 2017.
- [GS17b] S. Gangloff and M. Sablik. A characterization of the entropy dimensions of minimal z3-sfts. *Dynamical systems*, 2017.
- [HM10] M. Hochman and T. Meyerovitch. A characterization of the entropies of multidimensional shifts of finite type. *Annals of Mathematics*, 171:2011–2038, 2010.
- [Hoc09] M. Hochman. On the dynamics and recursive properties of multidimensional symbolic systems. *Inventiones Mathematicae*, 176:131–167, 2009.
- [HV17] M. Hochman and P. Vanier. Turing spectra of minimal subshifts. In *Computer Science - Theory and Applications*, pages 154–161, 2017.
- [JLKP17] U. Jung, J. Lee, and K. Koh Park. Topological entropy dimension and directional entropy dimension for z2-subshifts. *Entropy*, 2017.
- [JV15] E. Jeandel and P. Vanier. Characterizations of periods of multidimensional shifts. *Ergodic Theory and Dynamical Systems*, 35:431–460, 2015.
- [Mey11] T. Meyerovitch. Growth-type invariants for zd subshifts of finite type and arithmetical classes of real numbers. *Inventiones mathematicae*, 184:567–589, 2011.
- [Moz89] S. Mozes. Tilings, substitution systems and dynamical systems generated by them. *Journal d'Analyse Mathématique*, 53:139–186, 1989.
- [PS15] R. Pavlov and M. Schraudner. Entropies realizable by block gluing shifts of finite type. *Journal d'Analyse Mathématique*, 126:113–174, 2015.
- [Rob71] R. Robinson. Undecidability and nonperiodicity for tilings of the plane. *Inventiones Mathematicae*, 12:177–209, 1971.
- [Ber66] R. Berger. The undecidability of the domino problem. *Memoirs of the American Mathematical Society*, 66, 1966.
- [AS10] N. Aubrun and M. Sablik. Simulation of effective subshifts by two-dimensional subshifts of finite type. *Acta Appl. Math.*, 126:35–63, 2013.
- [DRS10] B. Durand, A. Romashchenko, and A. Shen. Fixed-point tile sets and their applications. *Journal of Computer and System Sciences*, 78:731–764, 2012.