

MSC: 34C10, 34D05, 34D20

**The behavior of solutions of the systems of two first order
linear ordinary differential equations**

G. A. Grigorian

0019 Armenia c. Yerevan, str. M. Bagramian 24/5
Institute of Mathematics NAS of Armenia
E - mail: mathohys2@instmath.sci.am

Abstract. The Riccati equation method is used for study the behavior of solutions of the systems of two linear first order ordinary differential equations. All types of oscillation and regularity of these system are revealed. A generalization of Leighton's theorem is obtained. Three new principles for the second order linear differential equations are derived. Stability and non conjugation criteria are proved for the mentioned systems, as well as estimates are obtained for the solutions of the last ones.

Key words: Riccati equation, oscillation, non oscillation, weak oscillation, weak non oscillation, half oscillation, singularity, Leighton's theorem, regular solution, normality, extreme, super extreme and exotic systems, non conjugate property.

§1. Introduction

Let $a_{jk}(t)$ ($j, k = 1, 2$) be real valued continuous functions on $[t_0; +\infty)$. Consider the system of equations

$$\begin{cases} \phi' = a_{11}(t)\phi + a_{12}(t)\psi; \\ \psi' = a_{21}(t)\phi + a_{22}(t)\psi, \quad t \geq t_0. \end{cases} \quad (1.1)$$

Study of the asymptotic behavior problem (oscillation, non oscillation, non conjugation, rate of growth) of solutions linear systems of ordinary differential equations as well as stability problem of the last ones, in particular of the system (1.1), are important problems of the qualitative theory of differential equations and many works are devoted to them (see [1] and cited works therein, [2], [3], [4], [5], [6], [7]). Let $p(t)$, $q(t)$ and $r(t)$ be real valued continuous functions on $[t_0; +\infty)$, and let $p(t) > 0$, $t \geq t_0$. Along with the

system (1.1) consider the equation

$$(p(t)\phi')' + q(t)\phi' + r(t)\phi = 0, \quad t \geq t_0. \quad (1.2)$$

The substitution

$$p(t)\phi' = \psi \quad (1.3)$$

in this equation reduces it to the system

$$\begin{cases} \phi' = \frac{1}{p(t)}\psi; \\ \psi' = -r(t)\phi - \frac{q(t)}{p(t)}\psi, \quad t \geq t_0, \end{cases} \quad (1.4)$$

which is a particular case of the system (1.1). For $p(t) \equiv 1$, $q(t) \equiv 0$ Eq. (1.2) takes the forme

$$\phi'' + r(t)\phi = 0, \quad t \geq t_0. \quad (1.5)$$

It is well known (see for example [8]), that by using different transformations Eq. (1.2) can be reduced to the Eq. (1.5). One can show that the system (1.1) can be reduced to Eq. (1.5), if (for example) $a_{12}(t) \neq 0$, $t \geq t_0$. There exist also other conditions for which the system (1.1) can be reduced to Eq. (1.5). Of course the reduction of the system (1.1) to Eq. (1.5), if it is possible to carry it out (until now, it is not known whether this can always be done), can be very useful for study of different qualitative characteristics of the system (1.1). However this method not always can help to solve the assigned problem. One of effective methods of qualitative investigation of Eq. (1.5), as well as of the system (1.1) is the Riccati equation method. In this work we use this method for the study of the behavior of solutions of the system of two linear first order ordinary differential equations. We reveal all types of oscillation and regularity of this system. We obtain a generalization of Leighton's oscillation theorem. We derive three new principles for the second order linear ordinary differential equations. We prove some stability and non conjugation criteria for the mentioned above system. We also obtain estimates for the solutions of the last one.

§2. Auxiliary propositions

Let $a(t)$, $b(t)$ and $c(t)$ be real valued continuous function on $[t_0; +\infty)$. Consider the Riccati equation

$$x' + a(t)x^2 + b(t)x + c(t) = 0, \quad t \geq t_0. \quad (2.1)$$

In this paragraph we study some important properties of global solutions (existing on $[t_1; +\infty)$ for some $t_1 \geq t_0$) of this equation which will be used further for the study of

asymptotic properties of solutions of the system (1.1). Along with Eq. (2.1) consider the system of equations

$$\begin{cases} \phi' = & a(t)\psi; \\ \psi' = -c(t)\phi - b(t)\psi, & t \geq t_0. \end{cases} \quad (2.2)$$

The solutions $x(t)$ of Eq. (2.1), existing on some interval $[t_1; t_2)$ ($t_0 \leq t_1 < t_2 \leq +\infty$), are connected with the solutions $(\phi(t), \psi(t))$ of the system (2.2) by the equalities (see [9], pp. 153 - 154)

$$\phi(t) = \phi(t_1) \exp\left\{\int_{t_1}^t a(\tau)x(\tau)d\tau\right\}, \quad \phi(t_1) \neq 0, \quad \psi(t) = x(t)\phi(t). \quad (2.3)$$

In this paragraph we will take that all solutions of equations and systems of equations are real valued. For brevity we introduce the denotations:

$$\begin{aligned} J_u(t_1; t) &\equiv \exp\left\{\int_{t_1}^t a(\tau)u(\tau)d\tau\right\}, \quad J_u(t) \equiv J_u(t_0; t), \\ I_{u,v}^+(t_1; t) &\equiv \int_{t_1}^t u(\tau)J_{-v}(t_1; \tau)d\tau, \quad I_{u,v}^+(t_1) \equiv \int_{t_1}^{+\infty} u(\tau)J_{-v}(t_1; \tau)d\tau, \\ I_{u,v}^-(t_1; t) &\equiv \int_{t_1}^t J_{-u}(\tau; t)v(\tau)d\tau, \quad t_1, t \geq t_0, \end{aligned}$$

where $u(t)$ and $v(t)$ are arbitrary continuous functions on $[t_0; +\infty)$. Rewrite Eq. (2.1) in the form:

$$x' + h_x(t)x + b(t) = 0, \quad t \geq t_0,$$

where $h_x(t) \equiv a(t)x + b(t)$, $t \geq t_0$. Then by virtue of the Cauchy formula Eq. (2.1) is equivalent to the following integral equation

$$x = J_{-h_x}(t_1; t) \left[x(t_1) - \int_{t_1}^t J_b(t; \tau)c(\tau)\phi_x(t_1; \tau)d\tau \right], \quad t \geq t_0, \quad (2.4)$$

where $\phi_x(t_1; t) \equiv \exp \left\{ \int_{t_1}^t a(\tau)x(\tau)d\tau \right\}$, $t_1, t \geq t_0$. Let $a_1(t)$, $b_1(t)$ and $c_1(t)$ be real valued continuous function on $[t_0; +\infty)$. Along with Eq. (2.1) consider the equation

$$x' + a_1(t)x^2 + b_1(t)x + c_1(t) = 0, \quad t \geq t_0, \quad (2.5)$$

and differential inequality

$$\eta' + a(t)\eta^2 + b(t)\eta + c(t) \geq 0, \quad t \geq t_0. \quad (2.6)$$

Note that for $a(t) \geq 0$, $t \geq t_0$, any solution of the linear equation

$$\eta' + b(t)\eta + c(t) = 0, \quad t \geq t_0,$$

is a solution of (2.6). Therefore for any initial condition $\eta_{(0)}$ inequality (2.6) has a solution $\eta_0(t)$ on $[t_0; +\infty)$ with $\eta_0(t_0) = \eta_{(0)}$.

Theorem 2.1. *Let Eq. (2.5) has a solution $x_1(t)$ on $[t_0; \tau_0)$ ($\tau_0 \leq +\infty$) and let the following condition be satisfied:*

$$a(t) \geq 0, \quad \int_{t_0}^t \exp \left\{ \int_{t_0}^{\xi} [a(\xi)(\eta_0(\xi) + x_1(\xi)) + b(\xi)] d\xi \right\} \times$$

$$\times [(a_1(\tau) - a(\tau))x_1^2(\tau) + (b_1(\tau) - b(\tau))x_1(\tau) + c_1(\tau) - c(\tau)] d\tau \geq 0, \quad t \in [t_0; \tau_0),$$

where $\eta_0(t)$ is a solution of (2.6) on $[t_0; \tau_0)$ with $\eta_0(t_0) \geq x_1(t_0)$. Then for each $x_{(0)} \geq x_1(t_0)$ Eq. (2.1) has a solution $x_0(t)$ on $[t_0; \tau_0)$, and $x_0(t) \geq x_1(t)$, $t \in [t_0; \tau_0)$.

See proof in [10].

Let $t_1 \geq t_0$.

Definition 2.1. *A solution of Eq. (2.1) is called t_1 -regular, if it exists on $[t_1; +\infty)$. Eq. (2.1) is called regular if it has a t_1 -regular solution for some $t_1 \geq t_0$.*

Definition 2.2. *A t_1 -regular solution $x(t)$ of Eq. (2.1) is called t_1 -normal, if there exists a neighborhood $U_x(t_1)$ of the point $x(t_1)$ such that each solution $\tilde{x}(t)$ of Eq. (2.1) with $\tilde{x}(t_1) \in U_x(t_1)$ is t_1 -regular. Otherwise $x(t)$ is called t_1 -extremal.*

Remark 2.1. *From the results of work [11] it follows that for some $t_1 \geq t_0$ the regular equation (2.1) can have: the unique t_1 -regular solution (then it is t_1 -extremal); no t_1 -extremal solution (then its all t_1 -regular solutions are t_1 -normal); the unique t_1 -extremal solution (and all other t_1 -regular solutions are t_1 -normal); two t_1 -extremal solutions (all other t_1 -regular solutions are t_1 -normal).*

In what follow we will assume that the functions $a(t)$ and $c(t)$ have unbounded supports (the case when one of these functions has a bounded support is trivial). For arbitrary continuous function $u(t)$ on $[t_0; +\infty)$ denote:

$$\mu_u(t_1; t) \equiv \int_{t_1}^t a(\tau) \exp \left\{ - \int_{t_1}^{\tau} [2a(\xi)u(\xi) + b(\xi)] d\xi \right\} d\tau,$$

$$\nu_u(t) \equiv \int_t^{+\infty} a(\tau) \exp \left\{ - \int_t^{\tau} [2a(\xi)u(\xi) + b(\xi)] d\xi \right\} d\tau, \quad t_1, t \geq t_0.$$

Theorem 2.2. *Let for some t_1 -regular solution $x_0(t)$ of Eq. (2.1) the integral $\nu_{x_0}(t_1)$ be convergent. Then the following assertions are valid.*

A) *For any $t \geq t_1$ and for all t_1 -normal solutions $x(t)$ of Eq. (2.1) and only for them the integrals $\nu_x(t)$ converge.*

B) *In order that Eq. (2.1) have t_1 -extremal solution it is necessary and sufficient that*

$$\nu_{x_0}(t) \neq 0, \quad t \geq t_1.$$

Under this condition the unique t_1 -extremal solution $x_(t)$ is defined by formula*

$$x_*(t) = x_0(t) - \frac{1}{\nu_{x_0}(t)}, \quad t \geq t_1, \quad (2.7)$$

and

$$\nu_{x_*}(t) = +\infty, \quad t \geq t_1, \quad \text{or} \quad \nu_{x_*}(t) = -\infty, \quad t \geq t_1, \quad (2.8)$$

$$\int_t^{+\infty} a(\tau) [x_1(\tau) - x_2(\tau)] d\tau = \ln \left[\frac{x_*(t) - x_1(t)}{x_*(t) - x_2(t)} \right], \quad t \geq t_1, \quad (2.9)$$

$$\int_{t_1}^{+\infty} a(\tau) [x_1(\tau) - x_2(\tau)] d\tau = -\infty. \quad (2.10)$$

Proof. All assertions of this theorem except (2.8) and (2.10), are proved in [11]. Let as prove (2.8). We will use the equalities (see [11]):

$$\mu_{x_*}(t_2; t) = \frac{\mu_{x_0}(t_2; t)}{1 + \lambda_*(t_2)\mu_{x_0}(t_2; t)}, \quad (2.11)$$

$$x_1(t) = x_2(t) + \frac{\lambda_{12}(t_2) \exp\left\{-\int_{t_1}^t [2a(\tau)x_2(\tau) + b(\tau)]d\tau\right\}}{1 + \lambda_{12}(t_2)\mu_{x_2}(t_2; t)}, \quad t \geq t_2 \geq t_1, \quad (2.12)$$

where $\lambda_*(t_2) \equiv x_*(t_2) - x_0(t_2)$, $\lambda_{12}(t_2) \equiv x_1(t_2) - x_2(t_2)$, $t \geq t_2 \geq t_1$, $x_1(t)$ and $x_2(t)$ are arbitrary t_1 -regular solutions of Eq. (2.1). From (2.12) it follows that $\mu_{x_0}(t_2; t)$ is bounded by t on $[t_2; +\infty)$. Then since obviously

$$\nu_{x_0}(t_2) = \lim_{t \rightarrow +\infty} \mu_{x_0}(t_2; t) \neq 0, \quad t_2 \geq t_1, \quad (2.13)$$

necessarily

$$\lim_{t \rightarrow +\infty} [1 + \lambda_*(t_2)\mu_{x_0}(t_2; t)] = 0, \quad t_2 \geq t_1. \quad (2.14)$$

From here from (2.11) and (2.13) it follows (2.8). Let us prove (2.10). By (2.12) we have:

$$x_*(t) - x_0(t) = \frac{\lambda_*(t_1) \exp\left\{-\int_{t_1}^t [2a(\tau)x_0(\tau) + b(\tau)]d\tau\right\}}{1 + \lambda_*(t_1)\mu_{x_0}(t_1; t)}, \quad t \geq t_1.$$

Multiplying both sides of this equality on $a(t)$ and integrating from t_1 to t we will get

$$\int_{t_1}^t a(\tau)[x_*(\tau) - x_0(\tau)]d\tau = \ln[1 + \lambda_*(t_1)\mu_{x_0}(t_1; t)], \quad t \geq t_1.$$

Passing to the limit in this equality when $t \rightarrow +\infty$ and taking into account (2.14) we obtain (2.10). The theorem is proved.

Corollary 2.1. *If for some t_1 -regular solution $x_*(t)$ the equality $\nu_{x_*}(t_1) = \pm\infty$ is fulfilled, then $x_*(t)$ is the unique t_1 -extremal solution of Eq. (2.1), and Eq. (2.1) has t_1 -normal solutions, and for each $t \geq t_1$ and for all t_1 -normal solutions $x(t)$ of Eq. (2.1) the integrals $\nu_x(t)$ converge; for every normal solutions $x_0(t)$, $x_1(t)$, $x_2(t)$ of Eq. (2.1) and for $x_*(t)$ the correlations (2.7) - (2.10) are satisfied.*

Proof. Let $\nu_{x_*}(t_1) = +\infty$ (the proof in the case $\nu_{x_*}(t_1) = -\infty$ by analogy). Then

$$\mu_{x_*}(t_1; t) > 1, \quad t \geq T, \quad (2.15)$$

for some $T > t_1$. Let $\bar{\mu}_{x_*} \equiv \max_{t \in [t_0; T]} |\mu_{x_*}(t_1; t)|$, and let $x_0(t)$ be a solution to Eq. (2.1) with $x_*(t_1) < x_0(t_1) < x_*(t_1) + \frac{1}{\max\{1, \bar{\mu}_{x_*}\}}$. Then taking into account (2.15) we will have:

$$1 + \lambda_*(t_1)\mu_{x_*}(t_1; t) > 0, \quad t \geq t_1,$$

where $\lambda_*(t_1) \equiv x_0(t_1) - x_*(t_1) > 0$. Hence (see [11]) by (2.11) $x_0(t)$ is a t_1 -regular solution of Eq. (2.1). Show that the integrals $\nu_{x_*}(t)$ converge for all $t \geq t_1$ and $\nu_{x_*}(t) \neq 0$. We use the equality (see [11])

$$\mu_{x_0}(t_2; t) = \frac{\mu_{x_*}(t_2; t)}{1 + \lambda_*(t_2)\mu_{x_*}(t_2; t)}, \quad t \geq t_2 \geq t_1,$$

where $\lambda_*(t_2) \equiv x_0(t_2) - x_*(t_2) \neq 0$. For enough large values of $t > t_2$ we have $\mu_{x_*}(t_2; t) > 0$. Therefore,

$$\nu_{x_0}(t_2) = \lim_{t \rightarrow +\infty} \mu_{x_0}(t_2; t) = \lim_{t \rightarrow +\infty} \frac{1}{\lambda_*(t_2) + \frac{1}{\mu_{x_*}(t_2; t)}} = \frac{1}{\lambda_*(t_2)} \neq 0.$$

So for $x_0(t)$ all conditions of Theorem 2.2 are fulfilled. Therefore Eq. (2.1) has t_1 -normal solutions and for every t_1 -normal solutions $x(t)$ of Eq. (2.1) and for all $t \geq t_1$ the integrals $\nu_x(t)$ converge; also for every t_1 -normal solutions $x_0(t)$, $x_1(t)$, $x_2(t)$ of Eq. (2.1) and for $x_*(t)$ the correlations (2.7) - (2.10) are satisfied. The corollary is proved.

Denote by $reg(t_1)$ the set of values $x_0 \in R$, for which the solution $x(t)$ of Eq. (2.1) with $x(t_1) = x_0$ is t_1 -regular.

Lemma 2.1. *Let $a(t) \geq 0$, $t \geq t_0$, and let Eq. (2.1) has t_1 -regular solution. Then it has the unique t_1 -extremal solution $x_*(t)$, and $reg(t_1) = [x_*(t_1); +\infty)$.*

See the proof in [2].

Lemma 2.2. *let $a(t) \geq 0$, $t \geq t_0$; $t_0 \leq t_1 < t_2$, and let $(t_1; t_2)$ be the maximal existence interval for the solution $x(t)$ of Eq. (2.1). Then $\lim_{t \rightarrow t_1+0} x(t) = +\infty$.*

See the proof in [10].

Lemma 2.3. *Let $a(t) \geq 0$, $t \geq t_0$, $x_0(t)$ be a t_0 -normal solution of Eq. (2.1), $x_0(t) \neq 0$, $t \geq t_0$. Then for its unique t_0 -extremal solution $x_*(t)$ the equality*

$$\begin{aligned} \int_{t_0}^t a(\tau)x_*(\tau)d\tau &= -\ln \nu_{x_0}(t_0) + \ln \left[\exp \left\{ \int_{t_0}^t a(\xi)x_0(\xi)d\xi \right\} \times \right. \\ &\times \left. \int_t^{+\infty} \frac{a(s)x_0(s)}{x_0(t_0)} \exp \left\{ \int_{t_0}^s \left[\frac{c(\xi)}{x_0(\xi)} - a(\xi)x_0(\xi) \right] d\xi \right\} ds \right], \quad t \geq t_0. \end{aligned} \quad (2.16)$$

holds

Proof. By Lemma 2.1 Eq. (2.1) has a t_0 -normal solution $x_0(t)$. Then since $a(t) \geq 0$, $t \geq t_0$ and has unbounded support, the integral $\nu_{x_0}(t)$ converges for all $t \geq t_0$ and $\nu_{x_0}(t) \neq 0$, $t \geq t_0$. By virtue of Theorem 2.2 from here it follows that Eq. (2.1) has the unique t_0 -extremal solution $x_*(t)$, satisfying the equality $x_*(t) = x_0(t) - \frac{1}{\nu_{x_0}(t)}$, $t \geq t_0$. From here it follows:

$$\begin{aligned} \int_{t_0}^t a(\tau)x_*(\tau)d\tau &= \int_{t_0}^t a(\tau)x_0(\tau)d\tau - \int_{t_0}^t \frac{a(\tau)}{\nu_{x_0}(\tau)}d\tau = \ln[\exp\{\int_{t_0}^t a(\tau)x_0(\tau)d\tau\}] - \\ &- \ln \nu_{x_0}(t_0) + \int_{t_0}^t d\left(\ln\left[\int_{\tau}^{+\infty} a(s)\exp\left\{-\int_{t_0}^s [2a(\xi)x_0(\xi) + b(\xi)]d\xi\right\}ds\right]\right), \end{aligned} \quad (2.17)$$

$t \geq t_0$. On the strength of (2.1) from the condition $x_0(t) \neq 0$, $t \geq t_0$, it follows:

$$2a(\xi)x_0(\xi) + b(\xi) = -\frac{x_0'(\xi) - a(\xi)x_0^2(\xi) + c(\xi)}{x_0(\xi)}, \quad \xi \geq t_0.$$

From here and from (2.17) it follows (2.16). The lemma is proved.

Lemma 2.4. Let $a(t) \geq 0$, $c(t) \geq 0$, $t \geq t_0$, $I_{a,b}^+(t_0) = +\infty$ and let Eq. (2.1) has a solution on $[t_1; +\infty)$ for some $t_1 \geq t_0$. Then Eq. (2.1) has a positive solution on $[t_1; +\infty)$.

See proof in [5].

Theorem 2.3. Let $a(t) \geq 0$, $c(t) \leq 0$, $t \geq t_0$. Then the following assertions are valid.

I^o). For each $x_{(0)} \geq \frac{-1}{I_{a,b}^+(t_0)}$ (for $I_{a,b}^+(t_0) = +\infty$ we take that $\frac{1}{I_{a,b}^+(t_0)} = 0$) Er. (2.1) has a t_0 -regular solution $x_0(t)$ with $x_0(t_0) = x_{(0)}$, and

$$\frac{x_{(0)}J_{-b}(t)}{1 + x_{(0)}I_{a,b}^+(t_0; t)} \leq x_0(t) \leq x_{(0)}J_{-b}(t) - I_{a,b}^-(t_0; t), \quad t \geq t_0, \quad (2.18)$$

moreover if $x_{(0)} = 0$, then there exists $t_1 \geq t_0$ such that $x_0(t) = 0$, $t \in [t_0; t_1]$, $x_0(t) > 0$, $t > t_1$. If $x_{(0)} > 0$ then $x_0(t) > 0$, $t \geq t_0$.

II^o). The unique t_0 -extremal solution $x_*(t)$ of Eq. (2.1) is negative.

III^o). If $I_{a,b}^+(t_0) = +\infty$ or $I_{c,-b}^+(t_0) = -\infty$, then for each solution $x(t)$ of Eq. (2.1) with $x(t_0) \in (x_*(t_0); 0)$ there exists $t_2 = t_2(x) \geq t_1 = t_1(x) > t_0$ such that $x(t) < 0$, $t \in [t_0; t_1]$, $x(t) = 0$, $t \in [t_1; t_2]$ and $x(t) > 0$, $t > t_2$.

IV^o). If $I_{a,b}^+(t_0) = +\infty$, then for each t_0 -normal solution $x_N(t)$ of Eq. (2.1) the equality

$$\int_{t_0}^{+\infty} a(\tau)x_N(\tau)d\tau = +\infty. \text{ is fulfilled.}$$

V°). If $I_{c,-b}^+(t_0) = -\infty$, then $\int_{t_0}^{+\infty} a(\tau)x_*(\tau)d\tau = -\infty$, where $x_*(t)$ is the unique t_0 -extremal solution of Eq. (2.1).

VP). If $I_{a,b}^+(t_0) < +\infty$ and $I_{-c,-b}^+(t_0) < +\infty$, then Eq. (2.1) has a negative t_0 -normal solution $x_N^-(t)$ such that for each solution $x(t)$ of Eq. (2.1) with $x_0(t_0) \in (x_N^-(t_0); 0)$ there exists $t_2 = t_2(x) \geq t_1 = t_1(x) > t_0$ such that $x(t) < 0$, $t \in [t_0; t_1)$, $x(t) = 0$, $t \in [t_1; t_2]$, $x(t) > 0$, $t > t_2$.

VIP). If

$$I_{a,b}^+(t_0) = +\infty, \quad \int_{t_0}^{+\infty} |c(\tau)|I_{-b,a}^-(t_0; \tau)d\tau < +\infty, \quad (2.19)$$

then $\int_{t_0}^{+\infty} a(\tau)x_*(\tau)d\tau > -\infty$, $\int_{t_0}^{+\infty} c(\tau)u_*(\tau)d\tau = +\infty$, where $u_*(t)$ is the unique t_0 -extremal solution of the equation

$$u' - c(t)u^2 - b(t)u - a(t) = 0, \quad t \geq t_0.$$

Proof. Set $a_1(t) = a(t)$, $b_1(t) = b(t)$, $t \geq t_0$, $c_1(t) \equiv 0$. Then for each $x_{(0)} \geq \frac{-1}{I_{a,b}^+(t_0)} \stackrel{def}{=} A$ the function $x_1(t) \equiv \frac{x_{(0)}J_{-b}(t)}{1+x_{(0)}I_{a,b}^+(t_0;t)}$ is a t_0 -regular solution of Eq. (2.5), and the conditions of Theorem 2.1 are fulfilled. Therefore for each $x_{(0)} \geq A$ Eq. (2.1) has a t_0 -regular solution $x_0(t)$ with $x_0(t_0) = x_{(0)}$ and the first of conditions of inequalities (2.18) is satisfied. Set $a_1(t) = a(t)$, $b_1(t) = b(t)$, $c_1(t) = c(t)$, $t \geq t_0$. Then by already proven Eq. (2.5) will have t_0 -regular solutions, coinciding with the t_0 -regular solutions of Eq. (2.1). In the Eq. (2.1) set: $a(t) \equiv 0$. Then $x_2(t) \equiv x_{(0)}J_{-b}(t_0;t) - I_{b,c}^-(t_0;t)$ is a t_0 -regular solution of Eq. (2.1). Obviously in this case the conditions of Theorem 2.1. are satisfied. Therefore the second of the inequalities (2.18) is fulfilled. Let $x_{(0)} = 0$. Then since $c(t)$ has unbounded support by virtue of (2.17) from the inequality $c(t) \leq 0$, $t \geq t_0$, it follows existence of $t_1 > t_0$ such that $x(t) = 0$, $t \in [t_0; t_1]$ and $x(t) > 0$, $t > t_1$. The assertion I° is proved. Prove II° . Let $x_0(t)$ be a solution of Eq. (2.1) with $x_0(t_0) > 0$. By virtue of I° $x_0(t)$ is t_0 -normal and positive. Therefore From Theorem 2.2 it follows that for each $t \geq t_0$ the integral $\nu_{x_0}(t)$ converges. Obviously $\nu_{x_0}(t) > 0$, $t \geq t_0$. Then by virtue of the same Theorem 2.2 $x_*(t) \equiv x_0(t) - \frac{1}{\nu_{x_0}(t)}$ is the unique t_0 -extremal solution of Eq. (2.1). Show that $x_*(t) \leq 0$, $t \geq t_0$. By virtue of the first of inequalities (2.18) we have:

$$\frac{x_0(t)J_{-b}(t;s)}{1+x_0(t)I_{a,b}(t;s)} \leq x_0(s), \quad t_0 \leq t \leq s.$$

Multiplying both sides of this inequality on $a(s)$ and integrating by s from t to τ we get:

$$\ln[1 + x_0(t)I_{a,b}(t; \tau)] \leq \int_{t_0}^t a(s)x_0(s)ds, \quad t_0 \leq t \leq \tau. \text{ Then}$$

$$\begin{aligned} \nu_{x_0}(t) &\leq \int_t^{+\infty} \frac{a(\tau)J_{-b}(t; \tau)d\tau}{1 + x_0(t)I_{a,b}^+(t; \tau)} = -\frac{1}{x_0(t)} \int_t^{+\infty} d\left(\frac{1}{1 + x_0(t)I_{a,b}^+(t; \tau)}\right) = \\ &= \frac{1}{x_0(t)} \left[1 - \frac{1}{1 + x_0(t)I_{a,b}^+(t; +\infty)}\right] \leq \frac{1}{x_0(t)}, \quad t \geq t_0. \end{aligned}$$

From here it follows that $x_*(t) \leq 0$, $t \geq t_0$. Show that

$$x_*(t) < 0, \quad t \geq t_0. \quad (2.20)$$

Suppose that it is not true. Then since $x_*(t) \leq 0$, $t \geq t_0$, there exists $t_1 \geq t_0$ such that $x_*(t_1) = 0$. By the first of the inequalities (2.18) from here it follows that $x_*(t) \geq 0$, $t \geq t_1$. Hence $x_*(t) \equiv 0$ on $[t_1; +\infty)$, which is impossible (since on $[t_1; +\infty)$ $c(t) \not\equiv 0$.) The obtained contradiction proves (2.20), and therefore the assertion II° does. Prove III°. Let $x_0(t)$ and $x_1(t)$ be solutions of Eq. (2.1) with the initial conditions $x_0(t_0) > 0$, $x_1(t_0) \in (x_*(t_0); 0)$. By virtue of Lemma 2.1 $x_0(t)$ and $x_1(t)$ are t_0 -normal. Therefore by (2.8) we have

$$\int_{t_0}^{+\infty} a(\tau)[x_0(\tau) - x_1(\tau)]d\tau < +\infty. \quad (2.21)$$

Suppose $I_{a,b}^+(t_0) = +\infty$. Then from the first of inequalities (2.18) it follows:

$$\int_{t_0}^{+\infty} a(\tau)x_0(\tau)d\tau \geq \ln[1 + x_0(t_0)I_{a,b}^+(t_0)] = +\infty, \quad (2.22)$$

Show that there exists $\tilde{t}_1 \geq t_0$ such that $x_1(\tilde{t}_1) = 0$. Suppose that it is not true. Then $x_1(t) < 0$, $t \geq t_0$. Taking into account (2.18) from here we obtain:

$$\int_{t_0}^{+\infty} a(\tau)(x_0(\tau) - x_1(\tau))d\tau \geq \int_{t_0}^{+\infty} a(\tau)x_0(\tau)d\tau = +\infty, \quad (2.23)$$

which contradicts (2.21). The obtained contradiction shows that $x_1(\tilde{t}_1) = 0$ for some $\tilde{t}_1 > t_0$. Since $c(t)$ has unbounded support by virtue of (2.4) from here and from non positivity of $c(t)$ it follows that $x_1(t) < 0$, $t \in [t_0; t_1)$, $x_1(t) = 0$, $t \in [t_1; t_2]$ and $x_1(t) > 0$, $t > t_2$, for some $t_2 \geq t_1 > t_0$. Suppose $I_{c,-b}^+(t_0) = -\infty$. Consider the equation

$$u' - c(t)u^2 - b(t)u - a(t) = 0, \quad t \geq t_0. \quad (2.24)$$

By II $^\circ$ the unique t_0 -extremal solution $u_*(t)$ of this equation is negative. Therefore $\tilde{x}_*(t) \equiv \frac{1}{u_*(t)}$ is a t_0 -regular solution of Eq. (2.1). By already proven, from here and from the equality $I_{c,-b}^+(t_0) = -\infty$ it follows that each solution $u(t)$ of Eq. (2.24) with $u(t_0) \in (u_*(t_0); 0)$ vanishes on $[t_0; +\infty)$. Therefore each solution $x(t)$ of Eq. (2.1) with $x(t_0) < \tilde{x}(t_0)$ is not t_0 -regular. By virtue of Lemma 2.1 from here it follows that

$$u_*(t) = \frac{1}{x_*(t)}, \quad t \geq t_0. \quad (2.25)$$

Suppose that some solution $\tilde{x}(t)$ of Eq. (2.1) with $\tilde{x}(t_0) \in (x_*(t_0); 0)$ is negative. Then $\tilde{u}(t) \equiv \frac{1}{\tilde{x}(t)}$, $t \geq t_0$, is a t_0 -regular solution of Eq. (2.24), and $\tilde{u}(t_0) = \frac{1}{\tilde{x}(t_0)} < \frac{1}{x_*(t_0)}$. From here and from (2.25) it follows that $\tilde{u}(t_0) < u_*(t_0)$, which contradicts Lemma 2.1. The obtained contradiction shows that for any solution $x(t)$ of Eq. (2.1) with $x(t_0) \in (x_*(t_0); 0)$ there exists $t_1 = t_1(x) > t_0$ such that $x(t_1) = 0$, $x(t) < 0$, $t \in [t_0; t_1)$. Since $c(t)$ has unbounded support by (2.4) from here and from non negativity of $c(t)$ it follows that there exists $t_2 = t_2(x) \geq t_1$ such that $x(t) = 0$, $t \in [t_1; t_2]$, $x(t) > 0$, $t > t_2$. The assertion III $^\circ$ is proved. Prove IV $^\circ$. Let $x_+(t)$ be a solution of Eq. (2.1) with $x_+(t_0) = 1$. On the strength of Lemma 2.1 from the assertion I $^\circ$ it follows that $x_+(t)$ is t_0 -normal. By the first of the inequalities (2.18) we have $x_+(t) \geq J_{-b}(t)$, $t \geq t_0$. Let $I_{a,b}^+(t_0) = +\infty$. Then from the last inequality it follows that

$$\int_{t_0}^{+\infty} a(\tau)x_+(\tau)d\tau \geq I_{a,b}^+(t_0) = +\infty. \quad (2.26)$$

Let $x_N(t)$ be an arbitrary t_0 -normal solution of Eq. (2.1). By (2.9) we have: $\int_{t_0}^{+\infty} |x_+(\tau) - x_N(\tau)|d\tau < +\infty$. From here and from (2.26) we will get:

$\int_{t_0}^{+\infty} a(\tau)x_N(\tau)d\tau = \int_{t_0}^{+\infty} a(\tau)(x_N(\tau) - x_+(\tau))d\tau + \int_{t_0}^{+\infty} a(\tau)x_+(\tau)d\tau = +\infty$. The assertion IV $^\circ$ is proved. Prove V $^\circ$. Since on the strength of II $^\circ$ $I_*(t) \equiv \int_{t_0}^t a(\tau)x_*(\tau)d\tau$ is a monotonically non increasing function on $[t_0; +\infty)$, from Lemma 2.3 it follows (after differentiation (2.10)):

$$\begin{aligned}
 a(t)x_0(t) \exp\left\{\int_{t_0}^t a(\xi)x_0(\xi)d\xi\right\} \int_t^{+\infty} \frac{a(s)x_0(s)}{x_0(t_0)} \exp\left\{\int_{t_0}^s \left[\frac{c(\xi)}{x_0(\xi)} - a(\xi)x_0(\xi)\right]d\xi\right\} ds \leq \\
 \leq \frac{a(t)x_0(t)}{x_0(t_0)} \exp\left\{\int_{t_0}^t \frac{c(\xi)}{x_0(\xi)}d\xi\right\}, \quad t \geq t_0. \quad (2.27)
 \end{aligned}$$

where $x_0(t) (> 0, t \geq t_0)$ is a t_0 -normal solution of Eq. (2.1) (by virtue of Lemma 2.1 from I $^\circ$ it follows the existence of $x_0(t)$). Since $u_0(t) \equiv \frac{1}{x_0(t)}$ is a t_0 -normal solution of Eq. (2.24) and $I_{-c,-b}^+(t_0) = +\infty$, by IV $^\circ$ we have:

$$\int_{t_0}^{+\infty} c(\tau)u_0(\tau)d\tau = \int_{t_0}^{+\infty} \frac{c(\tau)}{x_0(\tau)}d\tau = -\infty. \quad (2.28)$$

Since $a(t)$ has unbounded support there exists infinitely large sequence $t_0 < t_1 < \dots < t_m < \dots$ such that $a(t_m) > 0, m = 1, 2, \dots$. Then from (2.27) it follows

$$\exp\left\{\int_{t_0}^{t_m} a(\xi)x_0(\xi)d\xi\right\} \int_{t_m}^{+\infty} \frac{a(s)x_0(s)}{x_0(t_0)} \exp\left\{\int_{t_0}^s \left[\frac{c(\xi)}{x_0(\xi)} - a(\xi)x_0(\xi)\right]d\xi\right\} ds \leq \exp\left\{\int_{t_0}^{t_m} \frac{c(\xi)}{x_0(\xi)}d\xi\right\},$$

$m = 1, 2, \dots$. Due to Lemma 2.3 From here and from (2.28) it folloes that $I_*(t_m) \rightarrow -\infty$ for $m \rightarrow +\infty$. Hence, $\int_{t_0}^{+\infty} a(\tau)x(\tau)d\tau = -\infty$. The assertion V $^\circ$ is proved. Prove VI $^\circ$.

Show that Eq. (2.1) has a t_0 -normal negative solution. In Eq. (2.1) make the change: $x = J_{-b}(t_0; t)X, t \geq t_0$. We will come to the equation

$$X' + a(t)J_{-b}(t)X^2 + c(t)J_b(t) = 0, \quad t \geq t_0. \quad (2.29)$$

Due to conditions of VI $^\circ$ chose $t_1 (> t_0)$ so large that

$$\left[\int_{t_1}^{+\infty} a(\tau)J_{-b}(\tau)d\tau\right]^{-1} > -\int_{t_1}^{+\infty} c(\tau)J_b(\tau)d\tau.$$

Then

$$-[I_{a,b}^+(t_0)]^{-1} < I_{c,-b}^+(t_0) < 0. \quad (2.30)$$

Let then $X_-(t)$ be a solution to Eq. (2.29) with

$$X_-(t_1) \in (-[I_{a,b}^+(t_0)]^{-1}; I_{c,-b}^+(t_0)). \quad (2.31)$$

By (2.18) the inequalities

$$\frac{X_-(t_1)}{1 + X_-(t_1)I_{a,b}^+(t_1;t)} \leq X_-(t) \leq X_-(t_1) - I_{c,-b}^+(t_1;t), \quad t \geq t_1, \quad (2.32)$$

are fulfilled. From here and from (2.30) and (2.31) it follows that $X_-(t)$ is a defined on $[t_1; +\infty)$ negative t_1 -normal solution of Eq. (2.29). Then $x_-(t) \equiv X_-(t)J_{-b}(t_1;t)$ is a defined on $[t_1; +\infty)$ negative t_1 -normal solution to Eq. (2.1). Show that $x_-(t)$ is continuable on $[t_0; +\infty)$ as a solution to Eq. (2.1). Suppose $x_-(t)$ can not be continued on $[t_0; +\infty)$ as a solution of Eq. (2.1). Let then $(t_2; +\infty)$ be the maximum existence interval for $x_-(t)$, where $t_2 \geq t_0$. By Lemma 2.2 there exists $t_3 > t_2$ such that $x_-(t_3) > 0$. On the strength of the first of the inequalities (2.18) from here it follows that $x_-(t) > 0$, $t \geq t_3$. The obtained contradiction shows that $x_-(t)$ is continuable on $[t_0; +\infty)$. By virtue of the first of the inequalities (2.18) the supposition that $x_-(t_4) \geq 0$ for some $t_4 \geq t_0$ also leads to the contradiction. So, $x_-(t) < 0$, $t \geq t_0$. Since $x_-(t)$ is t_1 -normal, by continuable dependence of solutions of Eq. (2.1) from their initial values, the solution $x_-(t)$ also is t_0 -normal. According to I° the solution $x_0(t)$ of Eq. (2.1) with $x_0(t_0) = 0$ starting with some $t_1 = t_1(x_0) \geq t_6$ becomes positive. Then by continuable dependence of solutions of Eq. (2.1) from their initial values, all initial values $x_{(0)}$, for which the solutions $x(t)$ of Eq. (2.1) with $x(t_0) = x_{(0)}$ eventually become positive, form an open set. From here from Lemma 2.1 and from the fact that $x_-(t)$ is negative it follows that there exists a negative t_0 -normal solution $X_N^-(t)$ of Eq. (2.1) such that any solution $x(t)$ of Eq. (2.1) with $x(t_0) > X_N^-(t_0)$ eventually becomes positive. By (2.4) from here it follows that for any solution $x(t)$ of Eq. (2.1) with $x(t_0) \in (x_N^-(t_0); 0)$ there exists $t_2 = t_2(x) \geq t_1 = t_1(x) > t_0$ such that $x(t) < 0$, $t \in [t_0; t_1)$, $x(t) = 0$, $t \in [t_1; t_2]$, $x(t) > 0$, $t > t_2$. By (2.8) $\int_{t_0}^{+\infty} a(\tau)[x_*(\tau) - x_N(\tau)]d\tau = -\infty$. Then $\int_{t_0}^{+\infty} a(\tau)x_*(\tau)d\tau \leq \int_{t_0}^{+\infty} a(\tau)[x_*(\tau) - x_N(\tau)]d\tau = -\infty$. Let $x_+(t)$ be a solution to Eq. (2.1) with $x_+(t_0) = 1$. On the strength of Lemma 2.1 from I° it follows that $x_+(t)$ is t_0 -normal. Then by (2.9) we have:

$$0 < \int_{t_0}^{+\infty} a(\tau)x_+(\tau)d\tau \leq \int_{t_0}^{+\infty} a(\tau)[x_+(\tau) - x_N^-(\tau)]d\tau < +\infty. \quad (2.33)$$

Let $x_N(t)$ be an arbitrary t_0 -normal solution to Eq. (2.1). Then since $\int_{t_0}^{+\infty} a(\tau)x_N(\tau)d\tau = \int_{t_0}^{+\infty} [x_N(\tau) - x_+(\tau)]d\tau + \int_{t_0}^{+\infty} a(\tau)x_+(\tau)d\tau$ and by virtue of (2.9) $\int_{t_0}^{+\infty} a(\tau)|x_N(\tau) - x_+(\tau)|d\tau < +\infty$, from (2.33) it follows that the integral $\int_{t_0}^{+\infty} a(\tau)x_N(\tau)d\tau$ converges. The assertion VI $^\circ$ is proved. Prove VII $^\circ$. Due to the second of inequalities (2.18) taking into account the inequality $c(t) \leq 0$, $t \geq t_0$ we have:

$$\int_{t_0}^t \frac{c(\tau)}{x_0(\tau)}d\tau \geq \frac{1}{x_0(t_0)} \int_{t_0}^t c(\tau)J_b(t) \left[1 + x_0(t_0)I_{a,b}^+(t_0; \tau) \right] d\tau, \quad t \geq t_0, \quad (2.34)$$

where $x_0(t)$ is a positive t_0 -normal solution of Eq. (2.1), existence of which follows from Lemma 2.1 and from I $^\circ$. By virtue of Fubini's theorem from the second relation of (2.19) it follows that $I_{-b,-c}^+(t_0; +\infty) < +\infty$. From here and from the second relation of (2.19) and from (2.34) it follows that

$$\int_{t_0}^{+\infty} \frac{c(\tau)}{x_0(\tau)}d\tau > -\infty. \quad (3.35)$$

From the first relations of (2.18) and (2.19) it follows that

$$\int_{t_0}^{+\infty} a(\tau)x_0(\tau)d\tau = +\infty. \quad (2.36)$$

Set $g(t) \equiv \exp \left\{ - \int_{t_0}^t a(\xi)x_0(\xi)d\xi \right\}$. Obviously the inverse function $g^{-1}(t)$ of $g(t)$ exists on $\text{supp } a(t)$. Denote:

$$g_1(t) \equiv \begin{cases} g^{-1}(t), & t \in \text{supp } a(t); \\ t_0, & t \notin \text{supp } a(t), \quad t \geq t_0. \end{cases}$$

Then taking into account (2.36) the equality (2.16) can be rewritten in the form

$$\int_{t_0}^t a(\tau)x_*(\tau)d\tau = -\ln \nu_{x_0}(t_0) + \ln \left[\frac{\int_0^{g(t)} \exp \left\{ \int_{t_0}^{g^{-1}(\zeta)} \frac{c(\xi)}{x_0(\xi)}d\xi \right\} d\zeta}{x_0(t_0)g(t)} \right] \geq 1, \quad t \geq t_0.$$

From here and from (2.35) it follows that

$$\int_{t_0}^{+\infty} a(\tau)x_*(\tau)d\tau \geq -\ln[x_0(t_0)\nu_{x_0}(t_0)] + \int_{t_0}^{+\infty} \frac{c(\xi)}{x_0(\xi)}d\xi > -\infty.$$

By virtue of Lemma 2.1 $u_0(t) \equiv \frac{1}{x_0(t)}$ is a t_0 -normal solution of Eq. (2.24) (since for $x_1(t_0) > x_0(t_0)$ the function $u_1(t) \equiv \frac{1}{x_1(t)}$ is a t_0 -regular solution of Eq. (2.24), where $x_1(t)$ is a t_0 -regular solution to Eq. (2.1)). Then by (2.8) taking into account (2.35) we obtain:

$$\int_{t_0}^{+\infty} c(\tau)u_*(\tau)d\tau = \int_{t_0}^{+\infty} c(\tau)(u_*(\tau) - u_0(\tau))d\tau + \int_{t_0}^{+\infty} \frac{c(\tau)}{x_0(\tau)}d\tau = +\infty.$$

The assertion VII° is proved. The theorem is proved.

On the basis of Theorem 2.3 it can be make phase portrait of solutions of Eq. (2.1) in the case $a(t) \geq 0$, $c(t) \leq 0$, $t \geq t_0$, for the following two possible restrictions:

- a) $I_{a,b}^+(t_0) = +\infty$ or $I_{c,-b}^+(t_0) = -\infty$ (see pict. 1) ;
- b) $I_{a,b}^+(t_0) < +\infty$ and $I_{-c,-b}^+(t_0) < +\infty$ (see pict. 2).

In pict 1. we see only one negative global solution of Eq (2.1), meanwhile in pict. 2 we see whole slice of negative global solutions of Eq. (2.1).

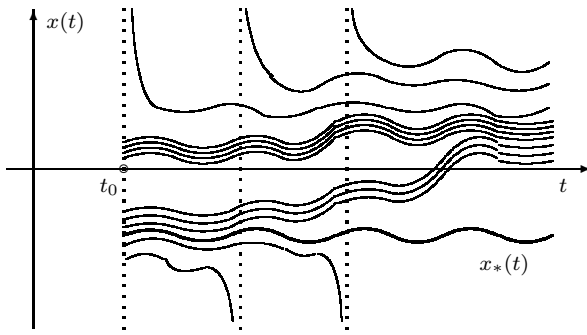

pict.1. $I_{a,b}^+(t_0) = +\infty$ or $I_{-c,-b}^+(t_0) = +\infty$

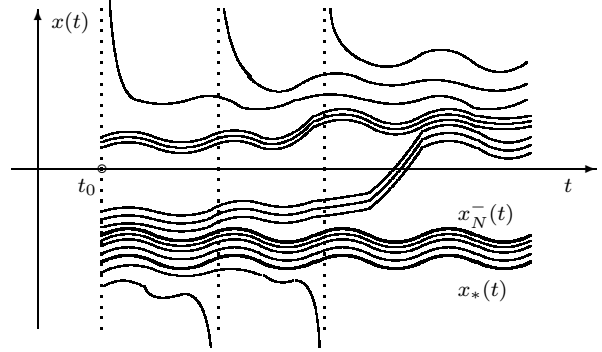

pict.2. $I_{a,b}^+(t_0) < +\infty$ and $I_{-c,-b}^+(t_0) < +\infty$

Theorem 2.4. Suppose $a(t) \geq 0$, $c(t) \geq 0$, $t \geq t_0$, and Eq. (2.1) has a t_0 -regular solution. Then the following assertions are valid.

I* If $I_{a,b}^+(t_0) = +\infty$, then every t_0 -regular solution of Eq. (2.1) is positive and for its every t_0 -normal solution $x_N(t)$ the equality $\int_{t_0}^{+\infty} a(\tau)x_N(\tau)d\tau = +\infty$ is fulfilled. Moreover if in

addition $\int_{t_0}^{+\infty} c(\tau)I_{a,-b}^+(t_0; \tau)d\tau = +\infty$, then also $\int_{t_0}^{+\infty} a(\tau)x_*(\tau)d\tau = +\infty$, where $x_*(t)$ is the unique t_0 -extremal solution of Eq. (2.1).

II* If $I_{c,-b}^+(t_0) = +\infty$, then for every t_0 -regular solution $x(t)$ of Eq. (2.1) with $x(t_0) > 0$ there exist $t_2 = t_2(x) \geq t_1 = t_1(x) > t_0$ such that $x(t) > 0$, $t \in [t_0; t_1)$, $x(t) = 0$, $t \in [t_1; t_2]$, $x(t) < 0$, $t > t_2$, and if $x(t_0) = 0 (< 0)$, there exists $t_1 = t_1(x) \geq t_0$ such that $x(t) = 0$, $t \in [t_0; t_1]$, $x(t) < 0$, $t > t_1$ (then $x(t) < 0$, $t \geq t_0$), and $\int_{t_0}^{+\infty} a(\tau)x_*(\tau)d\tau =$

$-\infty$. Moreover if in addition $\int_{t_0}^{+\infty} a(\tau)I_{b,c}^-(t_0; \tau)d\tau = +\infty$, then for every t_0 -normal solution

$x_N(t)$ of Eq. (2.1) the equality $\int_{t_0}^{+\infty} a(\tau)x_N(\tau)d\tau = -\infty$ is fulfilled.

III* If $I_{a,b}^+(t_0) < +\infty$ and $I_{c,-b}^+(t_0) < +\infty$, then there exist $t_1 \geq t_0$ such that $x_*(t) < 0$, $t \geq t_1$; the solutions $x(t)$ of Eq. (2.1) with $x(t_1) \in (x_*(t_1); 0)$ are t_0 -regular and $x(t) < 0$, $t \geq t_1$; there exists a t_1 -normal positive on $[t_1; +\infty)$ solution $x_N^+(t)$ of Eq. (2.1) such that for every solution $x(t)$ of Eq. (2.1) with $x(t_1) \in (0; x_N^+(t_1))$ there exist $t_3 = t_3(x) \geq t_2 = t_2(x) > t_1$ such that $x(t) > 0$, $t \in [t_1; t_2)$, $x(t) = 0$, $t \in [t_2; t_3]$, $x(t) < 0$, $t > t_3$, and if $x(t_1) = 0$ ($x(t_1) < 0$), there exists $t_2 = t_2(x) \geq t_1$ such that $x(t) = 0$, $t \in [t_1; t_2]$, $x(t) < 0$, $t > t_2$ (then $x(t) < 0$, $t \geq t_1$); for every t_0 -normal solution $x_N(t)$ of Eq. (2.1) the integral $\int_{t_0}^{+\infty} a(\tau)x_N(\tau)d\tau$ converges and $\int_{t_0}^{+\infty} a(\tau)x_*(\tau)d\tau = -\infty$.

Proof. Let us prove I*. Let $x_*(t)$ be the t_0 -extremal solution of Eq. (2.1). Show that $x_*(t) > 0$, $t \geq t_0$. Suppose for some $t_1 > t_0$ the inequality $x_*(t_1) < 0$ is satisfied. Let then $x(t)$ be a solution to Eq. (2.1) with $x(t_1) \in (x_*(t_1); 0)$. By virtue of Lemma 2.1 $x(t)$ is t_1 -normal. Since $x(t_1) < 0$ and $c(t) \geq 0$, $t \geq t_0$, by (2.4) we have $x(t) < 0$, $t \geq t_1$. From here it follows that

$$\nu_x(t_1) \geq I_{a,b}^+(t_1). \quad (2.37)$$

Suppose $I_{a,b}^+(t_0) = +\infty$. Then from the easily verifiable equality

$$I_{a,b}^+(t_0) = I_{a,b}^+(t_0; t) + J_b(t_1)I_{a,b}^+(t_1) \quad (2.38)$$

and from (2.37) it follows that $\nu_x(t_1) = +\infty$. But on the other hand since $x(t)$ is t_1 -normal by virtue of Theorem 2.2 we have $\nu_x(t_1), +\infty$. The obtained contradiction shows that $x_*(t) \geq 0$, $t \geq t_0$. Show that the equality $x_*(t) = 0$ is impossible for all $t \geq t_0$. Suppose for some $t_2 \geq t_0$ the equality $x_*(t_2) = 0$ is satisfied. Then by (2.4) from the inequality $c(t) \geq 0$, $t \geq t_0$ it follows that $x_*(t) \leq 0$, $t \geq t_2$. Hence, $x_*(t) \equiv 0$ on $[t_2; +\infty)$, which is impossible (since on $[t_2; +\infty)$ we have $c(t) \not\equiv 0$). On the strength of Lemma 2.1 from here

it follows that every t_0 -regular solution of Eq. (2.1) is positive. Let $x_N(t)$ be a t_0 -normal solution of Eq. (2.1). Then since $x_*(t) > 0$, $t \geq t_0$, by (2.8) we have: $\int_{t_0}^{+\infty} a(\tau)x_N(\tau)d\tau = \int_{t_0}^{+\infty} a(\tau)[x_N(\tau) - x_*(\tau)]d\tau + \int_{t_0}^{+\infty} a(\tau)x_*(\tau)d\tau \geq \int_{t_0}^{+\infty} a(\tau)[x_N(\tau) - x_*(\tau)]d\tau = +\infty$. Suppose

$$\int_{t_0}^{+\infty} c(\tau)I_{a,b}(t_0; \tau)d\tau = +\infty, \quad (2.39)$$

and $\int_{t_0}^{+\infty} a(\tau)x_*(\tau)d\tau < +\infty$. Show that then

$$x_*(t) = \int_t^{+\infty} J_b(t; \tau)c(\tau)\phi_*(t; \tau)d\tau, \quad t \geq t_0, \quad (2.40)$$

where $\phi_*(t; \tau) \equiv \exp\left\{\int_t^\tau a(s)x_*(s)ds\right\}$, $\tau \geq t \geq t_0$. By (2.4) we have:

$$x_*(t) = J_{-h_*}(t_1; t) \left[x_*(t_1) - \int_{t_1}^t J_b(t_1; \tau)c(\tau)\phi_*(t_1; \tau)d\tau \right], \quad t \geq t_1 \geq t_0, \quad (2.41)$$

where $h_*(t) \equiv a(t)x_*(t) + b(t)$, $t \geq t_0$. From here and from the positivity of $x_*(t)$ it follows that

$$x_*(t) \geq \int_{t_1}^{+\infty} j_b(t_1; \tau)c(\tau)\phi_*(t_1; \tau)d\tau, \quad t_1 \geq t_0.$$

Show that the strict inequality

$$x_*(t) > \int_{t_1}^{+\infty} J_b(t_1; \tau)c(\tau)\phi_*(t_1; \tau)d\tau \quad (2.42)$$

is impossible for all $t_1 \geq t_0$. Multiplying both sides of (2.41) on $a(t)\phi_*(t_1; t)$ and integrating from t_1 to $+\infty$ we get:

$$\exp\left\{\int_{t_1}^{+\infty} a(\tau)x_*(\tau)d\tau\right\} = 1 + \int_{t_1}^{+\infty} J_{-b}(t_1; \tau) \left[x_*(t_1) - \int_{t_1}^t J_b(t_1; \tau)c(\tau)\phi_*(t_1; \tau)d\tau \right] d\tau \geq$$

$$1 + I_{a,b}^+(t_1) \left[x_*(t_1) - \int_{t_1}^{+\infty} J_b(t_1; \tau) c(\tau) \phi_*(t_1; \tau) d\tau \right]. \quad (2.43)$$

Suppose for some $t_1 \geq t_0$ the inequality (2.42) is satisfied. Then by (2.38) from the equality $I_{a,b}^+(t_0) = +\infty$ and from (2.43) it follows that $\int_{t_1}^{+\infty} a(\tau) x_*(\tau) d\tau = +\infty$. The obtained contradiction proves (2.40). Multiplying both sides of (2.40) on $a(t) \phi_*(t_0; t)$ and integrating from t_0 to $+\infty$ we will get: $\exp \left\{ \int_{t_0}^{+\infty} a(\tau) x_*(\tau) d\tau \right\} = 1 + \int_{t_0}^{+\infty} a(\tau) \phi_*(t_0; \tau) d\tau \int_t^{+\infty} J_b(t; \tau) c(\tau) \phi_*(t; \tau) d\tau \geq 1 + \int_{t_0}^{+\infty} a(t) dt \int_t^{+\infty} J_b(t; \tau) c(\tau) d\tau$. By virtue of Fubini's theorem from here and from (2.39) it follows that $\int_{t_0}^{+\infty} a(\tau) x_*(\tau) d\tau = +\infty$. We came to the contradiction. The assertion I* is proved. Let us prove II*. Let $x(t)$ be a t_0 -regular solution of Eq. (2.1). If $x(t_0) < 0$, then by (2.4) from inequality $c(t) \geq 0$, $t \geq t_0$ it follows that $x(t) < 0$, $t \geq t_0$. Let $x(t_0) \geq 0$. Show that in this case it is impossible that

$$x(t) \geq 0, \quad t \geq t_0. \quad (2.44)$$

Suppose this relation is true. Then since $a(t) \geq 0$, $c(t) \geq 0$, $t \geq t_0$, we have

$$\int_{t_0}^t J_b(\tau) c(\tau) \exp \left\{ \int_{t_0}^{\tau} a(s) x(s) ds \right\} d\tau \geq I_{c,-b}^+(t_0; t), \quad t \geq t_0.$$

By (2.4) from here and from equality $I_{c,-b}^+(t_0) = +\infty$ it follows that $x(t_1) < 0$ for some $t_1 > t_0$. We came to the contradiction. Hence by (2.4) if $x(t_0) > 0$, then there exists $t_2 = t_2(x) \geq t_1 = t_1(x) > t_0$ such that $x(t) > 0$, $t \in [t_0; t_1)$, $x(t) = 0$, $t \in [t_1; t_2]$, $x(t) < 0$, $t > t_2$, and if $x(t_0) = 0$, then there exists $t_1 = t_1(x) \geq t_0$ such that $x(t) = 0$, $t \in [t_0; t_1]$, and $x(t) < 0$, $t \geq t_1$. Let $x_0(t)$ be a t_0 -normal solution of Eq. (2.1) with $x_0(t_0) \geq 0$, and let $t_1 = t_1(x) \geq t_0$ such that $x_0(t_1) = 0$, $x_0(t) < 0$, $t > t_1$. Then since by (2.8)

$$\int_{t_1}^{+\infty} a(\tau) [x_*(\tau) - x_0(\tau)] d\tau = -\infty, \text{ we have}$$

$$\int_{t_0}^{+\infty} a(\tau) x_*(\tau) d\tau = \int_{t_0}^{t_1} a(\tau) x_*(\tau) d\tau + \int_{t_1}^{+\infty} a(\tau) [x_*(\tau) - x_0(\tau)] d\tau + \int_{t_1}^{+\infty} a(\tau) x_0(\tau) d\tau \leq$$

$$\leq \int_{t_0}^t a(\tau)x_*(\tau)d\tau + \int_{t_1}^{+\infty} a(\tau)[x_*(\tau) - x_0(\tau)]d\tau = -\infty.$$

Using Theorem 2.1 by analogy of the second of inequalities (2.18) can be obtained the estimation

$$x_0(t) \leq x_0(t_1)J_{-b}(t_1; t) - I_{b,c}^-(t_1; t) = -I_{b,c}^-(t_1; t), \quad t \geq t_1.$$

Then

$$\int_{t_0}^{+\infty} a(\tau)x_0(\tau)d\tau \leq \int_{t_0}^{t_1} a(\tau)x_0(\tau)d\tau - \int_{t_1}^{+\infty} a(\tau)I_{a,b}^-(t_1; \tau)d\tau. \quad (2.45)$$

Since $I_{b,c}^-(t_0; t) = I_{b,c}^-(t_0; t_1)J_{-b}(t_1; t) + I_{b,c}^-(t_1; t)$, we have

$$\int_{t_0}^{+\infty} a(\tau)I_{b,c}^-(t_0; \tau)d\tau = \int_{t_0}^{t_1} I_{b,c}^-(t_1; \tau)d\tau + I_{b,c}^-(t_0; t_1)I_{a,b}^+(t_1; +\infty) + \int_{t_1}^{+\infty} a(\tau)I_{b,c}^-(t_1; \tau)d\tau. \quad (2.46)$$

Since $x_0(t) < 0$, $t > t_1$, by virtue of I^* we obtain

$$I_{a,b}^+(t_1) < +\infty. \quad (2.47)$$

Let $\int_{t_0}^{+\infty} a(\tau)I_{b,c}^-(t_0; \tau)d\tau = +\infty$. Then from (2.45) - (2.47) it follows that

$$\int_{t_0}^{+\infty} a(\tau)x_0(\tau)d\tau = -\infty. \quad (2.48)$$

Let $x_N(t)$ be an arbitrary t_0 -normal solution of Eq. (2.1). Then since by (2.9) $\int_{t_0}^{+\infty} a(\tau)|x_N(\tau) - x_0(\tau)|d\tau < +\infty$, taking into account (2.48) we have: $\int_{t_0}^{+\infty} a(\tau)x_N(\tau)d\tau = \int_{t_0}^{+\infty} a(\tau)[x_N(\tau) - x_0(\tau)]d\tau + \int_{t_0}^{+\infty} a(\tau)x_0(\tau)d\tau = -\infty$. The assertion II^* is proved. Let us prove III^* . Show that

$$x_*(t_1) < 0 \quad (2.49)$$

for some $t_1 \geq t_0$. Suppose that it is not true. Then $x_*(t) \geq 0$, $t \geq t_0$ and therefore $\nu_{x_*}(t_0) \leq I_{a,b}^+(t_0) < +\infty$. But on the other hand by (2.7) we have $\nu_{x_*}(t_0) = +\infty$. The

obtained contradiction proves (2.49). By (2.4) from (2.49) and from non negativity of $c(t)$ it follows that

$$x_*(t) < 0, \quad t \geq t_1. \quad (2.50)$$

Hence $v_*(t) \equiv \frac{1}{x_*(t)}$, $t \geq t_1$ is a t_1 -regular solution of the equation

$$v' + c(t)v^2 - b(t)v + a(t) = 0, \quad t \geq t_0. \quad (2.51)$$

Suppose $I_{c,-b}^+(t_0) < +\infty$. By (2.38) from here it follows that $I_{c,-b}^+(t_1) < +\infty$. Then by already proven $v_*(t) < 0$, $t \geq t_2$ for some $t_2 \geq t_1$, where $v_*(t)$ is the t_1 -extremal solution of Eq. (2.51). From here it follows that $x_1(t) \equiv -\frac{1}{v_*(t)}$ is an positive solution of Eq. (2.1) defined on $[t_2; +\infty)$. Since according to (2.50) $x_*(t_2) < 0$, by virtue of Lemma 2.1 $x_1(t)$ is t_2 -normal. By virtue of continuously dependence of solutions of Eq. (2.1) from their initial values from here from (2.4) and (2.50) it follows that there exists t_1 -normal positive solution $x_N^+(t)$ of Eq. (2.1) on $[t_2; +\infty)$ having the property: for each solution $x(t)$ of Eq. (2.1) with $x(t_2) \in (0; x_N^+(t_2))$ there exists $t_4 = t_4(x) \geq t_3 = t_3(x) > t_2$ such that $x(t) > 0$, $t \in [t_2; t_3)$, $x(t) = 0$, $t \in [t_3; t_4]$, $x(t) < 0$, $t > t_4$; if $x(t_2) = 0$, then there exists $t_3 = t_3(x) \geq t_2$ such that $x(t) = 0$, $t \in [t_2; t_3]$, $x(t) < 0$, $t > t_3$; if $x(t_2) \in (x_*(t_2); 0)$, then $x(t) < 0$, $t \geq t_2$. Let $x_-(t)$ be a solution of Eq. (2.1) with $x_-(t_2) \in (x_*(t_2); 0)$. Then by virtue of Lemma 2.1 $x_-(t)$ is t_2 -normal and, as it was already proved, $x_-(t) < 0$, $t \geq t_2$. Therefore taking into account (2.9) we obtain:

$$0 < \int_{t_0}^{+\infty} a(\tau)x_N^+(\tau)d\tau \leq \int_{t_0}^{t_2} a(\tau)x_N^+(\tau)d\tau + \int_{t_2}^{+\infty} a(\tau)[x_N^+(\tau) - x_-(\tau)]d\tau < +\infty. \quad (2.52)$$

Let $x_N(t)$ be an arbitrary t_0 -normal solution of Eq. (2.1). Then

$$\int_{t_0}^{+\infty} a(\tau)x_N(\tau)d\tau = \int_{t_0}^{t_2} a(\tau)x_N(\tau)d\tau + \int_{t_2}^{+\infty} a(\tau)[x_N(\tau) - x_N^+(\tau)]d\tau + \int_{t_2}^{+\infty} a(\tau)x_N^+(\tau)d\tau. \text{ Since by}$$

(2.9) $\int_{t_2}^{+\infty} a(\tau)|x_N(\tau) - x_N^+(\tau)|d\tau < +\infty$, from the last equality and from (2.52) it follows

convergence of the integral $\int_{t_0}^{+\infty} a(\tau)x_N(\tau)d\tau$. Since $x_N^+(t) > 0$, $t \geq t_2$; $\int_{t_0}^{+\infty} a(\tau)x_*(\tau)d\tau =$

$$\int_{t_0}^{t_2} a(\tau)x_*(\tau)d\tau + \int_{t_2}^{+\infty} a(\tau)[x_*(\tau) - x_N^+(\tau)]d\tau + \int_{t_2}^{+\infty} a(\tau)x_N^+(\tau)d\tau. \text{ and by (2.8) } \int_{t_2}^{+\infty} a(\tau)[x_*(\tau) -$$

$x_N^+(\tau)]d\tau = -\infty$, taking into account (2.52) we have: $\int_{t_0}^{+\infty} a(\tau)x_*(\tau)d\tau = -\infty$. The theorem

is proved.

Remark 2.2. Existence criteria of t_1 -regular solutions of Eq. (2.1) are proved in [5] and [12].

Remark 2.3. If $a(t) > 0$, $t \geq t_0$, then existence of t_1 -regular solutions of Eq. (2.1) is equivalent to the non oscillation of the equation

$$\left(\frac{\phi'}{a(t)}\right)' - a(t)b(t)\phi' - c(t)\phi = 0, \quad t \geq t_0.$$

Non oscillatory criteria for the last equation is proved in [13].

Corollary 2.2. Let $a(t) \geq 0$, $c(t) \geq 0$, $t \geq t_0$, $I_{a,b}^+(t_0) = I_{c,-b}(t_0) = +\infty$. Then Eq. (2.1) has no t_1 -regular solutions for all $t_1 \geq t_0$.

Proof. Suppose that for some $t_1 \geq t_0$ Eq. (2.1) has t_1 -regular solution $x(t)$. Then by virtue of Theorem 2.4 from the equality $I_{a,b}^+(t_1) = I_{a,b}^+(t_0)$ (see (2.38)) it follows that $x(t) > 0$, $t \geq t_1$. Therefore $v(t) \equiv -\frac{1}{x(t)}$, $t \geq t_1$, is a negative t_1 -regular solution of Eq. (2.51). But on the other hand by virtue of Theorem 2.4 I* from the equality $I_{c,-b}^+(t_1) = I_{c,-b}^+(t_0) = +\infty$ it follows that $v(t) > 0$, $t \geq t_1$. We came to the contradiction. The corollary is proved.

On the basis of Theorem 2.1 and corollary 2.2 we can make the phase portrait of solutions of Eq. (2.1) if $a(t) \geq 0$, $c(t) \geq 0$, $t \geq t_0$ for the following four cases:

α) $I_{a,b}^+(t_0) = +\infty$; and Eq. (2.1) has a t_1 -regular solution for some $t_1 \geq t_0$ (see pict. 3);

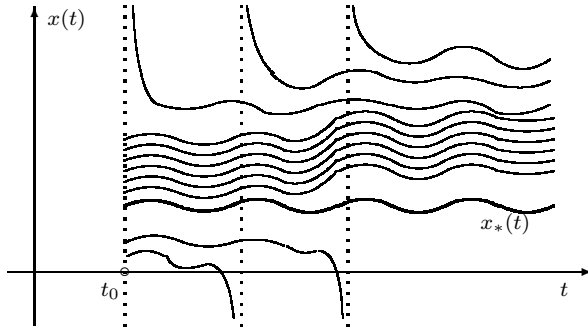

pict.3. $I_{a,b}^+(t_0) = +\infty$

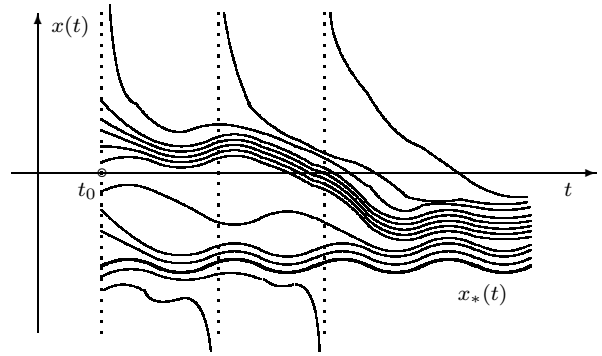

pict.4. $I_{c,-b}^+(t_0) = +\infty$

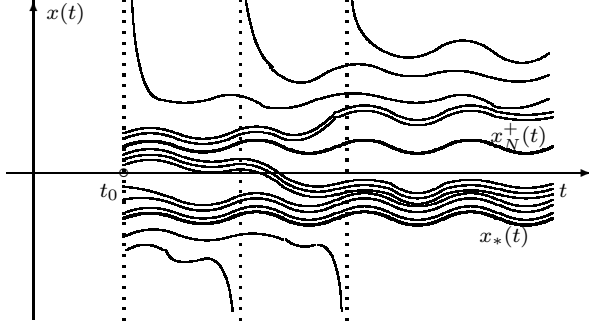

pict.5. $I_{a,b}^+(t_0) < +\infty$ and $I_{c,-b}^+(t_0) < +\infty$

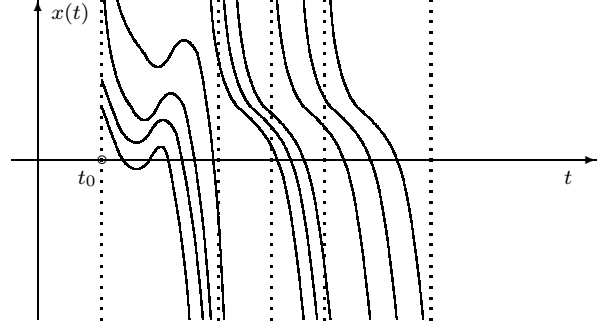

pict.6. $I_{a,b}^+(t_0) = I_{c,-b}^+(t_0) = +\infty$

- β) $I_{c,-b}^+(t_0) = +\infty$; and Eq. (2.1) has a t_1 -regular solution for some $t_1 \geq t_0$ (see pict. 4);
 γ) $I_{a,b}^+(t_0) < +\infty$, $I_{c,-b}^+(t_0) < +\infty$; and Eq. (2.1) has a t_1 -regular solution for some $t_1 \geq t_0$ (see pict. 5);
 δ) $I_{a,b}^+(t_0) = I_{c,-b}^+(t_0) = +\infty$ (see pict. 6).

Let $a(t) > 0$, $t \geq t_0$, and let $x_0(t)$ be a solution of Eq. (2.1) with $x_0(t_0) = 0$. Then by virtue of Theorem 2.3. I° $x_0(t)$ is t_0 -normal and non negative. Obviously

$$x_0(t) + \int_{t_0}^t a(\tau) \left(x_0(\tau) + \frac{b(\tau)}{2a(\tau)} \right)^2 d\tau = \int_{t_0}^t \frac{b^2(\tau) - 4a(\tau)c(\tau)}{4a(\tau)} d\tau, \quad t \geq t_0.$$

Then since $x_0(t) \geq 0$, $t \geq t_0$, we have

$$\int_{t_0}^t a(\tau) \left(x_0(\tau) + \frac{b(\tau)}{2a(\tau)} \right)^2 d\tau \leq \int_{t_0}^t \frac{b^2(\tau) - 4a(\tau)c(\tau)}{4a(\tau)} d\tau, \quad t \geq t_0. \quad (2.53)$$

According to Cauchy - Schwarz inequality we have:

$$\int_{t_0}^t a(\tau) \left(x_0(\tau) + \frac{b(\tau)}{2a(\tau)} \right) d\tau \leq \sqrt{\int_{t_0}^t a(\tau) d\tau} \sqrt{\int_{t_0}^t a(\tau) \left(x_0(\tau) + \frac{b(\tau)}{2a(\tau)} \right)^2 d\tau}$$

From here and from (2.53) we get:

$$\int_{t_0}^t a(\tau)x_0(\tau)d\tau \leq -\frac{1}{2} \int_{t_0}^t b(\tau)d\tau + \frac{1}{2} \sqrt{\int_{t_0}^t a(\tau)d\tau \left[\int_{t_0}^t \frac{b^2(\tau) - 4a(\tau)c(\tau)}{a(\tau)} d\tau \right]} d\tau, \quad (2.54)$$

$t \geq t_0$. Let $x_*(t)$ be a t_0 -extremal solution to Eq. (2.1). Then (see [11])

$$a(t)x_*(t) = \frac{\nu_{x_0}(t)}{\nu_{x_0}(t_0)} - a(t)x_0(t) - b(t), \quad t \geq t_0.$$

From here and from (2.54) we obtain:

$$\begin{aligned} \int_{t_0}^t a(\tau)x_*(\tau)d\tau &\geq -\frac{1}{2} \int_{t_0}^t b(\tau)d\tau - \\ &- \frac{1}{2} \sqrt{\int_{t_0}^t a(\tau)d\tau \left[\int_{t_0}^t \frac{b^2(\tau) - 4a(\tau)c(\tau)}{a(\tau)} d\tau \right]} d\tau + \ln \frac{\nu_{x_0}(t)}{\nu_{x_0}(t_0)}, \quad t \geq t_0. \end{aligned} \quad (2.55)$$

Remark 2.2 *The estimates (2.54) and (2.55) are sharp in the sense that for $a(t) = \text{const}$, $b(t) = \text{const}$, $c(t) = \text{const}$ the estimate (2.54) becomes an equality up to constant summand and the inequality (2.55) becomes an equality.*

Suppose $I_{a,b}^+(t_0) < +\infty$, $I_{-c,-b}^+(t_0) < +\infty$. Then due to Theorem 2.3. VP Eq. (2.1) has a negative t_0 -normal solution. Therefore,

$$\begin{aligned} \nu_{x_0}(t) &= \int_t^{+\infty} a(\tau) \exp \left\{ - \int_t^\tau [2a(s)(x_0(\xi) - x_N^-(\xi)) + 2a(\xi)x_N^-(\xi) + b(\xi)] d\xi \right\} d\tau \geq \\ &\geq \exp \left\{ - \int_t^{+\infty} 2a(s)(x_0(\xi) - x_N^-(\xi)) d\xi \right\} I_{a,b}^+(t, +\infty), \quad t \geq t_0. \end{aligned}$$

From here and from (2.55) we get:

$$\int_{t_0}^t a(\tau)x_*(\tau)d\tau \geq -\frac{1}{2} \int_{t_0}^t b(\tau)d\tau -$$

$$-\frac{1}{2}\sqrt{\int_{t_0}^t a(\tau)d\tau \left[\int_{t_0}^t \frac{b^2(\tau) - 4a(\tau)c(\tau)}{a(\tau)} d\tau \right]} + \ln I_{a,b}^+(t) + c, \quad t \geq t_0. \quad (2.56)$$

where

$$c \equiv - \int_{t_0}^{+\infty} a(\tau)(x_0(\tau) - x_N^-(\tau))d\tau - \ln \nu_{x_0}(t_0). \quad (2.57)$$

Suppose $a(t) > 0$, $c(t) \geq 0$, $t \geq t_0$, $I_{a,b}^+(t_0) = +\infty$, and Eq. (2.1) has a t_0 -regular solution. Obviously

$$x_1(t) + \int_{t_0}^t a(\tau) \left(x_1(\tau) + \frac{b(\tau)}{2a(\tau)} \right)^2 d\tau = x_1(t_0) + \int_{t_0}^t \frac{b^2(\tau) - 4a(\tau)c(\tau)}{4a(\tau)} d\tau, \quad t \geq t_0.$$

Then since by Theorem 2.4. I^* $x_1(t) > 0$, $t \geq t_0$, we have

$$\int_{t_0}^t a(\tau) \left(x_1(\tau) + \frac{b(\tau)}{2a(\tau)} \right)^2 d\tau \leq x_1(t_0) + \int_{t_0}^t \frac{b^2(\tau) - 4a(\tau)c(\tau)}{4a(\tau)} d\tau, \quad t \geq t_0.$$

From here using Cauchy - Schwarz inequality by analogy of (2.54) we get:

$$\begin{aligned} \int_{t_0}^t a(\tau)x_0(\tau)d\tau &\leq -\frac{1}{2} \int_{t_0}^t b(\tau)d\tau + \\ &+ \frac{1}{2}\sqrt{\int_{t_0}^t a(\tau)d\tau \left[4x_1(t_0) + \int_{t_0}^t \frac{b^2(\tau) - 4a(\tau)c(\tau)}{a(\tau)} d\tau \right]} d\tau, \quad t \geq t_0. \end{aligned} \quad (2.58)$$

§3. The behavior of solutions of the system (1.1)

3.1. The general case. Denote $B(t) \equiv a_{11}(t) - a_{22}(t)$, $t \geq t_0$. Consider the Riccati equation

$$z' + a_{12}(t)z^2 + B(t)z - a_{21}(t) = 0, \quad t \geq t_0. \quad (3.1)$$

It is not difficult to show that the solutions $z(t)$ of this equation existing on some interval $e [t_1; t_2)$ ($t_0 \leq t_1 \leq t_2 \leq +\infty$) are connected with solutions $(\phi(t), \psi(t))$ of the system (1.1) by correlations (see [6])

$$\phi(t) = \phi(t_1) \exp \left\{ \int_{t_1}^t [a_{12}(\tau)z(\tau) + a_{11}(\tau)] d\tau \right\}, \quad \phi(t_1) \neq 0. \quad \psi(t) = z(t)\phi(t), \quad (3.2)$$

$t \in [t_1; t_2)$. Denote by $z_0(t)$ the solution of Eq. (3.1) with $z_0(t_0) = i$. This solution exists on $[t_0; +\infty)$ (i. e. it is a t_0 -regular solution [see [6]]). Denote: $x_0(t) \equiv \text{Re } z_0(t)$, $y_0(t) \equiv \text{Im } z_0(t)$, $t \geq t_0$. Let $(\phi_{\pm}(t), \psi_{\pm}(t))$ be the solutions of the system (1.1) with $\phi_+(t_0) = 1$, $\psi_+(t_0) = 0$, $\phi_-(t_0) = 0$, $\psi_-(t_0) = 1$. Then the following equalities are valid (see [6]):

$$\begin{aligned} \phi_+(t) &= \frac{J_{S/2}(t)}{\sqrt{y_0(t)}} \cos \left(\int_{t_0}^t a_{12}(\tau)y_0(\tau) d\tau \right); \\ \psi_+(t) &= \frac{J_{S/2}(t)}{\sqrt{y_0(t)}} \left[x_0(t) \cos \left(\int_{t_0}^t a_{12}(\tau)y_0(\tau) d\tau \right) - y_0(t) \sin \left(\int_{t_0}^t a_{12}(\tau)y_0(\tau) d\tau \right) \right]; \\ \phi_-(t) &= \frac{J_{S/2}(t)}{\sqrt{y_0(t)}} \sin \left(\int_{t_0}^t a_{12}(\tau)y_0(\tau) d\tau \right); \\ \psi_-(t) &= \frac{J_{S/2}(t)}{\sqrt{y_0(t)}} \left[x_0(t) \sin \left(\int_{t_0}^t a_{12}(\tau)y_0(\tau) d\tau \right) + y_0(t) \cos \left(\int_{t_0}^t a_{12}(\tau)y_0(\tau) d\tau \right) \right], \end{aligned}$$

where $S \equiv a_{11}(t) + a_{22}(t)$, $t \geq t_0$. From here it is not difficult to obtain the relations

$$\phi_+(t) \cos \left(\int_{t_0}^t a_{12}(\tau)y_0(\tau) d\tau \right) + \phi_-(t) \sin \left(\int_{t_0}^t a_{12}(\tau)y_0(\tau) d\tau \right) = \frac{J_{S/2}(t)}{\sqrt{y_0(t)}}, \quad (3.3)$$

$$\psi_-(t) \cos \left(\int_{t_0}^t a_{12}(\tau)y_0(\tau) d\tau \right) - \psi_+(t) \sin \left(\int_{t_0}^t a_{12}(\tau)y_0(\tau) d\tau \right) = J_{S/2}(t) \sqrt{y_0(t)}, \quad (3.4)$$

$$\psi_-(t) \sin \left(\int_{t_0}^t a_{12}(\tau)y_0(\tau) d\tau \right) + \psi_+(t) \cos \left(\int_{t_0}^t a_{12}(\tau)y_0(\tau) d\tau \right) = J_{S/2}(t) \frac{x_0(t)}{\sqrt{y_0(t)}}, \quad (3.5)$$

The real valued solutions $(\phi(t), \psi(t))$ of the system (1.1) are connected with $x_0(t)$ and $y_0(t)$ by relations (see [6])

$$\begin{cases} \phi(t) = \mu \frac{J_{S/2}(t)}{\sqrt{y_0(t)}} \sin\left(\int_{t_0}^t a_{12}(\tau) y_0(\tau) d\tau + \nu\right); \\ \psi(t) = \mu \sqrt{x_0^2(t) + y_0^2(t)} \frac{J_{S/2}(t)}{\sqrt{y_0(t)}} \cos\left(\int_{t_0}^t a_{12}(\tau) y_0(\tau) d\tau + \nu - \alpha_0(t)\right), \end{cases} \quad (3.6)$$

$t \geq t_0$, where μ and ν are arbitrary constants;

$$\alpha_0(t) \equiv \arcsin \frac{x_0(t)}{\sqrt{x_0^2(t) + y_0^2(t)}} = \arctan \frac{x_0(t)}{y_0(t)}, \quad t \geq t_0. \quad (3.7)$$

Let $u(t)$ be a continuous function on $[t_0; +\infty)$.

Definition 3.1. The function $u(t)$ is called oscillatory if it has arbitrary large zeroes, otherwise $u(t)$ is called non oscillatory.

Definition 3.2. The system (1.1) is called oscillatory (non oscillatory), if for its each non trivial solution $(\phi(t), \psi(t))$ the functions $\phi(t)$ and $\psi(t)$ are oscillatory (non oscillatory).

Remark 3.1. Some oscillatory and non oscillatory criteria are proved in [6] (see also [5]).

Definition 3.3. The system (1.1) is called weak oscillatory (weak non oscillatory), if for its each non trivial solution $(\phi(t), \psi(t))$ at least one of the functions $\phi(t)$ and $\psi(t)$ is oscillatory (is non oscillatory) and there exist two solutions $(\phi_j(t), \psi_j(t))$, $j = 1, 2$, such that $\phi_1(t)$ and $\psi_1(t)$ are oscillatory (non oscillatory), and at least one of the functions $\phi_2(t)$ and $\psi_2(t)$ is non oscillatory (oscillatory).

Definition 3.4. The system (1.1) is called half oscillatory if for its each non trivial solution $(\phi(t), \psi(t))$ one of the functions $\phi(t)$, $\psi(t)$ is oscillatory and other is non oscillatory.

Definition 3.5. The system (1.1) is called singular, if it has two non trivial solutions $(\phi_j(t), \psi_j(t))$, $j = 1, 2$, such that $\phi_1(t)$ and $\psi_1(t)$ are oscillatory, and $\phi_2(t)$ and $\psi_2(t)$ are non oscillatory.

Remark 3.2. It is evident that each system (1.1) is or else oscillatory or else non oscillatory or else weak oscillatory or else weak non oscillatory or else half oscillatory or else singular.

Example 3.1. Consider the system

$$\begin{cases} \phi' = \cos(\lambda t)\psi; \\ \psi' = -\cos(\lambda t)\phi, \quad t \geq t_0 \end{cases} \quad (3.8)$$

where $\lambda = \text{const} > 0$ is a parameter. The general solution $(\phi(t), \psi(t))$ to this system is given by formulas:

$$\phi(t) = c_1 \sin\left(\frac{1}{\lambda} \sin \lambda t + c_2\right), \quad \psi(t) = c_1 \cos\left(\frac{1}{\lambda} \sin \lambda t + c_2\right),$$

where c_1 and c_2 are arbitrary constants. It is not difficult to verify that if:

- 1) $0 < \lambda \leq \frac{2}{\pi}$, then the system (3.8) is oscillatory;
- 2) $\frac{2}{\pi} < \lambda \leq \frac{4}{\pi}$, then the system (3.8) is weak oscillatory;
- 3) $\lambda > \frac{4}{\pi}$, then the system (3.8) is weak non oscillatory.

Example 3.2. Consider the system

$$\begin{cases} \phi' = & \psi; \\ \psi' = (-\cos^2 t - \sin t)\phi, & t \geq t_0. \end{cases} \quad (3.9)$$

The general solution $(\phi(t), \psi(t))$ of this system is given by formulas:

$$\phi(t) = e^{\sin t} \left(c_1 + c_2 \int_{t_0}^t e^{-2 \sin \tau} d\tau \right), \quad \psi(t) = e^{\sin t} \left[c_1 \cos t + c_2 \left\{ \cos t \int_{t_0}^t e^{-2 \sin \tau} d\tau + e^{-2 \sin t} \right\} \right].$$

where c_1 and c_2 are arbitrary constants. Obviously $\phi(t)$ is non oscillatory and $\psi(t)$ is oscillatory. Hence the system (3.9) is half oscillatory.

Example 3.3. Consider the system

$$\begin{cases} \phi' = 3 \cos t \phi - 2 \cos t \psi; \\ \psi' = 4 \cos t \phi - 3 \cos t \psi, & t \geq t_0. \end{cases} \quad (3.10)$$

It has the solutions

$$(e^{\sin t}, e^{\sin t}), \quad (e^{\sin t} - e^{-\sin t}, e^{\sin t} - 2e^{-\sin t}), \quad t \geq t_0.$$

Obviously the components of the first solution are non oscillatory; the first component of the second solution vanishes in the points $\pi k \geq t_0$, $k = 0, \pm 1, \pm 2, \dots$, and the nulls of the second component of the second solution are all solutions of the equation $\sin t = \ln \sqrt{2}$ on $[t_0; +\infty)$. Therefore the system (3.10) is singular.

Definition 3.6 The system (1.1) is called Lyapunov stable (asymptotically stable), if its all solutions are bounded on $[t_0; +\infty)$ (vanish on $+\infty$).

Theorem 3.1. *Let for each solution $(\phi(t), \psi(t))$ of the system (1.1) the function $J_{-S/2}(t)\phi(t)$ is bounded. Then there exists a solution $(\phi_0(t), \psi_0(t))$ of the system (1.1) such that $J_{-S/2}(t)\psi_0(t) \not\rightarrow 0$ for $t \rightarrow +\infty$. Moreover if in addition $a_{12}(t)$ does not change sign and $\int_{t_0}^{+\infty} |a_{12}(\tau)|d\tau = +\infty$, then the system (1.1) is oscillatory and for each nontrivial solution $(\phi(t), \psi(t))$ of the system (1.1) $J_{-S/2}(t)\psi(t) \not\rightarrow 0$ for $t \rightarrow +\infty$.*

Proof. By (3.3) from the conditions of the theorem it follows that

$$y_0(t) \geq \varepsilon, \quad t \geq t_0, \quad (3.11)$$

for some $\varepsilon > 0$. Suppose for every solution $(\phi(t), \psi(t))$ of the system (1.1) $J_{-S/2}(t)\psi(t) \rightarrow 0$ for $t \rightarrow +\infty$. Then according to (3.4) we have $y_0(t) \rightarrow 0$ for $t \rightarrow +\infty$, which contradicts (3.11). The obtained contradiction shows the existence of a solution $(\phi_0(t), \psi_0(t))$ of the system (2.1) with $J_{-S/2}(t)\psi_0(t) \not\rightarrow 0$ for $t \rightarrow +\infty$. If in addition $a_{12}(t)$ does not change sign and $\int_{t_0}^{+\infty} |a_{12}(\tau)|d\tau = +\infty$, then from (3.11) it follows that $|\int_{t_0}^{+\infty} a_{12}(\tau)y_0(\tau)d\tau| = +\infty$.

From here and from (3.6) it follows oscillation of the system (1.1). From the last equality from (3.6) and (3.11) it follows that for every solution $(\phi(t), \psi(t))$ for the system (1.1) the relation $J_{-S/2}(t)\psi(t) \not\rightarrow 0$ for $t \rightarrow +\infty$ is fulfilled. The theorem is proved.

Theorem 3.2. *Let for each solution $(\phi(t), \psi(t))$ of the system (1.1) the relation $J_{-S/2}(t)\phi(t) \rightarrow 0$ for $t \rightarrow +\infty$ be satisfied. Then there exists a solution $(\phi_0(t), \psi_0(t))$ of the system (1.1) such that $J_{-S/2}(t)\psi_0(t)$ is unbounded. Moreover if in addition $a_{12}(t)$ does not change sign and $\int_{t_0}^{+\infty} |a_{12}(\tau)|d\tau = +\infty$, then the system (1.1) is oscillatory, and for any nontrivial solution $(\phi(t), \psi(t))$ of the system (1.1) the function $J_{-S/2}(t)\psi(t)$ is unbounded.*

Proof. By (3.3) from the condition of the theorem it follows that

$$y_0(t) \rightarrow +\infty \text{ for } t \rightarrow +\infty. \quad (3.12)$$

Suppose for every solution $(\phi(t), \psi(t))$ of the system (1.1) the function $J_{-S/2}(t)\psi(t)$ is bounded. Then from (3.4) it follows that $y_0(t)$ is bounded, which contradicts (3.12). Hence for at least one solution $(\phi_0(t), \psi_0(t))$ of the system (1.1) the function $J_{-S/2}(t)\psi_0(t)$ is unbounded. Suppose $a_{12}(t)$ does not change sign and $\int_{t_0}^{+\infty} |a_{12}(\tau)|d\tau = +\infty$. Then from (3.6) and (3.12) it follows that the system (1.1) is oscillatory and by virtue of the second of equalities (3.6) from (3.12) it follows that for any nontrivial solution $(\phi(t), \psi(t))$ of the system (1.1) the function $J_{-S/2}(t)\psi(t)$ is unbounded. The theorem is proved.

Theorem 3.3 (abut rings). *Suppose for every solution $\Phi(t) \equiv (\phi(t), \psi(t))$ of the system (1.1) there exists $R_\Phi > 0$ such that $\|\Phi(t)\| \leq R_\Phi J_{S/2}(t)$, $t \geq t_0$. Then for every nontrivial solution $\Phi(t)$ of the system (1.1) there exists r_Φ such that*

$$\|\Phi(t)\| \geq r_\Phi J_{S/2}(t), \quad t \geq t_0. \quad (3.13)$$

Proof. By (3.3) - (3.5) from the conditions of the theorem it follows that

$$\sqrt{y_0(t)} \leq M, \quad \frac{1}{\sqrt{y_0(t)}} \leq M, \quad \frac{x_0(t)}{y_0(t)} \leq M, \quad t \geq t_0. \quad (3.14)$$

for some $M = \text{const} > 0$. Suppose for some solution $\Phi_0(t) \equiv (\phi_0(t), \psi_0(t))$ of the system (1.1) the relation (3.13) does not fulfill. Then there exists infinitely large sequence $\{t_n\}_{n=1}^{+\infty}$ such that

$$J_{-S/2}(t_n)\phi_0(t_n) \rightarrow 0, \quad J_{-S/2}(t_n)\psi_0(t_n) \rightarrow 0 \quad \text{for } n \rightarrow +\infty. \quad (3.15)$$

By (3.6) we have:

$$J_{-S/2}(t_n)\phi_0(t_n) = \frac{\mu_0}{\sqrt{y_0(t_n)}} \sin(\gamma_n);$$

$$J_{-S/2}(t_n)\psi_0(t_n) = \mu_0 \sqrt{1 + \frac{x_0(t_0)}{y_0(t_0)}} \sqrt{y_0(t_n)} \cos(\gamma_n - \alpha_0(t_n)),$$

where $\gamma_n \equiv \int_{t_0}^{t_n} y_0(\tau) d\tau + \nu_0$, $n = 1, 2, \dots$; ν_0 and μ_0 are some constants. From here from (3.14) and (3.15) it follows:

$$\sin(\gamma_n) \rightarrow 0, \quad \text{for } n \rightarrow +\infty; \quad (3.16)$$

$$\cos(\gamma_n - \alpha_0(t_n)) \rightarrow 0, \quad \text{for } n \rightarrow +\infty; \quad (3.17)$$

From (3.14) and from (3.7) it follows that there exists $\delta > 0$ such that $|\cos(\alpha_0(t_n))| > \delta$, $n = 1, 2, \dots$. From here and from (3.16) it follows that $|\cos(\gamma_n - \alpha_0(t_n))| = 1 \pm \pm \sqrt{1 - \sin^2 \gamma_n} \cos(\alpha_0(t_n)) + \sin \gamma_n \sin \alpha_0(t_n) \geq \delta/2$ for all enough large values of n , which contradicts (3.17). The obtained contradiction proves (3.13). The theorem is proved.

Remark 3.3. *The geometrical meaning of Theorem 3.4 is that if for all solutions $\Phi(t) \equiv (\phi(t), \psi(t))$ of the system (1.1) the vector functions $J_{-S/2}(t)\Phi(t)$ are bounded then every of them lies in some ring of radiuses $0 < r_\Phi < R_\Phi$.*

By correlation (1.3) between Eq. (1.2), Eq. (1.5) and the system (1.4) From Theorems 3.1 - 3.4 it follow the following

three principles for Eq. (1.5)

A) If all solutions of Eq. (1.5) are bounded then it is oscillatory and for its each nontrivial solution $\phi(t)$ the relation $\phi'(t) \not\rightarrow 0$ for $t \rightarrow +\infty$ is fulfilled.

B) If all solutions of Eq. (1.5) vanish on $+\infty$, then the derivative of its every nontrivial solution is unbounded.

C) If Eq. (1.5) is stable by Lyapunov then for its every nontrivial solution $\phi(t)$ there exist positive numbers $r_\phi < R_\phi$ such that $r_\phi \leq \sqrt{\phi^2(t) + \phi'(t)^2} \leq R_\phi$, $t \geq t_0$.

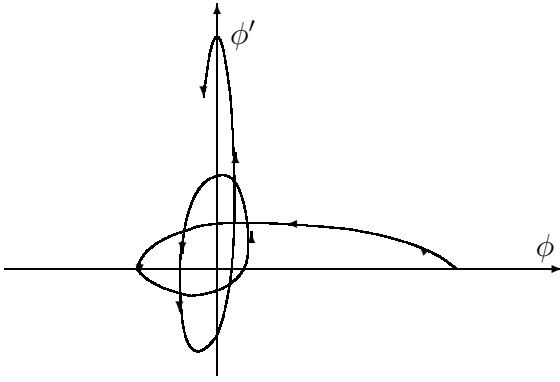

Pict.7. An illustration to the principle B)

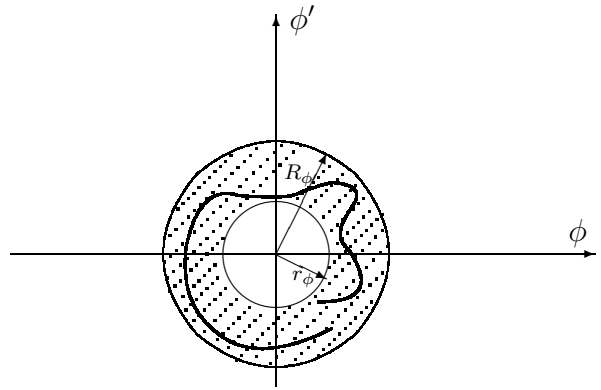

Pict.8. An illustration to the principle C)

Let us compare these principles with the following assertion proved in [1] (see [1], p. 222, Corollary 6.2.4).

Proposition 3.1. Let $|r(t)| \leq M$, $t \geq t_0$. Then if all solutions of Eq. (1.5) vanish on $+\infty$, then Eq. (1.5) is asymptotically stable.

Obviously from any of principles A) - C) it follows that the equations (1.5) satisfying the conditions of Proposition 3.1, form an empty set.

Example 3.4. Consider the Mathieu equation (see [14])

$$\phi'' + (\delta + \varepsilon \cos t)\phi = 0, \quad t \geq t_0, \quad \delta, \varepsilon \in R.$$

From the principle A) it follows that for all pairs (δ, ε) from the zones of stability this equation is oscillatory, and from the principle C) it follows that (for this restriction) for its each nontrivial solution $\phi(t)$ there exist $R_\phi > r_\phi > 0$ such that $r_\phi \leq \sqrt{\phi^2(t) + \phi'(t)^2} \leq R_\phi$, $t \geq t_0$ (see Pict. 8), which agrees quite well with the Floquet's theory. Note that some part of mentioned above zones of stability relates to the extremal case of Eq. (1.5), when

$$\int_{t_0}^{+\infty} r(t)dt = -\infty.$$

Example 3.5. Consider the Airy's equation

$$\phi'' + t\phi = 0, \quad t \geq t_0.$$

By virtue of L. A. Gusarov's theorem (see [15], Theorem 1) all solutions of this equation vanish on $+\infty$. From the principles A) and B) it follows that this equation is oscillatory and for its every nontrivial solution $\phi(t)$ the function $\phi'(t)$ is unbounded (see Pict. 7).

3.2. A generalization of Leighton's theorem. *In 1952 Leighton proves (see [16], p. 70, Theorem 2.24), that the equation*

$$(p(t)\phi')' + r(t)\phi = 0, \quad t \geq t_0,$$

is oscillatory if

$$\int_{t_0}^{+\infty} \frac{d\tau}{p(\tau)} = \int_{t_0}^{+\infty} r(\tau)d\tau = +\infty.$$

The next theorem generalizes this result.

Theorem 3.4. *Let the conditions*

1) $a_{12}(t) \geq 0, \quad t \geq t_0;$

2) $\int_{t_0}^{+\infty} a_{12}(\tau) \exp\left\{-\int_{t_0}^{\tau} B(s)ds\right\}d\tau = -\int_{t_0}^{+\infty} a_{21}(\tau) \exp\left\{\int_{t_0}^{\tau} B(s)ds\right\}d\tau = +\infty.$

be satisfied. Then the system (1.1) is oscillatory.

Proof. Suppose the system (1.1) is not oscillatory. Then from the condition 1) and from the Lemma 4.2 of work [6] it follows that Eq. (3.1) has a solution on $[t_1; +\infty)$ for some $t_1 \geq t_0$. Set $W(t) \equiv -a_{21}(t) \exp\left\{\int_{t_1}^t B(\tau)d\tau\right\}, \quad t \geq t_1$. In Eq. (3.1) make the substitution

$$y = z \exp\left\{-2 \int_{t_1}^t W(\tau)d\tau\right\}, \quad t \geq t_1.$$

We obtain

$$z' + U(t)z^2 + W(t) = 0, \quad t \geq t_1. \tag{3.18}$$

where $U(t) \equiv a_{12}(t) \exp\left\{-\int_{t_1}^t B(\tau)d\tau\right\}, \quad t \geq t_0$. Show that

$$\int_{t_1}^{+\infty} U(\tau) \exp\left\{\int_{t_1}^{\tau} U(s)ds \int_{t_1}^s W(\zeta)d\zeta\right\}d\tau = +\infty. \tag{3.19}$$

By 2) we have:

$$\int_{t_1}^t W(\tau) d\tau = - \int_{t_1}^t a_{21}(\tau) \exp \left\{ \int_{t_1}^{\tau} B(s) ds \right\} d\tau \geq 0, \quad t \geq t_2,$$

for some $t_2 \geq t_1$. By 2) from here it follows (3.19). In Eq. (3.18) make the substitution

$$z = u - \int_{t_1}^t W(\tau) d\tau, \quad t \geq t_1.$$

We get:

$$u' + U(t)u^2 - 2U(t) \int_{t_1}^t W(\tau) d\tau u + U(t) \left[\int_{t_1}^t W(\tau) d\tau \right]^2 = 0, \quad t \geq t_1. \quad (3.20)$$

Since Eq. (3.1) has a solution on $[t_1; +\infty)$, from the proven above substitutions is seen that Eq. (3.20) also has a solution on $[t_1; +\infty)$. By virtue of Lemma 2.4 from here, from (3.19) and from the inequalities $a_{12}(t) \geq 0$, $U(t) \left[\int_{t_1}^t W(\tau) d\tau \right]^2 \geq 0$, $t \geq t_1$, it follows that Eq. (3.20) has a positive solution on $[t_1; +\infty)$. Then $z_0(t) \equiv u_0(t) - \int_{t_1}^t W(\tau) d\tau$ is a solution to Eq. (3.18) such that

$$z_0(t) > \int_{t_1}^t W(\tau) d\tau, \quad t \geq t_1. \quad (3.21)$$

From (3.18) it follows that

$$z_0(t) = z_0(t_0) - \int_{t_1}^t U(\tau) z_0^2(\tau) d\tau - \int_{t_1}^t W(\tau) d\tau, \quad t \geq t_1. \quad (3.22)$$

From here and from (3.21) we have:

$$0 \leq \int_{t_1}^t U(\tau) z_0^2(\tau) d\tau < z_0(t_1), \quad t \geq t_1. \quad (3.23)$$

$(z_0(t_1) = u_0(t_1) > 0)$. Taking into account 2) from here we get:

$$\left[z_0(t_1) - \int_{t_1}^t U(\tau) z_0^2(\tau) d\tau - \int_{t_1}^t W(\tau) d\tau \right]^2 \geq 1, \quad t \geq T,$$

for some $T \geq t_1$. From here and from (3.22) it follows that $z_0^2(t) \geq 1$, $t \geq T$. Hence by 2) we have $\int_T^{+\infty} U(\tau) z_0^2(\tau) d\tau \geq \int_T^{+\infty} U(\tau) d\tau = +\infty$, which contradicts (3.23). The theorem is proved.

3.3. The case when the system (1.1) has a regular solution. In the sequel we will assume that the functions $a_{12}(t)$ and $a_{21}(t)$ have unbounded supports (the case when one of them has bounded support, is trivial).

Definition 3.7. A solution $(\phi(t), \psi(t))$ of the system (1.1) is called t_1 -regular if $\phi(t) \neq 0$, $t \geq t_1$.

Hereafter any t_1 -regular solution for any $t_1 \geq t_0$ we will just call a regular solution.

Definition 3.8. The system (1.1) is called regular if it has at least one regular solution.

Definition 3.9. The system (1.1) is called strongly regular if each its nontrivial solution is regular.

Definition 3.10. The system (1.1) is called exotic, if it has up to arbitrary multiplier the unique regular solution.

Definition 3.11. The regular system (1.1) is called normal if it is not exotic and for its any two regular solutions $(\phi_j(t), \psi_j(t))$, $j = 1, 2$, the function $\frac{\phi_1(t)}{\phi_2(t)}$ is bounded on $[T; +\infty)$, where $T = T(\phi_1, \phi_2)$ such that $\phi_j(t) \neq 0$, $t \geq T$, $j = 1, 2$.

Definition 3.12. The system (1.1) is called extremal if it is not exotic and has a regular solution $(\phi_*(t), \psi_*(t))$ such that for its any regular solution $(\phi(t), \psi(t))$, linearly independent of $(\phi_*(t), \psi_*(t))$ the equality $\lim_{t \rightarrow +\infty} \frac{\phi_*(t)}{\phi(t)} = 0$ is fulfilled.

The unique (up to arbitrary multiplier) solution $(\phi_*(t), \psi_*(t))$, defined above we will call the minimal solution of the system (1.1)

Remark 3.4. Every extremal system is strongly regular. Indeed Let $(\phi_*(t), \psi_*(t))$ be the minimal solution of the system (1.1) and let $(\phi_1(t), \psi_1(t))$ be another linearly independent regular solution of the system (1.1). Then for an arbitrary nontrivial solution $(\phi(t), \psi(t))$ the equality

$$\phi(t) = \phi_*(t) \left[c_1 + c_2 \frac{\phi_*(t)}{\phi_1(t)} \right], \quad t \geq t_1,$$

is fulfilled, where c_1 and c_2 are some constants, $c_1 \neq 0$, $t_1 \geq t_0$ such that $\phi_1(t) \neq 0$, $t \geq t_1$. Since $\lim_{t \rightarrow +\infty} \phi_*(t)/\phi_1(t) = 0$ from the last equality it follows that $\phi(t) \neq 0$, $t \geq t_2$ for some $t_2 \geq t_1$. Therefore the system (1.1) is strongly regular.

Definition 3.13. *The regular system (1.1) is called super extremal if it is neither exotic, nor normal nor extremal.*

From Theorem 2.2 and Remark 2.1 it follows that the system (1.1) having a regular solution is or else exotic or else normal or else extremal or else super extremal.

On the basis of (3.2) and relations (21) and (24) of work [11] it is easy to establish that: to exotic system (1.1) corresponds Eq. (3.1) with the unique regular solution; to normal system (1.1) corresponds Eq. (3.1), having only normal solution; to extremal system (1.1) corresponds Eq. (3.1), which has along with the normal solutions the unique extremal solution; to super extremal system (1.1) corresponds Eq. (3.1), which has along with the normal solutions two extremal solutions.

Let $(\phi_0(t), \psi_0(t))$ and $(\phi_(t), \psi_*(t))$ be solutions of the system (1.1) corresponding by formulae (3.2) to a normal and a extremal solutions respectively. Then by virtue of the relations (21) and (24) we have:*

$$\liminf_{t \rightarrow +\infty} \frac{|\phi_*(t)|}{|\phi_0(t)|} = 0, \quad \limsup_{t \rightarrow +\infty} \frac{|\phi_*(t)|}{|\phi_0(t)|} < +\infty.$$

For arbitrary continuous function $u(t)$ on $[t_0; +\infty)$ denote:

$$\begin{aligned} \tilde{\mu}_u(t_1; t) &\equiv \int_{t_1}^t a_{12}(\tau) \exp \left\{ - \int_{t_1}^{\tau} [2a_{12}(s)u(s) + B(s)] ds \right\} d\tau, \\ \tilde{\nu}_u(t) &\equiv \int_t^{+\infty} a_{12}(\tau) \exp \left\{ - \int_t^{\tau} [2a_{12}(s)u(s) + B(s)] ds \right\} d\tau, \quad t_1, t \geq t_0. \end{aligned}$$

Let the system (1.1) be exotic and let $x_0(t) \equiv \frac{\psi_0(t)}{\phi_0(t)}$, $t \geq t_1$, where $(\phi_0(t), \psi_0(t))$ is the unique (up to arbitrary multiplier) t_1 -regular solution of Eq. (3.1). Then (see [11]) $\limsup_{t \rightarrow +\infty} \tilde{\mu}_{x_0}(t_1; t) = +\infty$; $\liminf_{t \rightarrow +\infty} \tilde{\mu}_{x_0}(t_1; t) = -\infty$. By (3.2) from here it follows that

$$\limsup_{t \rightarrow +\infty} \int_{t_1}^t \frac{a_{12}(\tau) J_S(t_1; \tau)}{\phi_0^2(\tau)} d\tau = +\infty, \quad \liminf_{t \rightarrow +\infty} \int_{t_1}^t \frac{a_{12}(\tau) J_S(t_1; \tau)}{\phi_0^2(\tau)} d\tau = -\infty.$$

Let the system (1.1) be super extremal and let $(\phi_(t), \psi_*(t))$ and $(\phi_{**}(t), \psi_{**}(t))$ be solutions of the system (1.1), corresponding by formulae (3.2) to some extremal solutions of Eq. (3.1). Then by relation (24) of work [11] the equalities*

$$\liminf_{t \rightarrow +\infty} \frac{|\phi_*(t)|}{|\phi_{**}(t)|} = 0, \quad \limsup_{t \rightarrow +\infty} \frac{|\phi_*(t)|}{|\phi_{**}(t)|} = +\infty.$$

is fulfilled. As we see the exotic and normal systems are the most "poor" in the view of diversity of asymptotic behavior their regular solutions. In the same point of view the super extremal system is the most "rich".

Theorem 3.5. Let for some $t_1 \geq t_0$ there exists a real valued t_1 -regular solution $(\phi_0(t), \psi_0(t))$ of the system (1.1), such that the integral $\int_{t_1}^{+\infty} \frac{a_{12}(\tau)J_S(\tau)}{\phi_0^2(\tau)}d\tau$ is convergent

(conditionally) and $\int_t^{+\infty} \frac{a_{12}(\tau)J_S(\tau)}{\phi_0^2(\tau)}d\tau \neq 0$ for all $t \geq t_1$. Then:

a) the system (1.1) is extremal and for its minimal solution $(\phi_*(t), \psi_*(t))$ the equality

$$\int_{t_1}^{+\infty} \frac{a_{12}(\tau)J_S(\tau)}{\phi_*^2(\tau)}d\tau = \pm\infty, \quad (3.18)$$

is fulfilled;

b) for its each solution $(\phi(t), \psi(t))$ linearly independent of $(\phi_*(t), \psi_*(t))$ the integral $\int_T^{+\infty} \frac{a_{12}(\tau)J_S(\tau)}{\phi^2(\tau)}d\tau$ converges (conditionally) where $T = T(\phi; \psi) \geq t_0$ such that $\phi(t) \neq 0$,

$t \geq T$, and if in addition $a_{12}(t)$ does not change sign and $\int_{t_0}^{+\infty} |a_{12}(\tau)J_S(\tau)|d\tau = +\infty$, then

$$\limsup_{t \rightarrow +\infty} |\phi(t)| = +\infty; \quad (3.19)$$

c) for arbitrary real valued solutions $(\phi_j(t), \psi_j(t))$, $j = 1, 2$, of the system (1.1), linearly independent of $(\phi_*(t), \psi_*(t))$, there exists finite limit

$$\lim_{t \rightarrow +\infty} \frac{\phi_1(t)}{\phi_2(t)} (\neq 0). \quad (3.20)$$

Proof. $x_0(t) \equiv \frac{\psi_0(t)}{\phi_0(t)}$, $t \geq t_1$. By (3.2) we have: $\tilde{\nu}_{x_0}(t_1) = \int_{t_1}^{+\infty} \frac{a_{12}(\tau)J_S(\tau)}{\phi_0^2(\tau)}d\tau$. From here and from the conditions of the theorem it follows that the integral $\tilde{\nu}_{x_0}(t_1)$ converges and $\tilde{\nu}_{x_0}(t) \neq 0$, $t \geq t_1$. Then by virtue of Theorem 2.2 Eq. (3.1) has the unique t_1 -extremal solution $x_*(t)$. By (3.2) the functions

$$\phi_*(t) \equiv \exp \left\{ \int_{t_1}^t [a_{12}(\tau)x_*(\tau) + a_{11}(\tau)]d\tau \right\}, \quad \psi_*(t) \equiv x_*(t)\psi_*(t), \quad t \geq t_1,$$

define a real valued t_1 -regular solution $(\phi_*(t), \psi_*(t))$ of the system (1.1), which can be continued on $[t_0; +\infty)$ as a solution of Eq. (1.1). Then by (2.7) from the equality $\tilde{\nu}_{x_*}(t_1) = \int_{t_1}^{+\infty} \frac{a_{12}(\tau)J_S(\tau)}{\phi_*^2(\tau)} d\tau$ it follows (3.18). From (3.18) and from the conditions of the theorem it follows that $(\phi_0(t), \psi_0(t))$ and $(\phi_*(t), \psi_*(t))$ are linearly independent. Therefore for arbitrary solution $(\phi(t), \psi(t))$ of the system (1.1), linearly independent of $(\phi_*(t), \psi_*(t))$ the equality

$$\phi(t) = \phi_*(t) \left[c_0 + c_* \frac{\phi_*(t)}{\phi_0(t)} \right], \quad t \geq t_1, \quad (3.21)$$

is fulfilled, where c_0 and c_* are some constants and $c_0 \neq 0$. By virtue of Theorem 2.2 from the equality $\tilde{\nu}_{x_0}(t_1) = \int_{t_1}^{+\infty} \frac{a_{12}(\tau)J_S(\tau)}{\phi_0^2(\tau)} d\tau$ and from the conditions of the theorem it follows that $x_0(t)$ is a t_1 -normal solution of Eq. (3.2). Then according to (2.8) from the equality

$$\frac{\phi_*(t)}{\phi_0(t)} = \frac{\phi_*(t_1)}{\phi_0(t_1)} \exp \left\{ \int_{t_1}^t a_{12}(\tau) [x_0(\tau) - x_*(\tau)] d\tau \right\}, \quad t \geq t_1,$$

it follows that

$$\lim_{t \rightarrow +\infty} \frac{\phi_*(t)}{\phi_0(t)} = 0. \quad (3.22)$$

From here and from (3.21) it follows that $\phi(t) \neq 0$, $t \geq t_2$, for some $t_2 \geq t_1$. The assertion a) is proved. The assertion b) follows from Theorem 2.2 and from the equality $\tilde{\nu}_x(T) = \int_T^{+\infty} \frac{a_{12}(\tau)J_S(T;\tau)}{\phi^2(\tau)} d\tau$, where $x(t) \equiv \frac{\psi(t)}{\phi(t)}$ is a T -normal solution of Eq. (3.2), and the equality (3.19) immediately follows from the absolutely convergence of the integral $\int_T^{+\infty} \frac{a_{12}(\tau)J_S(T;\tau)}{\phi^2(\tau)} d\tau$ and from the equality

$$\int_{t_0}^{+\infty} |a_{12}(\tau)J_S(T;\tau)| d\tau = J_{-S}(T) \int_{t_0}^{+\infty} |a_{12}(\tau)J_S(\tau)| d\tau.$$

Let us prove c). Set $x_j(t) \equiv \frac{\psi_j(t)}{\phi_j(t)}$, $t \geq T$, $j = 1, 2$, where $T \geq t_0$ such that $\phi_j(t) \neq 0$, $t \geq T$, $j = 1, 2$. Since $(\phi_j(t), \psi_j(t))$, $j = 1, 2$, are linearly independent of $(\phi_*(t), \psi_*(t))$, on the strength of (3.2) and Theorem 2.2 the functions $x_j(t)$ are T -normal solutions of Eq.

(3.1), and

$$\frac{\phi_1(t)}{\phi_2(t)} = \frac{\phi_1(T)}{\phi_2(T)} \exp \left\{ \int_T^t a_{12}(\tau) [x_1(\tau) - x_2(\tau)] d\tau \right\}, \quad t \geq T.$$

By (2.9) from here it follows (3.20). The theorem is proved.

Remark 3.5. Theorem 3.5 is a generalization and supplement of the assertions (i) and (ii) of Theorem 6.4 from the book [17] (see [17], p. 355, Theorem 6.4)

Denote by $\text{reg}(t_1)$ the set of initial values $x_{(0)} \in R$, for which the solution $x(t)$ of Eq. (3.1) with $x(t_1) = x_{(0)}$ is t_1 -regular. If $a_{12}(t) \geq 0$ (≤ 0), $t \geq t_0$, and Eq. (3.1) has a real valued t_1 -regular solution then $\text{reg}(t_1) = [x_*(t); +\infty)$ ($\text{reg}(t_1) = (-\infty; x_*(t)]$), where $x_*(t)$ is the unique t_1 -extremal solution to Eq. (3.1) (see [11]).

Corollary 3.1. If $a_{12}(t)$ does not change sign, then the system (1.1) is or else oscillatory or else regular. In the last case the assertions of Theorem 3.5 are valid, and if:

A) $I_{|a_{12}|, -S}^+(t_0) = +\infty$, then the system (1.1) has a solution $(\phi_0(t), \psi_0(t))$ such that $\limsup_{t \rightarrow +\infty} |\phi_0(t)| = +\infty$;

B) $I_{|a_{12}|, -S}^+(t_0) < +\infty$, then the system (1.1) has a solution $(\phi_*(t), \psi_*(t))$ such that $\liminf_{t \rightarrow +\infty} |\phi_*(t)| = 0$.

Proof. If $a_{12}(t)$ does not change sign then or else $\int_{t_0}^{+\infty} |a_{12}(\tau)| y_0(\tau) d\tau = +\infty$ or else

$\int_{t_0}^{+\infty} |a_{12}(\tau)| y_0(\tau) d\tau < +\infty$. By (3.6) in the first case the system (1.1) is oscillatory. In the second case the system (1.1), and therefore Eq. (3.1) have t_1 -regular solutions for some $t_1 \geq t_0$. Then $\text{reg}(t_1) = [x_*(t_1); +\infty)$ or $\text{reg}(t_1) = (-\infty; x_*(t_1)]$, where $x_*(t)$ is the unique t_1 -extremal solution of Eq. (3.1). From here it follows that Eq. (3.1) has a t_1 -normal solution $x_0(t)$. Then by virtue of Theorem 2.2 the integral $\tilde{v}_{x_0}(t_1)$ converges and since $a_{12}(t)$ does not change sign and has unbounded support we have

$$\tilde{v}_{x_0}(t) \neq 0, \quad t \geq t_1. \quad (3.23)$$

By (3.2) we have $\tilde{v}_{x_0}(t) = \int_t^{+\infty} \frac{a_{12}(\tau) J_S(t; \tau)}{\phi_0^2(\tau)} d\tau$, $t \geq t_1$, where $\phi_0(t) \equiv \exp \left\{ \int_{t_1}^t [a_{12}(\tau) x_0(\tau) + a_{11}] d\tau \right\}$,

$\psi_0(t) \equiv x_0(t) \phi_0(t)$, $t \geq t_1$, form the t_1 -regular solution $(\phi_0(t), \psi_0(t))$ of the system (1.1) on $[t_1; +\infty)$, which can be continued on $[t_0; +\infty)$ as a solution of the system (1.1). From

here and from (3.23) it follows that all conditions of Theorem 3.5 are fulfilled. Therefore all assertions of Theorem 3.5 are valid. Suppose $I_{|a_{12}|, -S}^+(t_0; +\infty) = +\infty$. Show that for the solution $(\phi_0(t), \psi_0(t))$ the component $\phi_0(t)$ is unbounded. Suppose that $|\phi_0(t)| \leq M$, $t \geq t_0$. Then by (3.2) we have $|\tilde{\nu}_{x_0}(t_1)| = \int_{t_1}^{+\infty} \frac{|a_{12}(\tau)|J_s(t_1; \tau)}{\phi_0^2(\tau)} d\tau \geq \frac{1}{M^2} \int_{t_1}^{+\infty} |a_{12}(\tau)|J_s(t_1; \tau) d\tau = +\infty$. But on the other hand since $x_0(t)$ is t_1 -normal we have $|\tilde{\nu}_{x_0}(t_1)| < +\infty$. We came to the contradiction. The assertion A) is proved. Let us prove B). Set

$$\phi_*(t) \equiv \exp \left\{ \int_{t_1}^t [a_{12}(\tau)x_*(\tau) + a_{11}(\tau)] d\tau \right\}, \quad \psi_*(t) \equiv x_*(t)\phi_*(t), \quad t \geq t_1,$$

By (3.2) $(\phi_*(t), \psi_*(t))$ is a solution of the system (1.1) on $[t_1; +\infty)$, which can be continued on $[t_0; +\infty)$ as a solution of the system (1.1). Show that $\liminf_{t \rightarrow +\infty} |\phi_*(t)| = 0$. Suppose that it is not true. Then $|\phi_*(t)| \geq \varepsilon > 0$, $t \geq T_0$, for some $T_0 \geq t_0$. Hence by (3.2) from the condition $I_{|a_{12}|, -S}^+(t_0) < +\infty$ it follows that $|\tilde{\nu}_{x_*}(t_1)| = \int_{t_1}^{+\infty} \frac{|a_{12}(\tau)|J_s(t_1; \tau)}{\phi_*^2(\tau)} d\tau \leq \frac{1}{\varepsilon^2} \int_{t_1}^{+\infty} |a_{12}(\tau)|J_s(t_1; \tau) d\tau < +\infty$. But on the other hand since $x_*(t)$ is t_1 -extremal and $a_{12}(t)$ does not change sign, we have $\tilde{\nu}_{x_*}(t_1) = \pm\infty$. We came to the contradiction. Therefore $\liminf_{t \rightarrow +\infty} |\phi_*(t)| = 0$. The corollary is proved.

Corollary 3.2 Let for some $t_1 \geq t_0$ there exists a t_1 -regular solution $(\phi_*(t), \psi_*(t))$ of the system (1.1) such that $\int_{t_1}^{+\infty} \frac{a_{12}(\tau)J_s(\tau)}{\phi_*^2(\tau)} d\tau = \pm\infty$. Then the assertions of Theorem 3.5 are valid.

Proof. Set $x_*(t) \equiv \frac{\psi_*(t)}{\phi_*(t)}$, $t \geq t_1$. Obviously $x_*(t)$ is a t_1 -regular solution of Eq. (3.1).

On the basis of (3.2) it is easy to show that $\tilde{\nu}_{x_*}(t_1) = \int_{t_1}^{+\infty} \frac{a_{12}(\tau)J_s(\tau)}{\phi_*^2(\tau)} d\tau$. From here and from the condition of corollary it follows that $\tilde{\nu}_{x_*}(t_1) = \pm\infty$. On the basis of Corollary 2.1 from this relation we obtain that Eq. (3.1) has the unique t_1 -extremal solution (which coincides with $x_*(t)$). Then by virtue of Theorem 2.2 Eq. (3.1) has a t_1 -normal solution $x_0(t)$ such that the integral $\tilde{\nu}_{x_0}(t)$ converges for all $t \geq t_1$ and $\tilde{\nu}_{x_0}(t) \neq 0$, $t \geq t_1$. Set

$$\phi_0(t) \equiv \exp \left\{ \int_{t_1}^t [a_{12}(\tau)x_0(\tau) + a_{11}(\tau)] d\tau \right\}, \quad \psi_0(t) \equiv x_0(t)\phi_0(t), \quad t \geq t_1.$$

By (3.2) $(\phi_0(t), \psi_0(t))$ is a solution of the system (1.1) on $[t_1; +\infty)$, which can be continued on $[t_0; +\infty)$ as a solution of the system (1.1) By (3.2) we have $\int_t^{+\infty} \frac{a_{12}(\tau)J_S(\tau)}{\phi_0^2(\tau)} d\tau = \tilde{v}_{x_0}(t) \neq 0$, $t \geq t_1$. Therefore for the solution $(\phi_0(t), \psi_0(t))$ of the system (1.1) all conditions of Theorem 3.5 are fulfilled. The corollary is proved.

Theorem 3.6. Let $a_j(t)$ and $c_j(t)$ be continuously differentiable functions on $[t_0; +\infty)$ such that $(-1)^j a_j(t) > 0$, $(-1)^j c_j(t) > 0$, $t \geq t_0$, $j = 1, 3$, and let $a_1(t) \leq a_{12}(t) \leq a_2(t)$, $c_1(t) \leq -a_{21}(t) \leq c_2(t)$, $B(t) \geq \frac{1}{2} \left(\frac{a'_j(t)}{a_j(t)} - \frac{c'_j(t)}{c_j(t)} \right) + 2(-1)^j \sqrt{a_j(t)c_j(t)}$, $t \geq t_0$, $j = 1, 2$.

Then every solution $(\phi(t), \psi(t))$ of the system (1.1) with $\frac{\psi(t_0)}{\phi(t_0)} \in \left[-\sqrt{\frac{c_2(t)}{a_2(t)}}; \sqrt{\frac{c_1(t)}{a_1(t)}} \right]$ is t_0 -regular and

$$-\sqrt{\frac{c_2(t)}{a_2(t)}} \leq \frac{\psi(t)}{\phi(t)} \leq \sqrt{\frac{c_1(t)}{a_1(t)}}, \quad t \geq t_0. \quad (3.24)$$

If $\frac{\psi(t_0)}{\phi(t_0)} \in \left(-\sqrt{\frac{c_2(t)}{a_2(t)}}; \sqrt{\frac{c_1(t)}{a_1(t)}} \right)$, then the function $I_\phi(t) \equiv \int_{t_0}^t \frac{a_{12}(\tau)J_S(t_0;\tau)}{\phi_0^2(\tau)} d\tau$, $t \geq t_0$, is bounded.

Proof. By virtue of Theorem 4.2 of work [11] if the conditions of the theorem are fulfilled then every solution $x(t)$ of Eq. (3.1) with $x(t_0) \in \left[-\sqrt{\frac{c_2(t)}{a_2(t)}}; \sqrt{\frac{c_1(t)}{a_1(t)}} \right]$ is t_0 -regular and $-\sqrt{\frac{c_2(t)}{a_2(t)}} \leq x(t) \leq \sqrt{\frac{c_1(t)}{a_1(t)}}$, $t \geq t_0$. By (3.2) from here it follows that every solution $(\phi(t), \psi(t))$ of the system (1.1) with $\frac{\psi(t_0)}{\phi(t_0)} \in \left[-\sqrt{\frac{c_2(t)}{a_2(t)}}; \sqrt{\frac{c_1(t)}{a_1(t)}} \right]$ is t_0 -regular and the relation (3.24) is fulfilled. If $\frac{\psi(t_0)}{\phi(t_0)} \in \left(-\sqrt{\frac{c_2(t)}{a_2(t)}}; \sqrt{\frac{c_1(t)}{a_1(t)}} \right)$, then $x(t) \equiv \frac{\psi(t)}{\phi(t)}$, $t \geq t_0$ is t_0 -normal. Hence (see [10]) $\tilde{\mu}_x(t_0; t)$ is bounded. Therefore since by (3.2) $\tilde{\mu}_x(t_0; t) = I_\phi(t)$, $t \geq t_0$, the function $I_\phi(t)$, $t \geq t_0$ is bounded. The theorem is proved.

Example 3.6. Consider the system of equations

$$\begin{cases} \phi' = t^2 \phi + t \sin t \psi; \\ \psi' = t^3 \cos t \phi - t^2 \psi, \quad t \geq 1. \end{cases} \quad (3.25)$$

Any solution $(\phi(t), \psi(t))$ of this system with $\left| \frac{\psi(t_0)}{\phi(t_0)} \right| \leq 1$ is 1-regular and

$$\left| \frac{\psi(t)}{\phi(t)} \right| \leq t, \quad t \geq 1. \quad (3.26)$$

If $\left| \frac{\psi(t_0)}{\phi(t_0)} \right| < 1$, then the function $I_\phi(t) \equiv \int_1^t \frac{\tau \sin \tau}{\phi^2(\tau)}$, $t \geq 1$, is bounded. To prove this fact we should take $a_j(t) \equiv (-1)^j t$, $c_j(t) \equiv (-1)^j t^3$, $t \geq 1$, $j = 1, 2$, and apply Theorem 3.6. From the first equation of the system (3.25) and from (3.26) it is seen that for every solution $(\phi(t), \psi(t))$ of the system (3.25) with $\left| \frac{\psi(t_0)}{\phi(t_0)} \right| \leq 1$ the function $|\phi(t)|$ is monotonically nondecreasing.

3.4. The case when $a_{12}(t)$ and $a_{21}(t)$ do not change their signs. In this section we will study the behavior of the system (1.1) in two cases: I. $a_{12}(t) \geq 0$, $a_{21}(t) \geq 0$, $t \geq t_0$; II. $a_{12}(t) \geq 0$, $a_{21}(t) \leq 0$, $t \geq t_0$. The cases III. $a_{12}(t) \leq 0$, $a_{21}(t) \leq 0$, $t \geq t_0$; IV. $a_{12}(t) \leq 0$, $a_{21}(t) \geq 0$, $t \geq t_0$ can be reduced to I and II by simple transformation $\phi \rightarrow -\phi$ in the system (1.1) In (1.1) make the substitutions

$$\begin{cases} \phi = J_{a_{11}}(t)\rho \sin \theta; \\ \psi = J_{a_{22}}(t)\rho \cos \theta. \end{cases} \quad (3.27)$$

We get:

$$\begin{cases} \rho' \sin \theta + \theta' \rho \cos \theta = A_{21}(t)\rho \cos \theta; \\ \rho' \cos \theta - \theta' \rho \sin \theta = A_{12}(t)\rho \sin \theta, \end{cases} \quad (3.28)$$

where $A_{21}(t) \equiv J_{-B}(t)a_{21}(t)$, $A_{12}(t) \equiv J_B(t)a_{12}(t)$, $t \geq t_0$. Multiplying the first equation of the last system on $\sin \theta$, and the second one on $\cos \theta$ and summarizing we obtain the equation

$$\rho' = [A_{12}(t) + A_{21}(t)]\rho \sin \theta \cos \theta, \quad t \geq t_0. \quad (3.29)$$

Now multiplying the first equation of the system (3.28) on $\cos \theta$, and the second one on $\sin \theta$ and subtracting from the first obtained the second one we get:

$$\theta' \rho = \rho[A_{21}(t) \cos^2 \theta - A_{12}(t) \sin^2 \theta], \quad t \geq t_0. \quad (3.30)$$

The system (3.28) (or the system of equations (3.29) and (3.30)) is equivalent to the system (1.1) in the sense that to any real valued nontrivial solution $(\phi(t), \psi(t))$ of the system (1.1) corresponds the solution $(\rho(t), \theta(t))$ of the system (3.26) with $\rho(t) > 0$, $t \geq t_0$, defined by formulae (3.25), or by formulae:

$$\rho(t) = \sqrt{J_{-2a_{11}}(t)\phi^2(t) + J_{-2a_{22}}(t)\psi^2(t)}, \quad \theta(t) = \begin{cases} \arctan \frac{\phi(t)}{\psi(t)} J_{-B}(t), & \psi(t) \neq 0; \\ \arctan \frac{\psi(t)}{\phi(t)} J_B(t), & \phi(t) \neq 0, \end{cases}$$

(to null solution $(0, 0)$ of the system (1.1) corresponds the solution $(0, 0)$ of the system (3.28)). Due to uniqueness theorem if $\rho(t_0) > 0$, then

$$\rho(t) > 0, \quad t \geq t_0. \quad (3.31)$$

Then Eq. (3.30) can be replaced by

$$\theta' = A_{21}(t) \cos^2 \theta - A_{12}(t) \sin^2 \theta, \quad t \geq t_0. \quad (3.32)$$

Definition 3.14. We will say that a continuous function $u(t)$ on $[t_1; +\infty)$ ($t_1 \geq t_0$) vanishes no more than one time on $[t_1; +\infty)$, if it has no nulls on $[t_1; +\infty)$, or the set of its nulls on $[t_1; +\infty)$ is a segment $[a; b]$ which can be degenerated in a single point.

Definition 3.15. We will say that the system (1.1) satisfies the non conjugation condition on $[t_1; +\infty)$ ($t_1 \geq t_0$), if for its each nontrivial solution $(\phi(t), \psi(t))$ the functions $\phi(t)$ and $\psi(t)$ vanish on $[t_1; +\infty)$ no more than one time.

3.4.1. The case when $a_{12}(t) \geq 0$, $a_{21}(t) \geq 0$, $t \geq t_0$. In this subsection we will study the behavior of solutions of the system (1.1) under the restrictions $a_{12}(t) \geq 0$, $a_{21}(t) \geq 0$, $t \geq t_0$.

Theorem 3.7. If $a_{12}(t) \geq 0$, $a_{21}(t) \geq 0$, $t \geq t_0$, then the system (1.1) satisfies the non conjugation condition on $[t_0; +\infty)$.

Proof. Consider the following family of solutions of the system (1.1) $\Omega(t) \equiv \{(\phi(t), \psi(t)) : \phi(t_0) = 1\}$. By virtue of Theorem 2.3. I^o Eq. (3.1) has the unique t_0 -extremal solution $x_*(t)$. Let $(\phi(t), \psi(t)) \in \Omega$. If $\psi(t_0) \geq x_*(t_0)$, then by (3.2) and Lemma 2.1 the function $x(t) \equiv \frac{\psi(t)}{\phi(t)}$ is a t_0 -regular solution of Eq. (3.1). Therefore if $\psi(t_0) > 0$, then $\psi(t) > 0$, $t \geq t_0$ (since $\phi(t) > 0$, $t \geq t_0$); if $\psi(t_0) = 0$, then there exists $t_1 \geq t_0$ such that $\psi(t) = 0$, $t \in [t_0; t_1]$ and $\psi(t) > 0$, $t > t_1$. Suppose $I_{a_{12}, B}^+(t_0) = +\infty$ or $I_{a_{21}, -B}^+(t_0) = +\infty$. Then by virtue of Theorem 2.3. III^o if $\psi(t_0) \in (x_*(t_0); 0)$, then there exists $t_2 \geq t_1 > t_0$ such that $\psi(t) < 0$, $t \in [t_0; t_1)$, $\psi(t) = 0$, $t \in [t_1; t_2)$, $\psi(t) > 0$, $t > t_2$. If $\psi(t_0) = x_*(t_0)$, then by virtue of Theorem 2.3. III^o and (3.2) we have $\psi(t) < 0$, $t \geq t_0$. From here it follows that $u_*(t) \equiv \frac{\phi(t)}{\psi(t)}$, $t \geq t_0$, is a t_0 -regular solution of the equation

$$u' + a_{21}(t)u^2 - B(t)u - a_{21}(t) = 0, \quad t \geq t_0. \quad (3.33)$$

By Lemma 2.1 from here it follows that for $\psi(t_0) < x_*(t_0)$ the function $u(t) = \frac{\phi(t)}{\psi(t)}$ is a t_0 -regular solution of the last equation. Hence for $\psi(t_0) < 0$ we have $\psi(t) < 0$, $t \geq t_0$. Suppose $I_{a_{12}, B}^+(t_0) < +\infty$, $I_{a_{21}, -B}^+(t_0) < +\infty$. Then by virtue of Theorem 2.3. IV^o Eq. (3.1) has a negative t_0 -normal solution. By analogy of previous it shows that for $(\phi(t), \psi(t)) \in \Omega$; for $\psi(t_0) > 0$, $\psi(t) > 0$, $t \geq t_0$; for $\psi(t_0) = 0$ there exists $t_1 \geq t_0$ such that $\psi(t) = 0$, $t \in [t_0; t_1]$, $\psi(t) > 0$, $t > t_1$; for $\psi(t_0) \in (x_N^-(t_0); 0)$ there exists

$t_2 \geq t_1 > t_0$ such that $\psi(t) < 0$, $t \in [t_0; t_1)$, $\psi(t) = 0$, $t \in [t_1; t_2]$, $\psi(t) > 0$, $t > t_2$; for $\psi(t_0) \leq x_N^-(t_0)$ the inequality $\psi(t) < 0$, $t \geq t_0$ is fulfilled. So we have shown that for $(\phi(t), \psi(t)) \in \Omega$ the function $\psi(t)$ vanishes on $[t_0; +\infty)$ no more than one time. From here it follows that for arbitrary real valued solution $(\phi(t), \psi(t))$ of the system (1.1) with $\phi(t_0) \neq 0$ the function $\psi(t)$ vanishes on $[t_0; +\infty)$ no more than one time. Let $(\phi_0(t), \psi_0(t))$ be a nontrivial solution of the system (1.1) with $\phi_0(t_0) = 0$. Then there exists $t_2 > t_1 \geq t_0$ such that $\phi_0(t) = 0$, $t \in [t_0; t_1]$ and $\phi_0(t) \neq 0$, $t \in (t_1; t_2)$. Indeed if $\phi_0(t) \equiv 0$ on $[t_0; +\infty)$, then $u_0(t) \equiv 0$ is a solution of Eq. (3.33), which is impossible. By uniqueness theorem we have $\psi_0(t) \neq 0$, $t \in [t_0; t_3]$, for some $t_3 \in (t_1, t_2)$. Then by already proven the function $\psi_0(t)$ vanishes on $[t_3; +\infty)$ no more than one time. Therefore $\psi_0(t)$ vanishes on $[t_0; +\infty)$ no more than one time. We have proved that for each real valued solution $(\phi(t), \psi(t))$ of the system (1.1) the function $\psi(t)$ vanishes on $[t_0; +\infty)$ no more than one time. Replacing the system (1.1) by its transpose from here we conclude that for each real valued solution $(\phi(t), \psi(t))$ of the system (1.1) the function $\phi(t)$ vanishes on $[t_0; +\infty)$ no more than one time. The theorem is proved.

Let us compare Theorem 3.7 with the following result of Vale - Pussen (see [18], p. 122; [1], p. 212).

Proposition 3.2. *If in the considering interval $[t_1; t_2]$ $p(t) \equiv 1$, $|q(t)| \leq M_1$ and $|r(t)| \leq M_2$, then in the considering interval $[t_1; t_2]$ the distance h between any two successive nulls of each solution of Eq. (1.2) satisfies:*

for $M_2 > 0$ the inequality

$$h \geq \frac{\sqrt{9M_1^2 + 24M_2} - 3M_1}{2M_2},$$

and for $M_2 = 0$ the inequality

$$h \geq \frac{2}{M_2}.$$

By virtue of Theorem 3.7 for $r(t) \equiv 0$ the system (1.4) satisfies of non conjugation condition. B (1.3) from here it follows that for $r(t) \equiv 0$ every solution of Eq. (1.2) has no more than one null on $[t_0; +\infty)$. Therefore all equations (1.2), satisfying the conditions of Proposition 3.2 and having for $M_2 = 0$ two successive nulls on $[t_1; t_2]$, form a empty set.

Theorem 3.8. *Suppose $a_{12}(t) \geq 0$, $a_{21}(t) \geq 0$, $t \geq t_0$ Then if:*

$A_2) I_{a_{12}, B}^+(t_0) = +\infty$ or $I_{a_{21}, -B}^+(t_0) = +\infty$

then there exists up to arbitrary multiplier the unique solution $(\phi_*(t), \psi_*(t))$ of the system (1.1) such that $\phi_*(t) > 0$, $\psi_*(t) < 0$, $t \geq t_0$; for any solution $(\phi(t), \psi(t))$ of the system (1.1), linearly independent of $(\phi_*(t), \psi_*(t))$ the equalities

$$\lim_{t \rightarrow +\infty} \frac{\phi_*(t)}{\phi(t)} = \lim_{t \rightarrow +\infty} \frac{\psi_*(t)}{\psi(t)} = 0, \quad (3.34)$$

are fulfilled and

$$\int_{t_0}^{+\infty} \frac{a_{12}(\tau)J_S(\tau)}{\phi_*^2(\tau)}d\tau = \int_{t_0}^{+\infty} \frac{a_{21}(\tau)J_S(\tau)}{\psi_*^2(\tau)}d\tau = +\infty, \quad (3.35)$$

$$\int_T^{+\infty} \frac{a_{12}(\tau)J_S(\tau)}{\phi^2(\tau)}d\tau < +\infty, \quad \int_T^{+\infty} \frac{a_{21}(\tau)J_S(\tau)}{\psi^2(\tau)}d\tau < +\infty, \quad (3.36)$$

where $T = T(\phi; \psi) \geq t_0$ such that $\phi(t) \neq 0$, $\psi(t) \neq 0$, $t \geq T$, and a_1) if $I_{a_{12},B}^+(t_0) = +\infty$ ($I_{a_{21},-B}^+(t_0) = +\infty$), then

$$\int_{t_0}^{+\infty} a_{12}(\tau) \frac{\phi_*(\tau)}{\psi_*(\tau)}d\tau = -\infty, \quad \int_T^{+\infty} a_{12}(\tau) \frac{\psi(\tau)}{\phi(\tau)}d\tau = +\infty \quad (3.37)$$

$$\left(\int_{t_0}^{+\infty} a_{21}(\tau) \frac{\psi_*(\tau)}{\phi_*(\tau)}d\tau = -\infty, \quad \int_T^{+\infty} a_{21}(\tau) \frac{\phi(\tau)}{\psi(\tau)}d\tau = +\infty \right); \quad (3.38)$$

b_1) if $I_{a_{12},B}^+(t_0) = +\infty$, $\int_{t_0}^{+\infty} a_{21}(\tau)I_{-B,a_{12}}^-(t_0; \tau)d\tau < +\infty$
 $(I_{a_{21},-B}^+(t_0) = +\infty, \int_{t_0}^{+\infty} a_{12}(\tau)I_{B,a_{21}}^-(t_0; \tau)d\tau < +\infty)$, then

$$\int_{t_0}^{+\infty} a_{12}(\tau) \left| \frac{\psi_*(\tau)}{\phi_*(\tau)} \right| d\tau < +\infty, \quad \int_{t_0}^{+\infty} a_{21}(\tau) \frac{\phi_*(\tau)}{\psi_*(\tau)}d\tau = -\infty \quad (3.39)$$

$$\left(\int_{t_0}^{+\infty} a_{21}(\tau) \left| \frac{\phi_*(\tau)}{\psi_*(\tau)} \right| d\tau < +\infty, \quad \int_{t_0}^{+\infty} a_{12}(\tau) \frac{\psi_*(\tau)}{\phi_*(\tau)}d\tau = -\infty \right) \quad (3.40)$$

B_2) $I_{a_{12},B}(t_0; +\infty) < +\infty$, $I_{a_{21},-B}(t_0; +\infty) < +\infty$ then there exist up to arbitrary multiplier the unique linearly independent solutions $(\phi_{**}(t), \psi_0(t))$, $(\phi_0(t), \psi_{**}(t))$ of the system (1.1) such that $\phi_{**}(t) > 0$, $\psi_{**}(t) > 0$, $t \geq t_0$; for each solution $(\phi(t), \psi(t))$ of the system (1.1), linearly independent of $(\phi_{**}(t), \psi_0(t))$ (of $(\phi_0(t), \psi_{**}(t))$) the equality

$$\lim_{t \rightarrow +\infty} \frac{\phi_{**}(t)}{\phi(t)} = 0 \quad \left(\lim_{t \rightarrow +\infty} \frac{\psi_{**}(t)}{\psi(t)} = 0 \right), \quad (3.41)$$

is fulfilled and

$$\int_{t_0}^{+\infty} \frac{a_{12}(\tau)J_S(\tau)}{\phi_{**}^2(\tau)}d\tau = \int_{t_0}^{+\infty} \frac{a_{21}(\tau)J_S(\tau)}{\psi_{**}^2(\tau)}d\tau = +\infty \quad (3.42)$$

$$\int_T^{+\infty} \frac{a_{12}(\tau)J_S(\tau)}{\phi^2(\tau)}d\tau < +\infty \quad \left(\int_T^{+\infty} \frac{a_{21}(\tau)J_S(\tau)}{\psi^2(\tau)}d\tau < +\infty \right), \quad (3.43)$$

where $T = T(\phi; \psi) \geq t_0$ such that $\phi(t) \neq 0$, $\psi(t) \neq 0$, $t \geq T$.

Proof. Let $x_*(t)$ be the t_0 -extremal solution of Eq. (3.1). Let us prove A_2). Above it was proved (in proving of Theorem 3.7), that for fulfillment of the conditions A_2) the function $u_*(t) \equiv \frac{1}{x_*(t)}$ is the t_0 -extremal solution of Eq. (3.33). By (3.2) the functions

$$\phi_*(t) \equiv \exp \left\{ \int_{t_0}^t [a_{12}(\tau)x_*(\tau) + a_{11}(\tau)]d\tau \right\}, \quad \psi_*(t) \equiv x_*(t)\phi_*(t), \quad t \geq t_0,$$

form the solution $(\phi_*(t), \psi_*(t))$ of the system (1.1). Let $x_0(t)$ be a solution of Eq. (3.1) with $x_0(t_0) > x_*(t_0)$. By Lemma 2.1 $x_0(t)$ is t_0 -normal. Then by virtue of Theorem 2.2 the integral $\tilde{v}_{x_0}(t_0)$ converges. Obviously $\tilde{v}_{x_0}(t) > 0$, $t \geq t_0$ (since $a_{12}(t) \geq 0$, $t \geq t_0$ and has unbounded support). By (3.2) the functions

$$\tilde{\phi}_0(t) \equiv u_*(t)\tilde{\psi}_*(t), \quad \tilde{\psi}_*(t) \equiv \exp \left\{ \int_{t_0}^t [a_{21}(\tau)u_*(\tau) + a_{22}(\tau)]d\tau \right\}$$

form the solution $(\tilde{\phi}_*(t), \tilde{\psi}_*(t))$ of the system (1.1). Since $u_*(t) = \frac{1}{x_*(t)}$, we have $\det \begin{pmatrix} \phi_*(t) & \psi_*(t) \\ \tilde{\phi}_*(t) & \tilde{\psi}_*(t) \end{pmatrix} = 0$. Then $(\phi_*(t), \psi_*(t))$ and $(\tilde{\phi}_*(t), \tilde{\psi}_*(t))$ are linearly independent. Let $u_0(t)$ be a solution of Eq. (3.33) with $u_0(t_0) > u_*(t_0)$. By Lemma 2.1 $u_0(t)$ is t_0 -normal. Then by virtue of Theorem 2.2 the integral

$$\tilde{v}_{u_0}(t) \equiv \int_t^{+\infty} a_{21}(\tau) \exp \left\{ - \int_t^\tau [2a_{21}(\xi)u_0(\xi) - B(\xi)]d\xi \right\} d\tau$$

converges for all $t \geq t_0$ and $\tilde{v}_{u_0}(t) > 0$, $t \geq t_0$. Then the assertion A_2) immediately follows from the linearly independence of solutions $(\phi_*(t), \psi_*(t))$ and $(\tilde{\phi}_*(t), \tilde{\psi}_*(t))$ and

from Theorem 3.5 (as a up to arbitrary multiplier solution of Eq. (1.1), appearing in the formulation of A_2) one can take $(\phi_*(t), \psi_*(t))$). Let us prove B_2). By virtue of Theorem 2.3. VI^P Eq. (3.1) has a t_0 -normal negative solution $x_N^-(t)$ such that every solution $x(t)$ of Rq. (3.1) with $0 \geq x(t_0) > x_N^-(t_0)$ vanishes on $(t_0; +\infty)$. From here it follows that $u_*(t) \equiv \frac{1}{x_N^+ t}$, $t \geq t_0$, is the t_0 -extremal solution to Eq. (3.33). By (3.2) the functions

$$\phi_{**}(t) \equiv \exp \left\{ \int_{t_0}^t [a_{12}(\tau)x_*(\tau) + a_{11}(\tau)] d\tau \right\}, \quad \psi_0(t) \equiv x_*(t)\phi_{**}(t),$$

$$\phi_0(t) \equiv u_*(t)\psi_{**}(t), \quad \psi_{**}(t) \equiv \exp \left\{ \int_{t_0}^t [a_{21}(\tau)u_*(\tau) + a_{22}(\tau)] d\tau \right\} \quad t \geq t_0,$$

form the solutions $(\phi_{**}(t), \psi_0(t))$ and $(\phi_0(t), \psi_{**}(t))$ of the system (1.1). Since $\det \begin{pmatrix} \phi_{**}(t_0) & \psi_0(t_0) \\ \tilde{\phi}_0(t_0) & \tilde{\psi}_{**}(t_0) \end{pmatrix} = 1 - x_*(t_0)u_*(t_0) = 1 - \frac{x_*(t_0)}{x_N^+(t_0)} \neq 0$, the solutions $(\phi_{**}(t), \psi_0(t))$ and $(\phi_0(t), \psi_{**}(t))$ are linearly independent. Let $x_0(t)$ be a solution of Eq. (3.1) with $x_0(t_0) > x_*(t_0)$. According to Lemma 2.1 $x_0(t)$ is t_0 -normal. Then by virtue of Theorem 2.3 the integral $\tilde{v}_{x_0}(t)$ converges for all $t \geq t_0$ and $\tilde{v}_{x_0}(t) > 0$, $t \geq t_0$. By analogy if $u_0(t)$ is a solution of Eq. (3.33) with $u_0(t_0) > u_*(t_0)$, then

$\tilde{v}_{u_0}(t) \equiv \int_t^{+\infty} a_{21}(\tau) \exp \left\{ - \int_t^\tau [2a_{21}(\xi)u_0(\xi) - B(\xi)] d\xi \right\} d\tau$ for all $t \geq t_0$ and $\tilde{v}_{u_0}(t) \geq 0$, $t \geq t_0$. From here From Theorem 3.5 and from linearly independence of solutions $(\phi_{**}(t), \psi_0(t))$ and $(\phi_0(t), \psi_{**}(t))$ it follows B_2). The theorem is proved.

On the basis of Theorems 2.3 and 3.5 and the first of formulae (3.2) one can make the phase portrait of the family of curves $\Phi(t) \equiv J_{a_{11}}(t)\phi(t)$, where $(\phi(t), \psi(t))$ runs the family Ω in the case when $a_{12}(t) \geq 0$, $a_{21}(t) \geq 0$, $t \geq t_0$ (see pict. 9 and pict. 10)

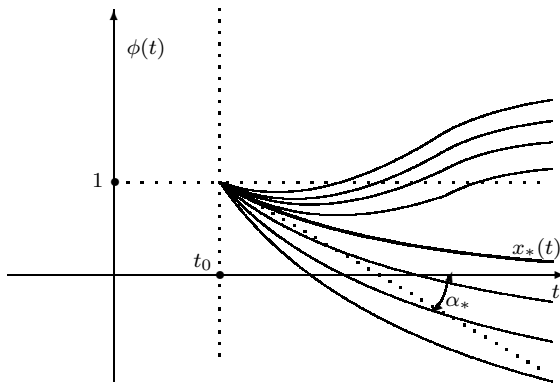

45

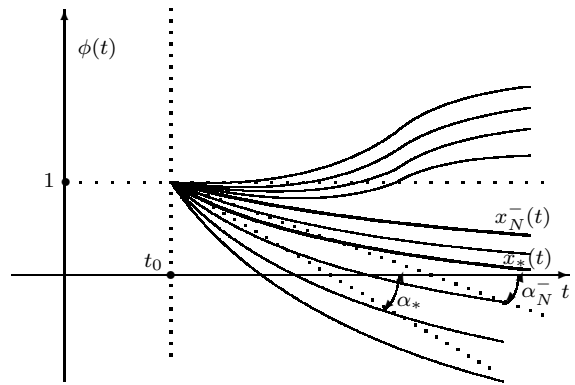

Pict.9. $\alpha_* = \arctan x_*(t_0)$
 $I_{a_{12}, B}^+(t_0) = +\infty$ or $I_{a_{21}, -B}^+(t_0) = +\infty$

Pict.10. $\alpha_* = \arctan x_*(t_0)$, $\alpha_N^- = \arctan x_N^-(t_0)$
 $I_{a_{12}, B}^+(t_0) < +\infty$ and $I_{a_{21}, -B}^+(t_0) < +\infty$

By analogy it can be make the phase portrait for the family of curves $\Psi(t) \equiv J_{a_{22}}(t)\psi(t)$, where $(\phi(t), \psi(t))$ runs the family of solutions of the system (1.1) with $\psi(t_0) = 1$.

Let $(\phi(t), \psi(t)) \in \Omega$. If the curve $(\phi(t), \psi(t))$ is in the first or the third quadrant of phase plane $\Phi \equiv J_{-a_{11}}(t)\phi$, $\Psi \equiv J_{-a_{11}}(t)\psi$, then from (3.39) it follows that the function $\rho(t) \equiv \sqrt{J_{-2a_{11}}(t)\phi^2(t) + J_{-2a_{22}}(t)\psi^2(t)}$ monotonically non decreases, and if $(\phi(t), \psi(t))$ belongs to the second or the fourth quadrant of phase plane $\Phi \equiv J_{-a_{11}}(t)\phi$, $\Psi \equiv J_{-a_{11}}(t)\psi$, then $\rho(t)$ monotonically non increases. Then taking into account Theorem 3.7 one can make the phase portrait of the family of the curves $\tilde{\Omega} \equiv \{(J_{-a_{11}}(t)\phi(t), J_{-a_{11}}(t)\psi(t)), (\phi(t), \psi(t)) \in \Omega\}$ for the case $a_{12}(t) \geq 0$, $a_{21}(t) \geq 0$, $t \geq t_0$ (see pict.'s 11 - 14, where

$$\Phi_*(t) \equiv \exp\left\{\int_{t_0}^t a_{12}(\tau)x_*(\tau)d\tau\right\}, \quad \Psi_*(t) \equiv x_*(t)J_{a_{11}}(t)\Phi_*(t).$$

If $I_{a_{12},B}^+(t_0) = +\infty$ and $I_{a_{21},-B}^+(t_0) = +\infty$, then by virtue of Theorem .3.V^o we have $\Phi_*(t) \rightarrow 0$, $\Psi_*(t) \rightarrow 0$ for $t \rightarrow +\infty$ (see pict. 11). If $I_{a_{12},B}^+(t_0) = +\infty$, $\int_{t_0}^{+\infty} a_{21}(\tau)I_{-B,a_{12}}^-(t_0;\tau)d\tau < +\infty$, then by virtue of Theorem 2.3. VI^P we have $\Phi_*(t) \rightarrow \gamma_* > 0$, $\Psi_*(t) \rightarrow 0$ for $t \rightarrow +\infty$ (see pict. 12).

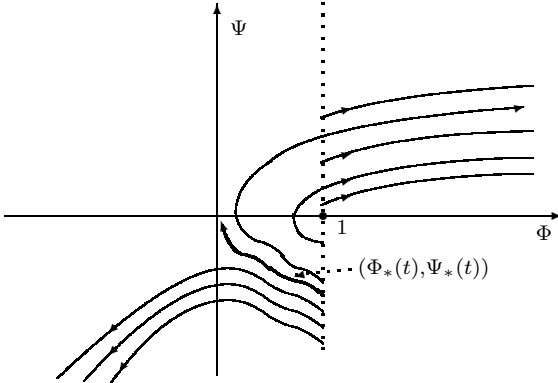

Pict.11. $I_{a_{12},B}^+(t_0)=I_{a_{21},-B}^+(t_0)=+\infty$

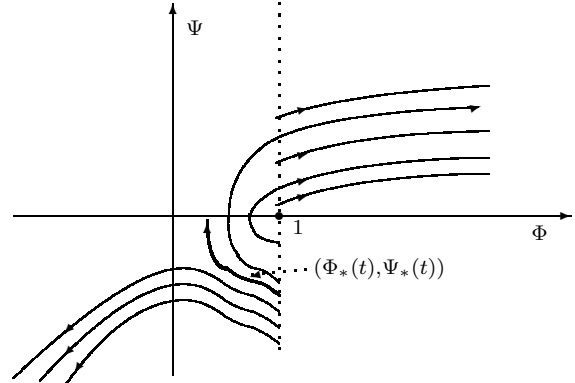

Pict.12. $I_{a_{12},B}^+(t_0)=+\infty, \int_{t_0}^{+\infty} a_{21}(\tau)I_{-B,a_{12}}^-(t_0;\tau)d\tau < +\infty$.

if $I_{a_{21},-B}^+(t_0) = +\infty$ and $\int_{t_0}^{+\infty} a_{12}(\tau)I_{B,a_{21}}^-(t_0;\tau)d\tau < +\infty$, then by virtue of Theorem 2.3. VI^P we have $\Phi_*(t) \rightarrow 0$, $\Psi_*(t) \rightarrow \gamma_* < 0$ for $t \rightarrow +\infty$ (see pict. 13). If $I_{a_{12},B}(t_0) < +\infty$ and $I_{a_{21},-B}(t_0) < +\infty$, then by virtue of Theorem 2.3. VI^P we have $\Phi_{**}(t) \rightarrow 0$, $\Psi_{**}(t) \rightarrow 0$ for $t \rightarrow +\infty$, where $\Phi_{**}(t) \equiv J_{-a_{11}}(t)\phi_{**}(t)$, $\Psi_{**}(t) \equiv J_{-a_{22}}(t)\psi_{**}(t)$, $(\phi_{**}(t), \psi_0(t))$ and $(\phi_0(t), \psi_{**}(t))$ are defined in the formulation of

Theorem 3.8. B_2) as up to arbitrary multiplier the unique solutions of the system (1.1) (see pict. 14).

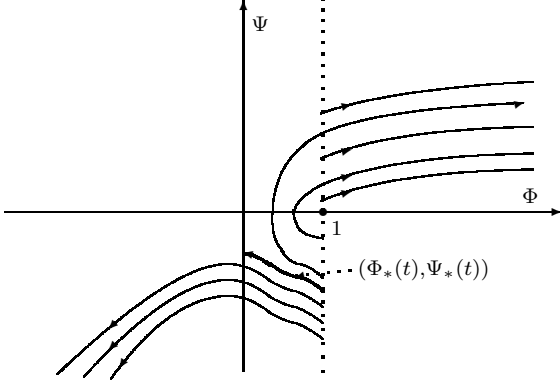

Pict.13.

$$I_{a_{21}, -B}^+(t_0) = +\infty, \int_{t_0}^{+\infty} a_{12}(\tau) I_{B, a_{21}}^-(t_0; \tau) d\tau < +\infty.$$

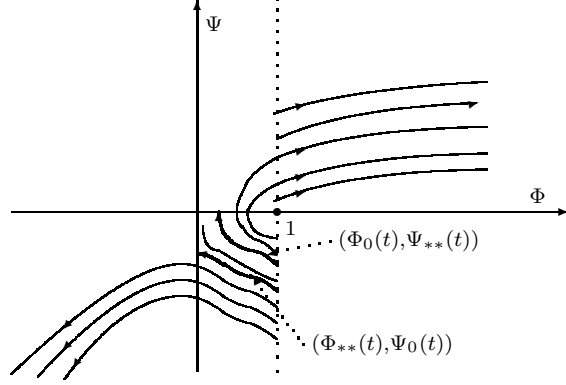

Pict.14. $I_{a_{12}, B}^+(t_0) < +\infty, I_{a_{21}, -B}^+(t_0) < +\infty$

Suppose $(\phi(t), \psi(t)) \in \Omega$. Then by virtue of Theorem 2.3.P if $\psi(t_0) \geq \frac{-1}{I_{a_{12}, B}^+(t_0)}$ then $(\phi(t), \psi(t))$ is t_0 -regular and

$$\frac{\psi(t_0) J_{-B}(t)}{1 + \psi(t_0) I_{a_{12}, B}^+(t_0; t)} \leq \frac{\psi(t)}{\phi(t)} \leq \psi(t_0) J_{-B}(t) + I_{B, a_{21}}^-(t_0; t), \quad t \geq t_0.$$

Let us multiply all parts of this inequality on $a_{12}(t)$, add $a_{11}(t)$, integrate from t_0 to t and take the exponential. We obtain:

$$\begin{aligned} J_{a_{11}}(t) \left[1 + \psi(t_0) I_{a_{12}, B}^+(t_0; t) \right] &\leq \phi(t) \leq \\ &\leq \exp \left\{ \psi(t_0) I_{a_{12}, B}^+(t_0; t) + \int_{t_0}^t [a_{11}(\tau) + a_{12}(\tau) I_{B, a_{21}}^-(t_0; \tau)] d\tau \right\}, \quad t \geq t_0. \end{aligned} \quad (3.44)$$

Passing to the transpose of the system (1.1) from here for the solution $(\phi(t), \psi(t))$ of the system (1.1) with $\phi(t_0) \geq \frac{-1}{I_{a_{21}, -B}^+(t_0)}$, $\psi(t_0) = 1$ we get the estimates

$$\begin{aligned} J_{a_{22}}(t) \left[1 + \phi(t_0) I_{a_{21}, -B}^+(t_0; t) \right] &\leq \psi(t) \leq \\ &\leq \exp \left\{ \phi(t_0) I_{a_{21}, -B}^+(t_0; t) + \int_{t_0}^t [a_{22}(\tau) + a_{21}(\tau) I_{-B, a_{12}}^-(t_0; \tau)] d\tau \right\}, \quad t \geq t_0. \end{aligned} \quad (3.45)$$

From here and from (3.34) we immediately have

Theorem 3.9. *The system (1.1) with $a_{12}(t) \geq 0$, $a_{21}(t) \geq 0$, $t \geq t_0$, is Lyapunov stable if and only if the functions $J_{a_{11}}(t)I_{a_{12},B}^+(t_0;t)$, $J_{a_{22}}(t)I_{a_{21},-B}^+(t_0;t)$ are bounded on $[t_0; +\infty)$.*

Example 3.7. Consider the system

$$\begin{cases} \phi' = \sin^2 t \psi; \\ \psi' = \cos^2 t \phi, \quad t \geq t_0. \end{cases} \quad (3.46)$$

for this system we have $a_{12}(t) = \sin^2(t) \geq 0$, $a_{21}(t) = \cos^2(t) \geq 0$, $J_{a_{11}}(t)I_{a_{12},B}^+(t_0;t) = \int_{t_0}^t \sin^2(\tau) d\tau$, $t \geq t_0$. Since $\int_{t_0}^t \sin^2(\tau) d\tau$ is unbounded by Theorem 3.9 the system (3.46) is not Lyapunov stable. It is not difficult to verify that the application of Theorem 4.6.2 of Wazewski and mentioned above estimates of Lyapunov and Yu. S. Bogdanov to the system (3.46) gives no result.

Let $(\phi_0(t), \psi_0(t))$ and $(\phi_1(t), \psi_1(t))$ be the solutions of the system (1.1) with $\phi_0(t_0) = \psi_1(t_0) = 1$, $\psi_0(t_0) = \phi_1(t_0) = 0$. Then from (3.44) and (3.45) we obtain:

$$\phi_0(t) \leq \exp \left\{ \int_{t_0}^t [a_{11}(\tau) + a_{12}(\tau) I_{B,a_{21}}^-(t_0;\tau)] d\tau \right\},$$

$$\psi_0(t) \leq \exp \left\{ \int_{t_0}^t [a_{22}(\tau) + a_{21}(\tau) I_{-B,a_{12}}^-(t_0;\tau)] d\tau \right\}, \quad t \geq t_0.$$

By (2.9) and (3.2) from here for the solution $(\phi(t), \psi(t))$ of the system (1.1) with $\phi(t_0) > 0$, $\psi(t_0) > 0$ we get the estimates

$$0 < \phi(t) \leq \phi(t_0) c_1 \exp \left\{ \int_{t_0}^t [a_{11}(\tau) + a_{12}(\tau) I_{B,a_{21}}^-(t_0;\tau)] d\tau \right\}, \quad (3.47)$$

$$0 < \psi(t) \leq \psi(t_0) c_2 \exp \left\{ \int_{t_0}^t [a_{22}(\tau) + a_{21}(\tau) I_{-B,a_{12}}^-(t_0;\tau)] d\tau \right\}, \quad t \geq t_0, \quad (3.48)$$

where

$$c_1 \equiv \exp \left\{ \int_{t_0}^{+\infty} a_{12}(\tau) \left(\frac{\psi(\tau)}{\phi(\tau)} - \frac{\psi_0(\tau)}{\phi_0(\tau)} \right) d\tau \right\}, \quad c_2 \equiv \exp \left\{ \int_{t_0}^{+\infty} a_{21}(\tau) \left(\frac{\phi(\tau)}{\psi(\tau)} - \frac{\phi_1(\tau)}{\psi_1(\tau)} \right) d\tau \right\}.$$

Remark 3.6. For $I_{a_{12},B}^+(t_0) = +\infty$ (for $I_{a_{21},-B}^+(t_0) = +\infty$) the estimate (3.47) (the estimate (3.48)) is sharper than the estimate from above from (3.44) (from (3.45)).

Using the estimates (3.47) and (3.48) for the two particular linearly independent solution $(\phi_j(t), \psi_j(t))$, $j = 1, 2$ with $\phi_j(t_0) > 0$, $\psi_j(t_0) > 0$, $j = 1, 2$ it is easy to get the following estimates for arbitrary solution $(\phi(t), \psi(t))$ of the system (1.1) for the case $a_{12}(t) \geq 0$, $a_{21}(t) \geq 0$, $t \geq t_0$:

$$|\phi(t)| \leq C_1(\phi; \psi) \exp \left\{ \int_{t_0}^t [a_{11}(\tau) + a_{12}(\tau) I_{B, a_{21}}^-(t_0; \tau)] d\tau \right\}, \quad (3.49)$$

$$|\psi(t)| \leq C_2(\phi; \psi) \exp \left\{ \int_{t_0}^t [a_{22}(\tau) + a_{21}(\tau) I_{-B, a_{12}}^-(t_0; \tau)] d\tau \right\}, \quad t \geq t_0, \quad (3.50)$$

where $C_j(\phi; \psi)$, $j = 1, 2$ are some constants depending on $(\phi(t), \psi(t))$.

Example 3.8. Consider the system

$$\begin{cases} \phi' = \lambda t^\alpha \phi + \mu t^\beta \psi; \\ \psi' = \nu t^\gamma \phi + \lambda t^\alpha \psi, \quad t \geq t_0 > 0, \end{cases} \quad (3.51)$$

where $\lambda \in R$, $\mu > 0$, $\nu > 0$, $\alpha > -1$, $\beta > -1$, $\gamma < -1$ are some constants and $\beta \geq \alpha$, $\beta + \gamma + 2 > 0$. By (3.49) and (3.50) for an arbitrary solution $(\phi(t), \psi(t))$ of the system (1.1) the estimates

$$|\phi(t)| \leq C_1 \exp \left\{ \frac{\lambda}{\alpha + 1} t^{\alpha+1} + \frac{\mu \nu t_0^{\gamma+1}}{(\beta + 1)|\gamma + 1|} t^{\beta+1} \right\}, \quad (3.52)$$

$$|\psi(t)| \leq C_2 \exp \left\{ \frac{\lambda}{\alpha + 1} t^{\alpha+1} + \frac{\mu \nu}{(\beta + 1)(\beta + \gamma + 2)} t^{\beta+\gamma+2} \right\}, \quad t \geq t_0. \quad (3.53)$$

are valid. The estimate of Wazevski (Theorem 4.6.2) for this system is the following:

$$\sqrt{\phi^2(t) + \psi^2(t)} \leq M \exp \left\{ \frac{\lambda}{\alpha + 1} t^{\alpha+1} + \frac{\mu}{2(\beta + 1)} t^{\beta+1} \right\}, \quad t \geq t_0, \quad (3.54)$$

where $M = \text{const} > 0$. Let us also write for the solution $(\phi(t), \psi(t))$ of the system (3.51) the estimates of Lyapunov [1], p. 132), Yu. S. Bogdanov ([1], p. 133, Theorem 4.61) and

S. M. Lozinski ([1], pp. 135 - 137, Theorem 4.6.3). These estimates are:

$$\sqrt{\phi^2(t) + \psi^2(t)} \leq M_1 \exp \left\{ \int_{t_0}^t \left[\max \left(\sqrt{\lambda^2 \tau^{2\alpha} + \nu^2 \tau^{2\gamma}}, \sqrt{\lambda^2 \tau^{2\alpha} + \mu^2 \tau^{2\beta}} \right) \right] d\tau \right\}, \quad (3.55)$$

$$\sqrt{\phi^2(t) + \psi^2(t)} \leq M_2 \exp \left\{ \frac{2|\lambda|}{\alpha+1} t^{\alpha+1} + \frac{\mu}{\beta+1} t^{\beta+1} \right\}, \quad (3.56)$$

$$\sqrt{\phi^2(t) + \psi^2(t)} \leq M_3 \exp \left\{ \lambda t^{\alpha+1} + \frac{\mu}{\beta+1} t^{\beta+1} \right\}, \quad t \geq t_0. \quad (3.57)$$

Obviously among the estimates (3.54) - (3.57) the most sharp is the estimate of Wazewski (3.54). For $\beta + \gamma + 1 > \alpha$ the estimate (3.53) is sharper than (3.54), and if $\beta + \gamma + 1 = \alpha$, then the estimate (3.53) will be sharper of estimate (3.54), provided $\nu < \frac{\alpha+1}{2}$. For $\beta \geq \alpha$ and $t_0^{\gamma+1} < \frac{\gamma+1}{2\nu}$ the estimate (3.52) is sharper than (3.54). In particular for $\alpha = \beta$, $\lambda < 0$ on the basis (3.52) and (3.53) we conclude (taking $t_0 > 0$ enough large), that the system (3.51) is asymptotically stable, meanwhile under these restrictions and for $\mu + 2\lambda > 0$ by using (3.54) even impossible establish the Lyapunov stability of the system (3.51). Note that for $\alpha > 1$ or $\beta > 1$ the estimate by freezing method (see [1], p. 141, Theorem 4.6.4) is not applicable to the system (3.51).

Let $a_{12}(t) > 0$, $t \geq t_0$, and let $(\phi_0(t), \psi_0(t))$ be a solution of the system (1.1) with $\phi_0(t_0) = 1$, $\psi_0(t_0) = 0$. Then by (3.2) we have

$$\phi_0(t) = \exp \left\{ \int_{t_0}^t \left[a_{11}(\tau) + a_{12}(\tau)x_0(\tau) \right] d\tau \right\}, \quad t \geq t_0,$$

where $x_0(t)$ is a solution of Eq. (3.1) with $x_0(t_0) = 0$. On the strength of (2.48) from here it follows

$$0 < \phi_0(t) \leq \exp \left\{ \frac{1}{2} \int_{t_0}^t S(\tau) d\tau + \frac{1}{2} \sqrt{ \int_{t_0}^t a_{12}(\tau) d\tau \int_{t_0}^t \frac{B^2(\tau) + 4a_{12}(\tau)a_{21}(\tau)}{a_{12}(\tau)} d\tau } \right\}, \quad (3.58)$$

$t \geq t_0$. Let $(\phi_1(t), \psi_1(t))$ be the solution of the system (1.1) with $\phi_1(t_0) = 1$, $\psi_1(t_0) = 1$. Then by (3.2) we have:

$$\phi_1(t) = \exp \left\{ \int_{t_0}^t \left[a_{11}(\tau) + a_{12}(\tau)x_1(\tau) \right] d\tau \right\}, \quad t \geq t_0, \quad (3.59)$$

where $x_1(t)$ is a solution of Eq. (3.2) with $x_1(t_0) = 1$. Since by virtue of Lemma 2.1 and Theorem 2.3.II^o the solutions $x_0(t)$ and $x_1(t)$ are t_0 -normal, taking into account (2.9) from (3.55) and (3.56) we get:

$$0 < \phi_1(t) \leq N \exp \left\{ \frac{1}{2} \int_{t_0}^t S(\tau) d\tau + \frac{1}{2} \sqrt{ \int_{t_0}^t a_{12}(\tau) d\tau \int_{t_0}^t \frac{B^2(\tau) + 4a_{12}(\tau)a_{21}(\tau)}{a_{12}(\tau)} d\tau } \right\}, \quad (3.60)$$

$t \geq t_0$ where $N \equiv \exp \left\{ \int_{t_0}^{+\infty} a_{12}(\tau) (x_1(\tau) - x_0(\tau)) d\tau \right\} < +\infty$. Let $(\phi(t), \psi(t))$ be an arbitrary solution of the system (1.1). Then since obviously $(\phi_0(t), \psi_0(t))$ and $(\phi_1(t), \psi_1(t))$ are linearly independent from the equality $\phi(t) = \nu_0 \phi_0(t) + \nu_1 \phi_1(t)$, $t \geq t_0$, where ν_0 and ν_1 are some constants, and from (3.58) and (3.60) we have:

$$|\phi(t)| \leq M \exp \left\{ \frac{1}{2} \int_{t_0}^t S(\tau) d\tau + \frac{1}{2} \sqrt{ \int_{t_0}^t a_{12}(\tau) d\tau \int_{t_0}^t \frac{B^2(\tau) + 4a_{12}(\tau)a_{21}(\tau)}{a_{12}(\tau)} d\tau } \right\}, \quad (3.61)$$

$t \geq t_0$, where $M = \text{const} > 0$. By analogy if $a_{21}(t) > 0$, $t \geq t_0$, then

$$|\psi(t)| \leq M_1 \exp \left\{ \frac{1}{2} \int_{t_0}^t S(\tau) d\tau + \frac{1}{2} \sqrt{ \int_{t_0}^t a_{12}(\tau) d\tau \int_{t_0}^t \frac{B^2(\tau) + 4a_{12}(\tau)a_{21}(\tau)}{a_{21}(\tau)} d\tau } \right\}, \quad (3.62)$$

$t \geq t_0$, where $M_1 = \text{const} > 0$. For the system (3.51) the estimates (3.61) and (3.62) give:

$$|\phi(t)| \leq m \exp \left\{ \frac{\lambda t^{\alpha+1}}{\alpha+1} + \sqrt{ \frac{\lambda \mu t^{\beta+1} t_0^{\gamma+1}}{(\beta+1)|\gamma+1|} } \right\}, \quad (3.63)$$

$$|\psi(t)| \leq m_1 \exp \left\{ \frac{\lambda t^{\alpha+1}}{\alpha+1} + \sqrt{ \frac{\lambda \mu t^{\beta+1} t_0^{\gamma+1}}{(\beta+1)|\gamma+1|} } \right\}, \quad t \geq t_0. \quad (3.64)$$

For $0 < \alpha \leq \beta$ the estimate (3.63) is sharper of estimate (3.52), and for $0 < \alpha \leq \beta + \gamma + 2$, $\beta + 2\gamma + 3 > 0$ the estimate (3.64) is sharper of (3.53).

3.4.2. The case when $a_{12}(t) \geq 0$, $a_{21}(t) \leq 0$, $t \geq t_0$. In this subsection we shall assume $a_{12}(t) \geq 0$, $a_{21}(t) \leq 0$, $t \geq t_0$. Then from (3.32) it follows that

$$\theta(t) \geq 0, \quad t \geq t_0. \quad (3.65)$$

Then by (3.27) the radius vector $\vec{R}(t) \equiv (J_{-a_{11}}(t)\phi(t), J_{-a_{22}}(t)\psi(t))$, $t \geq t_0$ rotates monotonically around of origin of the coordinate plane ϕ, ψ in the negative direction, where $(\phi(t), \psi(t))$ is a solution to the system (1.1) (see pict. 15). From (3.65)

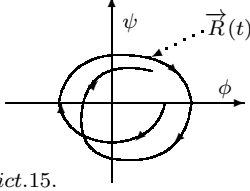

Pict.15.

it follows that $\theta(t)$ can have finite or negative infinite limit. By (3.27) in the first case the system (1.1) is non oscillatory, in the second case it is oscillatory.

Theorem 3.10 Let $a_{12}(t) \geq 0$, $a_{21}(t) \leq 0$, $t \geq t_0$, and let the system (1.1) is not oscillatory. Then if:

$A_2) I_{a_{12}, B}^+(t_0) = +\infty$, then there exists up to arbitrary multiplier the unique linearly independent solutions $(\phi_*(t), \psi_0(t))$ and $(\phi_0(t), \psi_*(t))$ of the system (1.1) such that $\phi_0(t) > 0$, $\psi_*(t) > 0$, $\phi_0(t), \phi_0(t) < 0$, $\psi_*(t) > 0$, $t \geq T$, for some $T \geq t_0$; for arbitrary solution $(\phi(t), \psi(t))$ of the system (1.1), linearly independent of $(\phi_*(t), \psi_0(t))$ (of $(\phi_0(t), \psi_*(t))$) the equality

$$\lim_{t \rightarrow +\infty} \frac{\phi_*(t)}{\phi(t)} = 0, \quad \left(\lim_{t \rightarrow +\infty} \frac{\psi_*(t)}{\psi(t)} = 0, \right), \quad (3.66)$$

is fulfilled and

$$\int_T^{+\infty} \frac{a_{12}(\tau) J_S(\tau)}{\phi_*^2(\tau)} d\tau = \int_T^{+\infty} \frac{|a_{21}(\tau)| J_S(\tau)}{\psi_*^2(\tau)} d\tau = +\infty, \quad (3.67)$$

$$\int_{T_1}^{+\infty} \frac{a_{12}(\tau) J_S(\tau)}{\phi^2(\tau)} d\tau < +\infty \quad \left(\int_{T_1}^{+\infty} \frac{a_{12}(\tau) J_S(\tau)}{\phi^2(\tau)} d\tau < +\infty \right); \quad (3.68)$$

where $T_1 = T_1(\phi; \psi) \geq t_0$ such that $\phi(t) \neq 0$, $\psi(t) \neq 0$, $t \geq T_1$ and

$\int_{T_1}^{+\infty} a_{12}(\tau) \frac{\psi(\tau)}{\phi(\tau)} d\tau = +\infty$. Moreover if in addition $\int_{t_0}^{+\infty} a_{21}(\tau) I_{a_{12}, -B}^-(t_0; \tau) d\tau = -\infty$, then

$\int_T^{+\infty} a_{12}(\tau) \frac{\psi_0(\tau)}{\phi_*(\tau)} d\tau = +\infty$;

$B_2) I_{a_{21}, -B}^+(t_0) = -\infty$, there exists up to arbitrary multiplier the unique solutions $(\phi_{**}(t), \psi_{00}(t))$ and $(\phi_{00}(t), \psi_{**}(t))$ of the system (1.1) such that $\phi_{**}(t) > 0$, $\psi_{00}(t) < 0$, $\phi_{00}(t) > 0$, $\psi_{**}(t) < 0$, $t \geq T$, for some $T \geq t_0$; for every solution $(\phi(t), \psi(t))$ of the system (1.1), linearly independent of $(\phi_{**}(t), \psi_{00}(t))$ (of $(\phi_{00}(t), \psi_{**}(t))$) the equality

$$\lim_{t \rightarrow +\infty} \frac{\phi_{**}(t)}{\phi(t)} = 0, \quad \left(\lim_{t \rightarrow +\infty} \frac{\psi_{**}(t)}{\psi(t)} = 0, \right), \quad (3.69)$$

is fulfilled and

$$\int_T^{+\infty} \frac{a_{12}(\tau)J_S(\tau)}{\phi_{**}^2(\tau)} d\tau = \int_T^{+\infty} \frac{|a_{21}(\tau)|J_S(\tau)}{\psi_{**}^2(\tau)} d\tau = +\infty, \quad (3.70)$$

$$\int_{T_1}^{+\infty} \frac{a_{12}(\tau)J_S(\tau)}{\phi^2(\tau)} d\tau < +\infty \quad \left(\int_{T_1}^{+\infty} \frac{a_{12}(\tau)J_S(\tau)}{\phi^2(\tau)} d\tau < +\infty \right); \quad (3.71)$$

where $T_1 = T_1(\phi; \psi) \geq t_0$ such that $\phi(t) \neq 0$, $\psi(t) \neq 0$, $t \geq T_1$;

$$\int_T^{+\infty} a_{12}(\tau) \frac{\psi_{00}(\tau)}{\phi_{**}(\tau)} d\tau = -\infty \quad (3.72).$$

Moreover if in addition $\int_{t_0}^{+\infty} a_{12}(\tau) I_{B, a_{21}}^-(t_0; \tau) d\tau = -\infty$, then

$$\int_{T_1}^{+\infty} a_{12}(\tau) \frac{\psi(\tau)}{\phi(\tau)} d\tau = -\infty. \quad (3.73)$$

Proof. Since the system (1.1) is not oscillatory from (3.6) it follows that it has a T -regular solution for some $T \geq t_0$. Then by (3.2) Eq. (3.1) has a T -regular solution. Due to Lemma 2.1 from here it follows that Eq. (3.1) has the unique T -extremal solution $x_*(t)$. Set

$$\phi_{**}(t) \equiv \exp \left\{ \int_T^t [a_{12}(\tau)x_*(\tau) + a_{11}(\tau)] d\tau \right\}, \quad \psi_{00}(t) \equiv x_*(t)\phi_{**}(t), \quad t \geq T. \quad (3.74)$$

By (3.2) $(\phi_{**}(t), \psi_{00}(t))$ is a solution to the system (1.1) on $[T; +\infty)$, which can be continued on $[t_0; +\infty)$ as a solution of the system (1.1). Let us prove A_2). Suppose $I_{a_{12}, B}^+(t_0) = +\infty$. Then by virtue of Theorem 2.4. F^* we have $x_*(t) > 0$, $t \geq T$. From here and from (2.74) it follows that $\phi_{**}(t) > 0$, $\psi_{00}(t) > 0$, $t \geq T$. Obviously $v_*(t) \equiv -\frac{1}{x_*(t)}$ is the T -extremal solution of the equation

$$z' - a_{21}(t)z^2 - B(t)z + a_{12}(t) = 0, \quad t \geq t_0. \quad (3.75)$$

Set

$$\phi_{00}(t) \equiv v_*(t)\psi_{**}(t), \quad \psi_{**}(t) \equiv \exp\left\{\int_T^t [a_{21}(\tau)v_*(\tau) + a_{22}(\tau)]d\tau\right\}, \quad t \geq T. \quad (3.76)$$

By (3.2) $(\phi_{00}(t), \psi_{**}(t))$ is a solution of the system (1.1) on $[T; +\infty)$, which can be continued on $[t_0; +\infty)$ as a solution of the system (1.1). From (3.76) it follows that $\phi_{00}(t) < 0$, $\psi_{**}(t) > 0$, $t \geq T$. Obviously $(\phi_{**}(t), \psi_{00}(t))$ and $(\phi_{00}(t), \psi_{**}(t))$ are linearly independent. Since $a_{12}(t) \geq 0$, $-a_{21}(t) \geq 0$, $t \geq t_0$, by virtue of Theorem 2.1 the equations (3.1) and (3.22) have the T -normal solutions $x_0(t)$ and $v_0(t)$ respectively, for which the integrals $\tilde{\nu}_{x_0}(t)$ and $\tilde{\nu}_{v_0}(t) \equiv \int_t^{+\infty} a_{21}(\tau) \exp\left\{-\int_t^\tau [-2a_{21}(\xi)v_0(\xi) - B(\xi)]d\xi\right\}$ converge for all $t \geq T$ and $\tilde{\nu}_{x_0}(t) > 0$, $\tilde{\nu}_{v_0}(t) < 0$, $t \geq T$. Set

$$\tilde{\phi}_0(t) \equiv \exp\left\{\int_T^t [a_{12}(\tau)x_0(\tau) + a_{11}(\tau)]d\tau\right\}, \quad \tilde{\psi}_0(t) \equiv x_0(t)\tilde{\phi}_0(t), \quad t \geq T;$$

$$\tilde{\phi}_0(t) \equiv v_0(t)\tilde{\phi}_0(t), \quad \tilde{\psi}_0(t) \equiv \exp\left\{\int_T^t [-a_{21}(\tau)v_0(\tau) + a_{22}(\tau)]d\tau\right\}, \quad t \geq T.$$

By (3.2) $(\tilde{\phi}_0(t), \tilde{\psi}_0(t))$ and $(\tilde{\phi}_0(t), \tilde{\psi}_0(t))$ are solutions of the system (1.1) on $[T; +\infty)$. By (3.2) we have

$$\int_t^{+\infty} \frac{a_{12}(\tau)J_S(T; \tau)}{\tilde{\phi}_0(\tau)^2}d\tau = \tilde{\nu}_{x_0}(t) > 0, \quad \int_t^{+\infty} \frac{a_{21}(\tau)J_S(T; \tau)}{\tilde{\psi}_0(\tau)^2}d\tau = \tilde{\nu}_{-v_0}(t) < 0, \quad t \geq t_0.$$

Then the equalities (3.66) - (3.68) follow from Theorem 3.5 and from the equality $\int_{T_1}^{+\infty} a_{12}(\tau) \frac{\psi(\tau)}{\phi(\tau)}d\tau = +\infty$ (since $\frac{\psi(t)}{\phi(t)}$ is the T_1 -extremal solution of Eq. (3.1)) and $\int_T^{+\infty} a_{12}(\tau) \frac{\psi_*(\tau)}{\phi_*(\tau)}d\tau = +\infty$ (since $\frac{\psi_*(t)}{\phi_*(t)} = x_*(t)$) from Theorem 2.4.I*. The assertion A_2) is proved. Let us prove B_2). Suppose $I_{a_{21}, -B}^+(t_0) = -\infty$. Then by virtue of Theorem 2.4.II* the inequality $x_*(t) < 0$, $t \geq T_1$, is fulfilled for some $T_1 \geq t_0$. Without loss generality we shall take that $T_1 = T$. Show that $v_*(t) \equiv -\frac{1}{x_*(t)}$ is the T -extremal solution of Eq. (3.75). Suppose that it is not so. Let then $\tilde{v}_*(t)$ be the T -extremal solution of Eq. (3.75)

(existence of $\tilde{v}_*(t)$ follows from Lemma 2.1). By Lemma 2.1 we have $\tilde{v}_*(T) < v_*(T)$. Then $\tilde{x}_*(t) \equiv -\frac{1}{\tilde{v}_*(t)}$ is a solution of eq. (3.1) with $\tilde{x}_*(T) < x_*(T)$. Therefore by Lemma 2.1 the solution $\tilde{x}_*(t)$ is not T -regular and has in an point $T_2 > T$ a vertical asymptote. From here it follows that $\tilde{v}_*(t) = 0$, $t \in [T_2; T_3]$ and $\tilde{v}_*(t) \neq 0$, $t \in (T_3; T_4)$ for some $T_4 > T_3 \geq T_2$. Since $x_*(t) < 0$, $t \geq T$, we have $\tilde{x}_*(t) < 0$, $t \in [T; T_1)$. From here it follows that

$$\tilde{v}_*(t) > 0, \quad t \in [T; T_1). \quad (3.77)$$

Since by (3.2) $\tilde{v}_*(t) = \frac{\tilde{\phi}_*(t)}{\tilde{\psi}_*(t)}$, $t \geq T$, where $(\tilde{\phi}_*(t), \tilde{\psi}_*(t))$ is a solution of the system (1.1) with $\tilde{\psi}_*(t) \neq 0$, $t \geq T$, on the strength of (3.27) from (3.24) it follows that $\tilde{v}_*(T_5) < 0$ for some $T_5 \in (T_3; T_4)$. Then

$$\tilde{x}_*(T_5) = -\frac{1}{\tilde{v}_*(T_5)} > 0, \quad (3.78)$$

and since $x_*(T_5) < 0$, we have that $\tilde{x}_*(t)$ is a T_5 -normal solution of Eq. (3.1). It is easy to show that from the equality $I_{a_{21}, -B}(t_0) = -\infty$ follows $I_{a_{21}, -B}(T_5) = -\infty$. By virtue of Theorem 2.4.II* from here and from (3.78) it follows that $\tilde{x}_*(T_6) = 0$ for some $T_6 > T_5$. Hence $\tilde{v}_*(t)$ has a vertical asymptote in T_6 , i. e. $\tilde{v}_*(t)$ is not T -regular. We came to the contradiction which proves that $v_*(t) \equiv -\frac{1}{x_*(t)}$ is the T -extremal solution of Eq. (3.75). Consider the functions

$$\phi_{**}(t) \equiv \exp \left\{ \int_T^t [a_{12}(\tau)x_*(\tau) + a_{11}(\tau)] d\tau \right\}, \quad \psi_{00}(t) \equiv x_*(t)\phi_{**}(t), \quad (3.79)$$

$$\psi_{**}(t) \equiv \exp \left\{ \int_T^t [-a_{21}(\tau)x_*(\tau) + a_{22}(\tau)] d\tau \right\}, \quad \phi_{00}(t) \equiv v_*(t)\psi_{**}(t), \quad t \geq T.$$

By (3.2) $(\phi_{**}(t), \psi_{00}(t))$ and $(\phi_{00}(t), \psi_{**}(t))$ are solutions of the system (1.1) on $[T; +\infty)$, which can be continued on $[t_0; +\infty)$ as solutions of the system (1.1). Obviously $\phi_{**}(t) > 0$, $\psi_{00}(t) < 0$, $\phi_{00}(t) > 0$, $\psi_{**}(t) > 0$, $t \geq T$. Therefore $(\phi_{**}(t), \psi_{00}(t))$ and $(\phi_{00}(t), \psi_{**}(t))$ are linearly independent. Further as in the proof of A_2) it shows that for some solutions $(\phi_0(t), \psi_0(t))$ and $(\phi_1(t), \psi_1(t))$ of the system (1.1) with $\phi_0(t) \neq 0$, $\psi_1(t) \neq 0$, $t \geq T$, the integrals $\int_t^{+\infty} \frac{a_{12}(\tau)J_S(\tau)}{\phi_0^2(\tau)} d\tau$ and $\int_t^{+\infty} \frac{a_{21}(\tau)J_S(\tau)}{\psi_0^2(\tau)} d\tau$ converge for all $t \geq T$ and do not vanish on $[T; +\infty)$. Then the equalities (3.69) - (3.71) are consequences of Theorem 3.5, and the equalities (3.72) and (3.73) follow from Theorem 2.4.II* and from (3.2) ((3.79)). The theorem is proved.

Theorem 3.11. Suppose $a_{12}(t) \geq 0$, $a_{21}(t) \leq 0$, $t \geq t_0$, $I_{a_{12},B}^+(t_0) < +\infty$, $I_{-a_{21},-B}^+(t_0) < +\infty$. Then the following assertions are valid:

A_3) the system (1.1) is non oscillatory;

B_3) there exist up to arbitrary multiplier the unique solutions $(\phi_*(t), \psi_0(t))$ and $(\phi_0(t), \psi_*(t))$ of the system (1.1) such that $\phi_*(t) > 0$, $\psi_0(t) < 0$, $\phi_0(t) < 0$, $\psi_*(t) > 0$, $t \geq T$ for some $T > t_0$, for each solution $(\phi(t), \psi(t))$ of the system (1.1), linearly independent of $(\phi_*(t), \psi_0(t))$ (of $(\phi_0(t), \psi_*(t))$) the equality

$$\lim_{t \rightarrow +\infty} \frac{\phi_*(t)}{\phi(t)} = 0, \quad \left(\lim_{t \rightarrow +\infty} \frac{\psi_*(t)}{\psi(t)} = 0 \right). \quad (3.80)$$

is fulfilled and

$$\int_T^{+\infty} \frac{a_{12}(\tau) J_S(\tau)}{\phi_*^2(\tau)} d\tau = - \int_T^{+\infty} \frac{a_{21}(\tau) J_S(\tau)}{\psi_*^2(\tau)} d\tau = +\infty, \quad (3.81)$$

$$\int_{T_1}^{+\infty} \frac{a_{12}(\tau) J_S(\tau)}{\phi^2(\tau)} d\tau < +\infty \quad \left(\int_{T_1}^{+\infty} \frac{|a_{21}(\tau)| J_S(\tau)}{\psi^2(\tau)} d\tau < +\infty \right). \quad (3.82)$$

For every solution $(\phi(t), \psi(t))$ of the system (1.1), linearly independent of $(\phi_*(t), \psi_0(t))$ the integral $\int_{T_1}^{+\infty} a_{12}(\tau) \frac{\psi(\tau)}{\phi(\tau)} f\tau \left(\int_{T_1}^{+\infty} a_{21}(\tau) \frac{\phi(\tau)}{\psi(\tau)} d\tau \right)$ converges, where $T_1 \geq t_0$ such that $\phi(t) \neq 0$, $\psi(t) \neq 0$, $t \geq T_1$, and

$$\int_T^{+\infty} a_{12}(\tau) \frac{\psi_0(\tau)}{\phi_*(\tau)} d\tau = -\infty, \quad \int_T^{+\infty} a_{21}(\tau) \frac{\phi_0(\tau)}{\psi_*(\tau)} d\tau = +\infty. \quad (3.83)$$

Proof. The assertion A_3) immediately follows from (3.32) and from the equalities

$$\int_{t_0}^{+\infty} A_{12}(\tau) d\tau = I_{a_{12},B}^+(t_0), \quad \int_{t_0}^{+\infty} A_{21}(\tau) d\tau = I_{a_{21},-B}^+(t_0).$$

Let us prove B_3). From A_3) and from (3.6) it follows that for some solution $(\phi_0(t), \psi_0(t))$ of the system (1.1) the inequality $\phi_0(t) \neq 0$, $t \geq T$, is fulfilled for some $T \geq t_0$. Therefore $x_0(t) \equiv \frac{\psi_0(t)}{\phi_0(t)}$ is a T -regular solution of eq. (3.1). Then since $a_{12}(t) \geq 0$, $t \geq t_0$, by virtue of Lemma 2.1 Eq. (3.1) has the T -extremal solution $x_*(t)$. By virtue of

Theorem 2.4.IV* from the conditions of the theorem it follows that $x_*(t) < 0$, $t \geq T_1$, for some $T_1 \geq t_0$. Without loss of generality we shall take that $T_1 = T$. Then $v_0(t) \equiv -\frac{1}{x_*(t)}$ is a T -regular solution of Eq. (3.75). Since $a_{21}(t)$ does not change sign from here it follows that Eq. (3.75) has the T -extremal solution $v_*(t)$. According to Theorem 2.4.III* from the convergence of the integral $I_{a_{21},-B}^+(t_0)$ it follows that $v_*(t) < 0$, $t \geq T_2$, for some $T_2 \geq t_0$. Without loss of generality we shall take that $T_2 = T$. By (3.2) the functions

$$\phi_*(t) \equiv \exp \left\{ \int_T^t [a_{12}(\tau)x_*(\tau) + a_{11}(\tau)] d\tau \right\} \quad \psi_0(t) \equiv x_*(t)\phi_*(t),$$

$$\psi_*(t) \equiv \exp \left\{ \int_T^t [-a_{21}(\tau)v_*(\tau) + a_{22}(\tau)] d\tau \right\} \quad \phi_0(t) \equiv v_*(t)\psi_*(t), \quad t \geq T,$$

form solutions $(\phi_*(t), \psi_0(t))$, $(\phi_*(t), \psi_0(t))$ of the system (1.1). Obviously $\phi_*(t) > 0$, $\psi_0(t) < 0$, $\phi_0(t) < 0$, $\psi_*(t) > 0$, $t \geq T$. Prove that these solutions are linearly independent. Suppose that it is not so. Then $\phi_0(t) = \lambda\phi_*(t)$, $\psi_*(t) = \lambda\psi_0(t)$, $t \geq T$, for some $\lambda = \text{const}$. From here it follows $\frac{\psi_0(t)}{\psi_*(t)} = \frac{\phi_*(t)}{\phi_0(t)}$, i. e. $x_*(t) = \frac{1}{v_*(t)}$, $t \geq T$. But on the other hand $x_*(t) = -\frac{1}{v_0(t)}$, $t \geq T$. From here it follows that $v_*(t) = -v_0(t)$, $t \geq T$. Then $x_0(t) \equiv -\frac{1}{v_*(t)} = \frac{1}{v_0(t)}$ is a positive T -regular solution of Eq. (3.1): $x_*(t) = -x_0(t)$. Since $x_0(t) > 0$, and $x_*(t) < 0$, $t \geq T$, by virtue of Lemma 2.1 we have that $x_0(t)$ is T -normal. Then on the strength of Theorem 2.4 the integral $\int_T^{+\infty} a_{12}(\tau)x_0(\tau)d\tau$ converges. But on the other hand by

virtue of the same Theorem 2.4.III* $\int_T^{+\infty} a_{12}(\tau)x_0(\tau)d\tau = -\int_T^{+\infty} a_{12}(\tau)x_*(\tau)d\tau = +\infty$. We came to the contradiction. Hence $(\phi_*(t), \psi_0(t))$ and $(\phi_*(t), \psi_0(t))$ are linearly independent. Let $x_0(t)$ and $v_0(t)$ be T -normal solutions of the equations (3.1) and (3.75) respectively. Then by virtue of Theorem 2.2 the integrals $\nu_{x_0}(t)$ and $\tilde{\nu}_{v_0}(t)$ converge for all $t \geq T$ and

$$\nu_{x_0}(t) > 0, \quad \tilde{\nu}_{v_0}(t) < 0, \quad t \geq T. \quad (3.85)$$

Set

$$\phi_0(t) \equiv \exp \left\{ \int_T^t [a_{12}(\tau)x_0(\tau) + a_{11}(\tau)] d\tau \right\} \quad \psi_0(t) \equiv x_0(t)\phi_0(t),$$

$$\psi_1(t) \equiv \exp \left\{ \int_T^t [-a_{21}(\tau)v_0(\tau) + a_{22}(\tau)] d\tau \right\} \quad \phi_1(t) \equiv v_0(t)\psi_1(t), \quad t \geq T,$$

By (3.2) $(\phi_0(t), \psi_0(t))$, $(\phi_1(t), \psi_1(t))$ are solutions of the system (1.1) on $[T; +\infty)$, which can be continued on $[t_0; +\infty)$ as solutions of the system (1.1) By virtue of (3.2) we have:

$$I_{\phi_0}(t) \equiv \int_t^{+\infty} \frac{a_{12}(\tau)J_S(\tau)}{\phi_0^2(\tau)} d\tau = \nu_{x_0}(t), \quad \tilde{I}_{\psi_1}(t) \equiv \int_t^{+\infty} \frac{a_{21}(\tau)J_S(\tau)}{\psi_1^2(\tau)} d\tau = \tilde{\nu}_{v_0}(t), \quad t \geq T.$$

From here and from (3.85) it follows that $I_{\phi_0}(t) \neq 0$, $\tilde{I}_{\psi_1}(t) \neq 0$, $t \geq T$. Then the equalities (3.80), (3.81), (3.82) follow from Theorem 3.5 and the equalities (3.80), (3.81) and the convergence of the integral $\int_{T_1}^{+\infty} a_{12}(\tau) \frac{\psi(\tau)}{\phi(\tau)} d\tau$ $\left(\int_{T_1}^{+\infty} a_{21}(\tau) \frac{\phi(\tau)}{\psi(\tau)} d\tau \right)$ follow from Theorem 2.4.III* and from (3.2). The theorem is proved.

Theorem 3.12. Let $a_{12}(t) \geq 0$, $a_{21}(t) \leq 0$, $t \geq t_0$, and let for some solution $(\phi(t), \psi(t))$ of the system (1.1) and for some $T \geq t_0$ the inequality $\phi(t) \neq 0$, $t \geq T$ is fulfilled. Then the system (1.1) satisfies to the non conjugation condition on $[T; +\infty)$.

Proof. By (3.6) we have:

$$\phi(t) = \mu \frac{J_{S/2}(t)}{\sqrt{y_0(t)}} \sin \left(\int_{t_0}^t a_{12}(\tau) y_0(\tau) d\tau + \nu \right), \quad t \geq t_0,$$

where μ and ν are some constants. Then $\int_{t_0}^t a_{12}(\tau) y_0(\tau) d\tau + \nu \in (\pi k_0, \pi(k_0 + 1))$ $t \geq T$, for some integer k_0 . Therefore for arbitrary $\nu_1 \in R$ we have

$$\int_{t_0}^t a_{12}(\tau) y_0(\tau) d\tau + \nu_1 \in (\pi k_0 + \nu_1 - \nu; \pi(k_0 + 1) + \nu_1 - \nu), \quad (3.86)$$

Let $(\phi_1(t), \psi_1(t))$ be an arbitrary solution to the system (1.1). Then by (3.6) we have

$$\phi_1(t) = \mu_1 \frac{J_{S/2}(t)}{\sqrt{y_0(t)}} \sin \left(\int_{t_0}^t a_{12}(\tau) y_0(\tau) d\tau + \nu_1 \right), \quad t \geq t_0,$$

and since the function $f(t) \equiv \int_{t_0}^t a_{12}(\tau) y_0(\tau) d\tau$ monotonically non decreases from (3.86) it follows that $\phi_1(t)$ vanishes on $[T; +\infty)$ no more than one time. Let us show that the function $\psi_1(t)$ vanishes on $[T; +\infty)$ no more than one time. Suppose that it is not so. Then

for some $t_k \geq T$, $k = \overline{1, 4}$, $T < t_1 \leq t_2 < t_3 \leq t_4$ we have $\psi_1(t) = 0$, $t \in [t_1; t_2] \cup [t_3; t_4]$ and $\psi_1(t) \neq 0$, $t \in (t_2; t_3)$. Then since $a_{12}(t)$ and $a_{21}(t)$ do not change sign by virtue of Corollary 3.2 from the work [6] we have $\phi(t_5) = 0$ for some $t_5 \in (t_2; t_3)$, which contradicts the condition of the theorem. Hence $\psi_1(t)$ vanishes on $[T; +\infty)$ no more than one time. The theorem is proved.

Now we investigate the system (1.1) in the case when it is non oscillatory. Let then $T \geq t_0$ such that according to Theorem 3.12 the system (1.1) satisfies the non conjugation condition on $[T; +\infty)$, and some its solution $(\phi_0(t), \psi_0(t))$ is T -regular. Without loss of generality we shall take that $\phi_0(T) = 1$. Consider the family of solutions of the system (1.1): $\Omega_T \equiv \{(\phi(t), \psi(t)) : \phi(t_0) = 1\}$. Since $(\phi_0(t), \psi_0(t)) \in \Omega_T$ and $\phi_0(t) \neq 0$, $t \geq T$, by (3.2) we have that $x_0(t) \equiv \frac{\psi_0(t)}{\phi_0(t)}$ is a T -regular solution to eq. (3.1). Then according to Lemma 2.1 Eq. (3.1) has the unique T -extremal solution. Suppose $I_{a_{12}, B}^+(t_0) = +\infty$ and $(\phi(t), \psi(t)) \in \Omega_T$, $\psi(T) > x_*(T)$. Then by virtue of Theorem 2.4.I* the function $\Phi_T(t) \equiv J_{-a_{11}}(T; t)\phi(t) \equiv \exp\left\{\int_T^t a_{12}(\tau) \frac{\psi(\tau)}{\phi(\tau)}\right\}$ is monotonically non decreasing function on $[T; +\infty)$ and if $\psi(T) > x_*(T)$, then $\Psi_T(+\infty) = +\infty$. Moreover if in addition $\int_{t_0}^{+\infty} |a_{21}(\tau)| I_{a_{12}, -B}^+(t_0; \tau) = +\infty$, then (for $\psi(T) = x_*(T)$) $\Phi_T(+\infty) = +\infty$. If $\psi(T) < 0$, then according to Lemma 2.1 the function $\Phi_T(t)$ vanishes on $[t_1; t_2]$, $T < t_1 \leq t_2 < +\infty$, and from (3.27) it follows (since $\Phi_T(t) > 0$, $t \in [T; t_1)$), that $\Phi_T(t) < 0$, $t > t_2$ (see pict. 16). Suppose $I_{a_{21}, -B}^+(t_0) = -\infty$. Then by virtue of Theorem 2.4.II*, if $\psi(T) > x_*(T)$ and $\psi(T) > 0$, then there exist $t_2 \geq t_1 > T$ such that $\Phi_T(t)$ monotonically non decreasing on $[T; t_1)$, is a constant on $[t_1; t_2]$ and monotonically non increases on $[t_2; +\infty)$, and $\Phi_T(t) > 0$, $t \geq T$. If $\phi(T) = x_*(T)$, then $\Phi_T(t) > 0$, $t \geq T$ and $\Phi_T(+\infty) = 0$, and if in addition $\int_{t_0}^{+\infty} a_{12}(\tau) I_{B, |a_{21}|}^-(t_0; \tau) d\tau = +\infty$, then for $\psi(T) > x_*(T)$ also we have $\Phi_T(+\infty) = 0$. If $\psi(T) < x_*(T)$, there exist $t_2 \geq t_1 > T$ such that $\Phi_T(t) > 0$, $t \in [T; t_1)$, $\Phi_T(t) = 0$, $t \in [t_1; t_3]$ and $\Phi_T(t) < 0$, $t > t_2$ (see pict. 17).

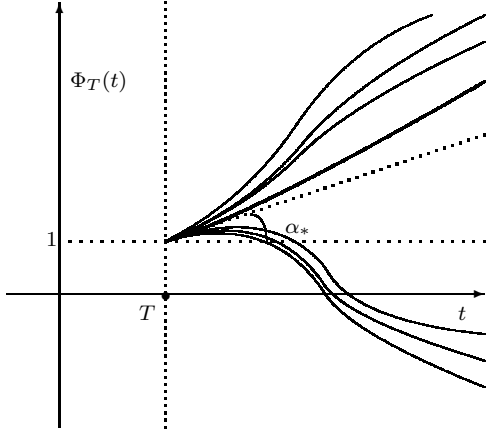

Pict.16. $\alpha_* = \arctan x_*(T) > 0, I_{a_{12}, B}^+(t_0) = +\infty.$

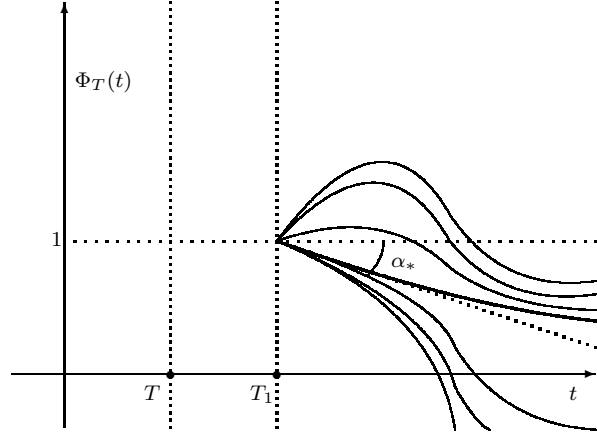

Pict.17. $\alpha_* = \arctan x_*(T_1) < 0, I_{a_{21}, -B}^+(t_0) = -\infty.$

Suppose $I_{a_{12}, B}^+(t_0) < +\infty, I_{-a_{21}, -B}^+(t_0) < +\infty.$ Then by Theorem 2.4.III* there exists $t_1 \geq T$ such that $x_*(t) < 0, t \geq T_1.$ There exists $\psi_N^+ > 0$ such that if $\psi(T_1) \in (0; \phi + N^+),$ then there exist $t_2 \geq t_1 > T_1$ such that $\Phi_T(t)$ monotonically non decreasing on $[T_1; t_1],$ is a constant on $[t_1; t_2]$ and monotonically non decreases for $t > t_2,$ and $\Phi_T(t) > 0, t \geq T_1.$ If $\psi(T_1) > \psi_N^+,$ then $\Phi_T(t)$ is monotonically non decreasing and has finite limit, and for $\phi(T_1) = x_*(T_1) \Phi_T(+\infty) = 0.$ If $\psi(T_1) < \psi_N^+,$ then there exist $t_2 \geq t_1 > T_1$ such that $\Phi_T(t) > 0, t \in [T_1; t_1],$ monotonically non increases, $\Phi_T(t) = 0, t \in [t_1; t_2]$ and $\Phi_T(t) < 0, t \geq t_2$ (see pict. 18). By (2.52) for the solution $(\phi(t), \psi(t)) \in \Omega_T$ with $\psi(T) \geq x_*(T)$ the inequality

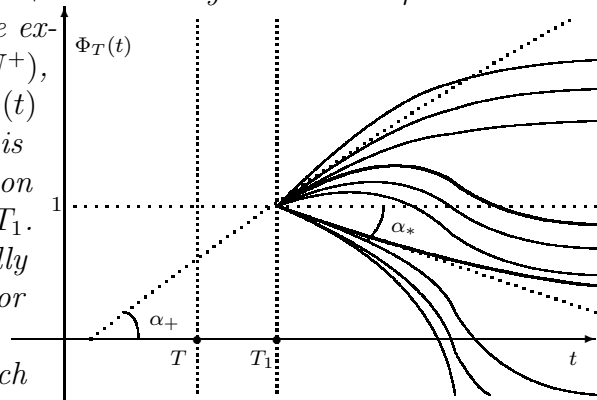

Pict.18. $\alpha_* = \arctan x_*(T_1) < 0, \alpha_+ = \arctan \psi_N^+(T_1) > 0, I_{a_{12}, B}^+(t_0) < +\infty, I_{-a_{21}, -B}^+(t_0) < +\infty.$

$$0 < \phi(t) \leq \exp \left\{ \frac{1}{2} \left(\int_T^t S(\tau) d\tau + \sqrt{\int_T^t a_{12}(\tau) \left[4 \frac{\psi(T)}{\phi(T)} + \int_T^\tau \frac{B^2(s) + 4a_{12}(s)a_{21}(s)}{a_{12}(s)} ds \right] d\tau} \right) \right\},$$

$t \geq T$ is fulfilled.

References

1. L. Ya. Adrianova, *Vvedenie v teoriu lineinikh sistem differentsial'nykh uravnenii (Introduction to the Theory of Linear Systems of Differential Equations).* St. - Peterburg: Izd. St. - Peterburg. Univ., 1992.
2. G. A. Grigorian, *On the Stability of Systems of Two First - Order Linear Ordinary Differential Equations,* *Differ. Uravn.,* 2015, vol. 51, no. 3, pp. 283 - 292.

3. G. A. Grigorian. *Necessary Conditions and a Test for the Stability of a System of Two Linear Ordinary Differential Equations of the First Order*. *Differ. Uravn.*, 2016, Vol. 52, No. 3, pp. 292 - 300.
4. G. A. Grigorian. *Some Properties of Solutions of Systems of Two Linear First - Order Ordinary Differential Equations*, *Differ. Uravn.*, 2015, Vol. 51, No. 4, pp. 436 - 444.
5. G. A. Grigorian, *Global Solvability of Scalar Riccati Equations*. *Izv. Vissh. Uchebn. Zaved. Mat.*, vol. 51, 2015, no. 3, pp. 35 - 48.
6. G. A. Grigorian. *Oscillatory Criteria for the Systems of Two First - Order Linear Ordinary Differential equations*. *Rocky Mountain Journal of Mathematics*, vol. 47, no. 5, 2017, pp. 1497 - 1524.
7. J. D. Mirzov, *Asymptotic properties of solutions of nonlinear non autonomus ordinary differential equations*, Brno: Masarik Univ, 2004.
8. R. Bellman, *Stability theory of differential equations*. Moskow, Foreign Literature Publishers, 1964.
9. A. I. Egorov, *Riccati Equations* (Fizmatlit, Moscow, 2011) [in Russian].
10. G. A. Grigorian. *On Two Comparison Tests for Second-Order Linear Ordinary Differential Equations (Russian)* *Differ. Uravn.* 47 (2011), no. 9, 1225 - 1240; translation in *Differ. Equ.* 47 (2011), no. 9 1237 - 1252, 34C10.
11. G. A. Grigorian, *Properties of solutions of Riccati equation*, *Journal of Contemporary Mathematical Analysis*, 2007, vol. 42, No 4, pp. 184 - 197.
12. G. A. Grigorian, *Two Comparison Criteria for Scalar Riccati Equations with Applications*. *Russian Mathematics (Iz. VUZ)*, 56, No. 11, 17 - 30 (2012).
13. G. A. Grigorian, *Some Properties of Solutions to Second - Order Linear Ordinary Differential Equations*. *Trudty Inst. Matem. i Mekh. UrO RAN*, 19, No. 1, 69 - 80 (2013).
14. L. Cesary, *Asymptotic behavior and stability problems in ordinary differential equations*. Moskow, "Mir", 1964.
15. L. A. Gusarov, *On Vanishing of Solutions of the Second Order Differential Equations*. *Sov. Phys. Dokl.* 71 (1) 0 -12 (1950).
16. C. A. Swanson, *Comparison and oscillation theory of linear differential equations*. Academic press. New York and London, 1968.
17. Ph. Hartman, *Ordinary differential equations*, SIAM - Society for industrial and applied Mathematics, *Classics in Applied Mathematics* 38, Philadelphia 2002.
18. F. Tricomi, *Differential Equations*, Izdatelstvo inostranoj literatury (russian translation of the book F. G. Tricomi, *Differential Equations*, Blackie & Son Limited).