

Motion and collision of particles in rotating linear dilaton black hole

P. A. González,^{1,*} Marco Olivares,^{2,†} Eleftherios Papantonopoulos,^{3,‡} and Yerko Vásquez^{4,§}

¹*Facultad de Ingeniería y Ciencias, Universidad Diego Portales,
Avenida Ejército Libertador 441, Casilla 298-V, Santiago, Chile.*

²*Facultad de Ingeniería y Ciencias, Universidad Diego Portales,
Avenida Ejército Libertador 441, Casilla 298-V, Santiago, Chile.*

³*Department of Physics, National Technical University of Athens, Zografou Campus GR 157 73, Athens, Greece.*

⁴*Departamento de Física y Astronomía, Facultad de Ciencias, Universidad de La Serena,
Avenida Cisternas 1200, La Serena, Chile.*

(Dated: February 7, 2018)

We study the motion of particles in the background of a four-dimensional linear dilaton black hole. We solve analytically the equations of motion of the test particles and we describe their motion. We show that the dilaton black hole acts as a particle accelerator by analyzing the energy in the center of mass (CM) frame of two colliding particles in the vicinity of its horizon. In particular we find that there is a critical value of the angular momentum, which depends on the string coupling, and a particle with this critical angular momentum can reach the inner horizon with an arbitrarily high CM energy. This is known as the Bañados, Silk and West (BSW) process. We also show that the motion and collisions of particles have a similar behavior to the three-dimensional BTZ black hole. In fact, the photons can plunge into the horizon or escape to infinity, and they can not be deflected, while for massive particles there are no confined orbits of first kind, like planetary or circular orbits.

arXiv:1802.01760v1 [gr-qc] 6 Feb 2018

* pablo.gonzalez@udp.cl

† marco.olivaresr@mail.udp.cl

‡ lpapa@central.ntua.gr

§ yvasquez@userena.cl

CONTENTS

I. Introduction	2
II. Static linear dilaton black holes	3
III. Motion equations of particles in a linear dilaton black hole	5
IV. Geodesics in the equatorial plane	6
A. Time Like Geodesics	8
1. Radial Geodesics	10
B. Null geodesics in the equatorial plane	11
1. Direct null bounded trajectory	12
2. Direct null unbounded trajectory	13
3. Radial Motion	14
V. The CM energy of two colliding particles	15
VI. The general equations of geodesic motion	19
A. Analysis of the angular motion (θ -motion)	20
B. Analysis of the radial motion (r -motion)	20
1. Radial motion of particles	21
2. Bounded radial motion of photons	21
3. Unbounded radial motion of photons	22
C. Analysis of the angular motion (φ -motion)	22
D. Analysis of the time motion (t -motion)	23
VII. Summary	23
Acknowledgments	25
References	26

I. INTRODUCTION

Stringy black holes are interesting because they have quite different properties from those that appear in the black hole solutions of general relativity (GR). The main ingredient of these solutions is the presence of a scalar field, the dilaton, which effectively acts as a string coupling. Then with a suitable conformal transformation this field couples to the electromagnetic field and this new coupling alters the known properties of spherically symmetric black hole solutions of GR. A static stringy charged black hole solution was found in [1], and independently in [2], known as Garfinkle-Horowitz-Strominger (GHS) black hole. These solutions resulted from a four-dimensional field theory of a heterotic string theory. Then, in the context of the heterotic string theory, a general electrically charged, rotating black hole solution was found [3, 4] which later was extended [5] and black hole solutions were found carrying electric charge, and both, electric and magnetic type antisymmetric tensor gauge field charge. Also, solitonic black hole solutions [6] and black hole solutions in the presence of a cosmological constant [7] were found.

In [8] within the Einstein-Maxwell-dilaton-axion theory rotating black hole solutions which asymptote to the linear dilaton space-time were found. The non-rotating case can be considered as some limit of extremal GHS black holes with a geometric interpretation of a horizon plus a throat describing a non-asymptotically flat black hole. Particularly they can be regarded as excitations over the linear dilaton vacua, forming a two-parameter family, which can be obtained as near-horizon and near-extreme limits of the parent dilaton black holes. Also in [8] a rotating version of linear dilaton black holes were found in which the dilaton field is independent of the black hole mass. The metric possesses an ergosphere outside the event horizon, which rotates with some angular velocity Ω_h . The angular momentum J computed as a surface integral at spatial infinity contains both a geometrical contribution and that coming from the Maxwell field. The Hawking temperature and the entropy depend both on the mass and the angular momentum of the black hole, these quantities are shown to satisfy the first law in the form $d\mathcal{M} = TdS + \Omega_h dJ$. Also analytical solutions of rotating linear dilaton black holes were discussed in [9, 10].

The Hamilton-Jacobi equation in the rotating linear dilaton black hole spacetime is shown to be separable [8] as in the Kerr case, indicating the existence of a Stachel-Killing tensor. Timelike geodesics do not escape to infinity,

while null ones do so for an infinite affine parameter. The Klein-Gordon equation is also separable, the mode behavior near the horizon exhibits the superradiance phenomenon. It was shown that all superradiant modes are reflected at large distances from the black hole, so there is no superradiant flux at infinity, in contrast with the case of massless fields in the Kerr spacetime. This situation is similar to the confinement of *massive* superradiant modes in the Kerr metric, which are reflected back to the horizon causing stimulated emission and absorption. In the classical limit this leads to an amplification effect due to the positive balance between emission and absorption. In the Kerr spacetime this phenomenon is rather small, being present only for massive modes. In our case massless modes are confined too, therefore all superradiant modes will form a cloud outside the horizon with an exponentially growing amplitude. This is in fact a classical instability which manifests itself in the rapid transfer of angular momentum from the hole to the outside matter cloud. A similar conclusion was obtained in [11] for the case of the Kerr-AdS spacetime with reflecting boundary conditions on the AdS boundary. The stability of the rotating linear dilatonic black hole was also studied in [12], by calculating the quasinormal modes of scalar field perturbations and superradiant modes.

The properties of charged black holes in string theory can be revealed studying the geodesics around these solutions. This is because except the information we get solving the classical equations of motion in the form of Einstein equations we also get information about stringy corrections due to the string coupling which is of the order of Planck scale. The study of null geodesics in the electrically charged GHS black hole was carried out in Refs. [13, 14], and the timelike geodesics were analyzed in [14–18]. Additionally, in [19] the gravitational Rutherford scattering and Keplerian orbits were studied in the GHS black hole background and the motion of massive particles with electric and magnetic charges in the background of a magnetically charged GHS stringy black hole in Ref. [20].

The aim of this work is to consider the linear dilaton black hole solution [8], and to study the geodesic structure. Also, to analyze, via the Bañados, Silk and West (BSW) mechanism, the possibility of obtaining unbounded energy in the center of mass (CM) frame of two colliding particles. Two particles colliding near the degenerate horizon of an extreme Kerr black hole could create a large CM energy if one of the particles has a critical angular momentum; thus, extreme Kerr black holes can act as natural particle accelerators, which is known as BSW mechanism [21]. Then, based on an infinite acceleration being able to occur not only for extremal black holes but also for non-extremal ones [22], it was shown that an infinite energy in the CM frame of colliding particles is a universal property of rotating black holes as long as the angular momentum of one of the colliding particles approaches the critical value [23]. However, it was shown that the similar effect exists for non-rotating charged black holes [24]. Moreover, the extension of the BSW mechanism to non-extremal backgrounds shows that particles cannot collide with arbitrarily high energies at the outer horizon and that ultra-energetic collisions can only occur near the Cauchy horizon of a Kerr black hole with any spin parameter [25]. The non-extremal Kerr-de Sitter black holes could also act as particle accelerators with arbitrarily high CM energy if one of the colliding particles has the critical angular momentum [26]. Also, it is known that two particles in the ergosphere lead to infinity growth of the energy of the CM frame, provided the angular momentum of one of the two particles has a large negative angular momentum and a fixed energy at infinity for the Kerr black holes [22], which was subsequently proven to be a universal property of the ergosphere [27]. The BSW mechanism has been studied for different black hole geometries. Higher-dimensional black holes have been studied, for instance, in Refs. [28–30], lower-dimensional black holes in Refs. [31, 35, 36, 44–46], as well as stringy black holes [37].

The manuscript is organized as follows: In Sec. II we give a brief review of the linear dilaton black hole. Then, we obtain the equations of motion in Sec. III. In Sec. IV we analyze the geodesics in the equatorial plane. In Sec. V we obtain the CM energy of two colliding particles, and we study the radial motion of a particle with critical angular momentum and we investigate the possibility that the black hole acts as a particle accelerator. Then, in Sec VI we study the geodesics in four dimensions. Finally, our conclusions are in Sec. VII.

II. STATIC LINEAR DILATON BLACK HOLES

In this section we will review how the linear dilaton black hole is extracted from the GHS solution [2]. The most general action of low energy heterotic string theory is given by

$$\mathcal{S} = \int d^D x \sqrt{-g} e^{-2\varphi} \left[\Lambda + R + 4(\nabla\varphi)^2 - F_{\mu\nu}F^{\mu\nu} - \frac{1}{12}H_{\mu\nu\rho}H^{\mu\nu\rho} \right], \quad (1)$$

where the scalar field φ is the dilaton field, $F_{\mu\nu}$ is a Maxwell field, and the three form $H_{\mu\nu\rho}$ is related to a two-form potential $B_{\mu\nu}$ and the gauge field A_μ by $H = dB - A \wedge F$ so that $dH = -F \wedge F$. Note that in this action the term e^φ plays the role of a coupling constant giving the strength of the stringy effects.

If we set H to zero and make the conformal transformation of the metric to rescale $g_{\mu\nu}$ by $e^{-2\varphi}$ to get a metric with the standard Einstein action

$$g_{\mu\nu}^E = e^{-2\varphi} g_{\mu\nu}. \quad (2)$$

The action now becomes (with $\Lambda = 0$)

$$\mathcal{S} = \int d^4x \sqrt{-g_E} (R_E - 2(\nabla\varphi)^2 - e^{-2\varphi}F^2) . \quad (3)$$

Rescaling the Einstein metric we get a simple form of an electrically charged black hole

$$ds_E^2 = -\left(1 - \frac{2M}{r}\right)dt^2 + \left(1 - \frac{2M}{r}\right)^{-1}dr^2 + r\left(r - \frac{Q^2}{M}\right)d\Omega , \quad (4)$$

$$F_{rt} = \frac{Q}{r^2} , \quad e^{2\phi} = 1 - \frac{Q^2}{Mr} . \quad (5)$$

Note that the metric in the $r-t$ plane is identical to Schwarzschild. The only difference is that the area of the spheres is smaller. In fact, this area goes to zero when $r = Q^2/M$ and this surface is singular. Since g_{tt} remains finite at the singularity, there is no ‘‘infinite stretching’’ analogous to what happens to an observer hitting the singularity in Schwarzschild. As you increase Q , the singularity moves out in ‘‘ r ’’. In the extremal limit $Q^2 = 2M^2$, the singularity coincides with the horizon. If you increase Q farther, the singularity moves outside the horizon and becomes timelike.

Using these properties of the electrically charged GHS black hole, studying its near-horizon and near-extremal limits and the results of [38] a linear dilaton black hole solution was constructed in [8]

$$ds^2 = \frac{r-b}{r_0}dt^2 - \frac{r_0}{r-b}dr^2 - r_0rd\Omega^2 , \quad (6)$$

$$e^{2\phi} = \frac{r}{r_0} , \quad F_{tr} = \frac{1}{\sqrt{2}r_0} . \quad (7)$$

The two parameters r_0 and b have a different physical meanings. The first describes the electric charge Q of the solution which is given by the flux through a 2-sphere

$$Q = \frac{1}{4\pi} \int e^{-2\phi}F^{0r}\sqrt{g}d\Omega = \frac{r_0}{\sqrt{2}} , \quad (8)$$

and characterizes the linear dilaton background and the parameter b characterizing the black hole solution is proportional to its mass. This solution corresponds to the Schwarzschild black hole. However the spacetime is not asymptotically flat.

Finally, this static lineal dilaton solution was generalized to a stationary one [8]

$$ds^2 = \frac{r^2 - 2Mr + a^2}{r_0r}dt^2 - r_0r \left[\frac{dr^2}{r^2 - 2Mr + a^2} + d\theta^2 + \sin^2\theta \left(d\varphi - \frac{a}{r_0r}dt \right)^2 \right] , \quad (9)$$

$$F = \frac{1}{\sqrt{2}} \left[\frac{r^2 - a^2 \cos^2\theta}{r_0r^2} dr \wedge dt + a \sin 2\theta d\theta \wedge \left(d\varphi - \frac{a}{r_0r}dt \right) \right] , \quad (10)$$

$$e^{-2\phi} = \frac{r_0r}{r^2 + a^2 \cos^2\theta} . \quad (11)$$

The Maxwell two-form is derivable from the following four-potential

$$A = \frac{1}{\sqrt{2}} \left(\frac{r^2 + a^2 \cos^2\theta}{r_0r}dt + a \sin^2\theta d\varphi \right) , \quad (12)$$

where the gauge is chosen such that the vector magnetic potential be regular on the axis $\theta = 0$.

Although the metric (9) was derived from the Kerr metric, it differs in its asymptotic behavior ($r \rightarrow \infty$), which is the same as for the linear dilaton metric and in its behaviour near $r = 0$. In the case of the Kerr metric, $r = 0$ is the equation of a disk through which the metric can be continued to negative r , while in (9) $r = 0$ is a timelike line singularity. It follows studying the Penrose diagrams of (9) for the three cases $M^2 > a^2$, $M^2 = a^2$ and $M^2 < a^2$ are identical, not to those of the Kerr spacetime, but rather to those of the Reissner-Nordström spacetime, with the charge replaced by the angular momentum parameter a .

III. MOTION EQUATIONS OF PARTICLES IN A LINEAR DILATON BLACK HOLE

Now, in order to obtain the motion equations of particles and photons in a linear dilaton black hole we rewrite the metric (9) as

$$ds^2 = -f(r)dt^2 + \frac{dr^2}{f(r)} + h(r) \left(d\theta^2 + \sin^2 \theta \left(d\varphi - a \frac{dt}{h(r)} \right)^2 \right), \quad (13)$$

where

$$f(r) = \frac{r^2 - 2Mr + a^2}{r_0 r} = \frac{(r - r_+)(r - r_-)}{r_0 r}, \quad h(r) = r_0 r, \quad (14)$$

and r_0 is a positive constant. The outer and inner horizons are given by

$$r_{\pm} = M \pm \sqrt{M^2 - a^2}. \quad (15)$$

It is worth noting that the geodesic structure of the linear dilaton black hole was studied in [39] for the non-rotating case. Here, we shall extend such study by considering the rotating case.

So, we first derive the equations of motion following the same approach given in [40]. We consider the motion of test particles with mass m and photons. Thus, in order to obtain the equation of motion, we apply the Hamilton-Jacobi formalism. In this sense, the Hamilton-Jacobi equation for the geometry described by the metric $g_{\mu\nu}$ is

$$2 \frac{\partial S}{\partial \tau} = g^{\mu\nu} \frac{\partial S}{\partial x^\mu} \frac{\partial S}{\partial x^\nu}. \quad (16)$$

So, in order to solve the Hamilton-Jacobi equation, and taking into account the symmetries of the metric, we use the following ansatz for the action

$$S = -\frac{1}{2} m^2 \tau - E t + S_r(r) + S_\theta(\theta) + L \varphi, \quad (17)$$

where E and L are identified as the energy and angular momentum of the particle. Thus, by replacing this ansatz in Eq. (16) yields

$$\left(\frac{\partial S_r}{\partial r} \right)^2 - \left(\frac{E}{f(r)} - \frac{aL}{h(r)f(r)} \right)^2 + \frac{m^2}{f(r)} + \frac{1}{h(r)f(r)} \left(\left(\frac{\partial S_\theta}{\partial \theta} \right)^2 + \frac{L^2}{\sin^2 \theta} \right) = 0. \quad (18)$$

Now, using the standard procedure we recognize the following constant

$$k^2 = \left(\frac{\partial S_\theta}{\partial \theta} \right)^2 + \frac{L^2}{\sin^2 \theta}, \quad (19)$$

which is identified as the Carter separability constant. Then, we obtain the following equation for the radial component of the action

$$\left(\frac{\partial S_r}{\partial r} \right)^2 - \left(\frac{E}{f(r)} - \frac{aL}{h(r)f(r)} \right)^2 + \frac{k^2 + m^2 h(r)}{h(r)f(r)} = 0. \quad (20)$$

Thus, the formal solutions for the radial and polar components of the action are given by

$$S_r(r, k^2, E, L) = \epsilon \int \sqrt{\left(E - \frac{aL}{r_0 r} \right)^2 - f(r) \left(m^2 + \frac{k^2}{r_0 r} \right)} \frac{dr}{f(r)}, \quad (21)$$

$$S_\theta(\theta, k^2, L) = \epsilon \int \sqrt{k^2 - \frac{L^2}{\sin^2 \theta}} d\theta, \quad (22)$$

where $\epsilon = \pm 1$. Now, using the Hamilton-Jacobi method and making $\frac{\delta S}{\delta k^2} = 0$, $\frac{\delta S}{\delta m^2} = 0$, $\frac{\delta S}{\delta E} = 0$ and $\frac{\delta S}{\delta L} = 0$, we simplify our study to the following quadrature problem

$$\int \frac{d\theta}{\sqrt{k^2 - \frac{L^2}{\sin^2 \theta}}} = \int \frac{dr}{r_0 r \sqrt{\left(E - \frac{aL}{r_0 r}\right)^2 - f(r) \left(m^2 + \frac{k^2}{r_0 r}\right)}}, \quad (23)$$

$$\tau(r) = \epsilon \int \frac{dr}{\sqrt{\left(E - \frac{aL}{r_0 r}\right)^2 - f(r) \left(m^2 + \frac{k^2}{r_0 r}\right)}}, \quad (24)$$

$$t(r) = \epsilon \int \frac{\left(E - \frac{aL}{r_0 r}\right) dr}{f(r) \sqrt{\left(E - \frac{aL}{r_0 r}\right)^2 - f(r) \left(m^2 + \frac{k^2}{r_0 r}\right)}}, \quad (25)$$

$$\varphi(r) = \epsilon \int \frac{\left(E - \frac{aL}{r_0 r}\right) \frac{a}{r_0 r} dr}{\sqrt{\left(E - \frac{aL}{r_0 r}\right)^2 - f(r) \left(m^2 + \frac{k^2}{r_0 r}\right)}} \frac{dr}{f(r)} + \epsilon \int \frac{L}{\sin^2 \theta \sqrt{k^2 - \frac{L^2}{\sin^2 \theta}}} d\theta. \quad (26)$$

Then, by defining the Mino time γ as $d\gamma = d\tau/(r_0 r)$, we can write the equations of motion in terms of the new time parameter, which yields

$$\left(\frac{d\theta}{d\gamma}\right)^2 = k^2 - \frac{L^2}{\sin^2 \theta}, \quad (27)$$

$$\left(\frac{dr}{d\gamma}\right)^2 = r_0^2 r^2 \left(\left(E - \frac{aL}{r_0 r}\right)^2 - f(r) \left(m^2 + \frac{k^2}{r_0 r}\right) \right), \quad (28)$$

$$\frac{d\varphi}{d\gamma} = \left(E - \frac{aL}{r_0 r}\right) \frac{a}{f(r)} + \frac{L}{\sin^2 \theta}, \quad (29)$$

$$\frac{dt}{d\gamma} = \frac{r_0 r \left(E - \frac{aL}{r_0 r}\right)}{f(r)}. \quad (30)$$

In this way we have the equations of motion for our particles moving in the background of linear dilaton black hole. In the next section we will perform an analysis of the equations of motion in the equatorial plane.

IV. GEODESICS IN THE EQUATORIAL PLANE

The Lagrangian associated with the motion in the equatorial plane, that is, $\theta = \pi/2$ and $\dot{\theta} = 0$ results to be:

$$2\mathcal{L} = -\frac{r^2 - 2Mr}{r_0 r} \dot{t}^2 - 2a\dot{t}\dot{\phi} + \frac{r_0 r}{r^2 - 2Mr + a^2} \dot{r}^2 + r_0 r \dot{\phi}^2, \quad (31)$$

where $\dot{q} = dq/d\tau$, and τ is an affine parameter along the geodesic that we choose as the proper time. Since the Lagrangian (31) is independent of the cyclic coordinates (t, ϕ) , then their conjugate momenta (Π_t, Π_ϕ) are conserved. Then, the equations of motion are obtained from $\dot{\Pi}_q - \frac{\partial \mathcal{L}}{\partial q} = 0$, and yield

$$\dot{\Pi}_t = 0, \quad \dot{\Pi}_r = -\frac{\dot{t}^2}{2r_0} - \frac{r_0(r^2 - a^2)\dot{r}^2}{2(r^2 - 2Mr + a^2)^2} + \frac{r_0 \dot{\phi}^2}{2} \quad \text{and} \quad \dot{\Pi}_\phi = 0, \quad (32)$$

where $\Pi_q = \partial \mathcal{L} / \partial \dot{q}$ are the conjugate momenta to the coordinate q , and are given by

$$\Pi_t = -\frac{r^2 - 2Mr}{r_0 r} \dot{t} - a\dot{\phi} \equiv -E, \quad \Pi_r = \frac{r_0 r}{r^2 - 2Mr + a^2} \dot{r} \quad \text{and} \quad \Pi_\phi = -a\dot{t} + r_0 r \dot{\phi} \equiv L, \quad (33)$$

where E and L are dimensionless integration constants associated to each of them. Therefore, the Hamiltonian is given by

$$\mathcal{H} = \Pi_t \dot{t} + \Pi_\phi \dot{\phi} + \Pi_r \dot{r} - \mathcal{L} \quad (34)$$

$$2\mathcal{H} = -E \dot{t} + L \dot{\phi} + \frac{r_0 r}{r^2 - 2Mr + a^2} \dot{r} \equiv -m^2 . \quad (35)$$

Now, by normalization, we shall consider that $m^2 = 1$ for massive particles and $m^2 = 0$ for photons. Therefore, we obtain

$$\dot{\phi} = \frac{r_0 r a E + (r^2 - 2Mr)L}{r_0 r (r^2 - 2Mr + a^2)} , \quad (36)$$

$$\dot{t} = \frac{r_0 r E - aL}{r^2 - 2Mr + a^2} , \quad (37)$$

$$\dot{r}^2 = \left(E - \frac{aL}{r_0 r} \right)^2 - \frac{r^2 - 2Mr + a^2}{r_0 r} \left(m^2 + \frac{L^2}{r_0 r} \right) = (E - V_-)(E - V_+) , \quad (38)$$

where $V_\pm(r)$ is the effective potential and it is given by

$$V_\pm(r) = \frac{aL}{r_0 r} \pm \sqrt{\frac{r^2 - 2Mr + a^2}{r_0 r} \left(m^2 + \frac{L^2}{r_0 r} \right)} . \quad (39)$$

Since the negative branch have no classical interpretation, it is associated with antiparticles in the framework of quantum field theory [41], we choose the positive branch of the effective potential $V = V_+$. In the next section we will perform a general analysis of the equations of motion.

Dragging of inertial frames: In linear dilaton black hole, the presence of $g_{t\phi} \neq 0$ in the metric introduces qualitatively new effects on particle and photon trajectories, like the effect called “dragging of inertial frames”. Thus, by using the equations (36) and (37), we obtain

$$\dot{\phi}/\dot{t} = \frac{d\phi}{dt} = \frac{r_0 a E + (r - 2M)L}{r_0 (r_0 r E - aL)} \equiv \omega(r) . \quad (40)$$

This equation defines $\omega(r)$, the angular velocity of the test particle. Notice that if we consider a zero angular-momentum particle ($L = 0$), the angular velocity of the test particle is given by

$$\omega(r) = \frac{a}{r_0 r} . \quad (41)$$

So, a remarkable result is that a particle dropped “straight in” ($L = 0$) from a finite distance is “dragged” just by the influence of gravity. Therefore, the test particle acquires an angular velocity (ω), with the same sign that a . Also, this effect weakens with distance as $1/r$. It is worth to mention that for the Kerr metric this effect weakens with the distance as $1/r^3$ [42].

Ergoregion: Following a similar treatment given in Ref. [42] for the Kerr geometry, we consider photons emitted in the equatorial plane ($d\theta = 0$) at some given r . In particular, we consider those initially going in the $\pm\phi$ -direction, that is tangent to a circle of constant r , ($dr = 0$). Then, they generally have only dt and $d\phi$ nonzero on the path at first and since $ds^2 = 0$, from the metric (2.9), we have

$$0 = g_{tt} dt^2 - 2a \sin^2 \theta dt d\phi + r_0 r \sin^2 \theta d\phi^2 , \quad (42)$$

where

$$g_{tt} = \frac{r^2 - 2Mr + a^2 \cos^2 \theta}{r_0 r} . \quad (43)$$

Thus, Eq. (42) can be written as

$$0 = g_{tt} - 2a \sin^2 \theta \omega + r_0 r \sin^2 \theta \omega^2 . \quad (44)$$

It is worth to mention that a remarkable effects happens if $g_{tt} = 0$, the two solutions are given by

$$\omega_1 = 0 \quad \text{and} \quad \omega_2 = \frac{2a}{r_0 r} . \quad (45)$$

Notice that the second solution, ω_2 , gives the same sign as the parameter a , and it represents the photon sent off in the same direction as the rotating hole. The other solution, ω_1 , means that the other photon the one sent backwards initially doesn't move at all. The dragging of orbits has become so strong that this photon cannot move in the direction opposite to the rotation. The surface where $g_{tt} = 0$ is called the ergosphere or "static limit", since inside it no particle can remain at fixed r, θ, ϕ , and this occurs at

$$r_e = M + \sqrt{M^2 - a^2 \cos^2 \theta} , \quad (46)$$

being r_e the radius of the ergosphere, which lies outside the horizon (15) and coincides with the event horizon only at the poles $\theta = 0$ and $\theta = \pi$. Inside this radius, since $g_{tt} > 0$, all particles and photons must rotate with the black hole. This result is similar to the Kerr metric [42].

On the other hand, as in the Kerr solution, in the linear dilaton black hole the ergosphere occurs at $g_{tt} = 0$ and the horizon is at $g_{rr} = 0$. The horizon r_+ , is a surface of constant r and t , any surface of constant r and t has an intrinsic metric whose line element comes from Eq. (2.9) with $dt = dr = 0$:

$$ds^2 = r_0 r_+ d\theta^2 + r_0 r_+ \sin^2 \theta d\phi^2 . \quad (47)$$

The proper area of this surface, \mathcal{A} , is given by integrating the square root of the determinant of this metric over all θ and ϕ :

$$\mathcal{A} = \int_0^{2\pi} \int_0^\pi r_0 r \sin \theta d\theta d\phi = 4\pi r_0 r_+ , \quad (48)$$

which is different to the result for the Kerr geometry [42].

A. Time Like Geodesics

In this case ($m = 1$), is adequate to rewrite the effective potential in the following form

$$V(r) = \frac{aL}{r_0 r} + \sqrt{\frac{r^2 - 2Mr + a^2}{r_0 r} \left(1 + \frac{L^2}{r_0 r}\right)} , \quad (49)$$

whose behaviors is given in Fig. 1 for particles with $a > 0$ (direct geodesics) and $a < 0$ (retrograde geodesics), where E corresponds to the energy of the particle, whose trajectory is allow for direct and retrograde geodesics, $E_1 = V(r_+, |a|)$ and $E_2 = V(r_+, -|a|)$. Notice that retrograde geodesics allow trajectories with negative energy with $E > E_2$. However, the behavior of the trajectories are similar in both cases, being bounded orbits with a finite return point R_i , which is given by

$$R_i = \frac{r_0^2 E^2 + 2Mr_0 - L^2}{2r_0} \left(1 + \sqrt{1 + \frac{4r_0(2ML^2 - 2aELr_0 - r_0 a^2)}{(r_0^2 E^2 + 2Mr_0 - L^2)^2}}\right) . \quad (50)$$

This return point for a given energy E is greater for retrograde geodesics than for direct geodesics. Now, in order to obtain the solution for the proper time we integrate Eq. (36), and we obtain

$$\tau(r) = \frac{r_0(F(r) - F(R_i))}{4\sqrt{2ML^2 - 2aELr_0 - r_0 a^2}} , \quad (51)$$

where

$$F(r) = \frac{2\zeta(\Omega)\wp^{-1}[U(r)]}{\wp'(\Omega)} + \frac{1}{\wp'(\Omega)} \ln \left| \frac{\sigma[\wp^{-1}[U(r)] - \Omega]}{\sigma[\wp^{-1}[U(r)] + \Omega]} \right| , \quad (52)$$

being $\wp^{-1}(Y) \equiv \wp^{-1}(Y; g_2, g_3)$ the inverse P-Weierstrass function, $\sigma(Y) \equiv \sigma(Y; g_2, g_3)$ is the sigma Weierstrass function, $\zeta(Y) \equiv \zeta(Y; g_2, g_3)$ is the zeta Weierstrass function, and the Weierstrass invariants are given by

$$g_2 = \frac{1}{12} \left(\frac{r_0^2 E^2 + 2Mr_0 - L^2}{2ML^2 - 2aELr_0 - r_0 a^2} \right)^2 + \frac{1}{4} \left(\frac{r_0}{2ML^2 - 2aELr_0 - r_0 a^2} \right) , \quad (53)$$

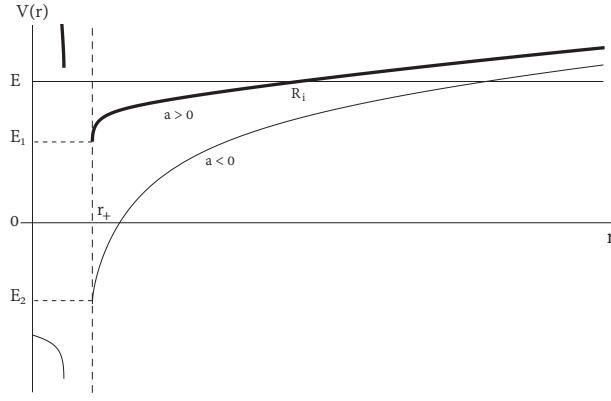

Figure 1. The behavior of the effective potential for massive particles as a function of r , $r_0 = 1$, $M = 2$, $L = 4$ and $|a| = 1.9$.

and

$$g_3 = \frac{-1}{216} \left(\frac{r_0^2 E^2 + 2Mr_0 - L^2}{2ML^2 - 2aELr_0 - r_0 a^2} \right)^3 - \frac{1}{48} \frac{r_0(r_0^2 E^2 + 2Mr_0 - L^2)}{(2ML^2 - 2aELr_0 - r_0 a^2)^2} . \quad (54)$$

Also, the radial function $U = U(r)$ and the constant Ω are given by

$$U(r) = \frac{1}{4r} + \frac{1}{12} \left(\frac{r_0^2 E^2 + 2Mr_0 - L^2}{2ML^2 - 2aELr_0 - r_0 a^2} \right) , \quad (55)$$

and

$$\Omega = \wp^{-1} \left(\frac{1}{12} \left(\frac{r_0^2 E^2 + 2Mr_0 - L^2}{2ML^2 - 2aELr_0 - r_0 a^2} \right) \right) . \quad (56)$$

Now, we consider the solution of the trajectory in the coordinate time in order to compare both times

$$t(r) = -A_+ [F_+(r) - F_+(R_i)] + A_- [F_-(r) - F_-(R_i)] , \quad (57)$$

where

$$F_{\pm}(r) = \frac{2\zeta(\Omega_{\pm})\wp^{-1}[U(r)]}{\wp'(\Omega_{\pm})} + \frac{1}{\wp'(\Omega_{\pm})} \ln \left| \frac{\sigma[\wp^{-1}[U(r)] - \Omega_{\pm}]}{\sigma[\wp^{-1}[U(r)] + \Omega_{\pm}]} \right| , \quad (58)$$

$$\Omega_{\pm} = \wp^{-1} \left[\frac{1}{12} \left(\frac{r_0^2 E^2 + 2Mr_0 - L^2}{2ML^2 - 2aELr_0 - r_0 a^2} \right) + \frac{1}{4r_{\pm}} \right] , \quad (59)$$

$$A_{\pm} = \frac{r_0(r_0 E - aLr_{\pm})}{4(r_+ - r_-)\sqrt{2ML^2 - 2aELr_0 - r_0 a^2}} . \quad (60)$$

Then, in Fig. 5 we plot the proper (τ) and coordinate time (t) as function of r for a particle falling from a finite distance with zero initial velocity, we can see that the particle falls towards the horizon in a finite proper time. The situation is very different if we consider the trajectory in the coordinate time, where t goes to infinity. This physical result is consistent with the Kerr black hole.

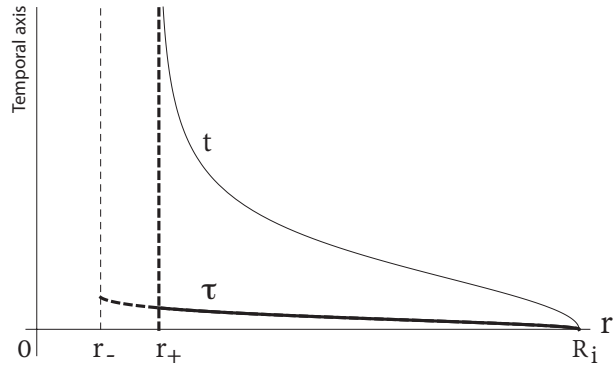

Figure 2. The behavior of the proper (τ) and coordinate (t) time for ingoing particles ($L > 0$) as function of r , with $M = 2$, $a = 1,9$, $L = 4$, and $r_0 = 1$.

The solution for $\phi(r)$ is given by

$$\phi(r) = -B_+ [F_+(r) - F_+(R_i)] + B_- [F_-(r) - F_-(R_i)] \quad (61)$$

with

$$B_{\pm} = \frac{L + r_{\pm}(r_0 a E - 2ML)}{4(r_+ - r_-)\sqrt{2ML^2 - 2aELr_0 - r_0 a^2}}. \quad (62)$$

In Fig. 3 we plot the behavior of $\phi(r)$, and we can observe that a trajectory approaching the horizon will spiral

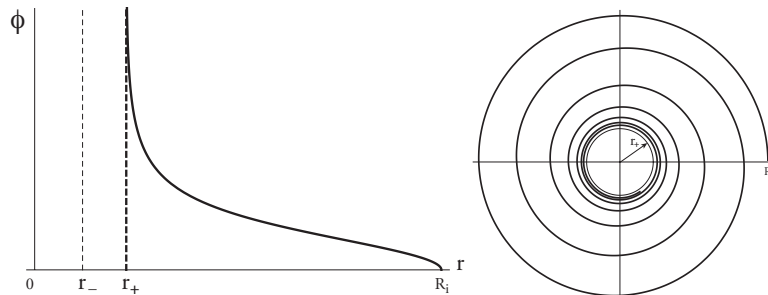

Figure 3. The behavior of $\phi(r)$ for ingoing particles ($L > 0$), with $M = 2$, $a = 1,9$, $L = 4$, and $r_0 = 1$.

round the black hole an infinite number of times such as was observed by Chandrasekhar for the geodesics in the Kerr spacetime [40].

1. Radial Geodesics

In this case ($L = 0$) is adequate to rewrite the effective potential in the following form

$$V(r) = \sqrt{\frac{r^2 - 2Mr + a^2}{r_0 r}}. \quad (63)$$

Notice that the effective potential is the same for direct and retrograde geodesics. The behaviors of the effective potential for massive particles is plotted in Fig 4. The turning point, R_F , can be obtained from Eq. (50) by imposing $L = 0$, and is given by

$$R_F = \frac{r_0 E^2 + 2M}{2} \left(1 + \sqrt{1 - \frac{4a^2}{(r_0 E^2 + 2M)^2}} \right), \quad (64)$$

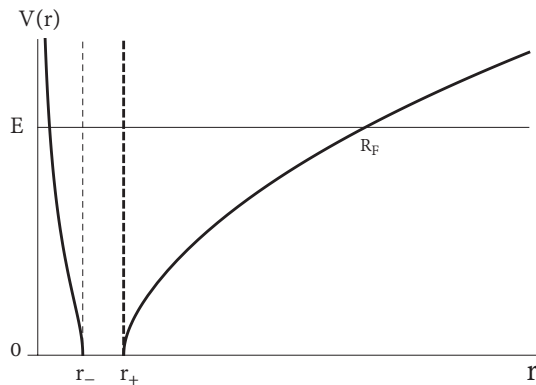

Figure 4. The behavior of the effective potential for massive particles as a function of r , $r_0 = 1$, $M = 2$, $L = 4$, $|a| = 1.9$, $R_F = 10$ and $E = 2.52$.

It is worth to mention that the radial motion allows only bounded orbits, similar to the trajectories with angular momentum. However, we can observe that the energy for particle without angular momentum must be positive ($E > 0$) independently if it is a direct or retrograde geodesics. In contrast to the trajectories with angular momentum where orbits with negative or null energy for retrograde trajectories are possible. On the other hand, the solutions for $\phi(r)$, $\tau(r)$, and $t(r)$ have a similar behavior to the observed for particles with angular momentum due to the effective potential.

B. Null geodesics in the equatorial plane

In this section we analyze the motion of photons, $m^2 = 0$, so the effective potential is given by

$$V(r) = \frac{L}{r_0 r} \left(a + \sqrt{r^2 - 2Mr + a^2} \right), \quad (65)$$

whose behavior is given in Fig. 5 for photons with $a > 0$ (direct null geodesics) and $a < 0$ (retrograde null geodesics), where $E_\infty = L/r_0$ corresponds to the energy of the photon when $r \rightarrow \infty$. $E_+ = V(r_+, |a|)$ and $E_- = V(r_+, -|a|)$. Notice that retrograde null geodesics allow trajectories with negative energy with $E > E_-$. However, in this case, we can distinguish two zones, one of them allows bounded orbits ($E < E_\infty$) and the other one allows unbounded orbits ($E \geq E_\infty$).

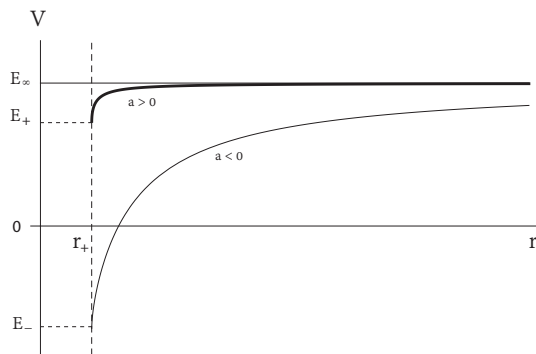

Figure 5. The behavior of the effective potential for photons ($L > 0$) as a function of r , with $r_0 = 1$, $M = 2$, $|a| = 1.9$.

1. *Direct null bounded trajectory*

Now, we consider the direct null bounded trajectory, which is allowed for $E_+ < E < E_\infty$, and the return point of the photon yields

$$r_i = \frac{2L(ML - ar_0E)}{L^2 - r_0^2E^2}. \quad (66)$$

So, choosing the initial conditions for the photons as $r = r_i$ when $\phi = t = \tau = 0$, Eq. (36) and Eq. (37) yields

$$\tau(r) = \frac{r_0}{\sqrt{L^2 - E^2r_0^2}} \left[\sqrt{r_i r - r^2} + r_i \tan^{-1} \sqrt{\frac{r_i}{r} - 1} \right], \quad (67)$$

$$t(r) = A_0 \left[2 \tan^{-1} \sqrt{\frac{r_i}{r} - 1} + A_1 \ln \left[\frac{\sqrt{r(r_i - r_+)} + \sqrt{r_+(r_i - r)}}{\sqrt{r(r_i - r_+)} - \sqrt{r_+(r_i - r)}} \right] \right] + A_0 A_2 \ln \left[\frac{\sqrt{r(r_i - r_-)} + \sqrt{r_-(r_i - r)}}{\sqrt{r(r_i - r_-)} - \sqrt{r_-(r_i - r)}} \right], \quad (68)$$

where, the constants A_0 , A_1 and A_2 are given by

$$A_0 = \frac{r_0^2 E}{\sqrt{L^2 - E^2 r_0^2}}, A_1 = \frac{r_+(r_+ - aL/r_0E)}{(r_+ - r_-)\sqrt{r_+(r_i - r_+)}} , A_2 = \frac{r_-(aL/r_0E - r_-)}{(r_+ - r_-)\sqrt{r_-(r_i - r_-)}} , \quad (69)$$

and Eq. (38) yields

$$\phi(r) = B_0 \left[2 \tan^{-1} \sqrt{\frac{r_i}{r} - 1} + B_1 \ln \left[\frac{\sqrt{r(r_i - r_+)} + \sqrt{r_+(r_i - r)}}{\sqrt{r(r_i - r_+)} - \sqrt{r_+(r_i - r)}} \right] \right] + B_0 B_2 \ln \left[\frac{\sqrt{r(r_i - r_-)} + \sqrt{r_-(r_i - r)}}{\sqrt{r(r_i - r_-)} - \sqrt{r_-(r_i - r)}} \right], \quad (70)$$

and the constants B_0 , B_1 , and B_2 are given by

$$B_0 = \frac{L}{\sqrt{L^2 - E^2 r_0^2}}, B_1 = \frac{r_+(r_+ - 2M + ar_0E/L)}{(r_+ - r_-)\sqrt{r_+(r_i - r_+)}} , B_2 = \frac{r_-(2M - ar_0E/L - r_-)}{(r_+ - r_-)\sqrt{r_-(r_i - r_-)}} . \quad (71)$$

Then, in Fig. 6 we plot the proper (τ) and coordinate time (t) as function of r for a photon falling from a finite distance, we can see that the photon falls towards the horizon in a finite proper time. The situation is very different if we consider the trajectory in the coordinate time, where t goes to infinity. Also, in Fig. 7 we plot the behavior of $\phi(r)$, and we can observe that a trajectory approaching the horizon will spiral round the black hole an infinite number of times.

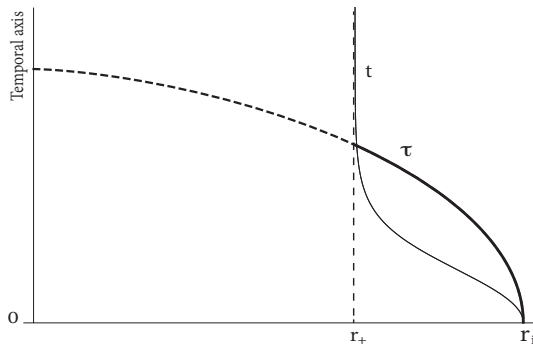

Figure 6. The behavior of the proper (τ) and coordinate (t) time for ingoing photons ($L > 0$) as function of r , with $r_0 = 1$, $M = 2$, $r_i = 4$, and $a = 1.9$.

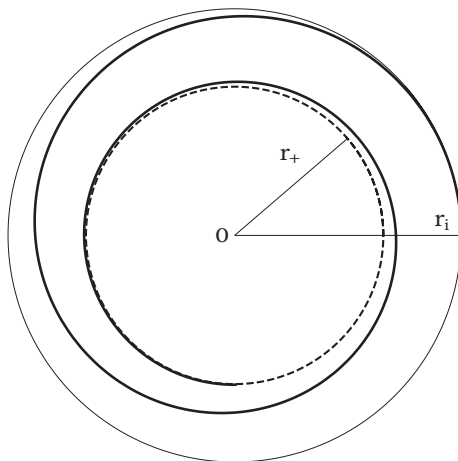

Figure 7. The behavior of $\phi(r)$ for ingoing photons ($L > 0$), with $r_0 = 1$, $M = 2$, $r_i = 4$, and $a = 1.9$.

2. Direct null unbounded trajectory

Photons with energy $E_\infty \leq E$ have not a barrier of potential or turning point. So, the photons can plunge into the horizon or escape to the infinity. In this section, we consider the special case $E = E_\infty = V(\infty) = L/r_0$ by simplicity. Thus, choosing the following initial conditions for the photons: $\phi = t = \tau = 0$, when $r = r_i$, the Eq. (36), Eq. (37) and Eq. (38) yield

$$\tau(r) = \pm \frac{2k_0}{3} \left[r^{3/2} - r_i^{3/2} \right], \quad \text{and} \quad k_0 = \frac{r_0}{L\sqrt{2(M-a)}}. \quad (72)$$

$$t(r) = \pm \frac{k_0 L}{(r_+ - r_-)} \left[(r_+ - a)[T_+(r) - T_+(r_i)] + (a - r_-)[T_-(r) - T_-(r_i)] \right], \quad (73)$$

and

$$\phi(r) = \pm \frac{k_0 L}{r_0(r_+ - r_-)} \left[(r_+ - 2M + a)[T_+(r) - T_+(r_i)] + (2M - a - r_-)[T_-(r) - T_-(r_i)] \right], \quad (74)$$

where

$$T_\pm(r) = 2\sqrt{r} - 2\sqrt{r_\pm} \tanh^{-1} \sqrt{\frac{r}{r_\pm}}. \quad (75)$$

The sign \pm corresponds to trajectories that escape to the infinity or that plunge into the horizon. In section V, we will plot the unbounded trajectories for photons. Notice that from Eq. (72) in the proper frame the photons arrive to the event horizon in a finite proper time.

3. Radial Motion

Radial motion corresponds to a trajectory with null angular momentum $L = 0$, and photons are destined to fall toward the event horizon. From Eq. (39) we can see that for radial photons we have $V(r) = 0$, so that eqs. (37), (38) and (36) in the equatorial plane become

$$\dot{t} = \frac{r_0 r E}{r^2 - 2Mr + a^2}, \quad (76)$$

$$\dot{\phi} = \frac{aE}{(r^2 - 2Mr + a^2)}, \quad (77)$$

$$\pm \dot{r} = E, \quad (78)$$

where the sign $(-)$ corresponds to photons falling into the event horizon and the sign $(+)$ corresponds to photons that escape to infinity. Choosing the initial conditions for the photons as $r = \rho_i$ when $\phi = t = \tau = 0$, Eq. (78) yields

$$\tau(r) = \pm \frac{1}{E}(r - \rho_i), \quad (79)$$

where the sign \pm has the same meaning given previously. Note that the above equation depends on the energy E and it is valid for retrograde and direct geodesics. Also, for the negative sign the photons, in the proper frame, arrive to the event horizon in a finite proper time, see Fig. 8. On the other hand, a straightforward integration of Eq. (76) and (77) leads to

$$t(r) = \pm \frac{r_0}{r_+ - r_-} \left[r_+ \ln \left| \frac{r - r_+}{\rho_i - r_+} \right| - r_- \ln \left| \frac{r - r_-}{\rho_i - r_-} \right| \right], \quad (80)$$

and

$$\phi(r) = \pm \frac{a}{r_+ - r_-} \left[\ln \left| \frac{r - r_+}{\rho_i - r_+} \right| - \ln \left| \frac{r - r_-}{\rho_i - r_-} \right| \right]. \quad (81)$$

Note that the solution for the coordinate time t does not depend on the energy of the photon and the expression is valid for retrograde and direct geodesics. While the solution for ϕ , see Fig. 9, also, it does not depend on the energy of the photon but it depends on the angular momentum parameter a . Moreover, for direct geodesic when $r \rightarrow \infty$

$$\phi_\infty = \frac{a}{r_+ - r_-} \ln \left| \frac{\rho_i - r_-}{\rho_i - r_+} \right|. \quad (82)$$

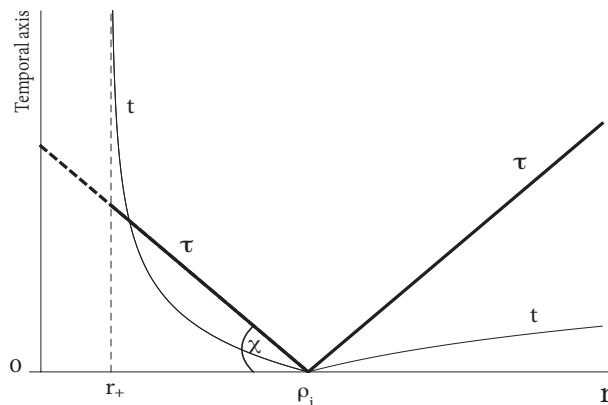

Figure 8. The variation of the coordinate time (t) and the proper time (τ) along an unbounded time-like radial geodesic described by a photon as test particle, starting at $\rho_i = 10$ and falling toward the singularity or going towards infinity, for $M = 2$, $a = 1, 9$, and $r_0 = 1$. Thick line for the proper time and thin line for the coordinate time. The dashed part of the curve inside the horizon has no physical meaning.

It is worth to mention that another remarkable feature of the motion of photons is the existence of circular orbits of any radius. This occurs in the extremal case ($M = a$) and for $L = Er_0$.

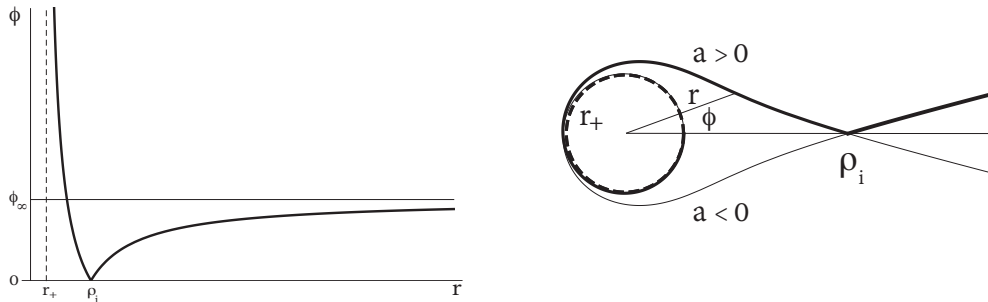

Figure 9. The behavior for $\phi(r)$ for direct and retrograde trajectory starting at $\rho_i = 10$ and falling toward the singularity or going towards infinity, for $M = 2$, $a = 1, 9$, and $r_0 = 1$.

V. THE CM ENERGY OF TWO COLLIDING PARTICLES

In this section we study the CM energy of two colliding massive particles in the equatorial plane $\theta = \pi/2$, the 4-velocity of the test particles is given by $u = (\dot{t}, \dot{r}, 0, \dot{\phi})$, where

$$\dot{t} = \frac{r_0 r E - a L}{r_0 r f(r)}, \quad (83)$$

$$\dot{r}^2 = \left(E - \frac{a L}{r_0 r} \right)^2 - f(r) \left(1 + \frac{L^2}{r_0 r} \right), \quad (84)$$

$$\dot{\phi} = \frac{a E r_0 r + L r_0 r f(r) - a^2 L}{r_0^2 r^2 f(r)}. \quad (85)$$

We will assume that $\dot{t} > 0$ for all $r > r_+$ so that the motion is forward in time outside the horizon, so:

$$r_0 r E - a L > 0, \text{ for all } r > r_+. \quad (86)$$

Now, we use the 4-velocity components to obtain the CM energy of the collision of two particles in the linear dilaton black hole, and we consider that the particles have energies E_1 and E_2 and angular momentum L_1 and L_2 , respectively. Thus, using the relation $E_{CM} = \sqrt{2} m_0 \sqrt{1 - g_{\mu\nu} u_1^\mu u_2^\nu}$, where m_0 denotes the rest mass of the particles, and u_1 and u_2 denotes the 4-velocities of the particles, we obtain

$$\frac{E_{CM}^2}{2m_0^2} = \frac{r_0 r f(r) (r_0 r - L_1 L_2) + (K_1 K_2 - H_1 H_2)}{r_0^2 r^2 f(r)}, \quad (87)$$

where

$$\begin{aligned} K_i &= E_i r_0 r - a L_i, \\ H_i &= \sqrt{(E_i r_0 r - a L_i)^2 - r_0 r f(r) (r_0 r + L_i^2)}, \end{aligned} \quad (88)$$

whit $i = 1, 2$. When the particles arrive to the horizon $r = r_+$, $f(r) \rightarrow 0$, $H_1 \rightarrow \sqrt{K_1^2}$ and $H_2 \rightarrow \sqrt{K_2^2}$, therefore:

$$\frac{E_{CM}^2}{2m_0^2}(r \rightarrow r_+) = \frac{1}{r_0^2 r^2 f(r)} (K_1 K_2 - \sqrt{K_1^2} \sqrt{K_2^2}). \quad (89)$$

Notice that for $K_1 K_2 < 0$ the E_{CM} on the horizon ($f(r) = 0$) is negative infinite which is not a physical solution. However, when $K_1 K_2 > 0$, the numerator of this expression will be zero and the value of E_{CM} will be undetermined. In order to obtain the limiting value we use the L'Hopital rule, and obtain

$$\frac{E_{CM}^2}{2m_0} = \frac{r_0 r_+ (K_1(r_+) + K_2(r_+))^2 + (K_1(r_+) L_2 - K_2(r_+) L_1)^2}{2 r_0 r_+ K_1(r_+) K_2(r_+)}. \quad (90)$$

Note that the numerator of the above expression is finite at the horizon and when $K_i(r_+) = 0$ the CM energy of two colliding particles on the horizon could be arbitrary high $E_{CM}|_{K_i=0} \rightarrow \infty$. From $K_i(r_+) = 0$ we obtain the critical angular momentum:

$$L_{ci} = \frac{r_0 r_+ E_i}{a}, \quad i = 1, 2. \quad (91)$$

Besides, when $K_1(r_+)$ and $K_2(r_+)$ are both zero, then E_{CM} is finite. In this case $H_1(r_+) = H_2(r_+) = 0$ and

$$\frac{E_{CM}^2}{2m_0} = 1 - \frac{L_1 L_2}{r_0 r_+}. \quad (92)$$

Therefore, in order to obtain infinite CM energy only one of the colliding particles must have the critical angular momentum.

By a similar analysis, it is possible to evaluate the E_{CM} on the inner horizon, finding that this is also infinite as long as one of the two particles has the following critical angular momentum:

$$L_{ci} = \frac{r_0 r_- E_i}{a}, \quad i = 1, 2. \quad (93)$$

Now, in order to see if a particle with critical angular momentum could reach the horizon, we shall analyze the radial motion of the particle with critical angular momentum and energy E , and we shall find the region where it can exist. The radial equation can be written as

$$\dot{r}^2 = R(r), \quad (94)$$

where

$$\begin{aligned} R(r) &= \left(E - \frac{aL}{r_0 r} \right)^2 - f(r) \left(1 + \frac{L^2}{r_0 r} \right) \\ &= -\frac{r}{r_0} + \frac{2ML^2 - r_0 a^2 - 2r_0 aEL}{r_0^2 r} + \frac{-L^2 + 2r_0 M + r_0^2 E^2}{r_0^2}. \end{aligned} \quad (95)$$

Note that the particle can exist only in regions where $R(r) \geq 0$. Also, note that at the horizon $R(r_+) \geq 0$ and $R(r_+) = 0$ for a particle with the critical momentum $L_c = r_0 r_+ E/a$. Therefore, from expression (95) we find that if $2ML^2 - r_0 a^2 - 2r_0 aEL > 0$ the radial function has the following asymptotic behaviors $R(r \rightarrow \infty) \rightarrow -\infty$ and $R(r \rightarrow 0) \rightarrow \infty$, so the function $R(r)$ has only one positive root, say r_*^+ ; thus, the particle can exist only in the region $0 < r < r_*$. On the other hand, if $2ML^2 - r_0 a^2 - 2r_0 aEL < 0$, we find $R(r \rightarrow \infty) \rightarrow -\infty$ and $R(r \rightarrow 0) \rightarrow -\infty$, so the function $R(r)$ has two positive roots, and the particle can exist in the region between the roots. The roots of $R(r)$ are given by:

$$r_*^\pm = \frac{E^2 r_0^2 + 2Mr_0 - L^2 \pm \sqrt{8r_0 ML^2 - 4a^2 r_0^2 - 8a r_0^2 LE + (E^2 r_0^2 + 2Mr_0 - L^2)^2}}{2r_0}. \quad (96)$$

For a particle with the critical angular momentum, the radial function is given by:

$$R^c = R(r)|_{L=L_c} = \frac{r - r_+}{r} \left(-\frac{r - r_-}{r_0} + \frac{E^2 (a^2 - r_+^2)}{a^2} \right), \quad (97)$$

and it vanishes on the event horizon, to simplify the above equation we have used $r_+ r_- = a^2$.

The roots of the radial function $R(r)|_{L=L_c}$ are given by:

$$\begin{aligned} r_1 &= r_+ \\ r_2 &= r_- + \frac{r_0 E^2 (a^2 - r_+^2)}{a^2}. \end{aligned} \quad (98)$$

Particles with critical angular momentum can reach the event horizon if

$$\left. \frac{dR^c}{dr} \right|_{r=r_+} > 0. \quad (99)$$

For the linear dilaton black hole we obtain

$$\left. \frac{dR^c}{dr} \right|_{r=r_+} = -\frac{(r_+ - r_-)(1 + r_0 r_+ E^2/a^2)}{r_0 r_+} < 0, \quad (100)$$

therefore, if particles with critical angular momentum exist outside the black hole, they cannot reach the event horizon. In Fig. 12 we plot the behavior of R^c as a function of r for the non-extremal linear dilaton black hole. Notice that if $\left. \frac{d^2 R^c}{dr^2} \right|_{r=r_+} = 2 \left(\frac{E^2}{a^2} - \frac{E^2}{r_+^2} - \frac{r_-}{r_0 r_+^2} \right) < 0$, then r_2 is positive and smaller than r_- and if $\left. \frac{d^2 R^c}{dr^2} \right|_{r=r_+} = 2 \left(\frac{E^2}{a^2} - \frac{E^2}{r_+^2} - \frac{r_-}{r_0 r_+^2} \right) > 0$, then r_2 is negative; therefore, particles with critical angular momentum cannot exist outside the event horizon.

On the other hand, we notice that the particle with the critical angular momentum can exist inside the event horizon r_+ . This can be shown by replacing the critical angular momentum Eq. (93) in the square of the radial component of the 4-velocity Eq. (84), obtaining the analog of Eq. (97), whose derivative evaluated on the internal horizon r_- is positive $\left. \frac{dR^c}{dr} \right|_{r=r_-} > 0$; therefore, the particle with critical angular momentum can reach the inner horizon and the CM energy can be arbitrarily high, with the BSW process being possible on the inner horizon. This behavior is similar to the rotating BTZ black hole [44–46]. In Table I we show the behavior of the CM energy on the inner horizon as a function of the angular momentum L_1 of a particle, we observe that when L_1 approaches to the critical angular momentum $L_c = \frac{r_0 r_- E}{a}$, the CM energy increases and tends to infinity when $L_1 \rightarrow L_c$. Also, in table II we show the critical angular momentum $L_c = \frac{E_1 r_0 r_-}{a}$ and $e^{-2\phi}(r)$ for different values of r_0 . Notice that in the equatorial plane the string coupling depends on r_0 and it does not depend on a . We also observe that when the coupling r_0 is increasing, the string coupling becomes stronger and this leads to a higher value of the critical angular momentum. Thus, a strong string coupling requires the particle to have a high angular momentum in the collision process in order the rotating linear dilaton black hole to act as a particle accelerator.

Table I. The behavior of $\frac{E_{CM}^2}{2m_0}$ as a function of L_1 for $a = 1.9$, $M = 2$, $r_0 = 1$, $E_1 = 1$, $E_2 = 2$ and $L_2 = 3$. The critical angular momentum is given by $L_c = \frac{E_1 r_0 r_-}{a} = 0.723947$.

L_1	$\frac{E_{CM}^2}{2m_0}$	L_1	$\frac{E_{CM}^2}{2m_0}$
5.0	3.97	0.73	177.32
4.0	3.23	0.729	212.36
3.0	2.56	0.728	264.71
2.0	2.12	0.727	351.34
1.0	4.34	0.726	522.40
0.9	6.47	0.725	1018.50
0.8	14.39	0.724	20404.30
0.75	41.40	0.72395	424247.95
0.74	67.02	0.723948	$2.03 \cdot 10^6$

Table II. Critical angular momentum $L_c = \frac{E_1 r_0 r_-}{a}$ and $e^{-2\phi}(r)$ for different values of r_0 , for $a = 1.9$, $M = 2$, and $E_1 = 1$.

r_0	$e^{-2\phi}(r)$	L_c
0.5	$\frac{1}{2r}$	0.263
1.0	$\frac{1}{r}$	0.526
1.5	$\frac{3}{2r}$	0.789
2.0	$2r$	1.053

On the other hand, in the extremal case, the function $R^c(r)$ for a particle with critical angular momentum reads:

$$R^c(r) = -\frac{(r - M)^2}{r_0 r}. \quad (101)$$

So, the function $R^c(r)$ is null for $r = r_+ = M$, which is the degenerate horizon of the extremal black hole. Notice that the particle with critical angular momentum cannot exist outside the event horizon; however, it can exist on the degenerate horizon, which is similar to the behavior for the extremal BTZ black hole [44–46].

Now, in order to illustrate these behaviors, we show some graphics. In Fig. 10 we have plotted the behavior of $f(r)$ and $R(r)$ for $a = 1.9$, $M = 2$, $r_0 = 1$, $E = 1$ and $L = 10$, and in Fig. 11 we have plotted the behavior of

$f(r)$ and $R(r)$ for $a = 1.9$, $M = 2$, $r_0 = 1$, $E = 1$ and $L = 0.1$. In Figs. 12 and 13 we show the behavior of $R^c(r)$ for a particle with critical angular momentum in the non-extremal and in the extremal case, respectively. One root of $R^c(r)$ coincide with the horizon in the non-extremal case. This means that the particle with the critical angular momentum can exist inside the outer horizon and the particle collision on the inner horizon could produce arbitrarily high CM energy. In the extremal case the roots of $R^c(r)$ coincide with the degenerate horizon, so, particles with critical angular momentum can only exist on the degenerate horizon.

In Fig. 14 we have plotted the behavior of E_{CM} as a function of L_1 , with $a = 1.9$, $M = 2$, $r_0 = 1$, $E_1 = 1$, $E_2 = 2$ and $L_3 = 3$. We see that in order to get infinite CM energy, particle 1 reach the critical angular momentum as shown in Figs. 14 and 15.

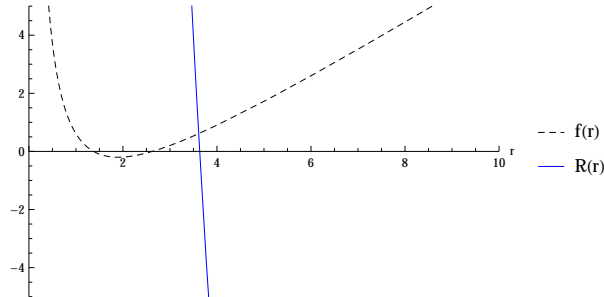

Figure 10. The behavior of $f(r)$ and $R(r)$ for $a = 1.9$, $M = 2$, $r_0 = 1$, $E = 1$ and $L = 10$.

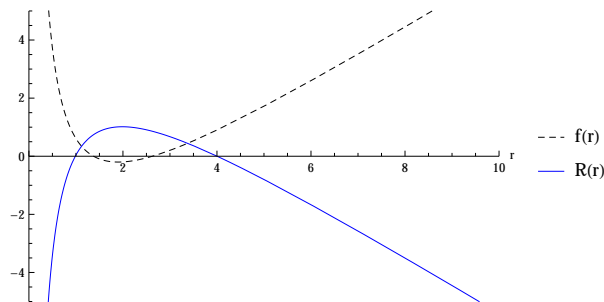

Figure 11. The behavior of $f(r)$ and $R(r)$ for $a = 1.9$, $M = 2$, $r_0 = 1$, $E = 1$ and $L = 0.1$.

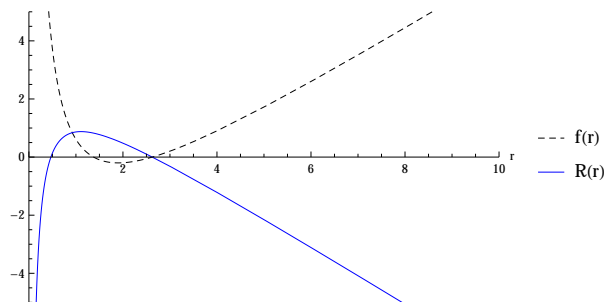

Figure 12. The behavior of $f(r)$ and $R(r)$ for $a = 1.9$, $M = 2$, $r_0 = 1$, $E = 1$ and $L = L_c$.

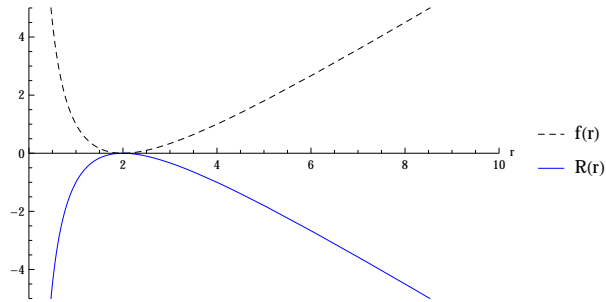

Figure 13. The behavior of $f(r)$ and $R(r)$ for $a = 2$, $M = 2$, $r_0 = 1$, $E = 1$ and $L = L_c$.

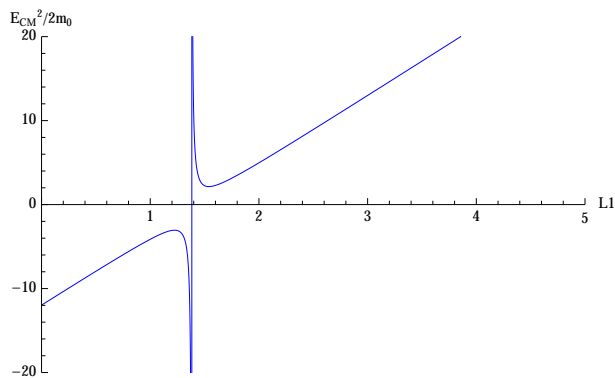

Figure 14. The behavior of E_{CM} as a function of L_1 , for $a = 1.9$, $M = 2$, $r_0 = 1$, $E_1 = 1$, $E_2 = 2$ and $L_2 = 3$.

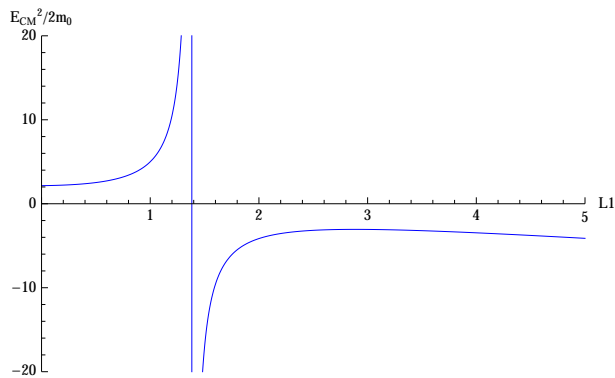

Figure 15. The behavior of E_{CM} as a function of L_1 , for $a = 1.9$, $M = 2$, $r_0 = 1$, $E_1 = 1$, $E_2 = 2$ and $L_2 = 0.5$.

VI. THE GENERAL EQUATIONS OF GEODESIC MOTION

In this section we solve analytically the geodesic equations of motion of the test particle for the radial, temporal and orbital motion.

A. Analysis of the angular motion (θ -motion)

In order to study the θ -motion, we consider the equation of motion (27), which can be rewritten as $d\theta/d\gamma = \sqrt{\Theta}$, where the coordinate θ is a polar angle that can take only positive values. So

$$\Theta = k^2 - \frac{L^2}{\sin^2 \theta} \geq 0, \quad (102)$$

where the separability constant is non null or negative. Now, through the change of variables $\xi = \cos \theta$, Eq. (27) yields

$$\frac{d\xi}{d\gamma} = -\sqrt{\Theta_\xi}, \quad (103)$$

being $\Theta_\xi = k^2(1 - \xi^2) - L^2$. The roots of the function Θ_ξ are given by

$$\theta_1 = \arccos\left(\sqrt{1 - \frac{L^2}{k^2}}\right), \quad \theta_2 = \arccos\left(-\sqrt{1 - \frac{L^2}{k^2}}\right), \quad (104)$$

which define the cone's angles that confine the movement of the particle. Integrating (103) we get

$$\gamma(\xi) = - \int \frac{d\xi}{\sqrt{k^2(1 - \xi^2) - L^2}}. \quad (105)$$

The solution, in terms of the variable θ is:

$$\gamma(\theta) = \frac{1}{\sqrt{k^2}} \arccos\left(\frac{\cos \theta}{\sqrt{1 - \frac{L^2}{k^2}}}\right), \quad (106)$$

where we have used that $\gamma_0 = 0$ for $\theta_0 = \theta_1$. Also, the above equation can be inverted, which yields

$$\theta(\gamma) = \arccos\left(\sqrt{1 - \frac{L^2}{k^2}} \cos(\sqrt{k^2}\gamma)\right), \quad (107)$$

for $k^2 > L^2$.

B. Analysis of the radial motion (r -motion)

Now, we consider the motion of the particle with respect to the r -coordinate. We will focus in Eq. (28) in order to obtain the velocity of the particle dr/dt . The condition of turning point $(\frac{dr}{dt})_{r=r_t} = 0$ allows us to define an effective potential

$$\left(E - \frac{aL}{r_0 r}\right)^2 - f(r) \left(m^2 + \frac{k^2}{r_0 r}\right) = (E - V_-)(E - V_+), \quad (108)$$

where we can recognize the effective potential for the particle with mass m as

$$V_\pm = \frac{aL}{r_0 r} \pm \sqrt{f(r) \left(m^2 + \frac{k^2}{r_0 r}\right)}. \quad (109)$$

The behavior of the effective potential is shown in Fig. 1. In the following sections, we will consider the motion of particles $m \neq 0$ and the motion of photons $m = 0$ separately.

1. *Radial motion of particles*

Now, Eq. (28) can be written as:

$$\left(\frac{dr}{d\gamma}\right)^2 = P(r), \quad (110)$$

where $P(r) = -a_3 r^3 + a_2 r^2 + a_1 r + a_0$, with

$$a_0 = -a^2(k^2 - L^2), \quad a_1 = 2k^2 M - 2aELr_0 - a^2 m^2 r_0, \quad a_2 = -k^2 + 2m^2 M r_0 + E^2 r_0^2, \quad a_3 = m^2 r_0 > 0. \quad (111)$$

Integrating the above equation, where r_1 corresponds to the starting point, we obtain

$$\int_{\gamma_i=0}^{\gamma} d\gamma = \frac{1}{\sqrt{a_3}} \int_{r_1}^r \frac{-dr}{\sqrt{P(r)/a_3}}, \quad (112)$$

with the change of variable $r = -4x + \frac{a_2}{3a_3}$, the integral transform to

$$\gamma(r) = \frac{1}{\sqrt{a_3}} \int_{x_1}^x \frac{dx}{\sqrt{4x^3 - g_2 x - g_3}}, \quad (113)$$

where $r_1 = -4x_1 + \frac{a_2}{3a_3}$. The invariants are:

$$g_2 = \frac{1}{a_3} \left(\frac{a_2^2}{3a_3} + a_1 \right), \quad g_3 = -\frac{1}{16a_3} \left(a_0 + \frac{2a_2^3}{27a_3^2} + \frac{a_1 a_2}{3a_3} \right), \quad (114)$$

$$\gamma = \frac{1}{\sqrt{a_3}} \left(\wp^{-1}(x; g_2, g_3) - \varphi_1 \right), \quad (115)$$

being $\varphi_1 = \wp^{-1}(x_1; g_2, g_3)$. Inverting this expression, we obtain:

$$r(\gamma) = \frac{a_2}{3a_3} - 4\wp(\sqrt{a_3}\gamma + \varphi_1; g_2, g_3). \quad (116)$$

2. *Bounded radial motion of photons*

For photons falling from ρ_1 ,

$$\int_0^{\gamma} d\gamma = \frac{1}{\sqrt{b_2}} \int_{\rho_1}^r \frac{-dr}{\sqrt{P_2(r)/b_2}}, \quad (117)$$

where $P_2(r) = -b_2 r^2 + b_1 r - b_0$, being

$$b_0 = a^2(k^2 - L^2), \quad b_1 = 2k^2 M - 2aELr_0, \quad b_2 = k^2 - E^2 r_0^2, \quad b_4 = b_1^2 - 4b_0 b_2, \quad (118)$$

$$\gamma = \frac{1}{\sqrt{b_2}} \left(\arcsin \left(\frac{b_1 - 2b_2 r}{\sqrt{b_4}} \right) - \varphi_2 \right), \quad (119)$$

with $\varphi_2 = \arcsin \left(\frac{b_1 - 2b_2 \rho_1}{\sqrt{b_4}} \right)$. Inverting this expression, we obtain:

$$r(\gamma) = \frac{b_1}{2b_2} - \frac{\sqrt{b_4}}{2b_2} \sin \left(\sqrt{b_2} \gamma + \varphi_2 \right). \quad (120)$$

3. Unbounded radial motion of photons

In this case we will consider $E = k/r_0$ and the solution is given by

$$r(\gamma) = \frac{b_0}{c_1} + \frac{1}{c_1} \left(\varphi_3 \pm \frac{c_1}{2} \gamma \right)^2, \quad (121)$$

where $c_1 = 2k(Mk - aL)$, $\varphi_3 = \sqrt{c_1 \rho_1 - b_0}$, and the sign (+) corresponds to photons that escape to infinity and the sign (-), for photons that fall into the horizon.

C. Analysis of the angular motion (φ -motion)

From Eq. (26) is possible to distinguish an integral in the radial part and the second one in the angular θ part. So the solution can be written as $\varphi = \varphi^m(r) + \varphi(\theta)$. The solution of the angular integral is given by

$$\varphi(\theta) = \frac{\pi}{2} + \frac{1}{2} \arcsin \left[\frac{\cos^2 \theta_1 - \cos \theta}{\cos \theta_1 (1 - \cos \theta)} \right] - \frac{1}{2} \arcsin \left[\frac{\cos^2 \theta_1 + \cos \theta}{\cos \theta_1 (1 + \cos \theta)} \right], \quad (122)$$

and for particles the radial integral is given by

$$\varphi^{m=1}(r) = \frac{a\sqrt{r_0}E}{4m(r_+ - r_-)} \left[\left(r_+ - \frac{aL}{r_0 E} \right) (\bar{F}_+(u_1) - \bar{F}_+(u)) - \left(r_- - \frac{aL}{r_0 E} \right) (\bar{F}_-(u_1) - \bar{F}_-(u)) \right], \quad (123)$$

where

$$\bar{F}_\pm(r) = \frac{2\zeta(W_\pm)\wp^{-1}[u(r)]}{\wp'(W_\pm)} + \frac{1}{\wp'(W_\pm)} \ln \left| \frac{\sigma[\wp^{-1}[u(r)] - W_\pm]}{\sigma[\wp^{-1}[u(r)] + W_\pm]} \right|, \quad (124)$$

$$u(r) = \frac{a_2}{12a_3} - \frac{r}{4}, \quad (125)$$

$u_1 = u(r_1)$ and

$$W_\pm = \wp^{-1} \left[\frac{a_2}{12a_3} - \frac{r_\pm}{4} \right]. \quad (126)$$

On the other hand, for bounded photons the solution is:

$$\varphi^{m=0}(r) = \frac{ar_0E}{\sqrt{b_2}(r_+ - r_-)} \left[\left(r_+ - \frac{aL}{r_0 E} \right) (\bar{G}_+(r) - \bar{G}_+(\rho_1)) - \left(r_- - \frac{aL}{r_0 E} \right) (\bar{G}_-(r) - \bar{G}_-(\rho_1)) \right], \quad (127)$$

being

$$\bar{G}_\pm(r) = + \frac{1}{\sqrt{\gamma_\pm}} \cosh^{-1} \left| \frac{2\gamma_\pm + \delta_\pm(r - r_\pm)}{(r - r_\pm)\sqrt{4\gamma_\pm + \delta_\pm^2}} \right|, \quad (128)$$

and

$$\gamma_\pm = \frac{b_1}{b_2} r_\pm - \frac{b_0}{b_2} - r_\pm^2,$$

$$\delta_\pm = \frac{b_0}{b_2} - 2r_\pm.$$

While that for unbounded photons the solution is

$$\varphi^{(0)}(r) = \frac{ar_0E}{(r_+ - r_-)} \left[\left(r_+ - \frac{aL}{r_0 E} \right) (\bar{J}_+(r) - \bar{J}_+(\rho_1)) - \left(r_- - \frac{aL}{r_0 E} \right) (\bar{J}_-(r) - \bar{J}_-(\rho_1)) \right], \quad (129)$$

where

$$\bar{J}_\pm(r) = \frac{2}{\sqrt{b_0 - c_1 r_\pm}} \tan^{-1} \left| \frac{\sqrt{c_1 r - b_0}}{\sqrt{b_0 - c_1 r_\pm}} \right|. \quad (130)$$

D. Analysis of the time motion (t -motion)

The solution for t -motion of particles is given by the following expression

$$t^{(m=1)}(r) = \frac{a\sqrt{r_0}E}{r_-} \left[\wp^{-1}(u) - \wp^{-1}(u_A) + \frac{r_+}{4} [\bar{F}_+(u_A) - \bar{F}_+(u)] \right], \quad (131)$$

where we have considered by simplicity that the energy of the particle is $E_A = V(r_-) = V(R_A) = aL/r_0r_-$, being R_A the turning point or Apoastro, and $u_A = u(R_A)$. On the other hand, the solution for t -motion of bounded photons yields

$$t^{(m=0)}(r) = \frac{ar_0E}{r_- \sqrt{b_2}} \left[\arcsin \left(\frac{b_1 - 2b_2 r}{\sqrt{b_4}} \right) - \arcsin \left(\frac{b_1 - 2b_2 \rho_A}{\sqrt{b_4}} \right) + \frac{r_+}{\sqrt{\gamma_+}} [\bar{G}_+(r) - \bar{G}_+(\rho_A)] \right], \quad (132)$$

where we have considered by simplicity that the energy of the photon is $E_A = V(r_-) = V(\rho_A) = aL/r_0r_-$, being ρ_A the turning point or Apoastro. While that for unbounded photons the solution of t -motion is given by

$$t^{(0)}(r) = \pm \frac{ar_0E}{r_-} \left[\frac{2}{c_1} [\sqrt{c_1 r - b_0} - \sqrt{c_1 \rho_A - b_0}] + r_+ [\bar{J}_+(r) - \bar{J}_+(\rho_A)] \right], \quad (133)$$

where we have considered by simplicity that the energy of the photon is $E_A = V(r_-) = V(\rho_A) = aL/r_0r_-$, and $k = aL/r_-$. Being, ρ_A the starting point of the trajectory.

Now, in order to show the trajectory for particles and photons, we plot in Fig. 16 the trajectory of a particle that fall to the black hole (left figure) and the motion in the r - θ plane (right figure). Then, in Fig. 17 we plot the trajectory of a photon that fall to the black hole (left figure) and the motion in the r - θ plane (right figure). Finally, in Fig. 18 we plot the trajectory of a photon that escape to the infinity (left figure) and the motion in the r - θ plane (right figure).

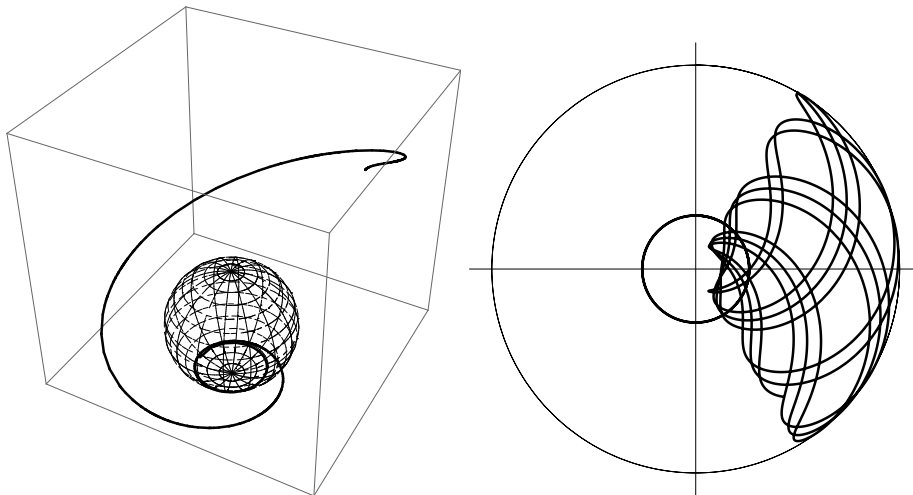

Figure 16. Trajectory for a particle that fall to the horizon. Left figure for three-dimensional motion, and right figure is the motion in the r - θ plane, for $a = 1.9$, $M = 2$, $r_0 = 1$, $r_1 = 10$, $k = 4$ and $L = 2$.

VII. SUMMARY

In this paper we studied the motion of particles in a linear dilaton black hole background. We analyzed the motion of particles in the equatorial plane as well as in four dimensions analytically. Mainly, a qualitative analysis of the effective potential for null geodesics, shows that photons plunge into the horizon or escape to infinity, they are not deflected. The study for massive particles shows that there are not confined orbits of first kind, like planetary or circular orbit. Therefore, the r -motion is not periodic, and it is not possible to define the orbital frequencies Ω_r , Ω_θ and Ω_ϕ , that determine the perihelion shift and the Lense-Thirring effects, which are defined as differences between

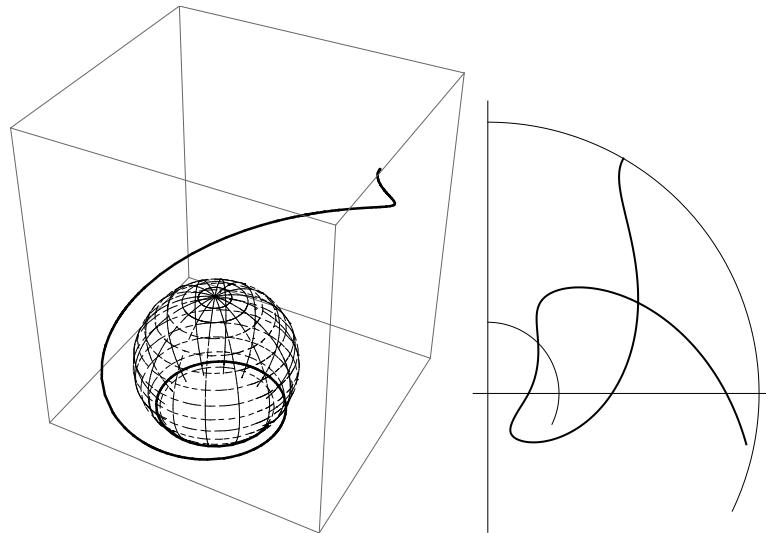

Figure 17. Trajectory for a photon that fall to the horizon. Left figure for three-dimensional motion, and right figure is the projection of the orbit onto the x-z plane, for $a = 1.9$, $M = 2$, $r_0 = 1$, $\rho_1 = 10$, $k = 4$, and $L = 2$

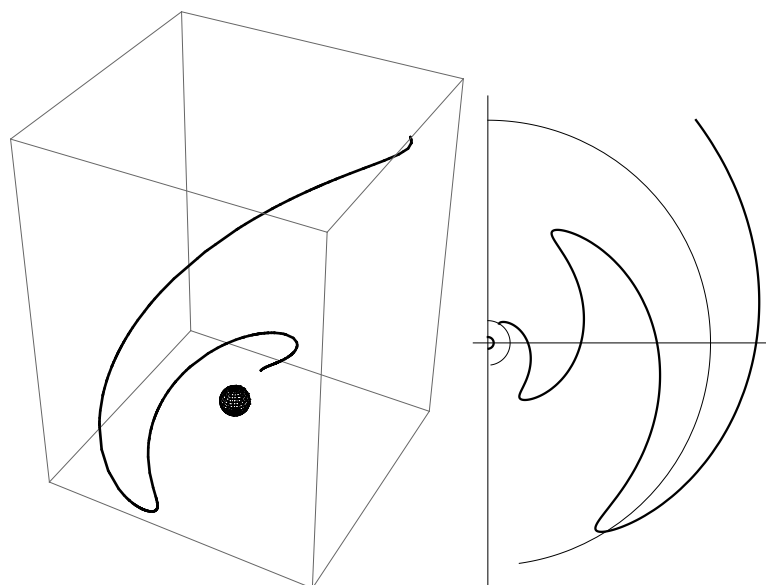

Figure 18. Trajectory for a photon that escape to infinity. Left figure for three-dimensional motion, and right figure is the projection of the orbit onto the x-z plane, for $a = 1.9$, $M = 2$, $k = 4$, $L = 10$, and $\rho_1 = 10$.

these orbital frequencies. Now, considering the θ -motion, we observe that the polar coordinate is confined to oscillate between θ_1 and θ_2 . The θ -motion is periodic with a period

$$\omega_\theta = 2\gamma(\theta_2) = \frac{2\pi}{k}, \quad (134)$$

and the corresponding frequency is $2\pi/\omega_\theta$. The secular accumulation rates of the angle ϕ is given by:

$$Y_\phi^{(m)} = \frac{2}{\omega_\theta} \phi(\theta_2) = \frac{2}{\omega_\theta} [\varphi^m(\theta_2) + \varphi(\theta_2)] = \frac{k}{\pi} [\varphi^m(\theta_2) + \pi], \quad (135)$$

where $\varphi^m(\theta_2) = \varphi^m[r^m(\frac{\pi}{k})]$, and $\gamma(\theta_2) = \frac{\pi}{k}$. The secular accumulation rates of the angle ϕ is different for particles and photons. It is worth to mention that another remarkable feature of the motion of photons is the existence of circular orbits of any radius. This occurs in the extremal case ($M = a$) and for $L = Er_0$.

Also, we analyzed the collision of particles near the horizon and we studied the possibility that the dilaton black hole acts as a particle accelerator. We found that when one of the particles with critical angular momentum, which exists inside the outer horizon, collides with another particle, it can produce an arbitrarily high CM energy, in the non-extremal case. For the extremal case, we have found that the particles with critical angular momentum can only exist on the degenerate horizon. The above arguments show that the motion and collision of particles in the linear dilaton black hole has a similar behavior to the observed for the motion and collision of particles in the BTZ black hole [43–46]. Also, we showed that in the equatorial plane the string coupling depends on r_0 and it does not depend on a . Then we observed that when the coupling r_0 is increasing, the string coupling becomes stronger and this leads to a higher value of the critical angular momentum. Thus, a strong string coupling requires the particle to have a high angular momentum in the collision process in order the rotating linear dilaton black hole to act as a particle accelerator.

ACKNOWLEDGMENTS

This work was partially funded by the Comisión Nacional de Ciencias y Tecnología through FONDECYT Grant 11140674 (PAG) and by the Dirección de Investigación y Desarrollo de la Universidad de La Serena (Y.V.). P. A. G. acknowledges the hospitality of the Universidad de La Serena and National Technical University of Athens and E. P. and Y. V. acknowledge the hospitality of the Universidad Diego Portales where part of this work was carried out.

-
- [1] G. W. Gibbons and K. i. Maeda, “Black Holes and Membranes in Higher Dimensional Theories with Dilaton Fields,” Nucl. Phys. B **298**, 741 (1988).
- [2] D. Garfinkle, G. T. Horowitz and A. Strominger, “Charged black holes in string theory,” Phys. Rev. D **43**, 3140 (1991) Erratum: [Phys. Rev. D **45**, 3888 (1992)].
- [3] A. Sen, “Rotating charged black hole solution in heterotic string theory,” Phys. Rev. Lett. **69**, 1006 (1992) [hep-th/9204046].
- [4] A. Sen, “Black hole solutions in heterotic string theory on a torus,” Nucl. Phys. B **440**, 421 (1995) [hep-th/9411187].
- [5] S. F. Hassan and A. Sen, “Twisting classical solutions in heterotic string theory,” Nucl. Phys. B **375**, 103 (1992) [hep-th/9109038].
- [6] R. R. Khuri, “Solitons, black holes and duality in string theory,” Nucl. Phys. Proc. Suppl. **61A**, 99 (1998) [hep-th/9704110].
- [7] C. J. Gao and S. N. Zhang, “Topological black holes in dilaton gravity theory,” Phys. Lett. B **612**, 127 (2005).
- [8] G. Clement, D. Gal’tsov and C. Leygnac, “Linear dilaton black holes,” Phys. Rev. D **67**, 024012 (2003) [hep-th/0208225].
- [9] I. Sakalli, “Analytical solutions in rotating linear dilaton black holes: resonant frequencies, quantization, greybody factor, and Hawking radiation,” Phys. Rev. D **94**, no. 8, 084040 (2016) [arXiv:1606.00896 [gr-qc]].
- [10] I. Sakalli and G. Tokgoz, “Stationary Scalar Clouds Around Maximally Rotating Linear Dilaton Black Holes,” Class. Quant. Grav. **34**, no. 12, 125007 (2017) [arXiv:1610.09329 [gr-qc]].
- [11] S. W. Hawking and H. S. Reall, “Charged and rotating AdS black holes and their CFT duals,” Phys. Rev. D **61**, 024014 (2000) [hep-th/9908109].
- [12] R. Li, “Analytical studies of Hawking radiation and quasinormal modes in rotating linear dilatonic black hole,” Eur. Phys. J. C **73**, no. 2, 2296 (2013) [arXiv:1204.6405 [hep-th]].
- [13] S. Fernando, “Null Geodesics of Charged Black Holes in String Theory,” Phys. Rev. D **85**, 024033 (2012) [arXiv:1109.0254 [hep-th]].
- [14] S. Soroushfar, R. Saffari and E. Sahami, “Geodesic equations in the static and rotating dilaton black holes: Analytical solutions and applications,” Phys. Rev. D **94** (2016) no.2, 024010 [arXiv:1601.03143 [gr-qc]].
- [15] T. Maki and K. Shiraishi, “Motion of test particles around a charged dilatonic black hole,” Class. Quant. Grav. **11**, 227 (1994) [arXiv:1707.05463 [gr-qc]].
- [16] M. Olivares and J. R. Villanueva, “Massive neutral particles on heterotic string theory,” Eur. Phys. J. C **73**, 2659 (2013) [arXiv:1311.4236 [gr-qc]].
- [17] C. Blaga, “Circular time-like geodesics around a charged spherically symmetric dilaton black hole,” Applications Math. **22**, 41 (2013) [arXiv:1406.7421 [gr-qc]].
- [18] C. Blaga, “Timelike geodesics around a charged spherically symmetric dilaton black hole,” Serb. Astron. J. **190**, 41 (2015) [arXiv:1407.1504 [gr-qc]].
- [19] J. R. Villanueva and M. Olivares, “Gravitational Rutherford scattering and Keplerian orbits for electrically charged bodies in heterotic string theory,” Eur. Phys. J. C **75**, no. 11, 562 (2015) [arXiv:1510.08340 [gr-qc]].
- [20] P. A. Gonzalez, M. Olivares, E. Papantonopoulos, J. Saavedra and Y. Vasquez, “Motion of magnetically charged particles in a magnetically charged stringy black hole spacetime,” Phys. Rev. D **95**, no. 10, 104052 (2017) [arXiv:1703.04840 [gr-qc]].
- [21] M. Bañados, J. Silk and S. M. West, “Kerr Black Holes as Particle Accelerators to Arbitrarily High Energy,” Phys. Rev. Lett. **103**, 111102 (2009) [arXiv:0909.0169 [hep-ph]].
- [22] A. A. Grib and Y. V. Pavlov, “Particles with negative energies in black holes,” Int. J. Mod. Phys. D **20**, 675 (2011) [arXiv:1008.3657 [gr-qc]].
- [23] O. B. Zaslavskii, “Acceleration of particles as universal property of rotating black holes,” Phys. Rev. D **82**, 083004 (2010) [arXiv:1007.3678 [gr-qc]].
- [24] O. B. Zaslavskii, “Acceleration of particles by nonrotating charged black holes,” JETP Lett. **92**, 571 (2010) [Pisma Zh. Eksp. Teor. Fiz. **92**, 635 (2010)] [arXiv:1007.4598 [gr-qc]].
- [25] S. Gao and C. Zhong, “Non-extremal Kerr black holes as particle accelerators,” Phys. Rev. D **84**, 044006 (2011) [arXiv:1106.2852 [gr-qc]].
- [26] Y. Li, J. Yang, Y. L. Li, S. W. Wei and Y. X. Liu, “Particle Acceleration in Kerr-(anti-) de Sitter Black Hole Backgrounds,” Class. Quant. Grav. **28**, 225006 (2011) [arXiv:1012.0748 [hep-th]].
- [27] O. B. Zaslavsky, “Acceleration of particles as a universal property of ergosphere,” Mod. Phys. Lett. A **28**, 1350037 (2013) [arXiv:1301.4699 [gr-qc]].
- [28] A. Abdujabbarov, N. Dadhich, B. Ahmedov and H. Eshkuvatov, “Particle acceleration around a five-dimensional Kerr black hole,” Phys. Rev. D **88**, 084036 (2013) [arXiv:1310.4494 [gr-qc]].
- [29] U. Debnath, “Particles Collision near Kerr-Sen Dilaton-Axion Black Hole,” arXiv:1508.02385 [gr-qc].
- [30] O. B. Zaslavskii, “Black hole with a scalar field as a particle accelerator,” Int. J. Mod. Phys. D **26**, no. 10, 1750108 (2017) [arXiv:1602.08779 [gr-qc]].
- [31] J. Sadeghi, B. Pourhassan and H. Farahani, “Rotating charged hairy black hole in (2+1) dimensions and particle acceleration,” Commun. Theor. Phys. **62**, no. 3, 358 (2014) [arXiv:1310.7142 [hep-th]].
- [32] K. Lake, “Particle Accelerators inside Spinning Black Holes,” Phys. Rev. Lett. **104**, 211102 (2010) Erratum: [Phys. Rev. Lett. **104**, 259903 (2010)] [arXiv:1001.5463 [gr-qc]].
- [33] J. Yang, Y. L. Li, Y. Li, S. W. Wei and Y. X. Liu, “Particle collisions in the lower dimensional rotating black hole space-time with the cosmological constant,” Adv. High Energy Phys. **2014**, 204016 (2014) [arXiv:1202.4159 [hep-th]].
- [34] N. Tsukamoto, K. Ogasawara and Y. Gong, “Particle collision with an arbitrarily high center-of-mass energy near a

- Bañados-Teitelboim-Zanelli black hole,” *Phys. Rev. D* **96**, no. 2, 024042 (2017) [arXiv:1705.10477 [gr-qc]].
- [35] S. Fernando, “Spinning dilaton black hole in 2+1 dimensions as a particle accelerator,” *Mod. Phys. Lett. A* **32**, 1750074 (2017) [arXiv:1703.00373 [gr-qc]].
- [36] “R. Becar, P. A. Gonzalez and Y. Vasquez, Particle collisions near a three-dimensional warped AdS black hole,” arXiv:1712.00868 [gr-qc].
- [37] S. Fernando, “String black hole: can it be a particle accelerator?,” *Gen. Rel. Grav.* **46**, 1634 (2014) [arXiv:1311.1455 [gr-qc]].
- [38] S. B. Giddings and A. Strominger, “Dynamics of extremal black holes,” *Phys. Rev. D* **46**, 627 (1992) [hep-th/9202004].
- [39] A. H. H. Hamo and I. Sakalli, “Exact solutions to the geodesic equations of linear dilaton black holes,” *Turk. J. Phys.* **40**, no. 2, 139 (2016) [arXiv:1506.07483 [gr-qc]].
- [40] Chandrasekhar S.: *The Mathematical Theory of Black Holes*. Oxford University Press, New York (1983).
- [41] N. Deruelle and R. Ruffini, “Quantum and classical relativistic energy states in stationary geometries,” *Phys. Lett.* **52B**, 437 (1974).
- [42] Shutz B.: *A First Course in General Relativity*. Cambridge University Press, New York (2009).
- [43] N. Cruz, C. Martinez and L. Pena, “Geodesic structure of the (2+1) black hole,” *Class. Quant. Grav.* **11**, 2731 (1994) [gr-qc/9401025].
- [44] K. Lake, “Particle Accelerators inside Spinning Black Holes,” *Phys. Rev. Lett.* **104**, 211102 (2010) Erratum: [*Phys. Rev. Lett.* **104**, 259903 (2010)] [arXiv:1001.5463 [gr-qc]].
- [45] J. Yang, Y. L. Li, Y. Li, S. W. Wei and Y. X. Liu, “Particle collisions in the lower dimensional rotating black hole space-time with the cosmological constant,” *Adv. High Energy Phys.* **2014**, 204016 (2014) [arXiv:1202.4159 [hep-th]].
- [46] N. Tsukamoto, K. Ogasawara and Y. Gong, “Particle collision with an arbitrarily high center-of-mass energy near a Baados-Teitelboim-Zanelli black hole,” *Phys. Rev. D* **96**, no. 2, 024042 (2017) [arXiv:1705.10477 [gr-qc]].