

Dominance analysis of linear complementarity systems

F. A. Miranda-Villatoro*

F. Forni*

R. Sepulchre*

Abstract—The paper extends the concepts of dominance and p -dissipativity to the non-smooth family of linear complementarity systems. Dominance generalizes incremental stability whereas p -dissipativity generalizes incremental passivity. The generalization aims at an interconnection theory for the design and analysis of switching and oscillatory systems. The approach is illustrated by a detailed study of classical electrical circuits that switch and oscillate.

I. INTRODUCTION

Dominance analysis and p -dissipativity were recently introduced in [1], [2] to extend the application of dissipativity theory to the analysis of multistable and oscillatory systems. The approach is *differential*, that is, based on the analysis of *linearized* dynamics along trajectories, in the spirit of contraction theory [3], convergence analysis [4], or differential stability analysis [5]. It is particularly adapted to systems whose linearization can be easily parametrized, such as Lure systems that interconnect linear time-invariant systems with static nonlinearities [6]. The present paper investigates how to extend this analysis to nonlinear circuits modeled as linear complementarity systems: models that consist of linear time-invariant systems augmented with a static complementarity constraint. The modeling framework of linear complementarity systems has proven very useful to analyze systems whose nonlinear dynamical behavior arises from non-smooth constraints [7], [8], [9], [10], [11]. They find applications in a number of fields including mechanical systems with unilateral constraints [12], electrical circuits with diodes [13], and mathematical programming [14]. Linear complementarity systems provide an attractive framework for dominance analysis because they are general enough to model switching and oscillatory behaviors often encountered in the presence of non-smooth constraints and specific enough to lead to tractable analysis. In particular, the *passivity* property of complementarity constraints has proven central to analyze linear complementarity systems in the framework of dissipativity theory [15], [9]. Linear complementarity systems hence offer an ideal platform for the application of p -dissipativity theory to switching and oscillatory behaviors. To account for the non-smoothness of linear complementarity systems, the *differential* analysis of [1], [2] has to be replaced by *incremental* analysis [16], [17], [18]. Incremental analysis studies how *increments* between

trajectories evolve in time, whereas differential analysis only considers *linearized* trajectories, that is, infinitesimal increments. In the context of linear complementarity systems, the difference is technical rather than conceptual. We show that the main results of [1], [2] extend to the incremental setting imposed by non-smooth constraints. This paper is organized as follows. In Section II we briefly review the modeling of linear complementarity systems and its core passivity property. Section III is dedicated to the property of dominance and p -dissipativity in the incremental setting. The example Section IV illustrates the potential of p -dissipativity theory to analyze classical switching and oscillatory circuits. The paper ends with conclusions in Section V.

II. LINEAR COMPLEMENTARITY SYSTEMS AND INCREMENTAL PASSIVITY

A. Linear complementarity systems

A linear complementarity system [15] consists of a linear dynamical system subject to a complementarity constraint

$$\begin{cases} \dot{x} = Ax + Bu + Bv \\ y = Cx + Du \\ 0 \leq u \perp y \geq 0, \end{cases} \quad (1)$$

where $x \in \mathbb{R}^n$ is the state variable, $u \in \mathbb{R}^m$ and $y \in \mathbb{R}^m$ are the so-called complementary variables, and $v \in \mathbb{R}^m$ is an additional control input. The matrices A, B, C , and D are constant and of the appropriate dimensions. The complementarity condition $0 \leq u(t) \perp y(t) \geq 0$ is a compact representation of the following three conditions: i) $u \in \mathbb{R}_+^m$, ii) $y \in \mathbb{R}_+^m$, and iii) $\langle u(t), y(t) \rangle = 0$. A solution of the linear complementarity system (1) is any tuple (x, u, y, v) such that $x : \mathbb{R}_+ \rightarrow \mathbb{R}^n$ is an absolutely continuous function and (x, u, y, v) satisfies (1) for almost all forward times $t \in \mathbb{R}_+$. In general, we assume that the initial conditions $x(0) = x_0$ are such that the complementarity conditions hold. This implies the absence of jumps in the initial condition and in the complementarity variables [9].

B. Incremental passivity

A cornerstone in the analysis of linear complementarity systems is to observe that the complementarity relation

$$R_\perp = \{(y, \zeta) \in \mathbb{R}^m \times \mathbb{R}^m \mid 0 \leq y \perp -\zeta \geq 0\} \quad (2)$$

defines an incrementally passive relation. We recall the definition and the proof of that property.

Definition 1: A relation $R \subseteq \mathbb{R}^m \times \mathbb{R}^m$ is incrementally passive if for any $(y_1, \zeta_1) \in R$, and any $(y_2, \zeta_2) \in R$ the inequality

$$\langle y_1 - y_2, \zeta_1 - \zeta_2 \rangle \geq 0 \quad (3)$$

The research leading to these results has received funding from the European Research Council under the Advanced ERC Grant Agreement Switchlet n. 670645.

*University of Cambridge, Department of Engineering, Trumpington Street, CB2 1PZ, Cambridge, United Kingdom. Emails: fam48@cam.ac.uk, f.forni@eng.cam.ac.uk, r.sepulchre@eng.cam.ac.uk

holds.

Proposition 2: R_{\perp} is incrementally passive.

Proof: Take $(y_1, \zeta_1) \in R_{\perp}$ and $(y_2, \zeta_2) \in R_{\perp}$. Then, $\langle y_1 - y_2, \zeta_1 - \zeta_2 \rangle = \langle -y_2, \zeta_1 \rangle + \langle y_1, -\zeta_2 \rangle + \underbrace{\langle y_1, \zeta_1 \rangle}_{=0} + \underbrace{\langle y_2, \zeta_2 \rangle}_{=0} = \underbrace{\langle y_2, -\zeta_1 \rangle}_{\geq 0} + \underbrace{\langle y_1, -\zeta_2 \rangle}_{\geq 0} \geq 0$. ■

An alternative description of the relation R_{\perp} is via the multivalued map

$$\zeta = \varphi_{\perp}(y) \in \{\zeta \in \mathbb{R}^m \mid 0 \leq y \perp -\zeta \geq 0\} \quad (4)$$

which leads to the feedback representation in Figure 1. This Lure type representation of linear complementarity

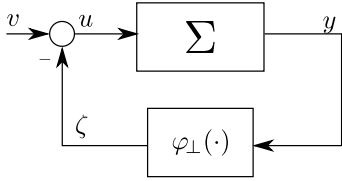

Fig. 1. Block diagram of the linear complementarity system (1)

systems calls for an analysis rooted in passivity theory: the linear complementarity system is incrementally passive as the negative feedback interconnection of a linear passive system Σ with an incrementally passive relation. Passivity of the linear part is a standard assumption in the literature on linear complementarity systems; it guarantees existence and uniqueness of solutions for (1). Details can be found in [9], [8], [19] based on the following additional assumption, which ensures well-posedness of the closed loop in the presence of the throughput term D , [9].

Assumption 3: The linear part of (1) is a minimal realization, it is passive and the matrix

$$\begin{bmatrix} B \\ D + D^T \end{bmatrix} \quad (5)$$

has full column rank. ▽

Passivity of the linear part of (1) from u to y reads

$$\dot{V}(x) \leq \langle y, u \rangle \quad (6)$$

where the derivative of the quadratic storage $V := x^T P x$, $P = P^T > 0$, is computed along the linear dynamics. Passivity and incremental passivity coincide for linear systems. In fact, for any pair of trajectories x_i , outputs y_i and inputs u_i , the incremental dynamics characterized by the variables $\Delta x = x_1 - x_2$, $\Delta y = y_1 - y_2$, $\Delta u = u_1 - u_2$ satisfies

$$\dot{V}(\Delta x) \leq \langle \Delta y, \Delta u \rangle. \quad (7)$$

Since the negative feedback interconnection of incrementally passive systems is incrementally passive [15], the closed loop linear complementarity system is incrementally passive. For any constant input v , the resulting closed loop is thus incrementally stable, that is, there exists a nondecreasing function β such that

$$|x_1(t) - x_2(t)| \leq \beta(|x_1(0) - x_2(0)|) \quad \forall t \geq 0$$

for any pair of trajectories $x_1(\cdot)$, $x_2(\cdot)$ of (1). Furthermore, if the passive inequality (6) is strict, the resulting closed loop becomes incrementally asymptotically stable; its trajectories converge towards each other

$$\lim_{t \rightarrow \infty} |x_1(t) - x_2(t)| = 0.$$

In this case, an equilibrium point is necessarily unique and globally stable. The concept of incremental stability [20] is analog to the concept of differential stability in the theory of contraction [3] or convergent systems [4]. But it does not require any differentiability of the system dynamics.

C. Beyond linear complementarity relations

For the purpose of this paper, the linear complementarity condition can be replaced by *any* incrementally passive static relation. Figure 2 provides an illustration of incrementally passive memoryless nonlinearities. Those multivalued maps are widely used for modeling electronic circuits. For example, the three graphs in Figure 2 represent the ideal current-voltage characteristic of a diode, of a zener diode, and of an array of diodes [21], [22]. Denoting $(w, z) \in R_i$ any pair

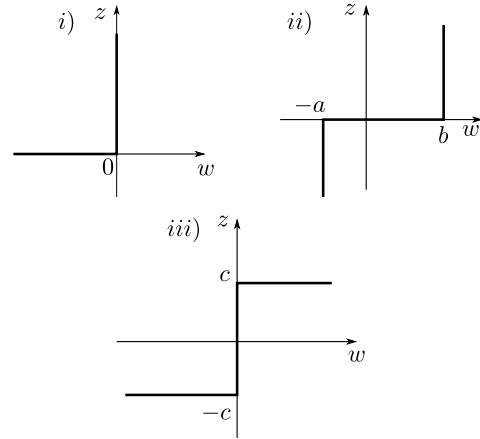

Fig. 2. Popular examples of incrementally passive relations.

(w, z) that belongs to the i -th relation in Figure 2, we extend the class of linear complementarity systems to the family of systems of the form

$$\begin{cases} \dot{x} = Ax + Bu + Bv \\ y = Cx \\ (y, -u) \in R_i. \end{cases} \quad (8)$$

Following the approach of linear complementarity systems, for a solution of (8) we mean any tuple (x, u, y, v) such that $x : \mathbb{R}_+ \rightarrow \mathbb{R}^n$ is an absolutely continuous function and (x, u, y, v) satisfies (8) for almost all forward times $t \in \mathbb{R}_+$. Indeed, the closed loop (8) allows for the block diagram representation in Figure 1, with φ_{\perp} replaced by φ_{R_i} , the static multivalued map associated to the relation R_i . Thus, for any passive relation R_i , the closed loop (8) is incrementally passive. We remark that incremental passivity guarantees existence and uniqueness of solutions also for general *maximal monotone* static multi-valued maps, [8].

III. DOMINANCE AND p -DISSIPATIVITY

A. Dominance

Dominance was recently introduced in [1], [2], [6] as a generalization of incremental stability for smooth nonlinear systems. Motivated by dominance analysis of linear complementarity systems, we extend the definition of dominance in a nonsmooth setting, replacing *differential* analysis by *incremental* analysis as in the previous section. For the sake of simplicity in this section, and the rest of the paper, we consider generic pairs of trajectories $x_1(\cdot)$ and $x_2(\cdot)$, and we adopt the notation $\Delta x = x_1 - x_2$ to denote their mismatch. $\Delta \dot{x} = \dot{x}_1 - \dot{x}_2$ is defined for almost every t by the right-hand side of (8) computed for x_1 and x_2 , respectively. A similar notation is adopted for inputs $\Delta u = u_1 - u_2$ and outputs $\Delta y = y_1 - y_2$. Finally, we say that a symmetric matrix P has inertia $\{p, 0, n - p\}$ when it has p negative eigenvalues and $n - p$ positive eigenvalues.

Definition 4: The nonsmooth system (8) is p -dominant with rate $\gamma \geq 0$ if there exist a matrix $P = P^\top$ with inertia $\{p, 0, n - p\}$ and a constant $\varepsilon \geq 0$ such that for any pair trajectories of (8),

$$\begin{bmatrix} \Delta \dot{x} \\ \Delta x \end{bmatrix} \begin{bmatrix} 0 & P \\ P & 2\gamma P + \varepsilon I \end{bmatrix} \begin{bmatrix} \Delta \dot{x} \\ \Delta x \end{bmatrix} \leq 0. \quad (9)$$

Strict p -dominance holds for $\varepsilon > 0$.

Note that dominance is just incremental stability if P is positive definite, which corresponds to $p = 0$. But we are interested in the generalization corresponding to $p = 1$ and to $p = 2$. For smooth closed systems $\dot{x} = f(x)$, (9) is equivalent to the linear matrix inequality inequality

$$\partial f(x)^\top P + P \partial f(x) + 2\gamma P + \varepsilon I \leq 0 \quad \forall x \in \mathbb{R}^n \quad (10)$$

where $\partial f(x)$ denotes the Jacobian of f at x . In the linear case, $f(x) = Ax$, (10) implies the existence of an invariant splitting such that $\mathbb{R}^n = E_n \oplus E_{n-p}$, where E_p is the p -dimensional eigenspace associated to the *dominant* modes of A (eigenvalues of A whose real part is larger than $-\gamma$), and E_{n-p} is the $(n - p)$ -dimensional eigenspace associated to the *transient* modes of A (i.e., the eigenvalues of A whose real part is smaller than $-\gamma$). Roughly speaking, in the nonlinear case the property of dominance forces the asymptotic behavior to be p -dimensional [2, Theorem 2], as shown by the analysis of the linearized flow in [2, Theorem 1]. The following theorem extends [2, Theorem 2] to the nonsmooth case.

Theorem 5: Assume v constant and suppose that all the trajectories of (13) are bounded. Let $\Omega(x)$ be the set of all ω -limit points of x and let (13) be strictly p -dominant with rate $\gamma \geq 0$. Then, the flow on the $\Omega(x)$ is topologically equivalent to the flow of a p -dimensional system.

Proof: Consider any pair of trajectories $x_1(\cdot)$ and $x_2(\cdot)$, define the increment $\Delta x(\cdot)$, and consider the quadratic form $V(\Delta x(t)) = \Delta x(t)^\top P \Delta x(t)$. From (9),

$$\frac{d}{dt} V(\Delta x(t)) \leq -2\gamma V(\Delta x(t)) - \varepsilon \|\Delta x(t)\|^2,$$

therefore

$$\frac{d}{dt} e^{2\gamma t} V(\Delta x(t)) \leq -\varepsilon e^{2\gamma t} \|\Delta x(t)\|^2.$$

By integration,

$$V(\Delta x(t)) \leq e^{-2\gamma t} V(\Delta x(0)) - \varepsilon \int_0^t e^{-2\gamma(t-\tau)} \|\Delta x(\tau)\|^2 d\tau \quad (11)$$

Let \bar{x}_1 and \bar{x}_2 be two different points of $\Omega(x)$ and define $\Delta \bar{x} = \bar{x}_1 - \bar{x}_2$. Note that both \bar{x}_1 and \bar{x}_2 are accumulation points of a suitable trajectory, therefore $\Delta \bar{x} \neq 0$ and (11) implies

$$V(\Delta \bar{x}) < 0. \quad (12)$$

Let $\mathcal{H}_P, \mathcal{V}_P$ be the eigenspaces of P associated to the p negative eigenvalues of P , and $n - p$ positive eigenvalues of P , respectively. Let $\Pi : \mathbb{R}^n \rightarrow \mathcal{H}_P$ be the projection onto \mathcal{H}_P along \mathcal{V}_P . We claim that Π restricted to Ω is one-to-one. In fact, assume by contradiction that for $\bar{x}_1, \bar{x}_2 \in \Omega(x)$, $\bar{x}_1 \neq \bar{x}_2$ implies $\Pi(\Delta \bar{x}) = 0$, it follows that $\Delta \bar{x} \in \mathcal{V}_P$ and therefore $V(\Delta \bar{x}) > 0$ which contradicts (12). Hence, Π restricted to $\Omega(x)$ is one-to-one.

Now, for each constant input v , consider the equivalent representation of the system (8) based on the differential inclusion

$$\dot{x} \in \mathbf{F}_v(x). \quad (13)$$

Using the results above, if $y \in \Pi\Omega(x)$ then there exists a unique initial condition $z(0) \in \Omega(x)$ such that $y = \Pi z(0)$ and the flow $\Pi z(t)$ in \mathcal{H}_P is generated by the vector field

$$\mathbf{G}_v(y) = \Pi \mathbf{F}_v(\Pi^{-1}y), \quad y \in \Omega(x) \quad (14)$$

which is p -dimensional. \blacksquare

Theorem 5 shows that the asymptotic behavior of a strict p -dominant system is strongly constrained for small values of p .

Corollary 6: Let the assumptions of Theorem 5 hold. In addition, assume that solutions of (8) are unique. Then all solutions asymptotically converge to

- 1) a unique equilibrium point, if $p = 0$.
- 2) an equilibrium point, if $p = 1$.
- 3) an equilibrium point, a set of equilibrium points and connecting arcs, or a limit cycle, if $p = 2$.

Under uniqueness of solutions, distinct trajectories cannot intersect. For $p = 1$, the asymptotic dynamics are one-dimensional, forcing bounded trajectories to converge to some fixed point. Uniqueness of solutions is also sufficient for guaranteeing the validity of the Poincaré-Bendixson Theorem, see e.g., [23, Theorem 5.3]. Hence, under the assumption of uniqueness of solutions, a 2-dominant system with a compact limit set that contains no equilibrium point has a closed orbit.

B. Incremental p -dissipativity

Dissipativity theory is an interconnection theory for stability analysis. In the same way, p -dissipativity is an interconnection theory for dominance analysis [2], [6]. It mimics standard dissipativity theory in the differential/incremental

setting but relies on quadratic storage functions that have a prescribed inertia.

Definition 7: A nonsmooth system (8) is p -dissipative with rate $\gamma \geq 0$ and incremental supply $w : \mathbb{R}^m \times \mathbb{R}^m \rightarrow \mathbb{R}$

$$w(\Delta u, \Delta y) := \begin{bmatrix} \Delta y \\ \Delta u \end{bmatrix}^\top \begin{bmatrix} Q & L^\top \\ L & R \end{bmatrix} \begin{bmatrix} \Delta y \\ \Delta u \end{bmatrix} \quad (15)$$

if there exists a matrix $P = P^\top$ with inertia $\{p, 0, n - p\}$ and $\varepsilon \geq 0$ such that

$$\begin{bmatrix} \Delta \dot{x} \\ \Delta x \end{bmatrix} \begin{bmatrix} 0 & P \\ P & 2\gamma P + \varepsilon I \end{bmatrix} \begin{bmatrix} \Delta \dot{x} \\ \Delta x \end{bmatrix} \leq w(\Delta y, \Delta u) \quad (16)$$

for any pair of trajectories. Strict p -dissipativity holds for $\varepsilon > 0$.

0-dissipativity coincides with the classical concept of incremental dissipativity. p -dissipativity allows for an interconnection theory for non-smooth systems, as clarified by the next theorem. The simplest example is given by the closed loop in Figure 1.

Theorem 8: Let Σ_1 and Σ_2 be (strict) p_1 and p_2 dissipative respectively, both with rate $\gamma \geq 0$ and supplies

$$w^i(\Delta u^i, \Delta y^i) = \begin{bmatrix} \Delta y^i \\ \Delta u^i \end{bmatrix}^\top \begin{bmatrix} Q_i & L_i \\ L_i^\top & R_i \end{bmatrix} \begin{bmatrix} \Delta y^i \\ \Delta u^i \end{bmatrix}, \quad i = 1, 2.$$

The negative feedback interconnection

$$u^1 = -y^2 + v^1, \quad u^2 = y^1 + v^2$$

of Σ_1 and Σ_2 is (strict) $(p_1 + p_2)$ -dissipative with respect to the input $v := [v^1, v^2]^\top$ and the output $y := [y^1, y^2]^\top$, with incremental supply given by

$$\begin{bmatrix} \Delta y \\ \Delta v \end{bmatrix}^\top \begin{bmatrix} Q_1 + R_2 & -L_1 + L_2^\top & L_1 & R_2 \\ -L_1^\top + L_2 & Q_2 + R_1 & -R_1 & L_2 \\ L_1^\top & -R_1^\top & R_1 & 0 \\ R_2 & L_2^\top & 0 & R_2 \end{bmatrix} \begin{bmatrix} \Delta y \\ \Delta v \end{bmatrix}.$$

and rate $\gamma \geq 0$. In addition, if

$$\begin{bmatrix} Q_1 + R_2 & -L_1 + L_2^\top \\ -L_1^\top + L_2 & Q_2 + R_1 \end{bmatrix} \leq 0$$

then the interconnection is (strictly) $(p_1 + p_2)$ -dominant.

Proof: The proof follows by standard arguments of dissipativity theory. See also [1]. ■

Classical dissipativity theory provides a tool to analyze stable systems, that is, 0-dominant systems, as interconnection of dissipative open systems, that is, 0-dissipative systems. Theorem 8 generalizes this conclusion: 1-dominant systems can be analyzed as interconnections of 0-dissipative systems with a 1-dissipative system; 2-dominant systems can be analyzed as interconnections of 0-dissipative systems with a 2-dissipative system, or as interconnections of two 1-dissipative systems.

C. p -Passivity of linear complementarity systems

As in the classical theory, p -passivity is p -dissipativity for the particular supply rate

$$w(\Delta u, \Delta y) := \begin{bmatrix} \Delta y \\ \Delta u \end{bmatrix}^\top \begin{bmatrix} 0 & I \\ I & 0 \end{bmatrix} \begin{bmatrix} \Delta y \\ \Delta u \end{bmatrix} \quad (17)$$

We have seen in Section II that the linear complementarity relation R_\perp is 0-passive (since 0-passivity and incremental passivity coincide). Also the static nonlinearities R_i in Section II-C are 0-passive. Thus, from Theorem 8, the nonsmooth system (8) is the negative feedback loop of a 0-passive static nonlinearity with a linear system, whose degree of p -passivity determines the degree of passivity of the closed loop. The degree of passivity of the linear part restricts the asymptotic behavior of the system. We observe that for linear systems of the form $\dot{x} = Ax + Bu$, $y = Cx$, the inequality (16) with (17) reduces to the simple feasibility test

$$A^\top P + PA + 2\gamma P \leq -\varepsilon I \quad PB = C^\top$$

for some matrix $P = P^\top$ with inertia $\{p, 0, n - p\}$; a numerically tractable condition. Also, p -passivity has a frequency domain characterization based on the rate-shifted transfer function $G(s - \gamma) = C(sI - (A + \gamma I))^{-1}B$, [6]:

Proposition 9: A linear system is p -passive if and only if the following two conditions hold,

- 1) $\Re \{G(j\omega - \gamma)\} > 0$, for all, $\omega \in \mathbb{R} \cup \{+\infty\}$.
- 2) $G(s - \gamma)$ has p poles on the right-hand side of the complex plane.

Frequency domain conditions prove useful in capturing the limits of the theory and for the selection of the systems parameters, as shown in the next section.

IV. SWITCHING AND OSCILLATING LCS CIRCUITS

A. The operational amplifier is 0-passive

A model of the operational amplifier is shown in Figure 3: a first order model [24], with additional voltage saturation limits, implemented via ideal diodes, to take into account the physical limitations of any op-amp device. Note that the right-most element $\times 1$ in the model denotes a buffer, which decouples the output current from the internal circuit. We make the usual assumption of infinite input impedance $Z_{in} = +\infty$ and 0 output impedance $Z_{out} = 0$. The model in Figure

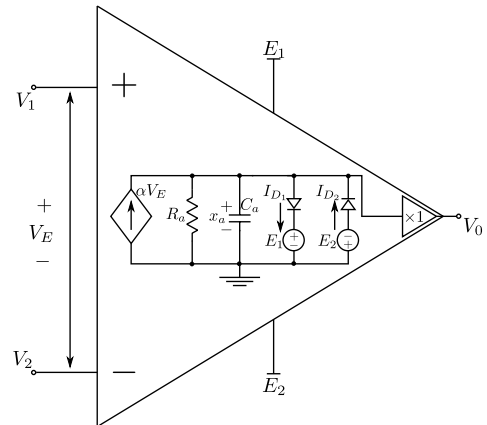

Fig. 3. A nonsmooth model of an operational amplifier

3 is described by the linear complementarity system

$$\dot{x}_a = -\frac{1}{R_a C_a} x_a + \frac{\alpha}{C_a} V_E - \frac{1}{C_a} (I_{D_1}(t) - I_{D_2}) \quad (18a)$$

$$V_0 = x_a \quad (18b)$$

$$0 \leq -V_0 + E_1 \perp I_{D_1} \geq 0, \quad (18c)$$

$$0 \leq V_0 + E_2 \perp I_{D_2} \geq 0. \quad (18d)$$

where we assume that the voltage sources E_1 and $-E_2$ are constant and $E_i > 0$, $i = 1, 2$. The model is derived via Kirchhoff's laws together with the complementarity conditions for the diodes [21]. x_a denotes the voltage across the capacitor C_a . The input is set to V_E and the output is V_0 . For completeness, we write (18) in the standard linear complementarity form (1) by taking $V_E = V_1 - V_2$, $u = [I_{D_1}, I_{D_2}, E_1, E_2]^\top$, $v = [-\alpha V_1, -\alpha V_2, 0, 0]^\top$, $A = -\frac{1}{R_a C_a}$, $B = \frac{1}{C_a}[-1, 1, 0, 0]$,

$$C = \begin{bmatrix} -1 \\ 1 \\ 0 \\ 0 \end{bmatrix}, \quad \text{and} \quad D = \begin{bmatrix} 0 & 0 & 1 & 0 \\ 0 & 0 & 0 & 1 \\ 0 & 0 & 0 & 0 \\ 0 & 0 & 0 & 0 \end{bmatrix}.$$

A representation of (18) is the negative feedback interconnection of a strictly 0-passive system with a 0-passive relation R defined by (18b), (18c), and (18d), linking voltage V_0 and the difference of diode currents $I_{DD} = I_{D_1} - I_{D_2}$. The relations $0 \leq -V_0(t) + E_1$ and $0 \leq V_0(t) + E_2$ imply $-E_2 \leq V_0(t) \leq E_1$. Thus, the output of the op-amp $V_0(t) = x_a(t)$ always belongs to the interval $[-E_2, E_1]$. For $V_0(t) = E_1$, (18c) and (18d) imply that $I_{D_1}(t) \geq 0$ and $I_{D_2}(t) = 0$, respectively, that is, $I_{DD}(t) \geq 0$. Similarly, $V_0(t) = -E_2$ implies $I_{DD}(t) \leq 0$ and $V_0(t) \in (-E_2, E_1)$ implies $I_{DD}(t) = 0$. Hence, R corresponds to the 0-passive relation represented in Figure 2.ii). Its associated multivalued function φ_R maps the voltage V_0 into

$$I_{DD} = \varphi_R(V_0) \in \begin{cases} (-\infty, 0], & V_0(t) = -E_2 \\ \{0\}, & -E_2 < V_0(t) < E_1 \\ [0, +\infty), & V_0(t) = E_1 \end{cases}.$$

The operational amplifier model (18) is thus given by the feedback loop in Figure 4, combining the 0-passive linear system Σ_a with matrices $A = -\frac{1}{R_a C_a}$, $B = \frac{1}{C_a}$, and $C = 1$, with the 0-passive nonlinearity φ_R . The transfer function of Σ_a reads

$$G(s) = \frac{\frac{1}{C_a}}{s + \frac{1}{R_a C_a}}. \quad (19)$$

and Proposition 9 guarantees strict 0-passivity with rate $\gamma \in [0, \frac{1}{R_a C_a})$. By Theorem 8, the op-amp is thus a strictly 0-passive device from V_E to V_0 with rate $\gamma \in [0, \frac{1}{R_a C_a})$.

B. Positive feedback amplifier: multistable Schmitt trigger

The positive feedback interconnection of the op-amp with an additional passive network leads to 1-passive circuits. For instance, the Schmitt trigger circuit represented in Figure 5

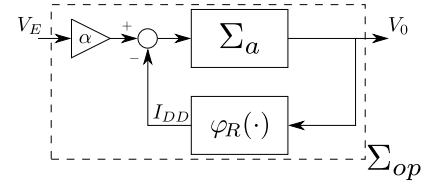

Fig. 4. Block diagram of the operational amplifier (18)

contains an op-amp, whose model is given by (18), and a linear network Σ_c represented by

$$\Sigma_c : \begin{cases} \dot{x}_1 = -\frac{R_1 + R_2}{R_1 R_2 C_1} x_1 + \frac{1}{R_2 C_1} \nu_1 \\ y_1(t) = -x_1, \end{cases} \quad (20)$$

where x_1 is the voltage across the capacitor C_1 . Their

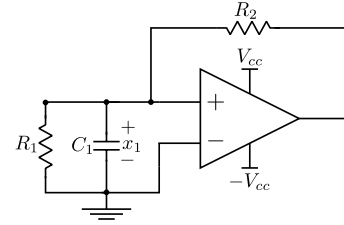

Fig. 5. Schmitt Trigger circuit formed as the positive feedback interconnection of the circuit in Figure 3 with a RC network

interconnection is characterized by the positive feedback identity

$$V_E = x_1, \quad \nu_1 = V_0. \quad (21)$$

Positive feedback loops of two 0-passive systems are not 0-passive. But Σ_c is also strictly 1-passive from the input ν_1 to the output y_1 with rate $\gamma \in (\frac{R_1 + R_2}{R_1 R_2 C_1}, +\infty)$, which allows to rewrite (21) as negative feedback

$$V_E = -y_1, \quad \nu_1 = V_0. \quad (22)$$

Indeed, the positive feedback in (21) is equivalent to the negative feedback between a strictly 0-passive system, the op-amp, and a strictly 1-passive system, Σ_c . Thus, by selecting the circuit parameters to satisfy

$$\frac{R_1 + R_2}{R_1 R_2 C_1} < \frac{1}{R_a C_a}, \quad (23)$$

Theorem 8 guarantees that the Schmitt trigger is strictly 1-passive with rate $\gamma \in (\frac{R_1 + R_2}{R_1 R_2 C_1}, \frac{1}{R_a C_a})$. The closed loop is thus strictly 1-dominant. An interpretation of (23) is that the linear circuit Σ_c must have a slower dynamics than the op-amp dynamics, to determine a dominant behavior of dimension 1. Mathematically, (23) guarantees the existence of a common rate $\gamma \geq 0$ for which op-amp and Σ_c are respectively 0-passive and 1-passive, as required by Theorem 8. A 1-passive circuit can be multistable. Bounded trajectories of a strictly 1-dominant system necessarily converge to a fixed point. Boundedness of trajectories follows from the saturation of the op-amp voltage, which essentially “opens the loop” for large overshoots. To enforce multistability, we

look for circuit parameters that guarantee the existence of at least one unstable equilibrium point. The condition

$$\frac{1}{R_a} < \frac{\alpha R_1}{R_1 + R_2}, \quad (24)$$

makes the zero-equilibrium unstable. The parameters in Table I satisfies (23) and (24), enabling bistability. The value of resistance R_a and capacitance C_a have been taken from [24], to ensure good matching between simulations and the behavior of a real op-amp component. Figure 6 shows the trajectories of the system from two different initial conditions $(x_a(0), x_1(0)) \in \{(-2, -2), (2, 2)\}$.

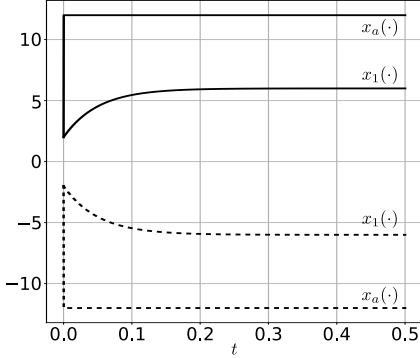

Fig. 6. Schmitt trigger trajectories from two different initial conditions.

$R_1 = 1K\Omega$	$R_a = 1M\Omega$	$C_1 = 100\mu F$	$E_1 = 12V$
$R_2 = 1K\Omega$	$\alpha = 0.1$	$C_a = 15.9nF$	$E_2 = 12V$

TABLE I

PARAMETER VALUES FOR THE SIMULATION OF THE SCHMITT TRIGGER.

C. Mixed feedback amplifier: relaxation oscillator

The interconnection of the op-amp with two slow passive networks, one with negative and one with positive feedback, leads to 2-passive circuits. For instance, the circuit in Figure 7 is a typical architecture for the generation of relaxation oscillations. It is derived from the Schmitt trigger through the addition of a slow network Σ_d , in negative feedback, represented by

$$\Sigma_d : \begin{cases} \dot{x}_2 = -\frac{R_3+R_4}{R_3R_4C_2}x_2 + \frac{1}{R_4C_2}\nu_2 \\ y_2 = x_2, \end{cases} \quad (25)$$

where x_2 is the voltage across the capacitor C_2 . The interconnection of the op-amp and of the two networks Σ_c and Σ_d is given by the mixed positive/negative feedback

$$V_E = x_1 - x_2, \quad \nu_1 = \nu_2 = V_0. \quad (26)$$

which can be written as a standard negative feedback loop using the aggregate output $y = y_1 + y_2$, for instance

$$V_E = -y = -y_1 - y_2, \quad \nu_1 = \nu_2 = V_0. \quad (27)$$

Taking $a_1 = \frac{1}{R_2C_1}$, $a_2 = \frac{1}{R_4C_2}$, $b_1 = \frac{R_1+R_2}{R_2R_1C_1}$ and $b_2 = \frac{R_3+R_4}{R_3R_4C_2}$, the aggregate transfer function from V_0 to y reads

$$G(s) = -\frac{a_1}{s+b_1} + \frac{a_2}{s+b_2} = \frac{(a_2 - a_1)s + a_2b_1 - a_1b_2}{(s+b_1)(s+b_2)}. \quad (28)$$

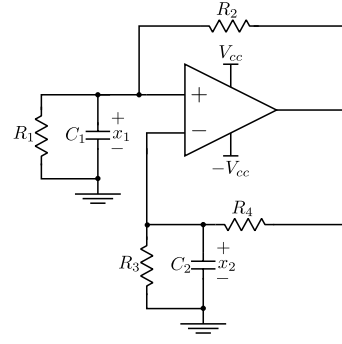

Fig. 7. Relaxation Oscillator realized as the mixed positive and negative feedback of two RC networks and an op-amp

For $a_2 = 0$, there is no negative feedback and the system reduces to the Schmitt trigger. For $a_2 \neq 0$, the negative feedback loop either stabilizes the closed loop system, typically for parameter values that guarantee 0-passivity of $G(s)$, or induces oscillations, typically for parameter values that guarantee 2-passivity of $G(s)$. For instance, $G(j\omega - \gamma)$ has positive real part if

$$\begin{aligned} a_2(b_2 - \gamma) - a_1(b_1 - \gamma) &> 0 \\ a_2(b_1 - \gamma) - a_1(b_2 - \gamma) &> 0 \end{aligned}$$

Hence, by Proposition 9, if

$$0 < \gamma < \min\left\{b_1, b_2, \frac{1}{R_a C_a}\right\}, \quad \frac{a_2}{a_1} > \max\left\{\frac{b_1 - \gamma}{b_2 - \gamma}, \frac{b_2 - \gamma}{b_1 - \gamma}\right\}$$

then $G(s)$ is strictly 0-passive with rate γ . The overall closed loop has a globally asymptotically stable fixed point. In contrast, for

$$0 < \max\{b_1, b_2\} < \gamma < \frac{1}{R_a C_a}, \quad \frac{a_2}{a_1} < \min\left\{\frac{b_1 - \gamma}{b_2 - \gamma}, \frac{b_2 - \gamma}{b_1 - \gamma}\right\}$$

$G(s)$ is strictly 2-passive with rate γ . Thus, by Theorem 8, the overall closed-loop is 2-dominant with rate γ . Indeed, γ divides the fast op-amp dynamics from the dominant two dimensional slow dynamics of the linear networks. We conclude the section with a numerical simulation. The parameters of Table I together with $R_3 = 3.3K\Omega$, $R_4 = 1K\Omega$ and $C_2 = 200\mu F$ satisfy the conditions above, thus guarantee strict 2-dominance the closed loop with rate $\gamma = 25$. The fixed point in 0 is unstable but all trajectories remain bounded (the constraint $x_a \in [-E_2, E_1]$ implies that x_1 and x_2 remain bounded), which enforces oscillations, as shown in Figure 8.

V. CONCLUSIONS

We extended the concept of dominance to the analysis of nonsmooth linear complementarity systems. The extension mimics the smooth case when uniqueness of solutions is assumed. The approach is based on the interconnection theory of dissipativity. It opens the way to the analysis of switching or oscillatory circuits with no restriction on the dimension of the state-space. The potential of the approach was illustrated with a detailed analysis of well-known circuits

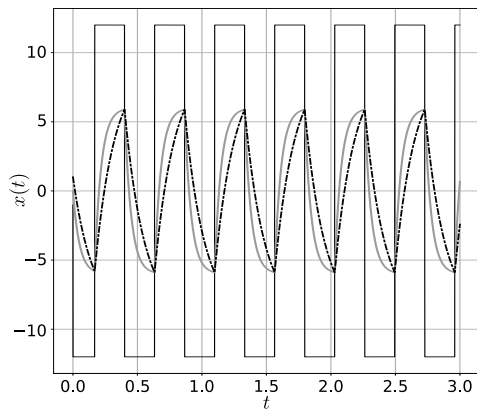

Fig. 8. Trajectories of the relaxation oscillator in Figure 7. $x_a(\cdot)$ – thin/black line; $x_1(\cdot)$ – thick/gray line; $x_2(\cdot)$ – dashed line.

based on op-amps, predicting multistable and oscillatory behaviors, while providing margins on the circuit parameters to enable such behaviors.

REFERENCES

- [1] F. Forni and R. Sepulchre, “A dissipativity theorem for p -dominant systems,” in *56th IEEE Conference on Decision and Control*, Melbourne, Australia, 2017.
- [2] —, “Differential dissipativity theory for dominance analysis,” 2017, submitted to *IEEE Transactions on Automatic Control*, <http://arxiv.org/abs/1710.01721>.
- [3] W. Lohmiller and J.-J. E. Slotine, “On contraction analysis for nonlinear systems,” *Automatica*, vol. 34, no. 6, pp. 683–696, 1998.
- [4] A. Pavlov, N. Van De Wouw, and H. Nijmeijer, “Convergent systems: analysis and synthesis,” in *Control and observer design for nonlinear finite and infinite dimensional systems*. Springer, 2005, pp. 131–146.
- [5] F. Forni and R. Sepulchre, “A differential Lyapunov framework for contraction analysis,” *IEEE Transactions on Automatic Control*, vol. 59, no. 3, pp. 614–628, 2014.
- [6] F. A. Miranda-Villatoro, F. Forni, and R. Sepulchre, “Analysis of Lur’e dominant systems in the frequency domain,” 2017, submitted to *Automatica*, <http://arxiv.org/abs/1710.01645>.
- [7] B. Brogliato, “On the control of non-smooth complementarity dynamical systems,” *Philosophical Transactions of the Royal Society of London. Series A: Mathematical, Physical and Engineering Sciences*, vol. 359, no. 1789, pp. 2369–2383, 2001.
- [8] —, “Some perspectives on the analysis and control of complementarity systems,” *IEEE Transactions on Automatic Control*, vol. 48, no. 6, pp. 918–935, 2003.
- [9] M. K. Çamlıbel, W. Heemels, and J. Schumacher, “On linear passive complementarity systems,” *European Journal of Control*, vol. 8, no. 3, pp. 220–237, 2002.
- [10] M. K. Çamlıbel, P. J. S., and J. L. Shen, “Lyapunov stability of linear complementarity systems,” *SIAM Journal on Optimization*, vol. 17, no. 4, pp. 1056–1101, 2006.
- [11] W. Heemels and B. Brogliato, “The complementarity class of hybrid dynamical systems,” *European Journal of Control*, vol. 9, no. 2, pp. 322–360, 2003.
- [12] B. Brogliato, *Nonsmooth Mechanics*, ser. Communications and Control Engineering. Springer, 2016.
- [13] V. Acary, O. Bonnefon, and B. Brogliato, *Nonsmooth modeling and simulation for switched circuits*, ser. Lecture Notes in Electrical Engineering. Springer, 2011.
- [14] A. Nagurney, *Network economics: A variational inequality approach*, ser. Advances in Computational Economics. Springer, 1999.
- [15] A. J. van der Schaft, *L2-Gain and Passivity Techniques in Nonlinear Control*, ser. Lecture Notes in Control and Information Sciences. Springer, 1996.
- [16] G. B. Stan and R. Sepulchre, “Analysis of interconnected oscillators by dissipativity theory,” *IEEE Transactions on Automatic Control*, vol. 52, no. 2, pp. 256–270, 2007.
- [17] A. Pavlov and M. L., “Incremental passivity and output regulation,” *Systems & Control Letters*, vol. 57, pp. 400–409, 2008.
- [18] T. Liu, D. J. Hill, and Z. J., “Incremental-dissipativity-based synchronization of interconnected systems,” in *Proceeding of the 18th World Congress*, Milano, Italy, 2011, pp. 8890–8895.
- [19] F. A. Miranda-Villatoro and F. Castañón, “Robust output regulation of strongly linear passive systems with multivalued maximally monotone controls,” *IEEE Transactions on Automatic Control*, vol. 62, no. 1, pp. 238–249, 2017.
- [20] D. Angeli, “A Lyapunov approach to incremental stability properties,” *IEEE Transactions on Automatic Control*, vol. 47, pp. 410–421, 2000.
- [21] V. Acary and B. Brogliato, “Implicit Euler numerical scheme and chattering-free implementation of sliding mode systems,” *Systems & Control Letters*, vol. 59, no. 5, pp. 284–293, 2010.
- [22] Y. J. Lootsma, A. J. van der Schaft, and M. K. Çamlıbel, “Uniqueness of solutions of linear relay systems,” *Automatica*, vol. 35, pp. 467–478, 1999.
- [23] K. Ciesielski, “The Poincaré-Bendixson theorems for two dimensional semiflows,” *Topological Methods in Nonlinear Analysis*, vol. 3, pp. 163–178, 1994.
- [24] J. Karki, “Effect of parasitic capacitance in op amp circuits,” Texas Instruments, Tech. Rep. SLOA013A, 2000.