

Generation of long-living entanglement between two distant three-level atoms in non-Markovian environments

CHUANG LI,¹ SEN YANG,¹ YAN XIA,² JIE SONG,^{1,3} AND WEI-QIANG DING^{1,4}

¹*Department of Physics, Harbin Institute of Technology, Harbin, 150001, China*

²*Department of Physics, Fuzhou University, Fuzhou, 350002, China*

³*jsong@hit.edu.cn*

⁴*wqding@hit.edu.cn*

Abstract: In this paper, a scheme for the generation of long-living entanglement between two distant Λ -type three-level atoms separately trapped in two dissipative cavities is proposed. In this scheme, two dissipative cavities are coupled to their own non-Markovian environments and two three-level atoms are driven by the classical fields. The entangled state between the two atoms is produced by performing Bell state measurement (BSM) on photons leaving the dissipative cavities. Using the time-dependent Schrödinger equation, we obtain the analytical results for the evolution of the entanglement. It is revealed that, by manipulating the detunings of classical field, the long-living stationary entanglement between two atoms can be generated in the presence of dissipation.

© 2018 Optical Society of America

OCIS codes: (270.0270) Quantum optics; (060.5565) Quantum communications.

References and links

1. R. Horodecki, P. Horodecki, M. Horodecki, and K. Horodecki, "Quantum entanglement," *Rev. Mod. Phys.* **81**(2), 865 (2009).
2. C. H. Bennett, G. Brassard, C. Crépeau, R. Jozsa, A. Peres, and W. K. Wootters, "Teleporting an unknown quantum state via dual classical and Einstein-Podolsky-Rosen channels," *Phys. Rev. Lett.* **70**(13) (1993).
3. K. Mattle, H. Weinfurter, P. G. Kwiat, and A. Zeilinger, "Dense coding in experimental quantum communication," *Phys. Rev. Lett.* **76**(25), 4656 (1996).
4. K. Ekert, "Quantum cryptography based on Bell's theorem," *Phys. Rev. Lett.* **67**(6), 661 (1991).
5. R. Raussendorf, and H. J. Briegel, "A one-way quantum computer," *Phys. Rev. Lett.* **86**(22), 5188 (2001).
6. Q. A. Turchette, C. S. Wood, B. E. King, C. J. Myatt, D. Leibfried, W. M. Itano, and D. J. Wineland, "Deterministic entanglement of two trapped ions," *Phys. Rev. Lett.* **81**(17), 3631 (1998).
7. C. A. Sackett, D. Kielpinski, B. E. King, C. Langer, V. Meyer, C. J. Myatt, and C. Monroe, "Experimental entanglement of four particles," *Nature* **404**(6775), 256–259 (2000).
8. S. B. Zheng and G. C. Guo, "Efficient scheme for two-atom entanglement and quantum information processing in cavity QED," *Phys. Rev. Lett.* **85**(11): 2392 (2000).
9. A. Wallraff, D. I. Schuster, A. Blais, L. Frunzio, R. S. Huang, J. Majer, and R. J. Schoelkopf, "Strong coupling of a single photon to a superconducting qubit using circuit quantum electrodynamics," *Nature* **431**(7005), 162–167 (2004).
10. A. Aspect, P. Grangier, G. Roger, "Experimental tests of realistic local theories via Bell's theorem," *Phys. Rev. Lett.* **47**(7): 460(1981).
11. W. Wieczorek, R. Krischek, N. Kiesel, P. Michelberger, G. Tóth, and H. Weinfurter, "Experimental entanglement of a six-photon symmetric Dicke state," *Phys. Rev. Lett.* **103**(2), 020504 (2009).
12. T. Yu and J. H. Eberly, "Qubit disentanglement and decoherence via dephasing," *Phys. Rev. B* **68**(16): 165322 (2003).
13. T. Yu and J. H. Eberly, "Finite-time disentanglement via spontaneous emission," *Phys. Rev. Lett.* **93**(14), 140404 (2004).
14. M. F. Santos, P. Milman, L. Davidovich, and N. Zagury, "Direct measurement of finite-time disentanglement induced by a reservoir," *Phys. Rev. B* **73**(4), 040305 (2006).
15. T. Yu and J. H. Eberly, "Quantum open system theory: bipartite aspects," *Phys. Rev. Lett.* **97**(14), 140403 (2006).
16. F. Benatti, R. Floreanini, and M. Piani, "Environment induced entanglement in Markovian dissipative dynamics," *Phys. Rev. Lett.* **91**(7), 070402 (2003).
17. F. Benatti and R. Floreanini, "Entangling oscillators through environment noise," *J. Phys. A* **39**(11), 2689 (2006).

18. J. Song, Z. J. Zhang, Y. Xia, X. D. Sun, and Y. Y. Jiang, “Fast coherent manipulation of quantum states in open systems,” *Opt. Express* **24**(19), 21674–21683 (2016).
19. J. F. Triana, A. F. Estrada, and L. A. Pachón, “Bringing entanglement to the high temperature limit,” *Phys. Rev. Lett.* **105**(18), 180501 (2010).
20. J. Cerrillo and J. Cao, “Non-Markovian dynamical maps: numerical processing of open quantum trajectories,” *Phys. Rev. Lett.* **112**(11), 110401 (2014).
21. R. Fischer, I. Vidal, D. Gilboa, R. R. Correia, A. C. Ribeiro-Teixeira, S. D. Prado, and Y. Silberberg, “Light with tunable non-Markovian phase imprint,” *Phys. Rev. Lett.* **115**(7), 073901 (2015).
22. A. F. Estrada and L. A. Pachón, and L. A. Pachón, “Quantum limit for driven linear non-Markovian open-quantum-systems,” *New J. Phys.* **17**(3), 033038 (2015).
23. F. Galve, L. A. Pachón, and D. Zueco, “Ultrafast Optimal Sideband Cooling under Non-Markovian Evolution,” *Phys. Rev. Lett.* **116**(18), 183602 (2016).
24. S. Oh and J. Kim, “Entanglement between qubits induced by a common environment with a gap,” *Phys. Rev. B* **73**(6), 062306 (2006).
25. M. Dukalski and Y. M. Blanter, “Periodic revival of entanglement of two strongly driven qubits in a dissipative cavity,” *Phys. Rev. A* **82**(5): 052330 (2010);
26. A. Nourmandipour, M. K. Tavassoly, and M. Rafiee, “Dynamics and protection of entanglement in n-qubit systems within Markovian and non-Markovian environments,” *Phys. Rev. A* **93**(2), 022327 (2016).
27. A. Nourmandipour and M. K. Tavassoly, “Entanglement swapping between dissipative systems,” *Phys. Rev. A* **94**(2), 022339(2016).
28. D. Kaszlikowski, P. Gnaniński, M. Żukowski, W. Miklaszewski, and A. Zeilinger, “Violations of local realism by two entangled N-dimensional systems are stronger than for two qubits,” *Phys. Rev. Lett.* **85**(21), 4418 (2000).
29. M. Bourennane, A. Karlsson, and G. Björk, “Quantum key distribution using multilevel encoding,” *Phys. Rev. A* **64**(1), 012306 (2001).
30. D. Bruss and C. Macchiavello, “Optimal eavesdropping in cryptography with three-dimensional quantum states,” *Phys. Rev. Lett.* **88**(12): 127901(2002).
31. X. Zou, K. Pahlke, and W. Mathis, “Generation of an entangled state of two three-level atoms in cavity QED,” *Phys. Rev. A* **67**(4), 044301 (2003).
32. X. Zou and W. Mathis, “One-step implementation of maximally entangled states of many three-level atoms in microwave cavity QED,” *Phys. Rev. A* **70**(3), 035802 (2004).
33. Ö. Çakir, H.T. Dung, L. Knöll, and D. G. Welsch, “Generation of long-living entanglement between two separate three-level atoms,” *Phys. Rev. A* **71**(3), 032326 (2005).
34. S. Y. Ye, Z. R. Zhong, and S. B. Zheng, “Deterministic generation of three-dimensional entanglement for two atoms separately trapped in two optical cavities,” *Phys. Rev. A* **77**(1), 014303 (2008).
35. H. Tan, H. Xia H, and G. Li, “Interference-induced enhancement of field entanglement from an intracavity three-level V-type atom,” *Phys. Rev. A* **79**(6), 063805 (2009).
36. G. Vidal and R. F. Werner, “Computable measure of entanglement,” *Phys. Rev. A* **65**(3), 032314 (2002).
37. A. Nourmandipour and M. K. Tavassoly, “Dynamics and protecting of entanglement in two-level systems interacting with a dissipative cavity: the Gardiner-Collett approach,” *J. Phys. B: At. Mol. Opt. Phys.* **48**(16), 165502 (2015).
38. A. Nourmandipour, M. K. Tavassoly and S. Mancini, “The entangling power of a glocal dissipative map,” *Quantum Inf. Comput.* **16**(11&12), 0969-0981 (2016).
39. G. R. Guthohriein, M. Keller, K. Hayasaka, W. Lange, and H. Walther, “A single ion as a nanoscopic probe of an optical field,” *Nature* **414**(6859), 256–259 (2001).
40. J. Johnson, J. Canning, T. Kaneko, J. K. Pru, and J. L. Tilly, “Germline stem cells and follicular renewal in the postnatal mammalian ovary,” *Nature* **428**(6979), 145–150 (2004).
41. X. S. Ma, S. Zotter, J. Kofler, R. Ursin, T. Jennewein, Č. Brukner, and A. Zeilinger, “Experimental delayed-choice entanglement swapping,” *Nature* **8**(6), 479–484 (2012).

1. Introduction

Quantum entanglement, as the most important resource for quantum science and technology, draws a great deal of attention in various domains [1], such as quantum teleportation [2], quantum dense coding [3], quantum cryptography [4], and quantum computation [5]. Therefore, many schemes have been proposed to generate entangled states, such as trapped ions [6, 7], quantum electrodynamics [8, 9], and photon pairs [10, 11].

In order to complete a quantum operation, the long-living entanglement is needed. In real physical systems, however, quantum entanglement is fragile and very easy to be destroyed due to the interaction between quantum system and environments [12–14]. Therefore, many efforts have been devoted to the dynamical evolution of entanglement in Markovian environments [15–18]. In contrast, non-Markovian dynamics shows more interesting phenomena because of the memory

effect, and has been used in various quantum operations [19–23]. Up to now, extensive researches on the entangled states for two-level atoms in dissipative environments have been done [24–27]. For example, in [27], Nourmandipour et al. investigate the entanglement swapping between two two-level atoms. Their results show that the stationary entanglement between two two-level atoms can be generated in the presence of dissipation.

Compared with the two-dimensional entanglement, high-dimensional entangled states are more competitive due to the fact that three-level quantum systems provide more secure quantum key distributions than those based on two-level systems [28–30]. Therefore, extensive researches have been devoted to the generation of three-dimensional entanglement [31–35]. For example, in [34], the generation of three-dimensional entanglement of two distant atoms in Markovian environments is proposed. In practice, the dissipation of cavities is unavoidable, and generating three-dimensional entangled states in non-Markovian environments is valuable and worth studying.

In this paper, we propose a scheme for producing the entanglement between two atoms separately trapped in two dissipative cavities. We first investigate the dynamical evolution of a three-level atom in non-Markovian environments by using the time-dependent Schrödinger equation. Then, we generate the entanglement between two atoms by performing Bell state measurement on photons leaving the cavities. We use negativity to quantify the amount of entanglement [36] and discuss the effect of detunings and initial atomic states on the evolution of entanglement. The rest of the paper is organized as follows: In Sec. II, we introduce the model of the atom-field coupling system, and the dynamical evolution of entanglement between the atom and the cavity field is presented in Sec. III. In Sec. IV, we produce the entangled state between two atoms by performing Bell state measurement and discuss the effect of detunings and initial atomic states on the evolution of entanglement. The conclusions are drawn in Sec. V.

2. THE MODEL

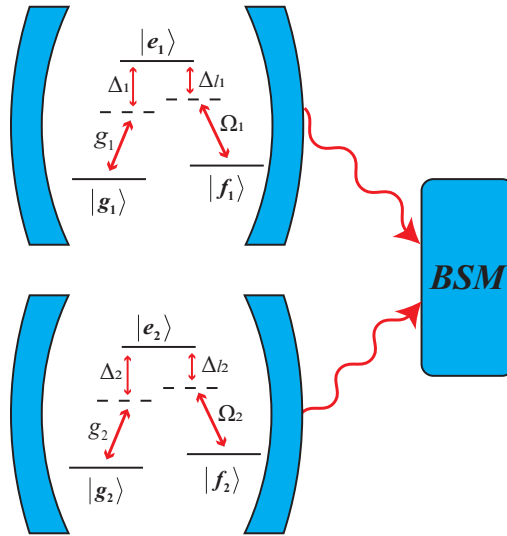

Fig. 1. Schematic representation of the setup. BSM is performing Bell state measurement on photons leaving the cavities.

We consider a system formed by two separate dissipative cavities, each of which contains a Λ -type three-level atom with ground state ($|g\rangle$), lower and upper excited states ($|f\rangle$, $|e\rangle$) (see Fig. 1). The quantum states $|g_i\rangle$, $|f_i\rangle$, and $|e_i\rangle$ ($i = 1, 2$) have the energies of ω_{g_i} , ω_{f_i} , and ω_{e_i} ,

respectively ($\hbar = 1$). We assume both two dissipative cavities have high quality factors. In the i th cavity, the transition $|g_i\rangle \leftrightarrow |e_i\rangle$ is coupled to a single-mode cavity field with the coupling constant g_i , while the transition $|f_i\rangle \leftrightarrow |e_i\rangle$ is driven through a classical field with the coupling constant Ω_i . Assuming that the cavity field interacts with a reservoir consisting of a set of continuous harmonic oscillators, the Hamiltonian describing the field-reservoir is given by

$$H_{c_i} = \omega_{c_i} a_i^\dagger a_i + \int_0^\infty B_i^\dagger(\eta) B_i(\eta) d\eta + \int_0^\infty G_i(\eta) [a_i^\dagger B_i(\eta) + \text{H.c.}] d\eta, \quad (1)$$

where ω_{c_i} is the frequency of the cavity field, $G_i(\eta)$ is the coupling strength between the cavity field and the reservoir, which is a function of frequency η . $B_i^\dagger(\eta)$ (and $B_i(\eta)$) is the creation (and annihilation) operator of the reservoir, which obeys the commutation relation of $[B_i(\eta), B_j^\dagger(\eta')] = \delta_{ij} \delta(\eta - \eta')$. The model of the field-reservoir shows that the dissipative cavity has a Lorentzian spectral density implying the nonperfect reflectivity of the cavity mirrors. Supposing that the reservoir has a narrow bandwidth, we can extend integrals over η from 0 to $-\infty$ and take $G_i(\eta)$ as a constant. Thus, by introducing the dressed operator $A_i(\omega) = \alpha_i(\omega) a_i + \int_{-\infty}^\infty \beta_i(\omega, \eta) B_i(\eta) d\eta$, one is able to diagonalize the Hamiltonian (1) as [37]

$$H_{c_i} = \int_{-\infty}^\infty \omega A_i^\dagger(\omega) A_i(\omega) d\omega. \quad (2)$$

The annihilation operator a_i is given by

$$a_i = \int_{-\infty}^\infty \alpha_i^*(\omega) A_i(\omega) d\omega, \quad (3)$$

with

$$\alpha_i(\omega) = \frac{\sqrt{\kappa_i/\pi}}{\omega - \omega_{c_i} + i\kappa_i}, \quad (4)$$

where κ_i is the decay rate of the i th cavity. Consequently, the total Hamiltonian of the atom-field system is

$$H_i = \int_{-\infty}^\infty \omega A_i^\dagger(\omega) A_i(\omega) d\omega + \omega_{e_i} |e_i\rangle \langle e_i| + \omega_{f_i} |f_i\rangle \langle f_i| + \omega_{g_i} |g_i\rangle \langle g_i| \\ + \int_{-\infty}^\infty g_i [\alpha_i^*(\omega) A_i(\omega) |e_i\rangle \langle g_i| + \text{H.c.}] d\omega + \Omega_i [|e_i\rangle \langle f_i| e^{-i\omega_{l_i} t} + \text{H.c.}], \quad (5)$$

where ω_{l_i} is the frequency of the classical field in the i th cavity. Without loss of generality, we assume the atoms and the cavities have the same parameters, i.e., $\omega_{e_1} = \omega_{e_2} \equiv \omega_e$, $\omega_{f_1} = \omega_{f_2} \equiv \omega_f$, $\omega_{g_1} = \omega_{g_2} \equiv \omega_g$, $\omega_{c_1} = \omega_{c_2} \equiv \omega_c$, $\kappa_1 = \kappa_2 \equiv \kappa$, $\omega_{l_1} = \omega_{l_2} \equiv \omega_l$, $g_1 = g_2 \equiv g$, and $\Omega_1 = \Omega_2 \equiv \Omega$. In the interaction picture, the interaction Hamiltonian is given by

$$H_{I_i} = \int_{-\infty}^\infty g [\alpha^*(\omega) A(\omega) |e_i\rangle \langle g_i| e^{i(\omega_e - \omega_g - \omega)t} + \text{H.c.}] d\omega + \Omega [|e_i\rangle \langle f_i| e^{-i\Delta_l t} + \text{H.c.}], \quad (6)$$

where $\Delta_l = \omega_l - (\omega_e - \omega_f)$ is the detuning of the classical field. Assuming the atom is initially in the coherent superposition of the quantum states $|f_i\rangle$ and $|g_i\rangle$, and the cavity field is in the vacuum state $|0\rangle$, the initial wave function of the subsystem is given by

$$|\psi(0)\rangle_i = [\cos(\theta_i/2) |f_i\rangle + \sin(\theta_i/2) e^{i\varphi_i} |g_i\rangle] |0\rangle_i, \quad (7)$$

where $\theta_i \in [0, \pi]$, $\varphi_i \in [0, 2\pi]$ and $|0\rangle_i$ represents for the vacuum state of the i environments. $|1_\omega\rangle_i = A^\dagger(\omega) |0\rangle_i$ represents that there is one photon at frequency ω in the i environments. With at most only one excitation, the wave function of the subsystem at any time t can be written as

$$|\psi(t)\rangle_i = [E_i(t) |e_i\rangle + F_i(t) |f_i\rangle + G_i(t) |g_i\rangle] |0\rangle_i + \int_{-\infty}^\infty U_i(t, \omega) |g_i\rangle |1_\omega\rangle_i d\omega, \quad (8)$$

where $E_i(t)$, $F_i(t)$, $G_i(t)$, and $U_i(t)$ are the probability amplitudes which should be determined. Using the Schrödinger equation, we obtain

$$\dot{E}_i(t) = -ig \int_{-\infty}^{\infty} \alpha^*(\omega) e^{i(\omega_e - \omega_g - \omega)t} U_i(\omega, t) d\omega - i\Omega e^{-i\Delta t} F_i(t) \quad (9)$$

$$\dot{F}_i(t) = -i\Omega e^{i\Delta t} E_i(t) \quad (10)$$

$$\dot{G}_i(t) = 0 \quad (11)$$

$$\dot{U}_i(t) = -ig\alpha(\omega) e^{-i(\omega_e - \omega_g - \omega)t} E_i(t) \quad (12)$$

The differential equations can be solved as $G_i(t) = G_i(0) = \sin(\theta_i/2)e^{i\varphi_i}$. Performing time integration of Eq. (10) and Eq. (12) and substituting the results into Eq. (9), we obtain

$$\dot{E}_i(t) = - \int_0^t f(t-t_1) E_i(t_1) dt_1 - \Omega^2 \int_0^t e^{-i\Delta t(t-t_2)} E_i(t_2) dt_2 - i\Omega F_i(0) e^{-i\Delta t}, \quad (13)$$

where the correlation function $f(t-t_1) = \int_{-\infty}^{\infty} J(\omega) e^{i(\omega_e - \omega_g - \omega)(t-t_1)} d\omega$. $J(\omega)$ is the spectral densities, which is chosen as Lorentzian function

$$J(\omega) = g^2 |\alpha(\omega)|^2 = \frac{1}{\pi} \frac{g^2 \kappa}{(\omega - \omega_c)^2 + \kappa^2}. \quad (14)$$

In Eq. (14), $\tau_g = g^{-1}$ is related to the relaxation time of the system and $\tau_\kappa = \kappa^{-1}$ is the correlation time of the reservoir. When the correlation time of the reservoir is greater than the relaxation time ($\tau_\kappa \gg \tau_g$), the system is coupled to non-Markovian environments. Conversely, when the relaxation time is greater than the correlation time of the reservoir ($\tau_g \gg \tau_\kappa$), the system is coupled to Markovian environments. Substituting the spectral densities into the correlation function, the correlation function can be written as

$$f(t-t_1) = g^2 e^{-(\kappa+i\Delta)(t-t_1)}, \quad (15)$$

where $\Delta = \omega_c - \omega_e + \omega_g$ is the detuning of the cavity field. The integro-differential equation (13) can be written as

$$\dot{E}_i(t) = -g^2 \int_0^t e^{-(\kappa+i\Delta)(t-t_1)} E_i(t_1) dt_1 - \Omega^2 \int_0^t e^{-i\Delta t(t-t_2)} E_i(t_2) dt_2 - i\Omega F_i(0) e^{-i\Delta t}. \quad (16)$$

In Eq. (16), the first term is the interaction between the atom and the cavity field, which leads to the dissipation of the quantum system; the remaining terms are the interaction between the atom and the classical field. With the help of Laplace transform, we solve the integro-differential equation Eq. (16) exactly. The result is expressed by

$$E_i(t) = F_i(0) \sum_{k=1}^{k=3} c_k e^{s_k t}, \quad (17)$$

where s_k is the k th root of the cubic equation $s^3 + [i(\Delta + \Delta_L) + \kappa]s^2 + [g^2 + \Omega^2 + i\Delta_L(i\Delta + \kappa)]s + \Omega^2(i\Delta + \kappa) + ig^2\Delta_L = 0$, and $c_1 = -i\Omega(s_1 + i\Delta + \kappa)/((s_1 - s_2)(s_1 - s_3))$, $c_2 = -i\Omega(s_2 + i\Delta + \kappa)/((s_2 - s_1)(s_2 - s_3))$, and $c_3 = -i\Omega(s_3 + i\Delta + \kappa)/((s_3 - s_2)(s_3 - s_1))$.

3. THE ENTANGLEMENT BETWEEN THE ATOM AND THE CAVITY FIELD

Let us introduce the linear entropy to quantify the entanglement between the atom and the cavity field, which is defined as

$$S_A(\theta, \varphi, t) = 1 - \text{Tr}(\rho_A^2), \quad (18)$$

where ρ_A is the atomic reduced density matrix of each subsystem. The range of the linear entropy is between 0 for pure state and $1 - 1/d$ for completely mixed state, where d is the dimension of the density matrix (here $d = 3$). Using Eq. (8), we obtain the atomic reduced density matrix ρ_A as follows

$$\rho_A = \begin{pmatrix} |E_i(t)|^2 & E_i(t)F_i^*(t) & E_i(t)G_i^*(t) \\ F_i(t)E_i^*(t) & |F_i(t)|^2 & F_i(t)G_i^*(t) \\ G_i(t)E_i^*(t) & G_i(t)F_i^*(t) & 1 - |E_i(t)|^2 - |F_i(t)|^2 \end{pmatrix}. \quad (19)$$

In this paper, we calculate the average linear entropy with respect to all possible input states on the surface of the Bloch sphere as [38]

$$S_A^{av}(t) = \frac{1}{4\pi} \int S_A(\theta, \varphi, t) \sin(\theta) d\theta d\varphi. \quad (20)$$

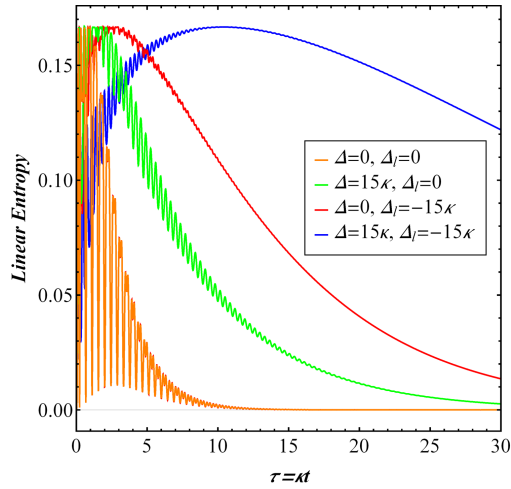

Fig. 2. The evolution of the average linear entropy as a function of the scaled time $\tau = \kappa t$ for different detunings in non-Markovian environments: $\Delta = 0, \Delta_I = 0$ (orange curve), $\Delta = 15\kappa, \Delta_I = 0$ (green curve), $\Delta = 0, \Delta_I = -15\kappa$ (red curve), and $\Delta = 15\kappa, \Delta_I = -15\kappa$ (blue curve). Other parameters: $g = \Omega = 10\kappa$.

Fig. 2 illustrates the evolution of entanglement between the atom and the cavity field over the scaled time $\tau = \kappa t$ in non-Markovian environments. In Fig. 2, the average linear entropy exhibits an oscillatory behaviour for the memory effect of non-Markovian environments. In the absence of the detuning, the average linear entropy decays rapidly. In the presence of the detunings, the average linear entropy first increases to a maximum and then gradually decreases. Fig. 3(a) shows the evolution of the populations of the states $|e\rangle$, $|f\rangle$, and $|g\rangle$ in Eq. (8) (P_e , P_f , and P_g) for the initial state $|f\rangle$ ($\theta = 0$). In Fig. 3(a), the populations of the states $|f\rangle$ and $|e\rangle$ decrease from one to zero and the population of the state $|g\rangle$ increases from zero to one. That is because the state $|f\rangle$ is transferred into the state $|g\rangle$ through the transition path $|f\rangle \rightarrow |e\rangle \rightarrow |g\rangle$ due to the dissipation of the cavities. From Eq. (8), we know that the atom and the cavity field are in the entangled state, when $0 < P_g(t) < 1$. In other words, the atom-field system will disentangle, when $P_g(t) = 1$. Fig.

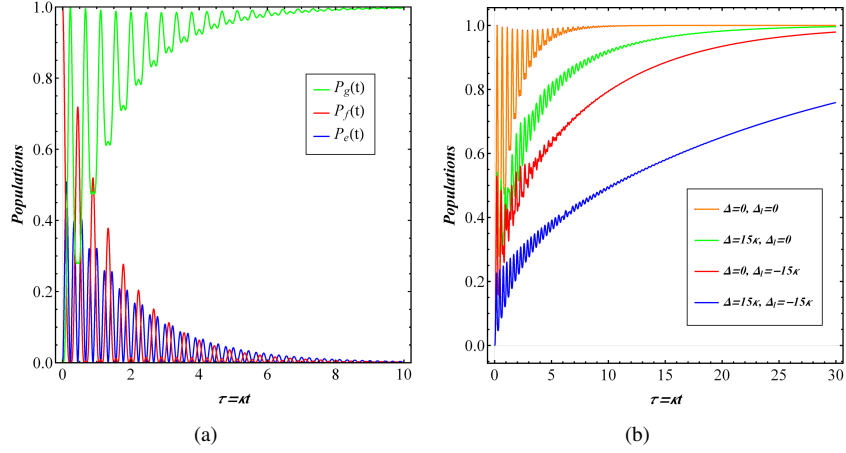

Fig. 3. (a) The evolution of the populations of the states $|e\rangle$, $|f\rangle$, and $|g\rangle$ as a function of the scaled time $\tau = \kappa t$ for the initial state $|f\rangle$: the population of the state $|e\rangle$ (blue curve), the population of the state $|f\rangle$ (red curve), and the population of the state $|g\rangle$ (green curve). (b) The evolution of the populations of the state $|g\rangle$ as a function of the scaled time $\tau = \kappa t$ for different detunings: $\Delta = 0, \Delta_I = 0$ (orange curve), $\Delta = 15\kappa, \Delta_I = 0$ (green curve), $\Delta = 0, \Delta_I = -15\kappa$ (red curve), and $\Delta = 15\kappa, \Delta_I = -15\kappa$ (blue curve). Other common parameters: $\Delta = \Delta_I = 0, g = \Omega = 10\kappa$, and $\theta = \varphi = 0$.

3(b) shows the evolution of the populations of state $|g\rangle$ over the scaled time $\tau = \kappa t$ for different detunings. It shows that the population of the state $|g\rangle$ increases from zero to one more slowly in the presence of detunings, i.e., the presence of detunings can preserve the entanglement between the atom and the cavity field. It is because that the presence of the detuning Δ (Δ_I) decreases the transition rate between the states $|e\rangle$ and $|g\rangle$ ($|f\rangle$ and $|e\rangle$). As a result, the decay of the entanglement between the atom and the cavity field becomes slow in the presence of detunings. In addition, the amplitude of the oscillations is associated with the intensity of the memory effect of non-Markovian environments. In Fig. 2, the linear entropy shows more intensive oscillations in the absence of the detuning. In other words, the detunings suppress the memory effect of non-Markovian environments. Hence, the detunings not only make the evolution of the system slow, but also suppress the the memory effect in non-Markovian environments.

In Fig. 4, we plot the linear entropy of the atom-field at the scaled time $\tau = 15\kappa t$, as a function of the detunings Δ and Δ_I for initial atomic state $|f\rangle$. Fig. 4 shows that when the detuning $\Delta = 0$ ($\Delta_I = 0$), the sign of the detuning Δ_I (Δ) has no effect on the decay of the entanglement. However, the decay of the entanglement can be suppressed, when the detunings satisfy the condition $\Delta \cdot \Delta_I < 0$. That means the decay of the entanglement can be suppressed greatly by choosing the sign of the detunings Δ and Δ_I .

In order to investigate the differences between the Markovian dynamics and the non-Markovian dynamics, we plot the evolution of the linear entropy between the atom and the cavity field over the scaled time $\tau = g t$ in Markovian and non-Markovian environments in Fig. 5. It shows that the linear entropy has an obvious oscillation and evolves more slowly in non-Markovian environments for the memory effect. In addition, the presence of detunings can preserve the entanglement between the atom and the cavity field both in the Markovian and non-Markovian environments.

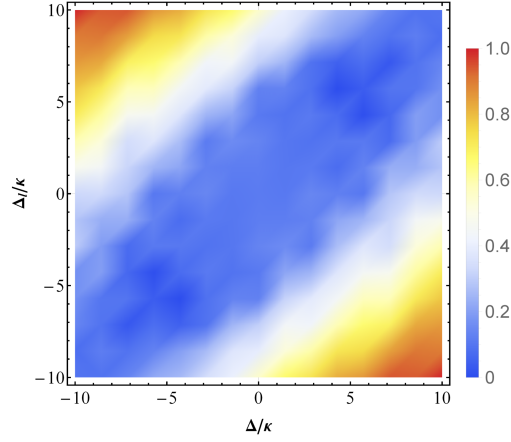

Fig. 4. The linear entropy of the atom-field at the scaled time $\tau = 15\kappa t$, as a function of detunings Δ and Δ_I for initial atomic state $|f\rangle$. Other parameters: $g = \Omega = 10\kappa$.

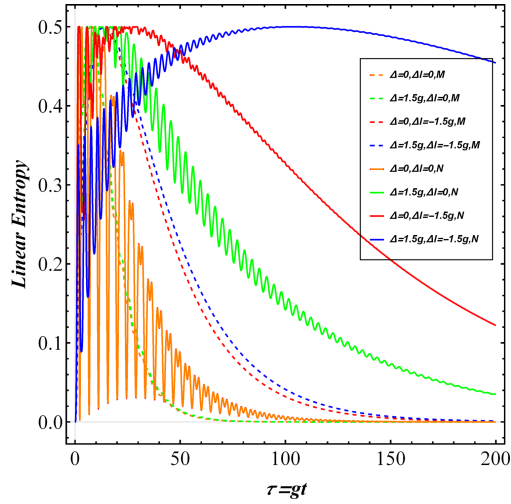

Fig. 5. The evolution of the linear entropy between the atom and the cavity field over the scaled time $\tau = gt$ for different detunings in Markovian and non-Markovian environments: $\Delta = \Delta_I = 0$ (orange curve), $\Delta = 1.5g, \Delta_I = 0$ (green curve), $\Delta = 0, \Delta_I = -1.5g$ (red curve), and $\Delta = 1.5g, \Delta_I = -1.5g$ (blue curve). The dashed and solid lines denote Markovian and non-Markovian environments, respectively. Other parameters: $\theta = \varphi = 0$.

4. THE ENTANGLEMENT BETWEEN TWO ATOMS

Due to the fact that the two subsystems are independent, the wave function of the total system can be written as

$$|\psi(t)\rangle = |\psi_1(t)\rangle \otimes |\psi_2(t)\rangle. \quad (21)$$

However, the atom and the cavity field in each subsystem are in the entangled state. This allows us to establish the entanglement between the two atoms by performing Bell state measurement on photons leaving the cavities. We consider the Bell state

$$|\Psi^+\rangle = \frac{1}{\sqrt{2}}(|0\rangle_1|1\rangle_2 - |1\rangle_1|0\rangle_2), \quad (22)$$

where $|1\rangle_i = \int_{-\infty}^{\infty} \Theta(\omega)|1_\omega\rangle_i d\omega$, $\Theta(\omega)$ is the pulse shape associated with the coming photon. Then, acting the projection operator $P_F = |\Psi^+\rangle\langle\Psi^+|$ on the wave function $|\psi(t)\rangle$ (after normalization), we obtain

$$\begin{aligned} |\psi_{AA}(t)\rangle &= \langle\Psi^+|\psi(t)\rangle \\ &= \frac{1}{\sqrt{N(t)}} [X_{12}(t)|e, g\rangle - X_{21}(t)|g, e\rangle + Y_{12}(t)|f, g\rangle - Y_{21}(t)|g, f\rangle \\ &\quad + (Z_{12}(t) - Z_{21}(t))|g, g\rangle], \end{aligned} \quad (23)$$

where

$$N(t) = |X_{12}(t)|^2 + |X_{21}(t)|^2 + |Y_{12}(t)|^2 + |Y_{21}(t)|^2 + |Z_{12}(t) - Z_{21}(t)|^2. \quad (24)$$

Here we have defined

$$X_{ij}(t) = E_i(t) \int_{-\infty}^{\infty} U_j(\omega, t) \Theta^*(\omega) d\omega, \quad (25)$$

$$Y_{ij}(t) = F_i(t) \int_{-\infty}^{\infty} U_j(\omega, t) \Theta^*(\omega) d\omega, \quad (26)$$

$$Z_{ij}(t) = G_i(t) \int_{-\infty}^{\infty} U_j(\omega, t) \Theta^*(\omega) d\omega. \quad (27)$$

In order to quantify the amount of entanglement between two atoms, we introduce the negativity [34], which is defined as

$$N(\rho(t)) = \frac{\|\rho^{TA}\| - 1}{2}, \quad (28)$$

where ρ^{TA} is the partial transpose of ρ and $\|X\| \equiv \text{tr}\sqrt{X^\dagger X}$ is the trace norm. Similarly, we calculate the average negativity with respect to all possible input pure separable states as

$$N^{av}(\rho(t)) = \frac{1}{16\pi^2} \int N(\rho(t)) \prod_{k=1}^2 \sin(\theta_k) d\theta_k d\varphi_k. \quad (29)$$

Fig. 6 (a) illustrates the evolution of the average negativity, as a function of the scaled time $\tau = \kappa t$ in non-Markovian environments. In Fig. 6 (a), the average negativity exhibits an oscillatory decay behaviour in the absence and presence of detuning for the interaction between cavities and environments. In the presence of the detunings Δ and Δ_I , the decay of the entanglement between two atoms becomes slow. It is because that the entanglement between the two atoms depends on the entanglement between the atom and cavity field, i.e., the disentanglement between the atom and the cavity field will lead to the disentanglement between the two atoms. From the results in section 3, we know that the presence of detunings can preserve the entanglement between the atom and the cavity field, namely, the detunings can preserve the entanglement between the two

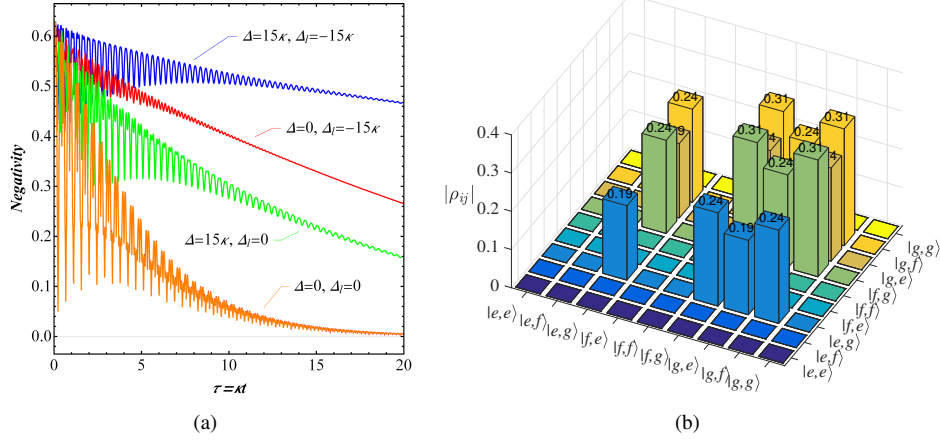

Fig. 6. (a) The evolution of the average negativity as a function of the scaled time $\tau = \kappa t$ for different detunings in non-Markovian environments: $\Delta = \Delta_I = 0$ (orange curve), $\Delta = 15\kappa, \Delta_I = 0$ (green curve), $\Delta = 0, \Delta_I = -15\kappa$ (red curve), and $\Delta = 15\kappa, \Delta_I = -15\kappa$ (blue curve). (b) Density matrix of the two atoms at $\tau = 1\kappa t$: $\Delta_1 = \Delta_2 = 15\kappa, \Delta_{I1} = \Delta_{I2} = -15\kappa$, and $\theta_1 = \theta_2 = \varphi_1 = \varphi_2 = 0$. Other common parameters: $g = \Omega = 10\kappa$.

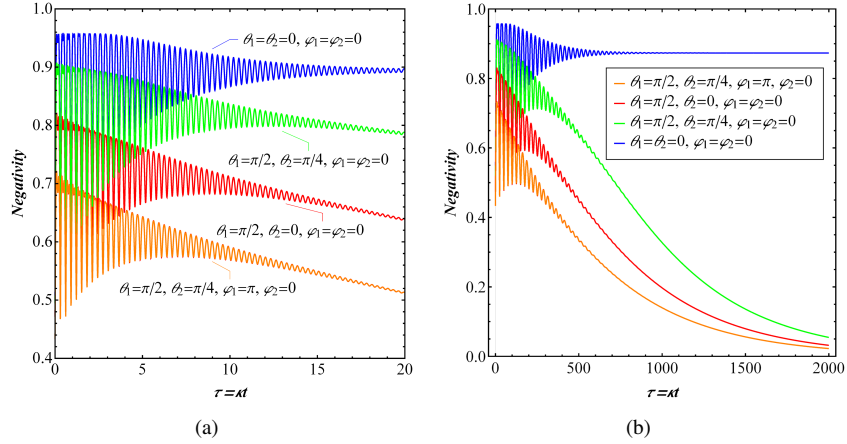

Fig. 7. The evolution of the negativity between the two atoms as a function of the scaled time $\tau = \kappa t$ for different initial atomic states in (a) non-Markovian environments and (b) Markovian environments: $\theta_1 = \theta_2 = 0, \varphi_1 = \varphi_2 = 0$ (blue curve), $\theta_1 = \pi/2, \theta_2 = 0, \varphi_1 = \varphi_2 = 0$ (red curve), $\theta_1 = \pi/2, \theta_2 = \pi/4, \varphi_1 = \varphi_2 = 0$ (green curve), and $\theta_1 = \pi/2, \theta_2 = \pi/4, \varphi_1 = \pi, \varphi_2 = 0$ (orange curve). Other parameters: (a) $\Delta = 15\kappa, \Delta_I = -15\kappa$ and $g = \Omega = 10\kappa$. (b) $\Delta = 0.15\kappa, \Delta_I = -0.15\kappa$ and $g = \Omega = 0.1\kappa$.

atoms. Therefore, by choosing the detunings Δ and Δ_l , a long-living stationary entangled state between two atoms can be created. Fig. 6 (b) shows the density matrix of two atoms at the scaled time $\tau = 1\kappa$. Due to the dissipation of cavities, the population of the state $|g, g\rangle$ is increased and the populations of the other states are decreased.

On the other hand, we consider the effect of the initial atomic states on the evolution of the entanglement between two atoms. In Fig. 7, we plot the evolution of the negativity, as a function of the scaled time $\tau = \kappa t$ for different initial atomic states in (a) non-Markovian environments and (b) Markovian environments. It is revealed that, when two atoms are in the quantum state $|f\rangle$ initially, the long-living stationary entanglement between two atoms is generated in both Markovian and non-Markovian environments. Furthermore, our further calculations show that when two atoms are in the same quantum state initially, a long-living stationary entangle state between two atoms can be produced in both Markovian and non-Markovian environments.

5. CONCLUSION

In summary, we have investigated the system formed by two independent dissipative cavities, each of which contains a Λ -type three-level atom. We solve the time-dependent Schrödinger equation of the subsystem and obtain the analytical results for the dynamical evolution of the atom-field system in non-Markovian environments. The results show that the atom and the cavity field are in the entangled state in non-Markovian environments and the decay of the entanglement is suppressed in the presence of detunings. We establish the entanglement between two atoms by performing Bell state measurement on photons leaving the cavities. It is revealed that, the presence of the detunings Δ and Δ_l can suppress the decay of the entanglement. By choosing the detunings and the initial atomic states, a long-living stationary entangled state between two distant atoms can be generated. Our results are useful to perform long-distance quantum communication, especially when long-living stationary entanglement is needed and the effect of environments cannot be neglected.

In the end, we briefly address the feasibility of experimental realization. In our proposed scheme, the two atoms are trapped in two distant cavities, respectively. That can be implemented experimentally by trapping atoms in cavity QED system [39, 40]. The leaking photons from the two cavities are mixed on a beam splitter, and two detectors D1 and D2 are set to the both output ports of it. The projection on the states is realized, when one of the two detectors is clicked. The Bell state $|\Psi^\pm\rangle = \frac{1}{\sqrt{2}}(|0\rangle_1|1\rangle_2 \pm |1\rangle_1|0\rangle_2)$ can be distinguished by the detectors D1 and D2. The detection scheme can be implemented in linear optical system experimentally [41].

Funding

National Natural Science Foundation of China (NSFC) (11474077, and 11675046), Program for Innovation Research of Science in Harbin Institute of Technology (A201411, and A201412), the Fundamental Research Funds for the Central Universities (AUGA5710056414), Natural Science Foundation of Heilongjiang Province of China. (A201303), and Postdoctoral Scientific Research Developmental Fund of Heilongjiang Province (LBH-Q15060).