

WHY MARKETS ARE INEFFICIENT:  
A GAMBLING “THEORY” OF FINANCIAL MARKETS  
FOR PRACTITIONERS AND THEORISTS

FEBRUARY 22, 2017

Steven D. Moffitt<sup>†</sup>

arXiv:1801.01948v1 [econ.EM] 6 Jan 2018

<sup>†</sup>Adjunct Professor of Finance, Stuart School of Business, Illinois Institute of Technology and  
Principal, Market Pattern Research, Inc.

## Abstract

The purpose of this article is to propose a new “theory,” the *Strategic Analysis of Financial Markets (SAFM)* theory, that explains the operation of financial markets using the analytical perspective of an enlightened gambler. The gambler understands that all opportunities for superior performance arise from suboptimal decisions by humans, but understands also that knowledge of human decision making alone is not enough to understand market behavior — one must still model how those decisions lead to market prices. Thus are there three parts to the model: gambling theory, human decision making and strategic problem solving. A new theory is necessary because at this writing in 2017, there is no theory of financial markets acceptable to both practitioners and theorists. Theorists’ efficient market theory, for example, cannot explain bubbles and crashes nor the exceptional returns of famous investors and speculators such as Warren Buffett and George Soros. At the same time, a new theory must be sufficiently quantitative, explain market “anomalies” and provide predictions in order to satisfy theorists. It is hoped that the SAFM framework will meet these requirements.

# 1 Introduction

Though we have over two centuries of financial market history and various theories of price formation, today there exists no single theory acceptable to market practitioners, yet rigorous enough to satisfy market theorists. The only major theory that purports universality is efficient market theory, which fails to explain some of the most important market phenomena, e.g. bubbles and crashes. That theory’s insistence that markets can’t be beaten, despite stellar careers of such luminaries as Warren Buffett and George Soros, makes it unacceptable to practitioners. The purpose of this article is to propose the *Strategic Analysis of Financial Markets (SAFM)* framework as a “theory” that will be acceptable to practitioners and theorists alike.

The perspective of this framework is best understood through the eyes of an enlightened gambler. That gambler uses the *Fundamental Laws of Gambling* together with knowledge of other market participants’ trading strategies to identify potentially superior investments, and then uses data analysis to extract winners. The gambler acknowledges that in the market game, prices are the result of strategic action by many players, some astute, some mediocre and some fools. The gambler understands that markets evolve in response to changing conditions, and in particular, that all static trading systems eventually get arbitrated out and fail.

The SAFM’s development is quite different from efficient market theory’s. It is a constructive theory, in the sense that its building blocks are human behavior and strategic thinking, and that it is not developed by assuming unrealistic axioms. It requires the theory of gambling, because only good gamblers succeed in the market game. It requires a strategic life cycle model (the *POPP*) to explain how markets evolve over time. And it requires *behavioral finance*, the study of financial decision making, to explicitly involve humans. These elements are combined logically to form the SAFM framework. A great advantage of the SAFM, and a major reason for its viability, is that a method for discovering trading edges (the *Strategic Analysis of Markets Method*) flows out of it naturally.

Here are the main elements of the framework, leaving explanations for undefined terms to later sections.

- *Potentially Profitable Gambling Systems (PPGS’s)*.
- The *Fundamental Laws of Gambling (FLOG)*.
- *FLOG*  $\longrightarrow$  *Grationality*.
- The *Pursuit of Profits Paradigm (POPP)* and strategic life cycles.
- Getting an Edge: Human Behavior and *Price Distorters*
- The *Strategic Analysis of Markets Method (SAMM)*  $\longrightarrow$  PPGS’s.

Brief discussions of each item in this list are contained in the following sections. But much is omitted in the interests of brevity — for a full development, see the books on which this summary is based, “The Strategic Analysis of Financial Markets, Volume 1: Framework” (Moffitt (2017b)) and “The Strategic Analysis of Financial Markets, Volume 2: Trading System Analytics” (Moffitt (2017c)).

## 2 Potentially Profitable Gambling Systems

In efficient market theory, prices are assumed to be unpredictable given past publicly available information. For prices represented as a time series with fixed, equally spaced times, one way to state this is

$$E[P_t + C_t | \mathcal{I}_{t-1}] = E[1 + R_t | \mathcal{I}_{t-1}] p_{t-1} \quad (1)$$

where

- $P_t$  is the price random variable for any asset at time  $t$ ,
- $C_t$  is the time  $t$  present value of its cash flows in  $(t - 1, t]$ ,
- $R_t$  is the random, security-independent return from time  $t - 1$  to time  $t$ ,
- $\mathcal{I}_{t-1}$  is an information set available at time  $t - 1$ ,
- $p_{t-1}$  is the realized (i.e. not random) price at time  $t - 1$ .

Condition (1) specifies that the expected next period value,  $P_t + C_t$ , of  $P_{t-1}$  given current  $\mathcal{I}_{t-1}$ , has the same rate of growth  $E[1 + R_t | \mathcal{I}_{t-1}]$  for all securities. It follows that no system which trades at time  $t - 1$  can earn an expected return better than  $E[R_t | \mathcal{I}_{t-1}]$  so that it's impossible to consistently "beat the market" by trading some subset of securities.

Because of the nature of scientific hypothesis testing, not to mention the near infinite dimensionality of  $\mathcal{I}_{t-1}$ , it is impossible to "prove" that (1) is false. The best one can expect is a demonstration that some trading systems have produced excess returns with high confidence. Thus the most credible evidence against efficient markets comes from revealed research showing that excess returns were earned over long periods.

We list below a few cases in which excess returns were reported. The descriptions are brief — readers desiring more information should consult Moffitt (2017b) or Shleifer (2000).

- (2.1) Three Year Mean Reversion.** In 1985, DeBondt and Thaler published research using 46 years of market history, which showed that excess returns occurred in a zero cost portfolio that sold at the end of each month the top decile of stocks ranked by previous 3 year returns and simultaneously bought the bottom decile. There were various criticisms of the study, including (1) whether returns were sufficiently large to offset costs of trading, and (2) the absence of a good explanation for why the largest returns occurred in January each year (De Bondt and Thaler (1985)).
- (2.2) Momentum.** Jegadeesh and Titman (1993) Titman attempted to reproduce the DeBondt & Thaler study and uncovered a remarkable pattern. The top decile of stocks ranked by 3-6 month returns had excess (positive) returns for an additional 6-12 months, and the bottom decile had inferior returns over the same period. Thus the pattern: 1 Year Momentum followed by 3 Year Reversal. The main objections to this study were (1) that data mining might have accounted for the effect, and (2) the effect would quickly be arbed out after this publication. Surprisingly, though, when Jegadeesh and Titman (2001) conducted a follow up study eight years later, they found that if anything, the momentum "anomaly" had strengthened. The authors ascribed that failure of arbitrage to behavioral anomalies, but under the proposed model of this paper, they were only partly correct.
- (2.3) Closed End Discount Puzzle.** The reconciliation of the closed-end pricing anomaly, referred to as the Closed End Discount Puzzle, has as yet no satisfactory EMT explanation, but a quite good behavioral explanation. The puzzle is that closed-end funds are generally initiated during bull markets, within 120 days of start up trade at a discount to book value, and continue trading at discount until fund dissolution or open ending, when they converge to book value. For details, see Shleifer (2000) which devotes an entire chapter to the topic.
- (2.4) Market Return vs. Prior Year New Issues.** A striking EMT anomaly published by Baker and Wurgler (2000) hints at cyclical stock patterns. They discovered that heightened levels of new equity issues predict poor next-year equity returns! For further discussion, see Shleifer (2000) or Moffitt (2017b).

None of these "anomalies" have good EMT explanations, but all have straightforward SAFM explanations.

For present purposes, a trading system is a family of functions  $\{f_t\}$  that maps a (possibly multivariate) set of prices  $\{P_t\}$  and *information sets*  $\{\mathcal{I}_t\}$ <sup>1</sup> to a stream of transactions  $\{f_t(P_t | \mathcal{I}_{t-1})\}$ . A basic requirement for inefficient markets is the existence of a *Potentially Profitable Gambling System (PPGS)* which is, simply, a trading system that is not a *martingale* with respect to some choice of information sets  $\{\mathcal{I}_t\}$ . For a PPGS, one also needs to know whether the expected return  $E[f_t(P_t | \mathcal{I}_{t-1})]$  at each time is positive, negative or zero, so that one can potentially buy in the first case, sell in the second and not trade in the third. Of course, prices need adjustment for prevailing interest rates in cases where that is an issue, but for cases the author has encountered, such adjustment has seldom been necessary. Translating into trader-speak, a PPGS is a trading system that relies on historical data to initiate a series of trades for which the expected value is  $\geq 0$  for all  $t$ .

A PPGS may be tradable or not, depending on the sizes of its expected returns, on its fees and slippage, on its riskiness, and so on.<sup>2</sup> The importance of the EMT anomalies (2.1)-(2.4) is that each supposedly yielded *tradable* returns that exceeded the market's. We remark in passing that publications which tout “winning systems” or “tradable anomalies” seldom show estimates of actual returns and risks. Systems developers, take note!

### 3 The Fundamental Laws of Gambling (FLOG)

Before presenting the two fundamental laws, it's important to dispel an urban myth — that all gamblers lead roller-coaster lives unacceptable to prudent people. That may be true of compulsive gamblers, but it is definitely false for professional gamblers. Good gamblers get rich; bad gamblers go broke.

There are only two principles in our *Fundamental Laws of Gambling*. In their imperative forms, they are

- (3.1) **FUNDAMENTAL LAW:** Never bet unless you think you have an edge.
- (3.2) **WAGERING PRINCIPLE:** Pick a fractional amount of your capital consistent with a drawdown or loss condition and a minimum return condition, and use estimates of your edge to chose a betting fraction.

The justification of these principles is based on an analysis of fixed fraction gambling systems. To illustrate our approach, we present a simple fractional betting system developed in Moffitt (2017a). Assume that a biased coin with probability of heads  $p > 0.5$  and tails  $q = 1 - p$  is flipped repeatedly, and assume stochastic independence of flips. At each flip, a fixed fraction  $f$  of current wealth is wagered at odds  $d > 0$ <sup>3</sup>, so that wealth after the flip is  $1 + df$  or  $1 - f$  times initial wealth. With this setup, one can show

- (3.a) For a fixed number of bets and  $p > 1/(1 + d)$ , the average return is greatest for a strategy consisting of betting everything each time. However, the chance of winning becomes vanishingly small as the number of bets increases, i.e. ruin is asymptotically certain. Therefore, this strategy is unacceptable.

---

<sup>1</sup>An information set  $\mathcal{I}_t$  is a set of information that is known at time  $t$ . This theoretical construct mirrors the reality that trading systems make bets on future outcomes conditional on those of realized variables.

<sup>2</sup>The SAFM does not use variance, except as a proxy, to measure risk.

<sup>3</sup>That is, you receive  $d$  when you win and pay 1 when you lose.

- (3.b) The strategy that wins money at the maximum rate consists of betting a fraction  $f = p - q/d$  of current wealth on heads at each turn when  $p - q/d > 0$  and  $f = 0$  when  $p - q/d \leq 0$  (see Appendix A for the Kelly calculation). In its practical usage, betting the Kelly fraction  $f = p - q/d > 0$  can lead to unacceptably large drawdowns.
- (3.c) There is a critical fraction  $f_c$  such that the betting of any greater fraction on heads assures ultimate ruin, and the betting of any lesser fraction assures ultimate unbounded growth of wealth.
- (3.d) When faced with a betting situation in which the probability of winning at each turn varies with random probability  $P$ , then the optimal fraction is  $f = p - q/d$  with  $p = E[P]$ .
- (3.e) When  $p$  is unknown and  $p - q/d > 0$ , using  $f_n = \bar{X}_n - (1 - \bar{X}_n)/d$ , yields the same asymptotic growth rate as  $f = p - q/d$ .
- (3.f) Given known probabilities  $p_i > 0.5$  of heads at each turn and odds  $d_i$ ,  $i = 1, 2, \dots, n$  for a sequence of bets, the strategy that wins money at the maximum rate consists of wagering the fraction  $f_i = p_i - q_i/d_i$  at the  $i^{\text{th}}$  bet when  $f_i > 0$  and nothing otherwise.
- (3.g) Volatility and drawdowns can be reduced with some loss of optimal growth through the use of *Fractional Kelly* betting. Fractional Kelly is straightforward: bet a fraction  $\alpha f$  at each turn, where  $0 < \alpha < 1$  and  $f$  is the Kelly fraction.

For readers who want more detail on Kelly strategies, especially fractional Kelly, the best reference at this writing is unquestionably MacLean et al. (2011).

Analogous of points (3.a)-(3.g) exist when bets involve security prices, not coin flips. Despite their relevance, we do not pursue such generalizations here and again refer interested readers to MacLean et al. (2011).

The important takeaways from Kelly Criterion betting are that (1) using it produces optimal growth, but results in huge drawdowns, (2) betting the critical fraction or greater leads to asymptotic ruin, and (3) approximate optimal growth given drawdown constraints can be achieved by fractional Kelly betting.

## 4 Grationality

Grationality (=“gambling rationality”) for simple bets is easily understood through an example. Suppose that a trader with capital \$1,000 at time 0 faces the prospect of a series of independent bets each paying +1 with probability  $p > 0.5$  and  $-1$  with probability  $q = 1 - p$ . The best long run growth of capital occurs if a fraction  $f^* = p - q$  is bet at each opportunity. But as stated earlier, optimal growth using  $f^*$  comes at a considerable cost: large drawdowns.

Large drawdowns are unacceptable for investors and most traders, leading to the search for alternative betting systems. The reasons are that (1) even a modest probability of markets having evolved to make a system unprofitable creates the incentive to liquidate during drawdowns, and (2) an individual whose funds are managed has *agency* issues that encourage liquidation of fund shares. Is this one reason that Warren Buffett invests through a closed-end fund, so that these liquidation incentives do not lead to share redemptions?

Luckily, an obvious means of controlling drawdowns is available: find a fraction  $f$  that maximizes expected growth, while having a probability no larger than  $u$  of producing a drawdown (loss) exceeding  $d$  ( $l$ )? To pose the problem analytically, let

$X = \{X_1, X_2, \dots, X_n, \dots\}$  be independent and identically distributed random variables

$$X_i = \begin{cases} 1 & \text{with probability } p \\ 0 & \text{with probability } 1 - p, \end{cases}$$

and given  $X$ , let the function  $G(f; X, n)$  in equation (2) be the growth rate of capital over the first  $n$  bets, assuming starting capital  $W_0$ :

$$\begin{aligned} G(f; X, n) &= \frac{1}{n} \log \left( \frac{W(n; f, X)}{W_0} \right) \\ &= \bar{X}_n \log(1 + f) + (1 - \bar{X}_n) \log(1 - f), \end{aligned} \quad (2)$$

where  $\bar{X}_n = \frac{1}{n} \sum_{i=1}^{i=n} X_i$  and

$$\begin{aligned} W(n; f, X) &= W_0 \prod_{i=1}^{i=n} (1 + f)^{X_i} (1 - f)^{1 - X_i} \\ &= W_0 (1 + f)^{\sum_{i=1}^{i=n} X_i} (1 - f)^{n - \sum_{i=1}^{i=n} X_i}. \end{aligned} \quad (3)$$

Next, consider controlling risk using either of two *loss functions*  $\mathcal{L}(W, n)$ : (1) the *worst loss function*  $\mathcal{L}(W, n)$  or (2) the *drawdown loss function*  $\mathcal{D}(W, n)$ . Both of these are expressed in terms of a generic wealth process  $W_n$ ,  $n \geq 0$ . These loss functions are defined as follows:

1. The ‘‘Worst Loss’’ Function.

$$\mathcal{L}(W, n) = \log(W_0) - \min_{0 \leq s \leq n} \log(W_s), \quad (4)$$

which is the log of the greatest relative loss up to time  $n$ , and  $W_0$  is the initial capital. Note that (4) is always nonnegative provided that  $W_n > 0$  for all  $n$ .

2. The ‘‘(Peak-to-Trough) Drawdown’’ Loss Function.

$$\mathcal{D}(W, n) = \max_{0 \leq s \leq n} \left\{ \max_{0 \leq u \leq s} \log(W_u) - \log(W_s) \right\}, \quad (5)$$

which is the log of the greatest relative loss from a previous high up to time  $n$ . Note that (5) is always nonnegative provided that  $W_n > 0$  for all  $n$ .

With this notation, the optimal betting fraction  $f$  should be a solution to the optimization problem

$$\begin{aligned} &\text{Maximize } E[G(f; X, n)] \quad \text{with respect to } f \\ &\text{subject to } 0 \leq f \leq 1 \text{ and} \\ &P[\mathcal{L}(W(f; X, n), n) \geq d] \leq u, \end{aligned} \quad (6)$$

with  $\mathcal{L}(W, n) = \mathcal{L}(W, n)$  or  $\mathcal{D}(W, n)$  or the asymptotic version as of (6) as  $n \rightarrow \infty$ .

For prices following a geometric Brownian motion, this problem for  $\mathcal{L}(W, n) = \mathcal{D}(W, n)$  and  $u = 0$  was solved in Grossman and Zhou (1993), but for discrete price series, Klass and Nowicki (2005) showed their solution to be suboptimal. Incidentally, the Grossman-Zhou solution is essentially an algorithm for *portfolio insurance*.

Four glaring differences between this simple set up and the real world are that (a) real-world wagers do not have simple  $\pm 1$  gains, (b) most wagers (= investments) occur in continuous auction markets that allow trading at any time the venue is open, (c) many systems bet a varying number of times, as is the case if a position is held for a random number of days, and (d) wagers are usually part of a portfolio the positions of which can be entered and exited asynchronously.

## 5 Miller’s Critique of Efficient Market Theory

This section has important background material needed in the development of the SAFM. It presents a critique of EMT published in Miller (1977) that presented an alternative, constructive approach to the evolution of market prices under specific conditions. Although Miller’s model has largely been ignored, it has lost none of its relevance. The reason is that its constructive approach describes *why* and *how* prices are formed, and demonstrates straightforward explanations for several well-known EMT “anomalies.” It is an early model of the type to which the SAFM aspires.

Miller based his analysis on the “Winner’s Curse” in auctions. The idea of the winner’s curse is simple; in the presence of heterogeneous estimates of value, the most optimistic bidder wins the prize, and therefore “overpays.” The use of “overpay” is not necessarily a statement about “fair value,” since overpaying in this instance means that a subsequent auction conducted immediately will clear at a lower price. Astute traders intuitively know about the winner’s curse, and in fact, have a rule to avoid it — when investors clamor after a security, the best long term value, other things being equal, is obtained by selling it to them.

Consider Figure 1, which depicts three distributions of price estimates for the security. The “average” opinion in each case is \$50, but the dispersions are different. Under conditions that Miller specifies, that (1) the number of sellers of the stock,  $N$ , is fixed, (2) that the number of potential buyers  $M \gg N$  is large compared to demand so that  $N/M \ll 1$ , and (3) that there is no short selling, Miller argues that only the most optimistic of potential buyers will determine the clearing price. Thus, the clearing price will exceed average price estimate among potential buyers.

Miller opines that this winner’s curse effect can explain a number of EMT anomalies:

### (5.1) Risk and return will be negatively correlated.

Provided that risk in a stock is proxied by greater divergence of opinion, prices of risky stocks should be relatively greater than average ones and therefore have sub par returns. This is the opposite of the EMT prediction that purchasers of risky securities will be compensated for those investments with appropriate risk premiums. This EMT “anomaly” is the basis of the recent popularity of “low volatility” strategies. See Haugen and Heins (1975) and Haugen and Baker (1991).

### (5.2) IPO’s will have short term price appreciation and poor long term returns.

IPO’s are an insider’s game. Underwriters typically price the issue by offering it to institutional clients (“insiders”) before the IPO. That price is typically too low in order to (1) allow insiders a chance to profit, (2) protect the underwriter against losses if the entire issue can’t be placed, and (3) encourage speculators to overpay



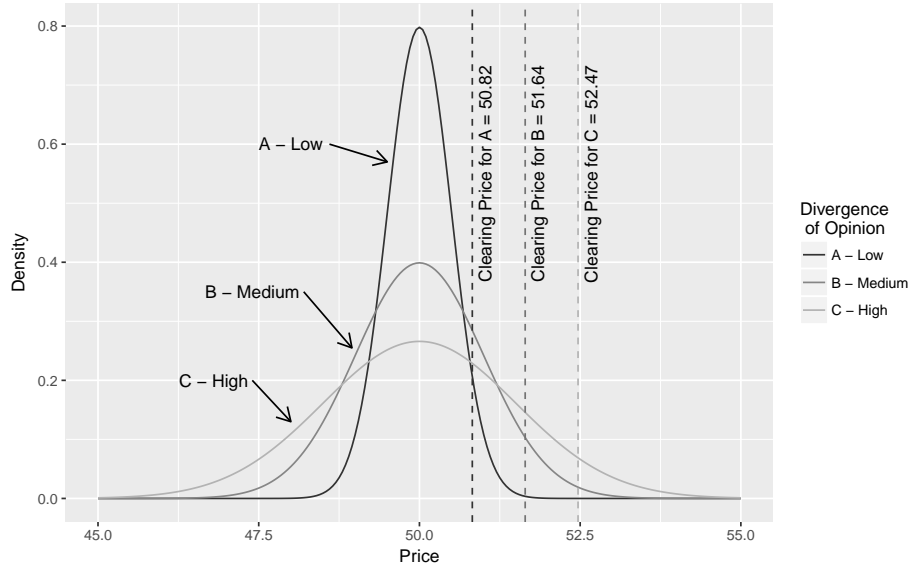

Figure 1: A plot that explains the Winner’s Curse effect in asset pricing. Assuming an asset that has small turnover and a large group of potential buyers and for which there is no short selling, Miller argues that the clearing price will be set by the most optimistic buyers, that is, those who have the highest estimates of its value. The figure shows three distributions of divergence of opinion, the curve with the highest peak showing low divergence, the middle curve showing medium divergence and the flattest curve showing the greatest divergence. The three vertical lines, reading from the left, mark the 95th percentiles of the low, medium and high divergence of opinion distributions.

when listed trading begins.<sup>4</sup> This explains the reason that IPO’s typically rally after the offering. Miller argues that initial optimism leads to high divergence of opinion, but the eventual removal of uncertainty about the stock’s prospects leads to a narrowing of that divergence, hence poor future performance relative to other stocks. Thus the old joke about an IPO ... it stands for “It’s Probably Overpriced.” See Foerster and Karolyi (2000).

**(5.3) High turnover will lead to low returns.**

It has been shown that high turnover (high volume) is associated with low returns in Cooley and Roenfeldt (1975). Provided that high turnover is associated with divergence of opinion, then this result is consistent with Miller’s model.

**(5.4) Short selling will attenuate the winner’s curse effect in riskier securities.**

Short selling effectively increases the number of shares. Since, short sellers are often pessimistic on a stock’s prospects, the supply side of the supply and demand curve is shifted to the right, lowering the clearing price. In view of the widespread shorting of stocks as part of index arbitrage, however, it isn’t clear if this anomaly still holds.

<sup>4</sup>Listed trading begins after all insiders have already bought; some of them sell in a price fixing auction that is held prior to listed trading in order to set the opening price, or in later trading on the listed market.

## 6 The Pursuit of Profits Paradigm (POPP)

There is only one goal common to all trading strategies — they seek to profit. In the previous section, we reviewed the Miller (1977) model, which showed, inter alia, that heterogeneous estimates of prices combined with limited supply of stock led to inefficient clearing. This section concerns a similar model, in which uncoordinated attempts to profit lead to life cycles in markets and strategies, a paradigm called the *Pursuit of Profits Paradigm (POPP)*. The POPP is based on the unremarkable premise that investors are mainly motivated by a desire for wealth, and that the impatient among them “chase after riches.” Perhaps surprisingly (except to Warren Buffett), the predictability of the chase leads chasers to losses!<sup>5</sup>

### 6.1 The Strategic Point of View

Description of the POPP requires two new terms,

**strategic plan.** A general plan of action for trading that lacks specifics.

**strategy.** A specific plan that can be used to generate trades. One that is specific enough to be programmed is called a trading algorithm.

In trading jargon, a strategy is a set of rules or an algorithm that a trader, investor or computer uses to buy and sell. Strategies are often semi-formal schemas for action. For example, a strategy such as “In a bull market, buy popular, high-beta stocks; in a bear market, selectively short formerly popular stocks but hold them only for a short period,” requires a determination of the type of market, bear or bull, and of criteria to determine “popularity” of stocks and holding periods for trades. While this form can be useful for discretionary traders, it is not specific enough for algorithmic traders. We call a strategy that lacks the specificity necessary for algorithmic trading, but which by a selection of specific *parameters* can be traded algorithmically, a *strategic plan*.

To convert a strategic plan into a trading algorithm, the best way is to perform analysis on market data. In the strategic plan of the previous paragraph, for example, three sets of criteria are needed, (1) ones that identify the market type as bull, bear or neither, (2) ones that identify a stock as popular, and (3) ones that determine for a given market type and stock, when to buy and when to sell or short. If as the result of statistical analysis, we specify (1), (2) and (3) by

- (1) Defining a bull market as one having positive 6 month returns, a bear market as one having negative two month returns on the Standard & Poors 500 Index and “neither bull nor bear” if these criteria point in opposite directions,
- (2) Selecting NASDAQ stocks with 6-month beta and weekly turnover ratio in the upper decile of their respective distributions, and
- (3) In bull markets, buying \$10,000,000 in NASDAQ popular stocks and selling when the bull ends, and in bear markets, shorting \$7,000,000 in NASDAQ formerly popular stocks for at least a week and remaining short as long as one month returns are negative and buying back when this criterion ends,

---

<sup>5</sup>... which is reminiscent of an old trader’s saying: “The pigs get fat and the hogs get slaughtered.”

then the strategic plan has given rise to a trading algorithm. Of course, this plan is not entirely specific, i.e. the allocation to stocks is not detailed, beta can be specified in several ways using daily or weekly prices, the time and place of buying and selling is not specified, and so on. Using the strict requirement that a trading algorithm be produced, only a code snippet implementing the algorithm would convert the plan into an algorithm.

## 6.2 State Variables in the POPP

The POPP describes the evolution of strategic plans through the changes in *state variables*. Here is a list, along with their abbreviations:

**RET:** Capitalization-weighted returns.

**VOL:** Capitalization-weighted volatility (= standard deviation) of returns.

**SR:** Sharpe ratio =  $\{ \text{RET} - (\text{Risk-free Rate}) \} / \text{VOL}$ .

**SP\$:** Aggregate capitalization.

**POP:** Number of implementors.

**LEV:** Capitalization-weighted leverage.

**SDIV:** Strategy diversity as a measure of heterogeneity in the population of strategies.

**SLINK:** Strategy linkage with a range from weak (= few links) to strong (= many links), considered as the degree to which the strategies in the plan have “cascading” links to similar and dissimilar strategies.

**SROB:** Strategy robustness (robust  $\rightarrow$  fragile) expressing the probability of a very large loss in a short time.

## 6.3 The POPP Lifecycle

Figure 2 shows the cyclical evolution of the *POPP*, starting with box “A” at the bottom and proceeding clockwise. The four phases of the POPP are (1) Phase (A) - Eureka!, (2) Phase (B) - Early Copycat, (3) Phase (C) - Late Copycat, and (4) Phase (D) - Crash. The +’s (++) and –’s (--) indicate positive (extreme) and negative (extreme) expected values. Thus the expected Sharpe Ratio (SR) is positive in the *Eureka!* and *Early Copycat* phases, negative in the *Late Copycat* phase and not applicable in the *Crash* phase.

In Phase (A), a new trading idea is “born” when one or more innovators devise a strategic plan and/or develop strategies that implement it. Returns (RET) and Sharpe Ratios (SR) are high, but most other state variables besides SROB are low (which is good). The strategic plan is quite profitable in this phase, but perhaps surprisingly, may not be as profitable as Phases (B) or (C). Phase (B), the Early Copycat begins when (a) copycats, attracted by high Sharpe Ratios or the rumor mill, begin trading the plan, (b) serendipitous discoverers enter the arena, and/or (c) existing players expand their allocations. In any case, the effect is an expansion of funds (*SP\$*). The number of users (*POP*) at the start is small, but grows toward the end as discussed further below. Although robustness (*SROB*) remains high, it becomes smaller as the phase proceeds. The expected (in contrast to realized) Sharpe Ratio (*SR*) reaches an apex due to improvements in strategy implementations outweighing increased *SP\$*, but thereafter declines for the duration of the evolution. Phase (B) ends when the strategic plan

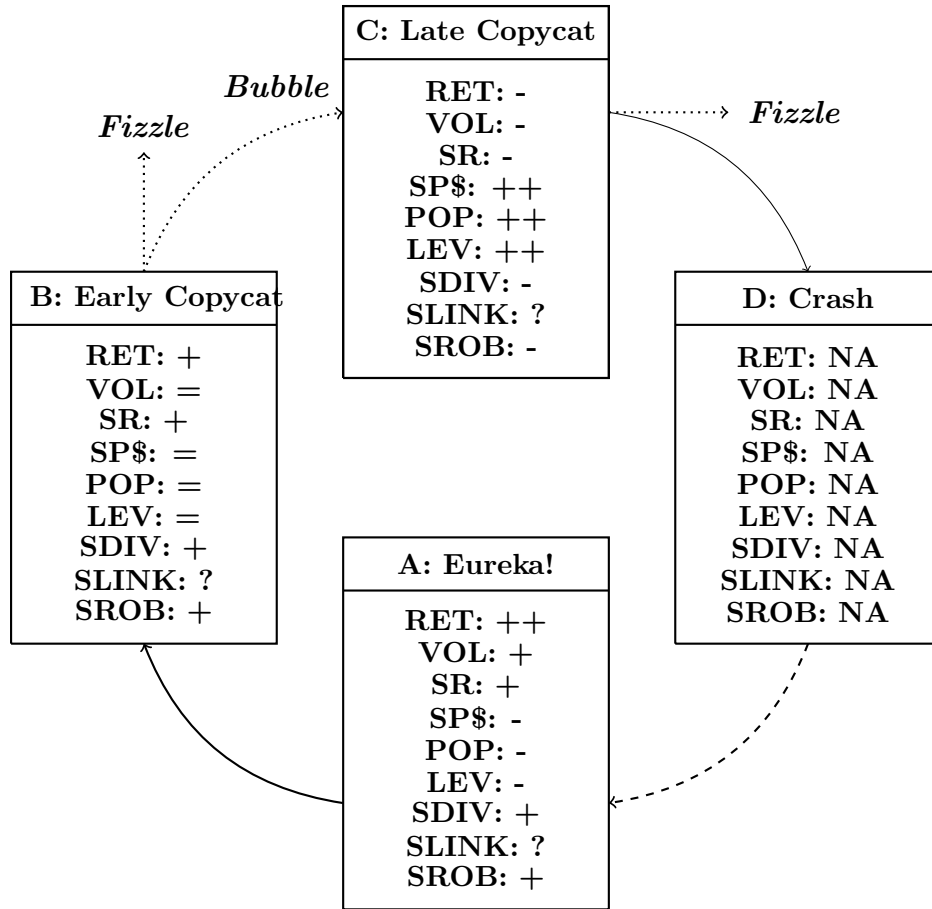

Figure 2: A Strategic Lifecycle Diagram for the Pursuit of Profit Paradigm. See the text for an explanation.

capacity is reached. The arrow from Phase (B) to (C) indicates that allocations begin to exceed the strategic plan capacity because there is *overinvestment* or *crowding*. The difference between this and the previous phase lies in the dominance of new copycats that destabilize the system and/or lead to an excessive level of funding. In phase (C) all that is required for a correction or crash is an event that triggers a reversal in the generators of profit, revealing previously occult fragility in the system. The final phase is a market correction or crash, brought on by financial fragility that results when the strategic plan capacity is exceeded. The reason that this phase is so much shorter than the preceding ones is that the system has become increasingly susceptible to contagion as a result of high leverage (*LEV*), decreased diversity (*SDIV*), high linkage with other strategies that implement the strategic plan (*SLINK*), and low robustness (*SROB*). Each of these developments makes the likelihood of contagion and the extent of its severity greater.

A few observations about the transition from Phase (C) to the crash are insightful for trading. First, it is common that there is high volatility in returns near the end of Phase (C). In this model the main reason this happens is that “enough” traders try to liquidate or reduce their positions, that the markets can’t clear easily. Of course, there can be many reasons for reduction or liquidation — margin calls, losses in other strategies that

mandate overall reduction in the portfolio, excess leverage, poor performance of the strategies, believing that a correction is coming, and so on. Second, the crash always entails a reduction in liquidity. While small traders can escape, larger traders cannot, and this suggests that traders ought to measure their risk by calculating the number of trades or days required to fully exit under normal circumstances, with allowances for reduced liquidity during crises. Reduced liquidity has the further effect of making larger moves in short periods more likely. Third, assuming that other markets are performing normally prior to the crash, contagion is likely to occur only if strategies are linked to other strategies in a network. Such links need not be based on fundamentals, e.g. losses in one strategy can trigger reductions in others. Fourth, the longer Phase (C) lasts, the greater the likelihood of a severe correction or crash. The reasons: (1) positions are much larger, making it difficult to unwind them in a short period of time, resulting often in a “stampede to the exits,” and (2) links to external markets grow in the chase after riches, increasing the likelihood of contagion in mature POPP’s.

We restate the premise of the POPP — that strategic evolution is impelled by “chases after riches.” If one accepts this paradigm, it says something profound about markets, for won’t there always be investors who “chase after riches?” Here are a couple of implications. First, in markets characterized by short-termism, there will be lots of bubbles, corrections and crashes because an accelerated chase after riches quickens the pace of POPP cycles. This suggests that a longer-term winning strategy consists of buying “value.” Second, the wider market’s fragility will be a function of “strategy linkage,” as developed in Moffitt (2017b).

*Example 6.1 (POPP in Action: Pairs Trading).* Pairs trading is really simple — buy undervalued securities and sell overvalued securities in equal dollar amounts, then exit both sides simultaneously when prices adjust sufficiently. The pairs method we use is presented in Moffitt (2017c).

The dark line in Figure 3 cumulates the average daily return over pairs and therefore represents the return that a single representative pair would have. There is no adjustment for commissions or slippage, so the curve is NOT TRADABLE. But for purposes of understanding the dynamics of the trade, it’s simpler to exclude the distorting effects of commissions and slippage. The gray line is the DJIA index. Our intention is to identify market events associated the curve’s gains and losses, and to use them to describe the strategic evolution of the pairs trade as an instance of the *Pursuit of Profits Paradigm (POPP)*. To match the dates to market events, refer to Table 1.

At this level of presentation, the most important dates are 1987-10-19 (the Worldwide Crash of 1987), 1998-08-17 (the Russian Financial Crisis), 2000-03-10 (the apex of the Dot-com Bubble), 2001-09-11 (the 9/11 attacks) and 2003-03-12 (the nadir of the post-911 correction).

In Figure 3 observe the largely linear appearance from 1980-01-02 to 1998-08-17. Except for the dramatic jump the day of the Crash of 1987, there is no other change like that which occurs during that period. About a month later on 1998-09-23 and directly as a result of the Russian default, the giant hedge fund *Long Term Capital Management (LTCM)* failed. On that date LTCM refused a rescue offer by Goldman Sachs, AIG and Warren Buffett, but was rescued instead by a group of creditors in a deal put together by the New York Federal Reserve. It’s important to understand that at the time LTCM was the shining star of the hedge fund world, and the fear was that if it wasn’t rescued, the ensuing turmoil might lead to a credit crisis (LTCM had massive positions in credit markets). The main question for us is: what increased the profitability of the pairs trade after 1998-08-17?

Note first that before 1998-08-17, there was a tendency for the pairs trade to perform better during and immediately after a market correction or crash. Jensen et al. (2002) and Bouchaud and Potters (2001) have documented that declines generally happen faster than market rallies,

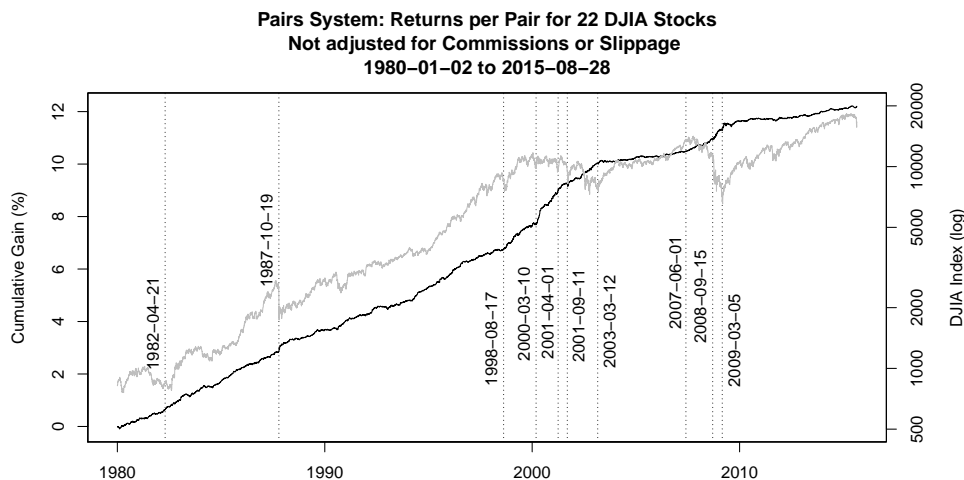

Figure 3: P&L Plot for a Pairs Trading System: 1969-12-31 to 2015-08-28. See text for details.

Table 1: Significant Dates for Pairs Trading.

Date	Event Description
1982-04-21	CME S&P 500 futures begin trading.
1987-10-19	Black Monday, the Worldwide Crash of 1987.
1998-08-17	Russian Financial Crisis, currency devaluation & default.
1998-09-23	LTCM declares bankruptcy (not shown).
2000-03-10	The beginning of the Dot-com Bubble crash.
2001-04-01	U.S. stock markets begin trading in pennies.
2001-09-11	World Trade Center attacks.
2003-03-12	U.S. stock market bottoms out.
2007-06-01	Beginning of the subprime CDO and CMO collapse.
2008-08-15	Lehman Brothers insolvency.
2009-03-01	Bottom of the Global Credit Crisis of 2008.

and that downside correlations among stocks are stronger than upside correlations. Although there is no accepted explanation for these asymmetries, they seem to provide an explanation for the better performance of the pairs trade during downturns, provided one accepts that increased correlations favor the pairs trade. Better performance after downturns is observable at various points of Figure 3 prior to 1998-08-17.

A window of understanding is afforded by the experience of LTCM around the time it failed. That date (1998-09-23) is not marked on the equity curve, but it is near the bottom of the DJIA drop that occurred after the Russian default on 1998-08-17. According to Chincarini (2012), pgs 58-60, LTCM near the time of its failure had a massive short position in equity index straddles, the net vegas being -\$25MM in U.S. equities and about the same for Europe equities. This means that for each 1% increase in implied volatility, LTCM would lose \$50MM, assuming that the U.S. and Europe had equal volatility increases. LTCM's entire position in this trade consisted

of short straddles on stock indexes and short-term hedges maintained dynamically using futures and options to neutralize portfolio delta and gamma. The long term options were written with banking counterparties and those counterparties had the right to demand more collateral. But LTCM's entire position in this trade depended on the five year volatility of 20 being too high relative to the historical 13. In a nutshell, LTCM was short volatility using illiquid, long-dated options with short-term hedges that dynamically maintained delta and gamma neutrality.

As rumors circulated that LTCM was in trouble, LTCM's counterparty banks starting demanding more collateral for their long-dated straddles. The situation became so serious that the straddles LTCM had purchased at implied volatility 20 were being priced at 45. The cost of that repricing to LTCM:  $25 * \$50MM = \$1BB$ ! Under ordinary circumstances collateral of \$1BB might have been manageable, but at the time LTCM had lots of other positions that were also unraveling.

To understand how LTCM's problems might affect the wider market, consider the strategic possibilities of a representative counterparty bank. They are long a straddle from LTCM. If LTCM collapses, that in-the-money short straddle goes in the worst case to zero, meaning that the bank doesn't get paid what it's owed. That's why they were demanding more collateral, in order to recoup some of the loss after a default. But now consider what happens if LTCM fails and the LTCM short straddle really does go to zero. If the bank hedged or transferred the position to other traders, then they and those they hedged with are collectively long those straddles and a dynamic delta hedge by holders of those long straddles requires purchasing stocks when prices are dropping and selling when they're rising. But this concave strategy favors the pairs trade!

Whenever a significant credit-related event occurs, the price impact on the wider market depends to a large degree on the web of creditor/debtor relations. In the case of the abrupt P&L increase in the pairs trade after 1998-08-17 we surmise that there was a concave strategy at work, one that was precipitated by the Russian default and its aftermath. Further, that effect was greater than the temporary effects after market downdrafts, as an examination of the chart between 1998-08-17 and 2003-03-12 should convince. Based on personal experience, I believe part of the effect was due to many new trading firms' discoveries of the pairs trade around that time.<sup>6</sup> As more traders used the pairs trade, it had the impact of reducing spreads in the pairs, thus creating better profitability for extant pairs.

Finally, what caused the accelerating profitability of the pairs trade after the Dot-com Bubble burst on 2000-03-10? Since the turn in the market coincides with the top of the Dot-Com Bubble, it seems clear that the Dot-com crash is somehow involved. Here is a guess based on work I was doing at the time. Many options traders I knew were long puts at incredibly high prices, and the majority of them delta hedged those positions. So as we discussed earlier, they were employing a concave strategy. And that, I believe, was enough to have an effect on the pairs strategy. Ironically the put buying strategy made no money according to people I knew, because the drop in NASDAQ stocks was so gradual that eroding options premium ate up all the directional gains. Was this due to concave hedging strategies as well?

Can one detect footprints of the POPP in Figure 3? Here is what I think. From 1982 to about 1995, the strategy wasn't well known and high commissions precluded all but a few professionals from using it, Phase (A). There is a marked increase in returns from 1995 to 1997 and this happens during the ascendancy of hedge funds, the Dot-com Bubble and ending with the collapse of LTCM. I suspect that hedge funds had more to with this quickening than other factors; this period is Phase (B). From March 2000 to March 2003 is Phase (C). Note the rapid ascent of the P&L in the very last bubble phase with low volatility. We cannot know the outcome had 9/11 not occurred, but I suspect the strategy would have failed to continue its gains even earlier. Note that after 9/11, the gains and losses of the pairs strategy are inverse to the DJIA, much as they had been before 1982.

Figure 4 shows Phase (C) in more detail. Note the steady rise after the Russian default

---

<sup>6</sup>I consulted with two groups looking into the trade around years 1998 to 2000. I even supervised an MBA project on pairs then.

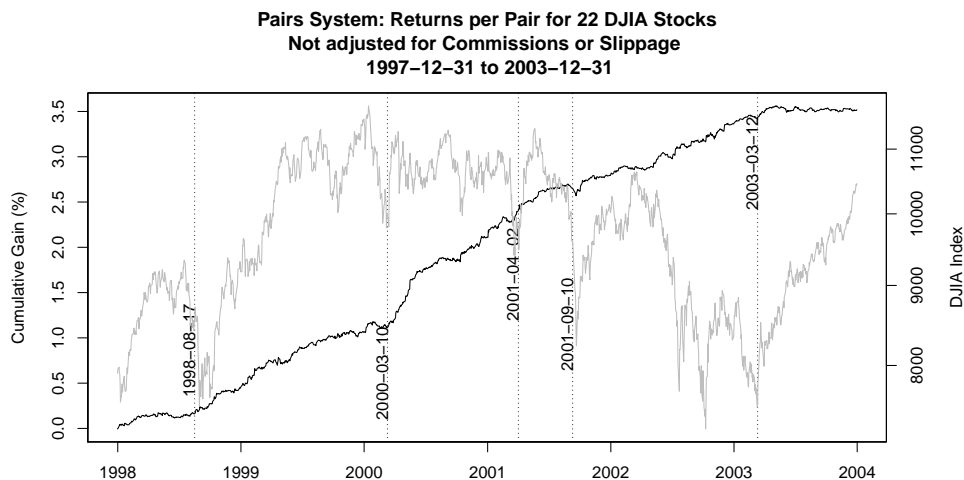

Figure 4: P&L Plot for a Pairs Trading System: 1997-12-31 2003-12-31. See text for details.

(1998-08-17) and the collapse of LTCM (1998-09-23) to the beginning of the Dot-com Bubble collapse that started on 2000-03-10. Although Figure 3 shows a modest increase in the equity curve after March 2003, that gain is illusory. As is shown in Moffitt (2017c), the costs of commissions and slippage cause a steady loss up to 2008, a gain during the crisis of 2008, and a steady loss thereafter.

Incidentally, what caused the acceleration in Figure 3 in 2007-2008? Well, obviously the Credit Crisis of 2008, but also the collapse of many hedge funds. During that period, the extinction of the simple pairs strategy was involved, since the acceleration started in the early part of 2007 when many hedge funds were already under pressure. Does the pairs strategy forecast crashes?

■

Consider the impact of *POPP* phases on Kelly betting. In the discrete setting, the Kelly fraction increases linearly with the success probability  $p$ . Thus, one should make the largest bets in Phases (A) and (B). And if can't make accurate predictions of, or efficiently escape from phase (D), bets in Phase (C) should be smaller due to lower  $p$ . We note that this prescription has important exceptions that are discussed in Moffitt (2017b).

In summary, the *POPP* is a useful model for traders, at least conceptually. Although not discussed here, there are different paths that the evolution can take. For example, the lifecycle can fizzle at any stage. A strategy can die with a whimper instead of a crash. Some thoughtful traders have addressed this, albeit in terms quite different from the *SAFM*. An example is the “reflexive” model of George Soros. But the biggest problem with the *POPP* is the issue of estimating the phase of a strategic plan, a problem we don't address here.

## 7 The Importance of Predictability

Two players, 1 and 2, each wager \$1 and give it to a referee who will pay the winner. Then they privately write either the letter  $H$  or the letter  $T$  on pieces on paper, seal them in envelopes, and then hand them to the referee. The referee opens the envelopes



and awards player 1 with the \$2 if the letters are the same, and player 2 the \$2 if the letters are different. In tabular form, the players' net gains are

- (+1, -1) if  $(H, H)$  occurs,
- (-1, +1) if  $(H, T)$  occurs,
- (-1, +1) if  $(T, H)$  occurs, and
- (+1, -1) if  $(T, T)$  occurs.

where the notation  $(i, j)$  means that player 1 wins  $i$  and player 2 wins  $j$ .

**Discussion:** While this game is superficially one of coin tossing, it differs from coin tossing in important ways that facilitate a discussion of real games as opposed to artificial mathematical games. An obvious difference is the intrusion of human decision making into what is otherwise a random, mechanical process. Thus the human element is an integral part of this game, which changes everything.

The letters  $H$  and  $T$  will denote the choices made by 1 and 2. Thus each player has a choice between two "strategies,"  $H$  and  $T$ . Table 2 shows the payoffs classified by the players' strategic choices.

Table 2: Normal Form of the Matching Pennies Game.

		Player 2's Strategies	
		H	T
Player 1's Strategies	H	(+1, -1)	(-1, +1)
	T	(-1, +1)	(+1, -1)

The display of the players' payoffs in Table 2 is called the *normal form* or *strategic form* of the game. Note that in this game, the net amount won in all cases is zero – games having this property are called *zero-sum* games. If the referee charged a fee for his services, the game between 1 and 2 would be *negative-sum*. Because of the strategic symmetry of this simple game, neither player has any a priori advantage. Thus the game should be "fair," meaning that in some sense the expected return to either player ought to be zero.

And indeed, that this game is fair and that the expectation to either player *who plays perfectly* is zero, follows from a theorem in von Neumann and Morgenstern (2004). Roughly speaking, that theorem states that there always exists a strategy for each player that guarantees the best expected return (Fudenberg and Tirole (1991); Myerson (1997)).<sup>7</sup> In the case of the guessing game, a perfect strategy consists of using the result of the flip of a fair coin to write  $H$  or  $T$ , thus ensuring that the expected return is 0 to a player using this strategy. Note the subtlety of this result; if one player flips a coin and the other always chooses  $H$ , an obviously exploitable strategy, the expected return to either player is still zero! And that is pretty much where game theory leaves it —

<sup>7</sup> This expected return is called the *value* of the game. In general, such a strategy is not unique.

neither player has an advantage.

1. Since nothing was said about how many times the game will be played, the game specification is incomplete. Suppose that the players sign a contract to play the game 100 times, which can be managed by having each player give the referee \$100 before play begins. After each round of play, the referee awards \$2 to the winner; if one player quits the game before 100 games have been completed, the other player is awarded the remaining money. Consider the following strategy for 1 – always write  $H$ . After a few games, 2 will notice that 1 always chooses  $H$ , and he will begin to play  $T$ . If 1 persists in always choosing  $H$ , 2 wins all the remaining games. Obviously, this is a foolish strategy for 1, but the gist of this example is that 1 might have an exploitable nonrandom pattern of choice. For example, suppose that without realizing it, player 1 writes  $H$  about 60% of the time. By randomly choosing  $T$  a fraction  $x$  of the time, 2 expects to win

$$((0.6x + 0.4(1 - x)) - (0.4x + 0.6(1 - x))) * \$200 = (0.4x - 0.2) * \$200$$

over the 100 games, which is positive provided  $x > 0.5$ . Thus 2 has a positive expectation in this case. If, for example,  $x = 0.6$ , his expected gain is \$8. Think that this is impossible? Think again — Claude Shannon invented an electronic device<sup>8</sup> that beats most people by detecting simple patterns in their choices!

Another variant is this: player 1 as he writes his number, tells player 2, “I’m going to write  $H$  with probability 0.75.” It is then possible for 2 to gain an edge by writing  $H$ . Of course, it is assumed here that 1 is honest. When one of the players makes some statement or takes some action that implies a choice of  $H$  with probability  $p$  such that  $p \neq 0$ ,  $p \neq 0.5$ , and  $p \neq 1$ , it is called a *partial disclosure* action. When the player specifies or implies  $p = 0$  or  $p = 1$ , it is called a full disclosure<sup>9</sup> action. Partial or full disclosure actions in this game are exploitable.

2. Suppose player 2 hires a spy to watch player 1 write a choice – and the spy lets player 2 know what was written before 2 writes his choice. What is 2’s return in this case? Obviously, it’s +1 per bet, since 2 will always write the other letter, thus winning \$1 each time the game is played.
3. Cheating by influencing the referee is also a possibility. Either player can bribe the referee by offering him or her a payment of less than \$1. This only works if the honest player does not detect the cheating. Situations that might arise in such cases can be imagined, i.e., the referee can produce a forged version of the cheater’s choice if necessary.

These methods of gaining advantage are quite general in zero-sum games. The first case occurs because of *skill* in playing the game. Game theory generally studies best play by both parties within the framework of the rules, yet is strangely silent on outcomes due to differences in skill and cheating. In most athletic games such as tennis, golf and slalom skiing as well as in board games like chess, poker and backgammon, skill in the talented can be developed by hard work. The development of expertise is the whole point of these games.

---

<sup>8</sup> Shannon, Claude. “A Mind-Reading (?) Machine.” Bell Laboratories Memorandum, March 18, 1953.

<sup>9</sup> The terms *full disclosure* and *partial disclosure* are not standard in game theory. They are sufficient, however, for the limited purposes of this presentation.

In the case of partial or full disclosure actions, one player has information that the other does not have, obtained in the example above by pattern recognition, voluntary disclosure by an opponent or by immoral conduct, spying or bribing the referee. This case illustrates a phenomenon that occurs in real zero-sum games, *competition for the second move*. Competition for the second move in zero-sum games occurs because the player that moves second with full knowledge of the first player's choice, essentially a full disclosure action, generally gains an advantage.

You're probably wondering what this example has to do with financial markets. Actually, each of these paradigms has analogs in financial markets.

For example, when participants in financial markets reveal information about their strategies, they allow others the potential to profit from that information, essentially by having the advantage of the second move. Consider, for example, the fact that some mutual fund managers sell losing stocks prior to quarterly reports to avoid investor backlash. This information opens the possibility of profiting by buying those stocks just before the end of a quarter. Why? Because excessive selling by the funds can "oversell" those stocks and drive them below their "fair" values. Of course, it is assumed here that excessive supply moves a market below its "fair" price.

An interesting example occurred many years ago in the most popular financial show of the era, "Wall Street Week," hosted by Louis Rukheyser. The program featured a witty, attention-getting monologue by Rukheyser in which he poked fun at market follies of the previous week. Later, he and market guru guests would chat in a homey room with modestly appointed furniture, lamps and fixtures. Guests would be asked for their market wisdom, especially for any hot tips. In a series of articles written between 1985 and 1993, well-respected market analysts Dorfman (1985) and Johnson (1993) analyzed these recommendations. Their analyses revealed that recommended stocks would generally rise starting about three weeks before the program, continue for a few days after its airing and decline significantly until 3 to 6 weeks after the show, and these moves were excessive relative to market averages. When experienced investors were asked to explain this pattern, they suggested that savvy investors would inquire as to the show's guests in upcoming weeks, learn what stocks they liked and begin buying them. They would then sell into anticipated demand after the show. Another explanation was that guests were generally invited because the sectors they specialized in were "hot," and were due to reverse that trend. And, of course, there is the rational possibility that gurus would share their picks with other gurus, either returning a favor or expecting the favor to be returned later.

Spying in the markets happens all the time. One form is the hiring of a trader, software developer or other significant player in order to "steal" proprietary trading ideas. While theft of trading ideas is governed in the U.S. by intellectual property law, such agreements have a short life-span (usually a year) and are difficult to enforce because improvements or reprogramming can get around the agreement.

I don't have any direct knowledge of "bribing the referee," but instances are widely reported. For instance, Johnson (2010) reported that several investment banks "worked with" rating firms to gain lenient treatment of mortgage derivatives. Yes, this was indeed a blatant conflict of interest by the rating companies, but to date no one has suffered criminal penalties. Though it does not easily fit into this category, there are well-publicized instances of "rigging the game." A recent, and particularly egregious case of this sort is the "Eurodollar scandal of 2012" (Wikipedia (2012)). The scandal

involved price rigging by a number of market-maker institutions.<sup>10</sup> In a quote attributed to Andrew Lo at MIT by O’Toole (2012),

“This dwarfs by orders of magnitude any financial scam in the history of the markets.”

The foregoing discussion of market realities should not obscure the message of this section — that in zero-sum games, partial or full disclosure actions confer the advantage of the second move to astute players. In these cases, then, the astute have potentially winning strategies in otherwise fair games.

## 8 Getting an Edge: Human Behavior and Price Distorters

Up to this point, it’s been assumed that our grational investor has an edge<sup>11</sup> which is exploited efficiently using grational principles and the POPP. “Fine,” you say, “but how do I get an edge?” In fact, if that question were to go unanswered, the SAFM’s value would be minimal. Therefore, beginning with this section and for the rest of this article, an answer is provided.

One popular answer is: learn how people make mistakes using investor psychology, or as it’s known in the scholarly literature, “behavioral finance”, and derive an edge therefrom. Indeed, for our grational investor, knowledge of investor psychology is essential. But investor psychology alone does not an edge make — that takes strategic thinking and gamesmanship.

### 8.1 Mostly Human Behavior

This section presents briefly some of the important findings about human decision making discussed in Moffitt (2017b).

Popular theories model the mind as a *dual process, associative machine*. The associative machine organizes memories, beliefs and constructs of reality in a massive network with links formed according to nearness in time, attribute classifications, emotional reactions, likes and dislikes, etc. When presented with a sensory or mentally-generated stimulus, the associative machine attempts to find a *coherent* explanation based on its extant web of associations. Learning cannot be effective if the mind completely revises its beliefs with every dissonant piece of information; it follows therefore that people revise their beliefs by discounting new information. The big question is: how does this discounting affect Bayesian updating of beliefs? Many studies provide an answer, that humans revise their beliefs slower than Bayesian rules do, a bias known as the *belief revision bias*.

The *dual process* theory models thinking as a product of collaboration of two minds, the *reflexive*, primitive *System 1* and the *reflective*, conscious *System 2*. System 1 is a massively parallel system that takes sensory and brain-generated information to make effortless, rapid judgments below the conscious threshold. System 1, however, is difficult to program consciously, especially since it makes some decisions using emotions and affect (deciding purely by “liked” or “disliked”). System 2 on the other hand, is

---

<sup>10</sup>LIBOR rigging was akin to alleged point-spread fixing by umpires and referees in sports betting. When bookies have tremendous exposure to a game’s outcome, it helps to have a “friendly” referee. Fixing is especially easy in basketball, since a few strategic calls can flip the point spread without changing the winner.

<sup>11</sup>That is, the expected returns on his portfolio of bets exceeds risk-free returns.

the conscious, effortful, programmable, plodder portion of the mind. It is involved in such things as mental calculations and abstract reasoning, operations that drain mental energy. While this simplistic introduction suffices for this article, serious quantitative traders should read the definitive introduction to this material: Kahneman (2011), “Thinking, Fast and Slow.”

In the late 1960’s, Daniel Kahneman and Amos Tversky became interested in the “rational man” model that had become popular in economics in the 1960’s, and began conducting experiments of its basic quantitative decision making model, *utility theory*. By the mid 1980’s, they had discovered that people do not decide using utility theory, and in Kahneman and Tversky (1979) proposed *prospect theory*<sup>12</sup> to approximate human decision making. But they are best known for discovering *heuristics* and *biases* that lead to violations of utility theory. The best known are (1) *representativeness*, an heuristic that chooses the best matching pattern, (2) *availability*, an heuristic that chooses using the most easily recalled instances, and (3) *anchoring*, an heuristic that biases choices toward a reference point. For examples, see Kahneman (2011) or Moffitt (2017b).

More important for finance, however, are the biases discovered by Kahneman, Shafir, Statman and Thaler: (1) the *status quo bias*, (2) the *endowment effect*, (3) *loss aversion*, (4) *mental accounting*, (5) the *disposition effect* and (6) framing effects. Briefly, the status quo bias expresses the human preference for the status quo (no change) to superior alternatives. The endowment effect is the human tendency to value the same object more if it is owned than if it is not. Loss aversion is the near universal preference to avoid losses, even if such action gives away considerable edge. Mental accounting refers to a compartmentalization of financial activity into *mental accounts* in which gains or losses in any one account are not aggregated with gains or losses in the others. The disposition effect is the tendency for investors to sell too early and hold too long, violating the long-standing trader’s injunction to “cut your losers and let your winners run.” Framing refers to the manner in which a problem is posed; a problem posed in terms of number of lives saved and the same problem posed in terms of lives lost, will often evoke two different decisions.

A larger catalog of heuristics and biases important for trading is contained in Chapters 6 & 7 of Moffitt (2017b); here we observe (tautologically) that human behavior lies behind all market anomalies and patterns. The view of this article is that while knowledge of behavior is necessary for system developers, it is not sufficient — that requires the analysis of trading strategies and their interactions.

We conclude this section with a brief discussion of two important pieces of research that are seldom mentioned in the behavioral literature. The first is the study of heuristics and biases in monkeys. Somewhat surprisingly, monkeys exhibit loss aversion, the status quo bias, the endowment effect and framing effects! Implication — in humans these are probably System 1 biases that are *very* hard to reprogram. The second is research by Hilbert (2012) which shows that a Shannon information-theoretic model can explain the *belief revision bias*. The implication is that imperfect human storage and retrieval of memories gives rise to the *belief revision bias*, and therefore that the belief revision bias is an integral part of human learning!

These and other human heuristics, biases and behaviors lead to partly predictable strategic behavior, and therefore to *potentially profitably gambling systems!*

---

<sup>12</sup>And proposed later in Tversky and Kahneman (1992) an improved model, *cumulative prospect theory*

## 8.2 Price Distorters

A price distorter is any exogenous news, constraints on trading, widely held beliefs, widely used strategies, or other regular market phenomena that have potential price impacts. It is difficult to appreciate this concept without some examples, but the core idea is this. All exogenous or endogenous happenings important to a market have the potential to “distort” prices, in the sense that prices would have been higher or lower in their absence. Many market participants unnecessarily limit the scope of this idea to concrete occurrences like dividend announcements, stock splits and so on. But it has much wider scope. For example, some strategies are price distorting, e.g. portfolio insurance or risk aversion. Structural factors such as the prohibition on shorting by mutual funds can be distorting. Conventions established in the effort to organize markets (rules) such as futures and options expirations are potentially price distorting. The introduction of a new financial instrument, e.g. the S&P 500 index future in August, 1982 can be price distorting. And so on.

We identify three classes of price distorters that occur commonly: (1) event, (2) strategic and (3) rule-constrained. A well-known event type was discovered by Bernard et al. (1989). That study found that after surprising earnings announcements, there was price drift for at least 60 trading days in the direction indicated by the surprise. A clear-cut example of a strategic price distorter is portfolio insurance (Moffitt (2017b)), the strategy of writing dynamically replicated puts on portfolios. Portfolio insurance is widely believed to have been the main cause of the Worldwide Stock Market Crash of 1987. See Example 8.1 for a rule-constrained distorter. Distorters are often hybrids, e.g. the Tax Day Trade described in Moffitt (2017d) that has event and rule-constrained origins.

Many other examples of price distorters are contained in Moffitt (2017b). The following example involves a factor whose origins are in U.S. tax law that produces end-of-year tax selling, and which can be exploited by a known strategy.

*Example 8.1 (Price Distorter: End of Year Tax Selling).* U.S. tax law allows deductions of no more than \$3,000 per tax year against income, so that if, say, a net of \$9,000 were lost from stock sales, only \$3,000 could be used as a deduction against current income. In subsequent tax years the additional \$6,000 could be used to offset capital gains in stocks or as offsets against income. For this reason, investors who want to realize stock gains often prefer to sell them together with losing stocks in a joint transaction that loses no more than \$3,000. But the law has a further provision that prevents the strategy of tax selling followed by immediate repurchase — the wash sale rule. It states that stocks sold as part of an offset cannot be repurchased for 30 days after the sale (with exceptions that are unimportant to this discussion; if you need to do tax selling, you need to read the tax law carefully or consult a financial professional).

In practice, brokers and tax professionals advise using these rules as follows. After a tax sale involving the sale of stocks with capital gains of  $\$x$  and the sales of stocks with capital losses of  $\$x + \$3,000$  or less, the investor bullish on one of the stocks should find a “close” substitute (the IRS has rules for this) and buy it. Then after 30 days, sell that stock and repurchase the original. This strategy is so common that it has a name: a *tax swap*. The strategy makes sense for an investor who has a large capital gain in a stock that he or she is bullish on, because the repurchase establishes a new, higher basis that reduces the future tax burden. And contrary to the optimal EMT strategy for using these rules (Constantinides (1983)) investors typically defer decisions on tax sales and tax swaps until December. Such last-minute-ism is characteristic of investors, especially when taxes are involved.

This tax-selling strategy has been implicated in the January effect, first published by Banz (1981) who discovered that small stocks had large returns when bought in the old year and held

only for a short period in the new year. The reason, some speculated, is that end of year tax selling differentially affected small stocks. See also Example 9.1, the *Tax Day Trade*.

■

## 9 The Strategic Analysis of Markets Method (SAMM)

The SAMM has six steps:

- (9.1) Select potential price distorters for trading systems.
- (9.2) Assemble datasets to investigate the price impacts associated with the price distorters.
- (9.3) If Step (2) shows significant price impacts, formulate strategic plans therefrom.
- (9.4) Convert each strategic plan to a trading algorithm.
- (9.5) Perform backtesting on the trading algorithms and iterate Steps (9.3)-(9.5) as necessary.
- (9.6) Upon the completion of iteration, locate the strategic plan in the POPP cycle and follow the evolution forward.

These steps are unremarkable except for the first and last— all successful systems developers employ some version of them. The value of the SAMM lies in its systematic approach to generating hypothetical trading ideas without any data analysis, using what we call price distorters, and in its requirement of following the strategic life cycle using POPP. But the efficient employ of distorting factors comes at a price — it requires a good working knowledge of market history and *market ecology*.

*Example 9.1* (The Tax Day Trade). Example 8.1 was an example of a rule-constrained distorter associated with tax law. Since tax law affects most U.S. citizens, this potentially large group could easily move stock markets if tax and stocks were affected. The table below shows major changes in tax law since 1954 (compliments of Wikipedia):

- (i) **Capital Gains Tax Rate:**
  - 1954-1967:** Flat 25%.
  - 1968-1977:** Variable, but significantly increased
  - 1978-1980:** Variable, but maximum 28%.
  - 1981-1986:** Flat 20%.
  - 1987-1986:** Variable, with maximum at 28%.
- (ii) **Dividend Taxation:**
  - 1954-1984:** At individual tax rate.
  - 1985-2002:** At individual tax rate with maximum of 50%.
  - 2003-2015:** Flat 15%.
- (iii) **Other Tax Changes since 1974:**
  - 1974:** Employee Retirement Income Security Act of 1974 (ERISA)
    - \* Established *Individual Retirement Accounts* (IRAs) with restrictions.
    - \* Deadline for deposit, tax day.
  - 1981:** Economic Recovery Tax Act of 1981 (Kemp-Roth Act).
    - \* Allowed all working taxpayers to establish *Individual Retirement Accounts* (IRAs)
    - \* Deadline for deposit, tax day.
    - \* Expanded provisions for employee stock ownership plans (ESOPs)
  - 1986:** Tax Reform Act of 1986.
    - \* Lowered individual tax rates for upper brackets, raised for lower.

Capital gains rates will have an impact, making stocks held for the mandated minimum period (one year at this writing) more attractive. Thus lowering of rates would be expected to boost stock prices. Dividend taxation would affect the attractiveness of dividend-paying stocks, favoring such stocks when dividend tax rates are below the ordinary income rate. Neither of these would seem to have immediate impacts except when the law changes. However, the ERISA law of 1974 and Kemp-Ross Act of 1981 have potential to impact markets, since establishment of individual retirement accounts could result in increased demand for stocks.

The law that would be expected to have the greatest impact is Kemp-Ross, since it allowed average tax payers to create account on or before the deadline for individual income tax payments. Furthermore, one might expect procrastination in establishing such accounts, just as investors procrastinated in end of year tax selling. Thus one would expect large numbers of accounts to be established at the deadline (usually April 15). This suggests testing stock returns around the deadline each year.

This trade is an hybrid of *event* and *rule-constrained* types. For event types, one locates all events at time zero (in this case, tax day), forms an aligned dataset of events and their nearby prices or returns and performs a multivariate analysis to discover tradable patterns. Performing such an analysis, we find that a major positive return occurs the day after tax day, as shown in Figure 5.

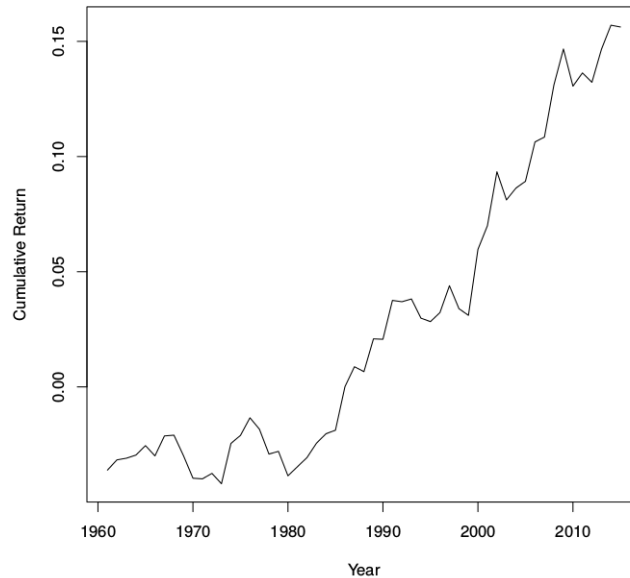

Figure 5: Cumulative returns from buying the S&P 500 index on the close of U.S. tax day and selling on the close one day later. Commissions and slippage not included.

The figure shows cumulative returns for the day after tax day for the 56 years 1960-2015. This strategy can be realized approximately (omitting commissions and slippage) by buying the close of S&P 500 futures<sup>13</sup> on tax day each year, and selling on the close one day later. Note the strikingly different behavior of cumulative returns after 1984 — the curve ascends steadily. Despite being a one day trade, it has averaged about 1/2% per year since 1980.

Using the hypothesis of concerted establishment of IRA's on the deadline day due to investor procrastination, many brokers would be too busy with the paperwork on tax day, and defer buying until the next day!

■

<sup>13</sup>Of course, S&P 500 futures did not exist until April 21, 1982. Details, details . . . , luckily irrelevant in this case. We also note that commissions were far higher than today during much of this period, making the trade unprofitable for non-professionals until lower commissions were generally available.



We give the results of another SAMM analysis in an example which is fully developed in Chapter 14 of Moffitt (2017c). The price distorter of Step 1 is an event type: expirations of Eurodollar futures.

*Example 9.2* (Two Systems for Eurodollar Futures Developed Using the SAMM). Eurodollar-System 1 holds long or short Eurodollar positions and should be profitable with efficient execution. Its Cumulative P&L curve before commissions is shown in Figure 6. and a summary of

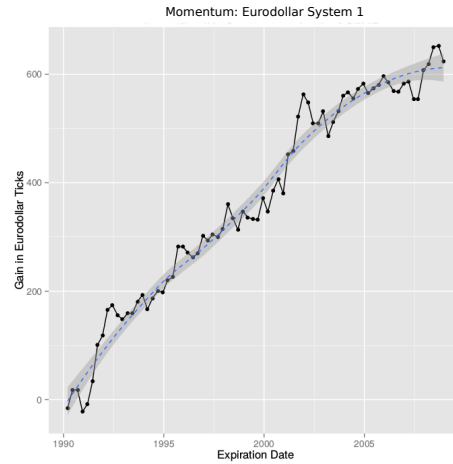

Figure 6: Cumulative gains for the Eurodollar-System 1 trade. Source: Moffitt (2017c)

the system's characteristics is shown in the Table below. Separate lines are shown for (1) long trades, (2) short trades, and (3) all trades. Column meanings are shown in Table 3.

	np	npi	maxdd	pnlpp	ir	pnltot	sdpnl	winpct	runs	runspvu
Long	41	41	-65.00	10.96	0.45	449.52	24.38	65.85	21	0.70
Short	32	32	-112.47	5.44	0.19	173.98	28.07	53.12	14	0.19
All	76	76	-77.49	8.20	0.32	623.50	25.55	57.89	38	0.74

The total gain for the 19 year period of analysis is 623 Eurodollar ticks on a one lot, for an average gain per year of 32.8 Eurodollar ticks. This is not an insubstantial gain! In fact, the target position from days 32 to 42 (two weeks) is held only 4 times per year, for a total of 8 weeks in 52 ( $8/52 \sim 15\%$ ) and averages a gain of about \$820 per year on a one lot. The initial margin on a one year Eurodollar has varied over the years but probably has averaged about \$1,500 per contract. If, say, funds of \$5,812 per contract are required (see reasoning below), then the return per year would be about 14% per year before fees and slippage. Thus this preliminary estimate of system profitability is encouraging, but that does not make the system viable.

Table 3: Column descriptions for trading system profit & loss summary.

Column Name	Description
np	The total number of periods.
npi	The number of periods “in the market,” that had a position.
maxdd	Maximum peak-to-trough drawdown
pnlpp	P&L per period (%).
ir	Information ratio = (mean ret)/(sd ret).
pnltot	Total of trade returns for the entire period (not compounded).
sdpnl	Standard deviation of P&L per period.
winpct	Winning percentage.
runs	Number of runs.
runspvu	P-value for too few runs.

A second system, Eurodollar-System 2, produces the following summary table and cumulative P&L Figure 7. This system has quite low commissions and slippage, and has produced annual returns exceeding 10%.

	np	npi	maxdd	pnlpp	ir	pnltot	sdpnl	winpct	runs	runspvu
Sys2 Long	2410	2410	-138.49	1.05	0.12	2533.54	8.50	56.72	1097	
Sys2 Short	1894	1894	-232.51	0.22	0.03	418.37	7.83	52.48	932	
Sys2 All	4730	4304	-205.50	0.69	0.08	2951.91	8.22	54.86	2026	0

■

## Appendix A Calculation of the Kelly Fraction

Using the setup of independent outcomes  $X_i = \{0, 1\}$  paying  $1 - f$  for  $X_i = 0$  and  $1 + d \cdot f$  for  $X_i = 1$ , the growth rate of wealth after  $n$  flips is

$$G_n = \frac{1}{n} \left( \left( \sum_{i=1}^{i=n} X_i \right) \log(1 + d \cdot f) - \left( n - \sum_{i=1}^{i=n} X_i \right) \log(1 - f) \right), \quad (7)$$

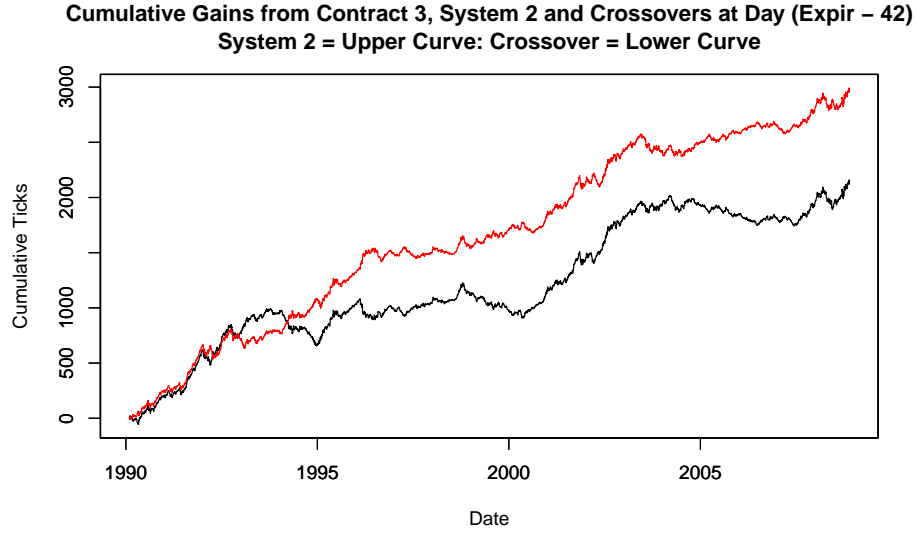

Figure 7: Cumulative Returns from the Roll Strategy (lower line) vs. *Eurodollar-System 2* (upper line).

where the notation  $d \cdot f$  has been used to avoid confusion with the differential  $df$ . By the law of large numbers, (7) converges strongly to

$$G_{\infty} = p \log(1 + d \cdot f) - (1 - p) \log(1 - f). \quad (8)$$

Differentiating (8) with respect to  $f$  gives

$$\frac{dG_{\infty}}{df} = \frac{d \cdot p}{1 + d \cdot f} - \frac{1 - p}{1 - f}. \quad (9)$$

Setting (9) to 0 and solving yields

$$f = p - q/d,$$

and this can be shown to maximize (7).



## References

- Baker, M. and Wurgler, J. (2000). The equity share in new issues and aggregate stock returns. *Journal of Finance*, 55(5):2219–2257.
- Banz, R. W. (1981). The relationship between return and market value of common stocks. *Journal of Financial Economics*, 9(1):3–18.
- Bernard, V. L., , and Thomas, J. K. (1989). Post-earnings-announcement drift: Delayed price response or risk premium? *Journal of Accounting Research*, 27(1):1–36.
- Bouchaud, J. and Potters, M. (2001). More stylized facts of financial markets: leverage effect and downside correlations. *Physica A: Statistical Mechanics and its Applications*, 299(1-2):60–70.
- Chincarini, L. (2012). *The Crisis of Crowding: Quant Copycats, Ugly Models, and the New Crash Normal*. Bloomberg. Wiley.
- Constantinides, G. (1983). Capital market equilibrium with personal tax. *Econometrica*, 51(3):611–36.
- Cooley, P. L. and Roenfeldt, R. L. (1975). A comparative multivariate analysis of factors affecting stock returns. *Financial Review*, 10(1):31–41.
- De Bondt, W. F. M. and Thaler, R. H. (1985). Does the Stock Market Overreact? *The Journal of Finance*, 40(3):793–805.
- Dorfman, D. (Jan 14, 1985). Wall street weak in review. *New York Magazine*, pages 14–15.
- Foerster, S. R. and Karolyi, G. A. (2000). The long-run performance of global equity offerings. *Journal of Financial and Quantitative Analysis*, 35(04):499–528.
- Fudenberg, D. and Tirole, J. (1991). *Game Theory*. The MIT Press.
- Grossman, S. and Zhou, Z. (1993). Optimal investment strategies for controlling drawdowns. *Mathematical Finance*, 3(3):241–276.
- Haugen, R. A. and Baker, N. L. (1991). The efficient market inefficiency of capitalization-weighted stock portfolios. *Journal of Portfolio Management*, 17(3):35 – 40.
- Haugen, R. A. and Heins, A. J. (1975). Risk and the rate of return on financial assets: Some old wine in new bottles. *The Journal of Financial and Quantitative Analysis*, 10(5):775–784.
- Hilbert, M. (2012). Toward a synthesis of cognitive biases: How noisy information processing can bias human decision making. *Psychological Bulletin*, 138(2):211–237.
- Jegadeesh, N. and Titman, S. (1993). Returns to Buying Winners and Selling Losers: Implications for Stock Market Efficiency. *The Journal of Finance*, 48(1):65–91.
- Jegadeesh, N. and Titman, S. (2001). Profitability of Momentum Strategies: An Evaluation of Alternative Explanations. *The Journal of Finance*, 56(2):699–720.
- Jensen, M. H., Johansen, A., and Simonsen, I. (2002). Inverse statistics in economics: The gain-loss asymmetry. Papers, arXiv.org.
- Johnson, I. (April 25, 1993). Even as ratings fall, rukeyser’s stock is still rising still mr. wall street? *The Baltimore Sun*.
- Johnson, S. (2010). *13 Bankers: The Wall Street Takeover and the Next Financial Meltdown*. Knopf Doubleday Publishing Group.
- Kahneman, D. (2011). *Thinking, Fast and Slow*. Farrar, Straus and Giroux, 1 edition.
- Kahneman, D. and Tversky, A. (1979). Prospect Theory: An Analysis of Decision under Risk. *Econometrica*, 47(2):263–291.

- Klass, M. J. and Nowicki, K. (2005). The grossman and zhou investment strategy is not always optimal. *Statistics & Probability Letters*, 74(3):245–252.
- MacLean, L. C., Thorp, E. O., and Ziemba, W. T., editors (2011). *THE KELLY CAPITAL GROWTH INVESTMENT CRITERION: Theory and Practice*, volume 3. World Scientific Publishing Co. Pte. Ltd.
- Miller, E. M. (1977). Risk, Uncertainty, and Divergence of Opinion. *The Journal of Finance*, 32(4):1151–1168.
- Moffitt, S. D. (2017a). Gambling for Quants, Part 1: A Simple Fractional Betting System. *Social Science Research Network Working Paper Series*.
- Moffitt, S. D. (2017b). *The Strategic Analysis of Financial Markets, Volume 1: Framework*. World Scientific Series in Finance. World Scientific.
- Moffitt, S. D. (2017c). *The Strategic Analysis of Financial Markets, Volume 2: Trading System Analytics*. World Scientific Series in Finance. World Scientific.
- Moffitt, S. D. (2017d). The Tax Day Trade: An Efficient Market Anomaly. *Social Science Research Network Working Paper Series*.
- Myerson, R. (1997). *Game Theory: Analysis of Conflict*. Harvard University Press.
- O’Toole, J. (2012). Explaining the libor interest rate mess.
- Shleifer, A. (2000). *Inefficient Markets: An Introduction to Behavioral Finance (Clarendon Lectures in Economics)*. Oxford University Press, USA.
- Tversky, A. and Kahneman, D. (1992). Advances in prospect theory: Cumulative representation of uncertainty. *Journal of Risk and Uncertainty*, 5(4):297–323.
- von Neumann, J. and Morgenstern, O. (2004). *Theory of Games and Economic Behavior (Commemorative Edition) (Princeton Classic Editions)*. Princeton University Press.
- Wikipedia (2012). Libor scandal — wikipedia, the free encyclopedia. [Online; accessed 22-January-2013].

# Index

- affect, 19
- algorithmic trading, 9
- anchoring, 20
- arbbbed out, 2
- associative machine, 19
- availability, 20
  
- behavioral finance, 2
- belief revision bias, 19, 20
- bubbles
  - Dot-Com Bubble of 1996-2000, 12, 14, 15
- Buffett, Warren, 2, 5, 9, 12
  
- capacity
  - strategic plan, 11
- Closed-end Discount Puzzle, 3
- concave strategy, 14
- continuous auction market, 7
- crashes
  - .COM Crash of 2000, 12, 14, 15
- crowding, 11
  
- discretionary trading, 9
- disposition effect, 20
- drawdown, 4, 5, 25
- dual process theory of the mind, 19
  
- edge, 19
- efficient market theory (EMT), 21
- endowment effect, 20
  
- FLOG, 2, 4
  - The Fundamental Law, 4
  - The Wagering Principle, 4
- fragility, 10–12
- framing, 20
- full disclosure, 17, 18
- Fundamental Laws of Gambling, 2, 4
  - The Fundamental Law, 4
  - The Wagering Principle, 4
  
- games & game theory
  - full disclosure, 17, 18
  - negative-sum, 16
  - normal form, 16
  - partial disclosure, 17
  - skill, 17
  - strategic form, 16
  - value, 16
  - zero-sum, 16–18
- gratationality, 2, 5, 19
  
- January effect, 21
  
- leverage, 10–12
  
- linkage
  - strategy, 10
- loss aversion, 20
- loss function
  - drawdown, 6
  - worst loss, 6
- LTCM, 12–15
  
- market ecology, 22
- martingale, 4
- mental accounting, 20
  
- pairs trading strategy, 12–14
- partial disclosure, 17
- POPP, 2
- position, 7
- Potentially Profitable Gambling System, 2, 4
- PPGS, 2, 4, 20
- price distorter, 21, 22
- price impact, 22
- prospect theory, 20
- Pursuit of Profits Paradigm, 2, 15
- Pursuit of Profits Paradigm (POPP), 9, 10, 12, 22
  
- representativeness, 20
- robustness, 10, 11
  
- SAFM, 2–4, 7, 15, 19
- SAMM, 2, 22
  - strategic plan, 9, 9, 10, 15, 22
- slippage, 25
- Soros, George, 2, 15
- status quo bias, 20
- Strategic Analysis of Financial Markets
  - framework, 2–4
- Strategic Analysis of Markets Method, 2
- Strategic Analysis of Markets Method (SAMM), 2, 22
- strategic plan, 9, 9, 10, 15, 22
- strategic plan capacity, 11
- strategy, 9, 10
  - concave, 14
  - diversity, 10
- System 1, 19, 20
- System 2, 19
  
- trading algorithm, 9, 10, 22
- trading system
  - algorithmic, 9
  
- utility theory, 20
  
- Wagering Principle, 4
- winner's curse, 7