

# EMBEDDED DESINGULARIZATION FOR ARITHMETIC SURFACES – TOWARD A PARALLEL IMPLEMENTATION

ANNE FRÜHBIS-KRÜGER, LUKAS RISTAU, AND BERND SCHÖBER

**ABSTRACT.** We present an algorithmic embedded desingularization of arithmetic surfaces bearing in mind implementability. Our algorithm is based on work by Cossart-Jannsen-Saito, though our variant uses a refinement of the order instead of the Hilbert-Samuel function as a measure for the complexity of the singularity. We particularly focus on aspects arising when working in mixed characteristics. Furthermore, we exploit the algorithm’s natural parallel structure rephrasing it in terms of Petri nets for use in the parallelization environment GPI-Space with SINGULAR as computational back-end.

## 1. INTRODUCTION

Resolution of singularities in all its facets has captured the attention of many algebraic geometers since the end of the 19th century. Hironaka’s monumental work [41] solved the long standing problem of desingularization in characteristic zero in arbitrary dimension in 1964, whereas the problem is still wide open in positive and mixed characteristic in higher dimension. With the aim to devise a viable approach in positive characteristic, Hironaka’s characteristic zero approach has been analyzed and rephrased over the decades. Starting with the first constructive formulations, (see in particular [3], [52]) and even more algorithmic simplified approaches (as for example [12, 27, 53]) to the point that nowadays there are accessible, concise introductions to the subject available (like [22], [47]). Around the turn of the century the algorithmization of resolution of singularities had reached a level which allowed first prototype implementations [8], [34], of which the latter was sufficiently efficient to also permit various applications [32], [33], [30].

In positive characteristic, there exist only results in small dimensions and in very special cases [5], [6], [7], [48], [51]. While the surface case has been treated in many different ways [1], [2], [14], [16], [21], [24], [43], [46], [49], it was not until the end of the last decade that the dimension 3 case (non-embedded) was solved in full generality [17], [18], [19], [20]. In mixed characteristic, in particular the approaches of Lipman [49] and Cossart-Jannsen-Saito [16] exemplify two different ways to deal with the task: using a combination of normalization and blow-up steps in the first case and relying solely on blowing up at suitably chosen centers in the second. In Lipman’s approach the normalization in mixed characteristic proved to be a bottleneck in practice [31]; the Cossart-Jannsen-Saito (CJS) algorithm, on the other hand, provides the structural advantage of only using a single kind of birational morphism.

The motivation behind our study of the CJS-algorithm is threefold: first, we need a sufficiently powerful tool for desingularization in this case to enter a more structured, experiment-driven approach to the comparison of desingularization and valuation theoretic approach started in [35]; second, key parts of the algorithm to determine the center can also be used for an alternative approach to normalization; last, but not least, the quest for a solution to the desingularization problem in higher dimension makes it tempting to experimentally search for cases where a straight-forward generalization of an existing algorithm for surfaces to higher dimensions reveals new interesting phenomena. Section 6 of this article provides some more details on the last two motivations.

The goal of this article is to introduce a variant of the approach of Cossart, Jannsen and Saito to embedded desingularization in dimension 2, which is sufficiently explicit to allow implementation. The underlying ideas of the CJS-algorithm can be traced back to

---

2010 *Mathematics Subject Classification.* 14E15 (primary), 14B05, 14J17, 13P99 (secondary).

L.R. was partially supported by DFG-grant SFB-TRR 195 “Symbolic Tools in Mathematics and their Application”, project II.5 “SINGULAR: A new level of abstraction and performance”.

Hironaka’s Bowdoin lectures [43] for hypersurfaces, for which Cossart later closed a gap in [15]. To further outline this approach in slightly more detail, we first need to fix the setting and notation for embedded resolution in mixed characteristic: Let  $X$  be a reduced excellent Noetherian scheme of dimension two, embedded in some excellent regular scheme<sup>1</sup>  $Z$ . Note that we do not fix a base field, explicitly allowing the case of a scheme over a Dedekind ring. We may assume without loss of generality that  $Z$  is connected (and hence that  $Z$  is irreducible) since  $Z$  is regular and we may safely treat each component separately. Throughout the article, we fix

$$N := \dim(Z).$$

In contrast to CJS, we avoid the use of the Hilbert-Samuel function  $H_X(x)$  (loc. cit. Definition 1.28) as measure for the complexity of the singularity of  $X$  at  $x$  and pursue the idea of using the order of  $I(X)$  at  $x$  instead. More precisely, we introduce a refined order  $\nu_{\text{ref}}(x)$  (Definition 2.4), for which the computation of the maximal locus is not as expensive as for the Hilbert-Samuel function. In Example 4.16 we show that this leads to a different resolution process. The idea of replacing the Hilbert-Samuel function by the order is by no means new, as it can e.g., be found in [12]. More recently, also the multiplicity has been used as a replacement for the Hilbert-Samuel function in [13], but we will not follow that train of thought here.

The article is structured to first cover the theoretical background, before formulating the algorithms first in a sequential way and then as Petri-nets. More precisely, section 2 discusses our variant of the algorithm of Cossart-Jannsen-Saito without assuming that the reader is already deeply familiar with desingularization algorithms. This section therefore also recalls important results and constructions from [16] and [21], and explains the complete algorithm illustrating important facts by examples, wherever necessary. In particular, it introduces the main invariant, the refined order of an ideal, and addresses the question of termination for the two simplest cases, namely the 1-dimensional case and the case of 2-dimensional hypersurfaces.

As the main measure for the complexity of a singularity is the order of the corresponding ideal in our setting, the computation of the locus of maximal order is the very heart of the algorithm. As this is not a completely trivial task in mixed characteristic, section 3 is devoted to treating this in detail. This section does not assume that the reader is familiar with the notion of Hasse-Schmidt derivatives, which are indispensable for the computation, and hence also discusses them briefly before rendering the construction of the locus of maximal refined order completely algorithmic.

Based on the theoretical discussions in sections 2 and 3, we are then prepared to reformulate our version of the CJS-approach in terms of sequential algorithms in section 4. In here, we apply particular care to the identification of bad primes or more precisely potentially bad primes, which we refer to as interesting primes (i.e., prime numbers above which there possibly lies a component of the maximal locus). At this point, it is also important to note that we distinguish between horizontal and vertical components in the maximal locus. The former are components that can be seen at every prime, while each vertical component is associated to a single particular prime  $p$  and is not seen above any prime  $q \neq p$ . In contrast to [16], we give precedence to the horizontal components and consider the vertical ones only when no more horizontal components are left.<sup>2</sup>

Given the sequential algorithms and the naturally parallel structure due to the use of coverings by charts at different points in the algorithms, we rephrase the algorithms in terms of Petri-nets in section 5 to make them accessible to the parallel workflow management system GPI-Space. As we also do not assume familiarity of the reader with the formalism of Petri nets, we give a very brief overview at the beginning of the section, before stating the nets which represent the main parts of the algorithms.

---

<sup>1</sup>In fact, if one is only interested in understanding the local situation, it is always possible to reduce all consideration to the embedded setting, see [16] Remark 5.22.

<sup>2</sup>The idea to try to resolve first all horizontal components and then to handle the vertical components has been pointed out by H. Hironaka during a private conversation at a conference in 2006 at the ICTP in Trieste, Italy.

The last section is then devoted to an outlook which details the possible applications already mentioned as motivations for this article.

*Acknowledgments:* The authors would like to thank Vincent Cossart, Gerhard Pfister, Mirko Rahn, and Stefan Wewers for fruitful exchange on topics touching upon the context of this article. Further, they thank Sabrina Gaube for numerous helpful comments on an earlier draft. They are grateful to the anonymous referees for useful comments and questions.

*Notational Remark:* throughout the article,  $\mathbb{N} = \{0, 1, 2, \dots\}$  and we use multi-index notation, i.e., for  $(\underline{x}) = (x_1, \dots, x_m)$  and  $\mathbf{a} = (a_1, \dots, a_m) \in \mathbb{N}^m$ , we abbreviate  $\underline{x}^{\mathbf{a}} = x_1^{a_1} \cdots x_m^{a_m}$ . We often apply abuse of notation and write  $V(J) := \text{Spec}(A[\underline{x}]/J)$ , for an ideal  $J \subset A[\underline{x}]$  and a principal ideal domain  $A$  (e.g.,  $A = \mathbb{Z}$ ).

## 2. A VARIANT OF THE ALGORITHM OF COSSART, JANNSSEN AND SAITO

We present a variant of the algorithm by Cossart, Jannsen, Saito [16]. In contrast to their approach, we do not consider the Hilbert-Samuel function  $H_X : X \rightarrow \mathbb{N}^{\mathbb{N}}$  as measure for the complexity of the singularities, but a refinement  $\nu_{\text{ref}} : X \rightarrow \mathbb{N}^2$  of the order (Definition 2.4). The benefit is that with our modification the implementation of the algorithm runs in reasonable time, whereas the computation of the Hilbert-Samuel locus is far more expensive. (cf. [50]). Furthermore, we make a distinction between the *vertical* components (i.e., those lying completely in one fiber above some prime  $p \in \mathbb{Z}$ ) in the maximal locus of  $\nu_{\text{ref}}$  and the *horizontal* ones (which appear in every fiber).

Let us point out that in this section we do not make use of the additional structure imposed on  $Z$ . Hence the constructed resolution procedure can be applied for any excellent irreducible regular scheme  $Z$ .

From the viewpoint of resolution of singularities, a map  $\mu : X \rightarrow S$  into a totally<sup>3</sup> ordered set  $(S, \leq)$  has to fulfill the following properties in order to be a decent measure for the complexity of a singularity and its improvement during the resolution process:

- (A)  $\mu$  distinguishes singular and regular points.
- (B)  $\mu$  is (Zariski) upper semi-continuous: the sets  $X_{\mu}(\geq s) := \{x \in X \mid \mu(x) \geq s\}$  are closed, for every  $s \in S$ .
- (C)  $\mu$  is infinitesimally upper semi-continuous:  $\mu$  does not increase if we blow up a regular center  $D$  contained in the locus, where  $\mu$  is maximal.
- (D)  $\mu$  can only decrease finitely many times until all points are regular.

Therefore the order itself is not an appropriate measure since (A) fails to hold, in general, see Example 2.7. In our setting, we shall use  $S = \mathbb{N}^2$  equipped with the lexicographical order. Hence, for us, (C) implies (D).

Recall the following criterion for upper semi-continuity:

**Lemma 2.1** ([16] Lemma 2.34(a)). *A map  $\mu : X \rightarrow S$ , with  $(S, \leq)$  a totally ordered set, is upper semi-continuous if and only if the following holds:*

- (1) If  $x, y \in X$  with  $x \in \overline{\{y\}}$ , then  $\mu(x) \geq \mu(y)$ .
- (2) For all  $y \in X$  there is a dense open subset  $U \subset \overline{\{y\}}$  such that  $\mu(x) = \mu(y)$  for all  $x \in U$ .

Since we assume that  $\mu$  cannot increase under suitable blowing ups and that  $\mu$  can only decrease finitely many times until the strict transform of  $X$  is regular, it is sufficient to construct a finite sequence of blowing ups such that the maximal value achieved by  $\mu$  decreases strictly. This implies then embedded resolution of singularities for  $X \subset Z$ . More precisely, we need to answer the following question: Given  $X \subset Z$ , can we find a finite sequence of blowing ups,

$$(2.1) \quad \begin{array}{ccccccc} Z =: & Z_0 & \longleftarrow & Bl_{D_0}(Z_0) =: & Z_1 & \longleftarrow & \cdots & \longleftarrow & Bl_{D_{a-1}}(Z_{a-1}) =: & Z_a \\ & \cup & & & \cup & & & & \cup & \\ X =: & X_0 & \longleftarrow & & X_1 & \longleftarrow & \cdots & \longleftarrow & & X_a, \end{array}$$

<sup>3</sup>In fact, it is sufficient if the set is partially ordered if we require that  $\mu$  can only achieve finitely many maximal values on  $X$ , cf. [16] Lemma 2.34(c) and the preceding paragraph. For example, this appears if the Hilbert-Samuel function is used.

in centers  $D_i$  contained in the locus, where  $\mu$  is maximal on  $X_i$ ,  $0 \leq i \leq a-1$ , ( $X_i$  denotes the strict transform of  $X$  in  $Z_i$ ) such that eventually

$$\max\{\mu(x_a) \mid x_a \in X_a\} < \max\{\mu(x) \mid x \in X\}?$$

As a first step we introduce our refinement  $\nu_{\text{ref}}$  of the order and then show that the above properties hold for  $\nu_{\text{ref}}$  in order to justify its use.

**Definition 2.2.** Let  $x \in X$  (not necessarily closed). We denote by  $(R = \mathcal{O}_{Z,x}, \mathfrak{m}, k = R/\mathfrak{m})$  the local ring of  $Z$  at  $x$  (which is excellent and regular) and by  $J \subset R$  the ideal which defines  $X$  locally at  $x$ .

- (1) The *order of  $X$  at  $x$*  is defined as the order of  $J$  at  $\mathfrak{m}$ ,

$$\text{ord}_x(X) := \text{ord}_{\mathfrak{m}}(J) := \sup\{t \in \mathbb{N} \mid J \subset \mathfrak{m}^t\}$$

For an element  $f \in J$ , we also abbreviate  $d(f) := \text{ord}_{\mathfrak{m}}(f)$ .

- (2) The *maximal order of  $X$*  is defined as

$$\text{max-ord}(X) := \sup\{\text{ord}_x(X) \mid x \in X\}$$

and the *maximal order locus of  $X$*  is the locus of points of order  $\text{max-ord}(X)$ ,

$$\text{Max-ord}(X) := \{x \in X \mid \text{ord}_x(X) = \text{max-ord}(X)\}.$$

- (3) The *initial form of  $f$  (with respect to  $\mathfrak{m}$ )* is defined as

$$\text{in}_{\mathfrak{m}}(f) := f \pmod{\mathfrak{m}^{d(f)+1}} \in \text{gr}_{\mathfrak{m}}(R),$$

where  $\text{gr}_{\mathfrak{m}}(R) = \bigoplus_{t \geq 0} \mathfrak{m}^t/\mathfrak{m}^{t+1}$  denotes the *associated graded ring of  $R$  at  $\mathfrak{m}$* .

- (4) The *initial ideal of  $J$  at  $\mathfrak{m}$*  is defined as the ideal  $\text{In}_{\mathfrak{m}}(J)$  in  $\text{gr}_{\mathfrak{m}}(R)$  generated by the initial forms of the elements in  $J$ ,

$$\text{In}_{\mathfrak{m}}(J) := \langle \text{in}_{\mathfrak{m}}(f) \mid f \in J \rangle.$$

Recall that the order is an upper semi-continuous function, see [41] Chapter III §3 Corollary 1 p. 220. Furthermore, the graded ring  $\text{gr}_{\mathfrak{m}}(R)$  is isomorphic to a polynomial ring in  $n$  variables over the residue field  $k$  (even in mixed characteristic), where

$$n := n_x := \dim(R).$$

In the graded ring one of the variables may correspond to a prime number, e.g.  $R = \mathbb{Z}[x]_{\langle 73, x \rangle}$ . Moreover,  $\text{In}_{\mathfrak{m}}(J)$  is a homogeneous ideal in  $\text{gr}_{\mathfrak{m}}(R)$ . For  $\mathfrak{M} := \text{In}_{\mathfrak{m}}(\mathfrak{m}) \subset \text{gr}_{\mathfrak{m}}(R)$ , we have

$$(2.2) \quad \min\{\text{ord}_{\mathfrak{m}}(f) \mid f \in J\} = \text{ord}_{\mathfrak{m}}(J) = \text{ord}_{\mathfrak{M}}(\text{In}_{\mathfrak{m}}(J)).$$

**Observation 2.3.** Let the situation be as in the previous definition. Set  $I_1 := \text{In}_{\mathfrak{m}}(J)$ . If  $\text{ord}_{\mathfrak{M}}(I_1) = 1$ , we can consider its image  $\overline{I_1}$  in the degree 1 slice of  $\text{gr}_{\mathfrak{m}}(R)$ , which yields a subspace of the finite dimensional  $k$ -vector space  $\text{gr}_{\mathfrak{m}}(R)_1 = \mathfrak{m}/\mathfrak{m}^2$ . We can thus find a basis, say  $F_1, \dots, F_a$  of  $\overline{I_1}$ , for some  $a := a_x \in \mathbb{N}$ . Either  $I_1 = \langle F_1, \dots, F_a \rangle_{\text{gr}_{\mathfrak{m}}(R)}$  or  $\text{ord}_{\mathfrak{M}}(H) > 1$  for all elements  $H$  in the ideal  $I_{a+1}$  generated by the set  $I_1 \setminus \langle F_1, \dots, F_a \rangle_{\text{gr}_{\mathfrak{m}}(R)}$ . We define

$$(2.3) \quad d_x := \begin{cases} 1, & \text{if } I_1 = \langle F_1, \dots, F_a \rangle \\ \text{ord}_{\mathfrak{M}}(I_{a+1}) > 1, & \text{otherwise.} \end{cases}$$

For each  $F_i \in \text{In}_{\mathfrak{m}}(J)$ , we can choose a lift  $f_i \in J$  with  $\text{in}_{\mathfrak{m}}(f_i) = F_i$ ,  $1 \leq i \leq a$ . We have  $\text{ord}_{\mathfrak{m}}(f_i) = \text{ord}_{\mathfrak{M}}(F_i) = 1$  and  $(f_1, \dots, f_a)$  forms a regular sequence, in particular,  $f_i \notin \langle f_1, \dots, f_{i-1} \rangle$ , for  $1 \leq i \leq a$ . Hence  $\mathcal{Y} := V(f_1, \dots, f_a)$  defines a  $(n-a)$ -dimensional regular subscheme of  $\mathcal{Z} := \text{Spec}(R)$  which contains  $\mathcal{X} = V(J)$ . This implies

$$a_x \leq n_x - \dim \mathcal{X} \leq N = \dim(Z).$$

The following are equivalent:

- (i) the first inequality is strict,  $a_x < n_x - \dim \mathcal{X}$  (i.e.,  $\dim \mathcal{X} < \dim \mathcal{Y}$ ),
- (ii)  $d_x > 1$ , and
- (iii)  $X$  is not regular at  $x$ .

At a closed point corresponding to a maximal ideal  $\mathfrak{m}_x$  the value of  $n_x - a_x$  coincides with the embedding dimension of  $X$  at  $x$ ,

$$n_x - a_x = \text{emb.dim}_x(X).$$

However, this idea needs to be refined slightly to also allow local considerations at non-maximal prime ideals. This is taken into account in the following definition. The reasons for the change will become apparent in Example 2.5 directly after it.

**Definition 2.4.** Let  $X \subset Z$  be as above.

- (1) Using the previous notations, we define the map

$$\nu_{\text{ref}} := \nu_{\text{ref}, X, Z} : X \rightarrow (\mathbb{N}^2, \leq_{lex}), \quad \nu_{\text{ref}}(x) := (N - a_x, d_x).$$

We call  $\nu_{\text{ref}}$  the *refined order on  $X$* .

- (2) For  $A \in \mathbb{N}^2$ , we set  $\mathcal{V}_{\geq A}(X) := \{x \in X \mid \nu_{\text{ref}}(x) \geq A\}$ . We define the *maximal refined order of  $X$*  by

$$\text{max-}\nu(X) := (\alpha, \delta) := \max\{\nu_{\text{ref}}(x) \mid x \in X\}$$

and the *maximal refined order locus of  $X$*  by

$$\text{Max-}\nu(X) := \begin{cases} \mathcal{V}_{\geq \text{max-}\nu(X)}(X), & \text{if } \delta > 1, \\ X, & \text{if } \delta = 1. \end{cases}$$

- (3) A closed subscheme  $D$  (not necessarily irreducible) is called a *weakly permissible center* if it is regular and contained in the maximal refined order locus of  $X$ . We call the blowing up with such a center  $D$  a *weakly permissible blowing up*.

As stated above,  $\nu_{\text{ref}}$  depends on  $X$  and  $Z$ . In order to keep formulas simple, we will only mention the dependence when it is not clear from the context.

The following example illustrates, why we are using  $N - a$  and not  $n - a$  in the definition of  $\nu_{\text{ref}}$ . The difference is subtle, but crucial for further reasoning.

**Example 2.5** (Whitney umbrella). Let  $k$  be an infinite field and  $X \subset Z := \mathbb{A}_k^3 = \text{Spec}(k[t, y, z])$  be the hypersurface defined by the polynomial  $f = t^2 - y^2z$ . Its singular locus is the curve  $C := V(t, y)$ , whose generic point we denote by  $\eta$ . By  $x$  we denote the closed point  $V(t, y, z)$ .

We have  $a_x = a_\eta = 0$  and  $d_x = d_\eta = 2$  coincides with the order of  $f$  at the respective point. Therefore  $\nu_{\text{ref}}(x) = \nu_{\text{ref}}(\eta) = (3, 2)$  since  $N = \dim(Z) = 3$ , and  $\text{Max-}\nu(X) = V(t, y)$ .

On the other hand, if we used  $\nu_{\text{hyp}} = (n_x - a_x, d_x)$  instead of  $\nu_{\text{ref}}$  we would see the following:  $n_x = \dim(\mathcal{O}_{Z, x}) = 3$  and  $n_\eta = \dim(\mathcal{O}_{Z, \eta}) = 2$ , since  $z$  becomes an element of the residue field at  $\eta$  and we see that  $\text{trdeg}((\mathcal{O}_{Z, \eta}/\mathfrak{m}_{Z, \eta}) : (\mathcal{O}_{Z, x}/\mathfrak{m}_{Z, x})) = 1$ . Hence we have  $n_x - a_x = 3 > 2 = n_\eta - a_\eta$ , i.e.,  $\nu_{\text{hyp}}(x) = (3, 2) > (2, 2) = \nu_{\text{hyp}}(\eta)$ . In fact, this computation holds for any closed point  $x'$  contained in  $C$  instead of  $x$ . Since  $k$  is infinite, there are infinitely many closed points on  $C$  and the maximal locus of  $\nu_{\text{hyp}}$  is not closed.

Another interesting aspect about this example is the following: if we blow up the closed point  $x$  then the strict transform of  $f$  at the point with parameters  $(t', y', z') = (\frac{t}{z}, \frac{y}{z}, z)$  is given by  $f' = t'^2 - y'^2z'$  and we have thus encountered a loop.

**Remark 2.6.** (1) The reader familiar with the notion of Hironaka's  $\nu^*$ -invariant ([41] Chapter III Definition 1, p. 205, see also [16] Definition 2.17) will recognize a connection. Observation 2.3 is precisely the beginning of a possible way to construct a so called standard basis for  $J$  and thus to determine  $\nu^*(J, R)$ , see [16] the paragraph before Remark 2.5. Set  $I := \text{In}_{\mathfrak{m}}(J)$ , then

$$\begin{aligned} \nu^*(J, R) &= (\nu^1(I), \nu^2(I), \dots, \nu^a(I), \nu^{a+1}(I), \nu^{a+2}(I), \dots) = \\ &= (1, 1, \dots, 1, d_x, \nu^{a+2}(I), \dots) \in (\mathbb{N} \cup \{\infty\})^{\mathbb{N}}. \end{aligned}$$

Note that our invariant at the closed point  $x$  corresponding to the maximal ideal of  $J$  is  $(N - a_x, d_x)$ , where  $a_x = a$ . Hence, our invariant corresponds to the truncation of the  $\nu^*$ -invariant after the first entry  $> 1$ .

The entries  $\nu^1(I), \nu^2(I), \dots$  are ordered increasingly and are equal to the orders of a particular system of generators  $f_1, f_2, \dots$  for  $J$ , whose behavior along a blowing

- up is the same as the one of the ideal  $J$ . By [16] Theorem 3.10, the Hilbert-Samuel function decreases after a permissible blowing up if and only if the  $\nu^*$ -invariant does.
- (2) If  $X = V(f)$  is an affine hypersurface then  $\nu_{\text{ref}}$  determines the order of  $X$  and vice versa. On the other hand, the behavior of the Hilbert-Samuel function is also detected by the order in this case ([16] Theorem 3.10). Hence the maximal loci considered by the original CJS-algorithm and by our variant coincide for hypersurfaces. Nonetheless, the algorithms may differ in their way of resolving the maximal locus since this is in general not a hypersurface.
- (3) Since we assume  $\dim(X) = 2$  and  $X$  reduced,  $\text{Max-}\nu(X)$  has at most dimension one. In particular,  $\text{Max-}\nu(X)$  itself has at most isolated singularities.

**Example 2.7.** Let  $R = \mathbb{Z}[t, v, w, y, z]_{\mathfrak{m}}$ , where  $\mathfrak{m} = \langle p, t, v, w, y, z \rangle$ , for  $p \in \mathbb{Z}$  prime. We consider the scheme  $X := V(J) \subset \text{Spec}(R)$ , where

$$J := \langle p, t, v^2 - y^3, z^5 - y^2w^5 \rangle \subset R.$$

Then,  $\text{ord}_{\mathfrak{m}}(J) = 1$ , although the point  $x$  in  $X$  corresponding to  $\mathfrak{m}$  is singular. Hence, the order cannot distinguish regular and singular points.

On the other hand, since  $\text{ord}_{\mathfrak{m}}(v^2 - y^3) = 2$  is maximal and  $\text{ord}_{\mathfrak{m}}(z^5 - y^2w^5) = 5 \geq 2$ , we have  $\nu_{\text{ref}}(x) = (4, 2)$ . In fact,  $\text{max-}\nu(X) = (4, 2)$  and  $\text{Max-}\nu(X) = V(p, t, v, y, z)$ .

Note: if we put  $P := \langle p, t, v, y, z \rangle$ , then  $\text{ord}_P(z^5 - y^2w^5) = 2 < 5 = \text{ord}_{\mathfrak{m}}(z^5 - y^2w^5)$ , a difference which is undetected by  $\nu_{\text{ref}}$ .

**Proposition 2.8.** *The map  $\nu_{\text{ref}} = \nu_{\text{ref}, X, Z} : X \rightarrow \mathbb{N}^2$  distinguishes regular from singular points (A), is Zariski upper semi-continuous (B), is infinitesimally upper semi-continuous (C), and can only decrease finitely many times until it detects regularity (D).*

*Proof.* Since  $\nu_{\text{ref}}$  takes values in  $\mathbb{N}^2$ , (D) is implied by (C). Further, we have seen in Observation 2.3 that  $d_x$  distinguishes singular and regular points. Hence (A) holds.

For (C), we may assume that  $X$  is singular. Let  $x \in \text{Max-}\nu(X)$ . As before,  $J$  denotes the ideal in  $R := \mathcal{O}_{Z, x}$  defining  $X$  locally at  $x$ . Let  $f_1, \dots, f_a, \dots, f_r \in J$  be generators for  $J$  such that  $\text{ord}_{\mathfrak{m}}(f_i) = 1$  and  $f_i \notin \langle f_1, \dots, f_{i-1} \rangle$ , for  $1 \leq i \leq a$ , and  $\text{ord}_{\mathfrak{m}}(f_j) > 1$ , for  $j > a$  (cf. Observation 2.3). In particular,  $V(f_1, \dots, f_a)$  is regular.

Let  $\pi : Z' := \text{Bl}_D(Z) \rightarrow Z$  be a weakly permissible blowing up with center  $D \subset \text{Max-}\nu(X)$  containing  $x$ . Denote by  $X'$  the strict transform of  $X$  in  $Z'$ . We have to show  $\nu_{\text{ref}}(x') \leq \nu_{\text{ref}}(x)$ , for every  $x' \in \pi^{-1}(x)$ . (Note that  $\dim(Z') = \dim(Z)$ ).

Above the point  $x$ , the strict transform of  $X$  is given by the strict transforms of the elements  $h \in J$ . Since  $X$  is singular, we can choose  $h \in J$  such that  $\text{ord}_{\overline{\mathfrak{m}}}(\overline{h}) = d_x$ , where  $\overline{\mathfrak{m}}$  and  $\overline{h}$  denote the images of the respective objects in  $R/\langle f_1, \dots, f_a \rangle$ . Without loss of generality, we may assume that  $h$  is of order  $d_x$  at  $x$ .<sup>4</sup>

Note that  $D$  is a weakly permissible center for the hypersurface  $V(h) \subset Z$  at least in a Zariski-open neighbourhood of  $x$  (i.e., it is regular and contained<sup>5</sup> in  $\text{Max-}\nu(V(h))$  – in fact the latter coincides with the maximal order locus of  $V(h)$ ). It is a well-known fact (see [16] Theorem 3.10, using loc. cit. Definitions 2.26 and 2.17(2)) that the order of a hypersurface does not increase under such blowing ups. This implies  $\nu_{\text{ref}}(x') \leq \nu_{\text{ref}}(x)$  and hence (C).

It remains to prove (B), which is the upper semi-continuity of  $\nu_{\text{ref}}$ . For this, we will make use of Lemma 2.1: Let  $x, y \in X \subset Z$  with  $x \in \overline{\{y\}}$ . We have to show that the inequality  $\nu_{\text{ref}}(x) \geq \nu_{\text{ref}}(y)$  holds. Let  $U_0 = \text{Spec}(S)$  be an affine open set containing  $x$  and  $y$ . Let  $f_1, \dots, f_a \in S$  be such that each  $f_i$  is of order one at  $x$  and they define  $a_x = a$  (cf. Observation 2.3). By the upper semi-continuity of the order, the order of each  $f_i$  does not

<sup>4</sup>The representative can, for instance, be chosen as the element  $f_{a+1}$  in the above mentioned computation of a standard basis leading to the  $\nu^*$ -invariant, cf. Remark 2.6.

From another perspective and moving  $x$  to the origin, the knowledge of  $\text{ord}_{\overline{\mathfrak{m}}}(\overline{h}) = d_x$  implies that after translation the Mora normal form (cf. [39], Algorithm 1.7.6, for a textbook reference) of an arbitrary representative of  $\overline{h}$  w.r.t a standard basis of  $\langle f_1, \dots, f_a \rangle$  will be of order  $d_x$ . Of course, retranslating the resulting normal form back to  $x$ , we obtain the desired representative.

<sup>5</sup>It may, of course happen that the maximal refined order of  $h$  exceeds  $d_x$  somewhere else, but this can only happen on a Zariski-closed subset not meeting  $x$ . Hence it is possible to avoid this set by taking a suitable Zariski-open neighbourhood of  $x$ .

increase by passing from  $x$  to  $y$ . Since  $y \in X$ , the order of  $f_i$  has to be at least one at  $y$ . Hence, we have  $a_y \geq a_x = a$  and if the inequality is strict then  $\nu_{\text{ref}}(y) < \nu_{\text{ref}}(x)$ .

Suppose  $a_y = a_x$ . We stay in the same notation ( $J \subset S$  the ideal defining  $X \cap U_0$  in  $U_0 = \text{Spec}(S)$  containing  $x$  and  $y$ ). Let  $h \in J$  be an element of order  $d_x$  at  $x$  (cf. proof of (C)). By choosing  $U_0$  sufficiently small, we may assume that  $V(f_1, \dots, f_a) \subset U_0$  is regular. Let us denote by  $\bar{h}$  the image of  $h$  in  $S/\langle f_1, \dots, f_a \rangle$ . Note that  $x, y \in V(f_1, \dots, f_a)$ . We have that the order of  $\bar{h}$  at  $x$  is  $d_x$ . Again, by the upper semi-continuity of the order, we obtain that the order of  $\bar{h}$  at  $y$  is at most  $d_x$ . Therefore,  $d_y \leq d_x$ , i.e.,  $\nu_{\text{ref}}(y) \leq \nu_{\text{ref}}(x)$ . In other words, Lemma 2.1(1) holds.

For Lemma 2.1(2), let  $y \in X$ . We need to show that there exists a dense open subset  $U \subset \overline{\{y\}}$  such that  $\nu_{\text{ref}}(x) = \nu_{\text{ref}}(y)$  for all  $x \in U$ . Let  $U_0 = \text{Spec}(S)$  be an affine neighborhood of  $y$  in  $Z$  and denote by  $J \subset S$  the ideal defining  $X$ . Using Observation 2.3 at  $y$  and analogous notation to before, we choose generators  $(f_1, \dots, f_a, f_{a+1}, \dots, f_r)$  for  $J$  in  $S$  such that  $V(f_1, \dots, f_a)$  is regular and  $N - a$  is the first entry of  $\nu_{\text{ref}}(y)$ . (Note: We can choose  $U_0$  sufficiently small for this). From the construction of  $d_y$  it follows that  $d_y$  coincides with the order of  $J \cdot S/\langle f_1, \dots, f_a \rangle$  at  $y$ . The latter is upper semi-continuous and by Lemma 2.1 there exists a dense open subset  $V$  contained in  $V(f_1, \dots, f_a)$  such that the order at every point in  $V$  is equal to  $d_y$ . This yields then a dense open set  $U \subset \overline{\{y\}}$  such that  $\nu_{\text{ref}}(x) = \nu_{\text{ref}}(y)$  for all  $x \in U$ . Hence Lemma 2.1(2) holds. As a conclusion we obtain that  $\nu_{\text{ref}}$  is upper semi-continuous.  $\square$

The resolution process provides us with more data than just the strict transform  $X'$  of  $X$  in  $Z'$ . Namely, there are also the exceptional divisors  $E'$  of the blowing ups. Additionally to the above, one imposes for an embedded resolution of singularities that the strict transform of  $X$  has at most simple normal crossings with  $E'$  and that all centers in (2.1) meet the exceptional divisors transversally.

Furthermore, in order to attain a canonical resolution of singularities one has to take the exceptional divisors into account. For example, the singular locus of  $X := V(x^2 - y^2z^2)$  (which coincides with  $\text{Max-}\nu(X)$ ) consists of the two lines  $L_1 := V(x, y)$  and  $L_2 := V(x, z)$ . A priori there is no way to distinguish them and we need to blow up their intersection  $V(x, y, z)$ . At first glance the situation did not change locally at the point with coordinates  $(x', y', z') = (\frac{x}{z}, \frac{y}{z}, z)$ . But, in fact,  $V(x', z')$  is contained in the exceptional divisor, whereas  $V(x', y')$  is the strict transform of  $L_1$ . Thus we can distinguish the lines and pick one of them as the next center. (For example, the CJS-algorithm will choose  $L'_1$  since it is "older" than the other component, see also Example 6.1).

It is a general philosophy in resolution of singularities to encode the information on the exceptional divisors in some way. Following [16], we do this using a so called boundary  $\mathcal{B}$  ([16] Definition 4.3) and adapt the notion of  $\mathcal{B}$ -permissible centers (loc. cit. Definition 4.5) for our situation.

**Definition 2.9.** Let  $X \subset Z$  be as before.

- (1) A *boundary on  $Z$*  is a collection  $\mathcal{B} = \{B_1, \dots, B_d\}$  of regular divisors on  $Z$  such that the associated divisor  $\text{div}(\mathcal{B}) = B_1 \cup \dots \cup B_d$  is a simple normal crossings divisor. For  $x \in Z$ , we let  $\mathcal{B}(x) := \{B_i \mid x \in B_i\}$  be the boundary components passing through  $x$ .
- (2) A closed subscheme  $D \subset X$  is called  *$\mathcal{B}$ -weakly permissible* if it is weakly permissible and has at most simple normal crossings with the boundary  $\mathcal{B}$  (i.e.,  $D$  is regular, contained in  $\text{Max-}\nu(X)$ , and intersects  $\text{div}(\mathcal{B})$  transversally).

We also say that the corresponding blowing up  $\pi : Z' := B\ell_D(Z) \rightarrow Z$  with center  $D$  is a  *$\mathcal{B}$ -weakly permissible blowing up*. The *transform  $\mathcal{B}'$  of the boundary  $\mathcal{B}$  under  $\pi$*  is defined to be the union of the strict transforms of the components of  $\mathcal{B}$  and the exceptional divisor  $E'_\pi$  of  $\pi$  (i.e.,  $\mathcal{B}' = \{B'_1, \dots, B'_d, E'_\pi\}$  with the obvious notations).

We *distinguish the boundary components* in two sets (cf. [16] Lemmas 4.7 and 4.14): Suppose we are at the beginning of the resolution process and we consider some point  $x$ . Then we define all boundary components passing through  $x$  to be *old*,  $O(x) := \mathcal{B}(x)$ .

Let  $\pi : Z' \rightarrow Z$  be a blowing up of  $Z$  in a regular center  $D \subset X$  containing  $x$ . Let  $x' \in X'$  be a point on the strict transform of  $X$  which lies above  $x$ ,  $\pi(x') = x$ .

- If  $\nu_{\text{ref}}(x') < \nu_{\text{ref}}(x)$  then the singularity improved at  $x'$  and we treat the situation as if we are at the beginning. Hence  $O(x') := \mathcal{B}'(x')$ .
- Suppose  $\nu_{\text{ref}}(x') = \nu_{\text{ref}}(x)$ . Then we define the old boundary components  $O(x')$  to be the subset of  $\mathcal{B}'(x')$  consisting of the strict transforms of the elements in  $O(x)$  which pass through  $x'$ . All other components are called *new*,  $N(x') := \mathcal{B}'(x') \setminus O(x')$ .

The reason for this distinction is that we have some control on the new boundary components and how they behave with respect to  $X$ . On the other hand, we lose this control once the singularity strictly improved, i.e., once  $\nu_{\text{ref}}$  decreases strictly.

**Definition 2.10.** Let  $X \subset Z$  be as before and let  $\mathcal{B}$  be a boundary on  $Z$ . We define the *log-refined order* by

$$\begin{aligned} \nu_{\text{ref}}^O = \nu_{\text{ref}, X, Z}^O : X &\longrightarrow (\mathbb{N}^3, \leq_{\text{lex}}) \\ x &\longmapsto (\nu_{\text{ref}}(x), |O(x)|). \end{aligned}$$

For  $\tilde{A} \in \mathbb{N}^3$ , we set

$$\begin{aligned} \mathcal{V}_{\geq \tilde{A}}^O(X) &:= \{x \in X \mid \nu_{\text{ref}}^O(x) \geq \tilde{A}\}, \\ \text{max-}\nu^O(X) &:= (\alpha, \delta, \sigma) := \max\{\nu_{\text{ref}}^O(x) \mid x \in X\}, \\ \text{Max-}\nu^O(X) &:= \begin{cases} \mathcal{V}_{\geq \text{max-}\nu^O(X)}^O(X), & \text{if } \delta > 1 \text{ or } \sigma > 0, \\ X, & \text{if } \delta = 1 \text{ and } \sigma = 0. \end{cases} \end{aligned}$$

Let us explain how to obtain  $\mathcal{V}_{\geq (A, b)}^O(X)$  from  $\mathcal{V}_{\geq A}(X)$ , for  $A \in \mathbb{N}^2, b \in \mathbb{N}$ :

**Construction 2.11.** Let the situation be as in the previous definition and, in particular, let  $\mathcal{B} = \{B_1, \dots, B_d\}$ . Let  $\tilde{A} = (A, b) \in \mathbb{N}^3$  with  $A \in \mathbb{N}^2, b \in \mathbb{N}$ . First, we observe that, for any  $A' \in \mathbb{N}^2$  with  $A' > A$ , we have  $(A', 0) > \tilde{A}$ . Hence,  $\bigcup_{A' > A} \mathcal{V}_{\geq A'}(X) \subseteq \mathcal{V}_{\geq \tilde{A}}^O(X)$ . The upper semi-continuity of  $\nu_{\text{ref}}$  (Proposition 2.8), implies that  $\mathcal{V}_{\geq A'}(X) = \{x \in X \mid \nu_{\text{ref}}(x) \geq A'\}$  is closed. Since there are only finitely many  $A'$  with  $\mathcal{V}_{\geq A'}(X) \neq \emptyset$ , the union  $\bigcup_{A' > A} \mathcal{V}_{\geq A'}(X)$  is closed. If  $b > d$  or  $b > N = \dim(Z)$ , then  $\mathcal{V}_{\geq \tilde{A}}^O(X) = \bigcup_{A' > A} \mathcal{V}_{\geq A'}(X)$ .

Hence, let us assume that  $b \leq \min\{d, N\}$ . We introduce the closed set

$$Y_0 := \bigcup_{(i_1, \dots, i_b)} (\mathcal{V}_{\geq A}(X) \cap B_{i_1} \cap \dots \cap B_{i_b}),$$

where the union runs through all subsets of  $\{1, \dots, d\}$  with  $b$  pairwise different elements. Suppose there is an irreducible component  $W$  of  $Y_0$  and a point  $w \in W$  such that  $\nu_{\text{ref}}^O(w) < \tilde{A}$ . (This may happen since we are intersecting with  $b$  exceptional components in the definition of  $Y_0$ , among which some could be new.) If there exists at least one  $j \in \{1, \dots, d\}$  such that  $W \not\subseteq B_j$ , then we replace  $W$  in  $Y_0$  by

$$W_0 := \bigcup_{j : W \not\subseteq B_j} (W \cap B_j).$$

If we have  $W \subset B_j$ , for  $1 \leq j \leq d$ , then we replace  $W$  by the empty set  $W_0 := \emptyset$ . The dimension of each irreducible component of  $W_0$  is strictly smaller than  $\dim(W)$  if  $W_0 \neq \emptyset$ . Hence, after finitely many iterations this procedure ends. Let us denote by  $Y_*$  the resulting closed set. By construction, we have that

$$\mathcal{V}_{\geq \tilde{A}}^O(X) = Y_* \cup \bigcup_{A' > A} \mathcal{V}_{\geq A'}(X).$$

In particular, we obtain that  $\nu_{\text{ref}}^O$  is an upper semi-continuous function.

By combining the latter with Proposition 2.8, we get

**Proposition 2.12.** *The map  $\nu_{\text{ref}}^O : X \rightarrow \mathbb{N}^3$  distinguishes regular from singular points (A), is Zariski upper semi-continuous (B), is infinitesimally upper semi-continuous (C), and can only decrease finitely many times until it detects regularity (D).*



*Proof.* By Proposition 2.8, (A) holds. The previous construction implies property (B) and, since  $\nu_{\text{ref}}^O$  takes values in  $\mathbb{N}^3$ , (D) follows. It remains to show (C).

A  $\mathcal{B}$ -weakly permissible blowing up is in particular weakly permissible and thus  $\nu_{\text{ref}}$  does not increase at points  $x'$  lying above  $x$ . Furthermore, if  $\nu_{\text{ref}}(x') = \nu_{\text{ref}}(x)$  then the definition of  $O(x')$  implies  $|O(x')| \leq |O(x)|$ . Therefore we obtain (C).  $\square$

**Definition 2.13.** Let  $X \subset Z$  be as above. We distinguish the irreducible components of  $\text{Max-}\nu^O(X)$  as follows: If  $Z$  contains a field, then all irreducible components are defined to be *vertical*.

Suppose  $Z$  does not contain a field. Let  $Y \subset \text{Max-}\nu^O(X)$  be an irreducible component. We say  $Y$  is a *horizontal component* of  $\text{Max-}\nu^O(X)$  if  $Y \times_{\text{Spec}(\mathbb{Z})} \text{Spec}(\mathbb{Q}) \neq \emptyset$ . Otherwise,  $Y$  is called a *vertical component*. We denote by  $\text{Max-}\nu_{\text{hor}}^O(X)$  the set of horizontal components of  $\text{Max-}\nu^O(X)$ .

**Example 2.14.** Consider  $Z = \text{Spec}(\mathbb{Z}[x, y])$  with empty boundary. Let

$$X = V(x^2 - y^3 5^7 (y - 2)^4).$$

We leave it as an exercise to the reader to show that

$$\text{Max-}\nu^O(X) = \text{Max-}\nu(X) = \text{Max-ord}(X) = V(x, y) \cup V(x, 5) \cup V(x, y - 2).$$

By the previous definition,  $V(x, y)$  is a horizontal component and  $V(x, 5)$  is a vertical component lying above the prime 5. Furthermore, the third component,  $V(x, y - 2)$ , is also a horizontal component of  $\text{Max-}\nu^O(X)$  since it is non-empty after passing to  $\text{Spec}(\mathbb{Q}[x, y])$ . Note:  $V(x, y + p - 2, p) \in V(x, y - 2)$  since  $y - 2 = (y + p - 2) - p$ , for every prime  $p \in \mathbb{Z}$ .

**Definition 2.15.** Let  $\pi : Z' := B\ell_D(Z) \rightarrow Z$  be a blowing up with some irreducible regular center  $D$ . Let  $Y' \subset Z'$  be an irreducible subscheme contained in the exceptional divisor  $E' := \pi^{-1}(D)$ ,  $Y' \subset E'$ . Then  $Y'$  *dominates*  $D$  if its image under  $\pi$  is dense in  $D$ .

If the center  $D$  is not necessarily irreducible, we say  $Y'$  *dominates*  $D$  if there exists an irreducible component  $D_0$  of  $D$  which is dominated by  $Y'$ .

For example, let  $Z = \mathbb{A}_S^3$  with coordinates  $(x, y, z)$ ,  $S$  any base,  $D = D_0 = V(x, y)$ . We consider the chart with coordinates  $(x', y', z) := (x, \frac{y}{x}, z)$ . In this local situation, the exceptional divisor  $E'$  is  $V(x')$ , and the component  $V(x', y') \subset E'$  dominates the center, whereas  $V(x', z) \subset E'$  does not, the closure of its image in  $Z$  is  $V(x, y, z)$ .

We are now prepared to formulate our variant of the CJS-algorithm. We deliberately formulate this construction in a way close to the original one [16] Remark 6.29.

**Construction 2.16.** Let  $X$  be a reduced excellent Noetherian scheme of dimension two, embedded in a regular scheme  $Z$ ,  $X \subset Z$ . Let  $\mathcal{B}$  be a boundary on  $Z$ .

Horizontal case: Suppose  $\text{Max-}\nu_{\text{hor}}^O(X) \neq \emptyset$ , we set

$$Y_0 := \text{Max-}\nu_{\text{hor}}^O(X).$$

Since  $X$  is reduced,  $\dim(Y_0) < \dim(X)$  unless  $X$  is regular in which case the construction of a desingularization is complete. By the induction on dimension we find a finite sequence of  $\mathcal{B}$ -weakly permissible blowing ups,

$$(2.4) \quad \begin{array}{ccccccc} Z =: Z_0 & \longleftarrow & \cdots & \longleftarrow & Z_{m_0} =: Z' \\ \mathcal{B} =: \mathcal{B}_0 & & \cdots & & \mathcal{B}_{m_0} =: \mathcal{B}', \end{array}$$

such that the strict transform  $Y'_0$  of  $Y_0$  in  $Z'$  is a  $\mathcal{B}'$ -weakly permissible center for  $X_{m_0}$ . The next center chosen according to the construction is  $D_{m_0} := Y'_0$ ,

$$\begin{array}{ccc} Z' = Z_{m_0} & \longleftarrow & B\ell_{D_{m_0}}(Z_{m_0}) =: Z_{m_0+1} \\ \mathcal{B}' = \mathcal{B}_{m_0} & & \mathcal{B}_{m_0+1}. \end{array}$$

Let  $X_{m_0+1}$  be the strict transform of  $X_0 := X$  under the previous sequence of blowing ups.

If  $\max\text{-}\nu^O(X_{m_0+1}) < \max\text{-}\nu^O(X_0)$  then the singularity improved strictly and the construction restarts with the new maximal value for  $\nu_{\text{ref}}^O$  and the corresponding data. Further, if  $\max\text{-}\nu^O(X_{m_0+1}) = \max\text{-}\nu^O(X_0)$  and  $\text{Max-}\nu_{\text{hor}}^O(X_{m_0+1}) = \emptyset$ , we go to the vertical case below.

Suppose  $\max\text{-}\nu^O(X_{m_0+1}) = \max\text{-}\nu^O(X_0)$  and  $\text{Max-}\nu^O_{hor}(X_{m_0+1}) \neq \emptyset$ . In order to determine the next center we need to study the locus  $Y_{m_0+1} := \text{Max-}\nu^O_{hor}(X_{m_0+1})$ . We have a decomposition

$$Y_{m_0+1} = Y_{m_0+1}^{(0)} \cup Y_{m_0+1}^{(1)} \cup \dots \cup Y_{m_0+1}^{(m_0+1)}, \quad \text{where:}$$

- (i) For  $1 \leq i \leq m_0$ ,  $Y_{m_0+1}^{(i)}$  denotes the union of irreducible components in  $Y_{m_0+1}$  that first occurred after the  $i$ -th blowing up of the algorithm ("label  $i$  components").
- (ii)  $Y_{m_0+1}^{(0)}$  are those irreducible components of  $Y_{m_0+1}$  dominating the center  $D_{m_0}$  of the last blowing up. These inherit the label of  $D_{m_0}$ .
- (iii)  $Y_{m_0+1}^{(m_0+1)}$  are those irreducible components of  $Y_{m_0+1}$  lying above the center  $D_{m_0}$  but not dominating. Hence we assign the label  $m_0 + 1$  to them.

We also say,  $Y_{m_0+1}^{(j)}$  are the *irreducible components of  $Y_{m_0+1}$  with label  $j$* ,  $0 \leq j \leq m_0 + 1$ .

Let

$$k := \min\{j \in \{0, \dots, m_0 + 1\} \mid Y_{m_0+1}^{(j)} \neq \emptyset\}.$$

In the next step, the algorithm repeats the previous, with  $Y_{m_0+1}^{(k)}$  now in the place of  $Y_0$ . Let us point out that in (ii) the components dominating will obtain the label  $k$  instead of 0, of course.

Vertical case: Suppose  $\text{Max-}\nu^O_{hor}(X) = \emptyset$ . We set

$$Y_0 := \text{Max-}\nu^O(X),$$

and proceed analogous to the horizontal case using  $\text{Max-}\nu^O$  instead of  $\text{Max-}\nu^O_{hor}$ . Note that the vertical case is stable until  $\max\text{-}\nu^O$  decreases strictly (see the remark below).

**Remark 2.17.** As we explained before, an irreducible component  $Y'$  in  $\text{Max-}\nu^O_{hor}(X')$  (resp.  $\text{Max-}\nu^O(X')$ , if  $\text{Max-}\nu^O_{hor}(X) = \emptyset$ ) inherits the label of a component  $D$  contained in  $\text{Max-}\nu^O_{hor}(X)$  (resp.  $\text{Max-}\nu^O(X)$ ) if  $Y'$  dominates  $D$ . In order to obtain this situation, we must blow up an entire irreducible component of  $\text{Max-}\nu^O_{hor}(X)$  (resp.  $\text{Max-}\nu^O(X)$ ).

Set  $Y_0 := \text{Max-}\nu^O_{hor}(X) \subset Z$ . During the blowing ups in (2.4), where we prepare  $Y_0$  to become  $\mathcal{B}'$ -weakly permissible, the centers are strictly contained in some irreducible components. Therefore, even if a new irreducible component  $Y'$  in  $\text{Max-}\nu^O_{hor}(X')$  dominates the center, it never dominates a whole irreducible component of  $Y_0 = \text{Max-}\nu^O_{hor}(X)$ . Thus we assign to  $Y'$  a new label. (The analogous observation applies to  $\text{Max-}\nu^O(X)$ , if  $\text{Max-}\nu^O_{hor}(X) = \emptyset$ ).

An irreducible component  $Y' \subset \text{Max-}\nu^O(X')$  lying above a vertical component of  $D \subset \text{Max-}\nu^O(X)$  is always vertical. Hence, once  $\text{Max-}\nu^O_{hor}(X)$  is empty, it remains so until  $\max\text{-}\nu^O(X') < \max\text{-}\nu^O(X)$  decreases. In other words, in our variant of the CJS-algorithm, we first handle the horizontal components and whenever no horizontal component exists, we consider the vertical ones.

Let us emphasize that Construction 2.16 is a variant of the resolution process by Cossart, Jannsen, Saito, but the centers are not equal in general, see Example 4.16. In particular, we have to prove

**Proposition 2.18.** *Let  $X$  be a reduced excellent Noetherian scheme of dimension at most two, embedded in a regular scheme  $Z$ . Suppose that one of the following conditions holds:*

- (a)  $X$  has at most dimension one, or
- (b)  $X$  has dimension two and there exists a covering  $Z = \bigcup_{i=1}^m U_i$  such that  $X \cap U_i$  is isomorphic to a hypersurface.

*Then the sequence of blowing ups in regular centers constructed in Construction 2.16 provides a desingularization of  $X$ , i.e., after finitely many blowing ups the strict transform is regular and transversal to the exceptional locus (which is a simple normal crossing divisor).*

*Proof.* Suppose  $X$  has dimension at most one. Since  $X$  is reduced, its singular locus is at most a finite set of closed points,  $\text{Sing}(X) = \{p_1, \dots, p_a\}$ . Since blowing ups are isomorphisms outside the center, we may consider each of the closed points in  $\text{Sing}(X)$  separately. For every  $i \in \{1, \dots, a\}$ , there is a sufficiently small neighborhood  $V_i$  of  $p_i$  such that

$\text{Sing}(X) \cap V_i = \{p_i\}$ . In particular, the maximal refined order locus of  $X \cap V_i$  coincides with the maximal Hilbert-Samuel stratum of  $X \cap V_i$ . After blowing up with center  $p_i$ , the singular locus of the strict transform of  $X \cap V_i$  consists of a finite number of closed points and we repeat the previous argument. In conclusion, we see that locally our algorithm coincides with the original CJS-algorithm and hence the termination follows from [16] Theorem 1.3.

Let us come to the case (b). Let  $Z = \bigcup_{i=1}^m U_i$  be a covering such that  $X \cap U_i$  is isomorphic to a hypersurface. If  $X \cap U_i$  is singular, its maximal refined order locus coincides with the corresponding maximal order locus. Furthermore, the maximal Hilbert-Samuel stratum of  $X \cap U_i$  also coincides with the latter. Theorem 3.10 of [16] implies that the order and the Hilbert-Samuel function have the same behavior along blowing ups in regular centers contained in the maximal order locus. (Observe that the  $\nu^*$ -invariant of [16] Theorem 3.10 is completely determined by the order in the hypersurface case). In particular, the refined order locus of the strict transform of  $X \cap U_i$  coincides with the maximal Hilbert-Samuel stratum.

In [21] Observation 2.4, the arguments of [16] are summarized providing that after a blowing up, one creates at most finitely many closed points or a projective line in the maximal Hilbert-Samuel stratum. Since we are in the hypersurface case, this also applies to the locus of maximal refined order.

By case (a), we know that the preparation process (2.4) of the lowest label components is finite. By [16] Lemma 6.30, the first part of our algorithm is finite: More precisely, if we blow up a horizontal component (which must have dimension one), then the cited lemma provides that it may happen only finitely many times that there is a projective line dominating the previous center after blowing up. (Note that a closed point is necessarily vertical).

Hence, we may assume that there are no horizontal components in the locus of maximal refined order. Since the latter coincides with the maximal Hilbert-Samuel stratum (as we are in the hypersurface case), the original CJS-centers are the same as those chosen by Construction 2.16. Therefore, [16] Theorem 1.3 implies the termination.  $\square$

The following example shows that the proof for the termination of our variant of the CJS-algorithm cannot be reduced to the original result [16], in general. More precisely, we construct a scheme with an isolated singularity at a closed point and after blowing up the latter, the locus of maximal order of the strict transform contains a singular curve. This does not happen in the original CJS-resolution, where the Hilbert-Samuel function is considered instead of the refined order, see [21] Observation 2.4, where the arguments of [16] are summarized.

**Example 2.19.** Let  $a, b, c, d, m \in \mathbb{Z}_{\geq 2}$  with  $b > 2a$ ,  $c < d$ ,  $\gcd(a, b) = 1$ ,  $m \geq a(d+1)$ , and  $\gcd(acd, m) = 1 = \gcd(c, d)$ . Let  $X$  be the scheme given by the ideal

$$\langle x^a - y^b, (y^{d-c}z^c - u^d)^a + z^m \rangle,$$

where  $(x, y, z)$  are variables and  $u$  is a variable if we are over a field  $k$ , or  $u = p$  is a prime number if we are working over  $\mathbb{Z}$ . The locus of maximal order of  $X$  has ideal  $\langle x, y, z, u \rangle$ . If we blow up  $\langle x, y, z, u \rangle$ , then we obtain in the  $Y$ -chart:

$$x = y_1x_1, \quad y = y_1, \quad z = y_1z_1, \quad u = u_1y_1$$

and the ideal of the strict transform  $X_1$  of  $X$  is

$$\langle x_1^a - y_1^{b-a}, (z_1^c - u_1^d)^a + y_1^{m-ad}z_1^m \rangle.$$

The hypotheses on  $(a, b, c, d, m)$  imply that  $b - a > a$  and  $m - ad \geq a$ . Thus, we see that the locus of maximal order of  $X_1$  contains the singular curve given by the ideal

$$\langle x_1, y_1, z_1^c - u_1^d \rangle.$$

On the other hand, one may determine that the maximal Hilbert-Samuel stratum of  $X_1$  is the closed point corresponding to  $\langle x_1, y_1, z_1, u_1 \rangle$ .

While the closed point above is also the center of the CJS-resolution, it may happen that the center chosen by our variant of the algorithm is different from the original one, see Example 4.16.

In conclusion, it is not straight-forward to prove the termination of the sequence of blowing ups of Construction 2.16 using the techniques of [16]. Since the present article focuses on aspects of an explicit realizations of the algorithm using SINGULAR and GPI-Space, we leave the proof of the termination in the general case to a later article.

### 3. THE LOCUS OF REFINED MAXIMAL ORDER

Let  $X \subset Z$  be as before. In this section we discuss a method to compute the maximal order locus  $\text{Max-ord}(X)$  of  $X$  from a theoretical viewpoint. We deduce how to construct the maximal refined order locus  $\text{Max-}\nu(X)$ , from which we obtain its log-variant  $\text{Max-}\nu^O(X)$  by applying Construction 2.11. Within this, we may restrict ourselves to a finite affine covering  $\bigcup_{i \in I} U_i$  of  $Z$ . The respective loci are then obtained by gluing together the relevant affine pieces. Note, however, that the maximal value of  $\text{ord}$ ,  $\nu_{\text{ref}}$ , or  $\nu_{\text{ref}}^O$  achieved locally on  $X \cap U_i$  is not necessarily a global maximum for  $X$ .

We pass to the local situation in a fixed  $U_i$ : Let  $Z = \text{Spec}(A[\underline{x}]) = \mathbb{A}_A^m$ , where  $A$  is a field or a principal ideal Dedekind domain, and  $(\underline{x}) := (x_1, \dots, x_m)$ . Let  $X = V(I_X) \subset Z$  be the scheme defined by a non-zero ideal  $I_X \subset B := A[\underline{x}]$ .

In Lemma 3.1, we show how to compute the order  $\text{ord}_{I_0}(f)$ , for  $f \in B$  and  $I_0 := \langle \underline{x} \rangle \subset B$ , using differential operators. For a detailed background on (absolute) differential operators, we refer to [26] Chapter 2.

Let us recall the definition of *Hasse-Schmidt derivatives* (cf. [37], sections 2.5, 2.6, or [26] Example (3.3.1)): Let  $S = k[\underline{X}] = k[X_1, \dots, X_m]$  be a polynomial ring over a field  $k$ . Let  $F = F(\underline{X}) \in S$ . We introduce new variables  $(\underline{T}) = (T_1, \dots, T_m)$  and consider

$$(3.1) \quad F(\underline{X} + \underline{T}) = F(X_1 + T_1, \dots, X_m + T_m) = \sum_{\mathbf{a} \in \mathbb{Z}_{\geq 0}^m} F_{\mathbf{a}}(\underline{X}) \underline{T}^{\mathbf{a}}.$$

The Hasse-Schmidt derivative of  $F$  by  $\underline{X}^{\mathbf{a}}$  is defined by the coefficient of  $\underline{T}^{\mathbf{a}}$  in the previous expansion,

$$\frac{\partial}{\partial \underline{X}^{\mathbf{a}}} F(\underline{X}) = F_{\mathbf{a}}(\underline{X}).$$

For any  $\mathbf{a} = (a_1, \dots, a_m), \mathbf{b} = (b_1, \dots, b_m) \in \mathbb{Z}_{\geq 0}^m$  and  $\lambda \in k$ , we have

$$\frac{\partial}{\partial \underline{X}^{\mathbf{a}}} \lambda \underline{X}^{\mathbf{b}} = \lambda \binom{\mathbf{b}}{\mathbf{a}} \underline{X}^{\mathbf{b}-\mathbf{a}},$$

where  $\binom{\mathbf{b}}{\mathbf{a}} = \binom{b_1}{a_1} \cdots \binom{b_m}{a_m}$  and  $\binom{\mathbf{b}}{\mathbf{a}} = 0$  if  $b < a$ . In particular,  $\frac{\partial}{\partial \underline{X}^{\mathbf{a}}} \underline{X}^{\mathbf{a}} = 1$ .

Let  $Y$  be one of the variables and  $a, b \in \mathbb{Z}_{\geq 0}$ . Since  $\binom{b}{a} \in \mathbb{Z}$ , we can relate the Hasse-Schmidt derivatives to usual derivatives via the following symbolic computations:

$$(3.2) \quad \frac{\partial}{\partial Y^a} Y^b = \binom{b}{a} Y^{b-a} = \frac{b!}{a!(b-a)!} Y^{b-a} = \frac{1}{a!} \left( \frac{\partial}{\partial Y} \right)^a Y^b.$$

More generally, we have, for  $\mathbf{a} = (a_1, \dots, a_m) \in \mathbb{Z}_{\geq 0}^m$ , that

$$\frac{\partial}{\partial \underline{X}^{\mathbf{a}}} = \frac{1}{a_1! \cdots a_m!} \left( \frac{\partial}{\partial X_1} \right)^{a_1} \cdots \left( \frac{\partial}{\partial X_m} \right)^{a_m}.$$

In fact, the above construction is valid if we replace the field  $k$  by any domain  $R$ . For  $B = A[\underline{x}]$ , the usual derivatives by the variables  $x_i$  and the Hasse-Schmidt derivatives generate the  $B$ -module  $\text{Diff}_A(B)$  of  $A$ -linear differential operators.

Using Hasse-Schmidt derivatives, we can recall a first connection between the order and differential operators:

**Lemma 3.1.** *Let  $R$  be a domain and  $S = R[\underline{x}]$ , for  $(\underline{x}) = (x_1, \dots, x_m)$ . Set  $I_0 = \langle \underline{x} \rangle \subset S$ . We have that, for every  $f \in S \setminus \{0\}$ ,*

$$\text{ord}_{I_0}(f) = \min \left\{ i \in \mathbb{N} \mid \exists \mathbf{a} \in \mathbb{N}^m : |\mathbf{a}| = i \wedge \frac{\partial}{\partial \underline{x}^{\mathbf{a}}} f \notin I_0 \right\}.$$

Note that  $R$  is any domain, hence we switch the notation to  $R \subset S$  instead of  $A \subset B$  since the latter is reserved for  $A$  a field or a principal ideal Dedekind domain.

*Proof.* Recall that  $\text{ord}_{I_0}(f) = \sup\{i \in \mathbb{N} \mid f \in I_0^i\}$ . Set  $d := \text{ord}_{I_0}(f) < \infty$ . Since  $S$  is a polynomial ring over  $R$ , we have that  $f = \sum_{\mathbf{a}} \lambda_{\mathbf{a}} \underline{x}^{\mathbf{a}}$ , for  $\mathbf{a} \in \mathbb{N}^m$  and some  $\lambda_{\mathbf{a}} \in R$  of which only finitely many are non-zero. By definition of the order at  $I_0 = \langle \underline{x} \rangle$ ,

$$d = \min\{i \in \mathbb{N} \mid \exists \mathbf{a} \in \mathbb{N}^m : |\mathbf{a}| = i \wedge \lambda_{\mathbf{a}} \neq 0\}.$$

Let  $\mathbf{a}_0 \in \mathbb{N}^m$  be such that  $|\mathbf{a}_0| = d$  and  $\lambda_{\mathbf{a}_0} \neq 0$ . We have that

$$\frac{\partial}{\partial \underline{x}^{\mathbf{a}_0}} f = \lambda_{\mathbf{a}_0} + \sum_{\mathbf{b} \neq \mathbf{0}} \lambda_{\mathbf{a}_0 + \mathbf{b}} \binom{\mathbf{a}_0 + \mathbf{b}}{\mathbf{a}_0} \underline{x}^{\mathbf{b}} \notin I_0.$$

By the minimality of  $d$ , the assertion follows.  $\square$

At a closed point, e.g., given by the maximal ideal  $\langle p, x_1, \dots, x_m \rangle$ , for some prime element  $p \in A$ , the connection with differential operators is best seen in the associated graded ring, where  $p$  corresponds to some variable, say  $P$ .

**Example 3.2.** Consider the hypersurface  $X := V(f) \subset \mathbb{A}_{\mathbb{Z}}^2 =: Z$  given by the polynomial

$$f = 12 - uv^2 \in \mathbb{Z}[u, v].$$

Since  $12 = 3 \cdot (1 + 3)$  the order of  $f$  at the maximal ideal  $\mathfrak{m} := \langle 3, u, v \rangle$  is one. Therefore  $X$  is not singular at the point corresponding to  $\mathfrak{m}$ , although  $X$  is singular in the fiber modulo 3. The initial form of  $f$  with respect to  $\mathfrak{m}$  is

$$\text{in}_{\mathfrak{m}}(f) = P \in k_{\mathfrak{m}}[P, U, V],$$

where  $P := 3 \pmod{\mathfrak{m}^2}$ ,  $U := u \pmod{\mathfrak{m}^2}$ , and  $V := v \pmod{\mathfrak{m}^2}$ , and  $k_{\mathfrak{m}} = \mathbb{Z}/3$ . As we can see the derivative of  $\text{in}_{\mathfrak{m}}(f)$  by  $P$  is non-zero.

On the other hand,  $12 = 2^2 \cdot (1 + 2)$  and at the point corresponding to the maximal ideal  $\mathfrak{n} := \langle 2, u, v \rangle$ , we have  $\text{ord}_{\mathfrak{n}}(f) = 2$ . The initial form is

$$F := \text{in}_{\mathfrak{n}}(f) = Q^2 \in k_{\mathfrak{n}}[Q, U, V],$$

where  $Q := 2 \pmod{\mathfrak{n}^2}$  ( $U, V$  analogous to above) and  $k_{\mathfrak{n}} = \mathbb{Z}/2$ . The derivative by  $Q$  is  $2Q = 0$  in the graded ring. (We also introduced the letter  $Q$  for  $2 \pmod{\mathfrak{n}^2}$  in order to avoid confusion between the powers of the element  $2 \pmod{\mathfrak{n}^2}$  and a factor  $2 = 0 \in k_{\mathfrak{n}}$ ). Of course, we have  $\frac{\partial}{\partial Q}(\frac{\partial}{\partial Q} F) = 0 \in \mathfrak{n}$ , but we have that  $\frac{\partial}{\partial Q^2} Q^2 = 1 \notin \mathfrak{n}$ . This shows the connection between the order of  $f$  at  $\mathfrak{n}$  and differential operators.

Nonetheless, we need also so called *derivatives by constants*, i.e., with respect to elements in the field itself, in order to compute the locus of maximal order. This is related to the notion of  $p$ -bases (see [40], 0<sub>IV</sub> (21.1.9), or [26] section 2.2).

**Definition 3.3.** Let  $S$  be a ring containing a field of characteristic  $p$  and  $e \in \mathbb{N}$ ,  $e > 0$ . A family  $(s_i)_{i \in I}$  in  $S$  is called  $p^e$ -independent (resp. a  $p^e$ -basis) of  $S$  if the family of monomials  $\underline{x}^{\mathbf{a}}$  with  $\mathbf{a} \in \mathbb{N}^{(I)}$ ,  $0 \leq a_i < p^e$  ( $i \in I$ ), is a free family (resp. a basis) for the  $S^{p^e}$ -module  $S$ .

Note that the family  $(s_i)_{i \in I}$  is not necessarily finite. If the Frobenius  $F : S \rightarrow S$ ,  $b \mapsto b^p$ , is injective (e.g., if  $S$  is a domain) and  $(s_i)_{i \in I}$  is a  $p$ -basis, then the monomials  $\underline{x}^{\mathbf{a}}$  with  $0 \leq a_i < p^e$  form a basis for  $S$  considered as  $S^{p^e}$ -module ([26] Remark (2.2.3)).

If  $S = k[X_1, \dots, X_m]$  is a polynomial ring over a field  $k$  and if  $(\lambda_i)_{i \in I}$  is a  $p^e$ -basis for  $k$ , then the family  $(\lambda_i, X_j)_{i \in I, j \in \{1, \dots, m\}}$  is a  $p^e$ -basis for  $S$  ([26] Remark (2.2.7)).

Two crucial results are

**Proposition 3.4** ([26] Proposition (2.2.5)). *Let  $S$  be a ring containing a field of characteristic  $p$ . Let  $(s_i)_{i \in I}$  be a  $p$ -basis of  $S$  and suppose that the Frobenius  $F : S \rightarrow S$  is injective. For every multiindex  $\mathbf{a} \in \mathbb{N}^{(I)}$ , there exists  $\mathcal{D}_{\mathbf{a}} \in \text{Diff}_{\mathbb{Z}}^{\leq |\mathbf{a}|}(S)$  with*

$$\mathcal{D}_{\mathbf{a}}(\underline{x}^{\mathbf{b}}) = \binom{\mathbf{b}}{\mathbf{a}} \underline{x}^{\mathbf{b}-\mathbf{a}},$$

for all  $\mathbf{b} \in \mathbb{N}^{(I)}$ . Furthermore, every  $\mathcal{D} \in \text{Diff}_{\mathbb{Z}}^{\leq m}(S)$  is a (possibly infinite) sum

$$\mathcal{D} = \sum_{|\mathbf{a}| \leq m} c_{\mathbf{a}} \mathcal{D}_{\mathbf{a}}$$

with unique coefficients  $c_{\mathbf{a}} \in S$ .

**Lemma 3.5** ([36] Lemma 1.2.3, p. III-4 (cf. [26] Lemma (2.3.1)). *Let  $R$  be a ring,  $S$  be an  $R$ -algebra, and  $\mathcal{D} \in \text{Diff}_R^{\leq i}(S)$ . For an ideal  $I \subseteq S$  and  $\ell \geq i$ , we have*

$$\mathcal{D}(I^\ell) \subseteq I^{\ell-i}.$$

**Example 3.6.** Let  $S = k[X, Y]$ , where  $k$  is a non-perfect field of characteristic two. Consider  $F = X^2 - \lambda Y^2$  with  $\lambda \in k \setminus k^2$ . The element  $\lambda$  can be extended to a 2-basis for  $k$ . We fix a 2-basis  $(\lambda_i)_{i \in I}$  of  $k$  containing  $\lambda$ . Then we can speak about the derivative  $\frac{\partial}{\partial \lambda}$ .

The maximal order of  $F$  is 2 and we have

$$\frac{\partial}{\partial \lambda}(X^2 - \lambda Y^2) = Y^2.$$

Since all other first order derivatives are zero, this implies that the locus of maximal order is the closed point  $V(X, Y)$ .

We now come to the computation of the maximal order locus.

**Construction 3.7.** Let  $J \subset B = A[\underline{x}]$  be a non-zero ideal, where  $A$  is a field or a principal ideal Dedekind domain. Set  $X := V(J)$ . Let

$$d := \max\{\text{ord}_x(X) \mid x \in X\} \geq 1.$$

For  $d = 1$ , the locus of maximal order is  $X$ . Hence let us suppose  $d > 1$ .

If  $B$  contains a field  $k$ ,  $k \subseteq B$ , then, using Proposition 3.4 and Lemma 3.5, we get that the maximal order locus for  $X = V(J)$  is given by

$$\Delta^{d-1}(J) := V(\mathcal{D}f \mid f \in J, \mathcal{D} \in \text{Diff}_{\mathbb{Z}}^{\leq d-1}(B)).$$

Suppose  $B$  does not contain a field (i.e.,  $A$  is of mixed characteristic). Let  $F := \text{Frac}(A)$  be the field of fractions of  $A$  and set  $B_F := B \otimes_A F = F[\underline{x}]$ . If the maximal order of  $V(J \cdot B_F)$  is equal to  $d$ , then  $\Delta^{d-1}(J \cdot B_F)$  provides the horizontal irreducible components of the locus of maximal order of  $X = V(J)$ .

For the vertical components, let  $p \in A$  be a prime element. We pass from  $B = A[\underline{x}]$  to  $B_p := B \otimes_A \text{gr}_p(A) = (\text{gr}_p(A))[\underline{x}]$ . An element  $\sum f_{\mathbf{a}} \underline{x}^{\mathbf{a}} \in B$  is mapped to  $\sum F_{\mathbf{a}} \underline{x}^{\mathbf{a}} \in B_p$ , where  $F_{\mathbf{a}} = F_{\mathbf{a}}(P) = \text{in}_p(f_{\mathbf{a}}) \in \text{gr}_p(A) \cong k_p[P]$  with  $P := \text{in}_p(p) = p \bmod p^2$  and  $k_p := A/p$  the residue field. Note that  $B_p \cong k_p[P, \underline{x}]$  is a polynomial ring over the field  $k_p$ . If the maximal order of  $V(J \cdot B_p)$  is equal to  $d$ , then  $\Delta^{d-1}(J \cdot B_p)$  provides the vertical irreducible components of the locus of maximal order of  $X = V(J)$  lying above  $p$ .

Applying this procedure for every prime  $p \in A$ , we eventually obtain  $\text{Max-ord}(X)$ .

**Remark 3.8.** (1) Since the max order locus has only finitely many irreducible components, there are only finitely many primes that need to be considered. An essential point in implementing the resolution algorithm is to detect these "interesting primes". In the next section we address this issue for  $A = \mathbb{Z}$ .

(2) The case  $A = \mathbb{Z}$  also explains why we need to pass to  $\text{gr}_p(A)$ . Let  $p \in \mathbb{Z}$  be any prime number, e.g.,  $p = 2$ . There cannot exist a derivation by 2 since every derivation is  $\mathbb{Z}$ -linear. Assume there exists  $\mathcal{D} \in \text{Diff}_{\mathbb{Z}}(B)$  being the derivation by 2. Then  $\mathcal{D}$  certainly has to fulfill  $\mathcal{D}(2) = 1$ . But the  $\mathbb{Z}$ -linearity implies

$$1 = \mathcal{D}(2) = 2\mathcal{D}(1) = 2 \cdot 0 = 0. \quad - \quad \text{Contradiction.}$$

(3) In fact, the method in the previous construction can be applied to compute the locus of all points of order at least  $d'$ , for any  $d' \in \mathbb{Z}_+$  instead of  $d$ .

Using Construction 3.7, we can describe how to determine the locus of maximal refined order  $\text{Max-}\nu(X)$  of  $X$ . As before, we reduce to the affine case and then glue the components.

**Construction 3.9.** Let  $J \subset B = A[\underline{x}]$  be a non-zero ideal, where  $A$  is a field or a principal ideal Dedekind domain. Set  $X = V(J)$  and  $Z = \text{Spec}(B)$ . Suppose

$$\text{max-}\nu(X) = (\alpha, \delta) \in \mathbb{N}^2.$$

We provide an inductive construction of  $\text{Max-}\nu(X)$  depending on

$$a := a(Z) := N - \alpha = \dim(Z) - \alpha \geq 0 \quad (\text{recall Definition 2.4}).$$

If  $a = 0$ , then  $\text{Max-}\nu(X)$  coincides with the locus of maximal order  $\text{Max-ord}(X)$  and we may apply Construction 3.7.

Suppose  $a(Z) \geq 1$ . Then,  $J$  is of order one at every point of  $X$ . In this case, it is possible to descend in the dimension of the ambient space locally at every point. Hence, for every point  $q$  in  $\text{Spec}(B)$ , there exists a differential operator  $\partial = \partial(q)$  such that  $(\partial J) \cdot B_{I_q} = B_{I_q}$ , where  $\partial J = \langle \partial h \mid h \in J \rangle$  and  $B_{I_q}$  denotes the localization of  $B$  at the ideal of  $q$ . (Note that, if necessary, we pass from  $B$  to  $B_p$  as in the previous construction).

Let  $(f_1, \dots, f_r)$  be a standard basis of  $J$ . The latter implies that there is a (refined) finite open covering of  $X$ ,  $X \subset \bigcup_{\ell} U_{\ell}$ , such that in each  $U_{\ell}$ , we have that

$$X_{\ell} := X \cap U_{\ell} \subset V(f_{j(\ell)}) \cap U_{\ell} =: Z_{\ell},$$

and  $V(f_{j(\ell)})$  is regular in  $U_{\ell}$ , for some  $j(\ell) \in \{1, \dots, r\}$ . Let us discuss how to detect such a hypersurface of order one. If  $A$  is a perfect field, we can apply the Jacobian criterion for each generator of  $J$  separately and consider the derivatives with respect to the variables  $(\underline{x})$ . If  $A$  is a non-perfect field, we apply Zariski's Jacobian criterion ([54] Theorem 11), which involves a  $p$ -basis for  $A$  and uses that there are only finitely many non-zero coefficients appearing in each generator  $f_1, \dots, f_r$ . If  $A$  is a principal ideal Dedekind domain that is not a field, there are only finitely many primes  $p_1, \dots, p_{\rho} \in A$  appearing in the coefficients of  $f_i$  for each  $i$  and for every  $j \in \{1, \dots, \rho\}$ , we proceed as follows: analogous to Construction 3.7, we pass from  $B$  to  $B_{p_j} := B \otimes_A \text{gr}_{p_j}(A) \cong k_{p_j}[P, \underline{x}]$ , where  $k_{p_j} := A/p_j$  is the residue field at  $p_j$  and  $P$  is a new variable. Then, we apply the Jacobian criterion to detect the desired hypersurface, now also considering the derivative by  $P$ .

By Proposition 2.8, we have  $\text{max-}\nu(X_{\ell}) \leq \text{max-}\nu(X)$ . If the inequality is strict, we may discard  $U_{\ell}$ . Otherwise, we have  $\text{max-}\nu(X_{\ell}) = (\alpha, \delta)$  and since  $\dim(Z_{\ell}) = \dim(Z) - 1$ , we get  $a(Z_{\ell}) = a(Z) - 1$  (since  $\nu_{\text{ref}}$  and hence  $\text{max-}\nu(X)$  does not depend on the embedding). By induction, we know how to determine  $\text{Max-}\nu(X_{\ell})$ . By gluing together the relevant affine pieces, we obtain then  $\text{Max-}\nu(X)$ .

Finally, if  $\text{max-}\nu^O(X) = (\alpha, \delta, \sigma) \in \mathbb{N}^3$ , we can apply Construction 2.11 to obtain from  $\text{Max-}\nu(X)$  the locus of maximal log-refined order  $\text{Max-}\nu^O(X)$ .

**Observation 3.10.** For practical reason, we like to point out some facts about computing the maximal locus after blowing up: Let  $X \subset Z$  be as before. Suppose  $\text{Max}(X) \subset X$  is a locus that we may compute from  $X$  (e.g.,  $\text{Max}(X) = \text{Max-}\nu^O(X)$ , or  $\text{Max}(X)$  being the (maximal) Hilbert-Samuel locus of  $X$ , cf. [16], Definition 2.35).

Let  $\pi : Z' = \text{Bl}_D(Z) \rightarrow Z$  be the blowing up in some regular center  $D \subsetneq \text{Max}(X)$  and denote by  $X'$  the strict transform of  $X$  under  $\pi$ . Set  $E := \pi^{-1}(D)$ , the exceptional divisor of the blowing up. The locus  $\text{Max}(X')$  consists of two types of irreducible components:

- (1) The strict transform  $Y'$  of  $Y := \text{Max}(X)$  is contained in  $\text{Max}(X')$ .
- (2) We may have created new components. But we know that each of them has to be contained in the exceptional divisor  $E$ .

Since we computed  $Y$  before, we can simply determine its strict transform under  $\pi$  in order to obtain the components of  $\text{Max}(X')$  of type (1). Therefore it is only left to determine the new components, i.e., those of type (2). The fact that these are contained in  $E$  then helps to simplify the local computations. The latter is also useful when  $D = \text{Max}(X)$  is the entire locus, in which case there is no component of type (1) in  $\text{Max}(X')$  and one has to check whether  $X'$  strictly improved compared to  $X$ .

#### 4. ALGORITHMIC FORMULATION AND EXAMPLES

In the previous sections the theoretical side of the desingularization algorithm by Cossart-Jannsen-Saito has been outlined to give us a solid basis for implementation aspects. We have seen that the main loop is a sequence of blowing ups of the arithmetic surface at suitably chosen centers.

From the computational point of view, it is standard to represent the given schemes by means of a covering with affine charts, i.e., as ideals in a polynomial ring. In each of these charts, we then encounter a situation  $I_Z \subset I_X \subset I_Y \subset A[\underline{x}]$  at the beginning and with the boundary  $\mathcal{B}$  on  $Z$  represented by  $I_Z \subset I_{\mathcal{B}} \subset A[\underline{x}]$  in later steps of the construction.

In general, the underlying base ring  $A$  can be any principal ideal Dedekind domain or field, as long as the arithmetic operations are practically computable; for the purpose of this section, however, we shall concentrate on the case of  $A = \mathbb{Z}$ . As the choice of centers is controlled by the locus of maximal value of  $\nu_{\text{ref}}^O$ , intersections of charts and patching are not an issue in this process. Moreover, blowing up at a given regular center is a well-understood standard technique, see e.g. [25] or [29]. We can hence focus completely on the practical aspects of the choice of centers in this section.

**Remark 4.1.** As we have seen before, the key ingredient for the choice of the center is the computation of  $\text{Max-}\nu^O(X)$  which was discussed from the theoretical point of view in the last section. More precisely, the center is constructed as follows:

**Step 1:** If the maximal order of  $X$  is one, the scheme can locally be embedded into a regular hypersurface and it thus suffices to find an open covering such that the use of a single such hypersurface on an open set is possible. The equation of this hypersurface can then be added to the generators of the ideal of the ambient space  $Z$ . Iterating this process, we descend in ambient space as long as we have not reached to minimal appearing  $a_x$  at any point  $x \in X$ . At these points the first entry of the invariant  $N - a_x$  attains a maximal value. (Cf. Constructions 3.7 and 3.9).

**Step 2:** Again computing the locus of maximal order of  $X$  with the new ambient space  $Z$  resulting from step 1, we reach the locus of maximal refined order, i.e., the points where  $\nu_{\text{ref}}(x) = (N - a_x, d_x)$  has maximal value.

**Step 3:** By taking into account the exceptional divisors, we obtain the locus of maximal log-refined order (cf. Construction 2.11).

**Step 4:** We label the irreducible components of  $\text{Max-}\nu^O(X)$  using the history of the resolution process and detect the locus of components which have smallest label (cf. Construction 2.16 and the remark after it). Since  $X$  is reduced and of dimension two, the latter components have at most dimension one. Hence, we either blow up the entire smallest label locus, or we have to prepare it to become weakly permissible by blowing up closed points.

Step 1 and Step 3 are standard techniques that already appear over fields of characteristic zero (cf. [12]). Moreover, they have been realized in implementations (see [8], [31]) and it requires at most minor modifications to adapt the algorithms to our situation. No special features of positive or mixed characteristic appear in these steps. The same is true for the labeling process in Step 4 which is of combinatorial nature and only requires some diligent book keeping.

Therefore, we completely focus on the algorithm to determine the locus of maximal order in the arithmetic setting, see Algorithm 3. The approach presented in the previous section is purely theoretical as it requires local computations at each point. The analogous problem already occurs in the by far simpler case of desingularization over a field of characteristic zero and we mimic the approach taken there. To this end, we first state the algorithm in characteristic zero before developing a similar approach in the arithmetic case, see Algorithm 1: MaxOrd (char  $K = 0$ ) (p.17). (In there, we denote by  $D(h)$  the principal Zariski open set determined by  $h \in \mathbb{Q}[x_1, \dots, x_n]$ ).

Note that we only require that  $Z$  is equidimensional and not necessarily irreducible. Since  $Z$  is regular, all irreducible components are disjoint. From a theoretical viewpoint, it suffices to solve the resolution problem on each component separately and hence one may reduce to the case  $Z$  irreducible. In praxis, we may have to deal with  $Z$  having several irreducible components if we pass to a smaller dimensional ambient space as in Construction 3.9.

**Remark 4.2** ([11] Remark 3.3). As the minor  $\det(M)$  is only invertible on the principal open set  $D(\det(M))$  (from step 12 of Algorithm 1 onwards), the differentiation in step 16 is more subtle than it seems at first glance. We start by determining a square matrix  $A$  satisfying

$$A \cdot M = q \cdot E_{\text{codim}(Z)},$$

where  $q := \det(M)$  and  $E_{\text{codim}(Z)}$  is the unit matrix of size  $\text{codim}(Z)$ . On  $D(q)$ ,  $\frac{1}{q} \cdot A$  is precisely the inverse matrix of  $M$ . As system of parameters  $y_1, \dots, y_s$ , we use the one induced by  $\{x_i \mid i \text{ not a column in } M\}$ . Let  $g_1, \dots, g_t \in \mathbb{Q}[\underline{x}]$  be a set of generators for



**Algorithm 1** MaxOrd (char  $K = 0$ )

---

**Input:**  $I_Z \subset \mathbb{Q}[x_1, \dots, x_n] = \mathbb{Q}[\underline{x}]$  such that  $Z := V(I_Z)$  is equidimensional and regular,

$I_X \subsetneq \mathbb{Q}[\underline{x}]$  such that  $I_Z \subset I_X$ , i.e.,  $\emptyset \neq X := V(I_X) \subset Z$

**Output:**  $(m, I)$ , where  $m = \text{max-ord}(X)$  and  $I$  ideal describing Max-ord( $X$ )

```

1:  $I_{temp} = I_X$ 
2: if  $I_Z == \langle 0 \rangle$  then
3:    $I_{max} = \langle 1 \rangle$ ,  $maxord = 0$ 
4:   while  $I_{temp} != \langle 1 \rangle$  do
5:      $I_{max} = I_{temp}$ 
6:      $I_{temp} = I_{temp} + \langle \frac{\partial f_i}{\partial x_j} \mid 1 \leq j \leq n \text{ and } 1 \leq i \leq r \rangle$ , where  $f_1, \dots, f_r$  generate  $I_{temp}$ 
7:      $maxord = maxord + 1$ 
8:   return  $(maxord, I_{max})$ 
9:  $L = \{\text{codim}(Z) \text{ square submatrices of Jacobian matrix of } I_Z\}$ 
10: choose a subset  $L_1 \subset L$  such that  $X \subset \bigcup_{M \in L_1} D(\det(M))$ 
11:  $maxord = 1$ ,  $thisord = 0$ ,  $I_{max} = \langle 0 \rangle$ 
12: for  $M \in L_1$  do
13:   denote by  $y_1, \dots, y_s$  the system of parameters on  $Z \cap D(\det(M))$  induced by variables
   not corresponding to columns of  $M$ 
14:    $I_{temp} = I_X$ 
15:   while  $I_{temp} + I_Z != \langle 1 \rangle$  do
16:      $I_{old} = I_{temp}$ 
17:      $I_{temp} = I_{temp} + \langle \frac{\partial f_i}{\partial y_j} \mid 1 \leq j \leq s \text{ and } 1 \leq i \leq r \rangle$ ,
     where  $f_1, \dots, f_r \in \mathbb{Q}[\underline{x}]$  correspond to generators of  $I_{temp} \cdot \mathbb{Q}[\underline{x}]/I_Z$ 
     (precise formulation of  $\frac{\partial f_i}{\partial y_j}$  in Remark 4.2)
18:      $I_{temp} = \text{sat}(I_{temp}, \det(M))$ 
19:      $thisord = thisord + 1$ 
20:   if  $thisord \geq maxord$  then
21:     if  $thisord == maxord$  then
22:        $I_{max} = I_{max} \cap I_{old}$ 
23:     else
24:        $maxord = thisord$ ,  $I_{max} = I_{old}$ 
25:      $thisord = 0$ 
26: return  $(maxord, I_{max})$ 

```

---

$I_Z$ . Further, we choose a set of generators  $\overline{f}_1, \dots, \overline{f}_r \in \mathbb{Q}[\underline{x}]/I_Z$  for the ideal  $I_X \cdot \mathbb{Q}[\underline{x}]/I_Z$  and choose representatives  $f_1, \dots, f_r \in \mathbb{Q}[\underline{x}]$  for these. For simplicity of presentation, we assume in the next formula that  $M$  involves precisely the last columns of the Jacobian matrix so that the indices of  $y_i$  and the corresponding  $x_i$  coincide. Then the chain rule provides the following derivatives:

$$(4.1) \quad q \cdot \frac{\partial f_i}{\partial y_j} = q \cdot \frac{\partial f_i}{\partial x_j} - \sum_{\substack{k \text{ column of } M \\ \ell \text{ row of } M}} \frac{\partial g_\ell}{\partial x_j} A_{\ell k} \frac{\partial f_i}{\partial x_k} \pmod{I_Z}.$$

To discard the extra factor  $q$  or more geometrically all components inside  $V(q)$ , we then need to saturate the resulting ideal with  $\langle q \rangle$ .

In the arithmetic setting, we first need to determine the primes above which we might find components of Max-ord( $X$ ) (resp. Max- $\nu^O(X)$ ). The following examples show that it is not feasible to read off the relevant primes from a given set of generators:

**Example 4.3.** Let  $f = 3x - y + 7z$  and  $g = x - 4y + 6z$ .

- (1) Consider  $I_Z = \langle g \rangle \subset \langle g, f \rangle = I_X \subset \mathbb{Z}[x, y, z]$ . The coefficients of the generators suggest that at most the primes 2, 3, 7 are relevant. However, passing to a different second generator of  $I_X$  we get  $f - 3g = (3x - y + 7z) - 3 \cdot (x - 4y + 6z) = 11 \cdot (y - z)$  and the locus of order two is  $V(11, y - z, g) = V(11, y - z, x + 2y)$ .

(2) Let  $I_Z = \langle 0 \rangle$  and  $I_X = \langle h \rangle \subset \mathbb{Z}[x, y, z]$  be the principal ideal generated by

$$h = f^2 - g^2 = 8x^2 + 2xy - 15y^2 + 30xz + 34yz + 13z^2.$$

If we introduce the new variable  $\tilde{x} := x - 4y + 6z = g$ , then  $f = 3\tilde{x} + 11(y - z)$ . Using  $\tilde{y} := y - z$ , we see that

$$h = (f - g)(f + g) = (2\tilde{x} + 11\tilde{y})(4\tilde{x} + 11\tilde{y}).$$

The locus of order two is given by the ideal  $\langle 2\tilde{x} + 11\tilde{y}, 4\tilde{x} + 11\tilde{y} \rangle = \langle 2\tilde{x}, 11\tilde{y} \rangle$ . In particular, there is the irreducible components  $V(\tilde{x}, 11)$ , and 11 does not appear as prime factor in the coefficients of  $h$  as polynomial in  $(x, y)$ .

To systematically determine the primes relevant for the locus of maximal order, we now try to mimic the previous algorithm which had been formulated in the case of a field of characteristic zero. Over  $\mathbb{Z}$ , we cannot expect to obtain the correct locus from this construction – not even using Hasse-Schmidt derivatives – as we are still missing the ‘derivative’ with respect to the prime. On the other hand, the algorithm for computing  $\text{Max-ord}(X)$  is blind to vertical components of it (cf. Definition 2.13) if there are horizontal components. The latter behavior is not a flaw, but in tune with the fact that we have given horizontal components precedence over vertical ones in the description of the resolution algorithms in the previous section.

In an ad-hoc notation, we shall call the primes arising from the algorithm *interesting* as the bad primes will eventually appear among those in the course of the resolution, but not all of the arising primes need to be bad.

In [Algorithm 2: InterestingPrimes \(p.19\)](#), we present an algorithm that detects the set of interesting primes.

Note that we demand in line 21 of Algorithm 2 that  $I_{int} \neq \langle 1 \rangle$  in order to avoid to speak of the prime factors of  $1 \in \mathbb{Z}$ .

**Remark 4.4.** Obviously, the resulting list of interesting primes will heavily depend on the choice of the system of generators  $(g)$  of  $I_Z$  and  $(g, f)$  of  $I_X$ . The set  $\{p_1, \dots, p_\alpha\}$  is not uniquely determined by  $I_Z$ . Since our goal is to determine a *finite* list of prime numbers, at which we have to test for components in the maximal order locus, the dependence on the mentioned choices is not a problem.

In Algorithm 1 the criterion for the end of the while loop is  $I_{temp} + I_Z = \langle 1 \rangle$ , while here it is  $I_{int} = (I_{temp} + I_Z) \cap \mathbb{Z} \neq \langle 0 \rangle$ . The former can as well be phrased as  $(I_{temp} + I_Z) \cap \mathbb{Z} \neq \langle 0 \rangle$ , which immediately reveals the structural similarity to the latter.

We introduce the following notation.

**Notation 4.5.** Let  $Z \subseteq \text{Spec}(\mathbb{Z}[x_1, \dots, x_n])$  be an equidimensional, regular closed subscheme and let  $X \subset Z$  be a non-empty closed subscheme of  $Z$ . We call a prime number  $p \in \mathbb{Z}$  *bad (for  $X$ )* if the following two conditions hold:

- $\text{Max-ord}(X)_{hor} = \emptyset$  and
- there is an irreducible components  $W \subseteq \text{Max-ord}(X)$  such that  $W \subset V(p)$ .

If  $p$  is not a bad prime, we say  $p$  is a *good prime (for  $X$ )*.

Whenever it is clear from the context for which subscheme  $X$  we are determining good and bad primes, we skip the reference to  $X$ .

**Lemma 4.6.** *Let  $X = V(I_X) \subset Z = V(I_Z)$ , for  $I_Z = \langle g_1, \dots, g_t \rangle \subset I_X = \langle g, f_1, \dots, f_r \rangle \subsetneq \mathbb{Z}[\underline{x}]$ . The set of interesting primes  $\mathfrak{P} = \{p_1, \dots, p_\rho\}$  resulting from Algorithm 2 (with the given choice of  $(g, f)$ ) contains all bad primes.*

*Proof.* Assume  $I_Z \cap \mathbb{Z} = \langle m \rangle \neq \langle 0 \rangle$ , for  $m \in \mathbb{Z}_{\geq 2}$ . Then  $Z \subset V(m)$  and every prime number, which is bad, has to be a divisor of  $m$ . On the other hand, if  $\text{Max-ord}(X)_{hor} \neq \emptyset$ , there is nothing to prove as the set of bad primes is empty in this case, by definition.

Let us suppose that  $I_Z \cap \mathbb{Z} = \langle 0 \rangle$  and  $\text{Max-ord}(X)_{hor} = \emptyset$ . Set  $d := \text{max-ord}(X)$  and let  $p$  be a bad prime. We first consider the case  $I_Z = \langle 0 \rangle$ . Since there are no horizontal components in  $\text{Max-ord}(X)$ , the locus of points in  $X \times_{\text{Spec}(\mathbb{Z})} \text{Spec}(\mathbb{Q})$ , which are at least of order  $d$ , is empty. The latter is obtained by taking  $d - 1$  times the derivatives with respect

**Algorithm 2** InterestingPrimes

---

**Input:**  $I_Z = \langle g_1, \dots, g_t \rangle \subset \mathbb{Z}[\underline{x}]$  such that  $Z := V(I_Z)$  is equidimensional and regular,  
 $I_X = \langle g_1, \dots, g_t, f_1, \dots, f_r \rangle \subsetneq \mathbb{Z}[\underline{x}]$

**Output:**  $\mathfrak{P} = \{p_1, \dots, p_\rho\}$  interesting primes for  $I_X \supset I_Z$

- 1: resultlist =  $\emptyset$
- 2:  $I_{temp} = \langle f_1, \dots, f_r \rangle$ ,  $I_{int} = \langle 0 \rangle$
- 3: **if**  $I_Z \cap \mathbb{Z} \neq \langle 0 \rangle$  **then**
- 4: resultlist = **primefactors**(generator of principal ideal  $I_Z \cap \mathbb{Z}$ ) (as set)
- 5: **return** resultlist
- 6: **if**  $I_Z == \langle 0 \rangle$  **then**
- 7: **while**  $I_{int} == \langle 0 \rangle$  **do**
- 8:  $I_{temp} = I_{temp} + \langle \frac{\partial F_i}{\partial x_j} \mid 1 \leq j \leq n \text{ and } 1 \leq i \leq q \rangle$ , where  $F_1, \dots, F_q$  are the generators of  $I_{temp}$  from the last pass through the loop
- 9:  $I_{int} = I_{temp} \cap \mathbb{Z}$
- 10: resultlist = **primefactors**(generator of principal ideal  $I_{int}$ ) (as set)
- 11: **return** resultlist
- 12: resultlist = resultlist  $\cup \{p_1, \dots, p_\alpha\}$ ,  
where  $\{p_1, \dots, p_\alpha\} = \mathbf{primefactors}$ (coefficients appearing in  $g_1, \dots, g_t$ )
- 13:  $L = \{\text{codim}(Z) \text{ square submatrices of Jacobian matrix of } (g_1, \dots, g_t) \text{ w.r.t. } (x_1, \dots, x_n)\}$
- 14: choose a subset  $L_1 \subset L$  such that  $X \cap D(p_1 \cdots p_\alpha) \subset \bigcup_{M \in L_1} D(\det(M)) \cap D(p_1 \cdots p_\alpha)$
- 15: **for**  $M \in L_1$  **do**
- 16: denote by  $(y_1, \dots, y_s)$  the system in  $D(\det(M)) \cap D(p_1 \cdots p_\alpha)$  induced by the subsystem of  $(\underline{x})$  of variables not corresponding to columns of  $M$
- 17:  $I_{int} = \langle 0 \rangle$ ,  $I_{temp} = \langle f_1, \dots, f_r \rangle$
- 18: **while**  $I_{int} == \langle 0 \rangle$  **do**
- 19:  $I_{temp} = I_{temp} + \langle \frac{\partial F_i}{\partial y_j} \mid 1 \leq j \leq s \text{ and } 1 \leq i \leq q \rangle$ , where  $F_1, \dots, F_q \in \mathbb{Z}[\underline{x}]$  are the generators of  $I_{temp}$  computed in the previous pass through the loop
- 20:  $I_{int} = (I_{temp} + I_Z) \cap \mathbb{Z}$
- 21: **if**  $I_{int} \neq \langle 1 \rangle$  **then**
- 22: resultlist = resultlist  $\cup \mathbf{primefactors}$ (generator of principal ideal  $I_{int}$ ) (as sets)
- 23: **return** resultlist

---

to the variables  $(\underline{x})$ . This implies, if we apply the same derivatives in  $\mathbb{Z}[\underline{x}]$  to generators of  $I_X$ , then the intersection with  $\mathbb{Z}$  of the resulting ideal is non-empty. Let  $m \in \mathbb{Z}$  be a generator of this principal ideal. By construction, all prime factors of  $m$  are contained in  $\mathfrak{P}$  (Algorithm 2, line 7–9). Since the maximal order is  $d$ , we may assume  $m > 1$ .

We claim that  $p$  divides  $m$ . Suppose this is not the case. In Construction 3.7, we discussed how to determine the components of the maximal order locus above  $p$ . In particular, we repeatedly apply derivatives with respect to  $(\underline{x})$ . If  $\gcd(p, m) = 1$ , then  $\Delta^{d-1}(J \cdot B_p) = \emptyset$  (using the notation of Construction 3.7). This is a contradiction to  $p$  being a bad prime for  $X$ , which ends the case  $I_Z = \langle 0 \rangle$ .

Let us come to  $I_Z = \langle g_1, \dots, g_t \rangle \neq \langle 0 \rangle$ . Let  $\mathfrak{P}_0 := \{p_1, \dots, p_\alpha\} \subseteq \mathfrak{P}$  be the set of prime numbers appearing in the coefficients of  $g_1, \dots, g_t$ . If  $p \in \mathfrak{P}_0$ , we are done. Hence, suppose that  $p \notin \mathfrak{P}_0$ . We pass to  $D(p_1 \cdots p_\alpha)$  and consider a covering of  $Z \cap D(p_1 \cdots p_\alpha)$  via the Jacobian matrix of  $(g)$  with respect to  $(\underline{x})$ . Equation (4.1) in Remark 4.2 provides that the derivatives with respect to the elements  $(y_1, \dots, y_s)$  do only involve derivatives by the variables  $(\underline{x})$ . Hence, these derivatives can also be considered over  $\mathbb{Q}$ , as in the case  $I_Z = \langle 0 \rangle$ . The analogous arguments as in the situation  $I_Z = \langle 0 \rangle$  apply, we only have to replace  $\frac{\partial}{\partial x_i}$  by  $\frac{\partial}{\partial y_j}$  in our reasoning. This ends the proof.  $\square$

The condition that there is no horizontal component is crucial:

**Example 4.7.** Consider  $I_X = \langle x^2 - 5^9 y^3 \rangle \subset \mathbb{Z}[x, y]$  and  $I_Z = \langle 0 \rangle$ . It is not hard to see that  $\text{Max-ord}(X) = V(x, y) \cup V(x, 5)$ . After the first pass through the loop starting at line 3, we get

$$I_{temp} = \langle x^2 - 5^9 y^3, 2x, 3 \cdot 5^9 y^2 \rangle \text{ and } I_{int} = \langle 0 \rangle.$$

We stay in the loop and obtain after a second run:

$$I_{temp} = \langle x^2 - 5^9 y^3, 2x, 2, 3 \cdot 5^9 y^2, 2 \cdot 3 \cdot 5^9 y \rangle = \langle x^2, 2, y^2 \rangle \text{ and } I_{int} = \langle 2 \rangle \neq \langle 0 \rangle.$$

Hence, 2 is the only interesting prime. In particular, we do not detect 5. This is not a contradiction since  $V(x, y)$  is a horizontal component.

We now pick up the toy example of before (Example 4.3(1)) to illustrate the algorithm to determine the interesting primes in the case  $I_Z \neq \langle 0 \rangle$ :

**Example 4.8.** Let  $I_Z = \langle g \rangle \subset \langle g, f \rangle = I_X \subset \mathbb{Z}[x, y, z]$  where  $f = 3x - y + 7z$  and  $g = x - 4y + 6z$ . First, 2, 3, 7 appear as prime factors in the coefficients of  $g$ , hence they are interesting primes. We can use the generator  $g$  of  $I_Z$  to eliminate the variable  $x$  as it has the coefficient 1, which also means that the corresponding 1-minor  $q$  of the Jacobian matrix has the value 1. (So, we do not have to pass to the locus, where  $2 \cdot 3 \cdot 7$  is invertible.) This implies that  $(y, z)$  is the desired subsystem inducing  $(y_1, y_2)$  of line 16 in Algorithm 2. Using  $q = 1$ , the derivatives of  $f$  are:

$$\frac{\partial f}{\partial y_1} = \frac{\partial f}{\partial y} - \frac{\partial g}{\partial y} \frac{\partial f}{\partial x} = -1 - (-4) \cdot 3 = 11 \quad \text{and} \quad \frac{\partial f}{\partial y_2} = \frac{\partial f}{\partial z} - \frac{\partial g}{\partial z} \frac{\partial f}{\partial x} = 7 - 6 \cdot 3 = -11.$$

Thus, the set of interesting primes is  $\mathfrak{P} = \{2, 3, 7, 11\}$ .

It is necessary that we collect the primes coming from a given set of generators of  $I_Z$ :

**Example 4.9.** Let  $p \in \mathbb{Z}$  be a prime number. Consider  $I_Z = \langle p - x^p \rangle \subset \mathbb{Z}[x, y, z]$  and  $I_X = I_Z + \langle z^2 + x^p y \rangle$ . The derivatives by  $(x, y, z)$  are not sufficient to cover  $V(I_X)$  as we are missing those points lying above  $p$ . On the other hand, it not hard to verify, that the locus of maximal order of  $X$  is  $V(p, x, z)$ .

To see, how the algorithm proceeds, let us consider a more complex example:

**Example 4.10.** Let  $I_Z := \langle 0 \rangle \subset I_X := \langle 3^2 x^2 - 5^2 y^2 \rangle \subset \mathbb{Z}[x, y]$ . Here it is easy to check that the maximal order 2 is attained precisely at  $V(5, x) \cup V(3, y) \cup V(x, y)$ , where the first two components are vertical and the last one is horizontal. After the first pass through the while loop starting at line 7, we have

$$I_{temp} = \langle 3^2 x^2 - 5^2 y^2, 2 \cdot 3^2 x, 2 \cdot 5^2 y \rangle \text{ and } I_{int} = \langle 0 \rangle.$$

After the second pass we obtain

$$I_{temp} = \langle 3^2 x^2 - 5^2 y^2, 2 \cdot 3^2 x, 2 \cdot 5^2 y, 2 \rangle = \langle x^2 + z^2, 2 \rangle \text{ and } I_{int} = \langle 2 \rangle \neq \langle 0 \rangle.$$

Thus, we leave the loop and return only the interesting prime 2 which is not bad. This is due to the presence of the horizontal component  $V(x, y)$ . (An algorithm to properly determine this component will be discussed in Algorithm 3).

After blowing up with center  $V(x, y)$ , we consider the  $X$ -chart, i.e., the chart with coordinates  $(x', y') = (x, \frac{y}{x})$ . Here, again  $I_Z = \langle 0 \rangle$ , but  $I_{\tilde{X}} = \langle 3^2 - 5^2 y'^2 \rangle$ . Running the algorithm as before, we obtain

$$I_{temp} = \langle 3^2 - 5^2 y'^2, 2 \cdot 5^2 y' \rangle,$$

which already contains an integer  $z = 2 \cdot 3^2$  after the first pass; i.e.,  $I_{int} = \langle 2 \cdot 3^2 \rangle \neq \langle 0 \rangle$  and the loop stops. Hence, we have collected the interesting primes 2 and 3, where of course 2 is still not bad, but 3 really leads to a vertical component. In the other chart, we then see the bad prime 5 in complete analogy to the discussed chart.

The above phenomenon is one of the reasons why we vary the original Cossart-Jannsen-Saito algorithm and give a preference to horizontal components (cf. Construction 2.16).

**Remark 4.11.** In principle we can use Hasse-Schmidt derivatives (cf. the idea of the computation in Remark 4.14 and the corresponding Algorithm 4 below) instead of the usual derivatives in the preceding algorithm. The ratio of primes contributing to  $\text{Max-ord}(X)$  among the interesting primes would then be higher, because we would not pick up as many primes originating directly from exponents. However, we would like to postpone the rather technical discussion of the computation of Hasse-Schmidt derivatives with respect to a system of parameters in the presence of a non-trivial  $Z$  as long as possible and first focus on the central task of determining the locus of maximal order.

Given a list of interesting primes and the ideals  $I_X$  and  $I_Z$ , we are now ready to determine  $\text{Max-ord}(X)$ , see [Algorithm 3: MaxOrdArith \(p.22\)](#). As this requires working locally at an interesting prime  $p$  and differentiating with respect to it, we need to introduce

**Construction 4.12.** Let  $p \in \mathbb{Z}_+$  be a prime number and  $c \in \mathbb{Z}$ . We have  $c = c'p^\ell$  with  $c' \in \mathbb{Z}$ ,  $\ell \in \mathbb{Z}_+$ , and  $\gcd(c', p) = 1$ . We introduce a new variable  $P$  and replace  $c$  by  $c'P^\ell$ .

Now, let  $I_Z \subset I_X \subset \mathbb{Z}[\underline{x}]$  be ideals. We choose a standard basis  $(g_1, \dots, g_t, f_1, \dots, f_r)$  for  $I_X$  such that  $(g_1, \dots, g_t)$  is a standard basis for  $I_Z$ . For every  $f_i, g_j \in \mathbb{Z}[\underline{x}]$ , we replace the non-zero coefficients as indicated before and denote by  $F_i \in \mathbb{Z}[\underline{x}, P]$  (resp.  $G_j$ ) the resulting element. We then set  $J_X := \langle G_1, \dots, G_t, F_1, \dots, F_r \rangle$  and  $J_Z := \langle G_1, \dots, G_t \rangle \subset \mathbb{Z}[\underline{x}, P]$ .

Note that it is not necessary to compute a full  $p$ -adic expansion, as locally in the stalk above  $p$  we see a unit  $c' = \frac{c}{p^\ell}$  due to the choice of  $\ell$ .

**Remark 4.13.** Note that in the output of Algorithm 3, the ideals  $I_i$  are not necessarily prime ideals. Hence, one might prefer to modify the algorithm slightly at the end in order to obtain that each  $I_i$  corresponds to an irreducible component. As this is not an essential part, we leave this to an explicit implementation.

In Algorithm 3, there is still one black box to be described further: `HasseDeriv`. In contrast to derivatives in the characteristic zero case, we cannot compute them iteratively. Instead, the Hasse-Schmidt derivatives of a given polynomial  $f(\underline{x})$  are extracted from  $f(\underline{x} + \underline{t})$  as the coefficients of the respective  $\underline{t}^\alpha$ , as was already mentioned above (see (3.1)). In view of the need to compute derivatives with respect to a regular system of parameters for a non-trivial  $Z$ , we are forced to reconsider the arguments of Remark 4.2:

**Remark 4.14.** In the setting analogous to Remark 4.2, we again consider a minor  $q = \det(M)$  of the Jacobian matrix of  $Z$  and restrict the considerations to  $D(q)$ , where  $q$  is invertible. As before, we can compute the usual derivatives w.r.t.  $(\underline{y})$ . To pass to Hasse-Schmidt derivatives, however, we have to recall the symbolic identity (3.2),

$$\frac{\partial}{\partial Y^a} Y^b = \frac{1}{a!} \left( \frac{\partial}{\partial Y} \right)^a Y^b.$$

This stresses that first order Hasse-Schmidt derivatives coincide with usual derivatives and it allows us to transform the higher usual derivatives into Hasse-Schmidt derivatives at each step of the computation by applying the appropriate correction factor.

In the algorithm to compute the list of Hasse-Schmidt derivatives, we thus carry along the information from which derivative a given polynomial originated and reuse this when passing to the next derivative. What we are not allowed to apply in this approach is a change of generators of intermediate ideals. Therefore, we need to carry along both the list of already computed derivatives and the corresponding saturated ideal.

In [Algorithm 4: HasseDeriv \(p.23\)](#), the previous considerations have been reformulated closer to an implementable algorithm.

Even if we start with a trivial ambient space, i.e.,  $I_Z = \langle 0 \rangle$ , it may become non-trivial after blowing up:

**Example 4.15.** Consider the hypersurface  $X \subset Z = \text{Spec}(\mathbb{Z}[x, y])$  given by

$$f = 3^2 5^2 + 5xy + x^3 y^3 \in \mathbb{Z}[x, y].$$

We assume that the boundary is empty. The maximal order achieved for  $f$  is 2 and

$$\text{Max-}\nu^{\mathcal{O}}(f) := \text{Max-}\nu^{\mathcal{O}}(X) = V(3, x, y) \cup V(5, x) \cup V(5, y),$$

where the first component is disjoint from the other two. All get label 0. One observes that  $\text{Max-}\nu(f)$  is not weakly permissible and its singular locus is  $V(5, x, y)$ . Therefore we blow up with center  $V(5, x, y)$ . Consider the  $Y$ -chart, where we set  $q := \frac{5}{y}$  and  $x' := \frac{x}{y}$  and  $y' = y$ .

It is important to keep in mind the transform of the ambient space, which is non-trivial in this chart:  $Z' = \text{Spec}(\mathbb{Z}[x', y', q]/\langle 5 - qq' \rangle)$ . The exceptional component is given by  $V(y')$ , hence the boundary is  $\mathcal{B}' = \{V(y')\}$ . The strict transform of  $f$  is

$$f' = 3^2 q^2 + qx'y' + x'^3 y'^4.$$

**Algorithm 3** MaxOrdArith

---

**Input:**  $I_Z \subset \mathbb{Z}[x_1, \dots, x_n] = \mathbb{Z}[\underline{x}]$  such that  $Z := V(I_Z)$  is equidimensional and regular,  
 $I_X \subsetneq \mathbb{Z}[\underline{x}]$  such that  $I_Z \subset I_X$ , i.e.,  $\emptyset \neq X := V(I_X) \subset Z$

**Output:**  $(m, L)$ , where  $m = \text{max-ord}(X)$  and  $L$  list, where  $L[i] = (p_i, I_i)$  such that:

- either  $p_i = 0$  for all  $i$  and  $\text{Max-ord}(X)_{hor} = \bigcup_i V(I_i)$ , if it is non-empty,
- or  $\text{Max-ord}(X) = \bigcup_i V(I_i)$  and  $I_i$  has been detected locally at  $p_i > 0$

- 1:  $\text{MaxOrd0} = \text{MaxOrd}(I_Z \otimes \mathbb{Q}, I_X \otimes \mathbb{Q})$
- 2:  $\text{maxord} = \text{MaxOrd0}[1]$ ,  $I_{\text{max}} = \text{MaxOrd0}[2] \cap \mathbb{Z}[\underline{x}]$
- 3:  $\text{RetList}[1] = (0, I_{\text{max}})$
- 4:  $\text{PrimeList} = \text{InterestingPrimes}(I_Z, I_X)$
- 5: **for**  $p \in \text{PrimeList}$  **do**
- 6:   apply Construction 4.12 for  $I_Z \subset I_X$  (replace each appearing coefficient  $c \in \mathbb{Z}$  by  $\frac{c}{p^\ell} P^\ell$ , for  $\ell$  maximal), denote by  $J_X$  and  $J_Z$  the resulting ideals in  $\mathbb{Z}[\underline{x}, P]$
- 7:   **if**  $I_Z == \langle 0 \rangle$  **then**
- 8:      $\text{DiffList} = \text{HasseDeriv}(\langle 0 \rangle, J_X, (\underline{x}, P), 0)$  //  $i$ -th entry = up to  $i$ -th derivatives of  $J_X$
- 9:      $m = \text{size}(\text{DiffList})$
- 10:    **for**  $i \in \{1, \dots, m\}$  **do**
- 11:      $\text{DiffList}[i] = \text{ideal}(\text{substitute}(\text{DiffList}[i], P, p))$
- 12:    **while**  $\text{DiffList}[m] == \langle 1 \rangle$  **do**
- 13:      $m = m - 1$
- 14:    **if**  $m \geq \text{maxord}$  **then**
- 15:      $I_{\text{max}} = \text{DiffList}[m]$
- 16:    **if**  $m > \text{maxord}$  **then**
- 17:      $\text{RetList} = \emptyset$ ,  $\text{maxord} = m$ ,  $\text{RetList}[1] = (p, I_{\text{max}})$
- 18:    **else if**  $\text{RetList}[1][1] \neq 0$  **then**
- 19:      $\text{RetList}[\text{size}(\text{RetList}) + 1] = (p, I_{\text{max}})$
- 20:    **else**
- 21:      $L = \{\text{codim}(Z) \text{ square submatrices of Jacobian matrix of } J_Z \subseteq \mathbb{Z}[\underline{x}, P]\}$
- 22:     choose a subset  $L_1 \subset L$  such that  $V(J_X) \subset \bigcup_{M \in L_1} D(\det(M))$
- 23:      $\text{locord} = 1$
- 24:     **for**  $M \in L_1$  **do**
- 25:      fix  $(y)$  a system of parameters on  $V(J_Z) \cap D(\det(M))$  as in line 12 Algorithm 1
- 26:       $\text{DiffList} = \text{HasseDeriv}(J_Z, J_X, y, M)$
- 27:       $m = \text{size}(\text{DiffList})$
- 28:      **for**  $i \in \{1, \dots, m\}$  **do**
- 29:        $\text{DiffList}[i] = \text{ideal}(\text{substitute}(\text{DiffList}[i], P, p))$
- 30:      **while**  $\text{DiffList}[m] == \langle 1 \rangle$  **do**
- 31:        $m = m - 1$
- 32:      **if**  $m > \text{locord}$  **then**
- 33:        $I_{\text{max}} = \text{DiffList}[m]$ ,  $\text{locord} = m$
- 34:      **else if**  $m == \text{locord}$  **then**
- 35:        $I_{\text{max}} = I_{\text{max}} \cap \text{DiffList}[m]$
- 36:      **if**  $\text{locord} \geq \text{maxord}$  **then**
- 37:       **if**  $\text{locord} > \text{maxord}$  **then**
- 38:           $\text{RetList} = \emptyset$ ,  $\text{maxord} = \text{locord}$ ,  $\text{RetList}[1] = (p, I_{\text{max}})$
- 39:       **else if**  $\text{RetList}[1][1] \neq 0$  **then**
- 40:           $\text{RetList}[\text{size}(\text{RetList}) + 1] = (p, I_{\text{max}})$
- 41:    **return**  $(\text{maxord}, \text{RetList})$

---

Note that  $\text{Max-}\nu^O(f')$  consists of the strict transform of  $\text{Max-}\nu^O(f)$  in  $Z'$  and components contained in the exceptional divisor. Hence we obtain

$$\text{Max-}\nu^O(f') = V(q, x') \cup V(q, y').$$

The first component is the strict transform of  $V(5, x)$  and has label 0. The second is contained in the exceptional component and thus gets the new label 1.

**Algorithm 4** HasseDeriv

---

**Input:**  $I_Z = \langle g_1, \dots, g_t \rangle \subset \mathbb{Z}[\underline{x}]$  such that  $Z := V(I_Z)$  is equidimensional and regular,  
 $I_X = I_Z + \langle f_1, \dots, f_r \rangle \subsetneq \mathbb{Z}[\underline{x}]$ , i.e.,  $\emptyset \neq X := V(I_X) \subset Z$ ,  
 $(\underline{y})$  system of parameters on  $Z \cap D(\det(M))$ ,  
 $M$   $\text{codim}(Z)$  square submatrix of Jacobian matrix of  $I_Z$

**Output:** list *RetList* such that  $\text{RetList}[i] = I_Z + \langle \mathcal{D}_a f \mid f \in I_X, |a| \leq i \rangle$

- 1: **if**  $I_Z == \langle 0 \rangle$  **then**
- 2:   **for**  $j \in \{1, \dots, r\}$  **do**
- 3:      $F_j(\underline{y}, \underline{t}) = f_j(x_1 + t_1, \dots, x_n + t_n)$
- 4:      $i = 1$ ,  $\text{tempid} = f_1, \dots, f_r$
- 5:     **while**  $((i == 1) \text{ OR } (\text{tempid} != \text{RetList}[i-1]))$  **do**
- 6:        $\text{RetList}[i] = \text{tempid}$
- 7:       **for**  $\mathbf{a} \in \{\mathbf{b} \in \mathbb{Z}_{\geq 0}^n \mid |\mathbf{b}| == i\}$  **do**
- 8:          $\text{tempid} = \text{tempid}, \{ \text{coefficients of } t^{\mathbf{a}} \text{ in } F_1, \dots, F_r \}$
- 9:        $i = i + 1$
- 10:    **return** *RetList*
- 11:  $I_{\text{temp}} = I_X$ ,  $\text{Null} = (0, \dots, 0)$  (*Null* has  $\#(\underline{y})$  entries)
- 12: **for**  $1 \leq i \leq r$  **do**
- 13:     $L[i] = (f_i, \text{Null})$
- 14:  $\text{old} = 0$ ,  $\text{cur} = r$
- 15: **while**  $I_{\text{temp}} \cap \mathbb{Z} == \langle 0 \rangle$  **do**
- 16:    **for**  $\text{old} < i \leq \text{cur}$  **do**
- 17:     **for**  $y_j \in (\underline{y})$  **do**
- 18:        $(f_{\text{temp}}, \text{note}) = L[i]$
- 19:        $\text{note}[j] = \text{note}[j] + 1$
- 20:        $f_{\text{temp}} = \frac{1}{\text{note}[j]} \cdot \frac{\partial f_{\text{temp}}}{\partial y_j}$   
       (precise formulation of  $\frac{\partial f_{\text{temp}}}{\partial y_j}$  in Remark 4.2 – these are usual derivatives)
- 21:        $L[\text{size}(L)+1] = (f_{\text{temp}}, \text{note})$
- 22:        $I_{\text{temp}} = I_{\text{temp}} + \langle f_{\text{temp}} \rangle$
- 23:        $I_{\text{temp}} = \text{sat}(I_{\text{temp}}, \det(M))$
- 24:        $\text{RetList}[\text{size}(\text{RetList})+1] = I_{\text{temp}}$
- 25:        $\text{old} = \text{cur}$ ,  $\text{cur} = \text{size}(L)$
- 26: **return** *RetList*

---

Note: In the computations, the component  $V(3, x', y')$  of the maximal order locus has been handled, but we do not see it in this chart as its intersection with the non-trivial ambient space is empty here:  $\langle 3, x', y', 5 - qy' \rangle = \langle 1 \rangle$  as  $\text{gcd}(3, 5) = 1$ .

Since  $V(q, x')$  is weakly permissible the algorithm chooses this component as the center for the next blowing up. We leave the other charts and the remaining resolution process to the reader.

Let us point out again that our variant is different from the original CJS-resolution. Since we are using  $\nu_{\text{ref}}$  instead of the Hilbert-Samuel function, we cannot control the maximal value of the Hilbert-Samuel function along our variant of the resolution process:

**Example 4.16.** Let  $X \subset Z = \mathbb{A}_{\mathbb{Z}}^3$  be the scheme defined by the ideal

$$J = \langle x^2 - y^{17}, p^5 - y^2 z^6 \rangle \subset \mathbb{Z}[x, y, z],$$

where  $p \in \mathbb{Z}$  is a prime number. We assume that the boundary is empty  $\mathcal{B} = \emptyset$ . We have  $\text{max-}\nu(X) = (4, 2)$  and

$$\text{Max-}\nu^O(X) = \text{Max-}\nu(X) = V(p, x, y).$$

In contrast to this, the maximal Hilbert-Samuel locus is  $V(p, x, y, z)$ .

The algorithm proposes as first center  $V(p, x, y)$ . After blowing up, we consider the  $Y$ -chart, where we use the notation  $p' := \frac{p}{y}$ ,  $x' := \frac{x}{y}$ ,  $y' = y$ , and  $z' := z$ . The strict transform

of the ambient space is  $Z' = \text{Spec}(\mathbb{Z}[p', x', y', z']/\langle p - p'y' \rangle)$  and  $X'$  is given by the ideal

$$J' = \langle x'^2 - y'^{15}, p'^5 y'^3 - z'^6 \rangle.$$

Hence,  $\max\text{-}\nu(X') = \max\text{-}\nu(X) = (4, 2)$ . Note that the maximal order of the second polynomial increased from 5 to 6 after the blowing up. This implies that the maximal value achieved by the Hilbert-Samuel function increased<sup>6</sup>, which is not surprising since we have blown up a center that is not contained in the maximal Hilbert-Samuel locus.

We have  $\text{Max-}\nu^O(J') = V(x', y', z')$  which is a weakly permissible and hence the next center. We leave the other charts and the remaining resolution process to the reader.

To end this section, let us outline for the toy example, why it is crucial to use a standard basis in Construction 4.12.

**Example 4.17.** Let  $I_Z = \langle g \rangle \subset \langle g, f \rangle = I_X \subset \mathbb{Z}[x, y, z]$  where  $f = 3x - y + 7z$  and  $g = x - 4y + 6z$ . In Example 4.8, we have seen that  $p = 11$  is the only interesting prime. If we replace each coefficient  $c$  in  $f$  and  $g$  by  $c'P^\ell$  for  $c' \in \mathbb{Z}$  prime to 11, we obtain the same elements. With the same argument as in Example 4.8,  $(y, z, P)$  induces a regular system of parameters  $(y_1, y_2, y_3)$  at every point of  $V(I_X)$  and we have  $\frac{\partial f}{\partial y_1} = P$  and  $\frac{\partial f}{\partial y_2} = -P$ . Further, since  $P$  does not appear,  $\frac{\partial f}{\partial y_3} = 0$ . This suggests that the locus of maximal order is given by the ideal  $\langle g, f, 11 \rangle = \langle g, 11 \rangle$ , where the last equality holds since  $f = 3g + 11(y - z)$ . This cannot be true.

On the other hand, we may replace  $f$  by  $h := 11(y - z)$  and  $(g, h)$  is a standard basis for  $I_X$ . Applying Construction 4.12 yields the element  $H = P(y - z)$ . Computing the derivatives leads to the correct maximal order locus  $V(g, 11, y - z)$ . The details are left as an exercise to the reader.

## 5. EXPLOITING THE NATURALLY PARALLEL STRUCTURE

In this section, we discuss the parallelization of the algorithm for finding the center of the chosen resolution strategy. The ubiquitous use of coverings by charts already suggests a high potential for parallelization; instead of starting with an arbitrarily chosen covering by a subset of the minors of the Jacobian matrix of  $I_Z$ , we can also start with all possible choices, run them in parallel and terminate as soon as all of  $X$  has been covered. As we aim to use GPI-Space [28] as the workflow-management system for managing and scheduling our parallel approach, we rephrase our algorithms in the language of Petri nets, which is slightly unusual for algebraic geometry, but has already proved useful in [9].

**5.1. Petri nets and parallel implementation.** Petri nets are models of distributed systems. In its basic form, a Petri net is a bipartite, directed, finite graph. Its vertices are *places*, which are denoted by circles in graphical representation, and *transitions*, which are denoted by rectangles. The edges of the graph are called *arcs*. The places from which there is an arc to a certain transition are called the *input places* of that transition. Similarly, the places which can be reached with an arc from a certain transition are the *output places* of that transition. There can also be *tokens* on the places, depicted by small solid circles. A token can be thought of carrying a piece of information (formally: it is of a certain *color*) that is being processed by the Petri net. A configuration of tokens is called a *marking* of the net. *Colored Petri nets* are in fact an extension to the original concept where the tokens on one place are indistinguishable. There are actually numerous extensions of Petri nets; some of them provide important features for describing computations which cannot be phrased with the language of basic Petri nets. We describe the properties of the Petri nets which are used in GPI-Space. The latter is a parallel environment that handles the workflow management of our implementation.

A transition of a Petri net is called *enabled* if there is at least one token at each of its input places. It can *switch* (or *fire*). When it switches, the transition consumes one token from every input place and places new tokens on every output place. Note that the Petri net itself makes no statement when an enabled transition will switch (if it does at all)

<sup>6</sup>The precise value is  $(1, 4, 9, 16, 25, 36, 48, \dots)$ , whereas it was  $(1, 4, 9, 16, 25, 35, 45, \dots)$  before blowing up.



and which tokens it will consume if there are several to choose from. In this sense, Petri nets are executed in a non-deterministic way (the actual choices are up to the underlying implementation).

Let us now consider an extremely simplified example to get used to the terminology of Petri nets:

**Example 5.1.** Consider a composition of functions  $X \xrightarrow{f} Y \xrightarrow{g} Z$  between some sets  $X, Y, Z$ . This translates into the following Petri net (only showing places and transitions):

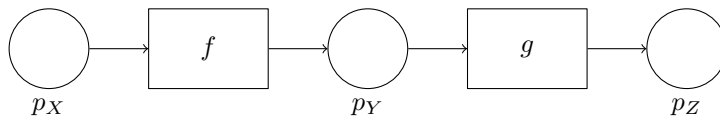

So far, we are hiding the tokens. If there is a token in  $p_X$ , it can be consumed by the transition  $f$  which then provides at least one token in  $p_Y$ , see below for further explanations. A snapshot of the Petri net might look as follows:

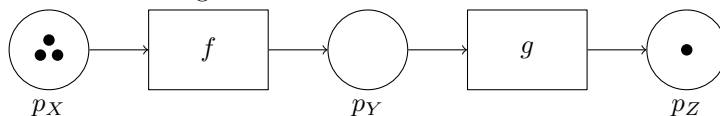

That means currently, there are three tokens in  $p_X$  waiting to be consumed by  $f$  and one in  $p_Z$ . Transition  $g$  cannot fire, as there are no token in its input place  $p_Y$ , whereas transition  $f$  is enabled as a consequence of the tokens in  $p_X$ . Upon firing, transition  $f$  consumes one token from place  $p_X$ , representing an element  $x \in X$ , and produces one token on place  $p_Y$ , representing a token  $f(x) \in Y$ .

Example 5.1 also shows further properties of Petri nets: One important point is that all dependencies are local, at least in theory. Every transition only needs to know about its input and output places, for both the data (color of tokens) and control dependency (presence of tokens). There is no need for any kind of global synchronization or global clock signal. This also means that in a real setting (i.e., in GPI-Space through which the computer executes the Petri net), there is usually no global state during execution that can be described with a marking. In the model, each switching is an atomic, instantaneous process, i.e., it is a step that cannot be further divided into smaller parts and it is processed immediately without time consumption. In a real system, the execution of a transition will take a finite amount of time and there will be several transitions executing at a given point in time, in general. However, it is always possible to give an equivalent *switching sequence* without overlaps.

This leads to the second important point: Petri nets automatically come with parallelism. There is both data parallelism, that is, there can be several instances of one transition running at the same time (on different CPU cores or even on different machines), but also task parallelism, that is, instances of different transitions can be running simultaneously.

Keeping this background in mind, we can now state a Petri net corresponding to a simplified version of the embedded resolution process:

**Example 5.2.** Roughly speaking a resolution of singularities via blowing ups in regular centers has the following structure: Given  $X \subset Z$  as in the previous sections, first determine the center  $C$  of the first blowing up. Then, if  $X$  is not already resolved (i.e., if  $C \subsetneq X$ ), we blow up at the center  $C$ . This process is then repeated for the transform of  $X \subset Z$  under the blowing up. Eventually, we reach the point that all singularities are resolved – at least in those cases, where desingularization by a finite number of blowing ups is not an open problem.

As we mentioned before, the resolution data is collected in local affine charts. In other words, given the initial data  $X \subset Z$ , we first have to split it into affine charts, each of which corresponds to a token (in place a below). Furthermore, after blowing up (i.e., at place c below), we also have to split the data into finitely many affine charts (i.e., we produce several tokens from one). Those of the affine charts (i.e., tokens) that are resolved are detected at place b and glued with the already handled resolved charts. The resulting token holding the glued object is put into place d, ready for gluing the next chart to it. If the token on

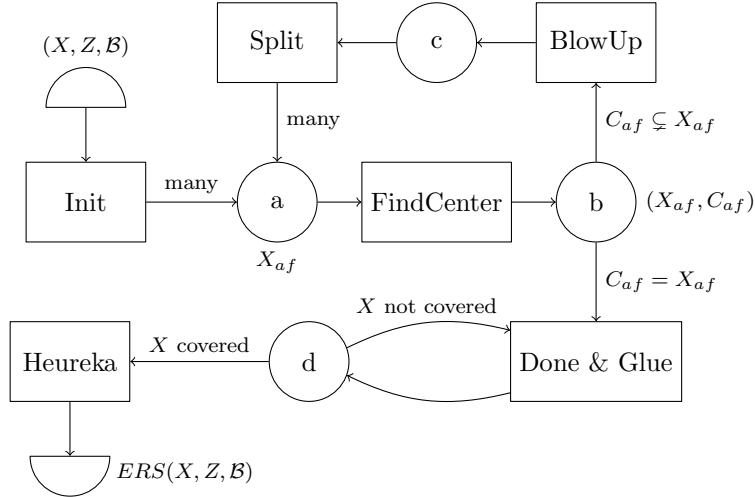

FIGURE 1. Simplified Petri net for an embedded resolution of singularities.

place  $d$  already describes the entire resolution of  $X$ , the transition **Heureka** fires and initiates the clean-up and termination of the Petri net. The output is an Embedded Resolution of Singularities  $ERS(X, Z, \mathcal{B})$ , where  $\mathcal{B}$  is some boundary on  $Z$ .

These explanations provide the simplified Petri net of Figure 1, where we use the obvious notation. We mark the beginning (resp. end) by an upper (resp. lower) half-disc.

Note that we have omitted several details in the above Petri net, e.g. the use of place  $d$  can only work properly, if a token representing the empty set is placed there at the beginning. To discuss all technicalities of the use of Petri nets, such as the use of conditions and parameter dependent behavior, is far beyond the scope of the current article. For an introduction to parallelization using Petri nets for algebraic geometries we refer to section 3 and 4 of [9]. We only state simplified Petri nets in the following sense: only the essential steps in the respective algorithm are presented, some of the transitions may themselves represent Petri nets, like **FindCenter** above, whereas others, like **BlowUp**, represent code which is executed in the back-end SINGULAR [25] and seen as atomic from the perspective of GPI-Space. Moreover, we take the liberty to add annotations for the data (i.e., coloring of tokens) at those places, where it contributes to a better understanding, and for the arcs, where the transition is subject to a condition or where more than one output token is created.

**5.2. Petri nets within the desingularization process.** In Example 5.2, we have already seen the inherent parallelity through the use of charts, but we have not yet discussed the very heart of the algorithm: the choice of center. The Petri net in Figure 2 describes the algorithm **FindCenter**, which is itself of sequential nature and directly corresponds to the steps outlined in section 4 as can easily be observed from its Petri net. The input- and output-tokens of this net are precisely of the structure of the respective tokens at the input and output place for **FindCenter** in the Petri net in Example 5.2.

Let us point out that, in the Petri net,  $Y$  denotes the locus of those irreducible components in  $\text{Max-}\nu^O(X)$  that are of lowest label.

The transitions **IntersecExc** and **Labeling** are implemented in the back-end SINGULAR and hence seen as atomic in this context. The purpose of **CenterY** is the choice of a center to resolve  $Y$ , which is of dimension at most  $\dim(X) - 1$ . In a general setting, this is a recursive call to the resolution. But in the special case of  $\dim(X) = 2$ , this only handles at most a finite number of singular points of  $Y$  and we consider it as simple call to SINGULAR. Note that we will get  $C = Y$  at some step of the algorithm, i.e., that the entire locus  $Y$  is the next center.

This leaves two important building blocks to discuss: **InterestPrimes** and **MaxRefOrd**, both of which exhibit a naturally parallel structure. In Figure 3, we first discuss the Petri net of **InterestPrimes** which corresponds to the algorithm **InterestingPrimes** of the previous section.

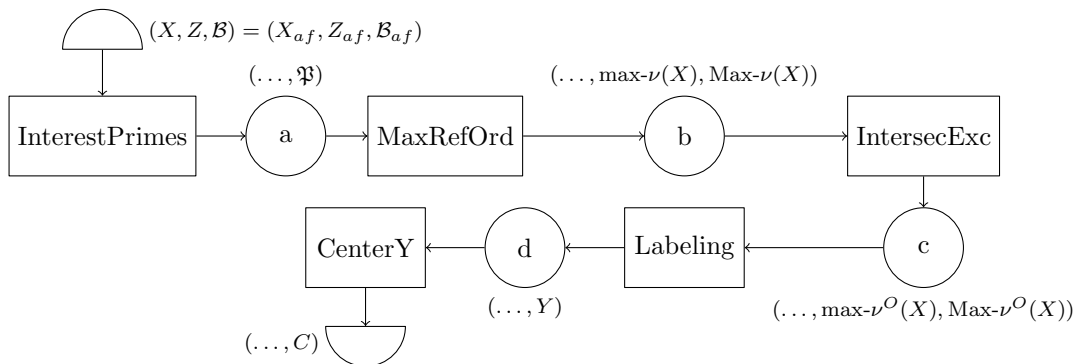
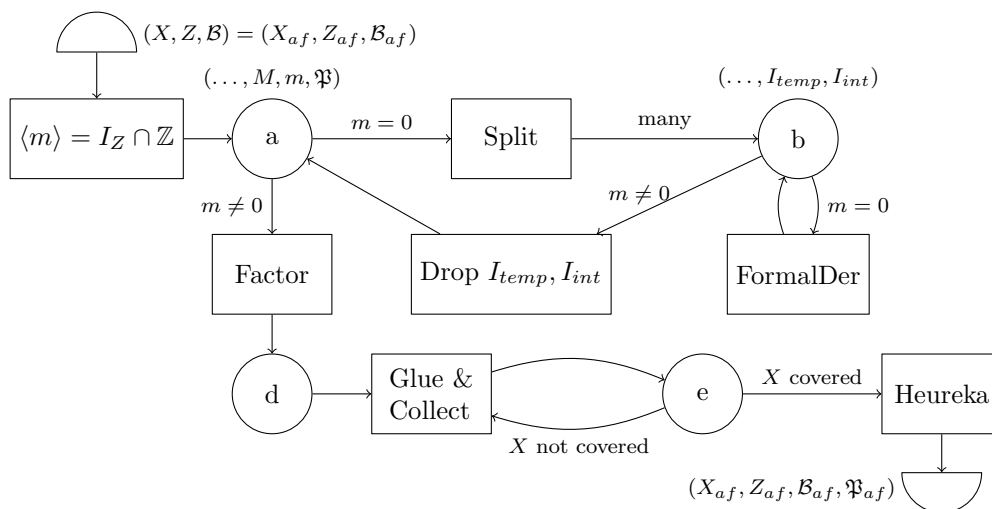
FIGURE 2. Petri net for `FindCenter`.FIGURE 3. Petri net for `InterestingPrimes`.

Note that for consistency of coloring at place `a`, the matrix  $M$  is initialized to the zero matrix in the very first transition of the net. Further, we add the empty list  $\mathfrak{P}$ , in which we will collect the interesting primes. In `Split`, we fix generators for  $I_Z$  and add the prime factors of the appearing coefficients to the list  $\mathfrak{P}$ . Following this, `Split` creates the covering by affine charts arising from the minors of the Jacobian matrix of  $I_Z$ , contains a call to `SINGULAR` and fills in a correct value for the matrix  $M$  for each of the generated tokens. The iteration of purely formally forming the derivatives is represented by `FormalDer`, which relies on functionality of the back-end `SINGULAR` again. Having found an integer  $m \neq 0$ , we need to find the prime factors, combine the knowledge from all charts and return the result.

The next transition in the Petri net of `FindCenter` is the computation of the locus of maximal refined order `MaxRefOrd`, which is represented by the Petri net in Figure 4. In reality, the output place of `InterestPrimes` and the input place of `MaxRefOrd` are identical; for presentation as separate Petri nets, we therefore start `MaxRefOrd` by a transition which actually only places its input token into its output place.

As the first entry of the desingularization invariant represents the number of descents upon finding maximal order one, the main part of this Petri net is the loop which computes the maximal order locus and then passes to the descent in ambient dimension, if the maximal order was 1. If the maximal order exceeded 1, the transition `Glue&Collect` fires instead, compares the maximal order to the current maximal value, identifies the current maximal order and places the locus of this order (as computed up to this point) into the place `c`. Note that the zero ideal has order  $\infty$ , which also triggers `Glue&Collect`, but the transition itself handles this special case appropriately, as it first compares the first entry of the invariant.

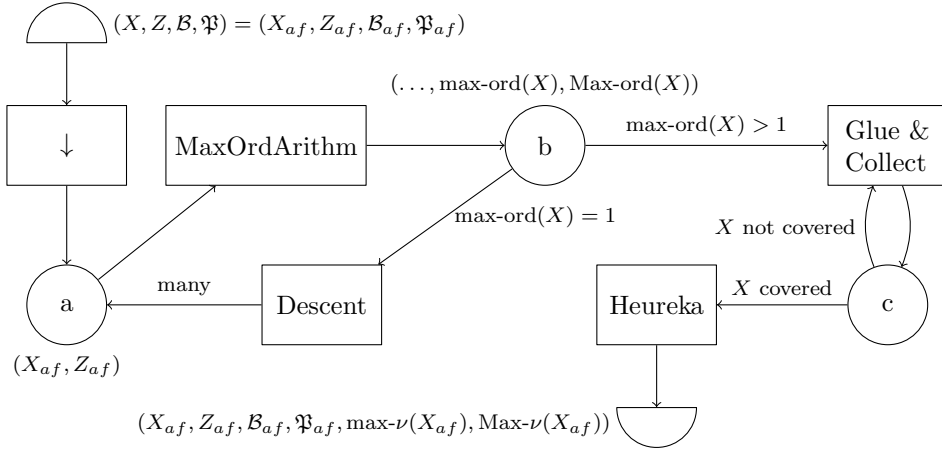

FIGURE 4. Petri net for MaxRefOrd.

In this Petri net, we are still hiding another key step, the calculation of the locus of maximal order in the arithmetic case, i.e., `MaxOrdArith`. This is the last of the Petri nets we are presenting here in Figure 5 and starts by calling `MaxOrd0`, already available functionality to compute the locus of maximal order in characteristic zero.

In the absence of interesting primes, this already terminates the algorithm. Otherwise, the stalk at each interesting prime needs to be considered separately giving rise to at least  $\#\mathfrak{P}$  tokens at place **b** for each of which the prime  $p$  has already been replaced by a symbol  $P$ . Note that at each of the stalks a covering by minors of the Jacobian matrix may become necessary. The computation of Hasse-Schmidt derivatives in `HasseDer` is a task for the back-end `SINGULAR`, as are the computations after resubstitution of  $P$  by  $p$ .

In the transition `Glue&Collect`, the computed maximal order of the token from place **d** is compared to the maximal order assigned to the token from place **e** (technically, we again need to make sure that place **e** holds an initialization token corresponding to the empty set at the beginning, but this is not shown here). According to the result of the comparison, the one of lower value is dropped or the union of the computed loci is formed in case of equality. This comprises a gluing step for charts by maximal minors and the collecting of the stalks at primes. At the same time, the prime  $p$  is discarded from  $\mathfrak{P}$  allowing us to leave the loop as soon as  $\mathfrak{P}$  is empty. The transition `Drop` then just drops unnecessary parts of the coloring to reach conformity with the coloring of tokens at place **a**.

## 6. OUTLOOK

**6.1. Normalization in the arithmetic case.** Up to this point, all considerations in the article have followed the general structure of Hironaka style desingularization, i.e., using suitably chosen smooth centers for resolving by blowing up. There is another classical approach to resolution of singularities for surfaces (even in mixed characteristic): Lipman introduced a desingularization process in [49], which alternately applies the normalization of the surface followed by blow ups of closed points.

Over a field, normalization can be achieved algorithmically following the ideas of Grauert (see [45]), for which state-of-the-art algorithms and implementations are available (see for instance [38], [10]). Crucial to all of this is the use of the ideal of the singular locus as an approximation of the non-normal locus. In the arithmetic case, the same theoretical ideas still hold, but on the practical side the approximation of the non-normal locus causes a problem: if it is done by means of the vanishing of the minors of the Jacobian matrix, it is by far too coarse, as it does not only detect the singular points, but also fiber singularities. Recall the first lines of Example 3.2 for an illustration of the difference between singular point and singularity of the fiber. The approximation of the non-normal locus hence needs to be done using the non-regular locus.

Recalling the considerations in Observation 2.3 and the subsequent definition of  $\nu_{\text{ref}}$ , we know that a scheme  $X$  is non-regular at a point  $x$ , if and only if  $d_x$ , the second entry of  $\nu_{\text{ref}}$ ,

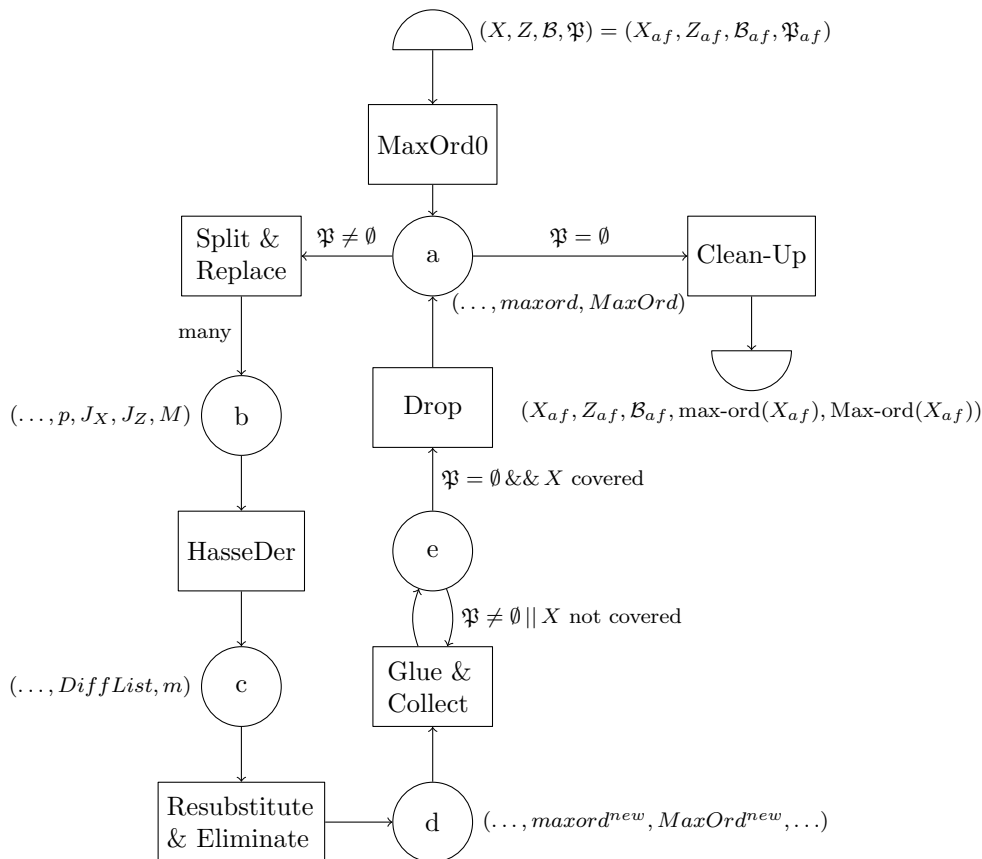

FIGURE 5. Petri net for MaxOrdArith.

exceeds 1. However, this is not as directly computable as it seems. We need to determine the non-regular locus as

$$\Sigma := \bigcup_{i=1}^N \mathcal{V}_{(N-i, \geq 2)}(X),$$

where  $\mathcal{V}_{(N-i, \geq 2)}(X)$  describes the locus on  $X$  where the invariant has first value  $N - i$  and second value at least 2. For  $i = N$ , the locus  $\mathcal{V}_{(0, \geq 2)}(X)$  is precisely the locus of order at least 2 on  $X$ , which is computable as the vanishing locus of the second entry of the output list of the Algorithm 4 by Remark 3.8(3). Suitably covering the complement of this locus by principal open sets and moving one generator of order 1 of  $I_X$  into  $I_Z$  on each open set, as is discussed in more detail in the characteristic zero case in [9], we can then compute the locus  $\mathcal{V}_{(1, \geq 2)}(X)$  on each of the open sets and so on. This provides a parallel algorithm to determine the non-regular locus.

**6.2. Schemes of higher dimension.** As it is already mentioned in [16] Remark 6.29, the formulation of the algorithm (see Construction 2.16) allows an *arbitrary* dimensional scheme  $X$  instead of a two-dimensional one. But termination of the algorithm is not known in higher dimensions (even in the situation over a field of characteristic zero), neither for the original version nor for our variant.

While the newly created components in the locus of maximal singularity (i.e., those with label 1 or larger) are well-behaved in dimension two, there is less control in higher dimensions, see [21] Example 2.5. Furthermore, one has to be more careful when dealing with the labels of irreducible components, see [21] Example 2.6. Since the mentioned examples are hypersurfaces they apply for both variants of the algorithm.

In the papers studying the algorithm ([43], [15], [16], [21]) Hironaka's characteristic polyhedron [42] plays a crucial role as a measure for the improvement of the singularity during the

resolution process. Another difficulty in higher dimension is to obtain a similar control on the characteristic polyhedron or to give an alternative invariant measuring the improvement.

Therefore an implementation of the algorithm could be extremely useful for investigations in this direction. In particular, it will be easier to test numerous examples on termination of the algorithm, to search for patterns in order to develop new invariants, and to explore the behavior of potential invariants.

Finally, one may think that choosing always the oldest irreducible components seems quite arbitrary. In fact, as the following example shows, we cannot modify the algorithm by considering always the newest irreducible component.

**Example 6.1.** Let  $k$  be a field of characteristic zero and  $\mathcal{B} = \emptyset$ . Let  $X = V(f) \subset \mathbb{A}_k^5$  be the affine variety given by the polynomial

$$f = t^5 + x^4 y^2 z^4 + w^{10} z^6.$$

We have  $\max\text{-}\nu(X) = (5, 5)$  and  $\text{Max-}\nu^O(X) = V(t, x, z) \cup V(t, y, z) \cup V(t, x, y, w)$ . All components get label 0 and the algorithm blows up with center the origin  $D_0 := V(t, x, y, z, w)$ .

In the affine chart with coordinates  $(t', x', y', z', w') = (\frac{t}{z}, \frac{x}{z}, \frac{y}{z}, z, \frac{w}{z})$  the strict transform  $X'$  of  $X$  is given by (for simplicity, we abuse notation and call the coordinates again  $(t, x, y, z, w)$ )

$$f' = t^5 + x^4 y^2 z^5 + w^{10} z^{11}.$$

We have  $\max\text{-}\nu(X') = (5, 5)$  and  $\text{Max-}\nu^O(X') = V(t, z) \cup V(t, x, y, w)$ . Since  $V(t, z)$  is contained in the exceptional divisor and the center is not an entire irreducible component of  $\text{Max-}\nu^O(X)$ , the component  $V(t, z)$  gets the label 1.

Suppose we modify Construction 2.16 such that we always consider the irreducible components with highest label. Then the center of the next blowing up is  $D_1 := V(t, z)$ .

In the affine chart with coordinates  $(t', x', y', z', w') = (\frac{t}{z}, x, y, z, w)$ , we obtain that the strict transform  $X''$  is given by

$$f'' = t^5 + x^4 y^2 + w^{10} z^6.$$

Further,  $\max\text{-}\nu(X'') = (5, 5)$ , and  $\text{Max-}\nu^O(X'') = V(t, x, y, z) \cup V(t, x, y, w)$ , where  $V(t, x, y, z)$  has label 2 and  $V(t, x, y, w)$  has label 0. The modified algorithm chooses  $D_2 := V(t, x, y, z)$  as the next center.

In the affine chart with coordinates  $(t', x', y', z', w') = (\frac{t}{z}, \frac{x}{z}, \frac{y}{z}, z, w)$  the strict transform  $X^{(3)}$  is given by

$$f^{(3)} = t^5 + x^4 y^2 z + w^{10} z.$$

Again,  $\max\text{-}\nu(X^{(3)}) = (5, 5)$ , and we have  $\text{Max-}\nu^O(X^{(3)}) = V(t, x, z, w) \cup V(t, x, y, w)$ , where the component  $V(t, x, z, w)$  gets label 3 and  $V(t, x, y, w)$  has label 0. Hence  $D_3 := V(t, x, z, w)$  is the center of the next blowing up.

In the affine chart with coordinates  $(t', x', y', z', w') = (\frac{t}{z}, \frac{x}{z}, y, z, \frac{w}{z})$  the strict transform  $X^{(4)}$  is given by

$$f^{(4)} = t^5 + x^4 y^2 + w^{10} z^6.$$

But  $f^{(4)} = f''$ . Thus we have created a loop and the modified algorithm never ends.

## REFERENCES

- [1] S. Abhyankar, *Resolution of Singularities of Embedded Surfaces* (Academic Press, New York, 1966).
- [2] A. Benito and O. Villamayor, ‘Techniques for the study of singularities with applications to resolution of 2-dimensional schemes’, *Math. Ann.* 353 (2012) 1037–1068.
- [3] E. Bierstone and P. Milman, ‘Uniformization of analytic spaces’, *J. Amer. Math. Soc.* 2 (1989) 801–836.
- [4] E. Bierstone and P. Milman, ‘Canonical desingularization in characteristic zero by blowing up the maximum strata of a local invariant’, *Invent. Math.* 128 (1997) 207–302.
- [5] E. Bierstone and P. Milman, ‘Desingularization of toric and binomial varieties’, *J. Algebraic Geom.* 15 (2006) 443–486.
- [6] R. Blanco, ‘Desingularization of binomial varieties in arbitrary characteristic. Part I. A new resolution function and their properties’, *Math. Nachr.* 285 (2012) 1316–1342.
- [7] R. Blanco, ‘Desingularization of binomial varieties in arbitrary characteristic. Part II: Combinatorial desingularization algorithm’, *Q. J. Math.* 63 (2012) 771–794.
- [8] G. Bodnár and J. Schicho, ‘A computer program for the resolution of singularities’, In: H. Hauser, J. Lipman, F. Oort, A. Quirós (Eds.), *Resolution of Singularities. A Research Book in Tribute of Oscar Zariski*. Progr. Math., vol. 181, p. 231–238. Birkhäuser, Basel, 2000.

- [9] J. Böhm, W. Decker, A. Frühbis-Krüger, F.-J. Pfreundt, M. Rahn and L. Ristau, ‘Towards massively parallel computations in algebraic geometry’, *Found. Comput. Math.* (2020). <https://doi.org/10.1007/s10208-020-09464-x>
- [10] J. Böhm, W. Decker, S. Laplagne, G. Pfister, A. Steenpaß and S. Steidel, ‘Parallel Algorithms for Normalization’, *Journal of Symbolic Computation* 51 (2013) 99–114.
- [11] J. Böhm and A. Frühbis-Krüger, ‘A smoothness test for higher codimension’, *J. Symbol. Comp.* 86 (2018) 153–165.
- [12] A. Bravo, S. Encinas and O. Villamayor, ‘A simplified proof of desingularization and applications’, *Rev. Mat. Iberoamericana* 21 (2005) 349–458.
- [13] A. Bravo and O. Villamayor, ‘On the Behavior of the Multiplicity on Schemes: Stratification and Blow Ups’, in *The Resolution of Singular Algebraic Varieties*, 81–209, *Clay Math. Proc.* 20, Amer. Math. Soc. (2014).
- [14] V. Cossart, J. Giraud and U. Orbanz, *Resolution of surface singularities*, with an appendix by H. Hironaka, *Lecture Notes in Mathematics* 1101 (Springer Verlag, 1984).
- [15] V. Cossart, ‘Desingularization of embedded excellent surfaces’, *Tohoku Math. J. II. Ser.* 33 (1981) 25–33.
- [16] V. Cossart, U. Jannsen and S. Saito, *Desingularization: Invariants and Strategy. Applications to Dimension 2*, with an appendix by B. Schober. *Lecture Notes in Math.* 2270, Springer, Cham, 2020.
- [17] V. Cossart and O. Piltant, ‘Resolution of singularities of threefolds in positive characteristic I’, *Journal of Algebra* 320 (2008) 1051–1081.
- [18] V. Cossart and O. Piltant, ‘Resolution of singularities of threefolds in positive characteristic II’, *Journal of Algebra* 321 (2009) 1836–1976.
- [19] V. Cossart and O. Piltant, ‘Resolution of Singularities of Threefolds in Mixed Characteristics. Case of small multiplicity’, *Rev. R. Acad. Cienc. Exactas Fs. Nat. Ser. A Math. RACSAM* 108 (2014) 113–151.
- [20] V. Cossart and O. Piltant, ‘Resolution of Singularities of Arithmetical Threefolds’, *Journal of Algebra* 529 (2019), 268–535.
- [21] V. Cossart and B. Schober, ‘A strictly decreasing invariant for resolution of singularities in dimension two’, *Publ. Res. Inst. Math.* 56 (2020), no. 2, 217–280.
- [22] S. D. Cutkosky, *Resolution of singularities*, Graduate Studies in Mathematics 63 (American Mathematical Society, Providence, RI, 2004).
- [23] S. D. Cutkosky, ‘Resolution of singularities for 3-folds in positive characteristic’, *Amer. J. Math.* 131 (2009) 59–127.
- [24] S. D. Cutkosky, ‘A skeleton key to abhyankar’s proof of embedded resolution of characteristic  $p$  surfaces’, *Asian J. Math.* 15 (2011) 369–416.
- [25] W. Decker, G.-M. Greuel, G. Pfister and H. Schönemann, ‘SINGULAR4-0-1 A computer algebra system for polynomial computations <http://www.singular.uni-kl.de>’, 2016.
- [26] B. Dietel, ‘A refinement of Hironaka’s additive group schemes for an extended invariant’, (Dissertation, Universität Regensburg, <http://epub.uni-regensburg.de/31359/>, 2015).
- [27] S. Encinas and H. Hauser, ‘Strong resolution of singularities in characteristic zero’, *Comment. Math. Helv.* 77 (2002) 821–845.
- [28] Fraunhofer ITWM, Competence Center High Performance Computing, *GPI-Space*, September 2020, <http://www.gpi-space.de/>.
- [29] A. Frühbis-Krüger, ‘Computational Aspects of Singularities’, in J.-P. Brasselet, J. Damon et al.: *Singularities in Geometry and Topology* World Scientific Publishing, 253–327, 2007.
- [30] A. Frühbis-Krüger, ‘An application of resolution of singularities: computing the topological  $\zeta$ -function of isolated surface singularities in  $(\mathbb{C}^3, 0)$ ’, in J.-P. Brasselet, J. Damon et al.: *Singularities in Geometry and Topology*, World Scientific Publishing, 577–591, 2007.
- [31] A. Frühbis-Krüger and G. Pfister, *Singular Library resolve.lib for Resolution of Singularities*, 2004–2007.
- [32] A. Frühbis-Krüger and G. Pfister, *Singular Library rezeta.lib for topological Zeta-function and some other applications of desingularization*, 2005–2007.
- [33] A. Frühbis-Krüger and G. Pfister, ‘Some Applications of Resolution of Singularities from a Practical Point of View’, in *Computational Commutative and Non-commutative Algebraic Geometry*, NATO Science Series III, Computer and Systems Sciences 196, 104–117 (2005).
- [34] A. Frühbis-Krüger and G. Pfister, ‘Algorithmic resolution of singularities’, in *Singularities and computer algebra*, 157–183, London Math. Soc. Lecture Note Ser.324, Cambridge Univ. Press, Cambridge, 2006.
- [35] A. Frühbis-Krüger and S. Wewers, ‘Desingularization of arithmetic surfaces: algorithmic aspects’, *Algorithmic and Experimental Methods in Algebra Geometry, and Number Theory* (2017) 231–252.
- [36] J. Giraud, ‘Étude locale des singularités’, Cours de 3<sup>ème</sup> cycle, 1971–1972, *Publ. Math. d’Orsay* 26 (1972).
- [37] J. Giraud, ‘Contact maximal en caractéristique positive’, *Ann. Sci. Éc. Norm. Sup. 4<sup>ème</sup> série* 8 (1975) 201–234.
- [38] G.-M. Greuel, S. Laplagne and F. Seelisch, ‘Normalization of rings’, *Journal of Symbolic Computation* 45 (2010) 887–901.
- [39] G.-M. Greuel and G. Pfister, ‘A Singular introduction to commutative algebra’, Second, extended edition. With contributions by Olaf Bachmann, Christoph Lossen and Hans Schönemann, Springer, Berlin, 2008.

- [40] A. Grothendieck and J. Dieudonné, ‘Éléments de géométrie algébrique’, *Publ. Math. I.H.E.S.*, I: No. 4 (1960), II: No. 8 (1961), III: No. 11 (1961), IV: 1: No. 20 (1964), 2: No. 24 (1965), 3: No. 28 (1966), 4: No. 32 (1967).
- [41] H. Hironaka, ‘Resolution of singularities of an algebraic variety over a field of characteristic zero I + II’, *Ann. of Math.* 79 (1964) 109–326.
- [42] H. Hironaka, ‘Characteristic polyhedra of singularities’, *J. Math. Kyoto Univ.* 7 (1967) 251–293.
- [43] H. Hironaka, ‘Desingularization of Excellent Surfaces’, Adv. Sci. Sem. in Alg. Geo, Bowdoin College, Summer 1967. Notes by Bruce Bennett, appendix of [14] (1984).
- [44] H. Hironaka, ‘Three key theorems on infinitely near singularities’, *Singularités Franco-Japonaises*, 87–126, Sémin. Congr.10, Soc. Math. France, Paris (2005).
- [45] T. deJong, ‘An algorithm for computing the integral closure’, *Journal of Symbolic Computation* 26 (1998) 273–277.
- [46] H. Kawanoue and K. Matsuki, ‘Resolution of singularities of an idealistic filtration in dimension 3 after Benito-Villamayor’, *Minimal models and extremal rays (Kyoto, 2011)* 115–214, Adv. Stud. Pure Math. 70 (Math. Soc. Japan, 2016).
- [47] J. Kollár, *Lectures on resolution of singularities*, Annals of Mathematics Studies 166 (Princeton University Press, 2007).
- [48] J. Kollár, ‘Partial resolution by toroidal blow-ups’, *Tunisian J. Math.* Vol. 1, No. 1 (2019), 3–12.
- [49] J. Lipman, ‘Desingularization of two-dimensional schemes’, *Ann. of Math.* 107 (1978) 151–207.
- [50] A. Raschke, *Praktische Bestimmung der Stratifikation nach der Hilbert-Samuel Funktion*, Diplomarbeit, TU Kaiserslautern (2008).
- [51] B. Schober, ‘Partial local resolution by characteristic zero methods’, *Results Math.* (2018) 73:48, 39pp.
- [52] O. Villamayor, ‘Constructiveness of Hironaka’s resolution’, *Ann. Sci. École Norm. Sup.* 22 (1989) 1–32.
- [53] J. Włodarczyk, ‘Hironaka resolution in characteristic zero’, *J. Amer. Math. Soc.* 18 (2005) 779–822.
- [54] O. Zariski, ‘The concept of a simple point of an abstract algebraic variety’, *Trans. Amer. Math. Soc.* 62 (1947) 1–52.

A.FK., INSTITUT FÜR ALGEBRAISCHE GEOMETRIE, LEIBNIZ UNIVERSITÄT HANNOVER, WELFENGARTEN 1, 30167 HANNOVER, GERMANY

*Current address:* Institut für Mathematik, Carl von Ossietzky Universität Oldenburg, 26111 Oldenburg, Germany

*E-mail address:* [anne.fruehbis-krueger@uni-oldenburg.de](mailto:anne.fruehbis-krueger@uni-oldenburg.de)

L.R., COMPETENCE CENTER HIGH PERFORMANCE COMPUTING, FRAUNHOFER INSTITUTE FOR INDUSTRIAL MATHEMATICS ITWM, FRAUNHOFER-PLATZ 1, 67663 KAISERSLAUTERN, GERMANY

*Current address:* Department of Mathematics, University of Kaiserslautern, Erwin-Schrödinger-Str., 67663 Kaiserslautern, Germany

*E-mail address:* [ristau@mathematik.uni-kl.de](mailto:ristau@mathematik.uni-kl.de)

B.S., INSTITUT FÜR ALGEBRAISCHE GEOMETRIE, LEIBNIZ UNIVERSITÄT HANNOVER, WELFENGARTEN 1, 30167 HANNOVER, GERMANY

*Current address:* Institut für Mathematik, Carl von Ossietzky Universität Oldenburg, 26111 Oldenburg, Germany

*E-mail address:* [bernd.schober@uni-oldenburg.de](mailto:bernd.schober@uni-oldenburg.de)