

# Intransitive sectional-Anosov flows on 3-manifolds

S. Bautista, A. M. López B., H. M. Sánchez \*

## Abstract

For each  $n \in \mathbb{Z}^+$ , we show the existence of Venice masks (i.e. intransitive sectional-Anosov flows with dense periodic orbits, [6], [18], [4], [13]) containing  $n$  equilibria on certain compact 3-manifolds. These examples are characterized because of the maximal invariant set is a finite union of homoclinic classes. Here, the intersection between two different homoclinic classes is contained in the closure of the union of unstable manifolds of the singularities.

## 1 Introduction

The dynamical systems theory proposes to find qualitative information on the behavior in a determined system without actually finding the solutions. An example of this study is the phenomenon of transverse homoclinic points. Birkhoff proved that any transverse homoclinic orbit is accumulated by periodic points. With the introduction of *uniformly hyperbolic dynamical systems* by Smale [23], was developed a study of robust models containing infinitely many periodic orbits. However, the uniform hyperbolicity were soon realized to be less universal properties that was initially thought. On the other hand, there exist many classes of systems non hyperbolic that are often the specific models coming from concrete applications. This motivated weaker formulations of hyperbolicity such as existence of dominated splitting, partial hyperbolicity or sectional hyperbolicity.

Recall that a  $C^r$  vector field  $X$  in  $M$  is  $C^r$  robustly transitive or  $C^r$  robustly periodic depending on whether every  $C^r$  vector field  $C^r$  close to it is transitive or has dense periodic orbits. Are particularly interesting the sectional-hyperbolic sets and sectional-Anosov flows, which were introduced in [17] and [14] respectively as a generalization of the hyperbolic sets and Anosov flows. Their

---

\**Key words and phrases:* Sectional Anosov flow, Maximal invariant set, Lorenz-like singularity, Homoclinic class, Venice mask, Dense periodic orbits. This work is partially supported by CAPES, Brazil.

importance is because of the robustly transitive property in dimension three of attractors sectional-Anosov flows [20], and the inclusion of important examples such as the saddle-type hyperbolic attracting sets, the singular horseshoe, the geometric and multidimensional Lorenz attractors [1], [7], [9].

With respect to robustly transitive property, we can mention a clue fact in the scenario of sectional-Anosov flows. As consequence of the main result in [2], and *Theorem 32* in [4] follows that every sectional-Anosov flow with a unique singularity on a compact 3-manifold is  $C^r$  robustly periodic if and only if is  $C^r$  robustly transitive. On the other hand, there is not equivalence between transitivity and density of periodic orbits (which is true for Anosov flows). Indeed, there exist examples of sectional-Anosov flows non transitive with dense periodic orbits supported on compact three dimensional manifolds. So, a sectional-Anosov flow is said a *Venice mask* if it has dense periodic orbits but is not transitive. An example of Venice mask with a unique singularity was given in [6], and for three singularities was provided in [19]. Recently, [13] showed the construction the examples with two equilibria. They are characterized because the maximal invariant set is non disjoint union of two homoclinic classes [19], [18], [6], and the intersection between these classes is contained in the closure of the union of unstable manifolds of the singularities.

Particularly, was proved in [19], [18] that every Venice mask with a unique singularity has these properties. The above observations motivate the following questions,

1. It is possible to obtain Venice masks with more singularities?
2. The maximal invariant set of every Venice mask is union of two homoclinic classes?
3. How is the intersection of these homoclinic classes?

The answer to the first question is positive. We use the ideas developed in [13] and [19] for the construction of these examples, which provide more tools and clues for a general theory of Venice masks. In particular, we construct an example with five singularities which is non disjoint union of three homoclinic classes. So, the answer to the second question is false.

Let us state our results in a more precise way.

Consider a Riemannian compact manifold  $M$  of dimension three (a *compact 3-manifold* for short).  $M$  is endowed with a Riemannian metric  $\langle \cdot, \cdot \rangle$  and an induced norm  $\|\cdot\|$ . We denote by  $\partial M$  the boundary of  $M$ . Let  $\mathcal{X}^1(M)$  be the space of  $C^1$  vector fields in  $M$  endowed with the  $C^1$  topology. Fix  $X \in \mathcal{X}^1(M)$ , inwardly transverse to the boundary  $\partial M$  and denotes by  $X_t$  the flow of  $X$ ,  $t \in \mathbb{R}$ .

The *omega-limit set* of  $p \in M$  is the set  $\omega_X(p)$  formed by those  $q \in M$  such that  $q = \lim_{n \rightarrow \infty} X_{t_n}(p)$  for some sequence  $t_n \rightarrow \infty$ . The *alpha-limit set* of  $p \in M$  is the set  $\alpha_X(p)$  formed by those  $q \in M$  such that  $q = \lim_{n \rightarrow \infty} X_{t_n}(p)$  for some sequence  $t_n \rightarrow -\infty$ . Given  $\Lambda \in M$  compact, we say that  $\Lambda$  is *invariant* if  $X_t(\Lambda) = \Lambda$  for all  $t \in \mathbb{R}$ . We also say that  $\Lambda$  is *transitive* if  $\Lambda = \omega_X(p)$  for some  $p \in \Lambda$ ; *singular* if it contains a singularity and *attracting* if  $\Lambda = \bigcap_{t > 0} X_t(U)$  for some compact neighborhood  $U$  of it. This neighborhood is often called *isolating block*. It is well known that the isolating block  $U$  can be chosen to be positively invariant, i.e.,  $X_t(U) \subset U$  for all  $t > 0$ . An *attractor* is a transitive attracting set. An attractor is *nontrivial* if it is not a closed orbit.

The *maximal invariant set* of  $X$  is defined by  $M(X) = \bigcap_{t \geq 0} X_t(M)$ .

**Definition 1.1.** A compact invariant set  $\Lambda$  of  $X$  is hyperbolic if there are a continuous tangent bundle invariant decomposition  $T_\Lambda M = E^s \oplus E^X \oplus E^u$  and positive constants  $C, \lambda$  such that

- $E^X$  is the vector field's direction over  $\Lambda$ .
- $E^s$  is contracting, i.e.,  $\|DX_t(x)|_{E_x^s}\| \leq Ce^{-\lambda t}$ , for all  $x \in \Lambda$  and  $t > 0$ .
- $E^u$  is expanding, i.e.,  $\|DX_{-t}(x)|_{E_x^u}\| \leq Ce^{-\lambda t}$ , for all  $x \in \Lambda$  and  $t > 0$ .

A compact invariant set  $\Lambda$  has a *dominated splitting* with respect to the tangent flow if there are an invariant splitting  $T_\Lambda M = E \oplus F$  and positive numbers  $K, \lambda$  such that

$$\|DX_t(x)e_x\| \cdot \|f_x\| \leq Ke^{-\lambda t} \|DX_t(x)f_x\| \cdot \|e_x\|, \quad \forall x \in \Lambda, t \geq 0, (e_x, f_x) \in E_x \times F_x.$$

Notice that this definition allows every compact invariant set  $\Lambda$  to have a dominated splitting with respect to the tangent flow (See [5]): Just take  $E_x = T_x M$  and  $F_x = 0$ , for every  $x \in \Lambda$  (or  $E_x = 0$  and  $F_x = T_x M$  for every  $x \in \Lambda$ ).

A compact invariant set  $\Lambda$  is *partially hyperbolic* if it has a *partially hyperbolic splitting*, i.e., a dominated splitting  $T_\Lambda M = E \oplus F$  with respect to the tangent flow whose dominated subbundle  $E$  is contracting in the sense of Definition 1.1.

The Riemannian metric  $\langle \cdot, \cdot \rangle$  of  $M$  induces a 2-Riemannian metric [21],

$$\langle u, v/w \rangle_p = \langle u, v \rangle_p \cdot \langle w, w \rangle_p - \langle u, w \rangle_p \cdot \langle v, w \rangle_p, \quad \forall p \in M, \forall u, v, w \in T_p M.$$

This in turns induces a 2-norm [8] (or areal metric [12]) defined by

$$\|u, v\| = \sqrt{\langle u, u/v \rangle_p} \quad \forall p \in M, \forall u, v \in T_p M.$$

Geometrically,  $\|u, v\|$  represents the area of the parallelogram generated by  $u$  and  $v$  in  $T_pM$ .

If a compact invariant set  $\Lambda$  has a dominated splitting  $T_\Lambda M = F^s \oplus F^c$  with respect to the tangent flow, then we say that its central subbundle  $F^c$  is *sectionally expanding* if

$$\|DX_t(x)u, DX_t(x)v\| \geq K^{-1}e^{\lambda t}\|u, v\|, \quad \forall x \in \Lambda, u, v \in F_x^c, t \geq 0.$$

Recall that a singularity of a vector field is hyperbolic if the eigenvalues of its linear part have non zero real part.

By a *sectional hyperbolic splitting* for  $X$  over  $\Lambda$  we mean a partially hyperbolic splitting  $T_\Lambda M = F^s \oplus F^c$  whose central subbundle  $F^c$  is sectionally expanding.

**Definition 1.2.** *A compact invariant set  $\Lambda$  is sectional hyperbolic for  $X$  if its singularities are hyperbolic and if there is a sectional hyperbolic splitting for  $X$  over  $\Lambda$ .*

**Definition 1.3.** *We say that  $X$  is a sectional-Anosov flow if  $M(X)$  is a sectional hyperbolic set.*

The Invariant Manifold Theorem [11] asserts that if  $x$  belongs to a hyperbolic set  $H$  of  $X$ , then the sets

$$W_X^{ss}(p) = \{x \in M : d(X_t(x), X_t(p)) \rightarrow 0, t \rightarrow \infty\} \quad \text{and} \\ W_X^{uu}(p) = \{x \in M : d(X_t(x), X_t(p)) \rightarrow 0, t \rightarrow -\infty\},$$

are  $C^1$  immersed submanifolds of  $M$  which are tangent at  $p$  to the subspaces  $E_p^s$  and  $E_p^u$  of  $T_pM$  respectively.

$$W_X^s(p) = \bigcup_{t \in \mathbb{R}} W_X^{ss}(X_t(p)) \quad \text{and} \quad W_X^u(p) = \bigcup_{t \in \mathbb{R}} W_X^{uu}(X_t(p))$$

are also  $C^1$  immersed submanifolds tangent to  $E_p^s \oplus E_p^X$  and  $E_p^X \oplus E_p^u$  at  $p$  respectively.

We denote by  $Sing(X)$  to the set of singularities of  $X$ , and  $Cl(A)$  to the closure of  $A$ .

**Definition 1.4.** *We say that a singularity  $\sigma$  of a sectional-Anosov flow  $X$  of dimension three is Lorenz-like if it has three real eigenvalues  $\lambda^{ss}, \lambda^s, \lambda^u$  with  $\lambda^{ss} < \lambda^s < 0 < -\lambda^s < \lambda^u$ . The strong stable foliation associated to  $\sigma$  and denoted by  $\mathcal{F}_X^{ss}(\sigma)$ , is the foliation contained in  $W^s(\sigma)$  which is tangent to space generated by the eigenvalue  $\lambda^{ss}$ .*

We denote as  $W^s(\text{Sing}(X))$  to  $\bigcup_{\sigma \in \text{Sing}(X)} W^s(\sigma)$ .

Respectively,  $W^u(\text{Sing}(X)) = \bigcup_{\sigma \in \text{Sing}(X)} W^u(\sigma)$ .

**Definition 1.5.** *A periodic orbit of  $X$  is the orbit of some  $p$  for which there is a minimal  $t > 0$  (called the period) such that  $X_t(p) = p$ .*

$\gamma$  is a *transverse homoclinic orbit* of a hyperbolic periodic orbit  $O$  if  $\gamma \subset W^s(O) \cap W^u(O)$ , and  $T_q M = T_q W^s(O) + T_q W^u(O)$  for some (and hence all) point  $q \in \gamma$ . The homoclinic class  $H(O)$  of a hyperbolic periodic orbit  $O$  is the closure of the union of the transverse homoclinic orbits of  $O$ . We say that a set  $\Lambda$  is a homoclinic class if  $\Lambda = H(O)$  for some hyperbolic periodic orbit  $O$ .

**Definition 1.6.** *A Venice mask is a sectional-Anosov flow with dense periodic orbits which is not transitive.*

$D^n$  denotes the unit ball in  $\mathbb{R}^n$  and  $\partial D^n$  the boundary of  $D^n$ .

An  $n$ -cell is a manifold homeomorphic to the open ball  $D^n \setminus \partial D^n$ .

The following definition appears in [10].

**Definition 1.7.** *A handlebody of genus  $n \in \mathbb{N}$  (or a cube with  $n$ -handles) is a compact 3-manifold with boundary  $HB_n$  such that*

- $HB_n$  contains a disjoint collection of  $n$  properly embedded 2-cells.
- A 3-cell is obtain of cutting  $HB_n$  along the boundary of these 2-cells.

Observe that a 3-ball is a handlebody of genus 0, whereas a solid torus is a handlebody of genus 1.

In [15] was proved that every orientable handlebody  $HB_n$  of genus  $n \geq 2$  supports a transitive sectional-Anosov flow. In particular these flows have  $n - 1$  singularities. An example is the geometric Lorenz attractor which is supported on a solid bitorus. We show that certain classes of handlebody support Venice masks.

The following is the statement of the main result in this paper.

**Theorem A.** *For each  $n \in \mathbb{Z}^+$ :*

- *There exists a Venice mask  $X_{(n)}$  with  $n$  singularities which is supported on some compact 3-manifold  $M$ . In addition,  $M(X_{(n)})$  can be decomposed as union of two homoclinic classes.*

- *There exists a Venice mask  $Y_{(n)}$  supported on some compact 3-manifold  $N$  such that  $N(Y_{(n)})$  is union of  $n + 1$  homoclinic classes.*

*In both cases, the intersection of two different homoclinic classes of the maximal invariant set, is contained in the closure of the union of unstable manifolds of the singularities.*

In section 2, we briefly describe the construction and some important properties for the known examples with two and three singularities. In section 3, by using the techniques of the Venice masks with two singularities, we construct an example with four singular points. In the same way, in Section 4, from the Venice mask with three singularities, will be obtained an example with five equilibria being its maximal invariant set union of three homoclinic classes. Theorems 4.2 and 3.2 will be obtained of an inductive process. Finally, *Theorem A* will be a direct consequence of *Theorem 4.2* and *Theorem 3.2*.

## 2 Preliminaries

We make a brief description about the known Venice masks.

An example with a unique singularity was given in [6], and in [19] was proved that every Venice mask  $X_{(1)}$  with one equilibrium satisfies the following properties:

- $M(X_{(1)})$  is union of two homoclinic classes  $H_{X_{(1)}}^1, H_{X_{(1)}}^2$ .
- $H_{X_{(1)}}^1 \cap H_{X_{(1)}}^2 = Cl(W_{X_{(1)}}^u(\sigma))$  where  $\sigma$  is the singularity of  $X_{(1)}$ .

In [13] were exhibited two Venice masks containing two equilibria  $\sigma_1, \sigma_2$ . For the first example we have a vector field  $X$  verifying:

- $M(X)$  is the union of two homoclinic class  $H_X^1, H_X^2$ .
- $H_X^1 \cap H_X^2 = O$ , where  $O$  is a hyperbolic periodic orbit.
- $O = \omega_X(q)$ , for all  $q \in W_X^u(\sigma_1) \cup W_X^u(\sigma_2) \setminus \{\sigma_1, \sigma_2\}$ .

The vector field  $Y$  that determines the second example with two singularities  $\sigma_1, \sigma_2$  satisfies:

- $M(Y)$  is the union of two homoclinic class  $H_Y^1, H_Y^2$ .
- $H_Y^1 \cap H_Y^2 = Cl(W_Y^u(\sigma_1) \cup W_Y^u(\sigma_2))$ .

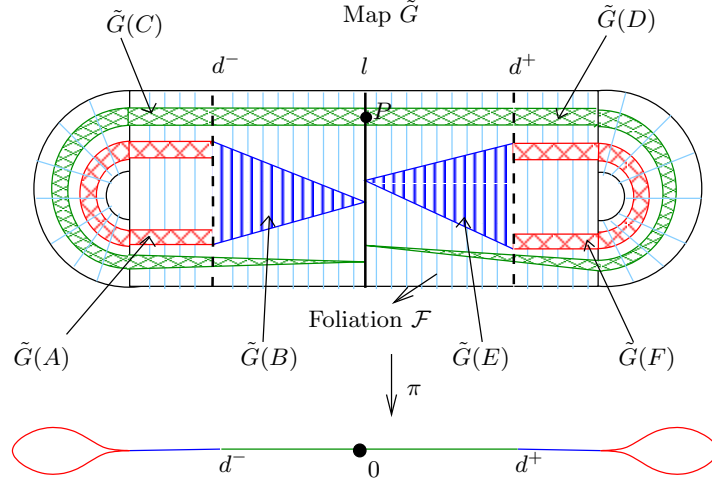

Figure 1: Two-dimensional map  $\tilde{G}$  on region  $R$ .

An essential element to obtain the examples with two singularities is the existence of a return map defined in a cross section  $R$ . A foliation  $\mathcal{F}$  is defined on  $R$ , which has vertical segments in the rectangular components  $B, C, D, E$  and radial segments in the annuli components  $A, F$ .

We are interested to take a  $C^\infty$  two-dimensional map  $\tilde{G} : R \setminus \{d^-, d^+\} \rightarrow \text{Int}(R)$  such as in [13], satisfying the hypotheses **(L1)**-**(L3)** established there. In particular, **(L1)** and **(L2)** imply the contraction and the invariance of the leaf  $l$  by  $\tilde{G}$ . So, the map  $\tilde{G}$  has a fixed point  $P \in l$ . We define  $H^+ = A \cup B \cup C$  and  $H^- = D \cup E \cup F$ . For

$$A_{\tilde{G}}^- = Cl \left( \bigcap_{n \geq 1} \tilde{G}^n(H^-) \right), \quad A_{\tilde{G}}^+ = Cl \left( \bigcap_{n \geq 1} \tilde{G}^n(H^+) \right)$$

follow that  $A_{\tilde{G}}^+$  and  $A_{\tilde{G}}^-$  are homoclinic classes and  $\{P\} = A_{\tilde{G}}^+ \cap A_{\tilde{G}}^-$ .

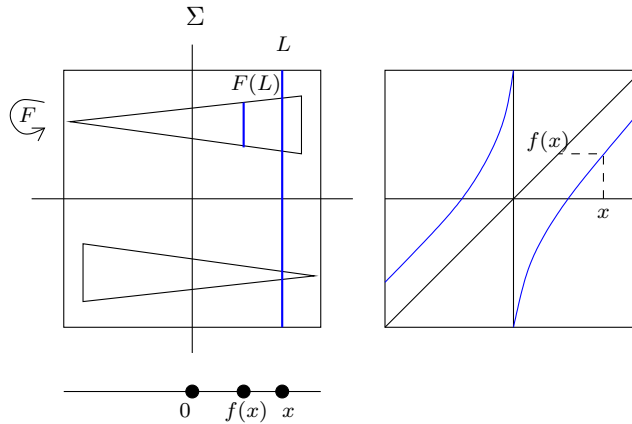

Figure 2: Map  $F$ .

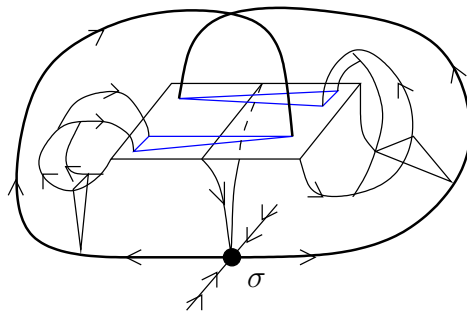

Figure 3: Geometric Lorenz Attractor.

The mode to obtain the example with three singularities described in [19] is easier. First of all, is important to know some properties about the dynamic of the Geometric Lorenz Attractor (GLA for short) [9].

In [3] was proved that this attractor is a homoclinic class. The result is obtained due to the existence of a return map  $F$  for the flow, defined on a cross section  $\Sigma$ . This map preserves the stable foliation  $\mathcal{F}^s$ , where the leaves are vertical lines. The induced map  $f$  in the leaf space is differentiable and expansive.

The GLA is modified in [19] by adding two singularities to the flow located at  $W^u(\sigma)$ . We called this modification as  $GLA_{mod}$ . We glue together in a  $C^\infty$  fashion two copies of this flow along the unstable manifold of the singularity  $\sigma$ , thus generating the flow depicted in Figure 4. In this way is obtained a sectional-Anosov flow  $X_{(3)}$  with dense periodic orbits and three equilibria whose



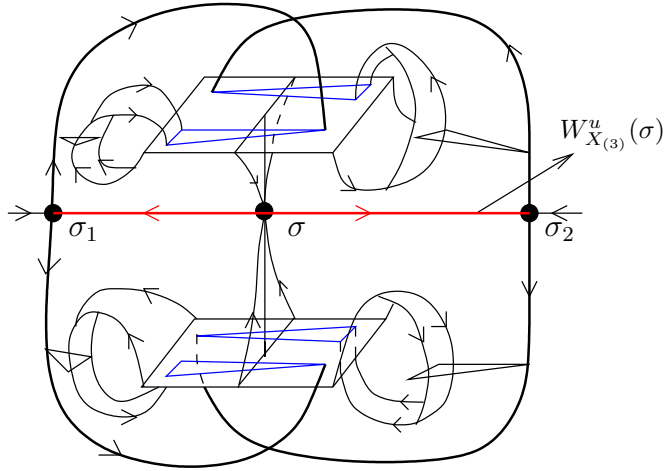

Figure 4: Example with three singularities.

maximal invariant set is non-disjoint union of two homoclinic classes. In this case, the intersection between the homoclinic classes is  $Cl(W_{X_{(3)}}^u(\sigma))$ .

Observe that this flow is supported on a handlebody of genus 4.

### 3 Decomposing the maximal invariant set as union of two homoclinic classes

#### 3.1 Vector field $Z$

We provide an example with four singularities. We start with the vector field  $X$  associated to the Venice mask with two singularities. Then, we construct a plug  $Z_4$  containing two additional equilibria  $\sigma_3, \sigma_4$ . In this way, the flow is obtained through plug  $Z_4$  surgery from one solid tritorus onto another manifold exporting some of its properties.

The vector field  $X$  is supported on a solid tritorus  $ST_1$ . Now, we remove a connected component  $B$  of  $ST_1$  as in Figure 5.

The behavior across the faces removed is similar with respect to observed in the example given by the vector field  $Y$  in [13].

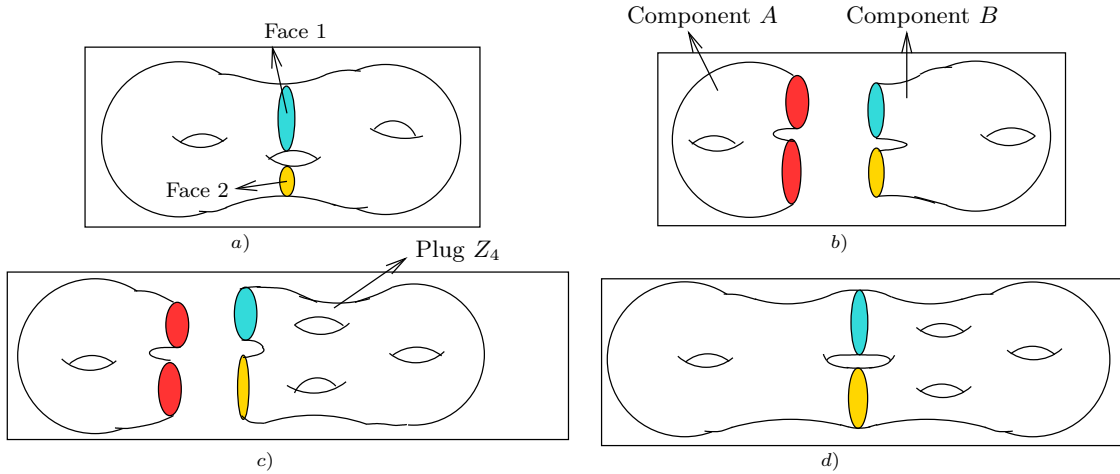

Figure 5: Steps by gluing the new plug.

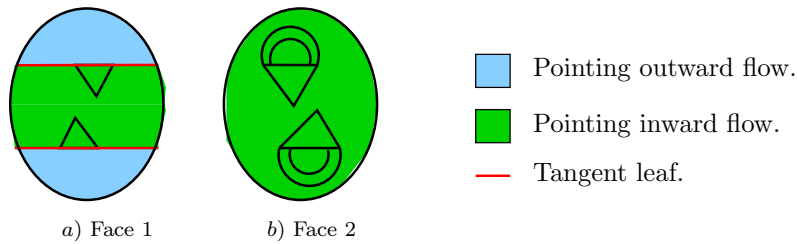

Figure 6: Faces.

On face 1, we identify three regions determined by the singular leaves saturated by the flow. In the middle region on face 1, the trajectories crossing inward to  $\partial A$ , such as the branch unstable manifold of the two initial singularities. All trajectories are crossing inward to face 2 as  $\partial A$ .

As we before mention, will be constructed an adequate plug  $Z_4$  to include the additional equilibria. We ask the singularities to be Lorenz-like. In this sense, is considered the Cherry flow and its deformation via DA-Attractor [22] to obtain a perturbed Cherry flow such as in [13]. Take the neighborhood  $U$  of  $\sigma$  such as in [13]. So,  $U$  contains a source  $\sigma$  and two saddles  $\sigma_1, \sigma_2$ . A disk  $D$  centered in  $\sigma$ , with the flow outwardly transverse to the  $\partial D$  is removed. After that, the vector field over  $U$  in the perturbed Cherry flow is multiplied by a strong contraction  $\lambda_{ss}$ . Then, two Lorenz-like singularities  $\sigma_1$  and  $\sigma_2$  are obtained and one hole  $H_\sigma$  is generated.

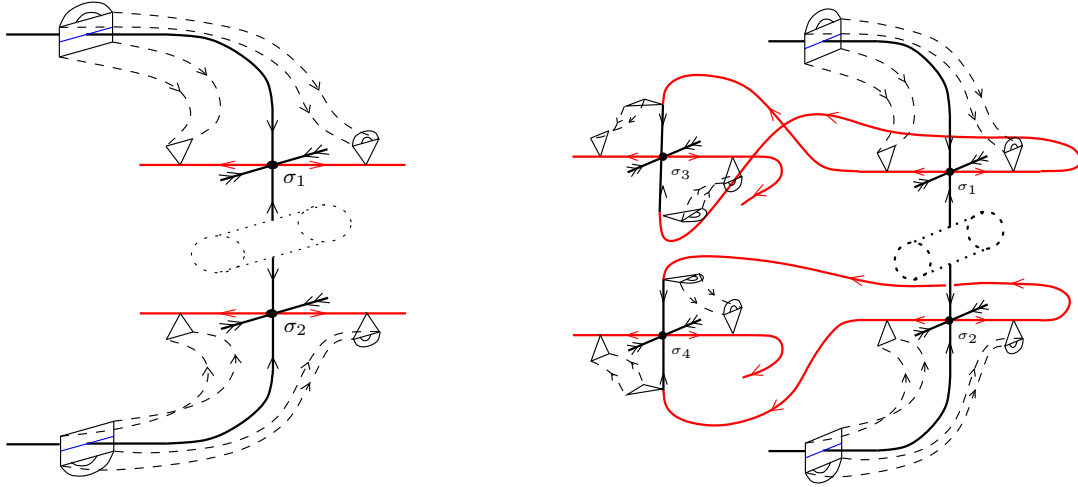

Figure 7: Plug  $Z_4$ .

To continue, is made a saddle-type connection between the branches of the unstable manifold of  $\sigma_1$  and the stable manifold of a singularity  $\sigma_3$ . In a similar way is made a saddle-type connection between the branches of the unstable manifold of  $\sigma_2$  and the stable manifold of a singularity  $\sigma_4$ . On the other hand, such as in the GLA (see [3]), two holes  $H_{\sigma_1}, H_{\sigma_2}$  are generated by the unstable manifolds of the singularities  $\sigma_1, \sigma_2$  respectively. In each hole, there is a singular point  $\rho_i$  with two complex eigenvalues  $z_i, \bar{z}_i$  ( $Re(z_i) > 0$ ) and an eigenvalue  $\lambda_i < 0$ .

The holes  $H_{\sigma_1}, H_{\sigma_2}$  are connected with the third hole  $H_\sigma$  separating  $\sigma_1$  and  $\sigma_2$ . The branches of the unstable manifolds associated to  $\sigma_3$  and  $\sigma_4$  cross the faces 1 and 2, and these go to the Plug 3 defined in [13] such as the example given by the vector field  $X$ . See Figure 8.

Therefore, we obtain a handlebody  $HB_5$  of genus five. So, the vector field  $Z$  produced by gluing plug  $Z_4$  instead the removed connected component  $B$ , satisfies  $Z_t(HB_5) \subset Int(HB_5)$  for all  $t > 0$ . Moreover  $Z$  is transverse to the boundary handlebody.

We exhibit with details the behavior near to the singularities. For that, we mention some facts that appear in [16]. As every singularity is Lorenz-like, there exists a center unstable manifold  $W_Z^{cu}(\sigma_i)$  associated to  $\sigma_i$  ( $i = 1, 2, 3, 4$ ). It is divided by  $W_Z^u(\sigma_i)$  and  $W_Z^s(\sigma_i) \cap W_Z^{cu}(\sigma_i)$  in the four sectors  $s_{11}, s_{12}, s_{21}, s_{22}$ . There is also a projection  $\pi : V_{\sigma_i} \rightarrow W_Z^{cu}(\sigma_i)$  defined in a neighborhood  $V_{\sigma_i}$  of  $\sigma_i$  via the strong stable foliation of the maximal invariant set associated to flow.

For  $\sigma \in Sing(Z)$ , we define the matrix

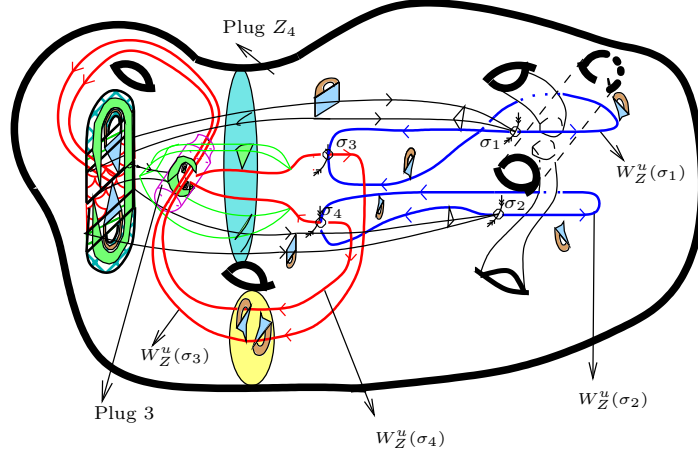

Figure 8: Venice mask with four singularities.

$$A(\sigma) = \begin{pmatrix} a_{11} & a_{12} \\ a_{21} & a_{22} \end{pmatrix},$$

where

$$a_{ij} = \begin{cases} 1 & \text{if } \sigma \in Cl(\pi(M(Z) \cap V_\sigma)) \cap s_{ij} \\ 0 & \text{if } \sigma \notin Cl(\pi(M(Z) \cap V_\sigma)) \cap s_{ij}. \end{cases}$$

$A(\sigma)$  does not depend on the chosen center unstable manifold  $W_Z^{cu}(\sigma)$ .

Figure 9 shows the case for the singularity  $\sigma_1$  of the example.

These are the associated matrices to the singularities of our vector field  $Z$ .

$$A_{\sigma_1} = \begin{pmatrix} 1 & 1 \\ 0 & 0 \end{pmatrix}, \quad A_{\sigma_2} = \begin{pmatrix} 0 & 0 \\ 1 & 1 \end{pmatrix}, \quad A_{\sigma_3} = \begin{pmatrix} 1 & 0 \\ 0 & 1 \end{pmatrix}, \quad A_{\sigma_4} = \begin{pmatrix} 0 & 1 \\ 1 & 0 \end{pmatrix}.$$

Now, we consider the following hypotheses.

**(Z1)**: There are two repelling periodic orbits  $O_1, O_2$  in  $Int(HB_5)$  crossing the holes of  $R$ .

**(Z2)**: There are two solid tori neighborhoods  $V_1, V_2 \subset Int(HB_5)$  of  $O_1, O_2$  with boundaries transverse to  $Z_t$  such that if  $N_4 = HB_5 \setminus (V_1 \cup V_2)$ , then  $N_4$  is a compact neighborhood with smooth boundary transverse to  $Z_t$  and  $Z_t(N_4) \subset N_4$  for  $t > 0$ .  $N_4$  is a handlebody of genus five with two solid tori removed.

**(Z3)**:  $R \subset N_4$  and the return map  $\tilde{G}$  induced by  $Z$  in  $R$  satisfies the properties **(L1)**-**(L3)** given in [13]. Moreover,

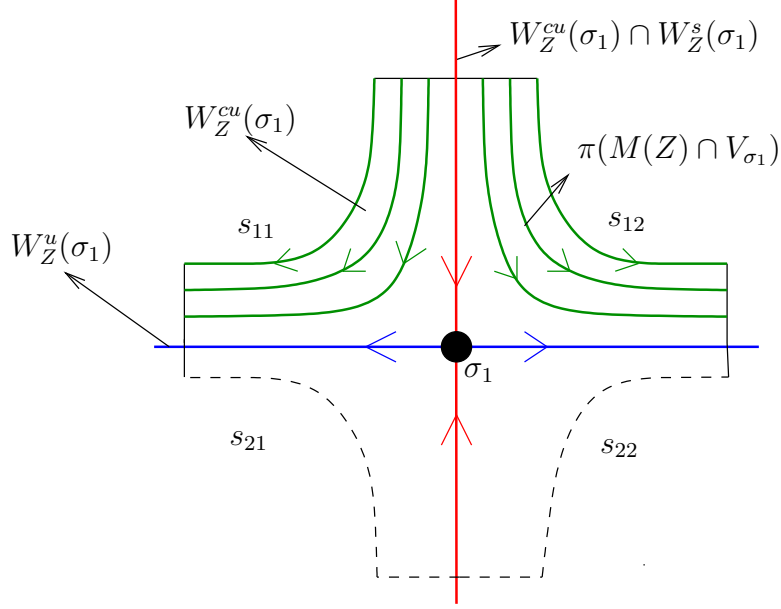

Figure 9: Center unstable manifold of  $\sigma_1$ .

$$\{q \in N : Z_t(q) \notin R, \forall t \in \mathbb{R}\} = Cl(W_Z^u(\sigma_1) \cup W_Z^u(\sigma_2)).$$

We define

$$A_Z^+ = Cl\left(\bigcup_{t \in \mathbb{R}} Z_t(A_G^+)\right) \quad \text{and} \quad A_Z^- = Cl\left(\bigcup_{t \in \mathbb{R}} Z_t(A_G^-)\right).$$

**Proposition 3.1.**  *$Z$  is a Venice mask with four singularities supported on the compact 3-manifold  $N_4$ .  $N_4(Z)$  is the union of two homoclinic classes  $A_Z^+$ ,  $A_Z^-$ . The intersection between  $A_Z^+$  and  $A_Z^-$  is a hyperbolic periodic orbit  $O$  contained in  $Cl(W_Z^u(\sigma_3) \cup W_Z^u(\sigma_4))$ .*

*Proof.* By construction  $Z$  has four singularities. The proof to be  $A_Z^+$ ,  $A_Z^-$  homoclinic classes is the same given in [13]. Also the fact to be  $Z$  a Venice mask. The intersection between the homoclinic classes is reduced to a hyperbolic periodic orbit  $O$  because of  $\{P\} = A_G^+ \cap A_G^-$  and by hypotheses **(Z3)**. Here,  $O = O_Z(P)$ . We observe that the branches of the unstable manifolds of  $\sigma_3$  and  $\sigma_4$  intersect the leaf  $l$  of the foliation  $\mathcal{F}$  in  $R$ . Then the hypotheses **(L1)**, **(L2)** of the map  $\tilde{G}$ , and the invariance of the flow imply  $O \subset \omega_Z(q)$  for all regular point  $q \in W_Z^u(\sigma_3) \cup W_Z^u(\sigma_4)$ . As  $W_Z^u(\sigma_3) \subset A_Z^+$  and  $W_Z^u(\sigma_4) \subset A_Z^-$  (see Proposition 4.1 [13]) we conclude  $A_Z^+ \cap A_Z^- \subset Cl(W_Z^u(\sigma_3) \cup W_Z^u(\sigma_4))$ .  $\square$

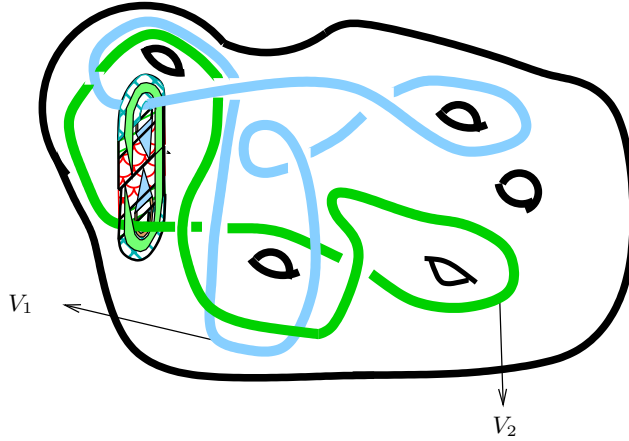

Figure 10: The manifold  $N_4$ .

### 3.2 General case

We expose a general result. More specifically the following theorem holds.

**Theorem 3.2.** *For every  $n \in \mathbb{Z}^+$ , there exists a Venice mask  $X_{(n)}$  with  $n$  singularities supported on a handlebody  $N_n$  of genus  $n + 1$  with two solid tori removed.  $N_n(X_{(n)})$  is the non-disjoint union of two homoclinic classes, and the intersection between them is a hyperbolic periodic orbit contained in  $Cl(W^u(\text{Sing}(X_{(n)})))$ .*

*Proof.*  $n = 1, 2, 4$  is done. Consider  $n \geq 3$ . Again, we remove the same connected component  $B$  to the manifold that supports the Venice mask  $X$  with two equilibria. We glue a plug  $Z_n$  containing  $n$  Lorenz-like singularities. For each singularity in  $Z_n$ , we have a saddle-type connection between  $W_{X_{(n)}}^u(\sigma_i)$  and  $W_{X_{(n)}}^s(\sigma_{i+2})$ ,  $i = 1, \dots, n - 2$ . For each saddle-type connection is produced a hole. Figure 11 exhibits the particular case for Plug  $Z_5$ . The branches of the unstable manifolds associated to  $\sigma_{n-1}$  and  $\sigma_n$  cross the faces 1 and 2, and these go to the Plug 3.

So, the new manifold is a handlebody  $HB_{n+1}$  of genus  $n + 1$  and supports a flow  $X_{(n)t}$  with  $n$  equilibria. The flow is obtained by gluing plug  $Z_n$  instead the connected component  $B$ . In this way, the vector field  $X_{(n)}$  on  $HB_{n+1}$  satisfies  $X_{(n)t}(HB_{n+1}) \subset \text{Int}(HB_{n+1})$  for all  $t > 0$ . In addition,  $X_{(n)}$  is transverse to the boundary handlebody.

Here,

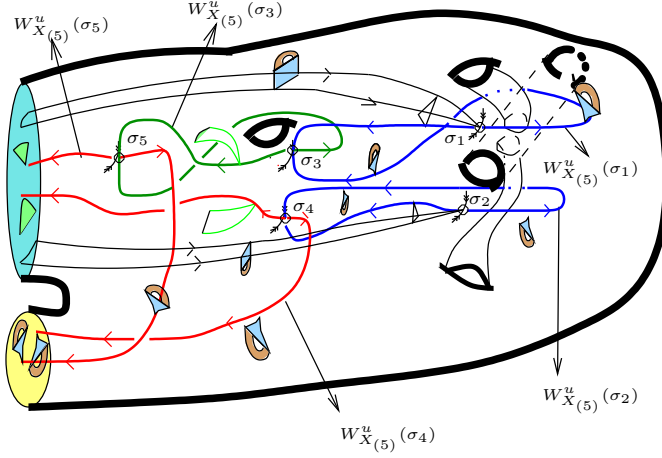

Figure 11: Plug  $Z_5$ .

$$A_{\sigma_1} = \begin{pmatrix} 1 & 1 \\ 0 & 0 \end{pmatrix}, \quad A_{\sigma_2} = \begin{pmatrix} 0 & 0 \\ 1 & 1 \end{pmatrix}, \quad A_{\sigma_{2k-1}} = \begin{pmatrix} 1 & 0 \\ 0 & 1 \end{pmatrix}, \quad A_{\sigma_{2k}} = \begin{pmatrix} 0 & 1 \\ 1 & 0 \end{pmatrix},$$

$$k = 2, \dots, n/2.$$

We assume  $X_{(n)}$  satisfying the hypotheses:

**( $Z_n\mathbf{1}$ )**: There are two repelling periodic orbits  $O_1, O_2$  in  $\text{Int}(HB_{n+1})$  crossing the holes of  $R$ .

**( $Z_n\mathbf{2}$ )**: There are two solid tori neighborhoods  $V_1, V_2 \subset \text{Int}(HB_{n+1})$  of  $O_1, O_2$  with boundaries transverse to  $X_{(n)t}$  such that if  $N_n = HB_{n+1} \setminus (V_1 \cup V_2)$ , then  $N_n$  is a compact neighborhood with smooth boundary transverse to  $X_{(n)t}$  and  $X_{(n)t}(N_n) \subset N_n$  for  $t > 0$ .  $N_n$  is a handlebody of genus  $n + 1$  with two solid tori removed.

**( $Z_n\mathbf{3}$ )**:  $R \subset N_n$  and the return map  $\tilde{G}$  induced by  $X_{(n)}$  in  $R$  satisfies the properties **(L1)**-**(L3)** given in [13]. Moreover,

$$\{q \in N_n : X_{(n)t}(q) \notin R, \forall t \in \mathbb{R}\} = \text{Cl} \left( \bigcup_{m=1}^{n-2} W_{X_{(n)}}^u(\sigma_m) \right).$$

We define

$$A_{X_{(n)}}^+ = \text{Cl} \left( \bigcup_{t \in \mathbb{R}} X_{(n)t}(A_{\tilde{G}}^+) \right) \quad \text{and} \quad A_{X_{(n)}}^- = \text{Cl} \left( \bigcup_{t \in \mathbb{R}} X_{(n)t}(A_{\tilde{G}}^-) \right).$$

$A_{X_{(n)}}^+$  and  $A_{X_{(n)}}^-$  are homoclinic classes for  $X_{(n)}$ . Moreover  $A_{X_{(n)}}^+ \cup A_{X_{(n)}}^- = N_n(X_{(n)})$  and  $A_{X_{(n)}}^+ \cap A_{X_{(n)}}^- = O$ , where  $O = O_{X_{(n)}}(P)$  with  $P$  the fix point

associated to map  $\tilde{G}$  defined in  $R$ .

The proof follows the same ideas to construct the example with four singularities.  $\square$

## 4 Decomposing the maximal invariant set as union of $n$ homoclinic classes

From Theorem 3.2 follows the first part of the main statement of this work. For these examples, the maximal invariant set can be decomposed as union of two homoclinic classes. Now, will be proved for each  $n \geq 2$ , the existence of a Venice mask such that the maximal invariant set is union of  $n$  homoclinic classes.

As was observed in Section 2, Venice masks containing one or three equilibria have already been developed. To continue, we provide an example with five singularities. The idea is very simple. We just proceed such as the process made to obtain the vector field  $X_{(3)}$ .

First of all, the GLA as sectional-Anosov flow, is supported on a solid bitorus (see [3]). The holes on the manifold are produced because of the branches of the unstable manifold of the saddle-type singularity. Therefore,  $X_{(3)}$  is a Venice mask defined on a handlebody of genus 4. The holes are generated by the branches of the unstable manifolds of  $\sigma_1$  and  $\sigma_2$ .

Now, for the vector field  $X_{(3)}$ , we add two Lorenz-like singularities located at the branches of  $W_{X_{(3)}}^u(\sigma_2)$ . We glue together in a  $C^\infty$  fashion one copy of  $GLA_{mod}$  along the unstable manifold of the singularity  $\sigma_2$ . Thus is obtained the vector field  $X_{(5)}$  whose flow is depicted in Figure 12.

For each  $i = 1, 2, 3$ , there is a cross section  $\Sigma_i$  and return map  $F_i$  such that

$$\Lambda_i = Cl \left( \bigcap_{n \geq 0} F_i^n(\Sigma_i) \right)$$

is a homoclinic class for  $F_i$ . Therefore

$$H_i = Cl \left( \bigcup_{t \in \mathbb{R}} X_{(5)}(t, \Lambda_i) \right)$$

is a homoclinic class for flow  $X_{(5)}$ . Moreover,  $H_1 \cap H_2 \subset Cl(W_{X_{(5)}}^u(\sigma))$ ,  $H_1 \cap H_3 \subset Cl(W_{X_{(5)}}^u(\sigma_2))$  and  $H_2 \cap H_3 \subset Cl(W_{X_{(5)}}^u(\sigma_2))$ .



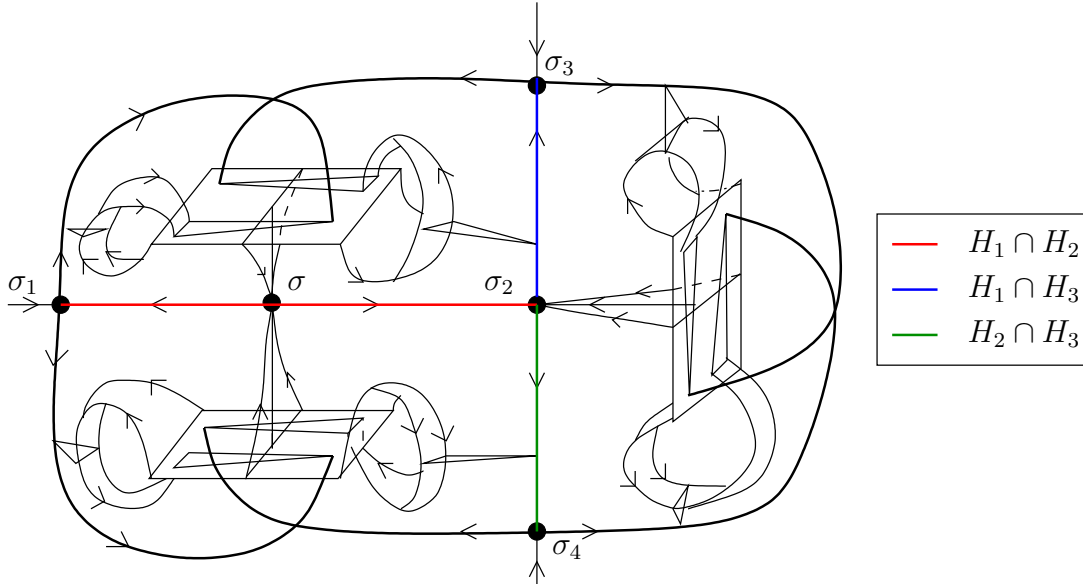

Figure 12: Venice mask with five singularities.

**Proposition 4.1.**  $X_{(5)}$  is a Venice mask supported on a handlebody  $HB_6$  of genus 6. The maximal invariant set  $HB_6(X_{(5)})$  is non-disjoint union of three homoclinic classes. The intersection between two different homoclinic classes is contained in  $Cl(W^u(\text{Sing}(X_{(5)})))$ .

It is possible to continue gluing copies of  $GLA_{mod}$  to produce Venice masks with any odd number of equilibria. Each copy is glued along the unstable manifold of some singularity  $\sigma_i$ . The equilibrium  $\sigma_i$  is chosen such that were previously possible to add two Lorenz-like singularities in its unstable manifold, one on each branch. More specifically, each  $\sigma_i$  is selected to add two new singular points if previously we have

$$A_{\sigma_i} \neq \begin{pmatrix} 1 & 1 \\ 1 & 1 \end{pmatrix}.$$

In this way, the following theorem holds.

**Theorem 4.2.** *For every  $n$  odd ( $n \geq 3$ ), there exists a Venice mask  $X_{(n)}$  with  $n$  singularities supported on a handlebody  $HB_{n+1}$  of genus  $n + 1$ . The maximal invariant set  $HB_{n+1}(X_{(n)})$  is non-disjoint union of  $(n + 1)/2$  homoclinic classes. The intersection between two different homoclinic classes is contained in  $Cl(W^u(\text{Sing}(X_{(n)})))$ .*

*Theorem A follows from Theorem 3.2 and Theorem 4.2.*

## References

- [1] AFRAIMOVICH, V. S., BYKOV, V. V., AND SHILNIKOV, L. P. On structurally unstable attracting limit sets of lorenz attractor type. *Trudy Moskov. Mat. Obshch.* 44, 2 (1982), 150–212.
- [2] ARROYO, A., AND PUJALS, E. Dynamical properties of singular-hyperbolic attractors. *Discrete Contin. Dyn. Syst.* 19, 1 (2007), 67–87.
- [3] BAUTISTA, S. The geometric lorenz attractor is a homoclinic class. *Bol. Mat.(NS)* 11, 1 (2004), 69–78.
- [4] BAUTISTA, S., AND MORALES, C. A. Lectures on sectional-anosov flows. [http://preprint.impa.br/Shadows/SERIE\\_D/2011/86.html](http://preprint.impa.br/Shadows/SERIE_D/2011/86.html).
- [5] BAUTISTA, S., AND MORALES, C. A. On the intersection of sectional-hyperbolic sets. *J. of Modern Dynamics* 10, 1 (2016), 1–16.
- [6] BAUTISTA, S., MORALES, C. A., AND PACIFICO, M. J. On the intersection of homoclinic classes on singular-hyperbolic sets. *Discrete and continuous Dynamical Systems* 19, 4 (2007), 761–775.
- [7] BONATTI, C., PUMARIÑO, A., AND VIANA, M. Lorenz attractors with arbitrary expanding dimension. *C. R. Acad. Sci. Paris Sér. I Math.* 325, 8 (1997), 883–888.
- [8] GÄHLER, S. Lineare 2-normierte räume. *Mathematische Nachrichten* 28, 1-2 (1964), 1–43.
- [9] GUCKENHEIMER, J., AND WILLIAMS, R. F. Structural stability of lorenz attractors. *Publications Mathématiques de l’IHÉS* 50, 1 (1979), 59–72.
- [10] HEMPEL, J. *3-manifolds*. Ann. of Math. Studies, No. 86. Princeton University Press, Princeton, N. J.; University of Tokyo Press, Tokyo, 1976.
- [11] HIRSCH, M. W., PUGH, C. C., AND SHUB, M. *Invariant manifolds*, vol. 583. Springer Berlin, 1977.

- [12] KAWAGUCHI, A., AND TANDAI, K. On areal spaces i. *Tensor NS 1* (1950), 14–45.
- [13] LÓPEZ BARRAGAN, A. M., AND SÁNCHEZ, H. M. S. Sectional anosov flows: Existence of venice masks with two singularities. *Bulletin of the Brazilian Mathematical Society, New Series 48*, 1 (2017), 1–18.
- [14] METZGER, R., AND MORALES, C. A. Sectional-hyperbolic systems. *Ergodic Theory and Dynamical Systems 28*, 05 (2008), 1587–1597.
- [15] MORALES, C. Singular-hyperbolic attractors with handlebody basins. *Dyn. Control Syst. 13*, 1, 15–24.
- [16] MORALES, C. A. Examples of singular-hyperbolic attracting sets. *Dynamical Systems 22*, 3 (2007), 339–349.
- [17] MORALES, C. A. Sectional-anosov flows. *Monatshefte für Mathematik 159*, 3 (2010), 253–260.
- [18] MORALES, C. A., AND PACÍFICO, M. J. Sufficient conditions for robustness of attractors. *Pacific journal of mathematics 216*, 2 (2004), 327–342.
- [19] MORALES, C. A., AND PACÍFICO, M. J. A spectral decomposition for singular-hyperbolic sets. *Pacific Journal of Mathematics 229*, 1 (2007), 223–232.
- [20] MORALES, C. A., PACÍFICO, M. J., AND PUJALS, E. R. Robust transitive singular sets for 3-flows are partially hyperbolic attractors or repellers. *Annals of mathematics* (2004), 375–432.
- [21] MORALES, C. A., AND VILCHES, M. On 2-riemannian manifolds. *SUT J. Math. 46*, 1 (2010), 119–153.
- [22] REIS, J. Infinitude de órbitas periódicas para fluxos seccional anosov. *Tese de Doutorado, UFRJ* (2011).
- [23] SMALE, S. Differentiable dynamical systems. *Bulletin of the American mathematical Society 73*, 6 (1967), 747–817.

S. Bautista.

Departamento de Matemáticas, Universidad Nacional de Colombia.

Bogotá, Colombia.

E-mail: sbautistad@unal.edu.co

A. M. López B.

Instituto de Ciências Exatas (ICE), Universidade Federal Rural do Rio de Janeiro.

Departamento de Matemática, Seropédica, Brazil.

E-mail: barragan@im.ufrj.br

H. M. Sánchez.

Departamento de Matemáticas, Universidad Central.

Bogotá, Colombia.

E-mail: hmsanchezs@unal.edu.co