

Structural Characteristics of Two-Sender Index Coding

Coding

Chandra Thapa¹, Lawrence Ong², Sarah J. Johnson², and Min Li³

¹CSIRO Data61, Australia; ²The University of Newcastle, Australia; ³Zhejiang University, China

Abstract

This paper studies index coding with two senders. In this setup, source messages are distributed among the senders possibly with common messages. In addition, there are multiple receivers, with each receiver having some messages a priori, known as side-information, and requesting one unique message such that each message is requested by only one receiver. Index coding in this setup is called two-sender unicast index coding (TSUIC). The main goal is to find the shortest aggregate normalized codelength, which is expressed as the optimal broadcast rate. In this work, firstly, for a given TSUIC problem, we form three independent sub-problems each consisting of the only subset of the messages, based on whether the messages are available only in one of the senders or in both senders. Then we express the optimal broadcast rate of the TSUIC problem as a function of the optimal broadcast rates of those independent sub-problems. In this way, we discover the structural characteristics of TSUIC. For the proofs of our results, we utilize confusion graphs and coding techniques used in single-sender index coding. To adapt the confusion graph technique in TSUIC, we introduce a new graph-coloring approach that is different from the normal graph coloring, which we call two-sender graph coloring, and propose a way of grouping the vertices to analyze the number of colors used. We further determine a class of TSUIC instances where a certain type of side-information can be removed without affecting their optimal broadcast rates. Finally, we generalize the results of a class of TSUIC problems to multiple senders.

Index Terms

Index coding; multi-sender index coding; confusion graphs; graph coloring; optimal broadcast rate; network coding

This work is supported by the Australian Research Council under Grant FT140100219 and Grant DP150100903.

arXiv:1711.08150v2 [cs.IT] 19 Jun 2019

I. INTRODUCTION

Consider a communication scenario over a noiseless channel where a sender is required to broadcast messages to multiple receivers, each caching some messages requested by other receivers a priori. The messages cached at each receiver is known as its *side-information*. In this scenario, if the sender is informed about the side-information available at all receivers, then it can leverage that information whilst encoding to reduce the required number of broadcast transmissions, in comparison with a naive approach of transmitting all requested messages uncoded and separately. Such an encoding process is called index coding, and the resulting sequence of coded messages is known as an index code. Moreover, each receiver upon receiving the index code will be able to decode its required message by utilizing its side-information. The main aim of index coding is to find the optimal (shortest) codelength and the corresponding coding scheme. Index coding was introduced by Birk and Kol [1], [2], and further studied in subsequent works [3]–[13].

Most existing works on index coding deal only with a single sender, capturing scenarios with centralized transmissions. However, many communication scenarios such as the following have messages distributed among multiple senders:

- Macro-cell networks with caching helpers [14] — cellular networks deploying dedicated nodes, called helpers, with large storage capacity instead of femto-cell access points to reduce backhaul loads,
- cooperative data exchange [15] — peer-to-peer networks with data exchange within a group of closely-located wireless nodes, and
- distributed storage — storage networks where data are distributed over multiple storage devices/locations.

In addition, each sender can be constrained to know only a subset of the total messages due to reasons such as limited storage, or error whilst receiving some messages over noisy channels, or server failure to deliver all messages. In this case, distributed transmissions are required, where multiple senders broadcast messages to the receivers. One metric to maximize the transmission efficiency in this scenario is to minimize the aggregate number of transmissions from all senders in such a way that all receivers' demands can be fulfilled. As this problem is more general than an index-coding problem with a single sender and is of practical interest (e.g., reducing delay in content delivery, and energy efficient broadcasting), it is a useful research avenue to study index-coding problems with multiple senders, known as multi-sender index-coding problems.

A. *Prior works*

The multi-sender index-coding problem was first studied by Ong et al. [16]. They considered the problems where multiple senders are connected to receivers via noiseless broadcast links (orthogonal to each other) with flexible capacities. In their setup, each sender knows only a subset of the messages; each receiver knows only one message requested by some receiver a priori, but may request multiple messages; also, one message is known to only one receiver. For this setup, they aimed to characterize the optimal aggregate codelengths, also known as the optimal broadcast rates, of the problems. This problem formulation model is called *broadcast-rate formulation* of the problems. In their work, they devised lower and upper bounds on the optimal broadcast rate by implementing a graph-theoretic approach. The results were established using *information-flow graphs*, which represent receivers' request, and *message graphs*, which represent senders' message setting. Furthermore, they showed problem instances for which the upper and lower bounds coincide. A class of such instances is where no two senders have messages in common.

In another work, Thapa et al. [17] considered a model similar to Ong et al. [16] but with the *unicast* message setting, meaning each message is requested by only one receiver, each receiver requests only one message, and each receiver knows a subset of messages requested by other receivers a priori. Based on graph-theoretic approaches, they established upper bounds on the optimal broadcast rate. In particular, they focused on the two-sender case, called two-sender unicast index coding (TSUIC). They extended existing single-sender index-coding schemes, namely the cycle-cover scheme [18], [19], the clique-cover scheme [1], [2] and the local-chromatic scheme [10] to the corresponding schemes in TSUIC.

Sadeghi et al. [20] considered multi-sender index-coding problems where the senders are connected to receivers via noiseless broadcast links of arbitrary but fixed capacities. They aimed to characterize the closure of the set of all achievable rate¹ tuples of messages, known as the capacity region. They devised inner bounds on the capacity region using random-coding approaches (which requires infinitely long messages), and outer bounds using Shannon-type inequalities. In particular, the first general inner bound was attained by a partitioned distributed-composite-coding scheme, built on the single-sender composite-coding scheme (an existing single-sender scheme that is based on a random-coding approach [7]). This scheme was further

¹The rate of a message is the number of message bits per encoded/broadcast bits.

enhanced to a fractional distributed-composite-coding scheme by Liu et al. [21]. Preliminary and improved polymatroidal outer bounds were also developed in the work by Sadeghi et al. [20] and Liu et al. [21], respectively. As a result, the capacity region was established for all problem instances up to 3 receivers, and the sum capacity is established for all instances with 4 receivers and with unit link capacity from each sender. Independent of and in parallel with the work by Liu et al. [21], Li et al. [22], [23] introduced new techniques of joint link-and-sender partitioning and cooperative compression of composite messages and developed a multi-sender cooperative composite-coding scheme. In a recent work by Li et al. [24], a new rank-minimization framework for multiple-sender index coding with the unicast message setting, i.e., MSUIC, was developed on the classic single-sender minrank concept. The framework enabled the authors to establish the optimal broadcast rate for all critical MSUIC instances up to four receivers. In addition, they presented a heuristic algorithm to study MSUIC instances with more receivers.

Wan et al. [25] introduced *decentralized data shuffling* problems in which the receivers/workers can communicate with one another via a shared link. The decentralized data shuffling phase with uncoded storage (which stores a subset of bits of the data set) is equivalent to a multi-sender index coding problem. For this problem, they proposed converse and achievable bounds that are to within a factor of $3/2$ of one another. Moreover, the proposed schemes were shown to be optimal for some classes of the problem. Recently, Porter et al. [26] introduced a special case of multi-sender index coding, called *embedded index coding* (EIC), in which each node acts as both sender and receiver. With the help of several results, they showed the relationship between single-sender index coding and EICs. Furthermore, they developed heuristics to solve EIC problems efficiently.

B. Our work and contributions

Different approaches have been attempted to solve the multi-sender index-coding problems. However, the problems are more difficult and computationally complex than their single-sender counterparts, and we know very little about the characteristics of the problems. This paper studies the broadcast-rate formulation of TSUIC problems by implementing a graph-theoretic approach. More precisely, in the same spirit of studying structural properties of index-coding capacity in the single-sender case by Arbabjolfaei et al. [8], we examine the structural characteristics of TSUIC problems. This kind of study embraces the "divide-and-conquer" approach and provides us an insight into the problems where we can solve a larger problem by solving its smaller

sub-problems. Note that in the work by Arbabjolfaei et al. [8], [27], the capacity region of a given single-sender index-coding problem is shown to be a simple function of the capacity regions of its independent sub-problems by generalizing the notion of lexicographic graph product. In the TSUIC setup, due to the distributed message setting among senders, we cannot directly implement the notion of graph products and the existing approaches of single-sender index coding. In this work, we consider interactions between three independent sub-problems at a time in the TSUIC setup. By applying the notion of *confusion graphs* in index coding [28] along with the introduction of a two-sender graph coloring and a code-forming technique, we bound the optimal broadcast rate in both asymptotic and non-asymptotic regimes, and show it to be tight for some classes of TSUIC instances. Moreover, even for the single-sender cases, the non-asymptotic cases (especially index coding in non-linear finite fields) are less explored. For an index coding instance in the unicast message setting and the non-asymptotic regime in the message size, our techniques in this paper can be used to upper bound the optimal broadcast rate of this instance by a function of the optimal broadcast rates of its sub-instances in single-sender unicast index coding.

The contributions of this paper are summarized as follows:

- 1) **Proposing a new coloring concept for confusion graphs in TSUIC, called two-sender graph coloring (Definition 8, Section IV-C):** For SSUIC, the chromatic number of its confusion graph gives the optimal broadcast rate and the corresponding index code (for a specific message size). However, for TSUIC, as the two senders (encoders) contain some messages in common, the standard method of graph coloring of the confusion graph may not lead us to an index code. In this regard, we need a different kind of coloring function in TSUIC, and thus, in this paper, we propose a novel coloring technique to color the confusion graphs in TSUIC, and its optimization gives the optimal broadcast rate and optimal index code.
- 2) **Presenting a way of grouping the vertices of confusion graphs in TSUIC (Appendix B):** By exploiting the symmetry of the confusion graph, we propose a way of grouping its vertices for analysis purposes mainly in its two-sender graph coloring. In particular, this grouping helps us to analyze the number of colors used in two-sender graph coloring of a confusion graph.
- 3) **Deriving the optimal broadcast rates of TSUIC problems as a function of the optimal broadcast rates of its sub-problems (Theorem 4–8):** We divide a TSUIC problem into

three independent sub-problems based on the requested messages by receivers, specifically whether the messages are present in only one of the senders or in both senders. Now in TSUIC, considering the interactions (defined by side-information available at the receivers) between these three independent sub-problems, we derive the optimal broadcast rate (in both asymptotic and non-asymptotic regimes in the message size) of the problem as a function of the optimal broadcast rates of its sub-problems. Moreover, we bound the optimal broadcast rate, and show that the bounds are tight for several classes of TSUIC instances (sometimes with conditions). Furthermore, we find a class of TSUIC instances where a TSUIC scheme can achieve the same optimal broadcast rate as the same instances when the two senders form a single sender having all messages.

- 4) **Characterizing a class of TSUIC instances where a certain type of side-information is not critical (Corollary 1):** For a class of TSUIC instances, we prove that certain interactions between the three independent sub-problems can be removed without affecting the optimal broadcast rate (in the asymptotic regime). This means that those interactions are not *critical*.
- 5) **Generalizing the results of some classes of TSUIC problems to multiple senders (Section VI):** For some classes of TSUIC problems, we generalize the two-sender graph coloring of confusion graphs and the proposed grouping of their vertices. Then we compute the optimal broadcast rates of those problems as a function of the optimal broadcast rates of their sub-problems.

After posting the first draft of this paper [29] on Arxiv, this work had led to the following works in TSUIC. Arunachala et al. [30], [31] claimed that they derived the optimal linear broadcast rates of classes of TSUIC problems as a function of their sub-problems by analyzing special matrices and linear code constructions. In another work by Arunachala et al. [32], the optimal asymptotic broadcast rates (asymptotic in the message size) of TSUIC problems were derived as a function of their sub-problems with fully-participated interactions. They affirmed that for some classes of TSUIC problems, the upper bounds of the optimal broadcast rates presented in our paper are tight. For their results, they used a similar graph-based technique as presented in our first draft ([29]). In this paper, we consider general broadcast rates (which includes both linear and non-linear broadcast rates) for both asymptotic and non-asymptotic regimes in the message size.

II. PROBLEM DEFINITIONS AND GRAPHICAL REPRESENTATION

A. Problem setup

In this paper, we consider unicast index coding. There are N independent messages $\mathcal{M} = \{x_1, x_2, \dots, x_N\}$, where $x_i \in \{0, 1\}^t$ for all $i \in \{1, 2, \dots, N\}$ and some integer $t \geq 1$, i.e., each message consists of t binary bits. There are N receivers $\{1, 2, \dots, N\}$, where each receiver $r \in \{1, 2, \dots, N\}$ requests a message x_r , and has an ordered² set $\mathcal{H}_r \subseteq \mathcal{M} \setminus \{x_r\}$ of messages as its side-information a priori. This paper deals with the following two types of unicast index coding (UIC) based on the number of senders: (i) Single-sender unicast index coding (SSUIC) — it has only one sender, denoted S , having all N messages \mathcal{M} , and (ii) two-sender unicast index coding (TSUIC) — it has two senders, denoted by S_1 and S_2 , having (ordered) message sets $\mathcal{M}_1 \subseteq \mathcal{M}$ and $\mathcal{M}_2 \subseteq \mathcal{M}$, respectively, such that $\mathcal{M}_1 \cup \mathcal{M}_2 = \mathcal{M}$ (i.e., each message is available at some sender(s)). In other words, the total messages are distributed over the two senders in TSUIC. Figure 1 illustrates an example of TSUIC problems with four receivers.

Given an index-coding problem, a two-sender index code is defined as follows:

Definition 1 (Two-sender index code): A two-sender index code $(\{\mathcal{F}_s\}, \{\mathcal{G}_r\})$, for $s \in \{1, 2\}$, $r \in \{1, 2, \dots, N\}$, is defined by

- (i) an encoding function for each sender S_s , $\mathcal{F}_s : \{0, 1\}^{|\mathcal{M}_s| \times t} \rightarrow \{0, 1\}^{p_s}$ such that $\mathcal{C}_s = \mathcal{F}_s(\mathcal{M}_s)$, and
- (ii) a decoding function for every receiver r , $\mathcal{G}_r : \{0, 1\}^{(\sum_{s=1}^2 p_s + |\mathcal{H}_r| \times t)} \rightarrow \{0, 1\}^t$ such that $x_r = \mathcal{G}_r(\mathcal{C}_1, \mathcal{C}_2, \mathcal{H}_r)$.

This means each sender S_s encodes its known messages to a p_s -bit sub-codeword, for some non-negative integer p_s . We assume that each receiver r receives sub-codewords from both senders without any noise, and decodes x_r from the received sub-codewords and \mathcal{H}_r . The sub-codewords $(\mathcal{C}_1, \mathcal{C}_2)$ form an index code in TSUIC.

Now we define the aggregate normalized codelength, which measures the performance of a code $(\mathcal{C}_1, \mathcal{C}_2)$, in the following.

Definition 2 (Broadcast rate or aggregate normalized codelength): The broadcast rate of an index code (with a single sender or two senders) is the total number of transmitted bits (if two senders, then it is a sum of transmitted bits by both senders) per received message bit. In TSUIC,

²The elements are ordered in increasing indices.

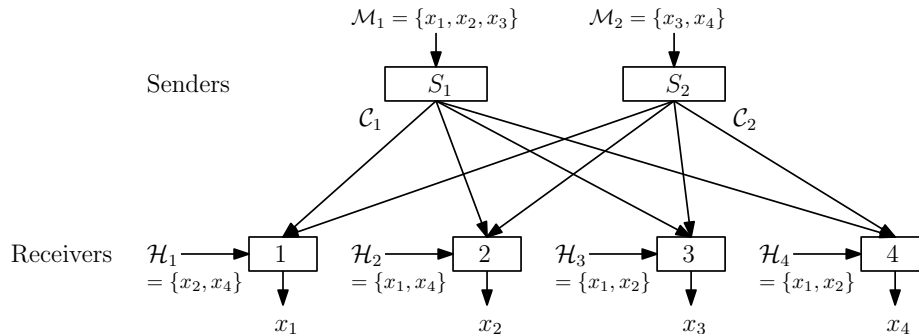

Fig. 1. An example of a TSUIC problem with four receivers: The total message set $\mathcal{M} = \mathcal{M}_1 \cup \mathcal{M}_2$ is distributed among two senders S_1 and S_2 . Each sender is connected to all receivers via a noiseless broadcast channel. Each receiver, $r \in \{1, 2, 3, 4\}$, having some side-information represented by a set \mathcal{H}_r , requests a unique message x_r . We assume that each sender S_s , $s \in \{1, 2\}$, is broadcasting a sub-codeword \mathcal{C}_s of length $|\mathcal{C}_s|$, and they cooperate with each other to reduce their aggregate transmissions. Precisely, we aim to find a two-sender index code with the minimum sum of lengths $|\mathcal{C}_1| + |\mathcal{C}_2|$.

it is denoted by $\ell_{\text{TSUIC}} \triangleq \frac{(p_1+p_2)}{t}$ for an index code $(\{\mathcal{F}_s\}, \{\mathcal{G}_r\})$. The broadcast rate is also referred to as the aggregate normalized codeword length of the index code. We say that ℓ is *achievable* for a UIC problem if there exists an index code of normalized length ℓ .

For the rest of the paper, we refer to normalized codeword length simply as codeword length.

Definition 3 (Optimal broadcast rate): The optimal broadcast rate for a given index-coding problem with t -bit messages is $\beta_t \triangleq \min_{\mathcal{E}} \ell$, where $\mathcal{E} = \mathcal{F}$ for SSUIC and $\mathcal{E} = \{\mathcal{F}_s\}$ for TSUIC. The optimal broadcast rate over all t is defined as $\beta \triangleq \inf_t \beta_t = \lim_{t \rightarrow \infty} \beta_t$. The limit exists and is equal to the infimum due to the subadditivity of $t\beta_t = p_1 + p_2$ and Fekete's lemma [33].

Remark 1: With the (optimal) broadcast rate as a performance metric, we can treat SSUIC as a special case of TSUIC when $\mathcal{M}_1 = \mathcal{M}$ or $\mathcal{M}_2 = \mathcal{M}$. Furthermore, for this case, the sender with \mathcal{M} alone will be responsible for fulfilling the demands made by all receivers.

B. Representation of the receivers' side-information and the senders' message setting in TSUIC problems

An index-coding problem can be modeled by graphs, which are defined as follows:

Definition 4 (Directed graphs and undirected graphs): A directed graph is an ordered pair $D = (V(D), A(D))$, where $V(D)$ is a set of vertices, and $A(D)$, usually called an arc set, is a set of ordered pairs of vertices. An undirected graph is an ordered pair $G = (V(G), E(G))$, where $V(G)$ is a set of vertices, and $E(G)$, usually called an edge set, is a set of unordered pairs of vertices.

From now on in this paper, we call directed graphs simply digraphs, and undirected graphs simply graphs.

The receivers' message setting of a UIC problem is represented by a side-information digraph $D = (V(D), A(D))$, where $V(D) = \{1, 2, \dots, N\}$ represents the N receivers, and the arc set $A(D)$ represents the side-information available at each receiver. More precisely, an arc $(i, j) \in A(D)$ exists from vertex i to vertex j if and only if receiver i has message x_j (the message requested by receiver j) in its side-information. So, in a side-information digraph, $\mathcal{H}_i \triangleq \{x_j : j \in N_D^+(i)\}$, where $N_D^+(i)$ is the out-neighborhood of a vertex i in D . In this paper, for convenience, a receiver i is also referred to as a vertex i , and vice versa. We also use the compact form of representation of an instance of UIC problems as used by Arbabjolfaei et al. [7], where a sequence $(i|N_D^+(i))$, for all $i \in V(D)$, represents a UIC problem.

In TSUIC, S_1 (sender one) encodes the messages in \mathcal{M}_1 , and S_2 (sender two) encodes the messages in \mathcal{M}_2 . In general, each sender has *private messages* and *common messages* defined as follows: Let $\mathcal{P}_1 \triangleq \mathcal{M}_1 \setminus \mathcal{M}_2$ and $\mathcal{P}_2 \triangleq \mathcal{M}_2 \setminus \mathcal{M}_1$ be the set of private messages at senders S_1 and S_2 , respectively, and $\mathcal{P}_3 \triangleq \mathcal{M}_1 \cap \mathcal{M}_2$ be the set of common messages at both senders. Now for a given side-information digraph D , without loss of generality, we define the following sub-digraphs induced by the following vertex subsets that partition $V(D)$: For $i \in \{1, 2, 3\}$, let D_i be the sub-digraph of D induced by vertices $\{j : x_j \in \mathcal{P}_i\}$. We refer to D_1 , D_2 and D_3 as per this definition throughout this paper unless stated otherwise. From the definition, it is clear that D_1 , D_2 and D_3 are the three sub-digraphs of D such that $V(D) = V(D_1) \cup V(D_2) \cup V(D_3)$ and $V(D_i) \cap V(D_k) = \emptyset$ for any $i \neq k$, $i, k \in \{1, 2, 3\}$. In TSUIC, the senders are limited to transmit only their messages, and this limitation is defined formally as a constraint due to the two senders as follows:

Definition 5 (Constraint due to the two senders): The constraint due to the two senders is the following: Whilst encoding, any two private messages $x_i \in \mathcal{P}_1$ and $x_j \in \mathcal{P}_2$ should not be encoded together (with or without other messages) to construct one coded symbol, or alternatively any two-sender index code can be written as $(\mathcal{C}_1, \mathcal{C}_2)$ such that $\mathcal{C}_1 = \mathcal{F}_1(\mathcal{M} \setminus \mathcal{P}_2)$ and $\mathcal{C}_2 = \mathcal{F}_2(\mathcal{M} \setminus \mathcal{P}_1)$.

In TSUIC, to reflect the senders' message setting, we introduce an undirected graph, denoted by $G_o = (V(G_o), E(G_o))$, that is constructed in the following way: (i) $V(G_o) = V(D)$, and (ii) for all $i, j \in V(G_o)$, an undirected arc, i.e., an edge $(i, j) \in E(G_o)$ exists if and only if $x_i \in \mathcal{P}_1$ and $x_j \in \mathcal{P}_2$, or vice versa. This means, there is an edge connecting two vertices in

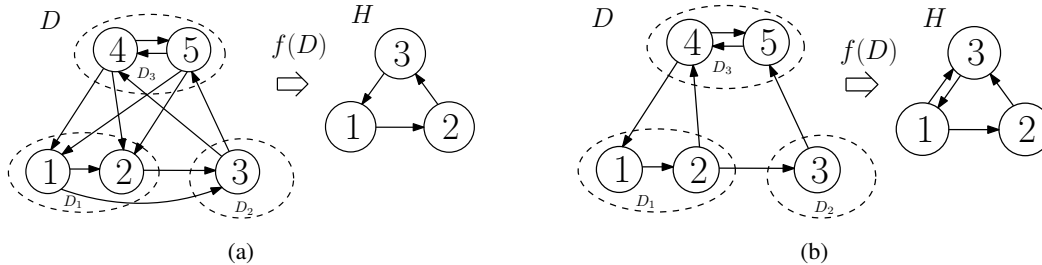

Fig. 2. (a) An example of the fully participated interaction between D_1 , D_2 and D_3 of a side-information digraph D along with the digraph H (having three vertices) obtained by mapping D by the function f , and (b) an example of the partially participated interaction between D_1 , D_2 and D_3 of another side-information digraph D along with the digraph H obtained by mapping D by the function f .

G_o if and only if no sender has both the corresponding messages. We call the graph G_o the *sender-constraint* graph.

As a TSUIC problem is described by D and G_o , it is represented by (D, G_o) in this paper. For a given (D, G_o) , let $\ell(D, G_o)$ denote the index codelength, $\beta_t(D, G_o)$ and $\beta(D, G_o)$ represent the optimal broadcast rate for a fixed t , and over all t , respectively. $\ell(D)$, $\beta_t(D)$ and $\beta(D)$ are the respective terms used for single-sender problems.

III. A NEW WAY OF CLASSIFYING TSUIC PROBLEMS AND THE MAIN RESULTS

In a TSUIC problem, if there is no common message, i.e., $\mathcal{P}_3 = \emptyset$, then in our earlier work, we have proved that the problem is equivalent to two separate SSUIC problems ([17, Theorem 1]). However, if $\mathcal{P}_3 \neq \emptyset$, then the problem is less well understood. We propose to tackle this problem by dividing it into three sub-problems based on the type of messages at the senders (whether they are common or private), and then study the interactions among these sub-problems due to the side-information present at the receivers. In this way, we can devise the structural characteristics of TSUIC problems. For a given problem D , three sub-problems based on the type of messages are D_1 , D_2 and D_3 . The side-information present at receivers of one sub-problem about messages requested by receivers of other sub-problems are formally referred to as an interaction between those sub-problems, defined in the following. We will see that this allows us to derive $\beta_t(D, G_o)$ in terms of the single-sender characterizations $\{\beta_t(D_i) : i \in \{1, 2, 3\}\}$ for a number of TSUIC instances.

1) *Interactions between D_1 , D_2 and D_3* : Arcs between $V(D_1)$, $V(D_2)$ and $V(D_3)$, each originating from some vertices of $V(D_i)$, $i \in \{1, 2, 3\}$, and terminating at some vertices of

$V(D) \setminus V(D_i)$ in D are called an interaction between D_1 , D_2 and D_3 . It is called a *fully-participated* interaction between D_1 , D_2 and D_3 if and only if we have the following: If there exists an arc from a vertex of D_i to a vertex of D_j for any $i, j \in \{1, 2, 3\}, i \neq j$, then $V(D_j) \subseteq N_D^+(r)$ for every $r \in V(D_i)$. In other words, all the vertices of the sub-digraph D_i interact in the same way to all the vertices of the sub-digraph D_j . For an example of a fully-participated interaction see Figure 2a. If an interaction between the sub-digraphs is not a fully-participated interaction, then it is called a *partially-participated* interaction among the sub-digraphs of the digraph. For example of a partially-participated interaction see Figure 2b. For the sub-digraphs of D , if some vertices in $V(D_i)$ have out-going arcs to some vertices in $V(D_j)$, $i \neq j$, $i, j \in \{1, 2, 3\}$, then it is denoted as $D_i \rightarrow D_j$. If we write $D_i \rightleftarrows D_j$, then it means $D_i \rightarrow D_j$ and $D_j \rightarrow D_i$. These representations are used for the indication of interaction, which does not explicitly specify the type of interactions.

2) *A compact representation of interactions:* For simplicity, an interaction between the sub-digraphs D_1 , D_2 and D_3 of D can be viewed as an interaction between three vertices, where each vertex represents one of the sub-digraphs. In this regard, we define a function that maps a digraph D (with its sub-digraphs D_1 , D_2 and D_3) to a digraph having three vertices, denoted H , in the following: $f : D \rightarrow H$ such that (i) all the vertices in $V(D_i)$ are mapped to a single vertex i of H , so $V(H) = \{1, 2, 3\}$, and (ii) $(i, j) \in A(H)$ if and only if there exist an arc $(u, v) \in A(D)$ for some $u \in V(D_i)$ and some $v \in V(D_j)$. For example see Figure 2. By referring to the definition of the fully or partially participated interaction, one can find that for a given D_1 , D_2 and D_3 of D , we can retrieve D by observing $f(D)$ if D has a fully-participated interaction among the sub-digraphs, but this is not true if D has a partially-participated interaction among the sub-digraphs. Observe that for any D , $D_i \rightarrow D_j$, if and only if $i \rightarrow j$ in $f(D)$ (i.e., H).

3) *A classification of the interactions:* Considering the digraph H , we get a total of 64 possible cases of the orientation of arcs among its vertices. As the vertices 1 and 2 of H can be swapped because we can interchange D_1 and D_2 (by swapping the labels of the senders), we get 36 unique cases (out of 64 cases) of interactions between the vertices of H . Now depending upon the type of orientation of arcs among the vertices of H , we classify all unique cases into two categories: (i) CASE I — Acyclic orientation (14 cases in total), and (ii) CASE II — with some cyclic orientation (22 cases). CASE II is further classified into smaller sub-cases II-A, II-B, II-C, and II-D. Refer to Figure 3 for details, where each digraph of H is labeled H_i for $i \in \{1, 2, \dots, 36\}$. Note that an interaction between D_1 , D_2 and D_3 of D defines arcs between

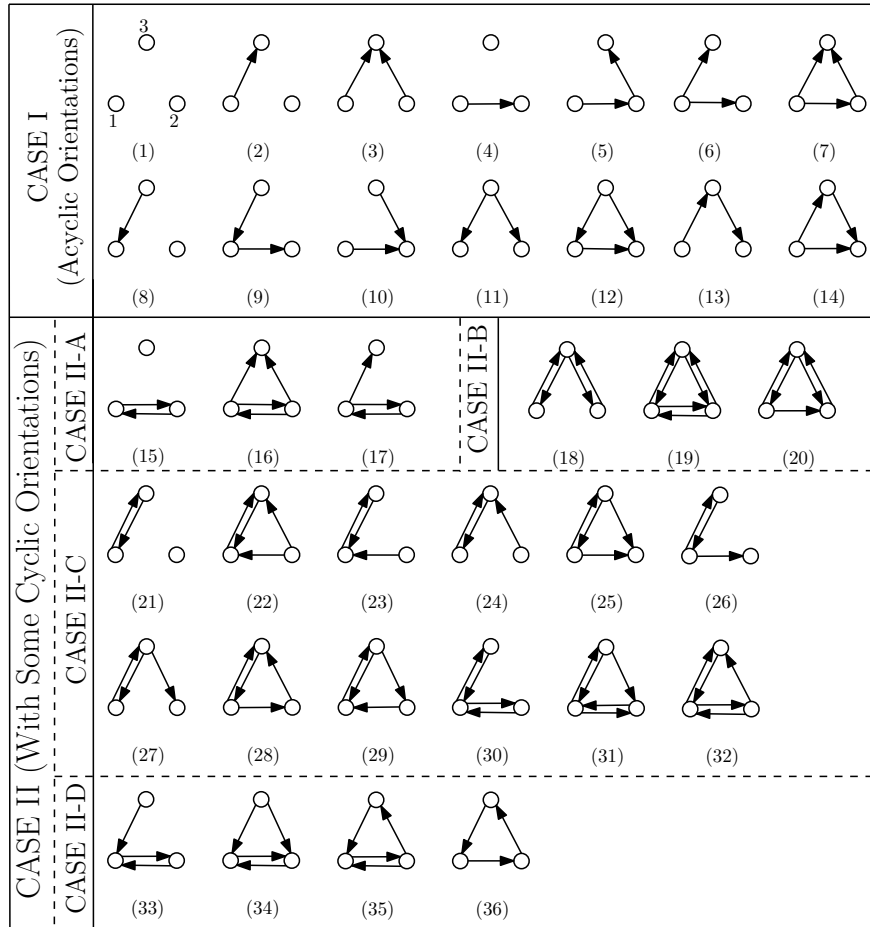

Fig. 3. All unique interactions among the vertices of H . The digraph of a number i is labeled by H_i , $i \in \{1, 2, \dots, 36\}$. For example, the digraph of the number 30 is labeled H_{30} .

them (not within the sub-digraph), and the cases of interactions (acyclic or cyclic) are defined with respect to the orientation of the arcs between the sub-digraphs. In this paper, a fully-participated interaction and a partially-participated interaction between D_1 , D_2 and D_3 of D are called a *cyclic-fully-participated* interaction and a *cyclic-partially-participated* interaction between the sub-digraphs, respectively, if and only if $f(D)$ has some cycles (for example, see CASE II in Figure 3).

4) *Main results:* For SSUIC, Arbabjolfaei and Kim [8, Prop. 1] argued that using structural properties can reduce the number of problems that need to be studied. This paper investigates the structural characteristics of TSUIC problems for the same purpose by studying the interactions among D_1 , D_2 and D_3 of D . Moreover, structural properties can be used to determine the criticality/non-criticality of arcs in TSUIC as in its SSUIC counterpart [9], [34]. An arc is said

TABLE I

SUMMARY OF THE RESULTS FOR ANY D WITH FULLY-PARTICIPATED INTERACTIONS BETWEEN D_1 , D_2 AND D_3 IN TSUIC.

| $f(D)$ | | $\beta(D, G_o)$ | $\beta_t(D, G_o)$ |
|-----------|-------------------|--|--|
| CASE I | $H_1 - H_7$ | $\beta(D_1) + \beta(D_2) + \beta(D_3) = \beta(D)$ (Theorem 4) | $\beta_t(D_1) + \beta_t(D_2) + \beta_t(D_3) + \epsilon/t, \epsilon \in \{-2, -1, 0\}$ (Theorem 5) |
| | $H_8 - H_{14}$ | | |
| CASE II-A | $H_{15} - H_{17}$ | $\beta(D_1) + \beta(D_2) + \beta(D_3)$ (Theorem 5) | $\beta_t(D_1) + \beta_t(D_2) + \beta_t(D_3) + \epsilon/t, \epsilon \in \{-2, -1, 0\}$ (Theorem 5) |
| CASE II-B | $H_{18} - H_{20}$ | $\max\{\beta(D_3), \beta(D_1) + \beta(D_2)\}$ (Theorem 6) | $\max\{\beta_t(D_3), \beta_t(D_1) + \beta_t(D_2)\}$ (Theorem 6) |
| CASE II-C | $H_{21} - H_{32}$ | $\beta(D_2) + \max\{\beta(D_1), \beta(D_3)\}$ (Proposition 2) | $\begin{cases} \leq \beta_t(D_2) + \max\{\beta_t(D_1), \beta_t(D_3)\} \\ = \beta_t(D_1) + \beta_t(D_2), \text{ if } \beta_t(D_1) \geq \beta_t(D_3) \end{cases}$ (Theorem 7) |
| CASE II-D | $H_{33} - H_{36}$ | $\begin{cases} \leq \max\{\beta(D_1), \beta(D_3)\} + \max\{\beta(D_2), \beta(D_3)\} \\ = \beta(D_1) + \beta(D_2), \text{ if } \beta(D_3) \leq \min\{\beta(D_1), \beta(D_2)\} \end{cases}$ (Theorem 8) | $\begin{cases} \leq \max\{\beta_t(D_1), \beta_t(D_3)\} + \max\{\beta_t(D_2), \beta_t(D_3)\} \\ = \beta_t(D_1) + \beta_t(D_2), \text{ if } \beta_t(D_3) \leq \min\{\beta_t(D_1), \beta_t(D_2)\} \end{cases}$ (Theorem 8) |

to be critical if removing the arc strictly increases the optimal broadcast rate.

This paper analyzes all cases of fully-participated and some cases of partially-participated interactions between D_1 , D_2 and D_3 of D , and establishes their optimal broadcast rates ($\beta(D, G_o)$ and $\beta_t(D, G_o)$) as a function of the optimal broadcast rates of D_1 , D_2 and D_3 for TSUIC. For fully-participated interactions, the results are summarized in Table I. Furthermore, similar results are presented for D whose $f(D)$ is of CASE I and Case II-A, and it has partially-participated interactions between the sub-digraphs (refer to Theorem 4 and Theorem 5). The results are established by utilizing existing SSUIC's results and our proposed coloring of confusion graphs for TSUIC, which we discuss in the subsequent sections.

IV. CONFUSION GRAPHS AND THEIR COLORING

A. Confusion graphs

For an index-coding problem modeled by a side-information digraph D with N vertices, two realizations of N messages, say, $u^N = (u_1, u_2, \dots, u_N)$ and $v^N = (v_1, v_2, \dots, v_N)$, are said to be confusable at a vertex (receiver) $r \in \{1, 2, \dots, N\}$, if $u_r \neq v_r$ and $u_i = v_i$ for all $i \in N_D^+(r)$, where, by definition, $u_j, v_j \in \{0, 1\}^t$ for all $j \in \{1, 2, \dots, N\}$. We say that two tuples are confusable if they are confusable at some receiver r . Clearly, in an index coding, we cannot encode message tuples that are confusable to the same codeword; otherwise one of the receivers may not always decode its requested message successfully. The confusability among all possible N -tuples of messages (each message having t bits) for an index-coding problem is represented by a graph called a *confusion graph*, defined as follows:

Definition 6 (Confusion graph): The confusion graph, denoted $\Gamma_t(D) = (V(\Gamma_t(D)), E(\Gamma_t(D)))$, of a side-information digraph D with N vertices and t -bit messages is an undirected graph with the following:

- (i) $V(\Gamma_t(D)) = \{u^N : u^N \in \{0, 1\}^{t \times N}\}$, and
- (ii) $E(\Gamma_t(D)) = \{(u^N, v^N) : u^N, v^N \in V(\Gamma_t(D)), \text{ and } u^N \text{ and } v^N \text{ are confusable}\}$.

B. A review of confusion graph coloring for SSUIC

Before proposing a notion of coloring for TSUIC, we first recall the standard definition of the graph coloring in the following:

Definition 7 (Graph coloring and Chromatic number): A proper graph coloring of a graph G is an onto function $J : V(G) \rightarrow \mathcal{J}$, where \mathcal{J} is a set of colors, in such a way that if i and j are adjacent vertices of G , then $J(i) \neq J(j)$. The minimum number of colors over all possible proper coloring of a graph G is called the chromatic number of G , and it is denoted by $\chi(G)$.

Consider coloring a confusion graph $\Gamma_t(D)$ with a set of colors \mathcal{J} . Now we get a family of *sets of independent vertices* where all vertices belonging to one set are assigned with the same color in the graph coloring. Here a set of independent vertices refers to a vertex set where any pair of vertices are not connected by an edge in $\Gamma_t(D)$, and we call such a set an *independent vertex set*. The tuples representing vertices within an independent vertex set are not confusable, and hence they can be coded into the same codeword. Assigning each independent vertex set (whose vertices are all colored by a unique color) a unique codeword provides us a valid index

code having $|\mathcal{J}|$ codewords. Thus there exists a bijective mapping $I : \mathcal{J} \rightarrow \mathcal{C}$, where \mathcal{C} is an index code (or a set of codewords that satisfies the demands made by all receivers). We know that $\chi(\Gamma_t(D)) = \min_j |\mathcal{J}|$. In SSUIC, it is shown that the optimal broadcast rate of an index-coding problem D with t -bit messages can be obtained by using confusion graphs. This is stated in the following theorem.

Theorem 1: (Alon et al. [28, Th. 1.1], Arbabjolfaei and Kim [8, Prop. 1]) The optimal broadcast rate for a SSUIC problem with t -bit messages is

$$\beta_t(D) = \frac{\lceil \log_2 \chi(\Gamma_t(D)) \rceil}{t}. \quad (1)$$

The notion of confusion graphs has been considered in the index coding literature, and it has been shown to be an effective tool for proving important results, for example, Bar-Yossef et al. [3], Alon et al. [28], and Arbabjolfaei et al. [8] in their respective works, referred to the confusion graph for the proof of results related to the odd hole and the odd anti-hole [3], the gap between β and $\beta_{t=1}$ of hypergraphs [28], and the structural properties of the index-coding problems [8], respectively.

C. Proposed confusion graph coloring for TSUIC

The confusion graph, which is only a function of the side-information graph, does not depend on the number of senders. Its coloring function described above for SSUIC may not lead to an index code for TSUIC because of the constraint due to the two senders. In this work, we propose a way of coloring the confusion graphs in TSUIC, which we call two-sender graph coloring. Before presenting a formal definition, we first define some notations that will be used in the remainder of this paper, unless stated otherwise.

- 1) Without loss of generality, we assume x_1, x_2, \dots, x_{n_1} to be the messages requested by vertices in $V(D_1)$, $x_{n_1+1}, x_{n_1+2}, \dots, x_{n_1+n_2}$ the messages requested by vertices in $V(D_2)$, and $x_{n_1+n_2+1}, x_{n_1+n_2+2}, \dots, x_{n_1+n_2+n_3}$ the messages requested by vertices in $V(D_3)$ with $N = n_1 + n_2 + n_3$.
- 2) Indices $i, i_1, i_2 \in \{1, 2, \dots, 2^{tn_1}\}$, $j, j_1, j_2 \in \{1, 2, \dots, 2^{tn_2}\}$ and $k, k_1, k_2 \in \{1, 2, \dots, 2^{tn_3}\}$ are used in the representation of possible realizations of words of tn_1 , tn_2 and tn_3 bits, respectively. For convenience, we use three indices (e.g., i, i_1, i_2) for the same set of numbers, where the first index (e.g., i) is used for a general case, and the remaining two indices (e.g., i_1 and i_2) are used to indicate any two words within the group of words.

- 3) We group the bits associated with the messages requested by vertices of $D_{i'}$, $i' \in \{1, 2, 3\}$. Within each group, each realization of the bits, i.e., each member in $\{0, 1\}^{tn_{i'}}$ is represented by a unique label $\mathbf{b}_{D_{i'}}^{j'}$, $j' \in \{1, 2, \dots, 2^{tn_{i'}}\}$. The Figure 10a in Appendix A outlines each tuple $\mathbf{b}_{D_{i'}}^{j'}$ for $t = 1$. Each message tuple (x_1, \dots, x_N) realization can then be uniquely written as $(\mathbf{b}_{D_1}^i, \mathbf{b}_{D_2}^j, \mathbf{b}_{D_3}^k)$ for some i, j, k .

Definition 8 (Two-sender graph coloring of $\Gamma_t(D)$): Let two onto functions $J_1 : \{0, 1\}^{tn_1} \times \{0, 1\}^{tn_3} \rightarrow \mathcal{J}_1$, and $J_2 : \{0, 1\}^{tn_2} \times \{0, 1\}^{tn_3} \rightarrow \mathcal{J}_2$ be the coloring functions carried out by senders S_1 and S_2 , respectively. A proper two-sender graph coloring of $\Gamma_t(D)$ is an onto function $J_o : \{0, 1\}^{tn_1} \times \{0, 1\}^{tn_2} \times \{0, 1\}^{tn_3} \rightarrow \mathcal{J}_1 \times \mathcal{J}_2$ where $J_o((\mathbf{b}_{D_1}^i, \mathbf{b}_{D_2}^j, \mathbf{b}_{D_3}^k)) = (J_1(\mathbf{b}_{D_1}^i, \mathbf{b}_{D_3}^k), J_2(\mathbf{b}_{D_2}^j, \mathbf{b}_{D_3}^k))$ such that if $(\mathbf{b}_{D_1}^{i_1}, \mathbf{b}_{D_2}^{j_1}, \mathbf{b}_{D_3}^{k_1})$ and $(\mathbf{b}_{D_1}^{i_2}, \mathbf{b}_{D_2}^{j_2}, \mathbf{b}_{D_3}^{k_2})$ are adjacent vertices of $\Gamma_t(D)$, then $J_o((\mathbf{b}_{D_1}^{i_1}, \mathbf{b}_{D_2}^{j_1}, \mathbf{b}_{D_3}^{k_1})) \neq J_o((\mathbf{b}_{D_1}^{i_2}, \mathbf{b}_{D_2}^{j_2}, \mathbf{b}_{D_3}^{k_2}))$.

Remark 2: The two-sender graph coloring is not a b -fold coloring that assigns a set of b colors to each vertex such that the color sets corresponding to two adjacent vertices do not share any color (refer to the definition of the fractional graph coloring [8]). In our definition, the color sets can share colors, as long as the color vectors (i.e., ordered pairs) are different.

D. A few lemmas for the TSUIC confusion graph coloring

In the form of lemmas, we discuss two-sender graph coloring of $\Gamma_t(D)$ in detail. Before this, we first assume the following: For any indices i', j' , assume that $c_{i'}$ and $c_{j'}$ are any two distinct colors if $i' \neq j'$, and let $(c_{i'}, c_{j'})$ be an ordered pair of colors. Any two ordered pairs of colors, $(c_{i'_1}, c_{j'_1})$ and $(c_{i'_2}, c_{j'_2})$, are said to be different (or not equal) if and only if $i'_1 \neq i'_2$ or $j'_1 \neq j'_2$ or both. If a color $c_{i'}$ is associated to a sender S_s , $s \in \{1, 2\}$, then we denote it by $c_{i'}^s$.

In TSUIC, the two senders encode separately, so in the aforementioned definition, we need to assign an ordered pair of colors for each vertex, where the first color is associated with S_1 and the second color with S_2 . Now we have the following lemmas.

Lemma 1: For any two distinct vertices $u^N, v^N \in V(\Gamma_t(D))$ that are labeled by $(\mathbf{b}_{D_1}^{i_1}, \mathbf{b}_{D_2}^{j_1}, \mathbf{b}_{D_3}^{k_1})$ and $(\mathbf{b}_{D_1}^{i_2}, \mathbf{b}_{D_2}^{j_2}, \mathbf{b}_{D_3}^{k_2})$, respectively, if $(u^N, v^N) \in E(\Gamma_t(D))$, then we must have $J_o(u^N) = (c_{i_1}^1, c_{j_1}^2)$ and $J_o(v^N) = (c_{i_2}^1, c_{j_2}^2)$ such that $c_{i_1}^1 \neq c_{i_2}^1$ and $c_{j_1}^2 = c_{j_2}^2$ for some indices i'_1, i'_2, j'_1, j'_2 .

Proof: Since $(u^N, v^N) \in E(\Gamma_t(D))$, u^N and v^N are confusable. Moreover, these two tuples are confusable only at some vertex in $V(D_1)$. This is because the labels $(\mathbf{b}_{D_1}^{i_1}, \mathbf{b}_{D_2}^{j_1}, \mathbf{b}_{D_3}^{k_1})$ and $(\mathbf{b}_{D_1}^{i_2}, \mathbf{b}_{D_2}^{j_2}, \mathbf{b}_{D_3}^{k_2})$ of u^N and v^N , respectively, are different only in $\mathbf{b}_{D_1}^{i_1}$ sub-label (which is representing tn_1 -bit tuples of the messages requested by vertices in $V(D_1)$). Now for the sender

S_2 , which does not contain any message in \mathcal{P}_1 (messages requested by receivers in $V(D_1)$), the coloring function $J_2(\mathbf{b}_{D_2}^j, \mathbf{b}_{D_3}^k)$ provides the same color to both vertices. Thus $c_{j_1}^2 = c_{j_2}^2$. On the other hand, for the sender S_1 , which contains all messages in \mathcal{P}_1 , it is necessary to have $J_1(\mathbf{b}_{D_1}^{i_1}, \mathbf{b}_{D_3}^k) \neq J_1(\mathbf{b}_{D_1}^{i_2}, \mathbf{b}_{D_3}^k)$ because these two tuples $(\mathbf{b}_{D_1}^{i_1}, \mathbf{b}_{D_3}^k)$ and $(\mathbf{b}_{D_1}^{i_2}, \mathbf{b}_{D_3}^k)$ are confusable given that $(\mathbf{b}_{D_1}^{i_1}, \mathbf{b}_{D_2}^j, \mathbf{b}_{D_3}^k)$ and $(\mathbf{b}_{D_1}^{i_2}, \mathbf{b}_{D_2}^j, \mathbf{b}_{D_3}^k)$ are confusable at some receiver in $V(D_1)$. Thus $c_{i_1}^1 \neq c_{i_2}^1$. ■

In a similar reasoning as in the above proof (of Lemma 1), one can prove the following lemma:

Lemma 2: For any two distinct vertices, $u^N, v^N \in V(\Gamma_t(D))$ such that they are labeled by $(\mathbf{b}_{D_1}^i, \mathbf{b}_{D_2}^{j_1}, \mathbf{b}_{D_3}^k)$ and $(\mathbf{b}_{D_1}^i, \mathbf{b}_{D_2}^{j_2}, \mathbf{b}_{D_3}^k)$, respectively, if $(u^N, v^N) \in E(\Gamma_t(D))$, then we must have $J_o(u^N) = (c_{i_1}^1, c_{j_1}^2)$ and $J_o(v^N) = (c_{i_2}^1, c_{j_2}^2)$ such that $c_{i_1}^1 = c_{i_2}^1$ and $c_{j_1}^2 \neq c_{j_2}^2$ for some indices i_1', i_2', j_1', j_2' .

If u^N and v^N are confusable at some vertices in $V(D_1)$ and in $V(D_2)$, then referring to Lemma 1 and 2, we get the following:

Lemma 3: For any two distinct vertices, $u^N, v^N \in V(\Gamma_t(D))$ such that they are labeled by $(\mathbf{b}_{D_1}^{i_1}, \mathbf{b}_{D_2}^{j_1}, \mathbf{b}_{D_3}^k)$ and $(\mathbf{b}_{D_1}^{i_2}, \mathbf{b}_{D_2}^{j_2}, \mathbf{b}_{D_3}^k)$, respectively, if $(u^N, v^N) \in E(\Gamma_t(D))$ due to confusion at some vertices in $V(D_1)$ and in $V(D_2)$, then we must have $J_o(u^N) = (c_{i_1}^1, c_{j_1}^2)$ and $J_o(v^N) = (c_{i_2}^1, c_{j_2}^2)$ such that $c_{i_1}^1 \neq c_{i_2}^1$ and $c_{j_1}^2 \neq c_{j_2}^2$ for some indices i_1', i_2', j_1', j_2' .

If u^N and v^N are confusable at some vertices in $V(D_3)$, then whilst coloring $\Gamma_t(D)$ in two-sender graph coloring, it suffices to have a different color associated with any one of the senders because all the messages in \mathcal{P}_3 are contained by both senders S_1 and S_2 . Thus we have the following lemma:

Lemma 4: For any two vertices, $u^N, v^N \in V(\Gamma_t(D))$ such that they are labeled by $(\mathbf{b}_{D_1}^i, \mathbf{b}_{D_2}^j, \mathbf{b}_{D_3}^{k_1})$ and $(\mathbf{b}_{D_1}^i, \mathbf{b}_{D_2}^j, \mathbf{b}_{D_3}^{k_2})$, respectively, if $(u^N, v^N) \in E(\Gamma_t(D))$, then we have $J_o(u^N) = (c_{i_1}^1, c_{j_1}^2)$ and $J_o(v^N) = (c_{i_2}^1, c_{j_2}^2)$ such that either $c_{i_1}^1 \neq c_{i_2}^1$, or $c_{j_1}^2 \neq c_{j_2}^2$, or both.

V. THE OPTIMAL BROADCAST RATE FOR TSUIC

For a TSUIC problem with t -bit messages, we have the following theorem:

Theorem 2: The optimal broadcast rate for a TSUIC problem with t -bit messages is

$$\beta_t(D, G_o) = \min_{J_1, J_2} \frac{\lceil \log_2 |\mathcal{J}_1| \rceil + \lceil \log_2 |\mathcal{J}_2| \rceil}{t}. \quad (2)$$

Proof: For $s \in \{1, 2\}$, consider J_s , a coloring function of the sender S_s , with a set of colors \mathcal{J}_s . A two-sender index code is obtained by S_1 mapping distinct colors in \mathcal{J}_1 to distinct

sub-codewords, and S_2 mapping distinct colors in \mathcal{J}_2 to distinct sub-codewords. By definition, all confusable vertex pairs are assigned different codewords. Now for $s \in \{1, 2\}$, the sender S_s transmits $|\mathcal{J}_s|$ sub-codewords. Equivalently, $\lceil \log_2 |\mathcal{J}_s| \rceil$ bits are transmitted by S_s . This is because the number of bits required to index $|\mathcal{J}_s|$ colors are $\lceil \log_2 |\mathcal{J}_s| \rceil$. Minimizing the sum $(\lceil \log_2 |\mathcal{J}_1| \rceil + \lceil \log_2 |\mathcal{J}_2| \rceil)$ over all coloring functions J_1 (of S_1) and J_2 (of S_2) per received message bits (i.e., t), we get

$$\beta_t(D, G_o) \leq \min_{J_1, J_2} \frac{\lceil \log_2 |\mathcal{J}_1| \rceil + \lceil \log_2 |\mathcal{J}_2| \rceil}{t}. \quad (3)$$

From the definition of $\beta_t(D, G_o)$, we have $\beta_t(D, G_o) = \min_{\mathcal{E}} \frac{p_1 + p_2}{t}$, so there exists a two-sender index code such that S_1 and S_2 transmit p'_1 -bit and p'_2 -bit sub-codewords, respectively, resulting in

$$\beta_t(D, G_o) = \frac{p'_1 + p'_2}{t}. \quad (4)$$

Now for each sender S_s , we know that there are at most $2^{p'_s}$ possible sub-codewords. Consider a bijective function that maps each sub-codeword to a color. A valid code must translate to a valid two-sender graph coloring. So, there exists a valid two-sender graph coloring such that $|\mathcal{J}'_1| \leq 2^{p'_1}$ and $|\mathcal{J}'_2| \leq 2^{p'_2}$, or equivalently, $p'_1 \geq \lceil \log_2 |\mathcal{J}'_1| \rceil$ and $p'_2 \geq \lceil \log_2 |\mathcal{J}'_2| \rceil$ as both are non-negative integers. Substituting the inequalities of p'_1 and p'_2 in (4), we get

$$\beta_t(D, G_o) \geq \frac{\lceil \log_2 |\mathcal{J}'_1| \rceil + \lceil \log_2 |\mathcal{J}'_2| \rceil}{t}. \quad (5)$$

Now we prove equality in (3). This is done by contradiction. Suppose that

$$\beta_t(D, G_o) < \min_{J_1, J_2} \frac{\lceil \log_2 |\mathcal{J}_1| \rceil + \lceil \log_2 |\mathcal{J}_2| \rceil}{t}. \quad (6)$$

From (5) and (6), we get

$$\frac{\lceil \log_2 |\mathcal{J}'_1| \rceil + \lceil \log_2 |\mathcal{J}'_2| \rceil}{t} < \min_{J_1, J_2} \frac{\lceil \log_2 |\mathcal{J}_1| \rceil + \lceil \log_2 |\mathcal{J}_2| \rceil}{t}, \quad (7)$$

and this leads to a contradiction. Thus $\beta_t(D, G_o) = \min_{J_1, J_2} \frac{\lceil \log_2 |\mathcal{J}_1| \rceil + \lceil \log_2 |\mathcal{J}_2| \rceil}{t}$. ■

We illustrate two-sender graph coloring of a confusion graph in TSUIC, and a mapping function that maps colors to codewords at each sender from the following example.

Example 1: Consider a TSUIC problem (D, G_o) of the following: $(1|2), (2|1), (3|1)$, and $\mathcal{M}_1 = \{1, 3\}$, $\mathcal{M}_2 = \{2, 3\}$ with $t = 1$. The problem is depicted in Figure 4a. We have $V(D_1) = \{1\}$, $V(D_2) = \{2\}$, $V(D_3) = \{3\}$, and $N = 3$. The confusion graph $\Gamma_1(D)$ has $2^N = 8$ vertices labeled by all possible realizations of a word with three bits. In $\Gamma_1(D)$, any two

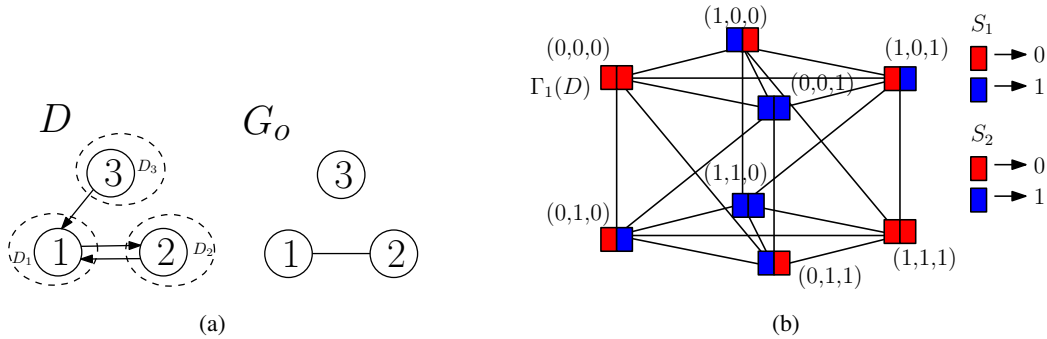

Fig. 4. (a) A TSUIC problem (D, G_o) , and (b) the confusion graph $\Gamma_1(D)$, and its two-sender graph coloring.

vertices are connected by an edge if the message tuples labeling the vertices are confused at some receiver. For example, $(0, 0, 0)$ and $(1, 0, 0)$ are connected by an edge because these two message tuples are confused at receiver 1. The confusion graph $\Gamma_1(D)$ is depicted in Figure 4b. Now we perform two-sender graph coloring of the vertices of $\Gamma_1(D)$. In two-sender graph coloring, each vertex of $\Gamma_1(D)$ is assigned with an ordered pair of colors; the first color is always associated with S_1 and the second color is always associated with S_2 , and we color the vertices as dictated by Lemma 1 to Lemma 4. For example, consider $(0, 0, 0)$ and $(1, 0, 0)$. These two tuples are confused at receiver 1 (requesting x_1). As S_2 , which does not know x_1 , the tuples $(0, 0, 0)$ and $(1, 0, 0)$, which have the same second and third message bits, are treated as the same. Thus S_2 must assign the same color, say RED, to both the tuples. As S_1 knows x_1 and the tuples are confusable at receiver 1, it must assign two different colors, say RED and BLUE, to $(0, 0, 0)$ and $(1, 0, 0)$, respectively. In a similar way, we assign ordered pairs of colors to all vertices of $\Gamma_1(D)$ as shown in Figure 4b. Altogether, one can get $\mathcal{J}_1 = \{\text{RED}, \text{BLUE}\}$ and $\mathcal{J}_2 = \{\text{RED}, \text{BLUE}\}$. Now we assume a mapping function that maps RED to 0 and BLUE to 1. So, we get $(0, 0, 0) \rightarrow 00$, $(1, 0, 0) \rightarrow 10$, $(0, 1, 0) \rightarrow 01$ and so on for the remaining tuples (vertices of $\Gamma_t(D)$). Thus $\{00, 10, 01, 11\}$ are codewords of a valid two-sender index code for (D, G_o) , where each sender transmits a 1-bit sub-codeword for a message tuple, and the sum of bits to be transmitted by the two senders is two for each message tuple. Consequently, $\beta_t(D, G_o) \leq 2$. Each sender has one private message, and that must be transmitted by that sender, so there must be at least one transmission by that sender. Thus $\beta_t(D, G_o) \geq 2$. Altogether, we get $\beta_t(D, G_o) = 2$.

A. Lower Bounds

For any D , we have $\beta(D) \leq \beta_t(D)$ for all t (by definition). Since any index code for (D, G_o) is also an index code for D , but the converse is not always true, so we have the following:

Lemma 5 (A simple lower bound): For any D and G_o , $\beta(D, G_o) \geq \beta(D)$.

In TSUIC, each sender S_s transmits at least $\beta(D_s)$, for $s \in \{1, 2\}$. We now provide a lower bound of the optimal broadcast rate for a TSUIC problem with t -bit messages in the following lemma.

Lemma 6 (A lower bound): For any two-sender index-coding problem (D, G_o) , $\beta_t(D, G_o) \geq \beta_t(D_1) + \beta_t(D_2)$, and $\beta(D, G_o) \geq \beta(D_1) + \beta(D_2)$.

Proof: For any two-sender index-coding problem (D, G_o) , let (D', G'_o) be its sub-problem induced by vertices $V(D_1) \cup V(D_2)$. Observe that $V(D') \cap V(D_3) = \emptyset$. Now we have $\beta_t(D', G'_o) = \beta_t(D_1) + \beta_t(D_2)$ ([17, Th. 1]). For any index-coding problem, its broadcast rate is always lower bounded by the broadcast rate of any sub-problem, so we get

$$\beta_t(D, G_o) \geq \beta_t(D', G'_o) = \beta_t(D_1) + \beta_t(D_2). \quad (8)$$

We know that $\lim_{t \rightarrow \infty} \beta_t(D_1) = \beta(D_1)$, $\lim_{t \rightarrow \infty} \beta_t(D_2) = \beta(D_2)$ and $\beta(D, G_o) = \lim_{t \rightarrow \infty} \beta_t(D, G_o)$ (by Definition 3). Now taking a limit $t \rightarrow \infty$ on both sides in (8), we get

$$\beta(D, G_o) \geq \beta(D_1) + \beta(D_2). \quad (9)$$

■

To compute the simple lower bound to the optimal broadcast rate of a given problem in TSUIC, we utilize the following SSUIC results by Arbabjolfaei and Kim [8, Prop. 3, Th. 2, Th. 3].

Theorem 3: In SSUIC, for a side-information digraph D having two sub-digraphs D_a and D_b induced by vertices $V(D_a)$ and $V(D_b)$, respectively, such that $V(D_a) \cup V(D_b) = V(D)$ and $V(D_a) \cap V(D_b) = \emptyset$, we have

- (i) $\beta(D) = \beta(D_a) + \beta(D_b)$ if there is (i) no interaction between D_a and D_b (i.e., no $D_a \rightarrow D_b$ and $D_b \rightarrow D_a$), or (ii) a one way interaction (either partially or fully participated) between D_a and D_b , i.e., either $D_a \rightarrow D_b$ or $D_b \rightarrow D_a$, but not both and
- (ii) $\beta(D) = \max\{\beta(D_a), \beta(D_b)\}$ if there is a fully participated both way interaction between D_a and D_b (i.e., fully participated $D_a \rightleftarrows D_b$).

B. Optimal broadcast rates for CASE I and CASE II-A: The arcs between D_1 , D_2 and D_3 are not critical in asymptotic regime in the message size.

For a digraph D whose $f(D)$ belongs to a digraph of CASE I and CASE II-A (see Figure 3), we have the following results.

Theorem 4 (CASE I): For any D having any interaction (i.e., either fully participated or partially participated) between its sub-digraphs D_1 , D_2 and D_3 , if $f(D) \in \{H_1, H_2, \dots, H_{14}\}$ (i.e., a digraph H of CASE I in Figure 3), then $\beta(D, G_o) = \beta(D_1) + \beta(D_2) + \beta(D_3) = \beta(D)$.

Proof: Referring to the definition of the mapping function f (in Section III), we know that for any D if $f(D) \in \{H_1, H_2, \dots, H_{14}\}$, then the interaction between D_1 , D_2 and D_3 of D are acyclic. Thus one can arrange D_1 , D_2 and D_3 in a sequence such that there is no arc between D_1 , D_2 and D_3 in a backward direction. Without loss of generality, let the sequence be D_1 , D_2 and D_3 . Now for D , referring to Theorem 3, we get

$$\beta(D) = \beta(D_1 \cup D_2) + \beta(D_3) = \beta(D_1) + \beta(D_2) + \beta(D_3). \quad (10)$$

From Lemma 5, we have

$$\beta(D, G_o) \geq \beta(D). \quad (11)$$

Now from (10) and (11), we get

$$\beta(D, G_o) \geq \beta(D_1) + \beta(D_2) + \beta(D_3). \quad (12)$$

In TSUIC, if we consider the sub-digraphs D_1 , D_2 and D_3 separately, then their respective source constraint graphs are the sub-graphs of G_0 induced by vertices $V(D_1)$, $V(D_2)$ and $V(D_3)$, denoted G_0^1 , G_0^2 and G_0^3 , respectively. These sub-graphs are edgeless graphs, and thus one can get $\beta(D_1, G_0^1) = \beta(D_1)$, $\beta(D_2, G_0^2) = \beta(D_2)$ and $\beta(D_3, G_0^3) = \beta(D_3)$. We know that the optimal broadcast rate of a side-information digraph is always less than or equal to the sum of the optimal broadcast rates of its sub-digraphs, so

$$\begin{aligned} \beta(D, G_o) &\leq \beta(D_1, G_0^1) + \beta(D_2, G_0^2) + \beta(D_3, G_0^3) \\ &\leq \beta(D_1) + \beta(D_2) + \beta(D_3). \end{aligned} \quad (13)$$

From (10), (12) and (13), we get $\beta(D, G_o) = \beta(D_1) + \beta(D_2) + \beta(D_3) = \beta(D)$. ■

Example 2: Consider a TSUIC problem of the following: (1) , $(2|1, 4, 5)$, $(3|1, 2, 4, 5)$, $(4|1, 5)$, $(5|1, 4)$, and $\mathcal{M}_1 = \{1, 4, 5\}$, $\mathcal{M}_2 = \{1, 2, 3\}$. We compute its $\beta(D, G_o)$ using Theorem 4. Refer to Figure 5 for details.

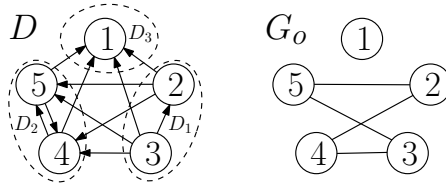

Fig. 5. A given side-information digraph D such that $f(D) = H_7$, and a source-constraint graph G_o (for $\mathcal{M}_1 = \{1, 2, 3\}$ and $\mathcal{M}_2 = \{1, 4, 5\}$). Moreover, we have $V(D_1) = \{2, 3\}$, $V(D_2) = \{4, 5\}$ and $V(D_3) = \{1\}$. From Theorem 4, we get $\beta(D, G_o) = \beta(D) = \beta(D_1) + \beta(D_2) + \beta(D_3) = 2 + 1 + 1 = 4$. It is not difficult to observe that a two-sender index code $\{x_1, x_2, x_3, x_4 \oplus x_5\}$, that is obtained by transmitting x_1, x_2, x_3 from S_1 , and $x_4 \oplus x_5$ from S_2 , achieves the optimal broadcast rate both in TSUIC and SSUIC.

Proposition 1: For any D having a fully-participated interaction between its sub-digraphs D_1 , D_2 and D_3 , if $f(D) \in \{H_1, H_{16}\}$, then $\beta_t(D, G_o) = \beta_t(D_1) + \beta_t(D_2) + \beta_t(D_3) + \epsilon/t$ for some $\epsilon \in \{-2, -1, 0\}$.

Proof: Refer to Appendix C ■

Remark 3: The proof of the Proposition 1 is based on the analysis of the confusion graph $\Gamma_t(D)$ and its coloring. This is described in section IV. As a confusion graph possesses some symmetry within — in fact, all confusion graphs are vertex-transitive³ — whilst analyzing them (especially coloring), we systematically group its vertices and then analyze the graph based on these groups (rather than individual vertices). This way, for a TSUIC problem whose sub-problems interact with each other in some way, we can reduce the complexity arising during its analysis (especially finding the number of colors in a proper coloring of $\Gamma_t(D)$) due to the number of vertices, which is exponential in t and N . The proposed grouping of the vertices of the confusion graph and its characteristics are stated in Appendix B.

Theorem 5 (CASE I & CASE II-A): For any D having any interaction (i.e., either fully participated or partially participated) between its sub-digraphs D_1 , D_2 and D_3 , if $f(D) \in \{H_1, H_2, \dots, H_{17}\} \setminus \{H_8, H_9, \dots, H_{14}\}$, then $\beta_t(D, G_o) = \beta_t(D_1) + \beta_t(D_2) + \beta_t(D_3) + \epsilon/t$, where $\epsilon \in \{-2, -1, 0\}$, and $\beta(D, G_o) = \beta(D_1) + \beta(D_2) + \beta(D_3)$.

Proof: For convenience, let $D = D^i$ if $f(D) = H_i$. Now for D^i , $i \in \{1, 16\}$, with a

³An undirected graph G is vertex-transitive if for every pair $u, v \in V(G)$ there exists an automorphism mapping from u to v . In the automorphism mapping of all vertices in $V(G)$, the graph is mapped onto itself whilst preserving the connectivity of the vertices and edges.

fully-participated interaction between the sub-digraphs, we have the following from Proposition 1,

$$\beta_t(D^i, G_o) = \beta_t(D_1) + \beta_t(D_2) + \beta_t(D_3) + \epsilon/t, \quad (14)$$

for some $\epsilon \in \{-2, -1, 0\}$. For any D^i , $i \in \{1, 2, 3, \dots, 17\}$, having either a partially-participated or a fully-participated interaction between the sub-digraphs, we have the following observations: The interactions between the sub-digraphs (i.e., D_1 , D_2 and D_3) are equal to or more than that in D^1 , so

$$\beta_t(D^i, G_o) \leq \beta_t(D^1, G_o), \quad (15)$$

and equal to or fewer than that in D^{14} (with a fully-participated interaction between the sub-digraphs), so

$$\beta_t(D^i, G_o) \geq \beta_t(D^{14}, G_o). \quad (16)$$

Now from (14), (15) and (16), we get

$$\beta_t(D^i, G_o) = \beta_t(D, G_o) = \beta_t(D_1) + \beta_t(D_2) + \beta_t(D_3) + \epsilon/t, \quad (17)$$

where $\epsilon \in \{-2, -1, 0\}$ and $i \in \{1, 2, \dots, 17\} \setminus \{H_8, H_9, \dots, H_{14}\}$.

Now taking a limit $t \rightarrow \infty$ on both sides in (17), we get

$$\begin{aligned} \beta(D, G_o) &= \lim_{t \rightarrow \infty} \beta_t(D, G_o) = \lim_{t \rightarrow \infty} (\beta_t(D_1) + \beta_t(D_2) + \beta_t(D_3) + \epsilon/t) \\ &= \beta(D_1) + \beta(D_2) + \beta(D_3), \end{aligned} \quad (18)$$

where $\lim_{t \rightarrow \infty} \frac{\epsilon}{t} = 0$. ■

Remark 4: For any D having non-empty D_1 , D_2 and D_3 with fully-participated interactions between them such that $f(D) \in \{H_{15}, H_{16}, H_{17}\}$, in SSUIC, we have $\beta(D) = \beta(D_3) + \max\{\beta(D_1), \beta(D_2)\}$ by Theorem 3, however in TSUIC, $\beta(D)$, a lower bound to $\beta(D, G_o)$, is not achievable due to Theorem 5.

Corollary 1: For any D having any interaction (i.e., either fully participated or partially participated) between its sub-digraphs D_1 , D_2 and D_3 , if $f(D) \in \{H_1, H_2, \dots, H_{17}\}$, then the arcs (contributing to that interaction) between D_1 , D_2 and D_3 of D are not critical in TSUIC in the asymptotic regime in message size (considering infinitely long messages).

Proof: The proof follows from Theorem 4 and 5. ■

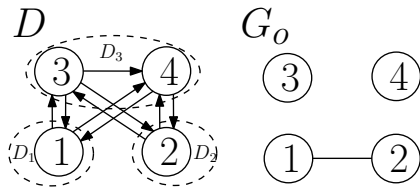

Fig. 6. A given side-information digraph D such that $f(D) = H_{18}$, and a source-constraint graph G_o . We have $V(D_1) = \{1\}$, $V(D_2) = \{2\}$ and $V(D_3) = \{3, 4\}$. From Theorem 6, we get $\beta(D, G_o) = 2$, and from Corollary 2, $\beta(D) = \beta(D, G_o) = 2$. It is not difficult to observe that a two-sender-index code $\{x_1 \oplus x_3, x_2 \oplus x_4\}$, that is obtained by transmitting $x_1 \oplus x_3$ and $x_2 \oplus x_4$ from sender 1 and sender 2, respectively, achieves its optimal broadcast rate both in TSUIC and SSUIC.

C. Optimal broadcast rates for CASE II-B

Theorem 6 (CASE II-B): For any D having a fully participated interaction between its sub-digraphs D_1 , D_2 and D_3 , and t -bit messages for any $t \geq 1$, if $f(D) \in \{H_{18}, H_{19}, H_{20}\}$, then $\beta_t(D, G_o) = \max\{\beta_t(D_3), \beta_t(D_1) + \beta_t(D_2)\}$ and $\beta(D, G_o) = \max\{\beta(D_3), \beta(D_1) + \beta(D_2)\}$.

Proof: Refer to Appendix D. ■

Corollary 2: For any D having a fully participated interaction between its sub-digraphs D_1 , D_2 and D_3 such that $f(D) \in \{H_{18}, H_{20}\}$, $\beta(D, G_o) = \beta(D)$.

Proof: The result follows from Theorem 3 and 6. ■

Remark 5: In TSUIC, for any D having a fully participated interaction between its non-empty sub-digraphs D_1 , D_2 and D_3 such that $f(D) = H_{19}$, no TSUIC scheme achieves $\beta(D)$ if $\beta(D_3) < \beta(D_1) + \beta(D_2)$ because $\beta(D) = \max\{\beta(D_1), \beta(D_2), \beta(D_3)\}$ (by Theorem 3) and $\beta(D, G_o)$ is at least $\beta(D_1) + \beta(D_2)$ (by Lemma 6).

Example 3: Consider a TSUIC problem of the following: $(1|3, 4)$, $(2|3, 4)$, $(3|1, 2, 4)$, $(4|1, 2)$, and $\mathcal{M}_1 = \{1, 3, 4\}$, $\mathcal{M}_2 = \{2, 3, 4\}$. We compute its $\beta(D, G_o)$ and $\beta_t(D, G_o)$ using Theorem 6. Refer to Figure 6 for details.

D. Optimal broadcast rates for CASE II-C: An upper bound, and special cases where the upper bound is tight

Theorem 7 (CASE II-C): For any D having a fully participated interaction between its sub-digraphs D_1 , D_2 and D_3 , and t -bit messages for any $t \geq 1$, if $f(D) \in \{H_{21}, H_{22}, \dots, H_{32}\}$, then

- (i) $\beta_t(D, G_o) \leq \beta_t(D_2) + \max\{\beta_t(D_1), \beta_t(D_3)\}$,
- (ii) $\beta_t(D, G_o) = \beta_t(D_1) + \beta_t(D_2)$ if $\beta_t(D_1) \geq \beta_t(D_3)$,

- (iii) $\beta(D, G_o) \leq \beta(D_2) + \max\{\beta(D_1), \beta(D_3)\}$, and
- (iv) $\beta(D, G_o) = \beta(D_1) + \beta(D_2)$ if $\beta(D_1) \geq \beta(D_3)$.

Proof: Refer to Appendix E. ■

Case (iii) in Theorem 7 can be strengthened as follows:

Proposition 2 (CASE II-C): For any D having a fully participated interaction between its sub-digraphs D_1 , D_2 and D_3 such that $f(D) \in \{H_{21}, H_{22}, \dots, H_{32}\}$, $\beta(D, G_o) = \beta(D_2) + \max\{\beta(D_1), \beta(D_3)\}$.

Proof: It follows from Theorem 7 that $\beta(D, G_o) = \beta(D_1) + \beta(D_2)$ if $\beta(D_1) \geq \beta(D_3)$, and for the case when $\beta(D_1) \leq \beta(D_3)$,

$$\beta(D, G_o) \leq \beta(D_2) + \beta(D_3). \quad (19)$$

For D whose $f(D) \in \{H_{21}, H_{22}, \dots, H_{32}\} \setminus \{H_{28}, H_{29}\}$ (all digraphs of CASE II-C except H_{28} and H_{29}), considering Theorem 3, we get $\beta(D) = \beta(D_2) + \beta(D_3)$ if $\beta(D_1) \leq \beta(D_3)$. As $\beta(D) \leq \beta(D, G_o)$ (Lemma 5), so

$$\beta(D, G_o) \geq \beta(D_2) + \beta(D_3). \quad (20)$$

The interaction among D_1 , D_2 and D_3 in D^{28} (that is, D where $f(D) = H_{28}$) is less than that in D^{32} . Thus,

$$\beta(D^{28}, G_o) \geq \beta(D^{32}, G_o). \quad (21)$$

From (20) and (21), we get

$$\beta(D^{28}, G_o) \geq \beta(D^{32}, G_o) \geq \beta(D_2) + \beta(D_3), \quad (22)$$

if $\beta(D_1) \leq \beta(D_3)$. Due to the similar aforementioned reasoning, we get

$$\beta(D^{29}, G_o) \geq \beta(D^{31}, G_o) \geq \beta(D_2) + \beta(D_3). \quad (23)$$

From (19), (20), (22) and (23), we get $\beta(D, G_o) = \beta(D_2) + \beta(D_3)$ if $\beta(D_1) \leq \beta(D_3)$ for any D with $f(D) \in \{H_{21}, H_{22}, \dots, H_{32}\}$. Altogether, $\beta(D, G_o) = \beta(D_2) + \max\{\beta(D_1), \beta(D_3)\}$. ■

Corollary 3: For any D having a fully participated interaction between its sub-digraphs D_1 , D_2 and D_3 such that $f(D) \in \{H_{21}, H_{22}, \dots, H_{27}\}$, $\beta(D, G_o) = \beta(D)$.

Proof: For the given digraph D , by applying Theorem 3, one can get $\beta(D) = \beta(D_2) + \max\{\beta(D_1), \beta(D_3)\}$, and this equals $\beta(D, G_o)$ by Proposition 2. ■

Corollary 4: For any D such that $f(D) \in \{H_{30}, H_{31}, H_{32}\}$,

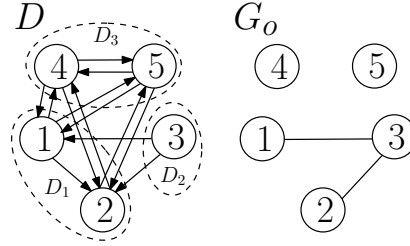

Fig. 7. (a) A given side-information digraph D such that $f(D) = H_{23}$, and a source-constraint graph G_o . We have $V(D_1) = \{1, 2\}$, $V(D_2) = \{3\}$, and $V(D_3) = \{4, 5\}$. From Theorem 7, we get $\beta(D, G_o) = 3$ and from Corollary 3, $\beta(D) = \beta(D, G_o) = 3$. It is not difficult to observe that a two-sender index code $\{x_1 \oplus x_4 \oplus x_5, x_2, x_3\}$, where $(x_1 \oplus x_4 \oplus x_5, x_2)$ and x_3 are transmitted by sender 1 and sender 2, respectively, achieves its optimal broadcast rate both in TSUIC and SSUIC.

- (i) if $\beta(D_1) \leq \beta(D_3)$, then $\beta(D, G_o) = \beta(D_2) + \beta(D_3) = \beta(D)$,
- (ii) if $\beta(D_1) > \beta(D_3)$, then
 - (a) if $\beta(D_1) \geq \beta(D_2) + \beta(D_3)$, then $\beta(D, G_o) = \beta(D_1) + \beta(D_2) \geq \beta(D_1) = \beta(D)$, with a strict inequality if D_2 is non-empty, and
 - (b) if $\beta(D_1) \leq \beta(D_2) + \beta(D_3)$, then $\beta(D, G_o) = \beta(D_1) + \beta(D_2) > \beta(D_2) + \beta(D_3) = \beta(D)$ for a non-empty D_2 .

Proof: If $\beta(D_1) \leq \beta(D_3)$, then $\beta(D_1) \leq \beta(D_3) + \beta(D_2)$. Now from Proposition 2 and Theorem 3, $\beta(D, G_o) = \beta(D_2) + \beta(D_3) = \beta(D)$. For the case $\beta(D_1) > \beta(D_3)$, the results directly follows from Proposition 2 and Theorem 3. \blacksquare

Remark 6: Let $D = D^i$ if $f(D) = H_i$. Now for any D such that $f(D) \in \{H_{28}, H_{29}\}$, we have the following if $\beta(D_1) \leq \beta(D_3)$:

- (i) $\{\beta(D^{32}, G_o) = \beta(D^{32}) = \beta(D_2) + \beta(D_3)\} \leq \beta(D^{28}) \leq \beta(D^{28}, G_o) \leq \{\beta(D^{26}) = \beta(D^{26}, G_o) = \beta(D_2) + \beta(D_3)\}$ from Proposition 2, Theorem 3, Corollary 3, Corollary 4, and Lemma 5. This implies $\beta(D^{28}) = \beta(D^{28}, G_o) = \beta(D_2) + \beta(D_3)$.
- (ii) $\{\beta(D^{31}, G_o) = \beta(D^{31}) = \beta(D_2) + \beta(D_3)\} \leq \beta(D^{29}) \leq \beta(D^{29}, G_o) \leq \{\beta(D^{27}) = \beta(D^{27}, G_o) = \beta(D_2) + \beta(D_3)\}$ from Proposition 2, Theorem 3, Corollary 3, Corollary 4, and Lemma 5. This implies $\beta(D^{29}) = \beta(D^{29}, G_o) = \beta(D_2) + \beta(D_3)$.

Example 4: Consider a TSUIC problem D of the following: $(1|2, 4, 5)$, $(2|4, 5)$, $(3|1, 2)$, $(4|1, 2, 5)$, $(5|1, 2, 4)$, and $\mathcal{M}_1 = \{1, 2, 4, 5\}$, $\mathcal{M}_2 = \{3, 4, 5\}$. We compute its $\beta(D, G_o)$ and $\beta_t(D, G_o)$ using Theorem 7. Refer to Figure 7 for details.

E. Optimal broadcast rates for CASE II-D

Theorem 8 (CASE II-D): For any D having a fully participated interaction between its sub-digraphs D_1 , D_2 and D_3 , and t -bit messages for any $t \geq 1$, if $f(D) \in \{H_{33}, H_{34}, H_{35}, H_{36}\}$, then

- (i) $\beta_t(D, G_o) \leq \max\{\beta_t(D_1), \beta_t(D_3)\} + \max\{\beta_t(D_2), \beta_t(D_3)\}$,
- (ii) $\beta_t(D, G_o) = \beta_t(D_1) + \beta_t(D_2)$ if $\beta_t(D_3) \leq \min\{\beta_t(D_1), \beta_t(D_2)\}$,
- (iii) $\beta(D, G_o) \leq \max\{\beta(D_1), \beta(D_3)\} + \max\{\beta(D_2), \beta(D_3)\}$, and
- (iv) $\beta(D, G_o) = \beta(D_1) + \beta(D_2)$ if $\beta(D_3) \leq \min\{\beta(D_1), \beta(D_2)\}$.

Proof: Refer to Appendix F. ■

Proposition 3: For any D having a fully participated interaction between its sub-digraphs D_1 , D_2 and D_3 such that $f(D) \in \{H_{33}, H_{34}\}$, $\beta(D, G_o) = \beta(D) = \beta(D_3) + \max\{\beta(D_1), \beta(D_2)\}$ if $\min\{\beta(D_1), \beta(D_2)\} \leq \beta(D_3) \leq \max\{\beta(D_1), \beta(D_2)\}$.

Proof: It follows from Theorem 8 that $\beta(D, G_o) \leq \max\{\beta(D_1), \beta(D_3)\} + \max\{\beta(D_2), \beta(D_3)\}$. So, considering $\min\{\beta(D_1), \beta(D_2)\} \leq \beta(D_3) \leq \max\{\beta(D_1), \beta(D_2)\}$, if $\beta(D_1) \geq \beta(D_2)$, then

$$\beta(D, G_o) \leq \beta(D_1) + \beta(D_3), \quad (24)$$

and if $\beta(D_2) \geq \beta(D_1)$, then

$$\beta(D, G_o) \leq \beta(D_2) + \beta(D_3). \quad (25)$$

From (24) and (25), we get

$$\beta(D, G_o) \leq \beta(D_3) + \max\{\beta(D_1), \beta(D_2)\}. \quad (26)$$

Now from Theorem 3, one can get $\beta(D) = \beta(D_3) + \max\{\beta(D_1), \beta(D_2)\}$. As $\beta(D) \leq \beta(D, G_o)$ (Lemma 5), we get

$$\beta(D, G_o) \geq \beta(D_3) + \max\{\beta(D_1), \beta(D_2)\}. \quad (27)$$

From (26) and (27), we get $\beta(D, G_o) = \beta(D_3) + \max\{\beta(D_1), \beta(D_2)\}$. ■

Now for UIC problems with more than two senders, we study some classes of interactions between the sub-digraphs of a digraph (representing the UIC problem) in the following sub-section.

VI. GENERALIZING THE RESULTS OF SOME CLASSES OF TSUIC PROBLEMS TO MULTIPLE SENDERS

In this section, we illustrate how the method proposed in this paper can be generalized to scenarios with more than two senders.

$$\begin{array}{|c|} \hline \text{---} \xrightarrow{(\mathbf{b}_{D_1}^1, \mathbf{b}_{D_2}^1, \mathbf{b}_{D_3}^1, \mathbf{b}_{D_4}^1)} \\ \hline \begin{array}{|c|c|} \hline 0,0,0,00 & 1,0,0,00 \\ \hline 0,0,1,00 & 1,0,1,00 \\ \hline 0,1,0,00 & 1,1,0,00 \\ \hline 0,1,1,00 & 1,1,1,00 \\ \hline \end{array} \\ \hline \end{array}$$

Fig. 8. Grouping of vertices in Block 1 of $\Gamma_1(D)$ for a SMSUIC with three senders having $\mathcal{M}_1 = \{x_1, x_4, x_5\}$, $\mathcal{M}_2 = \{x_2, x_4, x_5\}$, $\mathcal{M}_3 = \{x_3, x_4, x_5\}$, and $t = 1$.

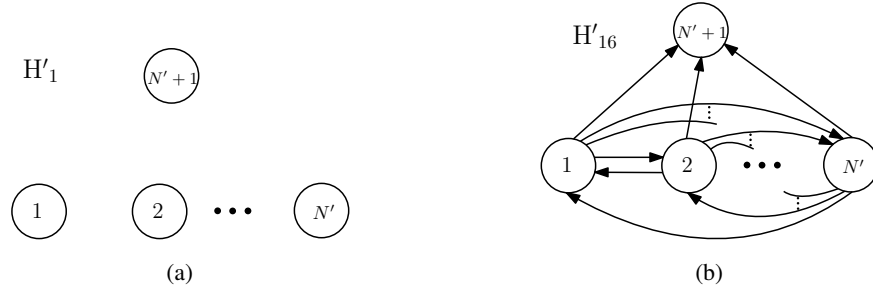

Fig. 9. Extension of (a) H_1 , and (b) H_{16} to SMSUIC.

Let N' be the number of senders, each with at least one private message. Clearly, $1 \leq N' \leq N$. In this section, we consider a special case of multi-sender unicast-index coding (MSUIC), where the only common messages are present in all N' senders and the rest are all private messages. We call this MSUIC special MSUIC (SMSUIC). Following the earlier convention of notations used in TSUIC, the set of common messages and its corresponding sub-problem are denoted by $\mathcal{P}_{N'+1}$ and $D_{N'+1}$, respectively. Precisely, for D , we have $N'+1$ sub-digraphs, where $D_1, D_2, \dots, D_{N'}$ are the vertex-induced sub-digraphs of D associated with vertices of those requesting the private messages, and $D_{N'+1}$ is associated with vertices of those requesting only common messages. In MSUIC, each vertex of $\Gamma_t(D)$ is labeled as $(\mathbf{b}_{D_1}^{i_1}, \mathbf{b}_{D_2}^{i_2}, \mathbf{b}_{D_3}^{i_3}, \dots, \mathbf{b}_{D_{N'}}^{i_{N'}}, \mathbf{b}_{D_{N'+1}}^k)$, where $i_j \in \{1, 2, \dots, 2^{tn_j}\}$ for $j \in \{1, 2, \dots, N'\}$ and $k \in \{1, 2, \dots, 2^{tn_{N'+1}}\}$.

Observe that the extensions of Definition 5 (including the sender-constraint graph, G_o), Definition 8, and Lemmas 1, 2, 3 & 4 to SMSUIC are straightforward. Similar to the proof of Theorem 2, one can prove the following in SMSUIC.

$$\beta_t(D, G_o) = \min_{J_1, J_2, \dots, J_{N'}} \frac{\lceil \log_2 |\mathcal{J}_1| \rceil + \lceil \log_2 |\mathcal{J}_2| \rceil + \dots + \lceil \log_2 |\mathcal{J}_{N'}| \rceil}{t}. \quad (28)$$

Now we extend the proposed grouping of the vertices of $\Gamma_t(D)$ to MSUIC (including SMSUIC).

Firstly, refer to Section IV and Appendix B for the notations, groupings and observations related to the vertices in any k -th block of $\Gamma_t(D)$ in TSUIC. We follow a similar way of grouping of vertices in MSUIC, where any k -th block of $\Gamma_t(D)$ has the following:

- 1) Vertices labeled by all $(\mathbf{b}_{D_1}^{i_1}, \mathbf{b}_{D_2}^{i_2}, \mathbf{b}_{D_3}^{i_3}, \dots, \mathbf{b}_{D_{N'}}^{i_{N'}}, \mathbf{b}_{D_{N'+1}}^k)$, $i_j \in \{1, 2, \dots, 2^{tn_j}\}$, $j \in \{1, 2, \dots, N'\}$ and $k \in \{1, 2, \dots, 2^{tn_{N'+1}}\}$, with the same $\mathbf{b}_{D_{N'+1}}^k$ sub-label,
- 2) any row sub-block consists of vertices labeled by all $(\mathbf{b}_{D_1}^{i_1}, \mathbf{b}_{D_2}^{i_2}, \mathbf{b}_{D_3}^{i_3}, \dots, \mathbf{b}_{D_{N'}}^{i_{N'}}, \mathbf{b}_{D_{N'+1}}^k)$, $i_j \in \{1, 2, \dots, 2^{tn_j}\}$, $j \in \{1, 2, \dots, N'\}$, with the same $\mathbf{b}_{D_2}^{i_2}, \mathbf{b}_{D_3}^{i_3}, \dots, \mathbf{b}_{D_{N'}}^{i_{N'}}, \mathbf{b}_{D_{N'+1}}^k$ sub-labels, and
- 3) any i_1 -th column sub-block consists of vertices labeled by all $(\mathbf{b}_{D_1}^{i_1}, \mathbf{b}_{D_2}^{i_2}, \mathbf{b}_{D_3}^{i_3}, \dots, \mathbf{b}_{D_{N'}}^{i_{N'}}, \mathbf{b}_{D_{N'+1}}^k)$, $i_j \in \{1, 2, \dots, 2^{tn_j}\}$, $j \in \{1, 2, \dots, N'\}$, with the same $\mathbf{b}_{D_1}^{i_1}$ and $\mathbf{b}_{D_{N'+1}}^k$ sub-labels. Moreover, in contrast to SSUIC, there are multiple sub-labels other than $\mathbf{b}_{D_1}^{i_1}$ and $\mathbf{b}_{D_{N'+1}}^k$ in MSUIC, so we arrange the vertices of any i_1 -th column sub-block as dictated by Figure 11 in Appendix A. Clearly, a block has 2^{tn_1} column sub-blocks and $2^{t(\sum_{i=2}^{N'} n_i)}$ row sub-blocks.

Now we illustrate the grouping of the vertices with an example. Assume that we have three senders S_1, S_2 and S_3 with $\mathcal{M}_1 = \{x_1, x_4, x_5\}$, $\mathcal{M}_2 = \{x_2, x_4, x_5\}$ and $\mathcal{M}_3 = \{x_3, x_4, x_5\}$. We get $N' = 3$, and $V(D_4) = \{4, 5\}$. For $x_i \in \{0, 1\}$, $i \in \{1, 2, 3, 4, 5\}$, we arrange the vertices of the first block as shown in Figure 8.

Based on our classification of interactions (referring to Figure 3), H_1 has no arc, and H_{16} has the following: Vertices 1 and 2, each has an out-degree of two, whereas the vertex 3 has zero out-degree. Now considering the interactions between the sub-digraphs $D_1, D_2, \dots, D_{N'}, D_{N'+1}$, the extensions of H_1 and H_{16} to SMSUIC are straightforward (refer to Figure 9). We labeled them by H'_1 and H'_{16} , respectively, in SMSUIC. Now we have the following proposition.

Proposition 4: For any D having a fully-participated interaction between its sub-digraphs $D_1, D_2, \dots, D_{N'}, D_{N'+1}$, if $f(D) \in \{H'_1, H'_{16}\}$, then $\beta_t(D, G_o) = \sum_{i=1}^{N'+1} \beta_t(D_i) + \epsilon/t$ for some $\epsilon \in \{-N', -N' + 1, \dots, 0\}$.

Proof: Refer to Appendix G. ■

Similar to the proof of Theorem 5, one can prove the following theorem using Proposition 4.

Theorem 9: For any D having any interaction (i.e., either fully participated or partially participated) between its sub-digraphs $D_1, D_2, \dots, D_{N'}, D_{N'+1}$, if $f(D)$ (i.e., H') has some arcs among its vertices $1, 2, \dots, N', N' + 1$ such that there is no out-going arc from $N' + 1$ to any other vertex, then $\beta_t(D, G_o) = \sum_{i=1}^{N'+1} \beta_t(D_i) + \epsilon/t$ for some $\epsilon \in \{-N', -N' + 1, \dots, 0\}$, and $\beta(D, G_o) = \sum_{i=1}^{N'+1} \beta(D_i)$.

Remark 7: Extending the other cases of TSUIC to MSUIC is a laborious task as it involves a construction of multi-dimensional blocks and sub-blocks in a confusion graph.

VII. DISCUSSIONS

Consider any digraph D and its sub-digraphs D_1 , D_2 and D_3 . Let $d_D^+(u)$ be the out-degree of a vertex u of D . Now we make the following two observations in TSUIC:

- *The role of side-information of the vertices in $V(D_3)$ (vertices requesting the common messages) about the messages requested by vertices in $V(D_1) \cup V(D_2)$ (vertices requesting the private messages) in TSUIC:* It is proved in SSUIC that if the interaction between D_1 , D_2 and D_3 is acyclic, i.e., $f(D)$ belongs to one of the digraphs in CASE I, then $\beta(D) = \beta(D_1) + \beta(D_2) + \beta(D_3)$ (by using Theorem 3). This means that the arcs contributing acyclic interactions between the sub-digraphs of D can be removed without affecting the optimal broadcast rate of D ; in other words, those are non-critical arcs. In this paper, we have proved that this result is also true in TSUIC (by Theorem 5). Moreover, in TSUIC, we have proved that for D , if the vertices in $V(D_3)$ have no side-information about the messages requested by vertices in $V(D_1) \cup V(D_2)$, i.e., $d_{f(D)}^+(3) = \emptyset$, then by Theorem 5, we have $\beta(D, G_o) = \beta(D_1) + \beta(D_2) + \beta(D_3)$ (behaves like having acyclic interactions between D_1 , D_2 and D_3). Under this condition, any arc that is contributing any interaction between D_1 , D_2 and D_3 is non-critical.
- *Non-critical arcs in SSUIC are not necessarily non-critical in TSUIC:* We illustrate this with an example. Consider the TSUIC problem stated in Example 1 (whose $f(D) = H_{33}$). In SSUIC, we know that the optimal broadcast rate $\beta(D) = 2$. This problem has an arc $(3, 1)$ that is non-critical in SSUIC (its removal does not change the optimal broadcast rate) but it is critical in TSUIC. This can be understood from the following: In SSUIC, we can remove the arc $(3, 1) \in A(D)$, and still form a valid index code $\{x_1 \oplus x_2, x_3\}$ that achieves $\beta(D)$. This infers that removing the arc $(3, 1)$ does not affect the optimal broadcast rate in SSUIC. However, in TSUIC, if we remove the arc $(3, 1) \in A(D)$, then the new problem, say D' , has $\beta(D', G_o) = 3$ (applying Theorem 5), whereas we get a valid two-sender index code $\{x_1 \oplus x_3, x_2 \oplus x_3\}$ of codelength two if we consider $(3, 1) \in A(D)$. Now it is evident that there exist cases in TSUIC where some side-information (e.g., $(1, 2)$ and $(2, 1)$) cannot be exploited directly during encoding by senders because of the constraint due to the two senders. However, those side-information can be utilized during decoding

process at receivers' end due to the presence of other helping side-information (e.g., $(3, 1)$). So, these helping side-information can be critical in TSUIC. This observation was also made by Sadeghi et al. [20] for MSUIC under a different performance metric (rate region with fixed capacity links).

VIII. CONCLUDING REMARKS AND OPEN PROBLEMS

In this paper, we studied two-sender unicast-index-coding problems and established their structural characteristics. Noting that SSUIC is a well-studied problem (though for any arbitrary instance, it is still an open problem), there have been many important contributions made in the literature. In this paper, we solved TSUIC instances by expressing the optimal broadcast rates in terms of that of SSUIC. To this end, we introduced a two-sender graph coloring of confusion graphs in TSUIC, and propose a way of grouping the vertices of a confusion graph for analysis. Using these techniques, we derived optimal broadcast rates of TSUIC problems, both in the asymptotic and non-asymptotic regime, as a function of the optimal broadcast rates of their sub-problems. We have also presented a class of TSUIC instances where the interactions between the sub-problems of the problem are not critical. We illustrated that our proposed approach to TSUIC can be extended to some cases with multiple senders.

Some open problems for future works are the following:

- **Study of the critical edges in the TSUIC problems:** It is observed that the non-critical arcs in SSUIC can be critical arcs in TSUIC. This requires further study.
- **Study of a general distributed index coding:** As our study is a step towards understanding multi-sender index coding, it is left as a future work to extend the approaches implemented and the results obtained in this paper to more general setups.
- **Finding the optimal broadcast rates of TSUIC problems with cyclic-partially-participated interactions:** The analysis of D with partially-participated interactions between its sub-digraphs D_1 , D_2 and D_3 is left as a future work.

APPENDIX A

The two figures in Figure 10 outline the labels used to represent vertices of a confusion graph. The Figure 11 outlines the arrangement of vertices in any column sub-block of a block of a confusion graph for MSUIC.

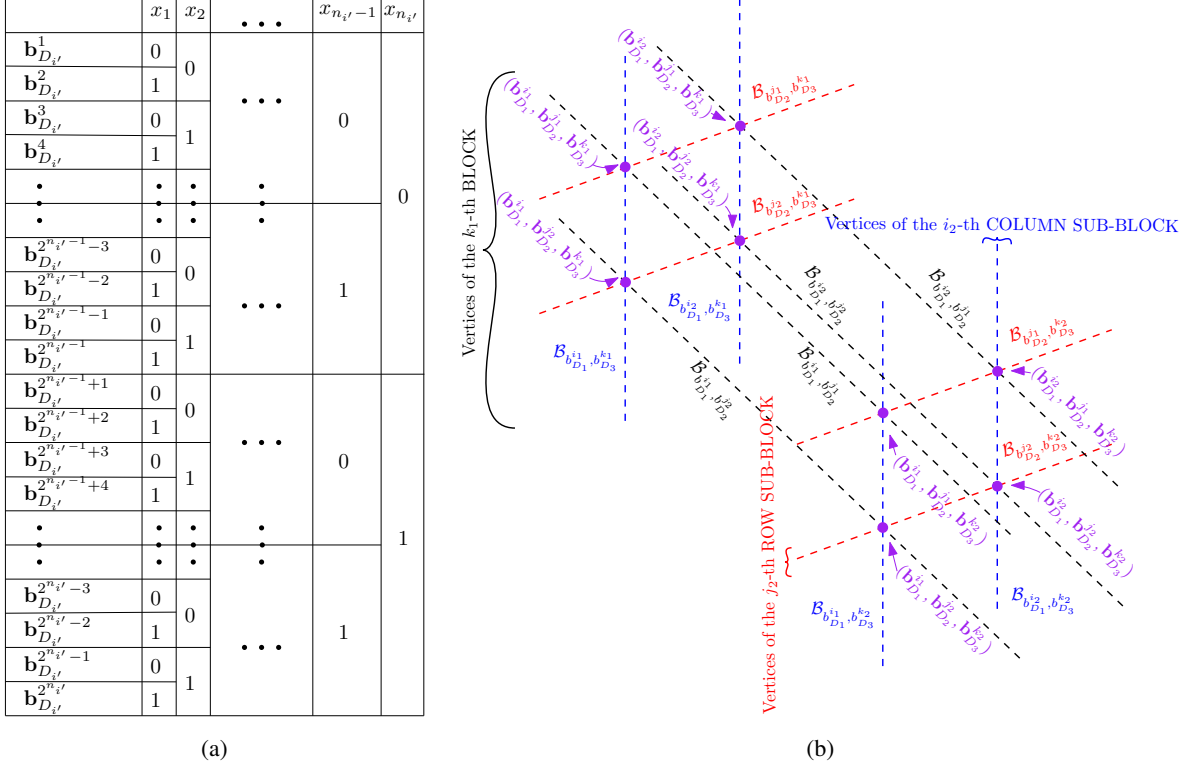

Fig. 10. (a) Each $n_{i'}$ -bit tuple $\mathbf{b}_{D_{i'}}^{j'}$ with its respective bits for $t = 1$, where $i' \in \{1, 2, 3\}$ and $j' \in \{1, 2, \dots, 2^{n_{i'}}\}$, and (b) representation of the vertices (e.g., $(\mathbf{b}_{D_1}^i, \mathbf{b}_{D_2}^j, \mathbf{b}_{D_3}^k)$) and sets of vertices (e.g., $\mathcal{B}_{\mathbf{b}_{D_2}^{j_1}, \mathbf{b}_{D_3}^{k_1}}$), each represented by a dotted line, in a confusion graph.

APPENDIX B

PROPOSED GROUPING OF THE VERTICES OF $\Gamma_t(D)$, AND ITS CHARACTERISTICS

A vertex of the confusion graph $\Gamma_t(D)$ is represented by a tuple x^N , where $x^N = (x_1, x_2, \dots, x_N)$, and it is labeled by a unique $(\mathbf{b}_{D_1}^i, \mathbf{b}_{D_2}^j, \mathbf{b}_{D_3}^k)$ (see Figure 12). For the ease of analysis, by considering special groups of vertices, we divide a confusion graph to the following fundamental sub-graphs.

Definition 9 (Block): The subgraph of $\Gamma_t(D)$ induced by a vertex set that is formed by collecting all the vertices with the same $\mathbf{b}_{D_3}^k$ sub-label is called a k -th block.

Refer to Figure 12 for a functional block diagram of a k -th block. Moreover, this grouping provides 2^{tn_3} blocks in $\Gamma_t(D)$. Clearly, all blocks in $\Gamma_t(D)$ are *isomorphic graphs*. This is because each block consists of all $(\mathbf{b}_{D_1}^i, \mathbf{b}_{D_2}^j, \mathbf{b}_{D_3}^k)$ for the same $\mathbf{b}_{D_3}^k$ sub-label (the $\mathbf{b}_{D_3}^k$ sub-labels are different only for different blocks), and the edges in any block is due to the confusion at some receivers in $V(D_1) \cup V(D_2)$. Moreover, the $(tn_1 + tn_2)$ -bit tuples of messages requested by the

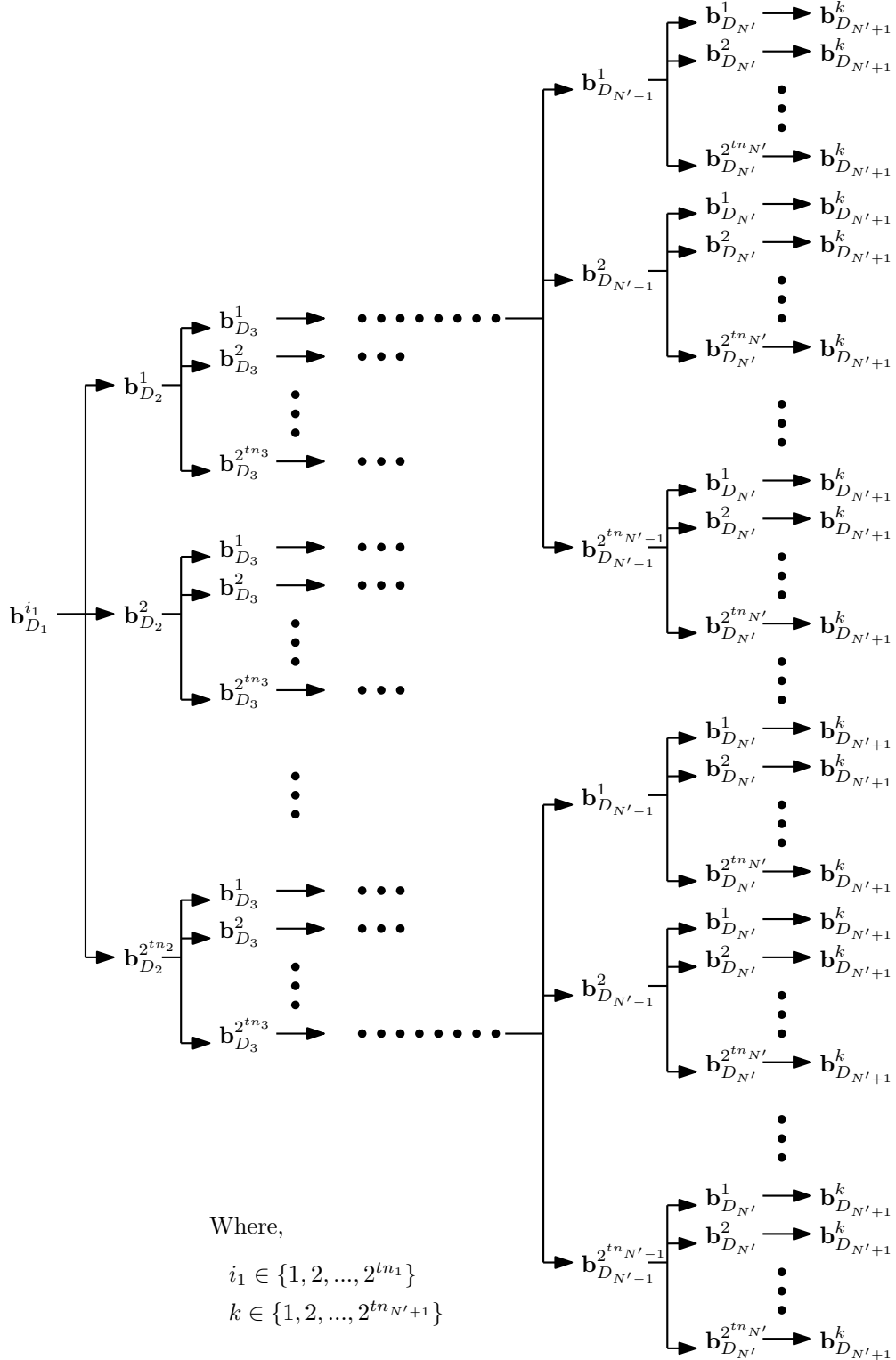

Fig. 11. Arrangement of vertices in i_1 -th column sub-block of a k -th block of a $\Gamma_t(D)$, where, for example, the first, second and the last vertices are labeled $(\mathbf{b}_{D_1}^{i_1}, \mathbf{b}_{D_2}^1, \mathbf{b}_{D_3}^1, \dots, \mathbf{b}_{D_{N'-1}}^1, \mathbf{b}_{D_{N'}}^1, \mathbf{b}_{D_{N'+1}}^k)$, $(\mathbf{b}_{D_1}^{i_1}, \mathbf{b}_{D_2}^1, \mathbf{b}_{D_3}^1, \dots, \mathbf{b}_{D_{N'-1}}^1, \mathbf{b}_{D_{N'}}^2, \mathbf{b}_{D_{N'+1}}^k)$, and $(\mathbf{b}_{D_1}^{i_1}, \mathbf{b}_{D_2}^{2^{tn_2}}, \mathbf{b}_{D_3}^{2^{tn_3}}, \dots, \mathbf{b}_{D_{N'-1}}^{2^{tn_{N'-1}}}, \mathbf{b}_{D_{N'}}^{2^{tn_{N'}}}, \mathbf{b}_{D_{N'+1}}^k)$, respectively. Observe that this sub-block has $2^{t(\sum_{i=2}^{N'} n_i)}$ vertices in total.

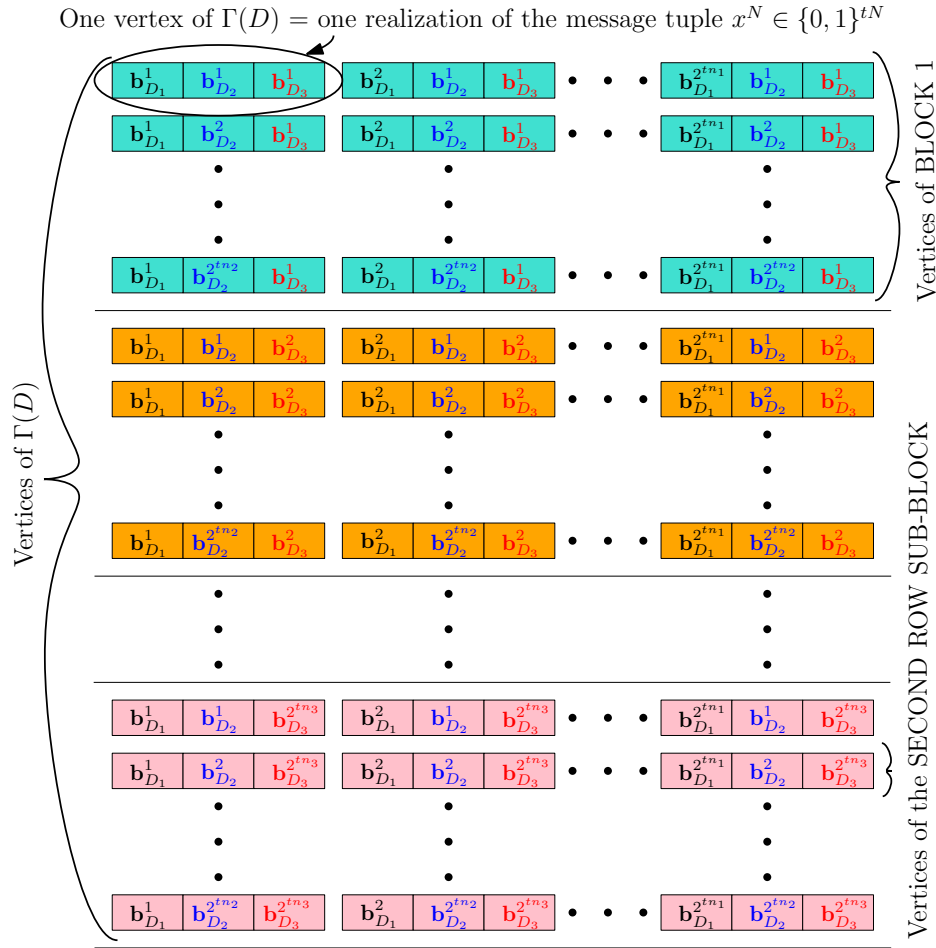

Fig. 12. Functional block digraph of grouping the vertices of a confusion graph. The vertices of a confusion graph are all the possible realizations of words of tN bits.

vertices in $V(D_1) \cup V(D_2)$ are labeled by $(\mathbf{b}_{D_1}^i, \mathbf{b}_{D_2}^j)$. For convenience, we further group the vertices of a block with the same $\mathbf{b}_{D_3}^k$ sub-label in two ways, but before this we introduce the following sets of vertices.

For the indices i, j, k , let $\mathcal{B}_{\mathbf{b}_{D_1}^i, \mathbf{b}_{D_2}^j}^k \triangleq \{(\mathbf{b}_{D_1}^i, \mathbf{b}_{D_2}^j, \mathbf{b}_{D_3}^k) : \text{for some fixed } (\mathbf{b}_{D_1}^i, \mathbf{b}_{D_2}^j)\}$ with cardinality 2^{tn_3} , $\mathcal{B}_{\mathbf{b}_{D_1}^i, \mathbf{b}_{D_3}^k}^j \triangleq \{(\mathbf{b}_{D_1}^i, \mathbf{b}_{D_2}^j, \mathbf{b}_{D_3}^k) : \text{for some fixed } (\mathbf{b}_{D_1}^i, \mathbf{b}_{D_3}^k)\}$ with cardinality 2^{tn_2} , and $\mathcal{B}_{\mathbf{b}_{D_2}^j, \mathbf{b}_{D_3}^k}^i$ is similarly defined.

Each block is further divided into two smaller sub-graphs, which are defined as follows:

Definition 10 (Column sub-block): The sub-graph of $\Gamma_t(D)$ induced by a vertex set that is formed by collecting all the vertices with the same $\mathbf{b}_{D_1}^i$ and $\mathbf{b}_{D_3}^k$ sub-labels is called an i -th column sub-block.

Definition 11 (Row sub-block): The sub-graph of $\Gamma_t(D)$ induced by a vertex set that is formed

by collecting all the vertices with the same $\mathbf{b}_{D_2}^j$ and $\mathbf{b}_{D_3}^k$ sub-labels is called a j -th row sub-block.

The sub-grouping of vertices provides 2^{tn_1} and 2^{tn_2} column and row sub-blocks, respectively, within each block. In addition, the vertex sets of a column and a row sub-blocks are represented by $\mathcal{B}_{\mathbf{b}_{D_1}^i, \mathbf{b}_{D_3}^k}$ and $\mathcal{B}_{\mathbf{b}_{D_2}^j, \mathbf{b}_{D_3}^k}$, respectively. Clearly, all i -th column sub-blocks of a $\Gamma_t(D)$ are isomorphic graphs. This is because each column sub-block consists of all $(\mathbf{b}_{D_1}^i, \mathbf{b}_{D_2}^j, \mathbf{b}_{D_3}^k)$ for the same $(\mathbf{b}_{D_1}^i, \mathbf{b}_{D_3}^k)$ sub-labels (the $(\mathbf{b}_{D_1}^i, \mathbf{b}_{D_3}^k)$ sub-labels are different only for different column sub-blocks), and the edges within any column sub-block is due to the confusion only at some receivers in $V(D_2)$. Moreover, the tn_2 -bit tuples of messages requested by the vertices in $V(D_2)$ are labeled by $\mathbf{b}_{D_2}^j$. From a similar reasoning as presented above for the case of column sub-blocks, it is not difficult to see that all the row sub-blocks are also isomorphic graphs, and the edges within any row sub-block is due to the confusion only at some receivers in $V(D_1)$.

Now we illustrate the grouping of the vertices by an example.

Example 5: Consider the TSUIC problem stated in Example 1. The confusion graph of the problem, $\Gamma_1(D)$, has the following: $\mathbf{b}_{D_1}^1 = 0, \mathbf{b}_{D_1}^2 = 1, \mathbf{b}_{D_2}^1 = 0, \mathbf{b}_{D_2}^2 = 1, \mathbf{b}_{D_3}^1 = 0, \mathbf{b}_{D_3}^2 = 1$, $\mathcal{B}_{\mathbf{b}_{D_2}^1, \mathbf{b}_{D_3}^1} = \{(0, 0, 0), (1, 0, 0)\}$, $\mathcal{B}_{\mathbf{b}_{D_2}^2, \mathbf{b}_{D_3}^1} = \{(0, 1, 0), (1, 1, 0)\}$, $\mathcal{B}_{\mathbf{b}_{D_2}^1, \mathbf{b}_{D_3}^2} = \{(0, 0, 1), (1, 0, 1)\}$, $\mathcal{B}_{\mathbf{b}_{D_2}^2, \mathbf{b}_{D_3}^2} = \{(0, 1, 1), (1, 1, 1)\}$, $\mathcal{B}_{\mathbf{b}_{D_1}^1, \mathbf{b}_{D_3}^1} = \{(0, 0, 0), (0, 1, 0)\}$, $\mathcal{B}_{\mathbf{b}_{D_1}^2, \mathbf{b}_{D_3}^1} = \{(1, 0, 0), (1, 1, 0)\}$, $\mathcal{B}_{\mathbf{b}_{D_1}^1, \mathbf{b}_{D_3}^2} = \{(0, 0, 1), (0, 1, 1)\}$, $\mathcal{B}_{\mathbf{b}_{D_1}^2, \mathbf{b}_{D_3}^2} = \{(1, 0, 1), (1, 1, 1)\}$, $\mathcal{B}_{\mathbf{b}_{D_2}^1, \mathbf{b}_{D_2}^1} = \{(0, 0, 0), (0, 0, 1)\}$, $\mathcal{B}_{\mathbf{b}_{D_2}^2, \mathbf{b}_{D_2}^1} = \{(1, 0, 0), (1, 0, 1)\}$, $\mathcal{B}_{\mathbf{b}_{D_2}^1, \mathbf{b}_{D_2}^2} = \{(0, 1, 0), (0, 1, 1)\}$, and $\mathcal{B}_{\mathbf{b}_{D_2}^2, \mathbf{b}_{D_2}^2} = \{(1, 1, 0), (1, 1, 1)\}$. Furthermore, the sub-graph of $\Gamma_1(D)$ induced by the vertices in the sets $\{(0, 0, 0), (1, 0, 0), (0, 1, 0), (1, 1, 0)\}$ and $\{(0, 0, 1), (1, 0, 1), (0, 1, 1), (1, 1, 1)\}$ form $k = 1$ and $k = 2$ blocks, respectively (see Figure 4b). In addition, we have four different row sub-blocks, each formed by the vertices in one of the following sets: $\mathcal{B}_{\mathbf{b}_{D_2}^1, \mathbf{b}_{D_3}^1}$, $\mathcal{B}_{\mathbf{b}_{D_2}^2, \mathbf{b}_{D_3}^1}$, $\mathcal{B}_{\mathbf{b}_{D_2}^1, \mathbf{b}_{D_3}^2}$, and $\mathcal{B}_{\mathbf{b}_{D_2}^2, \mathbf{b}_{D_3}^2}$ (for a general outline refer to Figure 10b in Appendix A).

A. Some lemmas

The following lemmas (7, 8, 9, 10 and 11) state the characteristics of our proposed grouping of vertices of a confusion graph $\Gamma_t(D)$ in TSUIC. These are helpful to understand the construction of a confusion graph, and are used in the proofs of our results.

Lemma 7: $\Gamma_t(D_1)$ and any j -th row sub-block are isomorphic graphs.

Proof: Let G be any j -th row sub-block. We know that any vertex in G has the same $(\mathbf{b}_{D_2}^j, \mathbf{b}_{D_3}^k)$ sub-labels, and all vertices of $\Gamma_t(D)$ with the same $(\mathbf{b}_{D_2}^j, \mathbf{b}_{D_3}^k)$ sub-label are included in the sub-block. Thus in G , any edge between its vertices is only due to the confusion at some

receiver belonging to $V(D_1)$ (corresponding to the change in bits of $\mathbf{b}_{D_1}^i$ sub-label of the vertices). We know that $\Gamma_t(D_1)$ has vertices $V(\Gamma_t(D_1)) = \{(\mathbf{b}_{D_1}^i)\}$, and any edge between its vertices is due to the confusion at some receiver belonging to $V(D_1)$. Observe that $|V(\Gamma_t(D_1))| = 2^{tn_1} = |\mathcal{B}_{\mathbf{b}_{D_2}^j, \mathbf{b}_{D_3}^k}| = |V(G)|$. Now $(\mathbf{b}_{D_1}^{i_1}, \mathbf{b}_{D_1}^{i_2}) \in E(\Gamma_t(D_1))$ if $((\mathbf{b}_{D_1}^{i_1}, \mathbf{b}_{D_2}^j, \mathbf{b}_{D_3}^k), (\mathbf{b}_{D_1}^{i_2}, \mathbf{b}_{D_2}^j, \mathbf{b}_{D_3}^k)) \in E(G)$ and vice-versa. This is because the edges are due to the confusion of the tuples, representing those vertices, at some receiver belonging to $V(D_1)$. Consequently, $\Gamma_t(D_1)$ and G are isomorphic graphs. ■

We illustrate Lemma 7 by an example. Consider the TSUIC problem stated in Example 1. The confusion graph of D_1 , $\Gamma_1(D_1)$, has two vertices 0 and 1 connected by an edge as they are confused at receiver 1. Observe that $j \in \{1, 2\}$. Now any j -th row sub-block of $\Gamma_1(D)$ has two vertices $(0, \mathbf{b}_{D_2}^j, \mathbf{b}_{D_3}^k)$ and $(1, \mathbf{b}_{D_2}^j, \mathbf{b}_{D_3}^k)$ connected by an edge as they are confused at receiver 1, and clearly, this vertex-induced sub-graph is isomorphic to $\Gamma_1(D_1)$.

In a similar way to the proof of Lemma 7, one can prove the following Lemma.

Lemma 8: Each pair of the following graphs are isomorphic: (i) $\Gamma_t(D_2)$ and any i -th column sub-block, (ii) $\Gamma_t(D_3)$ and the sub-graph of $\Gamma_t(D)$ induced by the vertices in $\mathcal{B}_{\mathbf{b}_{D_1}^i, \mathbf{b}_{D_2}^j}$ for any $(\mathbf{b}_{D_1}^i, \mathbf{b}_{D_2}^j)$, and (iii) any k -th block of a $\Gamma_t(D)$ and D' , where D' is an induced graph of D by the vertex set $V(D) \setminus V(D_3)$.

Lemma 9: In two-sender graph coloring of any row sub-block, $\chi(\Gamma_t(D_1))$ is the minimum number of total ordered pairs of colors required to color the sub-block, and the minimum number of colors associated with S_1 and S_2 are $\chi(\Gamma_t(D_1))$ and one, respectively.

Proof: Let G be any j -th row sub-block. Observe that G includes all vertices of $\Gamma_t(D)$ with the same $(\mathbf{b}_{D_2}^j, \mathbf{b}_{D_3}^k)$ sub-labels (due to our proposed method of grouping the vertices of $\Gamma_t(D)$). So, the edges between the vertices of G are only due to the confusion at some receivers belonging to $V(D_1)$. From Lemma 1, any pair of vertices of G connected by an edge must have different colors associated with S_1 and the same color associated with S_2 . Thus the minimum number of colors associated with S_2 is one. From Lemma 7, G is isomorphic to $\Gamma_t(D_1)$, so the minimum number of colors associated with S_1 must be $\chi(\Gamma_t(D_1))$. ■

In a similar way to the proof of Lemma 9, one can prove the following Lemma.

Lemma 10: In two-sender graph coloring of any column sub-block, $\chi(\Gamma_t(D_2))$ is the minimum number of total ordered pairs of colors required to color the sub-block, and the minimum number of colors associated with S_1 and S_2 are one and $\chi(\Gamma_t(D_2))$, respectively.

Lemma 11: In two-sender graph coloring of the sub-graph of $\Gamma_t(D)$ induced by the vertices in

$\mathcal{B}_{\mathbf{b}_{D_1}^i, \mathbf{b}_{D_2}^j}$ for any $(\mathbf{b}_{D_1}^i, \mathbf{b}_{D_2}^j)$, the minimum number of total ordered pairs of colors required to color the vertex-induced sub-graph is $\chi(\Gamma_t(D_3))$.

Proof: We know that $\Gamma_t(D_3)$ requires the minimum of $\chi(\Gamma_t(D_3))$ different colors in its coloring in SSUIC. Thus it has the minimum of $\chi(\Gamma_t(D_3))$ independent vertex sets. From Lemma 8, the sub-graph of $\Gamma_t(D)$ induced by the vertices in $\mathcal{B}_{\mathbf{b}_{D_1}^i, \mathbf{b}_{D_2}^j}$ is isomorphic to $\Gamma_t(D_3)$, so it has the minimum of $\chi(\Gamma_t(D_3))$ independent vertex sets. In two-sender graph coloring, we assign each independent vertex set a unique ordered pair of colors. Thus the vertex-induced sub-graph requires the minimum of $\chi(\Gamma_t(D_3))$ ordered pairs of colors. ■

APPENDIX C

PROOF OF PROPOSITION 1

A. An example

Before proving proposition 1, with the help of the following example, we provide an overview of the construction of the confusion graph and its two-sender graph coloring, which after generalization leads to the proof of Proposition 1.

Example 6: Consider a TSUIC problem (D, G_o) of the following: $(1|2), (2|1), (3|4), (4|3)$, and $\mathcal{M}_1 = \{1, 3, 4\}$, $\mathcal{M}_2 = \{2, 3, 4\}$ with $t = 1$.

For D , we have $f(D) = H_{15}$. Refer to Figure 13 for its confusion graph $\Gamma_1(D)$ whose vertices are grouped according to our proposed method. Now in details, we illustrate the construction of $\Gamma_1(D)$ and its two-sender graph coloring. These are used to derive $\beta_{t=1}(D, G_o)$. For the problem, we have $V(D_1) = \{1\}$, $V(D_2) = \{2\}$, and $V(D_3) = \{3, 4\}$. $\Gamma_1(D)$ has $2^4 = 16$ vertices labeled by all possible realizations of a word with four bits, each one is represented by a unique $(\mathbf{b}_{D_1}^i, \mathbf{b}_{D_2}^j, \mathbf{b}_{D_3}^k)$ label, where $i, j \in \{1, 2\}$, $k \in \{1, 2, 3, 4\}$, sub-labels $\mathbf{b}_{D_1}^i, \mathbf{b}_{D_2}^j \in \{0, 1\}$ and $\mathbf{b}_{D_3}^k \in \{00, 01, 10, 11\}$.

Before analyzing $\Gamma_1(D)$, for convenience, we define the following types of edges of $\Gamma_t(D)$, for any $t \geq 1$:

Definition 12 (Inter-block edge and Intra-block edge): An edge between two vertices each belonging to a different block⁴ of $\Gamma_t(D)$ (e.g., an edge between a vertex of the k_1 -th block and a vertex of the k_2 -th block of $\Gamma_t(D)$) is called an *inter-block edge*, and an edge within the vertices

⁴Refer to Definition 9 in Appendix B.

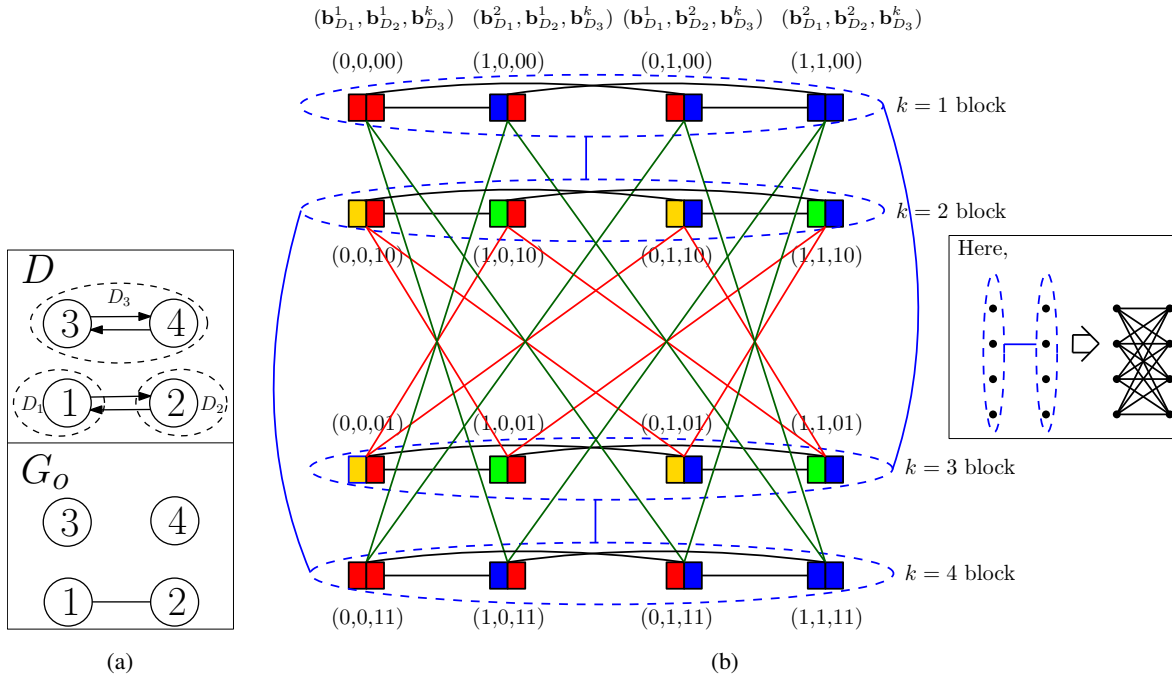

Fig. 13. (a) A given side-information digraph D such that $f(D) = H_{15}$, and a source-constraint graph G_o , (b) the confusion graph $\Gamma_1(D)$, and its two-sender graph coloring (where each vertex is assigned with an ordered pair of colors such that the first color is always associated with S_1 and the second color is always associated with S_2). The edges are shown in color only for an illustration purpose, it is not an edge coloring.

of a block of $\Gamma_t(D)$ (e.g., an edge between any two vertices of the k -th block of $\Gamma_t(D)$) is called an *intra-block edge*.

1) *Intra-block coloring*: Now consider the block with $k = 1$ (that is, the block with all vertices with the same $\mathbf{b}_{D_3}^1$ label). It has four vertices labeled by $(0, 0, 00)$, $(1, 0, 00)$, $(0, 1, 00)$ and $(1, 1, 00)$. One can find the intra-block edges (due to confusion at some receivers in $V(D_1 \cup D_2)$), and inter-block edges (due to confusion at some receivers in $V(D)$) as shown in Figure 13. We observe that all the blocks are isomorphic to each other. Now we color $\Gamma_1(D)$ starting from the block with $k = 1$. We color similarly for any other individual block. Consider its $(j = 1)$ -th row sub-block (refer to Definition 11 in Appendix B for its definition). It has two vertices $(0, 0, 00)$ and $(1, 0, 00)$. As these two tuples $((0, 0, 00)$ and $(1, 0, 00))$ are confused at receiver 1, so S_1 must assign different colors, and S_2 must assign the same color (by Lemma 1). Say we assign $(0, 0, 00) \rightarrow (\text{RED}, \text{RED})$ and $(1, 0, 00) \rightarrow (\text{BLUE}, \text{RED})$. We color similarly for each individual row sub-block (that is, the sub-block with all vertices with the same $\mathbf{b}_{D_2}^j, \mathbf{b}_{D_3}^k$ labels). Now

consider its $(i = 1)$ -th column sub-block⁵. It has two vertices $(0, 0, 00)$ and $(0, 1, 00)$. As these two tuples $((0, 0, 00)$ and $(0, 1, 00))$ are confused at receiver 2, so S_2 must assign different colors, and S_1 must assign the same color (by Lemma 2). Say we assign $(0, 0, 00) \rightarrow (\text{RED}, \text{RED})$ and $(0, 1, 00) \rightarrow (\text{RED}, \text{BLUE})$. We color similarly for each individual column sub-block. By carrying this way of coloring (as of the sub-blocks) to all the vertices of the block with $k = 1$, altogether, we have the following: $(0, 0, 00) \rightarrow (\text{RED}, \text{RED})$, $(1, 0, 00) \rightarrow (\text{BLUE}, \text{RED})$, $(0, 1, 00) \rightarrow (\text{RED}, \text{BLUE})$, and $(1, 1, 00) \rightarrow (\text{BLUE}, \text{BLUE})$. We say a two-sender graph coloring is the *best possible coloring* if it corresponds to the minimum sum of the bits, which is required to uniquely index the colors associated with each sender, in TSUIC. As $|V(D_1)| = 1$, $\Gamma_1(D_1)$ is a graph with two vertices (labeled by 0 and 1) connected by an edge. Thus $\chi(\Gamma_1(D_1)) = 2$. Similarly, we get $\chi(\Gamma_1(D_2)) = 2$. Now considering Lemmas 7, 8, 9, 10, and our proposed grouping of the vertices of a confusion graph, one can get $\chi(\Gamma_1(D_1)) \times \chi(\Gamma_1(D_2))$ ordered pairs of colors in the best possible coloring of a block of $\Gamma_1(D)$ in two-sender graph coloring. Thus, in any block, the four ordered pairs of colors (two colors associated per sender), that we have assigned to the vertices of $\Gamma_1(D)$, is the best possible coloring.

2) *Inter-block coloring:* We address the inter-block edges whist coloring. We consider any two blocks, and perform two-sender graph coloring. Firstly, consider the two blocks with $k = 1$ (all tuples having $\mathbf{b}_{D_3}^1 = 00$) and $k = 2$ (all tuples having $\mathbf{b}_{D_3}^2 = 10$). Observe that these two tuples are confused at receiver 3. As receivers 3 does not have $\{x_1, x_2\}$ in its side-information, any tuple of the block with $k = 1$ and any tuple of the block with $k = 2$ are confused at receiver 3. Thus every vertex of the block with $k = 1$ are connected to each vertex of the block with $k = 2$ by an inter-block edge. Consequently, we do not need to consider other inter-block edges due to confusions at some other receivers for this case. Now during two-sender graph coloring of these two blocks, we need to have two different ordered pairs of colors (one for each block). Furthermore, as x_3 is a common message to both senders, it suffices to have two completely different color sets (each for one block) associated with one of the senders. In other words, one of the senders can contribute additional colors to resolve these confusions (indicated by the inter-block edges between the blocks with k equal to 1 and 2). For example, assume that S_1 contributes the additional colors to resolve the confusions (inter-block edges) between the vertices of these blocks. Now we have the following coloring for the vertices of the block with $k = 2$:

⁵Refer to Definition 10 in Appendix B.

$(0, 0, 10) \rightarrow (\text{YELLOW}, \text{RED}), (1, 0, 10) \rightarrow (\text{GREEN}, \text{RED}), (0, 1, 10) \rightarrow (\text{YELLOW}, \text{BLUE}),$
and $(1, 1, 10) \rightarrow (\text{GREEN}, \text{BLUE}).$

Next, we consider the two blocks with $k = 1$ (all tuples having $\mathbf{b}_{D_3}^1 = 00$) and $k = 4$ (all tuples having $\mathbf{b}_{D_3}^4 = 11$). Clearly, these blocks have no inter-block edges due to the confusion at receivers 3 and 4. The inter-block edges are due to the confusion at receivers 1 and 2, and one can see them as shown in Figure 13. It is not difficult to verify that if we color the vertices of the block with $k = 4$ by the same coloring function done for the vertices of the block with $k = 1$, which is a function of $(\mathbf{b}_{D_1}^i, \mathbf{b}_{D_2}^j)$ sub-labels of the vertices, then the coloring is still valid. Thus in order to color the vertices of the block with $k = 4$, we do not need any additional colors for senders than that assigned to the vertices of the block with $k = 1$. Finally, we color similarly as above for the blocks with k equal to 2 and 3.

Now observe $\Gamma_1(D)$ by assuming each block as one super-vertex, the edges that connects all the vertices of one block to every vertex of another block, and vice-versa (edges due to confusion at some receivers in $V(D_3)$) as a single super-edge connecting those two super-vertices, and neglect all the inter-block edges due to the confusion at some receivers except receivers in $V(D_3)$, we see that the resulting graph is $\Gamma_1(D_3)$. Clearly, in two-sender graph coloring, we require $\chi(\Gamma_1(D_3))$ times of $\chi(\Gamma_1(D_1)) \times \chi(\Gamma_1(D_2))$ (which is required for each block) ordered pairs of colors in total, i.e., $2 \times 4 = 8$ ordered pairs of colors, which means $\beta_1(D, G_o) \geq 3$. The lower bound 3 is achievable by the coloring scheme in Figure 13b.

B. Ingredients for the proof

We prove the following five lemmas that are used to prove Proposition 1.

Lemma 12: For any k -th block of the confusion graph $\Gamma_t(D)$ of a digraph D , $\chi(\Gamma_t(D_1)) \times \chi(\Gamma_t(D_2))$ is the minimum ordered pairs of colors in two-sender graph coloring, where the number of colors associated with S_1 and S_2 are $\chi(\Gamma_t(D_1))$ and $\chi(\Gamma_t(D_2))$, respectively.

Proof: For any D , based on our proposed way of grouping the vertices of $\Gamma_t(D)$ (see Appendix B), we write all the vertices of any k -th block of $\Gamma_t(D)$ in the following matrix form:

$$\mathbb{B}_k = \begin{bmatrix} (\mathbf{b}_{D_1}^1, \mathbf{b}_{D_2}^1, \mathbf{b}_{D_3}^k) & (\mathbf{b}_{D_1}^2, \mathbf{b}_{D_2}^1, \mathbf{b}_{D_3}^k) & \dots & (\mathbf{b}_{D_1}^{2^{tn_1}}, \mathbf{b}_{D_2}^1, \mathbf{b}_{D_3}^k) \\ (\mathbf{b}_{D_1}^1, \mathbf{b}_{D_2}^2, \mathbf{b}_{D_3}^k) & (\mathbf{b}_{D_1}^2, \mathbf{b}_{D_2}^2, \mathbf{b}_{D_3}^k) & \dots & (\mathbf{b}_{D_1}^{2^{tn_1}}, \mathbf{b}_{D_2}^2, \mathbf{b}_{D_3}^k) \\ \vdots & \vdots & \ddots & \vdots \\ (\mathbf{b}_{D_1}^1, \mathbf{b}_{D_2}^{2^{tn_2}}, \mathbf{b}_{D_3}^k) & (\mathbf{b}_{D_1}^2, \mathbf{b}_{D_2}^{2^{tn_2}}, \mathbf{b}_{D_3}^k) & \dots & (\mathbf{b}_{D_1}^{2^{tn_1}}, \mathbf{b}_{D_2}^{2^{tn_2}}, \mathbf{b}_{D_3}^k) \end{bmatrix}.$$

\mathbb{B}_k provides a visualization of the arrangement of vertices in the k -th block. The coloring of any row sub-block (one row of \mathbb{B}_k provides the arrangement of its vertices) requires the minimum of $\chi(\Gamma_t(D_1))$ different colors associated with S_1 and exactly one color associated with S_2 (due to Lemma 9). Now considering the coloring function of S_1 , i.e., $J_1(\mathbf{b}_{D_1}^i, \mathbf{b}_{D_3}^k)$, the same coloring function must be applied to all row sub-blocks of the block. Now the coloring of any column sub-block (one column of \mathbb{B}_k provides the arrangement of its vertices) requires the minimum of $\chi(\Gamma_t(D_2))$ different colors associated with S_2 and exactly one color associated with S_1 (due to Lemma 10). Similarly, considering the coloring function of S_2 , i.e., $J_2(\mathbf{b}_{D_2}^j, \mathbf{b}_{D_3}^k)$, the same coloring function must be applied to all column sub-blocks of the block. Altogether, we get the minimum of $\chi(\Gamma_t(D_1)) \times \chi(\Gamma_t(D_2))$ ordered pairs of colors to color a block of the confusion graph $\Gamma_t(D)$ in two-sender graph coloring. ■

Lemma 13: Consider a two-sender graph coloring function J_o that properly colors the confusion graph $\Gamma_t(D)$. If there is no inter-block edge due to the confusion at some receiver in $V(D_3)$ between any blocks of $\Gamma_t(D)$, then $J_o(\mathbf{b}_{D_1}^i, \mathbf{b}_{D_2}^j, \mathbf{b}_{D_3}^1) = J_o(\mathbf{b}_{D_1}^i, \mathbf{b}_{D_2}^j, \mathbf{b}_{D_3}^2) = \dots = J_o(\mathbf{b}_{D_1}^i, \mathbf{b}_{D_2}^j, \mathbf{b}_{D_3}^{2tn_3})$, for all i and j , is a valid two-sender graph coloring.

Proof: We first prove the lemma considering any two blocks, say k_1 -th block and k_2 -th block. If there is no inter-block edge due to the confusion at any receiver in $V(D_3)$ between the k_1 -th and k_2 -th blocks of $\Gamma_t(D)$, then we have two cases: (i) no inter-block edge and (ii) some inter-block edges due to the confusion at some receivers in $V(D_1) \cup V(D_2)$. In case (i), since k_1 -block and k_2 -block are isomorphic, we can color a block by two-sender graph coloring, and keep the same copy of coloring in another block (i.e., $J_o(\mathbf{b}_{D_1}^{i_1}, \mathbf{b}_{D_2}^{j_1}, \mathbf{b}_{D_3}^{k_1}) = J_o(\mathbf{b}_{D_1}^{i_2}, \mathbf{b}_{D_2}^{j_2}, \mathbf{b}_{D_3}^{k_2})$, $\forall i_1, j_1$). Now for case (ii), suppose that there exists an edge $((\mathbf{b}_{D_1}^{i_1}, \mathbf{b}_{D_2}^{j_1}, \mathbf{b}_{D_3}^{k_1}), (\mathbf{b}_{D_1}^{i_2}, \mathbf{b}_{D_2}^{j_2}, \mathbf{b}_{D_3}^{k_2})) \in E(\Gamma_t(D))$. Observe that $k_1 \neq k_2$ because k_1 and k_2 are two different blocks. Moreover, since the edge is due to the confusion at some receivers in $V(D_1) \cup V(D_2)$, we must have $(i_1, j_1) \neq (i_2, j_2)$. Now if there exists the edge $((\mathbf{b}_{D_1}^{i_1}, \mathbf{b}_{D_2}^{j_1}, \mathbf{b}_{D_3}^{k_1}), (\mathbf{b}_{D_1}^{i_2}, \mathbf{b}_{D_2}^{j_2}, \mathbf{b}_{D_3}^{k_2}))$, then there must exist an edge $((\mathbf{b}_{D_1}^{i_1}, \mathbf{b}_{D_2}^{j_1}, \mathbf{b}_{D_3}^{k_1}), (\mathbf{b}_{D_1}^{i_2}, \mathbf{b}_{D_2}^{j_2}, \mathbf{b}_{D_3}^{k_1}))$. This edge is between the vertices of the same block, and the confusion must have already resolved by the coloring J_o . Thereby, $J_o(\mathbf{b}_{D_1}^i, \mathbf{b}_{D_2}^j, \mathbf{b}_{D_3}^{k_1}) = J_o(\mathbf{b}_{D_1}^i, \mathbf{b}_{D_2}^j, \mathbf{b}_{D_3}^{k_2})$, $\forall i, j$, is a valid coloring.

Since the choice of k_1 and k_2 is arbitrary, a two-sender graph coloring of $\Gamma_t(D)$ with $J_o(\mathbf{b}_{D_1}^i, \mathbf{b}_{D_2}^j, \mathbf{b}_{D_3}^1) = J_o(\mathbf{b}_{D_1}^i, \mathbf{b}_{D_2}^j, \mathbf{b}_{D_3}^2) = \dots = J_o(\mathbf{b}_{D_1}^i, \mathbf{b}_{D_2}^j, \mathbf{b}_{D_3}^{2tn_3})$, for all i and j , is a valid two-sender graph coloring. ■

Lemma 14: For a digraph D having fully-participated interactions between its sub-digraphs D_1 ,

D_2 and D_3 , the confusion at some receivers in $V(D_1)$ does not contribute any inter-block edges in $\Gamma_t(D)$ if $D_1 \rightarrow D_3$ in D (equivalently, $(1, 3) \in A(f(D))$), and the confusion at some receivers in $V(D_2)$ does not contribute any inter-block edges in $\Gamma_t(D)$ if $D_2 \rightarrow D_3$ in D (equivalently, $(2, 3) \in A(f(D))$).

Proof: There is no edge due to the confusion at some receivers in $V(D_1)$ between any pair of vertices $((\mathbf{b}_{D_1}^{i_1}, \mathbf{b}_{D_2}^{j_1}, \mathbf{b}_{D_3}^{k_1}), (\mathbf{b}_{D_1}^{i_2}, \mathbf{b}_{D_2}^{j_2}, \mathbf{b}_{D_3}^{k_2}))$, $k_1 \neq k_2$ (for inter-block edges), because any vertex in $V(D_1)$ has $\{x_u : u \in V(D_3)\}$ in its side-information and the corresponding $\mathbf{b}_{D_3}^{k_1}$ and $\mathbf{b}_{D_3}^{k_2}$ labels of the two vertices are different. This proves the first assertion. Repeating the same argument for D_2 , we get the second assertion (for the case $D_2 \rightarrow D_3$ in D). ■

Lemma 15: For any real numbers A and B , $\lceil A + B \rceil = \lceil A \rceil + \lceil B \rceil + \epsilon'$, where $\epsilon' \in \{-1, 0\}$.

Proof: As we know that for any real number A , we have $A \leq \lceil A \rceil$, and $\lceil A \rceil - A < 1$ (this implies $\lceil A \rceil < A + 1$ or $\lceil A \rceil - 1 < A$). So we get $A \leq \lceil A \rceil < A + 1$. This is true for any other real number $A + B$, so $A + B \leq \lceil A + B \rceil < A + B + 1$. Altogether, we get

$$\begin{aligned} \lceil A \rceil + \lceil B \rceil - 2 &< A + B \leq \lceil A + B \rceil < A + B + 1 \leq \lceil A \rceil + \lceil B \rceil + 1 \\ \lceil A \rceil + \lceil B \rceil - 2 &< \lceil A + B \rceil < \lceil A \rceil + \lceil B \rceil + 1. \end{aligned} \quad (29)$$

There are only two integers in $(\lceil A \rceil + \lceil B \rceil - 2, \lceil A \rceil + \lceil B \rceil + 1)$, and they are $\lceil A \rceil + \lceil B \rceil - 1$ and $\lceil A \rceil + \lceil B \rceil$, so $\lceil A + B \rceil = \lceil A \rceil + \lceil B \rceil + \epsilon'$, where $\epsilon' \in \{-1, 0\}$. ■

Lemma 16: For any $\Gamma_t(D)$, if a minimum of $\chi(\Gamma_t(D_1)) \times \chi(\Gamma_t(D_2)) \times \chi(\Gamma_t(D_3))$ ordered pairs of colors are required in its two-sender graph coloring, then $\beta_t(D, G_o) = \beta_t(D_1) + \beta_t(D_2) + \beta_t(D_3) + \epsilon/t$, $\epsilon \in \{-2, -1, 0\}$.

Proof: Let $\chi'(\Gamma_t(D_3))$ and $\chi''(\Gamma_t(D_3))$ be the non-negative non-zero integer factors of $\chi(\Gamma_t(D_3))$, and $\chi^1(\Gamma_t(D_3))$ and $\chi^2(\Gamma_t(D_3))$ be the best choice over all $\chi'(\Gamma_t(D_3))$ and $\chi''(\Gamma_t(D_3))$, respectively, such that the term $\lceil \log_2(\chi(\Gamma_t(D_1)) \times \chi'(\Gamma_t(D_3))) \rceil + \lceil \log_2(\chi(\Gamma_t(D_2)) \times \chi''(\Gamma_t(D_3))) \rceil$ is minimized. The colors associated with S_i , $i \in \{1, 2\}$, is always an integer multiple of $\chi(\Gamma_t(D_i))$ whilst coloring $\Gamma_t(D)$ due to its symmetry. Thus along with Lemmas 4 and 12, one can find that $\chi(\Gamma_t(D_1)) \times \chi^1(\Gamma_t(D_3))$ and $\chi(\Gamma_t(D_2)) \times \chi^2(\Gamma_t(D_3))$ are the colors associated with S_1 and S_2 , respectively, in order to produce a minimum of $\chi(\Gamma_t(D_1)) \times \chi(\Gamma_t(D_2)) \times \chi(\Gamma_t(D_3))$ ordered

pairs of colors in the two-sender graph coloring of $\Gamma_t(D)$. Now from Theorem 2, we get

$$\begin{aligned}
& t \times \beta_t(D, G_o) \\
&= \lceil \log_2(\chi(\Gamma_t(D_1)) \times \chi^1(\Gamma_t(D_3))) \rceil + \lceil \log_2(\chi(\Gamma_t(D_2)) \times \chi^2(\Gamma_t(D_3))) \rceil \\
&= \lceil \log_2(\chi(\Gamma_t(D_1))) + \log_2(\chi^1(\Gamma_t(D_3))) \rceil + \lceil \log_2(\chi(\Gamma_t(D_2))) + \log_2(\chi^2(\Gamma_t(D_3))) \rceil \\
&= \lceil \log_2(\chi(\Gamma_t(D_1))) \rceil + \lceil \log_2(\chi^1(\Gamma_t(D_3))) \rceil + \lceil \log_2(\chi(\Gamma_t(D_2))) \rceil + \lceil \log_2(\chi^2(\Gamma_t(D_3))) \rceil + \epsilon_1 \\
&= \lceil \log_2(\chi(\Gamma_t(D_1))) \rceil + \lceil \log_2(\chi(\Gamma_t(D_2))) \rceil + \lceil \log_2(\chi^1(\Gamma_t(D_3)) \times \chi^2(\Gamma_t(D_3))) \rceil + \epsilon_1 + \epsilon_2 \\
\beta_t(D, G_o) &= \beta_t(D_1) + \beta_t(D_2) + \beta_t(D_3) + \epsilon/t, \tag{30}
\end{aligned}$$

where $\epsilon_1 \in \{-2, -1, 0\}$ and $\epsilon_2 \in \{0, 1\}$ are obtained by using Lemma 15, and $\epsilon = (\epsilon_2 + \epsilon_1) \in \{-2, -1, 0, 1\}$, $\beta_t(D_m) = \frac{\lceil \log_2(\chi(\Gamma_t(D_m))) \rceil}{t}$, for $m \in \{1, 2, 3\}$. As we know that $\beta_t(D, G_o) \leq \beta_t(D_1) + \beta_t(D_2) + \beta_t(D_3)$ (a simpler upper bound in TSUIC), the value of ϵ in (30) cannot be greater than zero. Thus $\epsilon \in \{-2, -1, 0\}$. ■

C. Proof of Proposition 1

Whilst constructing a confusion graph, we follow our proposed grouping of vertices of the confusion graph described in Appendix B. For convenience, let D be denoted by D^i if $f(D) = H_i$, $i \in \{1, 16\}$ (see Figure 3).

1) *Construction and coloring of $\Gamma_t(D^{16})$* : We present the construction and two-sender graph coloring of $\Gamma_t(D^{16})$, where D^{16} has the fully-participated interactions between the sub-digraphs D_1 , D_2 and D_3 .

(A) *Construction of $\Gamma_t(D^{16})$* : All edges of $\Gamma_t(D^{16})$ are listed in the following:

- (i) Edges in $E(\Gamma_t(D^{16}))$ due to the confusion at some vertices in $V(D_1)$: The confusion at any vertex in $V(D_1)$ contributes to only intra-edges due to Lemma 14.
- (ii) Edges in $E(\Gamma_t(D^{16}))$ due to the confusion at some vertices in $V(D_2)$: The confusion at any vertex in $V(D_2)$ contributes to only intra-edges due to Lemma 14.
- (iii) Edges in $E(\Gamma_t(D^{16}))$ due to the confusion at some vertices in $V(D_3)$: If there exists an edge due to the confusion at some vertices in $V(D_3)$ between any vertex pair $((\mathbf{b}_{D_1}^{i_1}, \mathbf{b}_{D_2}^{j_1}, \mathbf{b}_{D_3}^{k_1}), (\mathbf{b}_{D_1}^{i_2}, \mathbf{b}_{D_2}^{j_2}, \mathbf{b}_{D_3}^{k_2}))$, then each of the vertices in the k_1 -th block has edges with all the vertices in the k_2 -th block. This is because any vertex in $V(D_3)$ has no message requested by any vertex in $V(D_1) \cup V(D_2)$ as its side-information. This results no effect due to a change in

bits of $\mathbf{b}_{D_1}^i$ or $\mathbf{b}_{D_2}^j$ sub-label once we have an edge due to confusion at some receivers in $V(D_3)$, which corresponds to the change in bits of the $\mathbf{b}_{D_3}^k$ sub-label.

(B) *Coloring of $\Gamma_t(D^{16})$* : In SSUIC, we know that the minimum numbers of colors required to color D_1 , D_2 and D_3 separately are $\chi(\Gamma_t(D_1))$, $\chi(\Gamma_t(D_2))$ and $\chi(\Gamma_t(D_3))$, respectively. From Lemma 12, in two-sender graph coloring, vertices in any k -th block of $\Gamma_t(D^{16})$ are colored properly with the minimum of $\chi(\Gamma_t(D_1)) \times \chi(\Gamma_t(D_2))$ ordered pairs of colors, where the minimum number of colors associated with S_1 and S_2 are $\chi(\Gamma_t(D_1))$ and $\chi(\Gamma_t(D_2))$, respectively. Referring to the construction of $\Gamma_t(D^{16})$, the inter-block edges are solely due to the confusion at some vertices in $V(D_3)$ (from (i), (ii) and (iii) of the construction), and if there exists an inter-block edge between any two vertices, the first one belonging to k_1 -th block and the second one belonging to k_2 -th block, then we have edges from every vertex of the k_1 -th block to all vertices of the k_2 -th block. This states that it is necessary to have two different sets of ordered pairs of $\chi(\Gamma_t(D_1)) \times \chi(\Gamma_t(D_2))$ colors, one for each block if there is an edge between these blocks. Furthermore, it is sufficient to consider the different color sets associated with one of the senders for those blocks in order to obtain the different sets of $\chi(\Gamma_t(D_1)) \times \chi(\Gamma_t(D_2))$ ordered pairs of colors. As we require the minimum of $\chi(\Gamma_t(D_3))$ ordered pairs of colors to color vertices in any $\mathcal{B}_{\mathbf{b}_{D_1}^i, \mathbf{b}_{D_2}^j}$ (refer to Lemma 11), so the total number of minimum ordered pairs of colors required to color $\Gamma_t(D^{16})$ in two-sender graph coloring is $\chi(\Gamma_t(D_1)) \times \chi(\Gamma_t(D_2)) \times \chi(\Gamma_t(D_3))$. Now from Lemma 16, we get $\beta_t(D^{16}, G_o) = \beta_t(D_1) + \beta_t(D_2) + \beta_t(D_3) + \epsilon/t$, where $\epsilon \in \{-2, -1, 0\}$.

2) *Construction and coloring of $\Gamma_t(D^1)$* : We present the construction and two-sender graph coloring of $\Gamma_t(D^1)$. In contrast to D^{16} above, D^1 has no interaction between D_1 , D_2 and D_3 . This results in extra edges, both intra-block and inter-block edges, in $\Gamma_t(D^1)$ with respect to $\Gamma_t(D^{16})$. We observe that one can build $\Gamma_t(D^1)$ on the top of $\Gamma_t(D^{16})$ by adding these extra edges.

(A) *Construction of $\Gamma_t(D^1)$* : The extra edges of $\Gamma_t(D^1)$ with respect to $\Gamma_t(D^{16})$ are both intra-block and inter-block edges.

(B) *Coloring of $\Gamma_t(D^1)$* : The extra intra-block edges do not change the requirements of ordered pairs of colors in two-sender graph coloring of a block of $\Gamma_t(D^1)$ due to Lemma 12. Now we address the extra inter-block edges. For the extra inter-block edges in $E(\Gamma_t(D^1))$ due to the confusion at some vertices in $V(D_1)$ and $V(D_2)$ in two-sender graph coloring, we have the following: If there is no inter-block edge due to the confusion at some vertices in $V(D_3)$, then we can do two-sender graph coloring of these blocks as stated by Lemma 13. This implies that

we can do two-sender graph coloring of all these blocks by $\chi(\Gamma_t(D_1)) \times \chi(\Gamma_t(D_2))$ ordered pairs of colors, where the minimum colors associated with S_1 and S_2 are $\chi(\Gamma_t(D_1))$ and $\chi(\Gamma_t(D_2))$, respectively. As the vertex 3 has no out-going arcs in both H_1 and H_{16} , the edges in $E(\Gamma_t(D^1))$ due to the confusion at some vertices in $V(D_3)$ are the same as of (iii) of the construction of $\Gamma_t(D^{16})$. Thus similar to the case of $\Gamma_t(D^{16})$, referring to the edges in $E(\Gamma_t(D^1))$ due to the confusion at some vertices in $V(D_3)$, if any k_1 -th and k_2 -th blocks have the inter-block edges (including all inter-block edges due to the confusion at some vertices in $V(D_1) \cup V(D)$), then it is necessary to have two different sets of ordered pairs of $\chi(\Gamma_t(D_1)) \times \chi(\Gamma_t(D_2))$ colors, one for each block. Furthermore, it is sufficient to consider different color sets associated with one of the senders for these blocks in order to achieve the necessary ordered pairs of colors. Altogether, a TSUIC coloring of $\Gamma_t(D^1)$ can be done similar to D^{16} with the minimum of $\chi(\Gamma_t(D_1)) \times \chi(\Gamma_t(D_2)) \times \chi(\Gamma_t(D_3))$ ordered pairs of colors. Now from Lemma 16, we get $\beta_t(D^1, G_o) = \beta_t(D_1) + \beta_t(D_2) + \beta_t(D_3) + \epsilon/t$, $\epsilon \in \{-2, -1, 0\}$. \square

APPENDIX D

PROOF OF THEOREM 6

For the problems in TSUIC, we prove this theorem by constructing a valid index code based on single-sender index codes. Before starting proof, unless stated otherwise, we assume the following for any vertex-induced sub-digraph $D_{i'}$, for some index $i' \in \{1, 2, 3\}$, in SSUIC:

- 1) Let $\mathcal{C}(D_{i'})$ be an index code (linear or non-linear) having a codeword length of $|\mathcal{C}(D_{i'})|$ bits, for a given t (message bits), that achieves $\beta_t(D_{i'})$. For convenience, we represent $|\mathcal{C}(D_{i'})|$ by $\ell^*(\mathcal{C}(D_{i'}))$ such that $\ell^*(\mathcal{C}(D_{i'})) = \beta_t(D_{i'})$.
- 2) Let the sequence of bits in $\mathcal{C}(D_{i'})$ be $(w_1^{i'}, w_2^{i'}, \dots, w_{\ell^*(\mathcal{C}(D_{i'}))}^{i'})$, where $w_m^{i'} \in \{0, 1\}$, $m \in \{1, 2, \dots, \ell^*(\mathcal{C}(D_{i'}))\}$.
- 3) Let $\mathcal{C}^1(D_{i'}) = (w_1^{i'}, w_2^{i'}, \dots, w_{\ell_1^*(\mathcal{C}(D_{i'}))}^{i'})$ and $\mathcal{C}^2(D_{i'}) = (w_{\ell_1^*(\mathcal{C}(D_{i'}))+1}^{i'}, w_{\ell_1^*(\mathcal{C}(D_{i'}))+2}^{i'}, \dots, w_{\ell^*(\mathcal{C}(D_{i'}))}^{i'})$ with $|\mathcal{C}^2(D_{i'})| = \ell_2^*(\mathcal{C}(D_{i'}))$ be two parts of the sequence of bits of a codeword of $\mathcal{C}(D_{i'})$ such that $\mathcal{C}(D_{i'}) = (\mathcal{C}^1(D_{i'}), \mathcal{C}^2(D_{i'}))$ with $\ell^*(\mathcal{C}(D_{i'})) = \ell_1^*(\mathcal{C}(D_{i'})) + \ell_2^*(\mathcal{C}(D_{i'}))$.
- 4) For any two codes $\mathcal{C}(D_{i'})$ and $\mathcal{C}(D_{j'})$ with codeword lengths of $\ell^*(\mathcal{C}(D_{i'}))$ and $\ell^*(\mathcal{C}(D_{j'}))$ bits, respectively, $\mathcal{C}(D_{i'}) \oplus \mathcal{C}(D_{j'})$ refers to the bit-wise XOR of bits of $\mathcal{C}(D_{i'})$ and $\mathcal{C}(D_{j'})$ with zero padding if $\ell^*(\mathcal{C}(D_{i'})) \neq \ell^*(\mathcal{C}(D_{j'}))$. This means $\mathcal{C}(D_{i'}) \oplus \mathcal{C}(D_{j'})$ contains $\max\{\ell^*(\mathcal{C}(D_{i'})), \ell^*(\mathcal{C}(D_{j'}))\}$ bits. For example, if $\mathcal{C}(D_{i'}) = (101)$ and $\mathcal{C}(D_{j'}) = (001101)$, then $\mathcal{C}(D_{i'}) \oplus \mathcal{C}(D_{j'}) = (101000) \oplus (001101) = (100101)$.

(First case: $\beta_t(D, G_o) = \beta_t(D_3)$ if $\beta_t(D_3) \geq \beta_t(D_1) + \beta_t(D_2)$) The given condition $\beta_t(D_3) \geq \beta_t(D_1) + \beta_t(D_2)$ implies that $|\mathcal{C}(D_3)| \geq |\mathcal{C}(D_1)| + |\mathcal{C}(D_2)|$ (i.e., $\ell^*(\mathcal{C}(D_3)) \geq \ell^*(\mathcal{C}(D_1)) + \ell^*(\mathcal{C}(D_2))$) for a finite t . Now in TSUIC, we propose that S_1 transmits $\mathcal{C}_1 = \mathcal{C}^1(D_3) \oplus \mathcal{C}(D_1)$ of $\ell_1^*(\mathcal{C}(D_3)) = \ell^*(\mathcal{C}(D_1))$ bits, and S_2 transmits $\mathcal{C}_2 = \mathcal{C}^2(D_3) \oplus \mathcal{C}(D_2)$ of $\ell_2^*(\mathcal{C}(D_3))$ bits because $\ell_2^*(\mathcal{C}(D_3)) \geq \ell^*(\mathcal{C}(D_2))$ as we have $\ell^*(\mathcal{C}(D_3)) \geq \ell^*(\mathcal{C}(D_1)) + \ell^*(\mathcal{C}(D_2))$ and $\ell_1^*(\mathcal{C}(D_3)) = \ell^*(\mathcal{C}(D_1))$. Each receiver receives $(\ell_1^*(\mathcal{C}(D_3)) + \ell_2^*(\mathcal{C}(D_3)))$ -bit $(\mathcal{C}_1, \mathcal{C}_2)$. Now the decoding is done in the following way: (i) All the vertices in $V(D_1)$ will decode their requested messages from \mathcal{C}_1 and its side-information that also includes $\{x_i : i \in V(D_3)\}$ (as there is a fully-participated $D_1 \rightarrow D_3$ in D), (ii) all the vertices in $V(D_2)$ will decode their requested messages from \mathcal{C}_2 and its side-information that also includes $\{x_i : i \in V(D_3)\}$ (as there is a fully-participated $D_2 \rightarrow D_3$ in D), and (iii) all the vertices in $V(D_3)$ will decode their requested messages from $(\mathcal{C}_1, \mathcal{C}_2)$ and its side-information that also includes $\{x_i : i \in V(D_1) \cup V(D_2)\}$ (as there is fully-participated $D_3 \rightarrow (D_1 \cup D_2)$ in D). Thus $(\ell_1^*(\mathcal{C}(D_3)) + \ell_2^*(\mathcal{C}(D_3)))$ -bit $(\mathcal{C}_1, \mathcal{C}_2)$ is a valid index code in TSUIC for this case, and

$$\beta_t(D, G_o) \leq (\ell_1^*(\mathcal{C}(D_3)) + \ell_2^*(\mathcal{C}(D_3)))/t = \ell^*(\mathcal{C}(D_3))/t = \beta_t(D_3). \quad (31)$$

In SSUIC, $\beta_t(D) \geq \beta_t(D_3)$ because D_3 is a sub-graph of D . Now in TSUIC,

$$\beta_t(D, G_o) \geq \beta_t(D) \geq \beta_t(D_3). \quad (32)$$

From (31) and (32), we have $\beta_t(D, G_o) = \beta_t(D_3)$.

(Second case: $\beta_t(D, G_o) = \beta_t(D_1) + \beta_t(D_2)$ if $\beta_t(D_3) \leq \beta_t(D_1) + \beta_t(D_2)$) The given condition $\beta_t(D_3) \leq \beta_t(D_1) + \beta_t(D_2)$ implies that $|\mathcal{C}(D_3)| \leq |\mathcal{C}(D_1)| + |\mathcal{C}(D_2)|$. Now we have the following three sub-cases: (i) $|\mathcal{C}(D_3)| \geq \max\{|\mathcal{C}(D_1)|, |\mathcal{C}(D_2)|\}$, (ii) $|\mathcal{C}(D_3)| \leq |\mathcal{C}(D_1)|$, and (iii) $|\mathcal{C}(D_3)| \leq |\mathcal{C}(D_2)|$. For these sub-cases, we propose the following:

(Sub-case (i): $|\mathcal{C}(D_3)| \geq \max\{|\mathcal{C}(D_1)|, |\mathcal{C}(D_2)|\}$) S_1 transmits $\mathcal{C}_1 = \mathcal{C}^1(D_3) \oplus \mathcal{C}(D_1)$ of $\ell_1^*(\mathcal{C}(D_3)) = \ell^*(\mathcal{C}(D_1))$ bits, and S_2 transmits $\mathcal{C}_2 = \mathcal{C}^2(D_3) \oplus \mathcal{C}(D_2)$ of $\ell^*(\mathcal{C}(D_2))$ bits because $\ell^*(\mathcal{C}(D_2)) \geq \ell_2^*(\mathcal{C}(D_3))$ as we have $\ell^*(\mathcal{C}(D_3)) \leq \ell^*(\mathcal{C}(D_1)) + \ell^*(\mathcal{C}(D_2))$ and $\ell_1^*(\mathcal{C}(D_3)) = \ell^*(\mathcal{C}(D_1))$. Each receiver receives $(\ell^*(\mathcal{C}(D_1)) + \ell^*(\mathcal{C}(D_2)))$ -bit $(\mathcal{C}_1, \mathcal{C}_2)$. Now one can verify that the decoding is done in the same way as stated in the first case. Thus $(\ell^*(\mathcal{C}(D_1)) + \ell^*(\mathcal{C}(D_2)))$ -bit $(\mathcal{C}_1, \mathcal{C}_2)$ is a valid index code in TSUIC for this sub-case.

(Sub-case (ii): $|\mathcal{C}(D_3)| \leq |\mathcal{C}(D_1)|$) S_1 transmits $\mathcal{C}_1 = \mathcal{C}(D_3) \oplus \mathcal{C}(D_1)$ of $\ell^*(\mathcal{C}(D_1))$ bits (because $\ell^*(\mathcal{C}(D_3)) \leq \ell^*(\mathcal{C}(D_1))$), and S_2 transmits $\mathcal{C}_2 = \mathcal{C}(D_2)$ of $\ell^*(\mathcal{C}(D_2))$ bits. Now the decoding is

done in the following way: (i) All the vertices in $V(D_1)$ will decode their requested messages from \mathcal{C}_1 and its side-information that also includes $\{x_i : i \in V(D_3)\}$ (as there is a fully-participated $D_1 \rightarrow D_3$ in D), (ii) all the vertices in $V(D_2)$ will decode their requested messages from \mathcal{C}_2 and its side-information, and (iii) all the vertices in $V(D_3)$ will decode their requested messages from \mathcal{C}_1 and its side-information that also includes $\{x_i : i \in V(D_1)\}$ (as there is a fully-participated $D_3 \rightarrow D_1$ in D). Thus $(\ell^*(\mathcal{C}(D_1)) + \ell^*(\mathcal{C}(D_2)))$ -bit $(\mathcal{C}_1, \mathcal{C}_2)$ is a valid encoding in TSUIC for this sub-case.

(Sub-case (iii): $|\mathcal{C}(D_3)| \leq |\mathcal{C}(D_2)|$) As we have a fully-participated $D_3 \rightarrow (D_1 \cup D_2)$ in D , so by swapping D_1 and D_2 (meaning we swap the two senders) in the sub-case (ii), one can prove that $(\ell^*(\mathcal{C}(D_1)) + \ell^*(\mathcal{C}(D_2)))$ -bit $(\mathcal{C}_1, \mathcal{C}_2)$ is a valid index code in TSUIC for this sub-case.

Altogether for the second case,

$$\beta_t(D, G_o) \leq (\ell^*(\mathcal{C}(D_1)) + \ell^*(\mathcal{C}(D_2)))/t = \beta_t(D_1) + \beta_t(D_2). \quad (33)$$

By considering $\beta_t(D, G_o) \geq \beta_t(D_1) + \beta_t(D_2)$ (by Lemma 6) and (33), we get, $\beta_t(D, G_o) = \beta_t(D_1) + \beta_t(D_2)$.

Now combining these two cases (First and Second cases), we get

$$\beta_t(D, G_o) = \max\{\beta_t(D_3), \beta_t(D_1) + \beta_t(D_2)\}. \quad (34)$$

Now taking a limit $t \rightarrow \infty$ on both sides of (34), we get

$$\begin{aligned} \lim_{t \rightarrow \infty} \beta_t(D, G_o) &= \lim_{t \rightarrow \infty} \max\{\beta_t(D_3), \beta_t(D_1) + \beta_t(D_2)\} \\ \lim_{t \rightarrow \infty} \beta_t(D, G_o) &= \max\{\lim_{t \rightarrow \infty} \beta_t(D_3), \lim_{t \rightarrow \infty} (\beta_t(D_1) + \beta_t(D_2))\}. \end{aligned} \quad (35)$$

We know that $\beta = \inf_t \beta_t = \lim_{t \rightarrow \infty} \beta_t$ (by Definition 3), and “a limit of a finite sum of functions equals the sum of the limit of each functions, if the limit of each function exists,” so we get $\beta(D, G_o) = \max\{\beta(D_3), \beta(D_1) + \beta(D_2)\}$ from (35). \square

APPENDIX E

PROOF OF THEOREM 7

For the problems in TSUIC, we prove this theorem by constructing a valid index code based on single-sender index codes. Refer to the first paragraph of Appendix D for notations.

In TSUIC, we propose that S_1 transmits $\mathcal{C}_1 = \mathcal{C}(D_1) \oplus \mathcal{C}(D_3)$ consisting of $\max\{\ell^*(\mathcal{C}(D_1)), \ell^*(\mathcal{C}(D_3))\}$ bits, and S_2 transmits $\mathcal{C}_2 = \mathcal{C}(D_2)$ of $\ell^*(\mathcal{C}(D_2))$ bits. Each receiver receives

$(\ell^*(\mathcal{C}(D_2)) + \max\{\ell^*(\mathcal{C}(D_1)), \ell^*(\mathcal{C}(D_3))\})$ -bit $(\mathcal{C}_1, \mathcal{C}_2)$. Now the decoding is done in the following way: (i) All the vertices in $V(D_1)$ will decode their requested messages from \mathcal{C}_1 and its side-information that also includes $\{x_i : i \in V(D_3)\}$ (as there is a fully-participated $D_1 \rightarrow D_3$ in D), (ii) all the vertices in $V(D_2)$ will decode their requested messages from \mathcal{C}_2 and its side-information, and (iii) all the vertices in $V(D_3)$ will decode their requested messages from \mathcal{C}_1 and its side-information that also includes $\{x_i : i \in V(D_1)\}$ (as there is a fully-participated $D_3 \rightarrow D_1$ in D). Thus $(\ell^*(\mathcal{C}(D_2)) + \max\{\ell^*(\mathcal{C}(D_1)), \ell^*(\mathcal{C}(D_3))\})$ -bit $(\mathcal{C}_1, \mathcal{C}_2)$ is a valid index code in TSUIC for this case, and

$$\beta_t(D, G_o) \leq \frac{1}{t}(\ell^*(\mathcal{C}(D_2)) + \max\{\ell^*(\mathcal{C}(D_1)), \ell^*(\mathcal{C}(D_3))\}) = \beta_t(D_2) + \max\{\beta_t(D_1), \beta_t(D_3)\}. \quad (36)$$

Now by Lemma 6, we have $\beta_t(D, G_o) \geq \beta_t(D_1) + \beta_t(D_2)$, and from (36), if $\beta_t(D_1) \geq \beta_t(D_3)$, then $\beta_t(D, G_o) \leq \beta_t(D_1) + \beta_t(D_2)$. Altogether, we get $\beta_t(D, G_o) = \beta_t(D_1) + \beta_t(D_2)$.

For the sub-digraph $D_{j'}$, $j' \in \{1, 2, 3\}$, we know that there exists an index code $\mathcal{C}(D_{j'})$ of $\ell^*(\mathcal{C}(D_{j'}))$ bits such that $\ell^*(\mathcal{C}(D_{j'}))/t$ tends to $\beta(D_{j'})$ if $t \rightarrow \infty$, and for any $t \geq 1$, $\beta(D_{j'}) \leq \ell^*(\mathcal{C}(D_{j'}))/t$. So, we write $\ell^*(\mathcal{C}(D_{j'}))/t = \beta(D_{j'}) + \epsilon_t(D_{j'})$, for some $\epsilon_t(D_{j'}) \geq 0$ such that $\epsilon_t(D_{j'})$ tends to zero if message length t tends to infinity. For D , considering the same code formation, which is a valid two-sender index code, as stated for the cases considering the finite message length, we get S_1 and S_2 transmitting sub-codewords of $\max\{\ell^*(\mathcal{C}(D_1)), \ell^*(\mathcal{C}(D_3))\}$ and $\ell^*(\mathcal{C}(D_2))$ bits, respectively. For any $t \geq 1$, there exists a two-sender index code of the following bit length:

$$p_1 + p_2 = \max\{\ell^*(\mathcal{C}(D_1)), \ell^*(\mathcal{C}(D_3))\} + \ell^*(\mathcal{C}(D_2)).$$

Now dividing both sides by t in the above equation, we get

$$\begin{aligned} \frac{p_1 + p_2}{t} &= \max\{\ell^*(\mathcal{C}(D_1))/t, \ell^*(\mathcal{C}(D_3))/t\} + \ell^*(\mathcal{C}(D_2))/t \\ &= \max\{\beta(D_1) + \epsilon_t(D_1), \beta(D_3) + \epsilon_t(D_3)\} + \beta(D_2) + \epsilon_t(D_2), \end{aligned} \quad (37)$$

where $\epsilon_t(D_{j'}) \geq 0$ for $j' \in \{1, 2, 3\}$. For any $j' \in \{1, 2, 3\}$, as $\epsilon_t(D_{j'}) \rightarrow 0$ for $t \rightarrow \infty$, we get

$$\beta(D, G_o) \leq \lim_{t \rightarrow \infty} (p_1 + p_2)/t = \max\{\beta(D_1), \beta(D_3)\} + \beta(D_2). \quad (38)$$

Alternatively, we can get (38) by taking a limit $t \rightarrow \infty$ on both sides of (36) because $\beta = \lim_{t \rightarrow \infty} \beta_t$ (by Definition 3).

Clearly, if $\beta(D_1) \geq \beta(D_3)$, then from (38), we get

$$\beta(D, G_o) \leq \beta(D_1) + \beta(D_2). \quad (39)$$

Now from Lemma 6 and (39), we get $\beta(D, G_o) = \beta(D_1) + \beta(D_2)$ if $\beta(D_1) \geq \beta(D_3)$. \square

APPENDIX F

PROOF OF THEOREM 8

Proof: For the problems in TSUIC, we prove this theorem by constructing a valid index code based on single-sender index codes. Refer to the first paragraph of Appendix D for notations.

In TSUIC, we propose that S_1 transmits $\mathcal{C}_1 = \mathcal{C}(D_1) \oplus \mathcal{C}(D_3)$ of $\max\{\ell^*(\mathcal{C}(D_1)), \ell^*(\mathcal{C}(D_3))\}$ bits, and S_2 transmits $\mathcal{C}_2 = \mathcal{C}(D_2) \oplus \mathcal{C}(D_3)$ of $\max\{\ell^*(\mathcal{C}(D_2)), \ell^*(\mathcal{C}(D_3))\}$ bits. Each receiver receives $(\max\{\ell^*(\mathcal{C}(D_1)), \ell^*(\mathcal{C}(D_3))\} + \max\{\ell^*(\mathcal{C}(D_2)), \ell^*(\mathcal{C}(D_3))\})$ -bit $(\mathcal{C}_1, \mathcal{C}_2)$. Now the decoding is done in the following way: (i) All the vertices in $V(D_1)$ will decode their requested messages from $\mathcal{C}_1 \oplus \mathcal{C}_2$ and its side-information that also includes $\{x_i : i \in V(D_2)\}$ (as there is a fully-participated $D_1 \rightarrow D_2$ in D), (ii) if $f(D) \in \{H_{i'} : i' \in \{33, 34, 35\}\}$, all the vertices in $V(D_2)$ will decode their requested messages from $\mathcal{C}_1 \oplus \mathcal{C}_2$ and its side-information that also includes $\{x_i : i \in V(D_1)\}$ (as there is a fully-participated $D_2 \rightarrow D_1$ in D), and if $f(D) = H_{36}$, all the vertices in $V(D_2)$ will decode their requested messages from \mathcal{C}_2 and its side-information that also includes $\{x_i : i \in V(D_3)\}$ (as there is a fully-participated $D_2 \rightarrow D_3$ in D), (iii) all the vertices in $V(D_3)$ will decode their requested messages from \mathcal{C}_1 and its side-information that also includes $\{x_i : i \in V(D_1)\}$ (as there is a fully-participated $D_3 \rightarrow D_1$ in D). Thus $(\max\{\ell^*(\mathcal{C}(D_1)), \ell^*(\mathcal{C}(D_3))\} + \max\{\ell^*(\mathcal{C}(D_2)), \ell^*(\mathcal{C}(D_3))\})$ -bit $(\mathcal{C}_1, \mathcal{C}_2)$ is a valid index code in TSUIC for this case, and

$$\begin{aligned} \beta_t(D, G_o) &\leq (\max\{\ell^*(\mathcal{C}(D_1)), \ell^*(\mathcal{C}(D_3))\} + \max\{\ell^*(\mathcal{C}(D_2)), \ell^*(\mathcal{C}(D_3))\})/t \\ &\leq \max\{\beta_t(D_1), \beta_t(D_3)\} + \max\{\beta_t(D_2), \beta_t(D_3)\}. \end{aligned} \quad (40)$$

Now if $\beta_t(D_3) \leq \min\{\beta_t(D_1), \beta_t(D_2)\}$, from (40), we get $\beta_t(D, G_o) \leq \beta_t(D_1) + \beta_t(D_2)$. From Lemma 6, we have $\beta_t(D, G_o) \geq \beta_t(D_1) + \beta_t(D_2)$. Thus $\beta_t(D, G_o) = \beta_t(D_1) + \beta_t(D_2)$ if $\beta_t(D_3) \leq \min\{\beta_t(D_1), \beta_t(D_2)\}$.

Now by taking a limit $t \rightarrow \infty$ on both sides of (40), we get

$$\begin{aligned} \lim_{t \rightarrow \infty} \beta_t(D, G_o) &\leq \lim_{t \rightarrow \infty} \max\{\beta_t(D_1), \beta_t(D_3)\} + \lim_{t \rightarrow \infty} \max\{\beta_t(D_2), \beta_t(D_3)\} \\ &\beta(D, G_o) \leq \max\{\beta(D_1), \beta(D_3)\} + \max\{\beta(D_2), \beta(D_3)\}. \end{aligned} \quad (41)$$

This is because $\beta = \lim_{t \rightarrow \infty} \beta_t$ (by Definition 3). Now from (41), we get $\beta(D, G_o) \leq \beta(D_1) + \beta(D_2)$ if $\beta(D_3) \leq \min\{\beta(D_1), \beta(D_2)\}$, and $\beta(D, G_o) \geq \beta(D_1) + \beta(D_2)$ from Lemma 6. So, $\beta(D, G_o) = \beta(D_1) + \beta(D_2)$ if $\beta(D_3) \leq \min\{\beta(D_1), \beta(D_2)\}$. ■

APPENDIX G

PROOF OF PROPOSITION 4

Before proving Proposition 4, we have the following lemmas related to row and column sub-blocks of any k -th block, $k \in \{1, 2, \dots, 2^{tn_{N'+1}}\}$.

Lemma 17: For any row sub-block of a k -th block, the minimum number of N' -tuples of colors required to color it in SMSUIC is $\chi(\Gamma_t(D_1)) \times 1 \times \dots \times 1$, where the minimum colors associated with S_1 and remainder senders are $\chi(\Gamma_t(D_1))$ and one each, respectively.

Proof: Based on our proposed grouping of vertices (also see Figure 11), any row sub-block of a k -th block consists of vertices labeled by all $(\mathbf{b}_{D_1}^{i_1}, \mathbf{b}_{D_2}^{i_2}, \mathbf{b}_{D_3}^{i_3}, \dots, \mathbf{b}_{D_{N'}}^{i_{N'}}, \mathbf{b}_{D_{N'+1}}^k)$, $i_j \in \{1, 2, \dots, 2^{tn_j}\}$ for $j \in \{1, 2, \dots, N'\}$, with the same $(\mathbf{b}_{D_2}^{i_2}, \mathbf{b}_{D_3}^{i_3}, \dots, \mathbf{b}_{D_{N'}}^{i_{N'}}, \mathbf{b}_{D_{N'+1}}^k)$ sub-labels. Clearly, the edges in the row sub-block are only due to the confusion at vertices in $V(D_1)$, so S_1 colors differently if there is any confusion, and any sender S_j , $j \neq 1$, provides the same color to all vertices of the row sub-block. Moreover, observe that any row sub-block and $\Gamma_t(D_1)$ are isomorphic graphs (one can extend the proof of Lemma 7 to get this result). The proof completes by noting that any S_j , $j \in \{1, 2, \dots, N'\}$, requires a minimum of $\chi(\Gamma_t(D_j))$ colors to color a confusion graph $\Gamma_t(D_j)$ whose vertices are labeled by $\mathbf{b}_{D_j}^{i_j}$, $i_j \in \{1, 2, \dots, 2^{tn_j}\}$. ■

Lemma 18: For any column sub-block of a k -th block, the minimum number of N' -tuples of colors required to color it in SMSUIC is $1 \times \chi(\Gamma_t(D_2)) \times \chi(\Gamma_t(D_3)) \times \dots \times \chi(\Gamma_t(D_{N'}))$, where the minimum colors associated with S_1 and S_j are one and $\chi(\Gamma_t(D_j))$, respectively, for all $j \in \{2, 3, \dots, N'\}$.

Proof: Based on our proposed grouping of vertices, any column sub-block of a k -th block consists of vertices labeled by all $(\mathbf{b}_{D_1}^{i_1}, \mathbf{b}_{D_2}^{i_2}, \mathbf{b}_{D_3}^{i_3}, \dots, \mathbf{b}_{D_{N'}}^{i_{N'}}, \mathbf{b}_{D_{N'+1}}^k)$, $i_j \in \{1, 2, \dots, 2^{tn_j}\}$ for $j \in \{1, 2, \dots, N'\}$, with the same $\mathbf{b}_{D_1}^{i_1}$ and $\mathbf{b}_{D_{N'+1}}^k$ sub-labels. As a result, the edges in the column sub-block are only due to the confusion at some vertex in $\bigcup_{i=2}^{N'} V(D_i)$, and S_1 assigns the same color to all vertices in the sub-block. Now for any sender S_j , $j \in \{2, 3, \dots, N'\}$, the message tuples associated to all sub-labels $(\mathbf{b}_{D_1}^{i_1}, \mathbf{b}_{D_2}^{i_2}, \mathbf{b}_{D_3}^{i_3}, \dots, \mathbf{b}_{D_{N'}}^{i_{N'}}, \mathbf{b}_{D_{N'+1}}^k)$ except $\mathbf{b}_{D_j}^{i_j}$ are “DON'T CARE” since all $\mathbf{b}_{D_1}^{i_1}, \mathbf{b}_{D_2}^{i_2}, \mathbf{b}_{D_3}^{i_3}, \dots, \mathbf{b}_{D_{N'}}^{i_{N'}}$ sub-labels are associated only with private messages, and $\mathbf{b}_{D_{N'+1}}^k$, which is associated with common messages, is same for all vertices of

the k -th block. Thus S_j colors any two or more vertices with the same $\mathbf{b}_{D_j}^{i_j}$ but with different other sub-labels in the sub-block with the same color. For example, S_2 assigns the same color to the vertices labeled by $(\mathbf{b}_{D_1}^1, \mathbf{b}_{D_2}^{i_2}, \mathbf{b}_{D_3}^1, \dots, \mathbf{b}_{D_{N'}}^1, \mathbf{b}_{D_{N'+1}}^k)$, $(\mathbf{b}_{D_1}^2, \mathbf{b}_{D_2}^{i_2}, \mathbf{b}_{D_3}^2, \dots, \mathbf{b}_{D_{N'}}^2, \mathbf{b}_{D_{N'+1}}^k)$ and $(\mathbf{b}_{D_1}^3, \mathbf{b}_{D_2}^{i_2}, \mathbf{b}_{D_3}^3, \dots, \mathbf{b}_{D_{N'}}^3, \mathbf{b}_{D_{N'+1}}^k)$ for some i_2 . Furthermore, it is the only one sender which can resolve the confusion by assigning different colors if there is confusion of the tuples associated with $\mathbf{b}_{D_j}^{i_j}$, $j \in \{1, 2, \dots, N'\}$. Clearly, for any column sub-block, the coloring function of S_j depends on the message tuples associated only to the sub-label $\mathbf{b}_{D_j}^{i_j}$, $i_j \in \{1, 2, \dots, 2^{tn_j}\}$. Note that any S_j , $j \in \{1, 2, \dots, N'\}$, requires a minimum of $\chi(\Gamma_t(D_j))$ colors to color a confusion graph $\Gamma_t(D_j)$ whose vertices are labeled by $\mathbf{b}_{D_j}^{i_j}$, $i_j \in \{1, 2, \dots, 2^{tn_j}\}$. Along with the proposed grouping of vertices (see Figure 11), altogether, for any column sub-block, each S_j requires a minimum of $\chi(\Gamma_t(D_j))$ colors. In SMSUIC, for any column sub-block, if any two vertices are connected by an edge due to the confusion of the message tuples associated with the following: (i) Only with sub-label $\mathbf{b}_{D_j}^{i_j}$, then the sender S_j assigns different colors in the color tuples of those vertices, and (ii) more than two sub-labels (for example $\mathbf{b}_{D_2}^{i_2}$ and $\mathbf{b}_{D_3}^{i_3}$), then all the associated senders (for example both S_2 and S_3) assign different colors in the color tuples of those vertices. This is because the confusion of the message tuples associated with the sub-labels of those vertices occurred at different sub-labels related only to private messages. Overall, considering the symmetry of the column sub-block, the minimum of $1 \times \chi(\Gamma_t(D_2)) \times \chi(\Gamma_t(D_3)) \times \dots \times \chi(\Gamma_t(D_{N'}))$ N' -tuples of colors is required to color it in MSUIC, where the minimum colors associated with S_1 and S_j are one and $\chi(\Gamma_t(D_j))$, respectively, for all $j \in \{2, 3, \dots, N'\}$. ■

Lemma 19: For any k -th block, the minimum number of N' -tuples of colors required to color it in MSUIC is $\chi(\Gamma_t(D_1)) \times \chi(\Gamma_t(D_2)) \times \chi(\Gamma_t(D_3)) \times \dots \times \chi(\Gamma_t(D_{N'}))$.

Proof: Consider any two different i_1 -th and i'_1 -th column sub-blocks of a k -th block, where $i_1, i'_1 \in \{1, 2, \dots, 2^{tn_1}\}$. Observe that these two column sub-blocks are isomorphic, and the vertices of these two sub-blocks have different $\mathbf{b}_{D_1}^{i_1}$ sub-label such that any i_1 -th sub-block has vertices labeled by all $(\mathbf{b}_{D_1}^{i_1}, \mathbf{b}_{D_2}^{i_2}, \mathbf{b}_{D_3}^{i_3}, \dots, \mathbf{b}_{D_{N'}}^{i_{N'}}, \mathbf{b}_{D_{N'+1}}^k)$, $i_j \in \{1, 2, \dots, 2^{tn_j}\}$ for $j \in \{2, \dots, N'\}$, with the same $\mathbf{b}_{D_1}^{i_1}$ sub-label. Assume that we properly color i_1 -th column sub-block with a minimum of $1 \times \chi(\Gamma_t(D_2)) \times \chi(\Gamma_t(D_3)) \times \dots \times \chi(\Gamma_t(D_{N'}))$ N' -tuples of colors in multi-sender graph coloring (by Lemma 18). Now we keep the same coloring functions of all S_j , $j \in \{2, \dots, N'\}$, that operate in i_1 -th column sub-block to i'_1 -th column sub-block. Considering our proposed grouping of the vertices, its symmetry, and the above observation, this is a valid multi-sender graph coloring of all S_j for those two column sub-blocks. Moreover, S_1 is the only one sender that provides different

colors if there is confusion at some vertices in $V(D_1)$ (where the confusion is associated with the sub-labels $\mathbf{b}_{D_1}^{i_1}$ and $\mathbf{b}_{D_1}^{i'_1}$), and once any coloring function of S_j , $j \in \{2, 3, \dots, N'\}$ resolves the confusion at vertices in $V(D_j)$ within one column sub-block, then it also resolves the confusion at vertices in $V(D_j)$ belonging to the different column sub-blocks. For example, if a vertex u in i_1 -th column sub-block is connected by an edge to a vertex v' in i'_1 -th column sub-block due to the confusion at a vertex in $V(D_j)$, then u is also connected to another vertex v present in i_1 -th column with the same sub-label $\mathbf{b}_{D_j}^{i_1}$ as of v' . The confusion is resolved by our assumption in any i_1 -th column, so it must be true for the two column sub-blocks as we repeat the same coloring function of all S_j , $j \in \{2, 3, \dots, N'\}$ to both the column sub-blocks.

Now for sender S_1 , whilst coloring in MSUIC, it assigns the same color to all vertices of a column sub-block as it has the same $\mathbf{b}_{D_1}^{i_1}$ sub-label. If we consider all column sub-blocks of the block, then S_1 properly colors with a minimum of $\chi(\Gamma_t(D_1))$ colors (from Lemma 17). Altogether, $\chi(\Gamma_t(D_1))$ times the N' -tuples of colors required to color one column sub-block, i.e., $\chi(\Gamma_t(D_1)) \times \chi(\Gamma_t(D_2)) \times \chi(\Gamma_t(D_3)) \times \dots \times \chi(\Gamma_t(D_{N'}))$ is the minimum number of N' -tuples of colors required to color a block in SMSUIC. ■

Let D with $f(D) = H'_1$ and $f(D) = H'_{16}$ be denoted by D_M^1 and D_M^{16} , respectively. Based on our proposed grouping of vertices of $\Gamma_t(D_M^{16})$, observe that any block has all vertices with the same label $\mathbf{b}_{D_{N'+1}}^k$, and this label only changes when block changes. This is exactly the same case as in TSUIC (where $\mathbf{b}_{D_3}^k$ changes when block changes). Now along with the consideration of the grouping of vertices, their symmetry, and Lemma 19, one can construct and color $\Gamma_t(D_M^{16})$ similar to $\Gamma_t(D^{16})$, and $\Gamma_t(D_M^1)$ similar to $\Gamma_t(D^1)$ stated in the proof of Proposition 1 in Appendix C. This results the following lemma.

Lemma 20: For any $\Gamma_t(D_M^{16})$ or $\Gamma_t(D_M^1)$, the minimum number of N' -tuples of colors required to color it in SMSUIC is $\chi(\Gamma_t(D_1)) \times \chi(\Gamma_t(D_2)) \times \chi(\Gamma_t(D_3)) \times \dots \times \chi(\Gamma_t(D_{N'})) \times \chi(\Gamma_t(D_{N'+1}))$.

Similar to the proof of Lemma 16, by utilizing Lemma 20, it is not difficult to prove the following lemma:

Lemma 21: For any $\Gamma_t(D)$, if $\chi(\Gamma_t(D_1)) \times \chi(\Gamma_t(D_2)) \times \chi(\Gamma_t(D_3)) \times \dots \times \chi(\Gamma_t(D_{N'})) \times \chi(\Gamma_t(D_{N'+1}))$ N' -tuples of colors required in SMSUIC, then $\beta_t(D, G_o) = \sum_{i=1}^{N'+1} \beta_t(D_i) + \epsilon/t$ for some $\epsilon \in \{-N', -N' + 1, \dots, 0\}$.

Now the proof of Proposition 4 follows from Lemmas 20 and 21.

REFERENCES

- [1] Y. Birk and T. Kol, "Informed-source coding-on-demand (ISCOD) over broadcast channels," *Proc. IEEE INFOCOM*, vol. 3, pp. 1257–1264, Mar. 1998.
- [2] —, "Coding on demand by an informed source (ISCOD) for efficient broadcast of different supplemental data to caching clients," *IEEE Trans. Inf. Theory*, vol. 52, no. 6, pp. 2825–2830, Jun. 2006.
- [3] Z. Bar-Yossef, Y. Birk, T. S. Jayram, and T. Kol, "Index coding with side information," *IEEE Trans. Inf. Theory*, vol. 57, no. 3, pp. 1479–1494, Mar. 2011.
- [4] A. Blasiak, R. Kleinberg, and E. Lubetzky, "Broadcasting with side information: Bounding and approximating the broadcast rate," *IEEE Trans. Inf. Theory*, vol. 59, no. 9, pp. 5811–5823, Sept. 2013.
- [5] S. E. Rouayheb, A. Sprintson, and C. Georghiades, "On the index coding problem and its relation to network coding and matroid theory," *IEEE Trans. Inf. Theory*, vol. 56, no. 7, pp. 3187–3195, Jul. 2010.
- [6] H. Maleki, V. R. Cadambe, and S. A. Jafar, "Index coding – An interference alignment perspective," *IEEE Trans. Inf. Theory*, vol. 60, no. 9, pp. 5402–5432, Jul. 2014.
- [7] F. Arbabjolfaei, B. Bandemer, Y.-H. Kim, E. Sasoglu, and L. Wang, "On the capacity region for index coding," *Proc. IEEE Int. Symp. Inf. Theory (ISIT)*, pp. 962–966, Jul. 2013.
- [8] F. Arbabjolfaei and Y.-H. Kim, "Structural properties of index coding capacity using fractional graph theory," *Proc. IEEE Int. Symp. Inf. Theory (ISIT)*, pp. 1034–1038, Jun. 2015.
- [9] M. Tahmasbi, A. Shahrasbi, and A. Gohari, "Critical graphs in index coding," *IEEE J. Sel. Areas Commun.*, vol. 33, no. 2, pp. 225–235, Feb. 2015.
- [10] K. Shanmugam, A. G. Dimakis, and M. Langberg, "Local graph coloring and index coding," *Proc. IEEE Int. Symp. Inf. Theory (ISIT)*, pp. 1152–1156, Jul. 2013.
- [11] L. Ong, "Optimal finite-length and asymptotic index codes for five or fewer receivers," *IEEE Trans. Inf. Theory*, vol. 63, no. 11, pp. 7116–7130, Nov. 2017.
- [12] C. Thapa, L. Ong, and S. J. Johnson, "Interlinked cycles for index coding: Generalizing cycles and cliques," *IEEE Trans. Inf. Theory*, vol. 63, no. 6, pp. 3692–3711, Jun. 2017.
- [13] —, "Corrections to interlinked cycles for index coding: Generalizing cycles and cliques," *IEEE Trans. Inf. Theory*, vol. 64, no. 9, pp. 6460–6460, Sep. 2018.
- [14] K. Shanmugam, N. Golrezaei, A. G. Dimakis, A. F. Molisch, and G. Caire, "Femtocaching: Wireless content delivery through distributed caching helpers," *IEEE Trans. Inf. Theory*, vol. 59, no. 12, pp. 8402–8413, Dec. 2013.
- [15] S. E. Rouayheb, A. Sprintson, and P. Sadeghi, "On coding for cooperative data exchange," *Proc. IEEE Inf. Theory Workshop (ITW)*, pp. 1–5, Jan. 2010.
- [16] L. Ong, C. K. Ho, and F. Lim, "The single-uniprior index-coding problem: The single-sender case and the multi-sender extension," *IEEE Trans. Inf. Theory*, vol. 62, no. 6, pp. 3165–3182, Jun. 2016.
- [17] C. Thapa, L. Ong, and S. J. Johnson, "Graph-theoretic approaches to two-sender index coding," *Proc. IEEE Globecom Workshops*, pp. 1–6, Dec. 2016.
- [18] M. A. R. Chaudhry, Z. Asad, A. Sprintson, and M. Langberg, "On the complementary index coding problem," *Proc. IEEE Int. Symp. Inf. Theory (ISIT)*, pp. 224–248, Jul. 2011.
- [19] M. J. Neely, A. S. Tehrani, and Z. Zhang, "Dynamic index coding for wireless broadcast networks," *IEEE Trans. Inf. Theory*, vol. 59, no. 11, pp. 7525–7540, Nov. 2013.
- [20] P. Sadeghi, F. Arbabjolfaei, and Y.-H. Kim, "Distributed index coding," *Proc. IEEE Inf. Theory Workshop (ITW)*, pp. 330–334, Sept. 2016.

- [21] Y. Liu, P. Sadeghi, F. Arbabjolfaei, and Y.-H. Kim, “On the capacity for distributed index coding,” *Proc. IEEE Int. Symp. Inf. Theory (ISIT)*, pp. 3055–3059, Jun. 2017.
- [22] M. Li, L. Ong, and S. J. Johnson, “Improved bounds for multi-sender index coding,” *Proc. IEEE Int. Symp. Inf. Theory (ISIT)*, pp. 3060–3064, Jun. 2017.
- [23] —, “Cooperative multi-sender index coding,” *IEEE Trans. Inf. Theory*, vol. 65, no. 3, pp. 1725–1739, Mar. 2019.
- [24] —, “Multi-sender index coding for collaborative broadcasting: A rank-minimization approach,” *IEEE Trans. on Comm.*, vol. 67, no. 2, pp. 1452–1466, Feb 2019.
- [25] K. Wan, D. Tuninetti, M. Ji, G. Caire, and P. Piantanida, “Fundamental limits of decentralized data shuffling,” [Online] Available: <https://arxiv.org/pdf/1807.00056.pdf>, Mar. 2019.
- [26] A. Porter and M. Wootters, “Embedded index coding,” [Online] Available: <https://arxiv.org/pdf/1904.02179.pdf>, Apr. 2019.
- [27] F. Arbabjolfaei, “Index coding: Fundamental limits, coding schemes, and structural properties,” *Ph.D. dissertation, Dept. of Elect. and Comput. Eng. (Commun. Theory and Systems), University of California, San Diego, CA, USA*, 2017.
- [28] N. Alon, A. Hassidim, E. Lubetzky, U. Stav, and A. Weinstein, “Broadcasting with side information,” *Proc. IEEE Symp. on Found. of Comput. Sci.*, pp. 823–832, Oct. 2008.
- [29] C. Thapa, L. Ong, and S. J. Johnson, “Structural characteristics of two-sender index coding,” [Online] Available: <https://arxiv.org/pdf/1711.08150v1.pdf>, Nov. 2017.
- [30] C. Arunachala and B. S. Rajan, “Optimal scalar linear index codes for three classes of two-sender unicast index coding problem,” [Online] Available: <https://arxiv.org/pdf/1804.03823.pdf>, Apr. 2018.
- [31] C. Arunachala, V. Aggarwal, and B. S. Rajan, “Optimal linear broadcast rates of the two-sender unicast index coding problem with fully-participated interactions,” [Online] Available: <https://arxiv.org/pdf/1808.09775.pdf>, Aug. 2018.
- [32] —, “On the optimal broadcast rate of the two-sender unicast index coding problem with fully-participated interactions,” [Online] Available: <https://arxiv.org/pdf/1809.08116.pdf>, Sep. 2018.
- [33] M. Fekete, “Über die verteilung der wurzeln bei gewissen algebraischen gleichungen mit ganzzahligen koeffizienten,” *Mathematische Zeitschrift*, vol. 17, pp. 228–249, Dec. 1923.
- [34] F. Arbabjolfaei and Y.-H. Kim, “On critical index coding problems,” *Proc. IEEE Inf. Theory Workshop (ITW)*, pp. 9–13, Oct. 2015.