

Bachelorarbeit
zur Erlangung des akademischen Grades Bachelor of Science Physik

**Elektrostatische Wechselwirkung zwischen nicht identischen
geladenen Teilchen an einer elektrolytischen Grenzfläche**

**Electrostatic interaction between non-identical charged particles at
an electrolyte interface**

Timo Schmetzer

Betreuer: Dr. Arghya Majee
Prüfer: Priv.-Doz. Dr. Markus Bier

Max-Planck-Institut für intelligente Systeme Stuttgart
Universität Stuttgart

15. September 2017

Korrigierte Version vom 15. Oktober 2017

In dieser Version wurden einige nach der Abgabe gefundene Fehler korrigiert.

Abstract

In this thesis we study the lateral electrostatic interaction between a pair of non-identical, moderately charged colloidal particles trapped at an electrolyte interface in the limit of short inter-particle separations. Using a simplified model system we solve the problem analytically within the framework of linearised Poisson-Boltzmann theory and classical density functional theory. In the first step, we calculate the electrostatic potential inside the system exactly as well as within the widely used superposition approximation. Then these results are used to calculate the surface and line interaction energy densities between the particles. Contrary to the case of identical particles, depending upon the parameters of the system, we obtain that both the surface and the line interaction can vary non-monotonically with varying separation between the particles and the superposition approximation fails to predict the correct qualitative behaviours in most cases. Additionally, the superposition approximation is unable to predict the energy contributions quantitatively even at large distances. We also provide expression for the constant (independent of the inter-particle separation) interaction parameters, i.e., the surface tension, the line tension and the interfacial tension. Our results are expected to be of use for modelling particle-interaction at fluid interfaces and, in particular, for emulsion stabilization using oppositely charged particles.

Zusammenfassung

In dieser Arbeit wird die laterale elektrostatische Wechselwirkung zwischen einem Paar nicht identischer, nicht zu stark geladener Kolloidteilchen, die sich an einer Grenzfläche zwischen zwei elektrolytischen Lösungen befinden im Grenzfall kleiner Teilchenabstände diskutiert. Wir lösen das Problem in einem vereinfachten Modellsystem analytisch mithilfe von linearer Poisson-Boltzmann Theorie und klassischer Dichtefunktionaltheorie. Als erstes berechnen wir das elektrostatische Potential in dem System exakt und im Rahmen der häufig verwendeten Superpositionsnäherung. Wir benutzen diese Ergebnisse, um die Oberflächen- und Linienwechselwirkungsenergiedichten zwischen den Teilchen zu berechnen. Im Gegensatz zum Fall identischer Teilchen kann sowohl die Oberflächenenergiedichte als auch die Linienenergiedichte eine nicht monotone Veränderung bezüglich des Teilchenabstands aufweisen. Die Superpositionsnäherung kann das Verhalten der Energiebeiträge in den meisten Fällen qualitativ nicht richtig wiedergeben. Die Superpositionsnäherung kann die Energiebeiträge quantitativ nicht einmal für große Teilchenabstände korrekt wiedergeben. Wir berechnen ebenfalls die Energiebeiträge, die nicht vom Teilchenabstand abhängen, wie die Oberflächenspannung, die Linienspannung und die Grenzflächenspannung. Die Ergebnisse sollten zur Modellierung der Teilcheninteraktion an Flüssigkeitsgrenzschichten und der Emulsionsstabilisierung durch entgegengesetzt geladene Teilchen verwendet werden können.

Contents

I	Introduction	2
1	Charged colloids at an electrolyte interface	2
2	The system considered in this thesis	3
II	Density functional Theory	5
3	Classical density functional Theory	5
4	Derivation of the density functional	7
5	Derivation of the non-linear Poisson-Boltzmann equation	9
6	Derivation of the linearisation and the Energies of the linearised System	11
III	Electrostatic Potentials	14
7	Problem	14
8	Ansatz	15
9	Exact Solution	16
10	Superposition Approximation	24
11	Plots	30
IV	Interaction Energies	35
12	Calculation of Energies	35
13	Exact Solution	38
14	Superposition Solution	43
15	Solution Summary	51
16	Discussion	53
V	Conclusion	68

Chapter I

Introduction

1 Charged colloids at an electrolyte interface

Suspended colloidal particles can get trapped at a liquid-liquid interface if the decrease in system energy due to the reduction of the interfacial area is larger than the thermal energy. Typically this adsorption energy is much larger than $k_B T$ and thus particles are virtually irreversibly trapped at the interface [1]. This effect was discovered by Ramsden in 1903 [2]. The most popular application of this phenomenon is stabilization of emulsions [3, 4]. There is also a range of industrial applications, as discussed in Ref. [5].

The stability of such an effectively two dimensional system depends on the lateral forces between the particles. Forces acting on the particle generally include the van der Waals force, which is the dominating force at small distances and attractive capillary interaction, which is dominating at large distances. These attractive interactions can, however, lead to accumulation and finally coagulation of the particles. It is therefore desirable to have some additional repulsive force for the stabilization of the particles, which is often achieved by using charged colloids. However, charges can also have an averse effect on the formation of such a system and can preclude its formation by an electrostatic image force between a particle approaching the interface and an image charge of the same sign, that is caused by the dielectric jump at the interface [6].

This electrostatic interaction between colloids has received much attention. Pieranski has shown that for such charge stabilized colloids the electrostatic force can be described as the interaction between dipoles originating due to charge asymmetry around the particle [7]. The overall electrostatic interaction comprises of a screened coulombic part in polar media and a unscreened part in the non-polar media. Hurd calculated both the power law and exponential contributions to such a system within linear Poisson-Boltzmann theory for point-like particles [8].

Later, this work has been extended in numerous directions by others [7, 9, 10, 11], but almost all studies on these systems have looked at the case of particles being far away from each other, where linear superposition is a commonly used approximation. However, Ref. [1] has shown that a superposition approximation is unreliable even for large distances and shows qualitative differences for short separations. However, the limit of short particle separations is often encountered for aggregating systems and systems with a high number density [12].

The results presented in Ref. [1] only consider equally charged particles based on the prevalence of such systems in practice. However in recent years heteroaggregation (systems featuring different sorts of particles that might vary in charge, size and form etc.) have been proven to be successful in stabilizing emulsions [13] and can be used as an alternative to other more undesirable surfactants [14]. From the experimental point of view, stabilization using oppositely charged particles has also become a standard technique [13, 15, 16]. Due to the reduced net charge carried by a system of differently charged particles they are easily attached to an interface where stabilization with colloids is otherwise precluded by the image charge effect [15, 16]. In such systems particles can come to distances even smaller than a nanometre [15], highlighting the case for the introduction of a theoretical description of interaction between non-identical particles in the limit of small separations. Therefore, in this thesis, we will generalize the model presented in Ref. [1] to non-identical particles.

In the case of identical particles the model in Ref. [1] predicts that the superposition approximation underestimates interaction energies asymptotically by a factor of two compared to the exact results. The question is then if this factor is a result of the symmetry of the system or of something else. This work seeks to answer this question as well as to find out if there are any qualitative differences in the solution of the non-identical case compared to the monotonic behaviour of the solutions found in Ref. [1].

2 The system considered in this thesis

In this thesis we focus on the electrostatic interaction between particles that carry a surface charge at an electrolyte interface. Surface charges can, for example, be generated by dissolving of charged molecules from the particle to the electrolyte solution [1]. In general, different particles can carry different surface charges and a particle can have different surface charges depending on which fluid it does contact.

For simplicity we consider a system with a planar interface and a contact angle of $\frac{\pi}{2}$ between the particle and the interface, i.e. we neglect any possible curvature caused by the capillary interaction and we also ignore the thickness of the interface, which is usually of the order of the molecular lengthscale, which is much smaller than the lengthscale of interest here.

Experimental systems that fulfill these assumptions do exist [1].

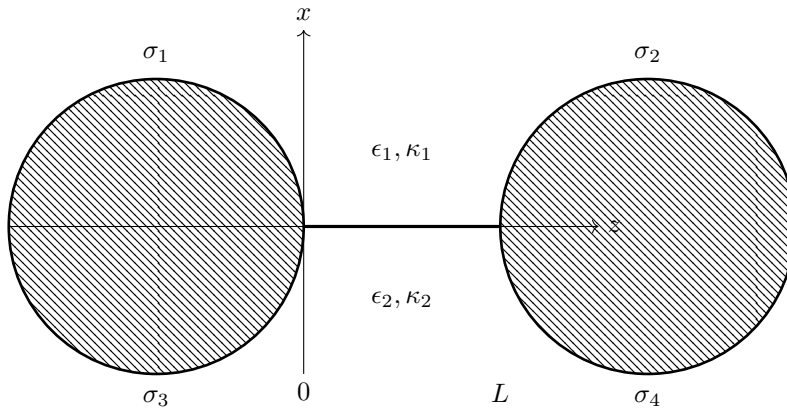


Figure I.1: Charged colloidal particles are trapped at a flat electrolyte interface. The spherical colloidal particles are separated by a distance of $L > 0$ and can carry four different surface charge densities σ_1 , σ_2 , σ_3 , and σ_4 depending on the particle and the contacted fluid. The electrolytic fluids are characterised by their dielectric constants ϵ_1 , ϵ_2 and their inverse Debye lengths κ_1 , κ_2 .

Solutions have been given for a single spherical particle [17], but no exact solution for two spherical particles is known. We focus on the limit of small distances as this is important for aggregating particles and therefore for considerations about the stability of such systems. Because of this we simplify our System and assume that for small separations between the colloidal particles the problem can be approximated by using a model of two planar walls.

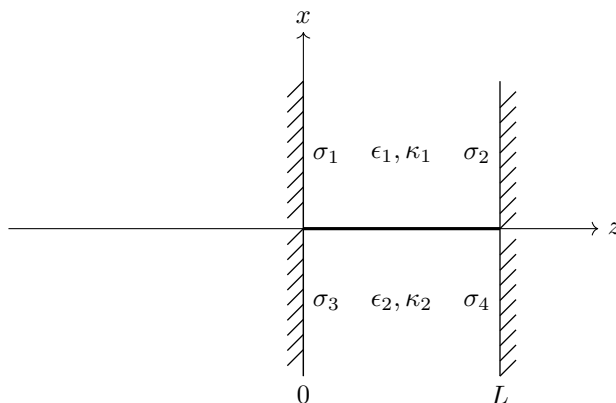


Figure I.2: Layout of the simplified model system. The system consists of two charged, planar walls at distance L from each other, that can carry four different surface charges, depending on the wall and the contacted fluid. The electrolytes are separated by a planar interface and are characterised by their dielectric constants ϵ_1 , ϵ_2 and their inverse Debye lengths κ_1 , κ_2 .

The solution strategy presented in this work is the same as in [1, 20]. We use density functional theory so we can calculate the energies with scalar quantities. The overall structure of the thesis is as follows:

Chapter II We use density functional theory to derive a density functional. From minimization of the density functional we can obtain the Poisson-Boltzmann equation. We linearise the density functional in order to be able to obtain an analytic solution. The minimization of this density functional leads to the Debye-Hückel equation and an expression of the grand canonical potential depending on the potential.

Chapter III We solve the Debye-Hückel equation for the boundary conditions of our system.

Chapter IV We use the potential from the last step and the expression obtained from density functional theory to calculate the energy of the system and separate the energy into several contributions that can be separately analyzed.

Chapter V We summarize our results.

The intermediate steps of some detailed calculations are given in grey.

Chapter II

Density functional Theory

3 Classical density functional Theory

In this chapter we will give a small introduction to classical density function theory (dft). In this endeavor we mostly follow Ref. [18].

Definiton 1. If the fluid particles do not have any degrees of freedom other than position and momentum then we call the fluid a simple fluid. Otherwise we call it a complex fluid.

Corollary 2. The microstate of a simple fluid with N particles inside a volume $V \subset \mathbb{R}^d$ is given by $\varphi = (r_1, p_1, \dots, r_N, p_N) \in (V \times \mathbb{R}^d)^N$

Corollary 3. The Hamiltonian of a simple fluid with particles of mass m inside an external potential $V(r)$ with pairwise interaction potential $U(r, r')$ is given by

$$H(\varphi) = \frac{1}{2m} \sum_{i=1}^{N(\varphi)} p_i^2 + \sum_{i=1}^{N(\varphi)} V(r_i) + \sum_{\substack{i,j=1 \\ i < j}}^{N(\varphi)} U(r_i, r_j).$$

Definiton 4. We define the (classical) trace as

$$\text{Tr}_\varphi := 1 + \sum_{n=1}^{\infty} \frac{1}{h^{dN} N!} \int_{V^N} d^{dN} r \int_{\mathbb{R}^{dN}} d^{dN} p.$$

Corollary 5. The Boltzmann distribution for the grand canonical ensemble has the probability density

$$p(\varphi) = \frac{e^{\beta(\mu N(\varphi) - H(\varphi))}}{Z}.$$

The grand canonical partition function of a fluid with chemical energy μ per particle and Hamiltonian H is given by

$$Z = \text{Tr}_\varphi \left(e^{\beta(\mu N(\varphi) - H(\varphi))} \right).$$

Definiton 6. If the single particle density observable is defined as

$$\tilde{\rho}^{(1)}(r, \varphi) := \sum_{i=1}^{N(\varphi)} \delta(r - r_i)$$

then the single particle density can be defined as

$$\rho^{(1)}(r) := \rho(r) := \left\langle \tilde{\rho}^{(1)}(r, \varphi) \right\rangle = \text{Tr}_\varphi \left(p(\varphi) \tilde{\rho}^{(1)}(r, \varphi) \right).$$

Similarly, we define the two particle density observable as

$$\tilde{\rho}^{(2)}(r, r', \varphi) := \sum_{\substack{i,j=1 \\ i \neq j}}^{N(\varphi)} \delta(r - r_i) \delta(r' - r_j)$$

and the two particle density as

$$\rho^{(2)}(r, r') := \langle \tilde{\rho}^{(2)}(r, r', \varphi) \rangle = \text{Tr}_\varphi \left(p(\varphi) \tilde{\rho}^{(1)}(r, r', \varphi) \right).$$

The pair distribution function is defined as

$$g(r, r') := \frac{\rho^{(2)}(r, r')}{\rho^{(1)}(r)\rho^{(1)}(r')}.$$

Remark 7. For fluids where we only have short range interactions it holds that

$$g(r, r') \xrightarrow{|r-r'| \rightarrow \infty} 1.$$

Theorem 8. $p(\varphi)$ minimizes the Mermin functional

$$\mathcal{M}[\tilde{p}] := \text{Tr}_\varphi \left(\tilde{p}(\varphi) (\ln(\tilde{p}(\varphi)) - \beta\mu N(\varphi) + \beta H(\varphi)) \right)$$

and the minimum is given by $\beta\Omega = -\ln Z$.

Definiton 9. Let $\rho : V \rightarrow \mathbb{R}^+$ a density function and $\tilde{p}(\varphi)$ a probability density

$$\tilde{p}|\rho : \Leftrightarrow \text{Tr}_\varphi \left(\tilde{p}(\varphi) \tilde{\rho}^{(1)}(r, \varphi) \right) = \rho(r).$$

Theorem 10.

$$\beta\Omega_0 = \min_{\tilde{p}} \mathcal{M}[\tilde{p}] = \min_{\rho} \min_{\tilde{p}|\rho} \mathcal{M}[\tilde{p}]$$

Definiton 11. We define the Density functional

$$\beta\Omega[\rho] := \min_{\tilde{p}|\rho} \mathcal{M}[\tilde{p}]$$

Theorem 12. The single particle density in the equilibrium state ρ_0 minimizes the density functional $\beta\Omega[\rho]$ and $\beta\Omega[\rho_0] = \beta\Omega_0$.

Corollary 13. It follows that

$$\left. \frac{\delta\beta\Omega[\rho]}{\delta\rho} \right|_{\rho=\rho_0} = 0$$

is a necessary condition for the equilibrium single particle density ρ_0 .

Theorem 14. The density functional of an ideal gas ($U(r_i, r_j) = 0$) is

$$\beta\Omega^{\text{id}}[\rho] = \int_V d^d r \rho(r) (\ln(\rho(r)\Lambda^d) - 1 - \beta\mu + \beta V(r))$$

with the thermal de Broglie wavelength

$$\Lambda = \sqrt{\frac{2\pi\hbar^2\beta}{m}}$$

Remark 15. There is no general method for determining the form of the density functional for $U \neq 0$. Instead of computing the exact functional, approximation methods are frequently used.

Definiton 16. We define the excess functional

$$\beta F^{\text{ex}}[\rho] = \beta\Omega[\rho] - \beta\Omega^{\text{id}}[\rho]$$

Remark 17. $\beta F^{\text{ex}}[\rho]$ depends on $U(r, r')$ but does not depend on μ or $V(r)$.

Theorem 18.

$$\beta F^{\text{ex}}[\rho, U] = \frac{\beta}{2} \int_V d^d r \int_V d^d r' \rho(r)\rho(r') U(r, r') \int_0^1 d\lambda g(r, r', [\rho, U^{(\lambda)}])$$

with $U^{(\lambda)} := \lambda U(r, r')$

Definiton 19. Random phase approximation (mean field type approximation): $g(r, r') = 1$

Corollary 20. For random phase approximation we can write the excess functional as

$$\beta F^{\text{ex}}(\rho, U) = \frac{1}{2} \int_V d^d r \int_V d^d r' \beta U(r, r') \rho(r)\rho(r')$$

4 Derivation of the density functional

In this section we derive a density functional for the following system.

4.1 The system

We describe the system in the usual three dimensional Cartesian coordinate system with axes x, y, z . Our system consists of two planar surfaces located at $z = 0$ and $z = L$ and two immiscible electrolyte solutions between the walls forming a flat interface at $x = 0$. We call the medium at $x > 0$ medium 1 and the medium at $x < 0$ medium 2. The two media are assumed to be homogeneous and structureless.

We assume that the walls carry a surface charge stemming from some chemical reaction with the fluid. As such we can have four different surface charges depending at which wall we look at and which fluid the wall is in contact with. We denote the surface charge at $z = 0, x > 0$ as σ_1 , $z = L, x > 0$ as σ_2 , $z = 0, x < 0$ as σ_3 and $z = L, x < 0$ as σ_4 , as shown in Figure II.1.

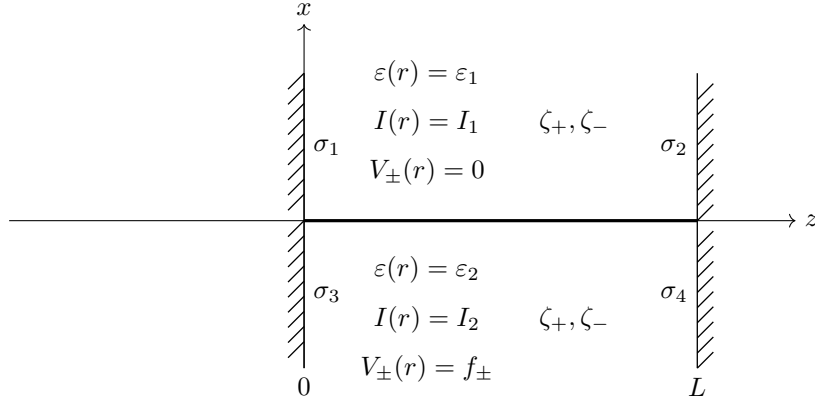


Figure II.1: Layout of our system

Each medium is assumed to be a linear dielectric medium and is characterized by a constant electrical permittivity; ε_1 in Medium 1 and ε_2 in Medium 2. Therefore the permittivity varies steplike at the interface and

$$\varepsilon(r) = \begin{cases} \varepsilon_1 & x > 0 \\ \varepsilon_2 & x < 0 \end{cases}$$

We assume that there are only two monovalent species of ions and that the ion species contained in both fluids are the same and therefore have the same fugacities ζ_{\pm} .

We assume that each fluid has a constant bulk ionic strength I , that is the concentration of ions without any outside electrostatic influences. Therefore the bulk ionic strength also varies step like at the interface and

$$I(r) = \begin{cases} I_1 & x > 0 \\ I_2 & x < 0 \end{cases}$$

Furthermore, we assume that there is a potential difference of f_+ (f_-) for the positive (negative) ions between the two media. Since we are free to choose an offset for these potentials, we simply set the potential V_{\pm} to zero in medium 1. Therefore we have

$$V_{\pm}(r) = \begin{cases} 0 & x > 0 \\ f_{\pm} & x < 0 \end{cases}$$

For our derivation to work we have to additionally assume that the resulting Debye screening length $1/\kappa(r)$ which is related to the screening thickness is larger than the size of the molecules contained in our system.

4.2 The derivation

The assumption that the Debye screening length is larger than the molecular scale allows us to neglect layering effects like ion-ion correlation, screening of ions by dipolar solvent molecules and Stern layers around objects and apply the (mean-field like) random phase approximation to derive an approximate density functional for

our system. We mostly follow Ref. [19] with some changes to incorporate our wall charges.

For two different particle sorts of ionic particles i, j with different valencies Z_i, Z_j the potential U is given by

$$\beta U(r, r') = \frac{Z_i Z_j l_B}{|r - r'|}$$

with the Bjerrum length

$$l_B := \frac{\beta e^2}{4\pi\epsilon}$$

which is the length where the electrostatic energy of two particles with a single elementary charge is equal to the thermal energy $k_B T$. The charge density due to the ions $\rho_{c,\text{int}}$ is

$$\rho_{c,\text{int}} = \sum_i Z_i e \rho_i.$$

Using this, we can write

$$\begin{aligned} \beta F^{\text{ex}}(\rho) &= \frac{1}{2} \int_V d^d r \int_V d^d r' \sum_i \sum_j \frac{Z_i Z_j l_B}{|r - r'|} \rho_i(r) \rho_j(r') \\ &= \frac{\beta}{2} \int_V d^d r \sum_i Z_i e \rho_i(r) \frac{1}{4\pi\epsilon} \int_V d^d r' \frac{\sum_j Z_j e \rho_j(r')}{|r - r'|} \\ &= \frac{\beta}{2} \int_V d^d r \rho_{c,\text{int}}(r) \frac{1}{4\pi\epsilon} \int_V d^d r' \frac{\rho_{c,\text{int}}(r')}{|r - r'|} \\ &= \frac{\beta}{2} \int_V d^d r \rho_{c,\text{int}}(r) \phi_{\text{int}}(\rho, r) \end{aligned}$$

where ϕ_{int} is the potential due to the charge of the ions.

We can write the external potential as consisting of a electrostatic part from charges outside the system volume or at its borders ($\rho_{c,\text{ext}}$) and other contributions

$$V_i(r) = \bar{V}_i(r) + Z_i e \phi_{\text{ext}}(r)$$

where ϕ_{ext} is the potential due to the external charge distribution $\rho_{c,\text{ext}}$.

So the full approximated density functional is

$$\begin{aligned} \beta \Omega[\rho] &= \int_V d^d r \sum_i \rho_i(r) (\ln(\rho_i(r) \Lambda_i^d) - 1 - \beta \mu_i + \beta V_i(r)) + \frac{\beta}{2} \rho_{c,\text{int}}(r) \phi_{\text{int}}(\rho, r) \\ &= \int_V d^d r \sum_i \rho_i(r) (\ln(\rho_i(r) \Lambda_i^d) - 1 - \beta \mu_i + \beta \bar{V}_i(r)) + \beta \sum_i Z_i e \rho_i(r) \phi_{\text{ext}}(r) + \frac{\beta}{2} \rho_{c,\text{int}}(r) \phi_{\text{int}}(\rho, r) \\ &= \int_V d^d r \sum_i \rho_i(r) \left(\ln \left(\rho_i(r) \frac{\Lambda_i^d}{\exp(\beta \mu_i)} \right) - 1 + \beta \bar{V}_i(r) \right) + \beta \rho_{c,\text{int}} \phi_{\text{ext}}(r) + \frac{\beta}{2} \rho_{c,\text{int}}(r) \phi_{\text{int}}(\rho, r) \\ &= \int_V d^d r \sum_i \rho_i(r) \left(\ln \left(\frac{\rho_i(r)}{\zeta_i} \right) - 1 + \beta \bar{V}_i(r) \right) + \beta \rho_{c,\text{int}} \phi_{\text{ext}}(r) + \frac{\beta}{2} \rho_{c,\text{int}}(r) \phi_{\text{int}}(\rho, r) \end{aligned}$$

with the fugacity

$$\zeta_i := \frac{\exp(\beta \mu_i)}{\Lambda_i^d}.$$

We rewrite the last part of the expression

$$\begin{aligned} &\beta \int_V d^d r \rho_{c,\text{int}} \phi_{\text{ext}}(r) + \frac{1}{2} \rho_{c,\text{int}}(r) \phi_{\text{int}}(\rho, r) \\ &\quad \text{since } \rho_{c,\text{int}} = \nabla \cdot D_{\text{int}}(\rho, r) \\ &= \beta \int_V d^d r (\nabla \cdot D_{\text{int}}(\rho, r)) \phi_{\text{ext}}(r) + \frac{1}{2} (\nabla \cdot D_{\text{int}}(\rho, r)) \phi_{\text{int}}(\rho, r) \end{aligned}$$

since $(\nabla \cdot D_{\text{int}}(\rho, r))\phi_{\text{int}}(\rho, r) = \nabla \cdot (\phi_{\text{int}}(\rho, r)D_{\text{int}}(\rho, r)) - D_{\text{int}}(\rho, r) \cdot \underbrace{\nabla\phi_{\text{int}}(\rho, r)}_{= -\frac{D_{\text{int}}(\rho, r)}{\varepsilon(r)}} + \text{Gau\ss}$

$$\begin{aligned}
&= \beta \int_{\partial V} \phi_{\text{ext}}(r) \underbrace{n(r) \cdot D_{\text{int}}(\rho, r)}_{=0} d^{d-1}r + \frac{1}{2}\beta \int_{\partial V} \phi_{\text{int}}(r) \underbrace{n(r) \cdot D_{\text{int}}(\rho, r)}_{=0} d^{d-1}r \\
&+ \frac{1}{2}\beta \int_V d^d r 2D_{\text{int}}(\rho, r) \frac{D_{\text{ext}}(r)}{\varepsilon(r)} + \frac{1}{2}\beta \int_V d^d r D_{\text{int}}(\rho, r) \frac{D_{\text{int}}(\rho, r)}{\varepsilon(r)} \\
&= \frac{1}{2}\beta \int_V d^d r \frac{(D_{\text{int}}(\rho, r) + D_{\text{ext}}(r))^2}{\varepsilon(r)} - \frac{1}{2}\beta \int_V d^d r \frac{D_{\text{ext}}(r)^2}{\varepsilon(r)} \\
&= \frac{1}{2}\beta \int_V d^d r \frac{D(\rho, r)^2}{\varepsilon(r)} - \frac{1}{2}\beta \int_V d^d r \frac{D_{\text{ext}}(r)^2}{\varepsilon(r)}
\end{aligned}$$

Since the last term is constant we can ignore it for the energy calculation and we rename \bar{V} to V . Our functional therefore is

$$\beta\Omega[\rho] = \int_V d^d r \sum_i \rho_i(r) \left(\ln \left(\frac{\rho_i(r)}{\zeta_i} \right) - 1 + \beta V_i(r) \right) + \frac{\beta D(r, \rho)^2}{2\varepsilon(r)}$$

5 Derivation of the non-linear Poisson-Boltzmann equation

For our system we assume that there are only two different singly and oppositely charged ion sorts, i.e.,

$$i \in \{+, -\}, Z_+ = +1, Z_- = -1.$$

The density functional then has the form

$$\beta\Omega[\rho] = \int_V d^d r \sum_{i \in \pm} \rho_i(r) \left(\ln \left(\frac{\rho_i(r)}{\zeta_i} \right) - 1 + \beta V_i(r) \right) + \frac{\beta D(r, \rho)^2}{2\varepsilon(r)}$$

Therefore,

$$\begin{aligned}
\delta_{\rho_i} \beta\Omega[\rho] &= \int_V d^d r (\delta_{\rho_i} \rho_i(r)) \left(\ln \left(\frac{\rho_i(r)}{\zeta_i} \right) - 1 + \beta V_i(r) \right) + \rho_i(r) \frac{\delta_{\rho_i} \rho_i(r)}{\zeta_i} \frac{\zeta_i}{\rho_i(r)} + \frac{\beta D(r, \rho)}{\varepsilon(r)} \cdot \delta_{\rho_i} D(r, \rho) \\
&= \int_V d^d r (\delta_{\rho_i} \rho_i(r)) \left(\ln \left(\frac{\rho_i(r)}{\zeta_i} \right) + \beta V_i(r) \right) + \frac{\beta D(r, \rho)}{\varepsilon(r)} \cdot \delta_{\rho_i} D(r, \rho).
\end{aligned}$$

The last term can be expressed in the following way.

$$\begin{aligned}
\int_V d^d r \frac{\beta D(r, \rho)}{\varepsilon(r)} \cdot \delta_{\rho_i} D(r, \rho) &= \int_V d^d r \beta E(r, \rho) \cdot \delta_{\rho_i} D(r, \rho) \\
&= \int_V d^d r \beta (-\nabla \Phi(r, \rho)) \cdot \delta_{\rho_i} D(r, \rho) \\
&= -\beta \int_V d^d r \nabla \Phi(r, \rho) \cdot \delta_{\rho_i} D(r, \rho) \\
&= -\beta \int_V d^d r \nabla(\Phi(r, \rho)) \cdot \delta_{\rho_i} D(r, \rho) - \Phi(r, \rho) \nabla \cdot \delta_{\rho_i} D(r, \rho) \\
&= -\beta \int_{\partial V} d^{d-1} r \Phi(r, \rho) n(r) \cdot \delta_{\rho_i} D(r, \rho) + \beta \int_V d^d r \Phi(r, \rho) \nabla \cdot \delta_{\rho_i} D(r, \rho) \\
&= -\beta \int_{\partial V} d^{d-1} r \Phi(r, \rho) \delta_{\rho_i} (n(r) \cdot D(r, \rho)) + \beta \int_V d^d r \Phi(r, \rho) \delta_{\rho_i} (\nabla \cdot D(r, \rho)) \\
&= -\beta \int_{\partial V} d^{d-1} r \Phi(r, \rho) \delta_{\rho_i} (-\sigma(r)) + \beta \int_V d^d r \Phi(r, \rho) \delta_{\rho_i} \left(\sum_{j \in \pm} e Z_j \rho_j(r) \right) \\
&= -\beta \int_{\partial V} d^{d-1} r \Phi(r, \rho) \cdot 0 + \beta \int_V d^d r \Phi(r, \rho) e Z_i \delta_{\rho_i} \rho_i(r)
\end{aligned}$$

Using the Euler-Lagrange-Equation

$$\delta_{\rho_i} \beta\Omega[\rho] = 0$$

we get

$$\delta_{\rho_i} \beta \Omega[\rho] = \int_V d^d r (\delta_{\rho_i} \rho_i(r)) \left(\ln \left(\frac{\rho_i(r)}{\zeta_i} \right) + \beta V_i(r) + \beta e Z_i \Phi(r, \rho) \right) = 0,$$

which implies

$$\ln \left(\frac{\rho_i(r)}{\zeta_i} \right) + \beta V_i(r) + \beta e Z_i \Phi(r, \rho) = 0.$$

We denote the deviations of the ion number densities from the bulk ion density $I(r)$ by

$$\phi_{\pm}(r) := \rho_{\pm}(r) - I(r).$$

The introduction of this quantity is not strictly necessary for this section, but it will be useful while deriving the linear theory in the next section. Using this we get

$$\begin{aligned} 0 &= \ln \left(\frac{\phi_i(r) + I(r)}{\zeta_i} \right) + \beta V_i(r) + \beta e Z_i \Phi(r, \phi) \\ &= \ln \left(\frac{I(r)}{\zeta_i} \right) + \ln \left(1 + \frac{\phi_i(r)}{I(r)} \right) + \beta V_i(r) + \beta e Z_i \Phi(r, \phi) \end{aligned} \quad (\text{II.1})$$

Bulk of Phase 1 In the bulk of medium 1, $I(r) = I_1$, $\beta V_{\pm}(r) = 0$, $\phi_{\pm}(r) = 0$, $\Phi(r, \phi) = 0$. Therefore, Eq. (II.1) gives

$$\ln \left(\frac{I_1}{\zeta_i} \right) = 0 \quad \Rightarrow \forall_{i \in \pm} I_1 = \zeta_i \quad (\text{II.2})$$

Bulk of Phase 2 In the bulk of medium 2, one has $I(r) = I_2$, $\beta V_{\pm}(r) = \beta f_{\pm}$, $\phi_{\pm}(r) = 0$, $\Phi(r, \phi) = \Phi_D$, where Φ_D is called the Donnan potential or Galvani potential difference [24]. Therefore, Eq. (II.1) gives

$$\ln \left(\frac{I_2}{\zeta_i} \right) + 0 + \beta f_i + \beta e Z_i \Phi_D = 0 \quad (\text{II.3})$$

$$\Rightarrow \ln \left(\frac{I_2}{I_1} \right) + \beta f_i + \beta e Z_i \Phi_D = 0$$

$$\Rightarrow \ln \left(\frac{I_2}{I_1} \right) + \beta f_+ + \beta e \Phi_D = 0 \quad (\text{II.4})$$

$$\ln \left(\frac{I_2}{I_1} \right) + \beta f_- - \beta e \Phi_D = 0 \quad (\text{II.5})$$

$$(\text{II.4}) - (\text{II.5}) \Rightarrow \beta(f_+ - f_-) + 2\beta e \Phi_D = 0$$

$$\Rightarrow \Phi_D = -\frac{1}{2e}(f_+ - f_-)$$

Therefore, the Donnan potential is related to the difference in the solubilities of ions in the two liquids.

$$(\text{II.4}) + (\text{II.5}) \Rightarrow 2 \ln \left(\frac{I_2}{I_1} \right) + \beta(f_+ + f_-) = 0$$

$$\Rightarrow \frac{I_2}{I_1} = e^{-\frac{\beta(f_+ + f_-)}{2}}$$

Back to non bulk Since $I(r)$, $V_i(r)$, ζ_i only depend on the bulk properties we can write in general that

$$\ln \left(\frac{I(r)}{\zeta_i} \right) + \beta V_i(r) + Z_i \beta e \varphi(r) = 0 \quad (\text{II.6})$$

with

$$\varphi(r) = \begin{cases} 0 & x > 0 \\ \Phi_D & x < 0 \end{cases}.$$

So it follows that

$$\ln \left(1 + \frac{\phi_i(r)}{I(r)} \right) + \beta e Z_i (\Phi(r, \phi) - \varphi(r)) = 0$$

$$\phi_i(r) = I(r)(\exp(-\beta e Z_i(\Phi(r, \phi) - \varphi(r))) - 1)$$

Therefore,

$$\rho_i(r) = I(r) \exp(-\beta e Z_i(\Phi(r, \phi) - \varphi(r)))$$

Gauß

$$\nabla \cdot D(r) = \sum_i e Z_i \rho_i(r) = \sum_i e Z_i \phi_i(r) + e \underbrace{\sum_i Z_i I(r)}_{=0} = e \sum_i Z_i \phi_i(r)$$

$$D(r) = -\varepsilon(r) \nabla \Phi(r)$$

$$\begin{aligned} \Rightarrow -\varepsilon(r) \Delta \Phi(r) &= e \sum_i Z_i \phi_i(r) \\ &= e I(r) (e^{-\beta e(\Phi(r, \phi) - \varphi(r))} - 1 - e^{+\beta e(\Phi(r, \phi) - \varphi(r))} + 1) \\ &= -e I(r) 2 \sinh(\beta e(\Phi(r, \phi) - \varphi(r))) \end{aligned}$$

so we get the non-linear Poisson-Boltzmann equation

$$\Delta(\beta e \Phi(r)) = \underbrace{\frac{2\beta e^2 I(r)}{\varepsilon(r)}}_{:=\kappa^2(r)} \sinh(\beta e(\Phi(r) - \varphi(r)))$$

6 Derivation of the linearisation and the Energies of the linearised System

An analytical solution for the non-linear Poisson-Boltzmann equation is only known for a system with a single wall [23]. In order to be able to solve the problem analytically we simplify the system by using a linearisation.

Considering the deviations $\phi_{\pm}(r)$ of the ion number densities from the bulk ionic strength to be small, we linearise the functional

$$\begin{aligned} \beta \Omega[\rho] &= \int_V d^d r \sum_{i \in \pm} \rho_i(r) \left(\ln \left(\frac{\rho_i(r)}{\zeta_i} \right) - 1 + \beta V_i(r) \right) + \frac{\beta D(r, \rho)^2}{2\varepsilon(r)} \\ &= \int_V d^d r \sum_{i \in \pm} I(r) \left(\ln \left(\frac{\phi_i(r) + I(r)}{\zeta_i} \right) - 1 + \beta V_i(r) \right) \\ &\quad + \int_V d^d r \sum_{i \in \pm} \phi_i(r) \left(\ln \left(\frac{\phi_i(r) + I(r)}{\zeta_i} \right) - 1 + \beta V_i(r) \right) \\ &\quad + \int_V d^d r \frac{\beta D(r, \rho)^2}{2\varepsilon(r)} \\ &= \int_V d^d r \sum_{i \in \pm} I(r) \left(\ln \left(\frac{I(r)}{\zeta_i} \right) + \ln \left(1 + \frac{\phi_i(r)}{I(r)} \right) - 1 + \beta V_i(r) \right) \\ &\quad + \int_V d^d r \sum_{i \in \pm} \phi_i(r) \left(\ln \left(\frac{I(r)}{\zeta_i} \right) + \ln \left(1 + \frac{\phi_i(r)}{I(r)} \right) - 1 + \beta V_i(r) \right) \\ &\quad + \int_V d^d r \frac{\beta D(r, \rho)^2}{2\varepsilon(r)} \\ &= \int_V d^d r \sum_{i \in \pm} I(r) \left(\ln \left(\frac{I(r)}{\zeta_i} \right) + \frac{\phi_i(r)}{I(r)} - \frac{1}{2} \frac{\phi_i(r)^2}{I(r)^2} + \mathcal{O}(\phi_i^3) - 1 + \beta V_i(r) \right) \\ &\quad + \int_V d^d r \sum_{i \in \pm} \phi_i(r) \left(\ln \left(\frac{I(r)}{\zeta_i} \right) + \frac{\phi_i(r)}{I(r)} - \frac{1}{2} \frac{\phi_i(r)^2}{I(r)^2} + \mathcal{O}(\phi_i^3) - 1 + \beta V_i(r) \right) \\ &\quad + \int_V d^d r \frac{\beta D(r, \rho)^2}{2\varepsilon(r)} \end{aligned}$$

$$\begin{aligned}
&= \int_V d^d r \sum_{i \in \pm} I(r) \left(\ln \left(\frac{I(r)}{\zeta_i} \right) - 1 + \beta V_i(r) \right) \\
&+ \int_V d^d r \sum_{i \in \pm} \phi_i(r) \left(\ln \left(\frac{I(r)}{\zeta_i} \right) + \frac{\phi_i(r)}{2I(r)} + \beta V_i(r) \right) \\
&+ \int_V d^d r \frac{\beta D(r, \rho)^2}{2\varepsilon(r)} + \mathcal{O}(\phi_i^3)
\end{aligned} \tag{II.7}$$

We define

$$\beta \mathcal{H}[\phi] := \int_V d^d r \sum_{i \in \pm} \phi_i(r) \left(\ln \left(\frac{I(r)}{\zeta_i} \right) + \frac{\phi_i(r)}{2I(r)} + \beta V_i(r) \right) + \frac{\beta D(r, \rho)^2}{2\varepsilon(r)} + \mathcal{O}(\phi_i^3)$$

this term excludes the ϕ independent bulk-contribution (II.7) to the energy.

The density then becomes

$$\phi_i(r) = -I(r)\beta e Z_i(\Phi(r, \phi) - \varphi(r)) + \mathcal{O}(\phi^2) \tag{II.8}$$

this can either be derived by using the linearised density and proceeding as in the non-linearised case or by linearisation of the analogous equation in the non-linear case.

In the same fashion the linearised Poisson-Boltzmann equation (also known as Debye-Hückel equation) can either be derived by using the linearised density and proceeding as in the non-linearised case or by linearisation of the analogous equation in the non-linear case. The Debye-Hückel equation is given by

$$\Delta(\beta e \Phi(r)) = \kappa^2(r)(\beta e(\Phi(r) - \varphi(r)))$$

with

$$\kappa^2(r) = \frac{2\beta e^2 I(r)}{\varepsilon(r)} = \begin{cases} \kappa_1^2 := \frac{2\beta e^2 I_1}{\varepsilon_1} & x > 0 \\ \kappa_2^2 := \frac{2\beta e^2 I_2}{\varepsilon_2} & x < 0 \end{cases}.$$

The linearisation depends on

$$\left| \frac{\phi_i(r)}{I(r)} \right| \ll 1 \quad \text{or} \quad |\beta e(\Phi(r) - \varphi(r))| \ll 1$$

As [21] shows this assumption can be quite problematic for some systems but can be achieved by relatively small charges.

We then proceed to rewrite the energy (without the bulk part) in terms of the potential

$$\begin{aligned}
\beta \mathcal{H}[\phi] &= \int_V d^d r \sum_{i \in \pm} \phi_i(r) \left(\ln \left(\frac{I(r)}{\zeta_i} \right) + \frac{\phi_i(r)}{2I(r)} + \beta V_i(r) \right) + \frac{\beta D(r, \rho)^2}{2\varepsilon(r)} + \mathcal{O}(\phi_i^3) \\
&\stackrel{\text{(II.6)}}{=} \int_V d^d r \sum_{i \in \pm} \phi_i(r) \left(\frac{\phi_i(r)}{2I(r)} - Z_i \beta e \varphi(r) \right) + \frac{\beta D(r, \rho)^2}{2\varepsilon(r)} + \mathcal{O}(\phi_i^3) \\
&\stackrel{\text{(II.8)}}{=} \int_V d^d r \sum_{i \in \pm} \phi_i(r) \left(-Z_i \frac{\beta}{2} e(\Phi(\phi, r) - \varphi(r)) - Z_i \beta e \varphi(r) \right) + \frac{\beta D(r, \rho)^2}{2\varepsilon(r)} + \mathcal{O}(\phi_i^3) \\
&= \int_V d^d r \left(\sum_{i \in \pm} Z_i e \phi_i(r) \right) \left(-\frac{\beta}{2}(\Phi(\phi, r) - \varphi(r)) - \beta \varphi(r) \right) + \frac{\beta D(r, \rho)^2}{2\varepsilon(r)} + \mathcal{O}(\phi_i^3) \\
&= \int_V d^d r (\nabla \cdot D) \left(-\frac{\beta}{2}(\Phi(\phi, r) + \varphi(r)) \right) + \frac{\beta D(r, \rho)^2}{2\varepsilon(r)} + \mathcal{O}(\phi_i^3) \\
&= \int_V d^d r (\nabla \cdot D) \left(-\frac{\beta}{2}(\Phi(\phi, r) + \varphi(r)) \right) - \frac{\beta}{2} D(r, \rho) \cdot \nabla \Phi(\phi, r) + \mathcal{O}(\phi_i^3) \\
&= -\frac{\beta}{2} \int_V d^d r (\nabla \cdot D)(\Phi(\phi, r) + \varphi(r)) + D(r, \rho) \cdot \nabla \Phi(\phi, r) + \mathcal{O}(\phi_i^3)
\end{aligned}$$

using $\nabla \cdot (\Phi D) = \nabla \Phi \cdot D + \Phi(\nabla \cdot D)$

$$\begin{aligned}
&= -\frac{\beta}{2} \int_V d^d r \nabla \cdot (\Phi(r) D(r)) + \varphi(r) (\nabla \cdot D(r)) + \mathcal{O}(\phi_i^3) \\
&\text{using } \nabla \cdot (\varphi D) = \nabla \varphi \cdot D + \varphi (\nabla \cdot D) \\
&= -\frac{\beta}{2} \int_V d^d r \nabla \cdot (\Phi(r) D(r)) + \nabla(\varphi(r) D(r)) - D(r) \cdot (\nabla \varphi(r)) + \mathcal{O}(\phi_i^3) \\
&\stackrel{\text{Gau\ss}}{=} -\frac{\beta}{2} \left(\int_{\partial V} d^{d-1} r n \cdot (\Phi(r) D(r) + \varphi(r) D(r)) - \int_V d^d r D(r) \cdot \underbrace{(\nabla \varphi(r))}_{=-\Phi_D \delta(x) e_x} \right) + \mathcal{O}(\phi_i^3) \\
&= -\frac{\beta}{2} \left(\int_{\partial V} d^{d-1} r \underbrace{n \cdot D(r)}_{=-\sigma(r)} (\Phi(r) + \varphi(r)) + \Phi_D \int_{x=0} d^{d-1} r D(r) \cdot e_x \right) + \mathcal{O}(\phi_i^3) \\
&= \frac{\beta}{2} \left(\int_{\partial V} d^{d-1} r \sigma(r) (\Phi(r) + \varphi(r)) - \Phi_D \int_{x=0} d^{d-1} r D(r) \cdot e_x \right) + \mathcal{O}(\phi_i^3) \tag{II.9}
\end{aligned}$$

We will use this expression to calculate the interaction energy parameters of our system in chapter IV.

Chapter III

Electrostatic Potentials

7 Problem

In this chapter we solve the electrostatic problem for the system we have defined in the previous chapter: In a three-dimensional Cartesian coordinate system we consider two infinite walls at $z = 0$ and L , and two electrolyte solutions in between, the $x = 0$ plane forming the interface between them. The fluid at $x > 0$ ($x < 0$) is called medium 1 (medium 2) and is characterized by its dielectric constant ε_1 (ε_2) and its inverse Debye length κ_1 (κ_2). The upper half ($x > 0$) of the wall at $z = 0$ (L) carries a surface-charge density σ_1 (σ_2), the lower half ($x < 0$) carries a surface-charge σ_3 (σ_4).

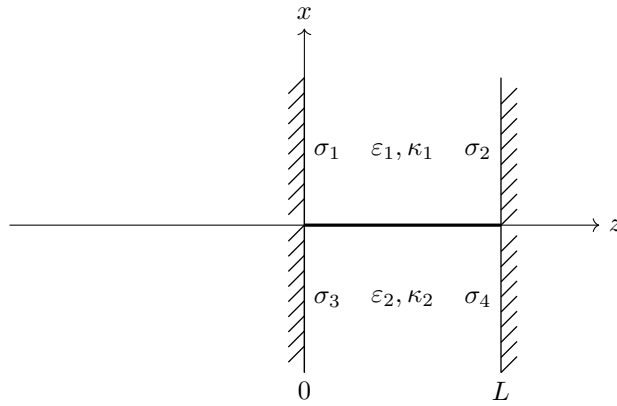


Figure III.1: Layout of the problem: Two planar charged walls with four different surface charges depending on the wall and the contacted fluid, and two different media characterized by their dielectric constants ε_i and inverse Debye lengths κ_i .

7.1 Differential equation

In the previous chapter we have derived the Debye-Hückel equation, which we solve in order to calculate the electrostatic potential for our problem:

$$\Delta \Phi(r) = \kappa^2(r)(\Phi(r) - \varphi(r)) \quad (\text{III.1})$$

with

$$\kappa(r) = \begin{cases} \kappa_1 & x > 0 \\ \kappa_2 & x < 0 \end{cases} \quad \text{and} \quad \varphi(r) = \begin{cases} 0 & x > 0 \\ \Phi_D & x < 0 \end{cases}$$

where Φ_D is the Donnan potential.

7.2 Boundary conditions

In order to obtain a unique solution of equation (III.1) we need to specify our boundary conditions. We have Neumann boundary conditions at the walls and at the interface

$$n \cdot (D_2 - D_1) = \sigma$$

which can be obtained using Gauß Law. We consider a wall medium such that the electric field immediately vanishes inside the walls like in an idealized metal-surface. Alternatively if we consider a non-metallic particle this means we neglect the image charges of the ions in the solution that are inside the wall.

Therefore we have the following boundary conditions:

1. At the walls we have $D_1 = 0$, $D_2 = \varepsilon_i E = -\varepsilon_i \nabla \Phi$ and $n = \pm e_z$ therefore the electrostatic potential should satisfy the following condition at the walls:

$$\varepsilon_i \partial_z \Phi|_{z=0,L} = \mp \sigma_k$$

2. At the interface we have $D_1 = -\varepsilon_1 \nabla \Phi$, $D_2 = -\varepsilon_2 \nabla \Phi$ and $n = -e_x$ therefore the electrostatic potential should satisfy

$$\varepsilon_1 \partial_x \Phi|_{x=0} = \varepsilon_2 \partial_x \Phi|_{x=0}$$

i.e. the displacement field should be continuous at the interface.

3. Additionally Φ must be continuous at the interface

$$\Phi(0^+, z) = \Phi(0^-, z)$$

because otherwise the displacement field would be undefined at the interface.

4. Furthermore Φ should remain finite between the walls in the limit $x \rightarrow \pm\infty$

$$\lim_{x \rightarrow \pm\infty} |\Phi(x, z)| < \infty$$

8 Ansatz

In order to find the solution $\Phi(x, z)$ of our problem we follow the strategy laid out in Ref. [20]. We consider three subproblems:

1. A fluid interface without any walls (See Fig. III.2). The potential ϕ we get from this problem fulfills the Debye-Hückel equation in each medium and satisfies the boundary conditions at the interface and for $x \rightarrow \pm\infty$. Due to the symmetry of the problem ϕ depends only on the x -coordinate, $\phi = \phi(x)$.
2. Two walls with only one medium and two different surface charges. (See Fig. III.3). The potentials ψ_1 (with medium 1), ψ_2 (with medium 2) we get from this problem fulfill the Debye-Hückel equation in their respective medium and satisfy the boundary conditions at the walls. Due to the symmetry of the problem ψ_i depends only on the z -coordinate, $\psi_i = \psi_i(z)$.

If we would simply set $\Phi(x, z) = \phi(x) + \begin{cases} \psi_1(z) & x \geq 0 \\ \psi_2(z) & x < 0 \end{cases}$, then Φ would fulfill the Debye-Hückel equation since it is linear and both $\phi(x)$ and $\psi_i(z)$ fulfill the equation. The condition for the limit to infinity holds since it is fulfilled by $\phi(x)$ and ψ_i does not depend on x . Because ϕ does not depend on z the boundary conditions at the walls that are by construction fulfilled by $\psi_i(z)$ are automatically preserved since $\partial_z \phi(x) = 0$. Because ψ_i does not depend on x the condition for the derivative of the potential at the interface that is by construction fulfilled by $\phi(x)$ will be preserved since $\partial_x \psi_i(z) = 0$, but the continuity at the interface would be violated.

To overcome the last problem we introduce another subproblem:

3. The calculation of a correction function c_i that fulfills the homogeneous Debye-Hückel equation and restores continuity at the interface but leaves the other boundary conditions unchanged.

For the final solution we set

$$\Phi(x, z) = \begin{cases} \Phi_1(x, z) & x \geq 0 \\ \Phi_2(x, z) & x \leq 0 \end{cases}$$

with

$$\Phi_i(x, z) = \phi(x) + \psi_i(z) + c_i(x, z)$$

since the Debye-Hückel equation is linear and each function fulfills this homogeneous pde in its medium and ϕ fulfills the inhomogeneous pde for medium 2, the sum of the functions is also a solution of the Debye-Hückel equation:

$$\begin{aligned}\Delta \Phi_i(x, z) &= \Delta \phi(x) + \Delta \psi_i(z) + \Delta c_i(x, z) \\ &= \kappa_i^2(\phi(x) + \delta_{i2}\Phi_D) + \kappa_i^2\psi_i(z) + \kappa_i^2c_i(x, z) \\ &= \kappa_i^2(\Phi_i(x, z) + \delta_{i2}\Phi_D)\end{aligned}$$

Furthermore

$$\begin{aligned}\partial_z \Phi_i(x, z)|_{z=0, L} &= \underbrace{\partial_z \phi(x)|_{z=0, L}}_{=0} + \partial_z \psi_i(z)|_{z=0, L} + \underbrace{\partial_z c_i(x, z)|_{z=0, L}}_{=0} \\ &= \partial_z \psi_i(z)|_{z=0, L}\end{aligned}$$

which implies that the boundary conditions at the walls are fulfilled, and

$$\begin{aligned}\partial_x \Phi_i(x, z)|_{z=0, L} &= \partial_x \phi(x)|_{z=0, L} + \underbrace{\partial_x \psi_i(z)|_{z=0, L}}_{=0} + \underbrace{\partial_x c_i(x, z)|_{z=0, L}}_{=0} \\ &= \partial_x \phi(x)|_{z=0, L}\end{aligned}$$

which implies that the boundary condition for the continuity of D at the wall is satisfied as well. Additionally, because of the way c_i is constructed the continuity at the interface is satisfied.

Thus if constructed this way $\Phi(x, z)$ will be a solution of our problem.

9 Exact Solution

Following the ansatz we will solve the three subproblems in order to derive the exact solution of the potential, which shall be denoted by Φ^e .

9.1 Subproblem 1

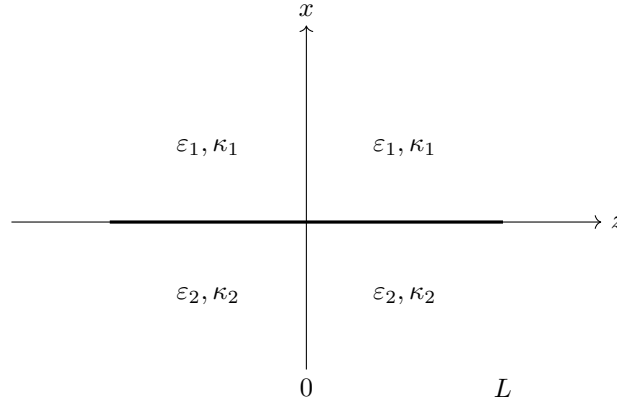


Figure III.2: Two dielectric fluids (medium 1 filling the space $x > 0$ and medium 2 filling the space $x < 0$) separated by a flat interface at $x = 0$ in absence of any walls. The media are characterized by their dielectric constants ε_i , $i \in \{1, 2\}$ and by their inverse Debye lengths κ_i , $i \in \{1, 2\}$.

Here we consider a system with two fluid media separated by an interface in the absence of any walls, as depicted in Fig. III.2. Because of the symmetry of the problem the electrostatic potential ϕ only depends on the x -coordinate:

$$\phi(x) = \begin{cases} \phi_1(x) & x \geq 0 \\ \phi_2(x) & x \leq 0 \end{cases}$$

We obtain the potential by solving the Debye-Hückel equation

$$\Delta \phi_1 = \kappa_1^2 \phi_1 \tag{III.2}$$

$$\Delta \phi_2 = \kappa_2^2(\phi_2 - \Phi_D) \quad (\text{III.3})$$

in each medium. Here Φ_D is the Donnan potential. The solution of Equations (III.2) and (III.3) are given by

$$\begin{aligned} \phi_1(x) &= Ae^{-\kappa_1 x} + Be^{\kappa_1 x} \\ \phi_2(x) &= \Phi_D + Ce^{-\kappa_2 x} + \mathcal{D}e^{\kappa_2 x} \end{aligned}$$

where A, B, C, \mathcal{D} are constants. We can immediately reduce the number of constants by using the following boundary conditions:

$$\begin{aligned} \lim_{x \rightarrow +\infty} |\phi_1(x)| < \infty &\Rightarrow B = 0 \\ \lim_{x \rightarrow -\infty} |\phi_2(x)| < \infty &\Rightarrow C = 0 \end{aligned}$$

In order to determine the remaining constants A and \mathcal{D} , we use the continuity condition for the electrostatic potential and the electric displacement vector at the interface.

1. Continuity of ϕ at the interface

$$\begin{aligned} \phi_1(0) &= \phi_2(0) \\ Ae^{-\kappa_1 \cdot 0} &= \Phi_D + \mathcal{D}e^{\kappa_2 \cdot 0} \end{aligned}$$

2. Continuity of D at the interface

$$\begin{aligned} \varepsilon_1 \partial_x \phi_1(x)|_{x=0} &= \varepsilon_2 \partial_x \phi_2(x)|_{x=0} \\ \varepsilon_1 A(-\kappa_1)e^{-\kappa_1 \cdot 0} &= \varepsilon_2 \mathcal{D} \kappa_2 e^{\kappa_2 \cdot 0} \end{aligned}$$

we can now solve this system of equations to obtain A and \mathcal{D} :

$$\begin{aligned} \Rightarrow A &= \Phi_D + \mathcal{D} \\ \Rightarrow 0 &= \varepsilon_1 \kappa_1 A + \varepsilon_2 \kappa_2 \mathcal{D} \\ \Rightarrow 0 &= \varepsilon_1 \kappa_1 (\Phi_D + \mathcal{D}) + \varepsilon_2 \kappa_2 \mathcal{D} \\ \Rightarrow \mathcal{D}(\varepsilon_1 \kappa_1 + \varepsilon_2 \kappa_2) &= -\varepsilon_1 \kappa_1 \Phi_D \\ \Rightarrow \mathcal{D} &= -\frac{\varepsilon_1 \kappa_1 \Phi_D}{\varepsilon_1 \kappa_1 + \varepsilon_2 \kappa_2} \\ \Rightarrow A = \Phi_D + \mathcal{D} &= \Phi_D - \frac{\varepsilon_1 \kappa_1 \Phi_D}{\varepsilon_1 \kappa_1 + \varepsilon_2 \kappa_2} = \frac{\varepsilon_2 \kappa_2 \Phi_D}{\varepsilon_1 \kappa_1 + \varepsilon_2 \kappa_2} \end{aligned}$$

So, finally

$$\begin{aligned} \Rightarrow \phi_1(x) &= \frac{\varepsilon_2 \kappa_2 \Phi_D}{\varepsilon_1 \kappa_1 + \varepsilon_2 \kappa_2} e^{-\kappa_1 x} \\ \Rightarrow \phi_2(x) &= \Phi_D \left(1 - \frac{\varepsilon_1 \kappa_1}{\varepsilon_1 \kappa_1 + \varepsilon_2 \kappa_2} e^{\kappa_2 x} \right) \end{aligned} \quad (\text{III.4})$$

9.2 Subproblem 2

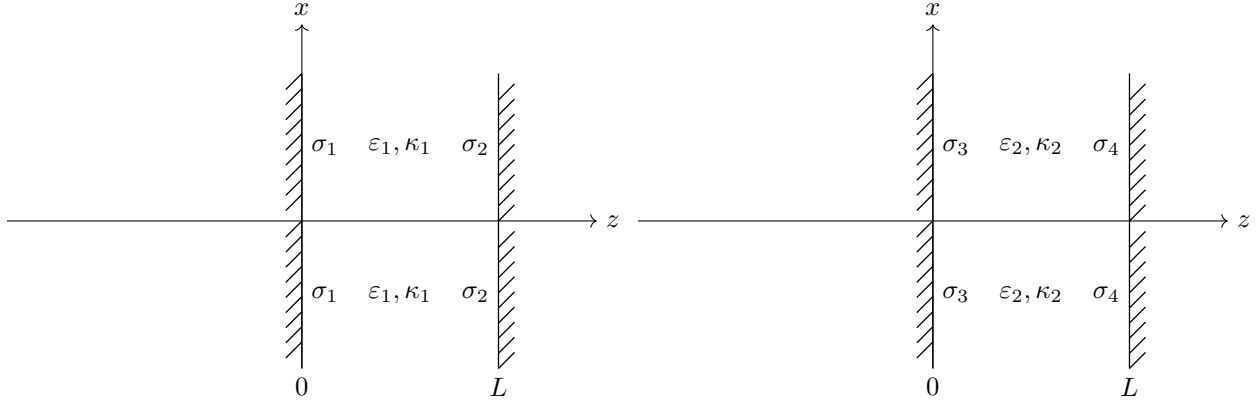


Figure III.3: The system left (right) is used to calculate ψ_1 (ψ_2). Two walls at $z = 0$ and $z = L$ with a single medium filling the space between them. The wall at $z = 0$ is homogeneously charged with charge density σ_1 (σ_3), the wall at $z = L$ is homogeneously charged with charge density σ_2 (σ_4), and the fluid is characterized by its dielectric constant ε_1 (ε_2) and its inverse Debye length κ_1 (κ_2).

Now we consider two walls in contact with a single fluid phase filling the space between them, as depicted in Fig. III.3. First we consider the case of medium 1. Because of the symmetry of the problem the solution only depends on the z -coordinate. The electrostatic potential $\psi_1(z)$ can be obtained by solving the equation

$$\Delta \psi_1 = \kappa_1^2 \psi_1$$

which has the general solution

$$\psi_1(z) = Ae^{-\kappa_1 z} + Be^{\kappa_1 z}$$

with constants A and B that can be determined by using the boundary conditions at the two walls. The boundary conditions for each wall are

1. Boundary condition for D at $z = 0$

$$\begin{aligned} n_1 \cdot D|_{z=0} &= -\varepsilon_1 \partial_z \psi_1(z)|_{z=0} = \sigma_1 \\ \varepsilon_1 (-\kappa_1) A e^{-\kappa_1 \cdot 0} + \varepsilon_1 \kappa_1 B e^{\kappa_1 \cdot 0} &= -\sigma_1 \end{aligned}$$

2. Boundary condition for D at $z = L$

$$\begin{aligned} n_2 \cdot D|_{z=L} &= \varepsilon_1 \partial_z \psi_1(z)|_{z=L} = \sigma_2 \\ \varepsilon_1 (-\kappa_1) A e^{-\kappa_1 L} + \varepsilon_1 \kappa_1 B e^{\kappa_1 L} &= \sigma_2 \end{aligned}$$

$$-\varepsilon_1 \kappa_1 A + \varepsilon_1 \kappa_1 B = -\sigma_1$$

$$-\varepsilon_1 \kappa_1 A + \varepsilon_2 \kappa_1 B e^{2\kappa_1 L} = \sigma_2 e^{\kappa_1 L}$$

$$\Rightarrow \varepsilon_1 \kappa_1 B (e^{2\kappa_1 L} - 1) = \sigma_2 e^{\kappa_1 L} + \sigma_1$$

$$\Rightarrow B = \frac{1}{\varepsilon_1 \kappa_1} \frac{\sigma_2 e^{\kappa_1 L} + \sigma_1}{e^{2\kappa_1 L} - 1} = \frac{1}{\varepsilon_1 \kappa_1} \frac{\sigma_2 + \sigma_1 e^{-\kappa_1 L}}{2 \sinh(\kappa_1 L)}$$

$$\Rightarrow -\varepsilon_1 \kappa_1 A + \frac{\sigma_2 + \sigma_1 e^{-\kappa_1 L}}{2 \sinh(\kappa_1 L)} = -\sigma_1$$

$$\Rightarrow A = \frac{1}{\varepsilon_1 \kappa_1} \frac{\sigma_2 + \sigma_1 (e^{-\kappa_1 L} + 2 \sinh(\kappa_1 L))}{2 \sinh(\kappa_1 L)} = \frac{1}{\varepsilon_1 \kappa_1} \frac{\sigma_2 + \sigma_1 e^{\kappa_1 L}}{2 \sinh(\kappa_1 L)}$$

So, finally, we can write

$$\psi_1(z) = \frac{1}{\varepsilon_1 \kappa_1 \cdot 2 \sinh(\kappa_1 L)} \underbrace{((\sigma_2 + \sigma_1 e^{\kappa_1 L}) e^{-\kappa_1 z} + (\sigma_2 + \sigma_1 e^{-\kappa_1 L}) e^{\kappa_1 z})}_{= 2\sigma_2 \cosh(\kappa_1 z) + \sigma_1 (e^{-\kappa_1(z-L)} + e^{\kappa_1(z-L)})}$$

$$= \frac{1}{\varepsilon_1 \kappa_1} \frac{\sigma_2 \cosh(\kappa_1 z) + \sigma_1 \cosh(\kappa_1(z-L))}{\sinh(\kappa_1 L)}$$

The calculation for ψ_2 is exactly the same, with σ_3 in place of σ_1 , σ_4 in place of σ_2 and ε_2 , κ_2 in place of ε_1 , κ_1 , respectively. Therefore, the potential in this case is given by

$$\psi_2(z) = \frac{1}{\varepsilon_2 \kappa_2} \frac{\sigma_4 \cosh(\kappa_2 z) + \sigma_3 \cosh(\kappa_2(z-L))}{\sinh(\kappa_2 L)}$$

9.3 Subproblem 3

In Ref. [20] the problem was symmetric, and thus $c_i(x, z)$ was symmetric in z and thereby periodic in z , so it could be written as a Fourier series in z . Because our problem is not symmetric in z we can not expect our $c_i(x, z)$ to be symmetric in z .

But to make the Fourier series approach work again, we can make the system symmetric by mirroring it on the x -axis. The mirrored system is symmetric and thus we can expand $c_i(x, z)$ in a Fourier series in z within the interval $[-L, L]$. And since our system is included in this larger system, $c_i(x, z)$ of our system is simply obtained as the restriction of the $c_i(x, z)$ of the larger system to values of z in $[0, L]$.

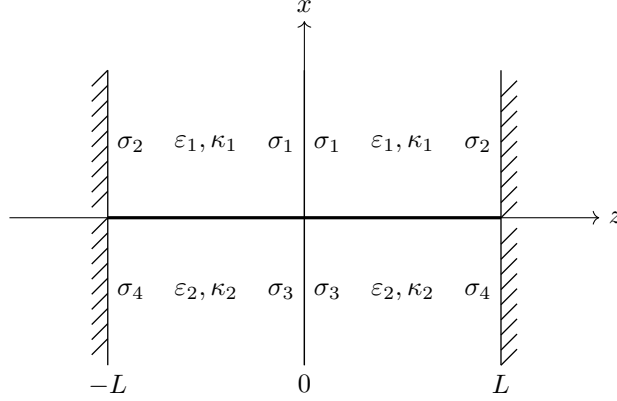


Figure III.4: Symmetrically extended system. The system in Fig. III.1 was mirrored on the x -axis.

In our extended symmetric system we can extend $\psi_i(z)$ in the expected way:

$$\psi_i(z) := \begin{cases} \psi_i(z) & z \geq 0 \\ \psi_i(-z) & z < 0 \end{cases}$$

since ϕ is only a function of x it does not need to be extended.

The conditions $c_i(x, z)$ has to fulfill in our extended system are

1. $\Delta c_i(x, z) = \kappa_i^2(x, z) \cdot c_i(x, z)$ so the pde is fulfilled
2. $\partial_z c_i(x, z)|_{z=0, \pm L} = 0$ so the boundary conditions for the surface charges stay valid
3. $\lim_{x \rightarrow \pm\infty} |c_i(x, z)| < \infty$ so Φ_i^e also stays finite in the limit $x \rightarrow \pm\infty$
4. $c_1(0, z) + \psi_1(z) = c_2(0, z) + \psi_2(z)$ since $\phi_1(0) = \phi_2(0)$ is already satisfied
5. $\varepsilon_1 \partial_x c_1(x, z)|_{x=0} = \varepsilon_2 \partial_x c_2(x, z)|_{x=0}$ so the boundary condition for the interface stays valid

We write c_i as a Fourier series in z :

$$c_i(x, z) = \frac{a_{0,i}(x)}{2} + \sum_{n=1}^{\infty} a_{n,i}(x) \cos\left(\frac{n\pi z}{L}\right) + \sum_{n=1}^{\infty} b_{n,i}(x) \sin\left(\frac{n\pi z}{L}\right)$$

Due to the symmetry of $c_i(x, z)$ in z it follows that

$$b_{n,i}(x) = \frac{1}{L} \int_{-L}^L c_i(x, z) \sin\left(\frac{n\pi z}{L}\right) dz = 0$$

Therefore,

$$c_i(x, z) = \frac{a_{0,i}(x)}{2} + \sum_{n=1}^{\infty} a_{n,i}(x) \cos\left(\frac{n\pi z}{L}\right) \quad (\text{III.5})$$

Treatment of Condition 2 The second condition listed above is automatically satisfied since

$$\begin{aligned} \partial_z c_i(x, z) &= \sum_{n=1}^{\infty} -a_{n,i}(x) \left(\frac{n\pi}{L}\right) \underbrace{\sin\left(\frac{n\pi z}{L}\right)}_{=0 \text{ for } z=0, \pm L} \\ \Rightarrow \partial_z c_i(x, z)|_{z=0, \pm L} &= 0 \end{aligned}$$

Treatment of Condition 1 Plugging the expression for $c_i(x, z)$ from Eq. (III.5) into the (homogeneous) Debye-Hückel equation given in condition 1, we obtain

$$\begin{aligned} \frac{a''_{0,i}(x)}{2} + \sum_{n=1}^{\infty} a''_{n,i}(x) \cos\left(\frac{n\pi z}{L}\right) + \sum_{n=1}^{\infty} -a_{n,i}(x) \left(\frac{n\pi}{L}\right)^2 \cos\left(\frac{n\pi z}{L}\right) \\ = \kappa_i^2 \frac{a_{0,i}(x)}{2} + \sum_{n=1}^{\infty} \kappa_i^2 a_{n,i}(x) \cos\left(\frac{n\pi z}{L}\right) \end{aligned}$$

$$\begin{aligned} \cos, \sin, \text{ constant Basis} \Rightarrow a''_{0,i}(x) &= \kappa_i^2 a_{0,i}(x) \\ a''_{n,i}(x) &= \left(\left(\frac{n\pi}{L}\right)^2 + \kappa_i^2 \right) a_{n,i}(x) \end{aligned}$$

Using condition 3 the solutions of these equations can be written as

$$\begin{aligned} \Rightarrow a_{0,1}(x) &= \mathcal{D} e^{-\kappa_1 x} \\ a_{0,2}(x) &= C e^{\kappa_2 x} \\ a_{n,1}(x) &= A_n e^{-\sqrt{\left(\frac{n\pi}{L}\right)^2 + \kappa_1^2} x} \\ a_{n,2}(x) &= B_n e^{\sqrt{\left(\frac{n\pi}{L}\right)^2 + \kappa_2^2} x} \end{aligned}$$

For brevity we define

$$p_i := \sqrt{\left(\frac{n\pi}{L}\right)^2 + \kappa_i^2}$$

Treatment of Condition 5

$$\begin{aligned} \varepsilon_1 \left(\frac{-\kappa_1 \mathcal{D}}{2} + \sum_{n=1}^{\infty} -p_1 A_n \cos\left(\frac{n\pi z}{L}\right) \right) \\ = \varepsilon_2 \left(\frac{\kappa_2 C}{2} + \sum_{n=1}^{\infty} p_2 B_n \cos\left(\frac{n\pi z}{L}\right) \right) \end{aligned}$$

$$\cos, \sin, \text{ const Basis} \Rightarrow -\varepsilon_1 \kappa_1 \mathcal{D} = \varepsilon_2 \kappa_2 C \quad (\text{III.6})$$

$$-\varepsilon_1 p_1 A_n = \varepsilon_2 p_2 B_n \quad (\text{III.7})$$

Treatment of Condition 4

$$c_1(0, z) = \frac{\mathcal{D}}{2} + \sum_{n=1}^{\infty} A_n \cos\left(\frac{n\pi z}{L}\right)$$

$$c_2(0, z) = \frac{C}{2} + \sum_{n=1}^{\infty} B_n \cos\left(\frac{n\pi z}{L}\right)$$

We develop $\Psi_1(z)$ into a Fourier series

$$\Psi_1(x, z) = \frac{\alpha_{0,1}}{2} + \sum_{n=1}^{\infty} \alpha_{n,1} \cos\left(\frac{n\pi z}{L}\right) + \sum_{n=1}^{\infty} \beta_{n,1} \sin\left(\frac{n\pi z}{L}\right)$$

Due to the Symmetry of the extended $\Psi_1(z)$ it follows that $\beta_{n,1} = 0$ for all n .

$$\begin{aligned} \alpha_{0,1} &= \frac{1}{L} \int_{-L}^L \Psi_1(z) dz \\ &\stackrel{\text{symmetry}}{=} \frac{2}{L} \int_0^L \Psi_1(z) dz \\ &= \frac{2}{L} \underbrace{\frac{1}{\varepsilon_1 \kappa_1 \sinh(\kappa_1 L)}}_{:=\gamma_1} \left(\sigma_2 \int_0^L \cosh(\kappa_1 z) dz + \sigma_1 \int_0^L \cosh(\kappa_1(z-L)) dz \right) \\ &\quad \text{subst. } z'=\kappa_1 z \quad \text{subst. } z'=\kappa_1(z-L) \\ &= \gamma_1 \left(\frac{\sigma_2}{\kappa_1} \int_0^{\kappa_1 L} \cosh(z') dz' + \frac{\sigma_1}{\kappa_1} \int_{-\kappa_1 L}^0 \cosh(z') dz' \right) \\ &= \frac{\gamma_1}{\kappa_1} (\sigma_2 \sinh(\kappa_1 L) + \sigma_1 \sinh(\kappa_1 L)) \\ &= \frac{2}{L \varepsilon_1 \kappa_1^2} (\sigma_1 + \sigma_2) \end{aligned}$$

Theorem 2.671.4 of [22] states that

$$\begin{aligned} \int \cosh(ax+b) \cos(cx+d) dx &= \frac{a}{a^2+c^2} \sinh(ax+b) \cos(cx+d) \\ &\quad + \frac{c}{a^2+c^2} \cosh(ax+b) \sin(cx+d) \\ \Rightarrow \int_0^L \cosh(az+b) \cos\left(\frac{n\pi z}{L}\right) dz &= \frac{a}{a^2 + \left(\frac{n\pi}{L}\right)^2} (\sinh(aL+b) \cdot (-1)^n + -\sinh(b)) \end{aligned}$$

$$\begin{aligned} \alpha_{n,1} &= \frac{1}{L} \int_{-L}^L \Psi_1(z) \cos\left(\frac{n\pi z}{L}\right) dz \\ &\stackrel{\text{symmetry}}{=} \frac{2}{L} \int_0^L \Psi_1(z) \cos\left(\frac{n\pi z}{L}\right) dz \\ &= \gamma_1 \left(\sigma_2 \int_0^L \cosh(\kappa_1 z) \cos\left(\frac{n\pi z}{L}\right) dz + \sigma_1 \int_0^L \cosh(\kappa_1(z-L)) \cos\left(\frac{n\pi z}{L}\right) dz \right) \\ &= \gamma_1 \sigma_2 \frac{\kappa_1}{\kappa_1^2 + \left(\frac{n\pi}{L}\right)^2} (-1)^n \sinh(\kappa_1 L) + \gamma_1 \sigma_1 \frac{\kappa_1}{\kappa_1^2 + \left(\frac{n\pi}{L}\right)^2} \sinh(\kappa_1 L) \\ &= \frac{2}{L \varepsilon_1} \frac{\sigma_1 + (-1)^n \sigma_2}{p_1^2} \end{aligned}$$

Condition 4 then becomes

$$\begin{aligned} &\frac{\mathcal{D}}{2} + \sum_{n=1}^{\infty} A_n \cos\left(\frac{n\pi z}{L}\right) + \frac{1}{L \varepsilon_1 \kappa_1^2} (\sigma_1 + \sigma_2) + \sum_{n=1}^{\infty} \frac{2}{L \varepsilon_1} \frac{\sigma_1 + (-1)^n \sigma_2}{p_1^2} \cos\left(\frac{n\pi z}{L}\right) \\ &= \frac{C}{2} + \sum_{n=1}^{\infty} B_n \cos\left(\frac{n\pi z}{L}\right) + \frac{1}{L \varepsilon_2 \kappa_2^2} (\sigma_3 + \sigma_4) + \sum_{n=1}^{\infty} \frac{2}{L \varepsilon_2} \frac{\sigma_3 + (-1)^n \sigma_4}{p_2^2} \cos\left(\frac{n\pi z}{L}\right) \end{aligned}$$

$$\cos, \sin, \text{ constant Basis} \Rightarrow \frac{\mathcal{D}}{2} + \frac{1}{L\varepsilon_1\kappa_1^2}(\sigma_1 + \sigma_2) = \frac{C}{2} + \frac{1}{L\varepsilon_2\kappa_2^2}(\sigma_3 + \sigma_4) \quad (\text{III.8})$$

$$A_n + \frac{2}{L\varepsilon_1} \frac{\sigma_1 + (-1)^n \sigma_2}{p_1^2} = B_n + \frac{2}{L\varepsilon_2} \frac{\sigma_3 + (-1)^n \sigma_4}{p_2^2} \quad (\text{III.9})$$

Conditions To calculate C , \mathcal{D} we use Eq. (III.6) and (III.8):

$$\begin{aligned} -\varepsilon_1\kappa_1\mathcal{D} &= \varepsilon_2\kappa_2C \\ \frac{\mathcal{D}}{2} + \frac{1}{L\varepsilon_1\kappa_1^2}(\sigma_1 + \sigma_2) &= \frac{C}{2} + \frac{1}{L\varepsilon_2\kappa_2^2}(\sigma_3 + \sigma_4) \end{aligned}$$

$$\begin{aligned} \mathcal{D} &= -\frac{\varepsilon_2\kappa_2}{\varepsilon_1\kappa_1}C \\ C &= \mathcal{D} + \frac{2}{L\varepsilon_1\kappa_1^2}(\sigma_1 + \sigma_2) - \frac{2}{L\varepsilon_2\kappa_2^2}(\sigma_3 + \sigma_4) \\ C &= \frac{1}{1 + \frac{\varepsilon_2\kappa_2}{\varepsilon_1\kappa_1}} \left(\frac{2}{L\varepsilon_1\kappa_1^2}(\sigma_1 + \sigma_2) - \frac{2}{L\varepsilon_2\kappa_2^2}(\sigma_3 + \sigma_4) \right) \\ C &= \frac{\varepsilon_1\kappa_1}{\varepsilon_1\kappa_1 + \varepsilon_2\kappa_2} \left(\frac{2}{L\varepsilon_1\kappa_1^2}(\sigma_1 + \sigma_2) - \frac{2}{L\varepsilon_2\kappa_2^2}(\sigma_3 + \sigma_4) \right) \end{aligned}$$

$$\begin{aligned} C &= \frac{2}{L} \frac{1}{\varepsilon_1\kappa_1 + \varepsilon_2\kappa_2} \left(\frac{1}{\kappa_1}(\sigma_1 + \sigma_2) - \frac{\varepsilon_1\kappa_1}{\varepsilon_2\kappa_2^2}(\sigma_3 + \sigma_4) \right) \\ \mathcal{D} &= \frac{2}{L} \frac{1}{\varepsilon_1\kappa_1 + \varepsilon_2\kappa_2} \left(\frac{1}{\kappa_2}(\sigma_3 + \sigma_4) - \frac{\varepsilon_2\kappa_2}{\varepsilon_1\kappa_1^2}(\sigma_1 + \sigma_2) \right) \end{aligned}$$

To calculate A_n , B_n we use Eq. (III.7) and (III.9):

$$\begin{aligned} -\varepsilon_1p_1A_n &= \varepsilon_2p_2B_n \\ A_n + \frac{2}{L\varepsilon_1} \frac{\sigma_1 + (-1)^n \sigma_2}{p_1^2} &= B_n + \frac{2}{L\varepsilon_2} \frac{\sigma_3 + (-1)^n \sigma_4}{p_2^2} \end{aligned}$$

$$\begin{aligned} A_n &= -\frac{\varepsilon_2p_2}{\varepsilon_1p_1} \\ B_n - A_n &= \frac{2}{L\varepsilon_1} \frac{\sigma_1 + (-1)^n \sigma_2}{p_1^2} - \frac{2}{L\varepsilon_2} \frac{\sigma_3 + (-1)^n \sigma_4}{p_2^2} \\ B_n &= \frac{1}{1 + \frac{\varepsilon_2p_2}{\varepsilon_1p_1}} \left(\frac{2}{L\varepsilon_1} \frac{\sigma_1 + (-1)^n \sigma_2}{p_1^2} - \frac{2}{L\varepsilon_2} \frac{\sigma_3 + (-1)^n \sigma_4}{p_2^2} \right) \\ B_n &= \frac{2}{L} \frac{\varepsilon_1p_1}{\varepsilon_1p_1 + \varepsilon_2p_2} \left(\frac{\sigma_1 + (-1)^n \sigma_2}{\varepsilon_1} \frac{1}{p_1^2} - \frac{\sigma_3 + (-1)^n \sigma_4}{\varepsilon_2} \frac{1}{p_2^2} \right) \\ A_n &= \frac{2}{L} \frac{\varepsilon_2p_2}{\varepsilon_1p_1 + \varepsilon_2p_2} \left(\frac{\sigma_3 + (-1)^n \sigma_4}{\varepsilon_2} \frac{1}{p_2^2} - \frac{\sigma_1 + (-1)^n \sigma_2}{\varepsilon_1} \frac{1}{p_1^2} \right) \end{aligned}$$

Finally

$$\begin{aligned} c_1(x, z) &= \frac{1}{L} \frac{1}{\kappa_1\varepsilon_1 + \kappa_2\varepsilon_2} \left(\frac{\sigma_3 + \sigma_4}{\kappa_2} - \frac{1}{\kappa_1} \frac{\kappa_2\varepsilon_2}{\kappa_1\varepsilon_1} (\sigma_1 + \sigma_2) \right) \\ &+ \sum_{n=1}^{\infty} \frac{2}{L} \frac{\varepsilon_2p_2}{\varepsilon_1p_1 + \varepsilon_2p_2} \left(\frac{\sigma_3 + (-1)^n \sigma_4}{\varepsilon_2} \frac{1}{p_2^2} - \frac{\sigma_1 + (-1)^n \sigma_2}{\varepsilon_1} \frac{1}{p_1^2} \right) e^{-p_1x} \cos\left(\frac{n\pi z}{L}\right) \end{aligned}$$

$$\begin{aligned} c_2(x, z) &= \frac{1}{L} \frac{1}{\kappa_1\varepsilon_1 + \kappa_2\varepsilon_2} \left(\frac{\sigma_1 + \sigma_2}{\kappa_1} - \frac{1}{\kappa_2} \frac{\kappa_1\varepsilon_1}{\kappa_2\varepsilon_2} (\sigma_3 + \sigma_4) \right) \\ &+ \sum_{n=1}^{\infty} \frac{2}{L} \frac{\varepsilon_1p_1}{\varepsilon_1p_1 + \varepsilon_2p_2} \left(\frac{\sigma_1 + (-1)^n \sigma_2}{\varepsilon_1} \frac{1}{p_1^2} - \frac{\sigma_3 + (-1)^n \sigma_4}{\varepsilon_2} \frac{1}{p_2^2} \right) e^{p_2x} \cos\left(\frac{n\pi z}{L}\right) \end{aligned}$$

9.4 Solution

Adding the solutions of the three subproblems, one finally obtains the expressions for the potentials in the two media:

$$\begin{aligned}\Phi_1^e(x, z) &= \frac{\sigma_1 \cosh(\kappa_1(L - z)) + \sigma_2 \cosh(\kappa_1 z)}{\varepsilon_1 \kappa_1 \sinh(\kappa_1 L)} \\ &+ \frac{\kappa_2 \varepsilon_2 \Phi_D}{\kappa_1 \varepsilon_1 + \kappa_2 \varepsilon_2} e^{-\kappa_1 x} \\ &+ \frac{1}{L} \frac{1}{\kappa_1 \varepsilon_1 + \kappa_2 \varepsilon_2} \left(\frac{\sigma_3 + \sigma_4}{\kappa_2} - \frac{1}{\kappa_1} \frac{\kappa_2 \varepsilon_2}{\kappa_1 \varepsilon_1} (\sigma_1 + \sigma_2) \right) e^{-\kappa_1 x} \\ &+ \sum_{n=1}^{\infty} \frac{2}{L} \frac{\varepsilon_2 p_2}{\varepsilon_1 p_1 + \varepsilon_2 p_2} \left(\frac{\sigma_3 + (-1)^n \sigma_4}{\varepsilon_2} \frac{1}{p_2^2} - \frac{\sigma_1 + (-1)^n \sigma_2}{\varepsilon_1} \frac{1}{p_1^2} \right) e^{-p_1 x} \cos\left(\frac{n\pi z}{L}\right)\end{aligned}$$

$$\begin{aligned}\Phi_2^e(x, z) &= \frac{\sigma_3 \cosh(\kappa_2(L - z)) + \sigma_4 \cosh(\kappa_2 z)}{\varepsilon_2 \kappa_2 \sinh(\kappa_2 L)} \\ &+ \Phi_D - \frac{\kappa_1 \varepsilon_1 \Phi_D}{\kappa_1 \varepsilon_1 + \kappa_2 \varepsilon_2} e^{\kappa_2 x} \\ &+ \frac{1}{L} \frac{1}{\kappa_1 \varepsilon_1 + \kappa_2 \varepsilon_2} \left(\frac{\sigma_1 + \sigma_2}{\kappa_1} - \frac{1}{\kappa_2} \frac{\kappa_1 \varepsilon_1}{\kappa_2 \varepsilon_2} (\sigma_3 + \sigma_4) \right) e^{\kappa_2 x} \\ &+ \sum_{n=1}^{\infty} \frac{2}{L} \frac{\varepsilon_1 p_1}{\varepsilon_1 p_1 + \varepsilon_2 p_2} \left(\frac{\sigma_1 + (-1)^n \sigma_2}{\varepsilon_1} \frac{1}{p_1^2} - \frac{\sigma_3 + (-1)^n \sigma_4}{\varepsilon_2} \frac{1}{p_2^2} \right) e^{p_2 x} \cos\left(\frac{n\pi z}{L}\right)\end{aligned}$$

9.5 Consistency with literature

We test our expression for consistency with the result of Ref. [20]. Since in Ref. [20] the walls are located at $z = \pm L$, we need to do a transformation in order to compare the results. For this we have to set

$$\begin{aligned}L &= 2L' \\ z &= z' + L' \\ \sigma'_1 &= \sigma_1 = \sigma_2 \\ \sigma'_2 &= \sigma_3 = \sigma_4\end{aligned}$$

We transform each line of our expression for $\Phi^e(x, z)$ separately and compare with Ref. [20].

Line 1

$$\begin{aligned}\kappa_1(L - z) &= \kappa_1(2L' - (z' + L')) = \kappa_1(L' - z') \\ \kappa_1 z &= \kappa_1(z' + L') \\ \frac{\sigma_1 \cosh(\kappa_1(L - z)) + \sigma_2 \cosh(\kappa_1 z)}{\varepsilon_1 \kappa_1 \sinh(\kappa_1 L)} &= \frac{\sigma'_1}{\kappa_1 \varepsilon_1} \frac{\cosh(\kappa_1(L' - z')) + \cosh(\kappa_1(z' + L'))}{\sinh(2\kappa_1 L')} \\ &= \frac{\sigma'_1}{\kappa_1 \varepsilon_1} \frac{1}{2 \sinh(\kappa_1 L') \cosh(\kappa_1 L')} \cdot \frac{1}{2} \left(e^{\kappa_1 L' - \kappa_1 z'} + e^{-\kappa_1 L' + \kappa_1 z'} + e^{\kappa_1 L' + \kappa_1 z'} + e^{-\kappa_1 L' - \kappa_1 z'} \right) \\ &= \frac{\sigma'_1}{\kappa_1 \varepsilon_1} \frac{1}{2 \sinh(\kappa_1 L') \cosh(\kappa_1 L')} \cdot \frac{1}{2} \left(e^{\kappa_1 L'} 2 \cosh(\kappa_1 z') + e^{-\kappa_1 L'} 2 \cosh(\kappa_1 z') \right) \\ &= \frac{\sigma'_1}{\kappa_1 \varepsilon_1} \frac{\cosh(\kappa_1 z')}{\sinh(\kappa_1 L')} \quad \checkmark\end{aligned}$$

Line 2 Nothing to be done.

Line 3

$$\frac{1}{L} \frac{1}{\kappa_1 \varepsilon_1 + \kappa_2 \varepsilon_2} \left(\frac{\sigma_3 + \sigma_4}{\kappa_2} - \frac{1}{\kappa_1} \frac{\kappa_2 \varepsilon_2}{\kappa_1 \varepsilon_1} (\sigma_1 + \sigma_2) \right) e^{-\kappa_1 x}$$

$$\begin{aligned}
&= \frac{1}{L'} \frac{\frac{1}{\kappa_2 \varepsilon_2}}{1 + \frac{\kappa_1 \varepsilon_1}{\kappa_2 \varepsilon_2}} \left(\frac{\sigma'_2}{\kappa_2} - \frac{1}{\kappa_1} \frac{\kappa_2 \varepsilon_2}{\kappa_1 \varepsilon_1} \sigma'_1 \right) e^{-\kappa_1 x} \\
&= \frac{1}{L'} \frac{\frac{\sigma'_2}{\varepsilon_2 \kappa_2} - \frac{\sigma'_1}{\varepsilon_1 \kappa_1}}{1 + \frac{\kappa_1 \varepsilon_1}{\kappa_2 \varepsilon_2}} e^{-\kappa_1 x} \quad \checkmark
\end{aligned}$$

Line 4

$$\begin{aligned}
\sigma_1 + (-1)^n \sigma_2 &= \sigma'_1 + (-1)^n \sigma'_1 = \begin{cases} 2\sigma'_1 & n \text{ even} \\ 0 & n \text{ odd} \end{cases} \\
\sigma_3 + (-1)^n \sigma_4 &= \sigma'_2 + (-1)^n \sigma'_2 = \begin{cases} 2\sigma'_2 & n \text{ even} \\ 0 & n \text{ odd} \end{cases}
\end{aligned}$$

so we can define $n' := \frac{n}{2}$ and write

$$\begin{aligned}
p_i &= \sqrt{\left(\frac{n\pi}{L}\right)^2 + \kappa_i^2} = \sqrt{\left(\frac{n\pi}{2L'}\right)^2 + \kappa_i^2} = \sqrt{\left(\frac{n'\pi}{L'}\right)^2 + \kappa_i^2} \\
\cos\left(\frac{n\pi z}{L}\right) &= \cos\left(\frac{n\pi(z' + L')}{2L'}\right) = \cos\left(\frac{n'\pi(z' + L')}{L'}\right) = \cos\left(\frac{n'\pi z'}{L'} + n'\pi\right) = (-1)^{n'} \cos\left(\frac{n'\pi z'}{L'}\right)
\end{aligned}$$

and

$$\begin{aligned}
&\sum_{n=1}^{\infty} \frac{2}{L} \frac{\varepsilon_2 p_2}{\varepsilon_1 p_1 + \varepsilon_2 p_2} \left(\frac{\sigma_3 + (-1)^n \sigma_4}{\varepsilon_2} \frac{1}{p_2^2} - \frac{\sigma_1 + (-1)^n \sigma_2}{\varepsilon_1} \frac{1}{p_1^2} \right) e^{-p_1 x} \cos\left(\frac{n\pi z}{L}\right) \\
&= \sum_{n'=1}^{\infty} \frac{2}{2L'} \frac{\varepsilon_2 p_2}{\varepsilon_1 p_1 + \varepsilon_2 p_2} \left(\frac{2\sigma'_2}{\varepsilon_2} \frac{1}{p_2^2} - \frac{2\sigma'_1}{\varepsilon_1} \frac{1}{p_1^2} \right) e^{-p_1 x} (-1)^{n'} \cos\left(\frac{n'\pi z}{L'}\right) \\
&= \frac{2}{L'} \sum_{n'=1}^{\infty} (-1)^{n'} \frac{1}{1 + \frac{\varepsilon_1 p_1}{\varepsilon_2 p_2}} \left(\frac{\sigma'_2}{\varepsilon_2} \frac{1}{p_2^2} - \frac{\sigma'_1}{\varepsilon_1} \frac{1}{p_1^2} \right) e^{-p_1 x} \cos\left(\frac{n'\pi z}{L'}\right) \quad \checkmark
\end{aligned}$$

Therefore we can obtain the result for the case of identical particles given in Ref. [20] from our general expressions.

10 Superposition Approximation

In the superposition approximation the potential is approximated using the sum of the potentials of two systems (see Fig. III.5) with one wall each. We will call the superposition potential Φ^s .

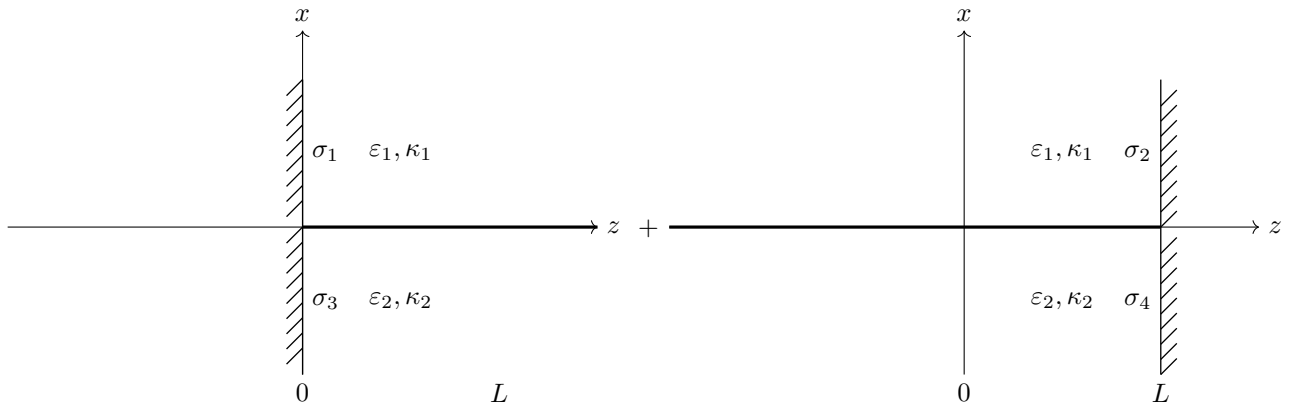


Figure III.5: We consider two different systems. One system (left) with a wall at $z = 0$ where the half space $z > 0$ is filled with two media forming an interface at $x = 0$. The other system (right) with a wall at $z = L$ where the half space $z < L$ is filled with two media forming an interface at $x = 0$. In both cases the medium residing in the space $x > 0$ ($x < 0$) is called medium 1 (2) and is characterized by its dielectric constant ε_1 (ε_2). In the first case (left) the wall carries a surface charge density of σ_1 for $x > 0$ and σ_3 for $x < 0$. In the second case (right) the wall carries a surface charge density of σ_2 for $x > 0$ and σ_4 for $x < 0$.

Because we simply add the solutions, Φ^s will fulfill boundary conditions at the interface and at infinity. But the Debye-Hückel equation will only be exactly fulfilled for $x > 0$. If the solution of the problem depicted in the left side of Fig. III.5 is denoted by $\Phi^{\sigma_1, \sigma_3}(x, z)$ and the solution of the problem depicted in the right side of Fig. III.5 is denoted by $\Phi^{\sigma_2, \sigma_4}(x, -(z-L))$, then

$$\begin{aligned}\Delta \Phi^s(x, z) &= \Delta \Phi^{\sigma_1, \sigma_3}(x, z) + \Delta \Phi^{\sigma_2, \sigma_4}(x, -(z-L)) \\ &= \kappa^2(x, z)(\Phi^{\sigma_1, \sigma_3}(x, z) - \varphi(x, z)) + \kappa^2(x, -(z-L))(\Phi^{\sigma_2, \sigma_4}(x, -(z-L)) - \varphi(x, -(z-L))) \\ &= \kappa^2(x, z)(\Phi^s(x, z) - 2\varphi(x, z)).\end{aligned}$$

It doesn't behave correctly in the "bulk limit" $\sigma_1 = \sigma_2 = \sigma_3 = \sigma_4 = 0$ and $L \rightarrow \infty$ ($\Phi^{s, \text{bulk}}(r) = 2\varphi(r)$ instead of $\varphi(r)$) for the same reason. The boundary condition at the walls will also be violated because each solution adds some value to the normal derivative at the wall in the other solution. Since $\Phi^s(x, z) \rightarrow 0$ for $x \rightarrow \pm\infty$, this error will become smaller for larger L . That is why it may be a better approximation for large values of L but certainly not for small L .

Please note that we only add the potentials of the systems. The calculation of the energies will not use such an addition and will be entirely based on the expression of $\Phi^s(x, z)$ derived here.

We calculate the potential for the first system depicted in III.6. We will call this solution $\Phi^{\sigma_k, \sigma_l}$. The solution for the complete System can then be determined by coordinate transformation and exchange of σ 's (see Eq. (III.10)).

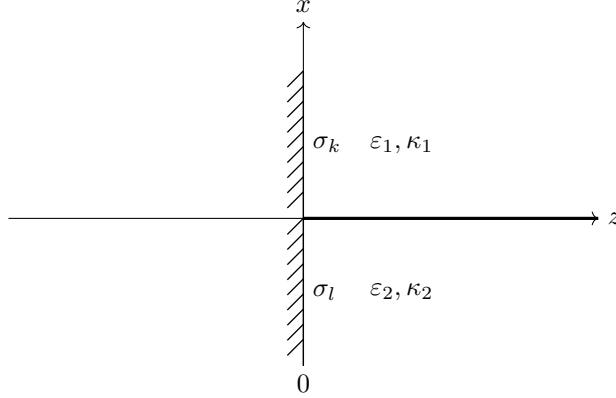


Figure III.6: The system has a wall at $z = 0$, and the half space $z > 0$ is filled with two media forming an interface at $x = 0$. The medium residing in the space $x > 0$ ($x < 0$) is called medium 1 (2) and is characterized by its dielectric constant ε_1 (ε_2). The wall carries a surface charge density of σ_k for $x > 0$ and σ_l for $x < 0$.

We again employ the same ansatz as used for the exact solution, with the systems changed appropriately. So our subproblems will be

1. A fluid interface without any walls. (See Fig. III.2). The potential ϕ we get from this problem fulfills the Poisson-Boltzmann equation in each medium and satisfies the boundary conditions at the interface and for $x \rightarrow \pm\infty$. Due to the symmetry of the problem ϕ depends only on the x -coordinate, $\phi = \phi(x)$. This problem is exactly the same as the first subproblem from the exact solution.
2. A wall with only one medium and a single surface charge. (See Fig. III.7). The potentials ψ_1 (with medium 1), ψ_2 (with medium 2) we get from this problem fulfill the Poisson-Boltzmann equation in their respective medium and satisfy the boundary conditions at the wall. Due to the symmetry of the problem ψ_i depends only on the z -coordinate, $\psi_i = \psi_i(z)$.
3. The calculation of a correction function c_i that fulfills the homogenous Poisson-Boltzmann equation and restores continuity at the interface but leaves the other boundary conditions unchanged.

For the solution of the system we set

$$\Phi^{\sigma_k, \sigma_l}(x, z) = \begin{cases} \Phi_1^{\sigma_k, \sigma_l}(x, z) & x \geq 0 \\ \Phi_2^{\sigma_k, \sigma_l}(x, z) & x \leq 0 \end{cases}$$

with

$$\Phi_i^{\sigma_k, \sigma_l}(x, z) = \phi(x) + \psi_i(z) + c_i(x, z)$$

and the final solution will be given by

$$\Phi^s(x, z) = \Phi^{\sigma_1, \sigma_3}(x, z) + \Phi^{\sigma_2, \sigma_4}(x, -(z - L)) \quad (\text{III.10})$$

10.1 Subproblem 1

Subproblem 1 is the same as subproblem 1 of the exact solution. Its solutions are given by Eq. (III.4).

$$\phi_1(x) = \frac{\varepsilon_2 \kappa_2 \Phi_D}{\varepsilon_1 \kappa_1 + \varepsilon_2 \kappa_2} e^{-\kappa_1 x}$$

$$\phi_1(x) = \Phi_D \left(1 - \frac{\varepsilon_1 \kappa_1}{\varepsilon_1 \kappa_1 + \varepsilon_2 \kappa_2} e^{\kappa_2 x} \right)$$

10.2 Subproblem 2

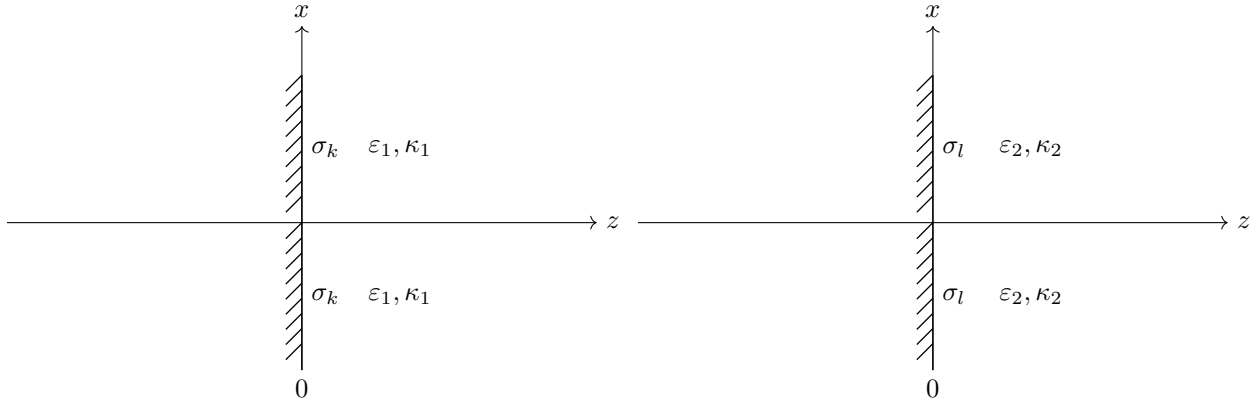


Figure III.7: The system left (right) is used to calculate ψ_1 (ψ_2). The system has a wall at $z = 0$ and a single medium filling the half space $z > 0$. The wall at is homogenously charged with charge density σ_k (σ_l), and the fluid is characterized by its dielectric constant ε_1 (ε_2) and its inverse Debye length κ_1 (κ_2).

We first solve the problem for ψ_1 , as depicted and described in Fig. III.7. The electrostatic potential is obtained by solving the following Debye-Hückel equation

$$\Delta \psi_1 = \kappa_1^2 \psi_1$$

The general solution is

$$\psi_1(z) = E e^{-\kappa_1 z} + F e^{\kappa_1 z}$$

with constants E and F . The potential ψ should be finite for $x \rightarrow \infty$. Therefore, $F = 0$. With the boundary condition at the wall

$$\varepsilon_1 \partial_z \psi_1(z)|_{z=0} = -\sigma_k$$

we obtain

$$\varepsilon_1 E (-\kappa_1) = \sigma_k \Rightarrow E = \frac{\sigma_k}{\varepsilon_1 \kappa_1}$$

So, finally

$$\psi_1(z) = \frac{\sigma_k}{\varepsilon_1 \kappa_1} e^{-\kappa_1 z}$$

The calculation for ψ_2 is exactly the same, with σ_l in place of σ_k and ε_2, κ_2 in place of ε_1, κ_1 , respectively. Therefore, the potential in this case is given by

$$\psi_2(z) = \frac{\sigma_l}{\varepsilon_2 \kappa_2} e^{-\kappa_2 z}$$

10.3 Subproblem 3

The conditions $c_i(x, z)$ has to fulfill in our extended system are as follows:

1. $\Delta c_i(x, z) = \kappa_i^2(x, z)$ so the pde is fulfilled
2. $\partial_z c_i(x, z)|_{z=0} = 0$ so the boundary conditions for the surface charges stay valid
3. $\lim_{x \rightarrow \pm\infty} |c_i(x, z)| < \infty$ so the same will hold for Φ_i^e .
4. $c_1(0, z) + \psi_1(z) = c_2(0, z) + \psi_2(z)$ since $\phi_1(0) = \phi_2(0)$ is already satisfied
5. $\varepsilon_1 \partial_x c_1(x, z)|_{x=0} = \varepsilon_2 \partial_x c_2(x, z)|_{x=0}$ so the boundary condition for the interface stays valid

Since we now have a semi-infinite system we use a Fourier transform in z instead of the Fourier series used in the exact solution. In the following calculation we will transform all the conditions for $c_i(x, z)$ to conditions for the Fourier transformation $\hat{c}_i(x, q) = \mathcal{F}[c_i(x, z)]$ and then derive an explicit solution for $\hat{c}_i(x, q)$.

Treatment of Condition 1

$$\begin{aligned} (\partial_x^2 + \partial_z^2 - \kappa_i^2)c_i(x, z) &= 0 & | \mathcal{F} \\ (\partial_x^2 - q^2 - \kappa_i^2)\hat{c}_i(x, q) &= 0 & \hat{c}_i(x, q) = \int_{-\infty}^{\infty} c_i(x, z)e^{-iqz} dz \end{aligned}$$

$$\begin{aligned} \stackrel{3}{\Rightarrow} \hat{c}_1(x, q) &= M_1(q)e^{-p_1 x} & \text{with } p_i := \sqrt{q^2 + \kappa_i^2} \\ \hat{c}_2(x, q) &= M_2(q)e^{p_2 x} \end{aligned}$$

Treatment of Condition 5

$$\begin{aligned} \varepsilon_1 \partial_x c_1(x, z)|_{x=0} &= \varepsilon_2 \partial_x c_2(x, z)|_{x=0} & | \mathcal{F} \\ \varepsilon_1 \partial_x \hat{c}_1(x, q)|_{x=0} &= \varepsilon_2 \partial_x \hat{c}_2(x, q)|_{x=0} \\ \Rightarrow \varepsilon_1(-p_1)M_1(q) &= \varepsilon_2 p_2 M_2(q) \end{aligned} \tag{III.11}$$

Treatment of Condition 4

$$\begin{aligned} c_1(0, z) + \psi_1(z) &= c_2(0, z) + \psi_2(z) & | \mathcal{F} \\ \hat{c}_1(0, q) + \hat{\psi}_1(q) &= \hat{c}_2(0, q) + \hat{\psi}_2(q) \end{aligned} \tag{III.12}$$

To proceed further, we need to first calculate the Fourier transform $\hat{\psi}_i(q)$ of $\psi_i(z)$.

$$\begin{aligned} \hat{\psi}_1(q) &= \int_{-\infty}^{\infty} \psi_1(z)e^{-iqz} dz \\ &= \frac{\sigma_k}{\varepsilon_1 \kappa_1} \left(\int_0^{\infty} e^{-\kappa_1 z} e^{-iqz} dz + \int_{-\infty}^0 e^{\kappa_1 z} e^{-iqz} dz \right) \\ &= \frac{\sigma_k}{\varepsilon_1 \kappa_1} \left(\int_0^{\infty} e^{-(\kappa_1 + iq)z} dz + \int_{-\infty}^0 e^{-(-\kappa_1 + iq)z} dz \right) \\ &= \frac{\sigma_k}{\varepsilon_1 \kappa_1} \left(\left[\frac{1}{-(\kappa_1 + iq)} e^{-(\kappa_1 + iq)z} \right]_0^{\infty} + \left[\frac{1}{-(-\kappa_1 + iq)} e^{-(-\kappa_1 + iq)z} \right]_{-\infty}^0 \right) \\ &= \frac{\sigma_k}{\varepsilon_1 \kappa_1} \left(\frac{1}{\kappa_1 + iq} + \frac{1}{-(-\kappa_1 + iq)} \right) \\ &= \frac{\sigma_k}{\varepsilon_1 \kappa_1} \frac{2\kappa_1}{\kappa_1^2 + q^2} \end{aligned}$$

Therefore, condition (III.12) gives:

$$M_1(q) + \frac{\sigma_k}{\varepsilon_1 \kappa_1} \frac{2\kappa_1}{\kappa_1^2 + q^2} = M_2(q) + \frac{\sigma_l}{\varepsilon_2 \kappa_2} \frac{2\kappa_2}{\kappa_2^2 + q^2} \tag{III.13}$$

$M_1(q)$ and $M_2(q)$ can be obtained by solving the Eqs. (III.11) and (III.13).

Shorthand

$$\begin{aligned}
aM_1(q) &= bM_2(q) & M_1(q) + c &= M_2(q) + d \\
\Rightarrow \frac{b}{a}M_2(q) + c &= M_2(q) + d \\
\Rightarrow \left(\frac{b}{a} - 1\right)M_2(q) &= d - c \\
\Rightarrow M_2(q) &= \frac{a}{b-a}(d - c) \\
\Rightarrow M_1(q) &= \frac{b}{a}M_2(q) = \frac{b}{b-a}(d - c)
\end{aligned}$$

$$\begin{aligned}
\Rightarrow M_1(q) &= \frac{\varepsilon_2 p_2}{\varepsilon_1 p_1 + \varepsilon_2 p_2} \left(-\frac{\sigma_k}{\varepsilon_1 \kappa_1} \frac{2\kappa_1}{\kappa_1^2 + q^2} + \frac{\sigma_l}{\varepsilon_2 \kappa_2} \frac{2\kappa_2}{\kappa_2^2 + q^2} \right) = 2 \frac{\varepsilon_2 p_2}{\varepsilon_1 p_1 + \varepsilon_2 p_2} \left(-\frac{\sigma_k}{\varepsilon_1} \frac{1}{p_1^2} + \frac{\sigma_l}{\varepsilon_2} \frac{1}{p_2^2} \right) \\
M_2(q) &= -\frac{\varepsilon_1 p_1}{\varepsilon_1 p_1 + \varepsilon_2 p_2} \left(-\frac{\sigma_k}{\varepsilon_1 \kappa_1} \frac{2\kappa_1}{\kappa_1^2 + q^2} + \frac{\sigma_l}{\varepsilon_2 \kappa_2} \frac{2\kappa_2}{\kappa_2^2 + q^2} \right) = -2 \frac{\varepsilon_1 p_1}{\varepsilon_1 p_1 + \varepsilon_2 p_2} \left(-\frac{\sigma_k}{\varepsilon_1} \frac{1}{p_1^2} + \frac{\sigma_l}{\varepsilon_2} \frac{1}{p_2^2} \right)
\end{aligned}$$

So we have derived an expression for the Fourier transform of $c_i(x, z)$. Applying the back transformation formula, we get the following expressions for $c_i(x, z)$:

$$\begin{aligned}
c_1(x, z) &= \frac{1}{\pi} \int_{-\infty}^{\infty} \frac{\varepsilon_2 p_2}{\varepsilon_1 p_1 + \varepsilon_2 p_2} \left(-\frac{\sigma_k}{\varepsilon_1} \frac{1}{p_1^2} + \frac{\sigma_l}{\varepsilon_2} \frac{1}{p_2^2} \right) e^{-p_1 x} e^{iqz} dq \\
c_2(x, z) &= -\frac{1}{\pi} \int_{-\infty}^{\infty} \frac{\varepsilon_1 p_1}{\varepsilon_1 p_1 + \varepsilon_2 p_2} \left(-\frac{\sigma_k}{\varepsilon_1} \frac{1}{p_1^2} + \frac{\sigma_l}{\varepsilon_2} \frac{1}{p_2^2} \right) e^{p_2 x} e^{iqz} dq
\end{aligned}$$

$e^{iqz} = \cos(qz) + i \sin(qz)$ and because the integrand is even $\Rightarrow \int \dots \sin = 0$, so we can write

$$\begin{aligned}
c_1(x, z) &= \frac{1}{\pi} \int_{-\infty}^{\infty} \frac{\varepsilon_2 p_2}{\varepsilon_1 p_1 + \varepsilon_2 p_2} \left(-\frac{\sigma_k}{\varepsilon_1} \frac{1}{p_1^2} + \frac{\sigma_l}{\varepsilon_2} \frac{1}{p_2^2} \right) e^{-p_1 x} \cos(qz) dq \\
c_2(x, z) &= -\frac{1}{\pi} \int_{-\infty}^{\infty} \frac{\varepsilon_1 p_1}{\varepsilon_1 p_1 + \varepsilon_2 p_2} \left(-\frac{\sigma_k}{\varepsilon_1} \frac{1}{p_1^2} + \frac{\sigma_l}{\varepsilon_2} \frac{1}{p_2^2} \right) e^{p_2 x} \cos(qz) dq
\end{aligned}$$

Finally, using these expressions for $c_1(x, z)$ and $c_2(x, z)$, one can write

$$\begin{aligned}
\Phi_1^{\sigma_k, \sigma_l}(x, z) &= \frac{\sigma_k}{\varepsilon_1 \kappa_1} e^{-\kappa_1 z} \\
&+ \frac{\kappa_2 \varepsilon_2 \Phi_D}{\kappa_1 \varepsilon_1 + \kappa_2 \varepsilon_2} e^{-\kappa_1 x} \\
&+ \frac{1}{\pi} \int_{-\infty}^{\infty} \frac{\varepsilon_2 p_2}{\varepsilon_1 p_1 + \varepsilon_2 p_2} \left(-\frac{\sigma_k}{\varepsilon_1} \frac{1}{p_1^2} + \frac{\sigma_l}{\varepsilon_2} \frac{1}{p_2^2} \right) e^{-p_1 x} \cos(qz) dq
\end{aligned}$$

$$\begin{aligned}
\Phi_2^{\sigma_k, \sigma_l}(x, z) &= \frac{\sigma_l}{\varepsilon_2 \kappa_2} e^{-\kappa_2 z} \\
&+ \Phi_D - \frac{\kappa_1 \varepsilon_1 \Phi_D}{\kappa_1 \varepsilon_1 + \kappa_2 \varepsilon_2} e^{\kappa_2 x} \\
&+ \frac{1}{\pi} \int_{-\infty}^{\infty} -\frac{\varepsilon_1 p_1}{\varepsilon_1 p_1 + \varepsilon_2 p_2} \left(-\frac{\sigma_k}{\varepsilon_1} \frac{1}{p_1^2} + \frac{\sigma_l}{\varepsilon_2} \frac{1}{p_2^2} \right) e^{p_2 x} \cos(qz) dq
\end{aligned}$$

Using Eq. (III.10) we finally obtain the superposition potentials in the two media:

$$\begin{aligned}
\Phi_1^s(x, z) &= \frac{\sigma_1}{\varepsilon_1 \kappa_1} e^{-\kappa_1 z} + \frac{\sigma_2}{\varepsilon_1 \kappa_1} e^{\kappa_1(z-L)} \\
&+ \frac{2\kappa_2 \varepsilon_2 \Phi_D}{\kappa_1 \varepsilon_1 + \kappa_2 \varepsilon_2} e^{-\kappa_1 x} \\
&+ \frac{1}{\pi} \int_{-\infty}^{\infty} \frac{\varepsilon_2 p_2}{\varepsilon_1 p_1 + \varepsilon_2 p_2} \left(-\frac{\sigma_1}{\varepsilon_1} \frac{1}{p_1^2} + \frac{\sigma_3}{\varepsilon_2} \frac{1}{p_2^2} \right) e^{-p_1 x} \cos(qz) dq \\
&+ \frac{1}{\pi} \int_{-\infty}^{\infty} \frac{\varepsilon_2 p_2}{\varepsilon_1 p_1 + \varepsilon_2 p_2} \left(-\frac{\sigma_2}{\varepsilon_1} \frac{1}{p_1^2} + \frac{\sigma_4}{\varepsilon_2} \frac{1}{p_2^2} \right) e^{-p_1 x} \cos(-q(z-L)) dq
\end{aligned} \tag{III.14}$$

$$\begin{aligned}
\Phi_2^s(x, z) &= \frac{\sigma_3}{\varepsilon_2 \kappa_2} e^{-\kappa_2 z} + \frac{\sigma_4}{\varepsilon_2 \kappa_2} e^{\kappa_2(z-L)} \\
&+ 2\Phi_D - 2 \frac{\kappa_1 \varepsilon_1 \Phi_D}{\kappa_1 \varepsilon_1 + \kappa_2 \varepsilon_2} e^{\kappa_2 x} \\
&+ \frac{1}{\pi} \int_{-\infty}^{\infty} -\frac{\varepsilon_1 p_1}{\varepsilon_1 p_1 + \varepsilon_2 p_2} \left(-\frac{\sigma_1}{\varepsilon_1} \frac{1}{p_1^2} + \frac{\sigma_3}{\varepsilon_2} \frac{1}{p_2^2} \right) e^{p_2 x} \cos(qz) dq \\
&+ \frac{1}{\pi} \int_{-\infty}^{\infty} -\frac{\varepsilon_1 p_1}{\varepsilon_1 p_1 + \varepsilon_2 p_2} \left(-\frac{\sigma_2}{\varepsilon_1} \frac{1}{p_1^2} + \frac{\sigma_4}{\varepsilon_2} \frac{1}{p_2^2} \right) e^{p_2 x} \cos(-q(z-L)) dq
\end{aligned} \tag{III.15}$$

10.4 Consistency with literature

We test our expression for consistency with the result of Ref. [20]. Since in Ref. [20] the walls are located at $z = \pm L$, we need to do a transformation in order to compare the results. For this we have to set

$$\begin{aligned}
L &= 2L' \\
z &= z' + L' \\
\sigma'_1 &= \sigma_1 = \sigma_2 \\
\sigma'_2 &= \sigma_3 = \sigma_4
\end{aligned}$$

We transform each line of our expression for $\Phi^s(x, z)$ separately and compare with Ref. [20].

Line 1

$$\begin{aligned}
&\frac{\sigma_1}{\varepsilon_1 \kappa_1} e^{-\kappa_1 z} + \frac{\sigma_2}{\varepsilon_1 \kappa_1} e^{\kappa_1(z-L)} \\
&= \frac{\sigma'_1}{\varepsilon_1 \kappa_1} \left(e^{-\kappa_1(z'+L')} + e^{\kappa_1(z'+L'-2L')} \right) \\
&= \frac{\sigma'_1}{\varepsilon_1 \kappa_1} \left(e^{-\kappa_1 z' - \kappa_1 L'} + e^{\kappa_1 z' - \kappa_1 L'} \right) \\
&= \frac{\sigma'_1}{\varepsilon_1 \kappa_1} e^{-\kappa_1 L'} 2 \cosh(\kappa_1 z') \quad \checkmark
\end{aligned}$$

Line 2 Nothing to be done.

Line 3

$$\begin{aligned}
&\cos(-q(z-L)) \\
&= \cos(-q(z'+L'-2L')) \\
&= \cos(-qz' + qL') \\
&= \cos(-qz') \cos(qL') - \sin(-qz') \sin(qL') \\
&= \cos(qz') \cos(qL') + \sin(qz') \sin(qL')
\end{aligned}$$

$$\begin{aligned}
&\cos(qz) \\
&= \cos(q(z'+L')) \\
&= \cos(qz' + qL') \\
&= \cos(qz') \cos(qL') - \sin(qz') \sin(qL') \\
&= \cos(qz') \cos(qL') - \sin(qz') \sin(qL')
\end{aligned}$$

$$\begin{aligned}
&\frac{1}{\pi} \int_{-\infty}^{\infty} \frac{\varepsilon_2 p_2}{\varepsilon_1 p_1 + \varepsilon_2 p_2} \left(-\frac{\sigma_1}{\varepsilon_1} \frac{1}{p_1^2} + \frac{\sigma_3}{\varepsilon_2} \frac{1}{p_2^2} \right) e^{-p_1 x} \cos(qz) dq \\
&+ \frac{1}{\pi} \int_{-\infty}^{\infty} \frac{\varepsilon_2 p_2}{\varepsilon_1 p_1 + \varepsilon_2 p_2} \left(-\frac{\sigma_2}{\varepsilon_1} \frac{1}{p_1^2} + \frac{\sigma_4}{\varepsilon_2} \frac{1}{p_2^2} \right) e^{-p_1 x} \cos(-q(z-L)) dq \\
&= \frac{1}{\pi} \int_{-\infty}^{\infty} \frac{\varepsilon_2 p_2}{\varepsilon_1 p_1 + \varepsilon_2 p_2} \left(-\frac{\sigma'_1}{\varepsilon_1} \frac{1}{p_1^2} + \frac{\sigma'_2}{\varepsilon_2} \frac{1}{p_2^2} \right) e^{-p_1 x} (\cos(qz') \cos(qL') - \sin(qz') \sin(qL')) dq \\
&+ \frac{1}{\pi} \int_{-\infty}^{\infty} \frac{\varepsilon_2 p_2}{\varepsilon_1 p_1 + \varepsilon_2 p_2} \left(-\frac{\sigma'_1}{\varepsilon_1} \frac{1}{p_1^2} + \frac{\sigma'_2}{\varepsilon_2} \frac{1}{p_2^2} \right) e^{-p_1 x} (\cos(qz') \cos(qL') + \sin(qz') \sin(qL')) dq
\end{aligned}$$

$$= \frac{2}{\pi} \int_{-\infty}^{\infty} \frac{\varepsilon_2 p_2}{\varepsilon_1 p_1 + \varepsilon_2 p_2} \left(-\frac{\sigma'_1}{\varepsilon_1} \frac{1}{p_1^2} + \frac{\sigma'_2}{\varepsilon_2} \frac{1}{p_2^2} \right) e^{-p_1 x} \cos(qz') \cos(qL') dq \quad \checkmark$$

Therefore we can obtain the result for the case of identical particles given in Ref. [20] from our general expressions.

11 Plots

For all the following plots of this chapter we use $\varepsilon_1 = 80 \varepsilon_0$, $\varepsilon_2 = 2 \varepsilon_0$, $\kappa_1 = 0.1 \text{ nm}^{-1}$, $\kappa_2 = 0.03 \text{ nm}^{-1}$, and $\Phi_D = 1 \text{ k}_B \text{T}/e$.

11.1 Comparison

Here, we compare the exact and superposition potentials Φ^e and Φ^s for different separations between the walls. As expected, and as it can be seen below, the superposition approximation increasingly deviates from the exact solutions for small values of L .

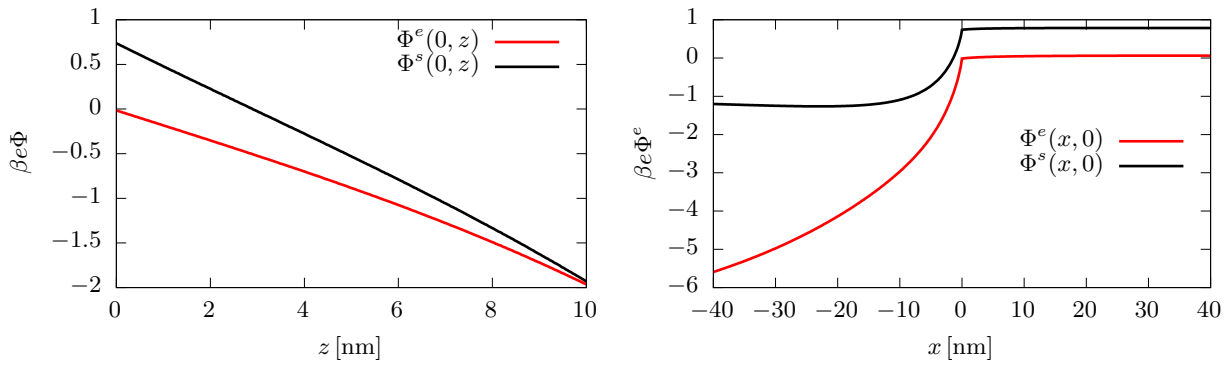


Figure III.8: Comparison of Φ^e and Φ^s for $L = 10 \text{ nm}$ and $\sigma_1 = 0.02 \text{ e/nm}^2$, $\sigma_2 = -0.03 \text{ e/nm}^2$, $\sigma_3 = -0.0004 \text{ e/nm}^2$, $\sigma_4 = 0.0002 \text{ e/nm}^2$

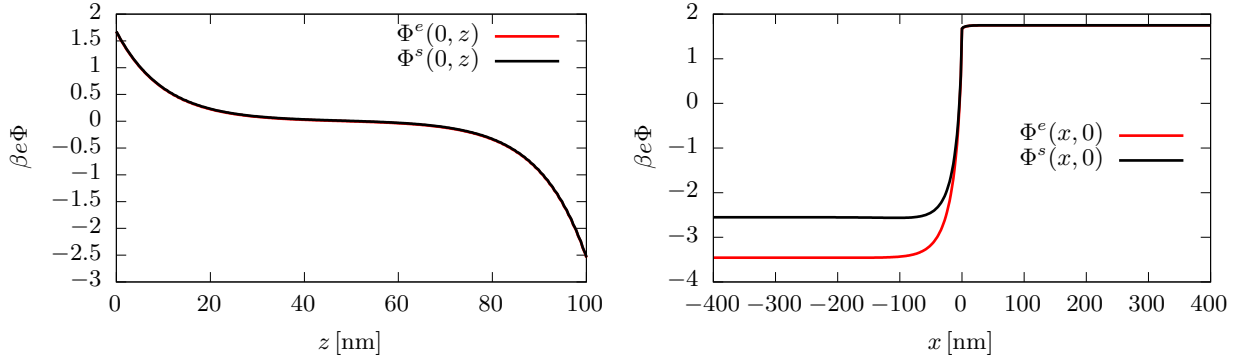


Figure III.9: Comparison of Φ^e and Φ^s for $L = 100 \text{ nm}$ and $\sigma_1 = 0.02 \text{ e/nm}^2$, $\sigma_2 = -0.03 \text{ e/nm}^2$, $\sigma_3 = -0.0004 \text{ e/nm}^2$, $\sigma_4 = 0.0002 \text{ e/nm}^2$

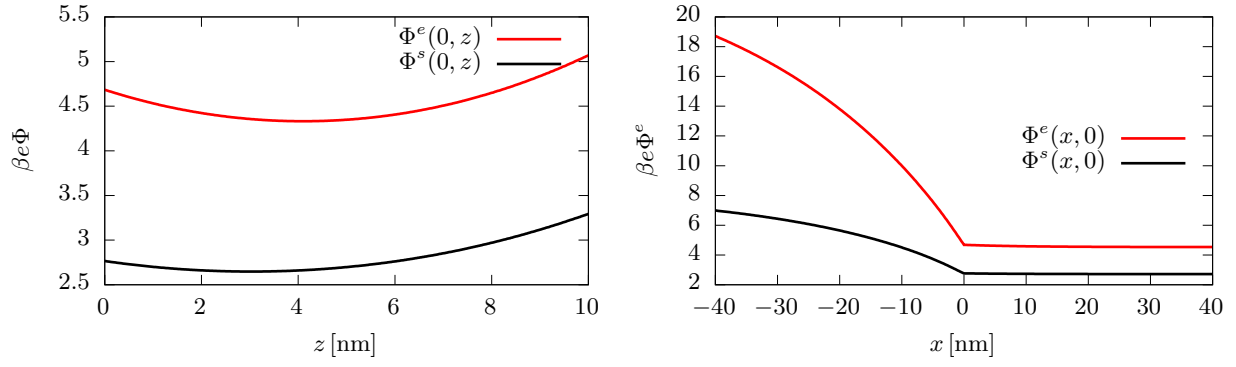


Figure III.10: Comparison of Φ^e and Φ^s for $L = 10$ nm and $\sigma_1 = 0.02$ e/nm², $\sigma_2 = 0.03$ e/nm², $\sigma_3 = 0.0004$ e/nm², $\sigma_4 = 0.0002$ e/nm²

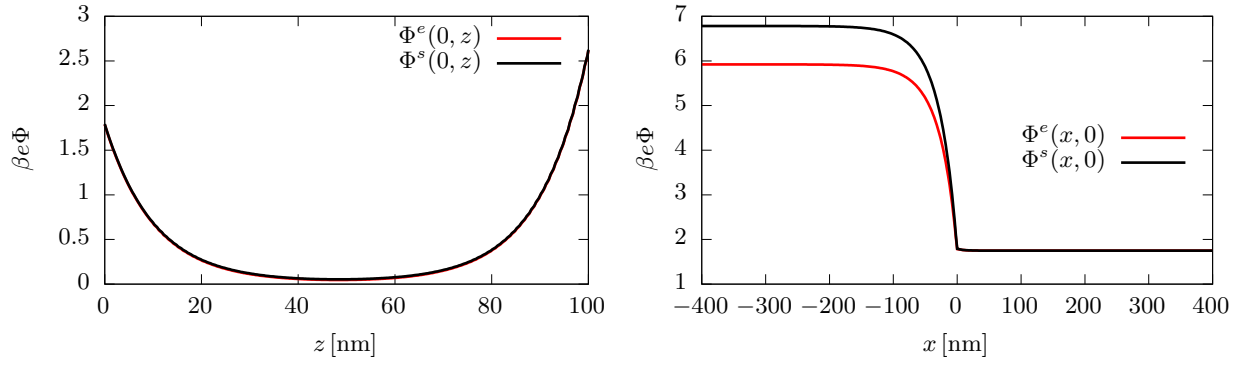


Figure III.11: Comparison of Φ^e and Φ^s for $L = 100$ nm and $\sigma_1 = 0.02$ e/nm², $\sigma_2 = 0.03$ e/nm², $\sigma_3 = 0.0004$ e/nm², $\sigma_4 = 0.0002$ e/nm²

11.2 Exact Solution

Some cross sections of the exact solution Potential

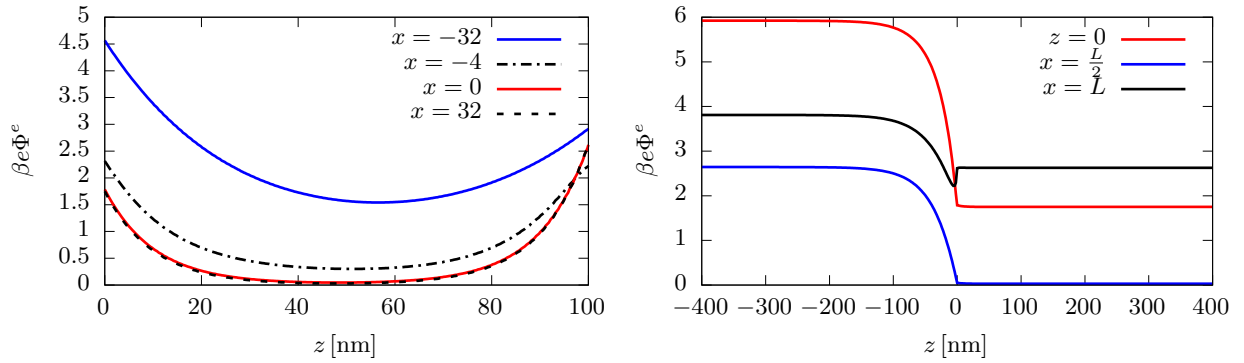


Figure III.12: Φ^e for $L = 100$ nm and $\sigma_1 = 0.02$ e/nm², $\sigma_2 = 0.03$ e/nm², $\sigma_3 = 0.0004$ e/nm², $\sigma_4 = 0.0002$ e/nm²

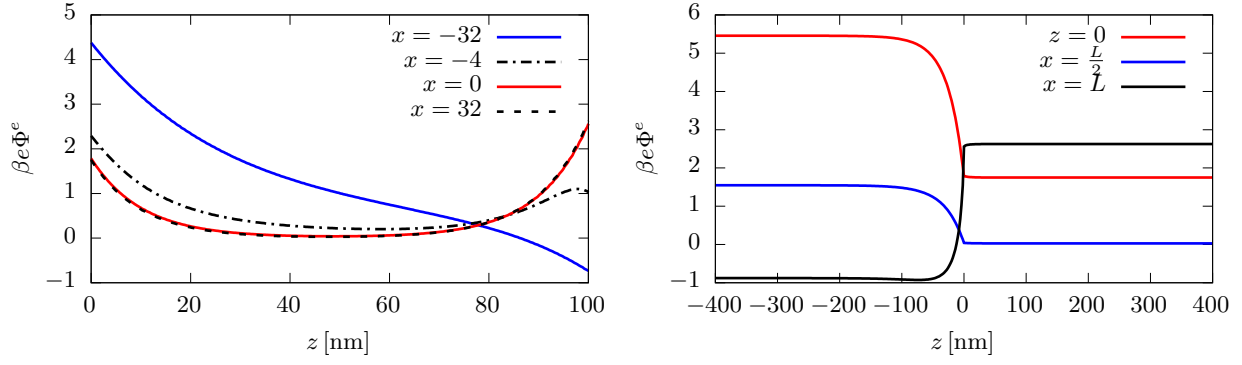


Figure III.13: Φ^e for $L = 100$ nm and $\sigma_1 = 0.02$ e/nm², $\sigma_2 = 0.03$ e/nm², $\sigma_3 = 0.0004$ e/nm², $\sigma_4 = -0.0002$ e/nm²

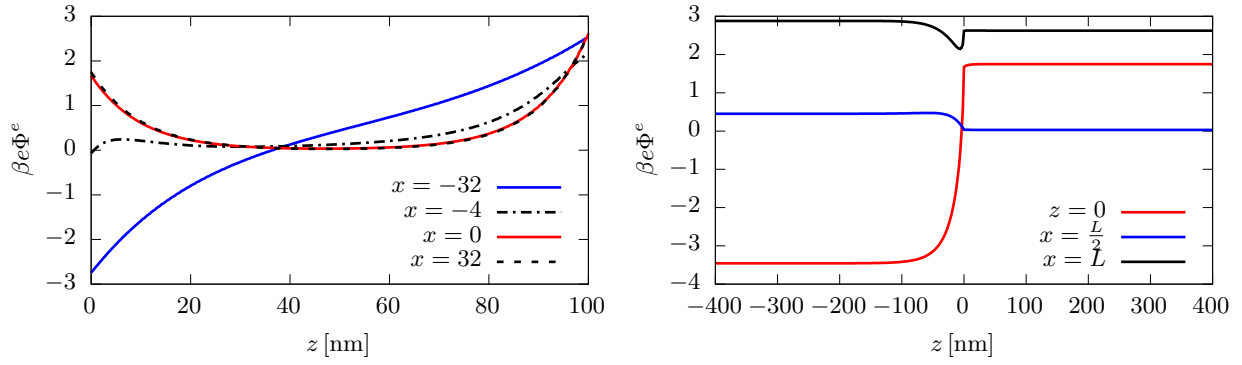


Figure III.14: Φ^e for $L = 100$ nm and $\sigma_1 = 0.02$ e/nm², $\sigma_2 = 0.03$ e/nm², $\sigma_3 = -0.0004$ e/nm², $\sigma_4 = 0.0002$ e/nm²

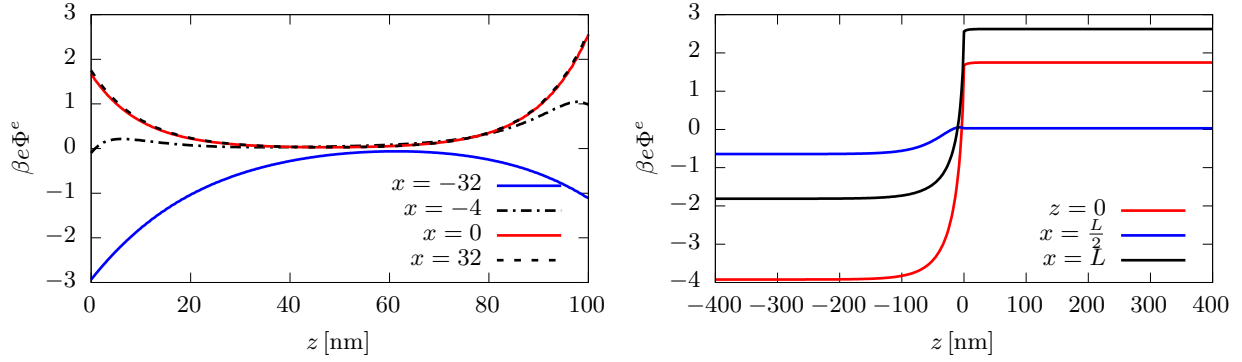


Figure III.15: Φ^e for $L = 100$ nm and $\sigma_1 = 0.02$ e/nm², $\sigma_2 = 0.03$ e/nm², $\sigma_3 = -0.0004$ e/nm², $\sigma_4 = -0.0002$ e/nm²

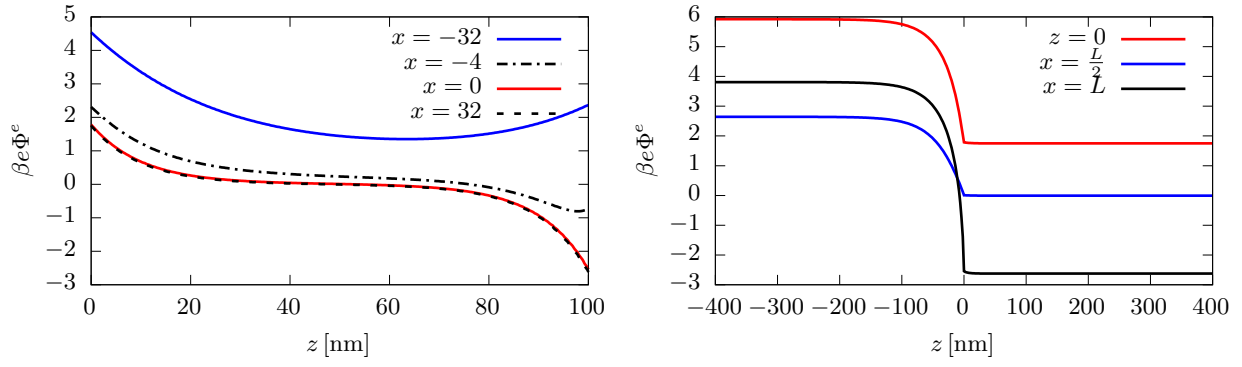


Figure III.16: Φ^e for $L = 100$ nm and $\sigma_1 = 0.02$ e/nm², $\sigma_2 = -0.03$ e/nm², $\sigma_3 = 0.0004$ e/nm², $\sigma_4 = 0.0002$ e/nm²

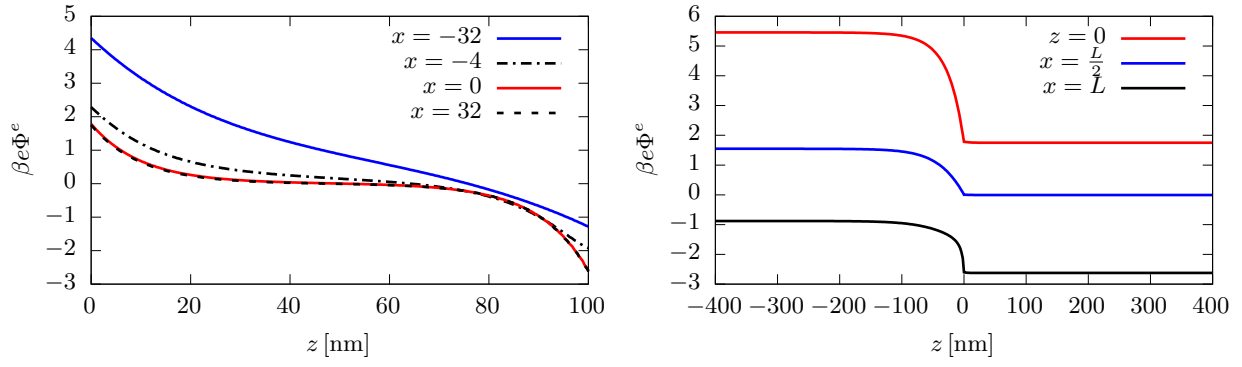


Figure III.17: Φ^e for $L = 100$ nm and $\sigma_1 = 0.02$ e/nm², $\sigma_2 = -0.03$ e/nm², $\sigma_3 = 0.0004$ e/nm², $\sigma_4 = -0.0002$ e/nm²

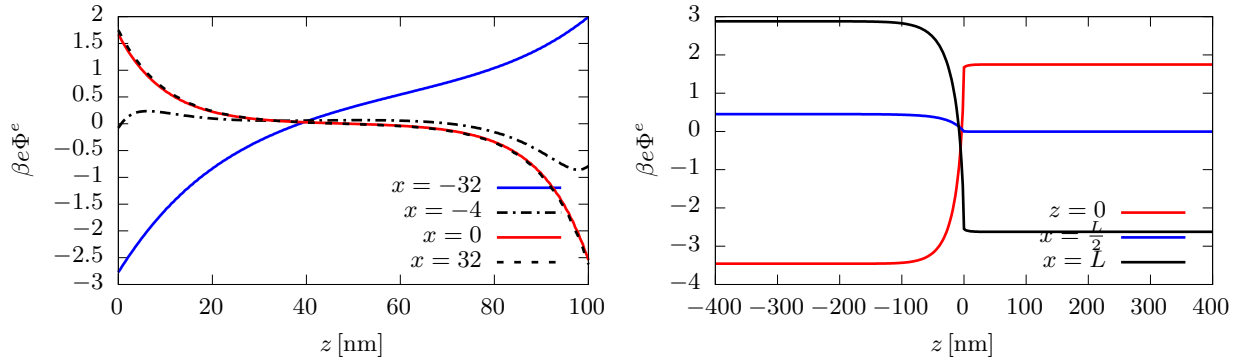


Figure III.18: Φ^e for $L = 100$ nm and $\sigma_1 = 0.02$ e/nm², $\sigma_2 = -0.03$ e/nm², $\sigma_3 = -0.0004$ e/nm², $\sigma_4 = 0.0002$ e/nm²

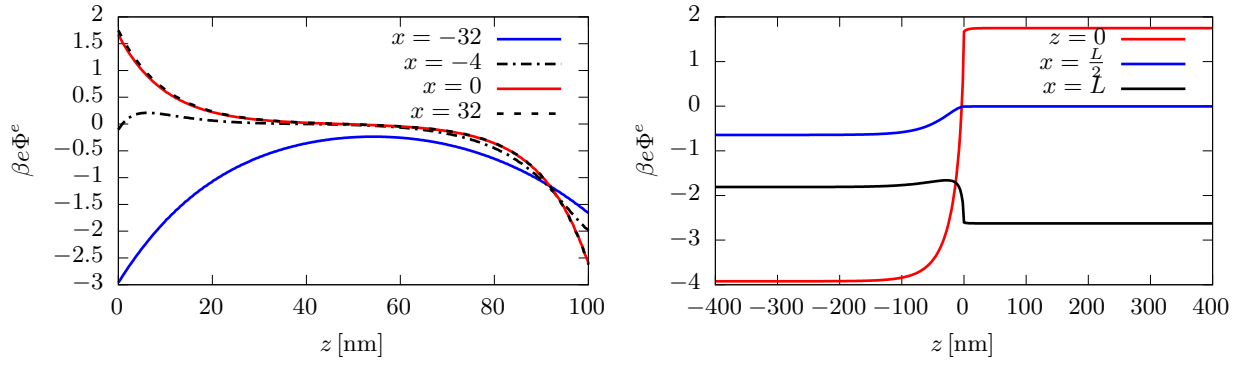


Figure III.19: Φ^e for $L = 100$ nm and $\sigma_1 = 0.02$ e/nm², $\sigma_2 = -0.03$ e/nm², $\sigma_3 = -0.0004$ e/nm², $\sigma_4 = -0.0002$ e/nm²

The cases with inverted signs do not have the same solutions but the plots are qualitatively not much different, so we omit them.

Chapter IV

Interaction Energies

12 Calculation of Energies

Using the electrostatic potentials derived in the last chapter we can now proceed to calculate the interaction energies of our system.

To better understand the behavior of the system we split the total energy into different contributions:

$$\begin{aligned}\Omega(L) = & \Omega_{b,1}V_1 + \Omega_{b,2}V_2 + \gamma_{1,2}A_{1,2} + (\gamma_1 + \gamma_2)\frac{A_1}{2} + \omega_{\gamma,1}(L)A_1 \\ & + (\gamma_3 + \gamma_4)\frac{A_2}{2} + \omega_{\gamma,2}(L)A_2 + (\tau_1 + \tau_2)\frac{l}{2} + \omega_\tau(L)l\end{aligned}\quad (\text{IV.1})$$

Here V_i denotes the volume containing medium i , $A_{1,2}$ denotes the area of the liquid-liquid interface, A_i denotes the total area of the walls in contact with medium i and l denotes the total length of the two three-phase contact lines (in contact with medium 1, medium 2 and the wall).

- $\Omega_{b,i}$ is the bulk energy density in medium i .

$$\beta\Omega_{b,1} \stackrel{(\text{II.7})}{=} \frac{1}{V_1} \int_{V_1} \sum_{i \in \{\pm\}} \underbrace{I(r)}_{=I_1} \left(\underbrace{\ln\left(\frac{I(r)}{\zeta_i}\right)}_{\stackrel{(\text{II.2})}{=}0} - 1 + \underbrace{\beta V_i(r)}_{=0} \right) = \frac{1}{V_1} \int_{V_1} \sum_{i \in \{\pm\}} -I_1 = -2I_1$$

$$\begin{aligned}\beta\Omega_{b,2} & \stackrel{(\text{II.7})}{=} \frac{1}{V_2} \int_{V_2} \sum_{i \in \{\pm\}} \underbrace{I(r)}_{=I_2} \left(\ln\left(\frac{I(r)}{\zeta_i}\right) - 1 + \underbrace{\beta V_i(r)}_{=\beta f_i} \right) \\ & = \frac{1}{V_2} \int_{V_2} \sum_{i \in \{\pm\}} \underbrace{I_2 \left(\ln\left(\frac{I_2}{\zeta_i}\right) + \beta f_i - 1 \right)}_{\stackrel{(\text{II.3})}{=} -\beta e Z_i \Phi_D} = \frac{1}{V_2} \int_{V_2} -2I_2 = -2I_2\end{aligned}$$

Therefore the bulk energy density is simply given by the negative osmotic pressure.

- γ_i is the surface tension between the part of the wall with surface charge σ_i and the neighbouring liquid. It is the energy per surface area of the part of the wall with a charge of σ_i in a single medium (1 if $i \in \{1, 2\}$, 2 if $i \in \{3, 4\}$) without interface (system (b)/(c)/(e)/(f) in Fig. IV.1) minus the bulk energy.
- $\omega_{\gamma,i}(L)$ is the surface interaction energy per total surface area of the walls in contact with medium i at distance L . $\omega_{\gamma,i}(L)A_i$ is the energy required to bring two walls together to distance L , i.e. the energy in a system with only two walls charged with σ_1, σ_2 in medium 1 ($i = 1$) or σ_3, σ_4 in medium 2 ($i = 2$) at distance L (system (d)/(g) in Fig. IV.1) minus $(\gamma_1 + \gamma_2)\frac{A_1}{2} + \Omega_{b,1}V_1$ or $(\gamma_3 + \gamma_4)\frac{A_2}{2} + \Omega_{b,2}V_2$.
- $\gamma_{1,2}$ is the interfacial tension, i.e. the energy per interface area in a system without any walls (system (a) in Fig. IV.1) minus the sum of bulk contributions $\Omega_{b,1}V_1 + \Omega_{b,2}V_2$.
- τ_i is the line tension acting at the left ($i = 1$) or right ($i = 2$) three-phase contact line. τ_i can be calculated by calculating the energy of the systems depicted in (h) and (i) of Fig. IV.1 and subtracting the bulk, interface and surface contributions calculated previously.
- $\omega_\tau(L)$ is the interaction energy per total length of the two three contact lines at distance L . $\omega_\tau(L)$ is the energy per length required for bringing left and right wall to distance L that was not yet accounted for in the previous energies.

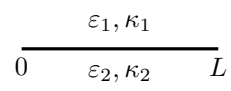
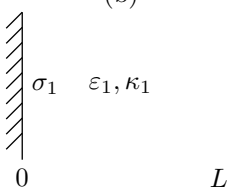
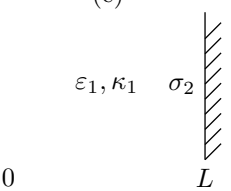
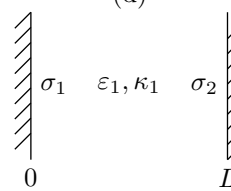
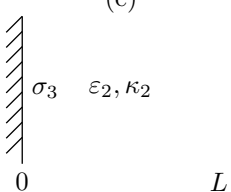
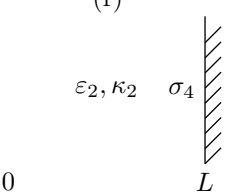
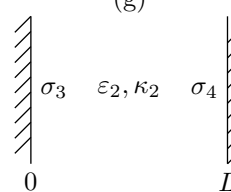
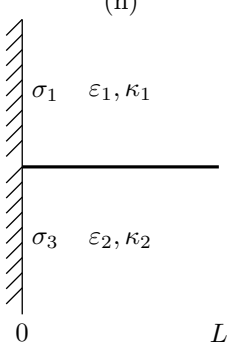
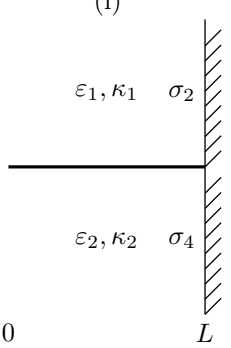
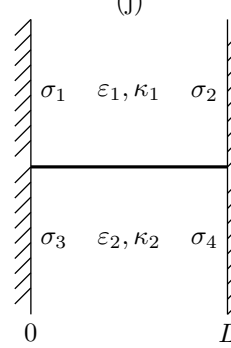
<p>(a)</p>  $\Omega = \gamma_{1,2}A_{1,2} + \Omega_{b,1}V_1 + \Omega_{b,2}V_2$		
<p>(b)</p>  $\Omega = \gamma_1 \frac{A_1}{2} + \Omega_{b,1}V_1$	<p>(c)</p>  $\Omega = \gamma_2 \frac{A_1}{2} + \Omega_{b,1}V_1$	<p>(d)</p>  $\Omega = (\gamma_1 + \gamma_2) \frac{A_1}{2} + \omega_{\gamma,1}A_1 + \Omega_{b,1}V_1$
<p>(e)</p>  $\Omega = \gamma_3 \frac{A_2}{2} + \Omega_{b,2}V_2$	<p>(f)</p>  $\Omega = \gamma_4 \frac{A_2}{2} + \Omega_{b,2}V_2$	<p>(g)</p>  $\Omega = (\gamma_3 + \gamma_4) \frac{A_2}{2} + \omega_{\gamma,2}A_2 + \Omega_{b,2}V_2$
<p>(h)</p>  $\Omega = \gamma_1 \frac{A_1}{2} + \gamma_3 \frac{A_2}{2} + \gamma_{1,2}A_{1,2} + \tau_1 \frac{l}{2} + \Omega_{b,1}V_1 + \Omega_{b,2}V_2$	<p>(i)</p>  $\Omega = \gamma_2 \frac{A_1}{2} + \gamma_4 \frac{A_2}{2} + \gamma_{1,2}A_{1,2} + \tau_2 \frac{l}{2} + \Omega_{b,1}V_1 + \Omega_{b,2}V_2$	<p>(j)</p>  $\Omega = (\text{IV.1})$

Figure IV.1: Different systems and their energies

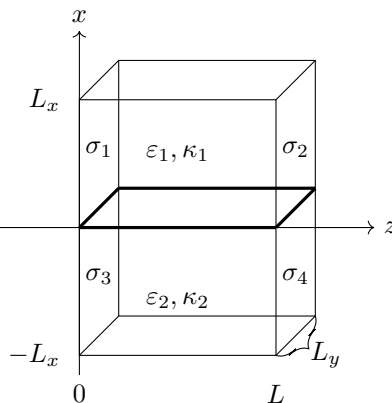


Figure IV.2: Schematic of the system volume considered in the following calculations. The volume contains an equal volume of both media (each $L_x L_y L$), the interface at $x = 0$ with a surface of $L_y L$, four charged wall parts with a surface of $L_x L_y$ each and two three-phase contact lines, each of length L_y .

We calculate the energy contained in the volume $[-L_x, L_x] \times [0, L_y] \times [0, L]$, as illustrated in Figure IV.2. After subtracting the bulk contributions from the total energy Ω , we obtain \mathcal{H} which is in this case given by

$$\mathcal{H} = (\gamma_1 + \gamma_2 + \gamma_3 + \gamma_4)L_x L_y + (\omega_{\gamma,1}(L) + \omega_{\gamma,2}(L))2L_x L_y + \gamma_{1,2}L_y L + (\tau_1 + \tau_2)L_y + \omega_\tau(L)2L_y \quad (\text{IV.2})$$

Since we can calculate an analytical solution for the total energy, we can avoid having to calculate the energies for all the systems outlined in Fig. IV.1 by making use of the following method.

We check if a term in our solution is proportional to $L_x L_y$. If it is proportional then we check if it has an L -dependence. If it has an L -dependence we separate the parts containing contributions from σ_1 and σ_2 , half them and add them to $\tilde{\omega}_{\gamma,1}$ and add half of the parts involving σ_3 and σ_4 to $\tilde{\omega}_{\gamma,2}$. We split up the non- L -dependent part into parts containing only one of the σ 's and then add the term involving σ_i to $\tilde{\tau}_i$.

We identify the other contributions in the same fashion, i.e. through the proportionality with $L_y L$ or L_y and then splitting in L -dependent and non- L -dependent parts and identifying the appropriate terms in (IV.2). From that we obtain the following quantities

$$\mathcal{H} = (\tilde{\gamma}_1 + \tilde{\gamma}_2 + \tilde{\gamma}_3 + \tilde{\gamma}_4)L_x L_y + (\tilde{\omega}_{\gamma,1}(L) + \tilde{\omega}_{\gamma,2}(L))2L_x L_y + \tilde{\gamma}_{1,2}L_y L + (\tilde{\tau}_1 + \tilde{\tau}_2)L_y + \tilde{\omega}_\tau(L)2L_y$$

but since L -dependent and non- L -dependent parts have the same kind of proportionality to our lengths we need to separate them by using the relation that the L -dependent part needs to go to zero for L to infinity. This can be done in the following way:

$$x(L) = \tilde{x}(L) - \lim_{L \rightarrow \infty} \tilde{x}(L) \quad x = \tilde{x} + 2 \lim_{L \rightarrow \infty} \tilde{x}(L) \quad (\text{IV.3})$$

where $x(L)$ is any of $\omega_{\gamma,1}(L)$ or $\omega_{\gamma,2}(L)$ or $\omega_\tau(L)$ and x is $\gamma_1 + \gamma_2$ or $\gamma_3 + \gamma_4$ or $\tau_1 + \tau_2$. The last expressions can be split by looking at the dependence on the respective charges in the expression.

Before presenting the detailed calculation we first simplify (II.9). We can use the symmetry of the Potential with regards to y for the integration in (II.9).

$$\begin{aligned} \mathcal{H}[\phi] &= \frac{1}{2} \left(\int_{\partial V} d^2 r \sigma(r) (\Phi(r) + \varphi(r)) - \Phi_D \int_{x=0} d^2 r D(r) \cdot e_x \right) + \mathcal{O}(\phi_i^3) \\ &= \frac{L_y}{2} \left(\int_0^{L_x} \sigma_1 (\Phi_1(x, 0) + 0) dx + \int_0^{L_x} \sigma_2 (\Phi_1(x, L) + 0) dx \right. \\ &\quad \left. + \int_{-L_x}^0 \sigma_3 (\Phi_2(x, 0) + \Phi_D) dx + \int_{-L_x}^0 \sigma_4 (\Phi_2(x, L) + \Phi_D) dx + \Phi_D \int_0^L \varepsilon_1 \partial_x \Phi_1(0, z) dz \right) \\ &= \frac{L_y}{2} \int_0^{L_x} \sigma_1 \Phi_1(x, 0) + \sigma_2 \Phi_1(x, L) dx \\ &\quad + \frac{L_y}{2} \int_{-L_x}^0 \sigma_3 \Phi_3(x, 0) + \sigma_4 \Phi_2(x, L) dx \end{aligned}$$

$$\begin{aligned}
& + \frac{L_x L_y \Phi_D}{2} (\sigma_3 + \sigma_4) \\
& + \frac{\varepsilon_1 \Phi_D L_y}{2} \int_0^L (\partial_x \Phi_1)(0, z) dz
\end{aligned} \tag{IV.4}$$

13 Exact Solution

We introduce abbreviations a_i , b_i , $c_i(L)$, $d_{n,i}(L)$ for terms in $\Phi^e(x, z)$ that are not depending on x or z :

$$\begin{aligned}
\Phi_1(x, z) &= a_1(L)(\sigma_1 \cosh(\kappa_1(L-z)) + \sigma_2 \cosh(\kappa_1 z)) \\
& + b_1 e^{-\kappa_1 x} \\
& + c_1(L) e^{-\kappa_1 x} \\
& + \sum_{n=1}^{\infty} d_{1,n}(L) e^{-p_1 x} \cos\left(\frac{n\pi z}{L}\right)
\end{aligned}$$

$$\begin{aligned}
\partial_x \Phi_1(x, z) &= -\kappa_1 b_1 e^{-\kappa_1 x} - \kappa_1 c_1(L) e^{-\kappa_1 x} \\
& + \sum_{n=1}^{\infty} d_{1,n}(L) (-p_1) e^{-p_1 x} \cos\left(\frac{n\pi z}{L}\right)
\end{aligned}$$

$$\begin{aligned}
\Phi_2(x, z) &= a_2(L)(\sigma_3 \cosh(\kappa_2(L-z)) + \sigma_4 \cosh(\kappa_2 z)) \\
& + \Phi_D + b_2 e^{\kappa_2 x} \\
& + c_2(L) e^{\kappa_2 x} \\
& + \sum_{n=1}^{\infty} d_{2,n}(L) e^{p_2 x} \cos\left(\frac{n\pi z}{L}\right)
\end{aligned}$$

We then proceed to insert these expressions into Eq. (IV.4) in order to calculate the energy.

$$\begin{aligned}
\Rightarrow \mathcal{H} &= \frac{L_y}{2} \sigma_1 \left(a_1(L)(\sigma_1 \cosh(\kappa_1 L) + \sigma_2) L_x + b_1 \frac{1}{-\kappa_1} (e^{-\kappa_1 L_x} - 1) \right. \\
& \quad \left. + c_1(L) \frac{1}{-\kappa_1} (e^{-\kappa_1 L_x} - 1) + \sum_{n=1}^{\infty} d_{1,n}(L) \frac{1}{-p_1} (e^{-p_1 L_x} - 1) \right) \\
& + \frac{L_y}{2} \sigma_2 \left(a_1(L)(\sigma_1 + \sigma_2 \cosh(\kappa_1 L)) L_x + b_1 \frac{1}{-\kappa_1} (e^{-\kappa_1 L_x} - 1) \right. \\
& \quad \left. + c_1(L) \frac{1}{-\kappa_1} (e^{-\kappa_1 L_x} - 1) + \sum_{n=1}^{\infty} (-1)^n d_{1,n}(L) \frac{1}{-p_1} (e^{-p_1 L_x} - 1) \right) \\
& + \frac{L_y}{2} \sigma_3 \left(a_2(L)(\sigma_3 \cosh(\kappa_2 L) + \sigma_4) L_x + b_2 \frac{1}{\kappa_2} (1 - e^{-\kappa_2 L_x}) + \Phi_D L_x \right. \\
& \quad \left. + c_2(L) \frac{1}{\kappa_2} (1 - e^{-\kappa_2 L_x}) + \sum_{n=1}^{\infty} d_{2,n}(L) \frac{1}{p_2} (1 - e^{-p_2 L_x}) \right) \\
& + \frac{L_y}{2} \sigma_4 \left(a_2(L)(\sigma_3 + \sigma_4 \cosh(\kappa_2 L)) L_x + b_2 \frac{1}{\kappa_2} (1 - e^{-\kappa_2 L_x}) + \Phi_D L_x \right. \\
& \quad \left. + c_2(L) \frac{1}{\kappa_2} (1 - e^{-\kappa_2 L_x}) + \sum_{n=1}^{\infty} (-1)^n d_{2,n}(L) \frac{1}{p_2} (1 - e^{-p_2 L_x}) \right) \\
& + \frac{L_x L_y \Phi_D}{2} (\sigma_3 + \sigma_4) \\
& + \frac{\varepsilon_1 \Phi_D L_y}{2} \left(-\kappa_1 b_1 L - \kappa_1 c_1(L) L + \sum_{n=1}^{\infty} d_{1,n}(L) (-p_1) \frac{L}{n\pi} \underbrace{\left(\sin\left(\frac{n\pi L}{L}\right) - \sin(0) \right)}_{=0} \right)
\end{aligned}$$

We are interested in the case of large L_x so we approx. $e^{-aL_x} \approx 0$ for all factors $a \in \mathbb{R}$ not depending on L_x .

$$\begin{aligned}
\mathcal{H} &\approx \frac{\sigma_1}{2} a_1(L) (\sigma_1 \cosh(\kappa_1 L) + \sigma_2) L_x L_y + \frac{\sigma_1}{2} \frac{b_1}{\kappa_1} L_y + \frac{\sigma_1}{2} \frac{c_1(L)}{\kappa_1} L_y + \frac{\sigma_1}{2} \left(\sum_{n=1}^{\infty} \frac{d_{1,n}(L)}{p_1} \right) L_y \\
&+ \frac{\sigma_2}{2} a_1(L) (\sigma_1 + \sigma_2 \cosh(\kappa_1 L)) L_x L_y + \frac{\sigma_2}{2} \frac{b_1}{\kappa_1} L_y + \frac{\sigma_2}{2} \frac{c_1(L)}{\kappa_1} L_y + \frac{\sigma_2}{2} \left(\sum_{n=1}^{\infty} (-1)^n \frac{d_{1,n}(L)}{p_1} \right) L_y \\
&+ \frac{\sigma_3}{2} a_2(L) (\sigma_3 \cosh(\kappa_2 L) + \sigma_4) L_x L_y + \frac{\sigma_3}{2} \frac{b_2}{\kappa_2} L_y + \frac{\sigma_3}{2} \frac{c_1(L)}{\kappa_2} L_y + \frac{\sigma_3}{2} \Phi_D L_x L_y + \frac{\sigma_3}{2} \left(\sum_{n=1}^{\infty} \frac{d_{2,n}(L)}{p_2} \right) L_y \\
&+ \frac{\sigma_4}{2} a_2(L) (\sigma_3 + \sigma_4 \cosh(\kappa_2 L)) L_x L_y + \frac{\sigma_4}{2} \frac{b_2}{\kappa_2} L_y + \frac{\sigma_4}{2} \frac{c_1(L)}{\kappa_2} L_y + \frac{\sigma_4}{2} \Phi_D L_x L_y + \frac{\sigma_4}{2} \left(\sum_{n=1}^{\infty} (-1)^n \frac{d_{2,n}(L)}{p_2} \right) L_y \\
&+ \frac{\Phi_D}{2} (\sigma_3 + \sigma_4) L_x L_y \\
&+ \frac{\varepsilon_1 \Phi_D}{2} (-\kappa_1 b_1) L_y L + \frac{\varepsilon_1 \Phi_D}{2} (-\kappa_1) c_1(L) L_y L \\
&= \left[\frac{a_1(L)}{2} ((\sigma_1^2 + \sigma_2^2) \cosh(\kappa_1 L) + 2\sigma_1 \sigma_2) \right. \\
&+ \frac{a_2(L)}{2} (\sigma_3^2 + \sigma_4^2) \cosh(\kappa_2 L) + 2\sigma_3 \sigma_4 \\
&+ \left. \Phi_D (\sigma_3 + \sigma_4) \right] L_x L_y \\
&+ \left[\frac{b_1}{2\kappa_1} (\sigma_1 + \sigma_2) + \frac{c_1(L)}{2\kappa_1} (\sigma_1 + \sigma_2) + \frac{1}{2} \left(\sum_{n=1}^{\infty} \frac{(\sigma_1 + (-1)^n \sigma_2) d_{1,n}(L)}{p_1} \right) \right. \\
&+ \left. \frac{b_2}{2\kappa_2} (\sigma_3 + \sigma_4) + \frac{c_2(L)}{2\kappa_2} (\sigma_3 + \sigma_4) + \frac{1}{2} \left(\sum_{n=1}^{\infty} \frac{(\sigma_3 + (-1)^n \sigma_4) d_{2,n}(L)}{p_2} \right) \right] L_y \\
&+ \left[-\frac{\varepsilon_1 \Phi_D}{2} \kappa_1 b_1 - \frac{\varepsilon_1 \Phi_D}{2} \kappa_1 c_1(L) \right] L_y L
\end{aligned}$$

We then proceed to identify the different terms by their proportionality, σ and L -dependence, as outlined above.

$$\tilde{\gamma}_1 = 0$$

$$\tilde{\gamma}_2 = 0$$

$$\tilde{\gamma}_3 = \Phi_D \sigma_3$$

$$\tilde{\gamma}_4 = \Phi_D \sigma_4$$

$$\tilde{\omega}_{\gamma,1}(L) = \frac{1}{4\varepsilon_1 \kappa_1 \sinh(\kappa_1 L)} ((\sigma_1^2 + \sigma_2^2) \cosh(\kappa_1 L) + 2\sigma_1 \sigma_2)$$

$$\tilde{\omega}_{\gamma,2}(L) = \frac{1}{4\varepsilon_2 \kappa_2 \sinh(\kappa_2 L)} ((\sigma_3^2 + \sigma_4^2) \cosh(\kappa_2 L) + 2\sigma_3 \sigma_4)$$

$$\tilde{\tau}_1 = \frac{1}{2\kappa_1} \frac{\kappa_2 \varepsilon_2 \Phi_D}{\kappa_1 \varepsilon_1 + \kappa_2 \varepsilon_2} \sigma_1 - \frac{1}{2\kappa_2} \frac{\kappa_1 \varepsilon_1 \Phi_D}{\kappa_1 \varepsilon_1 + \kappa_2 \varepsilon_2} \sigma_3 - \frac{\Phi_D}{2} \frac{1}{\kappa_1 \varepsilon_1 + \kappa_2 \varepsilon_2} \left(\frac{\varepsilon_1 \kappa_1}{\kappa_2} \sigma_3 - \frac{\varepsilon_2 \kappa_2}{\kappa_1} \sigma_1 \right)$$

$$= \frac{\Phi_D}{\kappa_1 \varepsilon_1 + \kappa_2 \varepsilon_2} \left(\frac{\varepsilon_2 \kappa_2}{\kappa_1} \sigma_1 - \frac{\varepsilon_1 \kappa_1}{\kappa_2} \sigma_3 \right)$$

$$\tilde{\tau}_2 = \frac{1}{2\kappa_1} \frac{\kappa_2 \varepsilon_2 \Phi_D}{\kappa_1 \varepsilon_1 + \kappa_2 \varepsilon_2} \sigma_2 - \frac{1}{2\kappa_2} \frac{\kappa_1 \varepsilon_1 \Phi_D}{\kappa_1 \varepsilon_1 + \kappa_2 \varepsilon_2} \sigma_4 - \frac{\Phi_D}{2} \frac{1}{\kappa_1 \varepsilon_1 + \kappa_2 \varepsilon_2} \left(\frac{\varepsilon_1 \kappa_1}{\kappa_2} \sigma_4 - \frac{\varepsilon_2 \kappa_2}{\kappa_1} \sigma_2 \right)$$

$$= \frac{\Phi_D}{\kappa_1 \varepsilon_1 + \kappa_2 \varepsilon_2} \left(\frac{\varepsilon_2 \kappa_2}{\kappa_1} \sigma_2 - \frac{\varepsilon_1 \kappa_1}{\kappa_2} \sigma_4 \right)$$

$$\tilde{\omega}_\tau = \frac{c_1(L)}{4\kappa_1} (\sigma_1 + \sigma_2) + \frac{c_2(L)}{4\kappa_2} (\sigma_3 + \sigma_4) + \frac{1}{4} \sum_{n=1}^{\infty} (\sigma_1 + (-1)^n \sigma_2) \frac{d_{1,n}(L)}{p_1} + (\sigma_3 + (-1)^n \sigma_4) \frac{d_{2,n}(L)}{p_2}$$

$$= \frac{1}{4\kappa_1 L} \frac{1}{\kappa_1 \varepsilon_1 + \kappa_2 \varepsilon_2} \left(\frac{\sigma_3 + \sigma_4}{\kappa_2} - \frac{1}{\kappa_1} \frac{\kappa_2 \varepsilon_2}{\kappa_1 \varepsilon_1} (\sigma_1 + \sigma_2) \right) (\sigma_1 + \sigma_2)$$

$$+ \frac{1}{4\kappa_2 L} \frac{1}{\kappa_1 \varepsilon_1 + \kappa_2 \varepsilon_2} \left(\frac{\sigma_1 + \sigma_2}{\kappa_1} - \frac{1}{\kappa_2} \frac{\kappa_1 \varepsilon_1}{\kappa_2 \varepsilon_2} (\sigma_3 + \sigma_4) \right) (\sigma_3 + \sigma_4)$$

$$\begin{aligned}
& + \frac{1}{2L} \sum_{n=1}^{\infty} \frac{1}{\varepsilon_1 p_1 + \varepsilon_2 p_2} \left(\frac{2(\sigma_1 + (-1)^n \sigma_2)(\sigma_3 + (-1)^n \sigma_4)}{p_1 p_2} - \frac{1}{p_1} \frac{\varepsilon_2 p_2}{\varepsilon_1 p_1^2} (\sigma_1 + (-1)^n \sigma_2)^2 - \frac{1}{p_2} \frac{\varepsilon_1 p_1}{\varepsilon_2 p_2^2} (\sigma_3 + (-1)^n \sigma_4)^2 \right) \\
& = \frac{1}{L} \frac{1}{\kappa_1 \varepsilon_1 + \kappa_2 \varepsilon_2} \left(\frac{(\sigma_1 + \sigma_2)(\sigma_3 + \sigma_4)}{2\kappa_1 \kappa_2} - \frac{1}{4\kappa_1^2} \frac{\kappa_2 \varepsilon_2}{\kappa_1 \varepsilon_1} (\sigma_1 + \sigma_2)^2 - \frac{1}{4\kappa_2^2} \frac{\kappa_1 \varepsilon_1}{\kappa_2 \varepsilon_2} (\sigma_3 + \sigma_4)^2 \right) \\
& + \frac{1}{2L} \sum_{n=1}^{\infty} \frac{1}{\varepsilon_1 p_1 + \varepsilon_2 p_2} \left(\frac{2(\sigma_1 + (-1)^n \sigma_2)(\sigma_3 + (-1)^n \sigma_4)}{p_1 p_2} - \frac{1}{p_1} \frac{\varepsilon_2 p_2}{\varepsilon_1 p_1^2} (\sigma_1 + (-1)^n \sigma_2)^2 - \frac{1}{p_2} \frac{\varepsilon_1 p_1}{\varepsilon_2 p_2^2} (\sigma_3 + (-1)^n \sigma_4)^2 \right) \\
\gamma_{1,2} & = -\frac{\varepsilon_1 \kappa_1 \Phi_D b_1}{2} = -\frac{\varepsilon_1 \varepsilon_2 \kappa_1 \kappa_2 \Phi_D^2}{2(\kappa_1 \varepsilon_1 + \kappa_2 \varepsilon_2)}
\end{aligned}$$

As explained earlier, we now calculate the limits of the L -dependent terms so we can obtain our final quantities

$$\begin{aligned}
\lim_{L \rightarrow \infty} \tilde{\omega}_{\gamma,1} & = \lim_{L \rightarrow \infty} \frac{1}{4\varepsilon_1 \kappa_1} \left((\sigma_1^2 + \sigma_2^2) \frac{\cosh(\kappa_1 L)}{\sinh(\kappa_1 L)} + \frac{2\sigma_1 \sigma_2}{\sinh(\kappa_1 L)} \right) \\
& = \frac{\sigma_1^2 + \sigma_2^2}{4\kappa_1 \varepsilon_1}
\end{aligned}$$

Similarly,

$$\lim_{L \rightarrow \infty} \tilde{\omega}_{\gamma,2} = \frac{\sigma_3^2 + \sigma_4^2}{4\kappa_2 \varepsilon_2}$$

with this limit and the expression calculated above we can use Eq. (IV.3) to obtain

$$\begin{aligned}
\gamma_1 & = \frac{\sigma_1^2}{2\kappa_1 \varepsilon_1} \\
\gamma_2 & = \frac{\sigma_2^2}{2\kappa_1 \varepsilon_1} \\
\gamma_3 & = \frac{\sigma_3^2}{2\kappa_2 \varepsilon_2} + \sigma_3 \Phi_D \\
\gamma_4 & = \frac{\sigma_4^2}{2\kappa_2 \varepsilon_2} + \sigma_4 \Phi_D \\
\omega_{\gamma,1}(L) & = \frac{1}{4\kappa_1 \varepsilon_1} \left((\sigma_1^2 + \sigma_2^2)(\coth(\kappa_1 L) - 1) + \frac{2\sigma_1 \sigma_2}{\sinh(\kappa_1 L)} \right) \\
\omega_{\gamma,2}(L) & = \frac{1}{4\kappa_2 \varepsilon_2} \left((\sigma_3^2 + \sigma_4^2)(\coth(\kappa_2 L) - 1) + \frac{2\sigma_3 \sigma_4}{\sinh(\kappa_2 L)} \right)
\end{aligned}$$

for the following, we define

$$p_{i,n} := \sqrt{\left(\frac{n\pi}{L}\right)^2 + \kappa_i^2} \quad \text{and} \quad p_i(x) := \sqrt{x^2 \pi^2 + \kappa_i^2}$$

With this definition $\tilde{\omega}_\tau$ can be written in a more compact form, which is useful for calculating the following limit:

$$\begin{aligned}
\lim_{L \rightarrow \infty} \tilde{\omega}_\tau & = \lim_{L \rightarrow \infty} \frac{1}{L} \frac{1}{\kappa_1 \varepsilon_1 + \kappa_2 \varepsilon_2} \left(\frac{(\sigma_1 + \sigma_2)(\sigma_3 + \sigma_4)}{2\kappa_1 \kappa_2} - \frac{1}{4\kappa_1^2} \frac{\kappa_2 \varepsilon_2}{\kappa_1 \varepsilon_1} (\sigma_1 + \sigma_2)^2 - \frac{1}{4\kappa_2^2} \frac{\kappa_1 \varepsilon_1}{\kappa_2 \varepsilon_2} (\sigma_3 + \sigma_4)^2 \right) \\
& + \lim_{L \rightarrow \infty} \frac{1}{2L} \sum_{n=1}^{\infty} \frac{1}{\varepsilon_1 p_{1,n} + \varepsilon_2 p_{2,n}} \left(\frac{2(\sigma_1 + (-1)^n \sigma_2)(\sigma_3 + (-1)^n \sigma_4)}{p_{1,n} p_{2,n}} \right. \\
& \quad \left. - \frac{1}{p_{1,n}} \frac{\varepsilon_2 p_{2,n}}{\varepsilon_1 p_{1,n}^2} (\sigma_1 + (-1)^n \sigma_2)^2 - \frac{1}{p_{2,n}} \frac{\varepsilon_1 p_{1,n}}{\varepsilon_2 p_{2,n}^2} (\sigma_3 + (-1)^n \sigma_4)^2 \right) \\
& = \lim_{L \rightarrow \infty} \frac{1}{2L} \sum_{n=1}^{\infty} \frac{1}{\varepsilon_1 p_{1,n} + \varepsilon_2 p_{2,n}} \left(\frac{2(\sigma_1 + (-1)^n \sigma_2)(\sigma_3 + (-1)^n \sigma_4)}{p_{1,n} p_{2,n}} \right. \\
& \quad \left. - \frac{1}{p_{1,n}} \frac{\varepsilon_2 p_{2,n}}{\varepsilon_1 p_{1,n}^2} (\sigma_1 + (-1)^n \sigma_2)^2 - \frac{1}{p_{2,n}} \frac{\varepsilon_1 p_{1,n}}{\varepsilon_2 p_{2,n}^2} (\sigma_3 + (-1)^n \sigma_4)^2 \right) \\
& = \lim_{L \rightarrow \infty} \frac{1}{2L} \sum_{k=1}^{\infty} \frac{1}{\varepsilon_1 p_{1,2k} + \varepsilon_2 p_{2,2k}} \left(\frac{2(\sigma_1 + \sigma_2)(\sigma_3 + \sigma_4)}{p_{1,2k} p_{2,2k}} \right)
\end{aligned}$$

$$\begin{aligned}
& - \frac{1}{p_{1,2k} \varepsilon_1 p_{1,2k}^2} (\sigma_1 + \sigma_2)^2 - \frac{1}{p_{2,2k} \varepsilon_2 p_{2,2k}^2} (\sigma_3 + \sigma_4)^2 \\
& + \lim_{L \rightarrow \infty} \frac{1}{2L} \sum_{l=1}^{\infty} \frac{1}{\varepsilon_1 p_{1,2l-1} + \varepsilon_2 p_{2,2l-1}} \left(\frac{2(\sigma_1 - \sigma_2)(\sigma_3 - \sigma_4)}{p_{1,2l-1} p_{2,2l-1}} \right. \\
& \quad \left. - \frac{1}{p_{1,2l-1} \varepsilon_1 p_{1,2l-1}^2} (\sigma_1 - \sigma_2)^2 - \frac{1}{p_{2,2l-1} \varepsilon_2 p_{2,2l-1}^2} (\sigma_3 - \sigma_4)^2 \right) \\
& = \frac{1}{2L} \frac{L}{2} \int_0^\infty \frac{1}{\varepsilon_1 p_1(x) + \varepsilon_2 p_2(x)} \left(\frac{2(\sigma_1 + \sigma_2)(\sigma_3 + \sigma_4)}{p_1(x) p_2(x)} \right. \\
& \quad \left. - \frac{1}{p_1(x) \varepsilon_1 p_1(x)^2} (\sigma_1 + \sigma_2)^2 - \frac{1}{p_2(x) \varepsilon_2 p_2(x)^2} (\sigma_3 + \sigma_4)^2 \right) dx \\
& + \frac{1}{2L} \frac{L}{2} \int_0^\infty \frac{1}{\varepsilon_1 p_1(x) + \varepsilon_2 p_2(x)} \left(\frac{2(\sigma_1 - \sigma_2)(\sigma_3 - \sigma_4)}{p_1(x) p_2(x)} \right. \\
& \quad \left. - \frac{1}{p_1(x) \varepsilon_1 p_1(x)^2} (\sigma_1 - \sigma_2)^2 - \frac{1}{p_2(x) \varepsilon_2 p_2(x)^2} (\sigma_3 - \sigma_4)^2 \right) dx \\
& = \frac{1}{4} \int_0^\infty \frac{1}{\varepsilon_1 p_1(x) + \varepsilon_2 p_2(x)} \left(\frac{2((\sigma_1 + \sigma_2)(\sigma_3 + \sigma_4) + (\sigma_1 - \sigma_2)(\sigma_3 - \sigma_4))}{p_1(x) p_2(x)} \right. \\
& \quad \left. - \frac{\varepsilon_2 p_2(x)}{\varepsilon_1 p_1(x)^3} ((\sigma_1 + \sigma_2)^2 + (\sigma_1 - \sigma_2)^2) - \frac{\varepsilon_1 p_1(x)}{\varepsilon_2 p_2(x)^3} ((\sigma_3 + \sigma_4)^2 + (\sigma_3 - \sigma_4)^2) \right) dx \\
& = \frac{1}{2} \int_0^\infty \frac{1}{\varepsilon_1 p_1(x) + \varepsilon_2 p_2(x)} \left(\frac{2(\sigma_1 \sigma_3 + \sigma_2 \sigma_4)}{p_1(x) p_2(x)} \right. \\
& \quad \left. - \frac{\varepsilon_2 p_2(x)}{\varepsilon_1 p_1(x)^3} (\sigma_1^2 + \sigma_2^2) - \frac{\varepsilon_1 p_1(x)}{\varepsilon_2 p_2(x)^3} (\sigma_3^2 + \sigma_4^2) \right) dx \\
& = \frac{1}{2} \int_0^\infty \frac{1}{\varepsilon_1 p_1(x) + \varepsilon_2 p_2(x)} \left(\frac{2\sigma_1 \sigma_3}{p_1(x) p_2(x)} - \frac{\varepsilon_2 p_2(x)}{\varepsilon_1 p_1(x)^3} \sigma_1^2 - \frac{\varepsilon_1 p_1(x)}{\varepsilon_2 p_2(x)^3} \sigma_3^2 \right) dx \\
& + \frac{1}{2} \int_0^\infty \frac{1}{\varepsilon_1 p_1(x) + \varepsilon_2 p_2(x)} \left(\frac{2\sigma_2 \sigma_4}{p_1(x) p_2(x)} - \frac{\varepsilon_2 p_2(x)}{\varepsilon_1 p_1(x)^3} \sigma_2^2 - \frac{\varepsilon_1 p_1(x)}{\varepsilon_2 p_2(x)^3} \sigma_4^2 \right) dx
\end{aligned}$$

With this limit and the expression calculated above we can use Eq. (IV.3) to obtain

$$\begin{aligned}
\tau_1 & = \frac{\Phi_D}{\kappa_1 \varepsilon_1 + \kappa_2 \varepsilon_2} \left(\frac{\varepsilon_2 \kappa_2}{\kappa_1} \sigma_1 - \frac{\varepsilon_1 \kappa_1}{\kappa_2} \sigma_3 \right) \\
& + \int_0^\infty \frac{1}{\varepsilon_1 p_1(x) + \varepsilon_2 p_2(x)} \left(\frac{2\sigma_1 \sigma_3}{p_1(x) p_2(x)} - \frac{\varepsilon_2 p_2(x)}{\varepsilon_1 p_1(x)^3} \sigma_1^2 - \frac{\varepsilon_1 p_1(x)}{\varepsilon_2 p_2(x)^3} \sigma_3^2 \right) dx \\
\tau_2 & = \frac{\Phi_D}{\kappa_1 \varepsilon_1 + \kappa_2 \varepsilon_2} \left(\frac{\varepsilon_2 \kappa_2}{\kappa_1} \sigma_2 - \frac{\varepsilon_1 \kappa_1}{\kappa_2} \sigma_4 \right) \\
& + \int_0^\infty \frac{1}{\varepsilon_1 p_1(x) + \varepsilon_2 p_2(x)} \left(\frac{2\sigma_2 \sigma_4}{p_1(x) p_2(x)} - \frac{\varepsilon_2 p_2(x)}{\varepsilon_1 p_1(x)^3} \sigma_2^2 - \frac{\varepsilon_1 p_1(x)}{\varepsilon_2 p_2(x)^3} \sigma_4^2 \right) dx \\
\omega_\tau(L) & = \frac{1}{L} \frac{1}{\kappa_1 \varepsilon_1 + \kappa_2 \varepsilon_2} \left(\frac{(\sigma_1 + \sigma_2)(\sigma_3 + \sigma_4)}{2\kappa_1 \kappa_2} - \frac{1}{4\kappa_1^2 \kappa_1 \varepsilon_1} (\sigma_1 + \sigma_2)^2 - \frac{1}{4\kappa_2^2 \kappa_2 \varepsilon_2} (\sigma_3 + \sigma_4)^2 \right) \\
& + \frac{1}{2L} \sum_{n=1}^{\infty} \frac{1}{\varepsilon_1 p_1 + \varepsilon_2 p_2} \left(\frac{2(\sigma_1 + (-1)^n \sigma_2)(\sigma_3 + (-1)^n \sigma_4)}{p_1 p_2} - \frac{1}{p_1} \frac{\varepsilon_2 p_2}{\varepsilon_1 p_1^2} (\sigma_1 + (-1)^n \sigma_2)^2 - \frac{1}{p_2} \frac{\varepsilon_1 p_1}{\varepsilon_2 p_2^2} (\sigma_3 + (-1)^n \sigma_4)^2 \right) \\
& - \frac{1}{2} \int_0^\infty \frac{1}{\varepsilon_1 p_1(x) + \varepsilon_2 p_2(x)} \left(\frac{2(\sigma_1 \sigma_3 + \sigma_2 \sigma_4)}{p_1(x) p_2(x)} - \frac{\varepsilon_2 p_2(x)}{\varepsilon_1 p_1(x)^3} (\sigma_1^2 + \sigma_2^2) - \frac{\varepsilon_1 p_1(x)}{\varepsilon_2 p_2(x)^3} (\sigma_3^2 + \sigma_4^2) \right) dx \quad (\text{IV.5})
\end{aligned}$$

13.1 Consistency with literature

We test our expression for consistency with with the result of Ref. [20, 21]. For this we have to set

$$L = 2L'$$

$$\sigma'_1 = \sigma_1 = \sigma_2$$

$$\sigma'_2 = \sigma_3 = \sigma_4$$

since in Ref. [20] the walls are located at $z = \pm L$ and the system therefore has a length of $2L$.

Surface interaction energies

$$\begin{aligned}
\bar{\omega}_{\gamma,1}(L') &= \frac{\sigma'_1}{2\kappa_1\varepsilon_1} \left(\coth(2\kappa_1 L') - 1 + \frac{1}{\sinh(2\kappa_1 L')} \right) \\
&= \frac{\sigma'_1}{2\kappa_1\varepsilon_1} \left(\frac{\cosh(2\kappa_1 L') + 1}{\sinh(2\kappa_1 L')} - 1 \right) \\
&= \frac{\sigma'_1}{2\kappa_1\varepsilon_1} \left(\frac{\cosh^2(\kappa_1 L') + \sinh^2(\kappa_1 L') + 1}{2 \sinh(\kappa_1 L') \cosh(\kappa_1 L')} - 1 \right) \\
&= \frac{\sigma'_1}{2\kappa_1\varepsilon_1} (\coth(\kappa_1 L') - 1) \quad \checkmark
\end{aligned}$$

Surface tensions

$$\begin{aligned}
\bar{\gamma}_1 2L_x L_y &= (\gamma_1 + \gamma_2) L_x L_y \\
\Rightarrow \bar{\gamma}_1 &= \frac{\gamma_1 + \gamma_2}{2} = \frac{\sigma_1'^2}{4\kappa_1\varepsilon_1} + \frac{\sigma_2'^2}{4\kappa_1\varepsilon_1} = \frac{\sigma_1'^2}{2\kappa_1\varepsilon_1} \quad \checkmark
\end{aligned}$$

$$\begin{aligned}
\bar{\gamma}_2 2L_x L_y &= (\gamma_3 + \gamma_4) L_x L_y \\
\Rightarrow \bar{\gamma}_2 &= \frac{\gamma_3 + \gamma_4}{2} = \frac{\sigma_2'^2}{4\kappa_2\varepsilon_2} + \frac{\sigma_2'\Phi_D}{2} + \frac{\sigma_2'^2}{4\kappa_2\varepsilon_2} + \frac{\sigma_2'\Phi_D}{2} = \frac{\sigma_1'^2}{2\kappa_1\varepsilon_1} + \sigma_2'\Phi_D \quad \checkmark
\end{aligned}$$

Interfacial tension

$$\begin{aligned}
\bar{\gamma}_{1,2} L_y L' &= \gamma_{1,2} L_y L = \gamma_{1,2} 2L_y L' \\
\Rightarrow \bar{\gamma}_{1,2} &= 2\gamma_{1,2} = -\frac{\varepsilon_1\varepsilon_2\kappa_1\kappa_2\Phi_D^2}{\kappa_1\varepsilon_1 + \kappa_2\varepsilon_2} \quad \checkmark
\end{aligned}$$

Line interaction energy

$$\begin{aligned}
\sigma_1 + (-1)^n \sigma_2 &= \sigma'_1 + (-1)^n \sigma'_1 = \begin{cases} 2\sigma'_1 & n \text{ even} \\ 0 & n \text{ odd} \end{cases} \\
\sigma_3 + (-1)^n \sigma_4 &= \sigma'_2 + (-1)^n \sigma'_2 = \begin{cases} 2\sigma'_2 & n \text{ even} \\ 0 & n \text{ odd} \end{cases}
\end{aligned}$$

so we can define $n' := \frac{n}{2}$ and write

$$p_i = \sqrt{\left(\frac{n\pi}{L}\right)^2 + \kappa_i^2} = \sqrt{\left(\frac{n\pi}{2L'}\right)^2 + \kappa_i^2} = \sqrt{\left(\frac{n'\pi}{L'}\right)^2 + \kappa_i^2}$$

and

$$\begin{aligned}
\omega_\tau(L) &= \frac{1}{2L'} \frac{1}{\kappa_1\varepsilon_1 + \kappa_2\varepsilon_2} \left(\frac{2\sigma'_1\sigma'_2}{\kappa_1\kappa_2} - \frac{1}{\kappa_1^2} \frac{\kappa_2\varepsilon_2}{\kappa_1\varepsilon_1} \sigma_1'^2 - \frac{1}{\kappa_2^2} \frac{\kappa_1\varepsilon_1}{\kappa_2\varepsilon_2} \sigma_2'^2 \right) \\
&+ \frac{1}{L'} \sum_{n'=1}^{\infty} \frac{1}{\varepsilon_1 p_1 + \varepsilon_2 p_2} \left(\frac{2\sigma'_1\sigma'_2}{p_1 p_2} - \frac{1}{p_1} \frac{\varepsilon_2 p_2}{\varepsilon_1 p_1^2} \sigma_1'^2 - \frac{1}{p_2} \frac{\varepsilon_1 p_1}{\varepsilon_2 p_2^2} \sigma_2'^2 \right) \\
&- \int_0^\infty \frac{1}{\varepsilon_1 p_1(x) + \varepsilon_2 p_2(x)} \left(\frac{2\sigma'_1\sigma'_2}{p_1(x)p_2(x)} - \frac{\varepsilon_2 p_2(x)}{\varepsilon_1 p_1(x)^3} \sigma_1'^2 - \frac{\varepsilon_1 p_1(x)}{\varepsilon_2 p_2(x)^3} \sigma_2'^2 \right) dx
\end{aligned}$$

We compare this with the expression given in [20]

$$\begin{aligned}
\omega_\tau &= \frac{\sigma_1'^2}{\kappa_1^2\varepsilon_1} \frac{1}{2\kappa_1 L'} \frac{\frac{2\sigma_2'\kappa_1}{\sigma_1'\kappa_2} - \frac{\kappa_2\varepsilon_2}{\kappa_1\varepsilon_1} - \frac{\sigma_2'^2\kappa_1^3\varepsilon_1}{\sigma_1'^2\kappa_2^3\varepsilon_2}}{1 + \frac{\kappa_2\varepsilon_2}{\kappa_1\varepsilon_1}} \\
&+ \frac{\sigma_1'^2}{\kappa_1^2\varepsilon_1} \frac{1}{\kappa_1 L'} \sum_{n=1}^{\infty} \frac{\frac{\sigma_2'\varepsilon_1}{\sigma_1'\varepsilon_2} \frac{1}{\frac{n^2\pi^2}{\kappa_1^2 L'^2} + \frac{\kappa_2^2}{\kappa_1^2}} - \frac{1}{\frac{n^2\pi^2}{\kappa_1^2 L'^2} + 1}}{1 + \frac{\frac{\varepsilon_2}{\varepsilon_1} \sqrt{\frac{n^2\pi^2}{\kappa_1^2 L'^2} + \frac{\kappa_2^2}{\kappa_1^2}}}{\sqrt{\frac{n^2\pi^2}{\kappa_1^2 L'^2} + 1}}} + \frac{\frac{\sigma_2'}{\sigma_1'} \frac{1}{\frac{n^2\pi^2}{\kappa_1^2 L'^2} + 1} - \frac{\sigma_2'^2\varepsilon_1}{\sigma_1'^2\varepsilon_2} \frac{1}{\frac{n^2\pi^2}{\kappa_1^2 L'^2} + \frac{\kappa_2^2}{\kappa_1^2}}}{1 + \frac{\frac{\varepsilon_2}{\varepsilon_1} \sqrt{\frac{n^2\pi^2}{\kappa_1^2 L'^2} + \frac{\kappa_2^2}{\kappa_1^2}}}{\sqrt{\frac{n^2\pi^2}{\kappa_1^2 L'^2} + 1}}} \frac{1}{\sqrt{\frac{n^2\pi^2}{\kappa_1^2 L'^2} + \frac{\kappa_2^2}{\kappa_1^2}}}
\end{aligned}$$

$$\begin{aligned}
& + \frac{\sigma_1'^2}{\kappa_1^2 \varepsilon_1} \int_0^\infty dx \frac{\frac{\sigma_2' \varepsilon_1}{\sigma_1' \varepsilon_2} \frac{1}{x^2 \pi^2 + \frac{\kappa_2^2}{\kappa_1^2}} - \frac{1}{x^2 \pi^2 + 1}}{1 + \frac{\frac{\varepsilon_2}{\varepsilon_1} \sqrt{x^2 \pi^2 + \frac{\kappa_2^2}{\kappa_1^2}}}{\sqrt{\frac{n^2 \pi^2}{\kappa_1^2 L'^2} + 1}}} \frac{1}{\sqrt{x^2 \pi^2 + 1}} + \frac{\frac{\sigma_2' \varepsilon_1}{\sigma_1' \varepsilon_2} \frac{1}{x^2 \pi^2 + 1} - \frac{\sigma_2'^2 \varepsilon_1}{\sigma_1'^2 \varepsilon_2} \frac{1}{x^2 \pi^2 + \frac{\kappa_2^2}{\kappa_1^2}}}{1 + \frac{\frac{\varepsilon_2}{\varepsilon_1} \sqrt{x^2 \pi^2 + \frac{\kappa_2^2}{\kappa_1^2}}}{\sqrt{\frac{n^2 \pi^2}{\kappa_1^2 L'^2} + 1}}} \frac{1}{\sqrt{x^2 \pi^2 + \frac{\kappa_2^2}{\kappa_1^2}}} \\
& = \frac{1}{2\kappa_1 L'} \frac{\sigma_1'^2}{\kappa_1} \frac{1}{\kappa_1 \varepsilon_1 + \kappa_2 \varepsilon_2} \left(\frac{2\sigma_2' \kappa_1}{\sigma_1' \kappa_2} - \frac{\kappa_2 \varepsilon_2}{\kappa_1 \varepsilon_1} - \frac{\sigma_2'^2 \kappa_1^3 \varepsilon_1}{\sigma_1'^2 \kappa_2^3 \varepsilon_2} \right) \\
& + \frac{\sigma_1'^2}{\varepsilon_1} \frac{1}{L'} \sum_{n=1}^\infty \frac{\frac{\sigma_2' \varepsilon_1}{\sigma_1' \varepsilon_2} \frac{1}{p_2^2} - \frac{1}{p_1^2}}{1 + \frac{\varepsilon_1 p_1}{\varepsilon_2 p_2}} \frac{1}{p_1} + \frac{\frac{\sigma_2' \varepsilon_1}{\sigma_1' \varepsilon_2} \frac{1}{p_2^2} - \frac{\sigma_2'^2 \varepsilon_1}{\sigma_1'^2 \varepsilon_2} \frac{1}{p_2^2}}{1 + \frac{\varepsilon_2 p_2}{\varepsilon_1 p_1}} \frac{1}{p_2} \\
& + \frac{\sigma_1'^2}{\varepsilon_1} \int_0^\infty dx \frac{\frac{\sigma_2' \varepsilon_1}{\sigma_1' \varepsilon_2} \frac{1}{p_2(x)^2} - \frac{1}{p_1(x)^2}}{1 + \frac{\varepsilon_1 p_1(x)}{\varepsilon_2 p_2(x)}} \frac{1}{p_1(x)} + \frac{\frac{\sigma_2' \varepsilon_1}{\sigma_1' \varepsilon_2} \frac{1}{p_2(x)^2} - \frac{\sigma_2'^2 \varepsilon_1}{\sigma_1'^2 \varepsilon_2} \frac{1}{p_2(x)^2}}{1 + \frac{\varepsilon_2 p_2(x)}{\varepsilon_1 p_1(x)}} \frac{1}{p_2(x)} \\
& = \frac{1}{2L'} \frac{1}{\kappa_1 \varepsilon_1 + \kappa_2 \varepsilon_2} \left(\frac{2\sigma_1' \sigma_2'}{\kappa_1 \kappa_2} - \frac{\sigma_1'^2 \kappa_2 \varepsilon_2}{\kappa_1^3 \varepsilon_1} - \frac{\sigma_2'^2 \kappa_1 \varepsilon_1}{\kappa_2^3 \varepsilon_2} \right) \\
& + \frac{1}{L'} \sum_{n=1}^\infty \frac{1}{\varepsilon_1 p_1 + \varepsilon_2 p_2} \left(\frac{\sigma_1' \sigma_2'}{p_1 p_2} - \frac{\varepsilon_2 \sigma_1'^2 p_2}{\varepsilon_1 p_1^3} + \frac{\sigma_1' \sigma_2'}{p_1 p_2} - \frac{\varepsilon_1 \sigma_2'^2 p_1}{\varepsilon_2 p_2^3} \right) \\
& + \int_0^\infty dx \frac{1}{\varepsilon_1 p_1(x) + \varepsilon_2 p_2(x)} \left(\frac{\sigma_1' \sigma_2'}{p_1(x) p_2(x)} - \frac{\varepsilon_2 \sigma_1'^2 p_2(x)}{\varepsilon_1 p_1(x)^3} + \frac{\sigma_1' \sigma_2'}{p_1(x) p_2(x)} - \frac{\varepsilon_1 \sigma_2'^2 p_1(x)}{\varepsilon_2 p_2(x)^3} \right) \quad \checkmark
\end{aligned}$$

Line tension

$$\bar{\tau} 2l = (\tau_1 + \tau_2)l$$

$$\begin{aligned}
\Rightarrow \bar{\tau} & = \frac{\tau_1 + \tau_2}{2} \\
& = \frac{\Phi_D}{2(\kappa_1 \varepsilon_1 + \kappa_2 \varepsilon_2)} \left(\frac{\varepsilon_2 \kappa_2}{\kappa_1} (\sigma_1 + \sigma_2) - \frac{\varepsilon_1 \kappa_1}{\kappa_2} (\sigma_3 + \sigma_4) \right) \\
& + \frac{1}{2} \int_0^\infty \frac{1}{\varepsilon_1 p_1(x) + \varepsilon_2 p_2(x)} \left(\frac{2(\sigma_1 \sigma_3 + \sigma_2 \sigma_4)}{p_1(x) p_2(x)} - \frac{\varepsilon_2 p_2(x)}{\varepsilon_1 p_1(x)^3} (\sigma_1^2 + \sigma_2^2) - \frac{\varepsilon_1 p_1(x)}{\varepsilon_2 p_2(x)^3} (\sigma_3^2 + \sigma_4^2) \right) dx
\end{aligned}$$

Since the integral term in this expression is equal to the integral term in our expression for the line interaction energy and the integral term appearing in [20] for line interaction and the term for line tension in [21] are the same and we have already checked the line interaction we only need to check the first term.

$$\begin{aligned}
& \frac{\Phi_D}{2(\kappa_1 \varepsilon_1 + \kappa_2 \varepsilon_2)} \left(\frac{\varepsilon_2 \kappa_2}{\kappa_1} (\sigma_1 + \sigma_2) - \frac{\varepsilon_1 \kappa_1}{\kappa_2} (\sigma_3 + \sigma_4) \right) \\
& = \frac{\Phi_D}{\kappa_1 \varepsilon_1 + \kappa_2 \varepsilon_2} \left(\frac{\varepsilon_2 \kappa_2}{\kappa_1} \sigma_1' - \frac{\varepsilon_1 \kappa_1}{\kappa_2} \sigma_2' \right) = \frac{\Phi_D}{1 + \frac{\kappa_2 \varepsilon_2}{\kappa_1 \varepsilon_1}} \left(\frac{\kappa_2 \varepsilon_2}{\kappa_1 \varepsilon_1} \frac{\sigma_1'}{\kappa_1} - \frac{\sigma_2'}{\kappa_2} \right) \quad \checkmark
\end{aligned}$$

Conclusion Therefore we can obtain the result for the case of identical particles given in Ref. [20, 21] from our general expressions.

14 Superposition Solution

First, we write the potentials calculated in chapter III (Eqs. (III.14) and (III.15)) by using some abbreviations:

$$\begin{aligned}
\Phi_1^s(x, z) & = a_1 e^{-\kappa_1 z} + b_1 e^{\kappa_1(z-L)} + c_1 e^{-\kappa_1 x} \\
& + \frac{1}{\pi} \int_{-\infty}^{\infty} d_1(q) e^{-p_1 x} \cos(qz) dq \\
& + \frac{1}{\pi} \int_{-\infty}^{\infty} f_1(q) e^{-p_1 x} \cos(-(z-L)q) dq
\end{aligned}$$

$$\begin{aligned}
\partial_x \Phi_1^s(x, z) & = -\kappa_1 c_1 e^{-\kappa_1 x} \\
& + \frac{1}{\pi} \int_{-\infty}^{\infty} -p_1 d_1(q) e^{-p_1 x} \cos(qz) dq
\end{aligned}$$

$$+ \frac{1}{\pi} \int_{-\infty}^{\infty} -p_1 f_1(q) e^{-p_1 x} \cos(-(z-L)q) dq$$

$$\begin{aligned} \Phi_2^s(x, z) &= a_2 e^{-\kappa_2 z} + b_2 e^{\kappa_2(z-L)} + 2\Phi_D + c_2 e^{\kappa_2 x} \\ &+ \frac{1}{\pi} \int_{-\infty}^{\infty} d_2(q) e^{p_2 x} \cos(qz) dq \\ &+ \frac{1}{\pi} \int_{-\infty}^{\infty} f_2(q) e^{p_2 x} \cos(-(z-L)q) dq \end{aligned}$$

Then

$$\begin{aligned} &\sigma_1 \Phi_1(x, 0) + \sigma_2 \Phi_1(x, L) \\ &= \sigma_1 \left(a_1 + b_1 e^{-\kappa_1 L} + c_1 e^{-\kappa_1 x} + \frac{1}{\pi} \int_{-\infty}^{\infty} d_1(q) e^{-p_1 x} dq + \frac{1}{\pi} \int_{-\infty}^{\infty} f_1(q) e^{-p_1 x} \cos(qL) dq \right) \\ &+ \sigma_2 \left(a_1 e^{-\kappa_1 L} + b_1 + c_1 e^{-\kappa_1 x} + \frac{1}{\pi} \int_{-\infty}^{\infty} d_1(q) e^{-p_1 x} \cos(qL) dq + \frac{1}{\pi} \int_{-\infty}^{\infty} f_1(q) e^{-p_1 x} dq \right) \end{aligned}$$

$$\begin{aligned} &\sigma_3 \Phi_2(x, 0) + \sigma_4 \Phi_2(x, L) \\ &= \sigma_3 \left(a_2 + b_2 e^{-\kappa_2 L} + 2\Phi_D + c_2 e^{\kappa_2 x} + \frac{1}{\pi} \int_{-\infty}^{\infty} d_2(q) e^{p_2 x} dq + \frac{1}{\pi} \int_{-\infty}^{\infty} f_2(q) e^{p_2 x} \cos(qL) dq \right) \\ &+ \sigma_4 \left(a_2 e^{-\kappa_2 L} + b_2 + 2\Phi_D + c_2 e^{\kappa_2 x} + \frac{1}{\pi} \int_{-\infty}^{\infty} d_2(q) e^{p_2 x} \cos(qL) dq + \frac{1}{\pi} \int_{-\infty}^{\infty} f_2(q) e^{p_2 x} dq \right) \end{aligned}$$

$$(\partial_x \Phi_1)(0, z) = -\kappa_1 c_1 + \frac{1}{\pi} \int_{-\infty}^{\infty} -p_1 d_1(q) \cos(qz) dq + \frac{1}{\pi} \int_{-\infty}^{\infty} -p_1 f_1(q) \cos(-(z-L)q) dq$$

We then proceed to insert these expressions into Eq. (IV.4) in order to calculate the energy.

$$\begin{aligned} \mathcal{H} &= \frac{L_y}{2} \sigma_1 \left(a_1 L_z + b_1 e^{-\kappa_1 L} L_x - \frac{c_1}{\kappa_1} (e^{-\kappa_1 L_x} - 1) \right. \\ &+ \frac{1}{\pi} \int_{-\infty}^{\infty} -\frac{d_1(q)}{p_1} (e^{-p_1 L_x} - 1) dq \\ &+ \left. \frac{1}{\pi} \int_{-\infty}^{\infty} -\frac{f_1(q)}{p_1} (e^{-p_1 L_x} - 1) \cos(qL) dq \right) \\ &+ \frac{L_y}{2} \sigma_2 \left(a_1 e^{-\kappa_1 L} L_z + b_1 L_x - \frac{c_1}{\kappa_1} (e^{-\kappa_1 L_x} - 1) \right. \\ &+ \frac{1}{\pi} \int_{-\infty}^{\infty} -\frac{d_1(q)}{p_1} (e^{-p_1 L_x} - 1) \cos(qL) dq \\ &+ \left. \frac{1}{\pi} \int_{-\infty}^{\infty} -\frac{f_1(q)}{p_1} (e^{-p_1 L_x} - 1) dq \right) \\ &+ \frac{L_y}{2} \sigma_3 \left(a_2 L_z + b_2 e^{-\kappa_2 L} L_x + 2\Phi_D L_x + \frac{c_2}{\kappa_2} (1 - e^{-\kappa_2 L_x}) \right. \\ &+ \frac{1}{\pi} \int_{-\infty}^{\infty} \frac{d_2(q)}{p_2} (1 - e^{-p_2 L_x}) dq \\ &+ \left. \frac{1}{\pi} \int_{-\infty}^{\infty} \frac{f_2(q)}{p_2} (1 - e^{-p_2 L_x}) \cos(qL) dq \right) \\ &+ \frac{L_y}{2} \sigma_4 \left(a_2 e^{-\kappa_2 L} L_z + b_2 L_x + 2\Phi_D L_x + \frac{c_2}{\kappa_2} (1 - e^{-\kappa_2 L_x}) \right. \\ &+ \frac{1}{\pi} \int_{-\infty}^{\infty} \frac{d_2(q)}{p_2} (1 - e^{-p_2 L_x}) \cos(qL) dq \\ &+ \left. \frac{1}{\pi} \int_{-\infty}^{\infty} \frac{f_2(q)}{p_2} (1 - e^{-p_2 L_x}) dq \right) \\ &+ \frac{L_x L_y \Phi_D}{2} (\sigma_3 + \sigma_4) \end{aligned}$$

$$\begin{aligned}
& + \frac{\varepsilon_1 L_y \Phi_D}{2} \left(-\kappa_1 c_1 L \right. \\
& + \frac{1}{\pi} \int_{-\infty}^{\infty} -p_1 d_1(q) \underbrace{\left[\frac{\sin(qz)}{q} \right]_0^L}_{= \frac{\sin(qL)}{q}} dq \\
& \left. + \frac{1}{\pi} \int_{-\infty}^{\infty} -p_1 f_1(q) \underbrace{\left[\frac{\sin(qz + qL)}{-q} \right]_0^L}_{= \frac{\sin(qL)}{q}} dq \right)
\end{aligned}$$

We are interested in the case of large L_x so we approx. $e^{-aL_x} \approx 0$ for all factors $a \in \mathbb{R}$ not depending on L_x .

$$\begin{aligned}
\mathcal{H} &= \frac{L_y}{2} \sigma_1 \left(a_1 L_z + b_1 e^{-\kappa_1 L} L_x + \frac{c_1}{\kappa_1} + \frac{1}{\pi} \int_{-\infty}^{\infty} \frac{d_1(q)}{p_1} dq + \frac{1}{\pi} \int_{-\infty}^{\infty} \frac{f_1(q)}{p_1} \cos(qL) dq \right) \\
&+ \frac{L_y}{2} \sigma_2 \left(a_1 e^{-\kappa_1 L} L_z + b_1 L_x + \frac{c_1}{\kappa_1} + \frac{1}{\pi} \int_{-\infty}^{\infty} \frac{d_1(q)}{p_1} \cos(qL) dq + \frac{1}{\pi} \int_{-\infty}^{\infty} \frac{f_1(q)}{p_1} dq \right) \\
&+ \frac{L_y}{2} \sigma_3 \left(a_2 L_z + b_2 e^{-\kappa_2 L} L_x + 2\Phi_D L_x + \frac{c_2}{\kappa_2} + \frac{1}{\pi} \int_{-\infty}^{\infty} \frac{d_2(q)}{p_2} dq + \frac{1}{\pi} \int_{-\infty}^{\infty} \frac{f_2(q)}{p_2} \cos(qL) dq \right) \\
&+ \frac{L_y}{2} \sigma_4 \left(a_2 e^{-\kappa_2 L} L_z + b_2 L_x + 2\Phi_D L_x + \frac{c_2}{\kappa_2} + \frac{1}{\pi} \int_{-\infty}^{\infty} \frac{d_2(q)}{p_2} \cos(qL) dq + \frac{1}{\pi} \int_{-\infty}^{\infty} \frac{f_2(q)}{p_2} dq \right) \\
&+ \frac{L_x L_y \Phi_D}{2} (\sigma_3 + \sigma_4) \\
&+ \frac{\varepsilon_1 L_y \Phi_D}{2} \left(-\kappa_1 c_1 L + \frac{1}{\pi} \int_{-\infty}^{\infty} -p_1 d_1(q) \frac{\sin(qL)}{q} dq + \frac{1}{\pi} \int_{-\infty}^{\infty} -p_1 f_1(q) \frac{\sin(qL)}{q} dq \right) \\
&= \left[(a_1 + b_1 e^{-\kappa_1 L}) \frac{\sigma_1}{4} \right] 2L_x L_y \\
&+ \left[(a_1 e^{-\kappa_1 L} + b_1) \frac{\sigma_2}{4} \right] 2L_x L_y \\
&+ \left[(a_2 + b_2 e^{-\kappa_2 L}) \frac{\sigma_3}{4} \right] 2L_x L_y \\
&+ \left[(a_2 e^{-\kappa_2 L} + b_2) \frac{\sigma_4}{4} \right] 2L_x L_y \\
&+ \left[\frac{3}{4} \Phi_D (\sigma_3 + \sigma_4) \right] 2L_x L_y \\
&+ \left[\frac{\sigma_1 c_1}{4\kappa_1} + \frac{1}{4\pi} \int_{-\infty}^{\infty} \sigma_1 \frac{d_1}{p_1} dq + \frac{1}{4\pi} \int_{-\infty}^{\infty} \sigma_1 \frac{f_1}{p_1} \cos(qL) dq \right] 2L_y \\
&+ \left[\frac{\sigma_2 c_1}{4\kappa_1} + \frac{1}{4\pi} \int_{-\infty}^{\infty} \sigma_2 \frac{d_1}{p_1} \cos(qL) dq + \frac{1}{4\pi} \int_{-\infty}^{\infty} \sigma_2 \frac{f_1}{p_1} dq \right] 2L_y \\
&+ \left[\frac{\sigma_3 c_2}{4\kappa_2} + \frac{1}{4\pi} \int_{-\infty}^{\infty} \sigma_3 \frac{d_2}{p_2} dq + \frac{1}{4\pi} \int_{-\infty}^{\infty} \sigma_3 \frac{f_2}{p_2} \cos(qL) dq \right] 2L_y \\
&+ \left[\frac{\sigma_4 c_2}{4\kappa_2} + \frac{1}{4\pi} \int_{-\infty}^{\infty} \sigma_4 \frac{d_2}{p_2} \cos(qL) dq + \frac{1}{4\pi} \int_{-\infty}^{\infty} \sigma_4 \frac{f_2}{p_2} dq \right] 2L_y \\
&+ \left[\left(\frac{1}{\pi} \int_{-\infty}^{\infty} -\frac{p_1 (d_1 + f_1)}{q} \sin(qL) dq \right) \frac{\varepsilon_1 \Phi_D}{4} \right] 2L_y \\
&+ \left[-\frac{\kappa_1 \varepsilon_1 \Phi_D c_1}{2} \right] L_y L
\end{aligned}$$

$$a_1 = \frac{\sigma_1}{\varepsilon_1 \kappa_1}$$

$$b_1 = \frac{\sigma_2}{\varepsilon_1 \kappa_1}$$

$$c_1 = \frac{2\varepsilon_2 \kappa_2 \Phi_D}{\varepsilon_1 \kappa_1 + \varepsilon_2 \kappa_2}$$

$$d_1 = \frac{\varepsilon_2 p_2}{\varepsilon_1 p_1 + \varepsilon_2 p_2} \left(-\frac{\sigma_1}{\varepsilon_1} \frac{1}{p_1^2} + \frac{\sigma_3}{\varepsilon_2} \frac{1}{p_2^2} \right)$$

$$f_1 = \frac{\varepsilon_2 p_2}{\varepsilon_1 p_1 + \varepsilon_2 p_2} \left(-\frac{\sigma_2}{\varepsilon_1} \frac{1}{p_1^2} + \frac{\sigma_4}{\varepsilon_2} \frac{1}{p_2^2} \right)$$

$$\begin{aligned}
a_2 &= \frac{\sigma_3}{\varepsilon_2 \kappa_2} \\
b_2 &= \frac{\sigma_4}{\varepsilon_2 \kappa_2} \\
c_2 &= -\frac{2\varepsilon_1 \kappa_1 \Phi_D}{\varepsilon_1 \kappa_1 + \varepsilon_2 \kappa_2} \\
d_2 &= -\frac{\varepsilon_1 p_1}{\varepsilon_1 p_1 + \varepsilon_2 p_2} \left(-\frac{\sigma_1}{\varepsilon_1} \frac{1}{p_1^2} + \frac{\sigma_3}{\varepsilon_2} \frac{1}{p_2^2} \right) \\
f_2 &= -\frac{\varepsilon_1 p_1}{\varepsilon_1 p_1 + \varepsilon_2 p_2} \left(-\frac{\sigma_2}{\varepsilon_1} \frac{1}{p_1^2} + \frac{\sigma_4}{\varepsilon_2} \frac{1}{p_2^2} \right)
\end{aligned}$$

As explained earlier, we now identify the different terms by their proportionality, σ and L -dependence:

$$\begin{aligned}
\tilde{\gamma}_1 &= \frac{\sigma_1^2}{2\varepsilon_1 \kappa_1} \\
\tilde{\gamma}_2 &= \frac{\sigma_2^2}{2\varepsilon_1 \kappa_1} \\
\tilde{\gamma}_3 &= \frac{\sigma_3^2}{2\varepsilon_2 \kappa_2} + \frac{3}{2} \Phi_D \sigma_3 \\
\tilde{\gamma}_4 &= \frac{\sigma_4^2}{2\varepsilon_2 \kappa_2} + \frac{3}{2} \Phi_D \sigma_4
\end{aligned}$$

$$\begin{aligned}
\tilde{\omega}_{\gamma,1} &= \frac{\sigma_1 \sigma_2}{4\varepsilon_1 \kappa_1} e^{-\kappa_1 L} + \frac{\sigma_1 \sigma_2}{4\varepsilon_1 \kappa_1} e^{-\kappa_1 L} \\
&= \frac{\sigma_1 \sigma_2}{2\varepsilon_1 \kappa_1} e^{-\kappa_1 L} \\
\tilde{\omega}_{\gamma,2} &= \frac{\sigma_3 \sigma_4}{4\varepsilon_2 \kappa_2} e^{-\kappa_2 L} + \frac{\sigma_3 \sigma_4}{4\varepsilon_2 \kappa_2} e^{-\kappa_2 L} \\
&= \frac{\sigma_3 \sigma_4}{2\varepsilon_2 \kappa_2} e^{-\kappa_2 L}
\end{aligned}$$

$$\gamma_{1,2} = -\frac{\kappa_1 \varepsilon_1 \kappa_2 \varepsilon_2 \Phi_D^2}{\kappa_1 \varepsilon_1 + \kappa_2 \varepsilon_2}$$

$$\begin{aligned}
\tilde{\tau}_1 &= \frac{\sigma_1}{2\kappa_1} + \frac{\sigma_3 c_2}{2\kappa_2} + \frac{1}{2\pi} \int_{-\infty}^{\infty} \sigma_1 \frac{d_1}{p_1} dq + \frac{1}{2\pi} \int_{-\infty}^{\infty} \sigma_3 \frac{d_2}{p_2} dq \\
&= \frac{\sigma_1 c_1}{2\kappa_1} \frac{2\varepsilon_2 \kappa_2 \Phi_D}{\varepsilon_1 \kappa_1 + \varepsilon_2 \kappa_2} - \frac{\sigma_3 c_2}{2\kappa_2} \frac{2\varepsilon_1 \kappa_1 \Phi_D}{\varepsilon_1 \kappa_1 + \varepsilon_2 \kappa_2} \\
&\quad + \frac{1}{2\pi} \int_{-\infty}^{\infty} \sigma_1 \frac{1}{p_1} \frac{\varepsilon_2 p_2}{\varepsilon_1 p_1 + \varepsilon_2 p_2} \left(-\frac{\sigma_1}{\varepsilon_1} \frac{1}{p_1^2} + \frac{\sigma_3}{\varepsilon_2} \frac{1}{p_2^2} \right) dq \\
&\quad + \frac{1}{2\pi} \int_{-\infty}^{\infty} -\sigma_3 \frac{1}{p_2} \frac{\varepsilon_1 p_1}{\varepsilon_1 p_1 + \varepsilon_2 p_2} \left(-\frac{\sigma_1}{\varepsilon_1} \frac{1}{p_1^2} + \frac{\sigma_3}{\varepsilon_2} \frac{1}{p_2^2} \right) dq \\
&= \frac{\Phi_D}{\varepsilon_1 \kappa_1 + \varepsilon_2 \kappa_1} \left(\sigma_1 \varepsilon_2 \frac{\kappa_2}{\kappa_1} - \sigma_3 \varepsilon_1 \frac{\kappa_1}{\kappa_2} \right) \\
&\quad + \frac{1}{2\pi} \int_{-\infty}^{\infty} \frac{1}{\varepsilon_1 p_1 + \varepsilon_2 p_2} \left(\frac{2\sigma_1 \sigma_3}{p_1 p_2} - \sigma_1^2 \frac{\varepsilon_2 p_2}{\varepsilon_1 p_1^3} - \sigma_3^2 \frac{\varepsilon_1 p_1}{\varepsilon_2 p_2^3} \right) dq \\
\tilde{\tau}_2 &= \frac{\sigma_2 c_1}{2\kappa_1} + \frac{\sigma_4 c_2}{2\kappa_2} + \frac{1}{2\pi} \int_{-\infty}^{\infty} \sigma_2 \frac{f_1}{p_1} dq + \frac{1}{2\pi} \int_{-\infty}^{\infty} \sigma_4 \frac{f_2}{p_2} dq \\
&= \frac{\sigma_2}{2\kappa_1} \frac{2\varepsilon_2 \kappa_2 \Phi_D}{\varepsilon_1 \kappa_1 + \varepsilon_2 \kappa_2} - \frac{\sigma_4 c_2}{2\kappa_2} \frac{2\varepsilon_1 \kappa_1 \Phi_D}{\varepsilon_1 \kappa_1 + \varepsilon_2 \kappa_2} \\
&\quad + \frac{1}{2\pi} \int_{-\infty}^{\infty} \sigma_2 \frac{1}{p_1} \frac{\varepsilon_2 p_2}{\varepsilon_1 p_1 + \varepsilon_2 p_2} \left(-\frac{\sigma_2}{\varepsilon_1} \frac{1}{p_1^2} + \frac{\sigma_4}{\varepsilon_2} \frac{1}{p_2^2} \right) dq \\
&\quad - \frac{1}{2\pi} \int_{-\infty}^{\infty} \sigma_4 \frac{1}{p_2} \frac{\varepsilon_1 p_1}{\varepsilon_1 p_1 + \varepsilon_2 p_2} \left(-\frac{\sigma_2}{\varepsilon_1} \frac{1}{p_1^2} + \frac{\sigma_4}{\varepsilon_2} \frac{1}{p_2^2} \right) dq
\end{aligned}$$

$$= \frac{\Phi_D}{\varepsilon_1 \kappa_1 + \varepsilon_2 \kappa_1} \left(\sigma_2 \varepsilon_2 \frac{\kappa_2}{\kappa_1} - \sigma_4 \varepsilon_1 \frac{\kappa_1}{\kappa_2} \right) + \frac{1}{2\pi} \int_{-\infty}^{\infty} \frac{1}{\varepsilon_1 p_1 + \varepsilon_2 p_2} \left(\frac{2\sigma_2 \sigma_4}{p_1 p_2} - \sigma_2^2 \frac{\varepsilon_2 p_2}{\varepsilon_1 p_1^3} - \sigma_4^2 \frac{\varepsilon_1 p_1}{\varepsilon_2 p_2^3} \right) dq$$

$$\begin{aligned} \tilde{\omega}_\tau &= \frac{1}{4\pi} \int_{-\infty}^{\infty} \sigma_1 \frac{f_1}{p_1} \cos(qL) dq + \frac{1}{4\pi} \int_{-\infty}^{\infty} \sigma_2 \frac{d_1}{p_1} \cos(qL) dq + \frac{1}{4\pi} \int_{-\infty}^{\infty} \sigma_3 \frac{f_2}{p_2} \cos(qL) dq \\ &+ \frac{1}{4\pi} \int_{-\infty}^{\infty} \sigma_4 \frac{d_2}{p_2} \cos(qL) dq + \left(\frac{1}{\pi} \int_{-\infty}^{\infty} -\frac{p_1(d_1 + f_1)}{q} \sin(qL) dq \right) \frac{\varepsilon_1 \Phi_D}{4} \\ &= \frac{1}{4\pi} \int_{-\infty}^{\infty} \sigma_1 \frac{1}{p_1} \frac{\varepsilon_2 p_2}{\varepsilon_1 p_1 + \varepsilon_2 p_2} \left(-\frac{\sigma_2}{\varepsilon_1} \frac{1}{p_1^2} + \frac{\sigma_4}{\varepsilon_2} \frac{1}{p_2^2} \right) \cos(qL) dq \\ &+ \frac{1}{4\pi} \int_{-\infty}^{\infty} \sigma_2 \frac{1}{p_1} \frac{\varepsilon_2 p_2}{\varepsilon_1 p_1 + \varepsilon_2 p_2} \left(-\frac{\sigma_1}{\varepsilon_1} \frac{1}{p_1^2} + \frac{\sigma_3}{\varepsilon_2} \frac{1}{p_2^2} \right) \cos(qL) dq \\ &+ \frac{1}{4\pi} \int_{-\infty}^{\infty} -\sigma_3 \frac{1}{p_2} \frac{\varepsilon_1 p_1}{\varepsilon_1 p_1 + \varepsilon_2 p_2} \left(-\frac{\sigma_2}{\varepsilon_1} \frac{1}{p_1^2} + \frac{\sigma_4}{\varepsilon_2} \frac{1}{p_2^2} \right) \cos(qL) dq \\ &+ \frac{1}{4\pi} \int_{-\infty}^{\infty} -\sigma_4 \frac{1}{p_2} \frac{\varepsilon_1 p_1}{\varepsilon_1 p_1 + \varepsilon_2 p_2} \left(-\frac{\sigma_1}{\varepsilon_1} \frac{1}{p_1^2} + \frac{\sigma_3}{\varepsilon_2} \frac{1}{p_2^2} \right) \cos(qL) dq \\ &+ \left(\frac{1}{\pi} \int_{-\infty}^{\infty} -p_1 \left(\frac{\varepsilon_2 p_2}{\varepsilon_1 p_1 + \varepsilon_2 p_2} \left(-\frac{\sigma_1}{\varepsilon_1} \frac{1}{p_1^2} + \frac{\sigma_3}{\varepsilon_2} \frac{1}{p_2^2} \right) \right. \right. \\ &\left. \left. + \frac{\varepsilon_2 p_2}{\varepsilon_1 p_1 + \varepsilon_2 p_2} \left(-\frac{\sigma_2}{\varepsilon_1} \frac{1}{p_1^2} + \frac{\sigma_4}{\varepsilon_2} \frac{1}{p_2^2} \right) \right) \frac{\sin(qL)}{q} dq \right) \frac{\varepsilon_1 \Phi_D}{4} \\ &= \frac{1}{2\pi} \int_{-\infty}^{\infty} \frac{1}{\varepsilon_1 p_1 + \varepsilon_2 p_2} \left(\frac{\sigma_2 \sigma_3 + \sigma_1 \sigma_4}{p_1 p_2} - \sigma_1 \sigma_2 \frac{\varepsilon_2 p_2}{\varepsilon_1 p_1^3} - \sigma_3 \sigma_4 \frac{\varepsilon_1 p_1}{\varepsilon_2 p_2^3} \right) \cos(qL) dq \\ &- \frac{\Phi_D}{4\pi} \int_{-\infty}^{\infty} \frac{\varepsilon_1 \varepsilon_2 p_1 p_2}{\varepsilon_1 p_1 + \varepsilon_2 p_2} \left(-\frac{\sigma_1 + \sigma_2}{\varepsilon_1} \frac{1}{p_1^2} + \frac{\sigma_3 + \sigma_4}{\varepsilon_2} \frac{1}{p_2^2} \right) \frac{\sin(qL)}{q} dq \end{aligned}$$

We then proceed to calculate the limits of the L -dependent terms so we can obtain our final quantities

$$\lim_{L \rightarrow \infty} \tilde{\omega}_{\gamma,i} = 0$$

with this limit and the expression calculated above we can use Eq. (IV.3) to obtain

$$\gamma_1 = \tilde{\gamma}_1 = \frac{\sigma_1^2}{2\varepsilon_1 \kappa_1} \quad \gamma_2 = \tilde{\gamma}_2 = \frac{\sigma_2^2}{2\varepsilon_1 \kappa_1} \quad \gamma_3 = \tilde{\gamma}_3 = \frac{\sigma_3^2}{2\varepsilon_2 \kappa_2} + \frac{3}{2} \Phi_D \sigma_3 \quad \gamma_4 = \tilde{\gamma}_4 = \frac{\sigma_4^2}{2\varepsilon_2 \kappa_2} + \frac{3}{2} \Phi_D \sigma_4$$

$$\omega_{\gamma,1} = \frac{\sigma_1 \sigma_2}{2\varepsilon_1 \kappa_1} e^{-\kappa_1 L} \quad \omega_{\gamma,2} = \frac{\sigma_3 \sigma_4}{2\varepsilon_2 \kappa_2} e^{-\kappa_2 L}$$

$$\lim_{L \rightarrow \infty} \tilde{\omega}_\tau = -\frac{\varepsilon_1 \varepsilon_2 \kappa_1 \kappa_2 \Phi_D}{4(\varepsilon_1 \kappa_1 + \varepsilon_2 \kappa_3)} \left(-\frac{\sigma_1 + \sigma_2}{\varepsilon_1} \frac{1}{\kappa_1^2} + \frac{\sigma_3 + \sigma_4}{\varepsilon_2} \frac{1}{\kappa_2^2} \right)$$

with this limit and the expression calculated above we can use Eq. (IV.3) to obtain

$$\begin{aligned} \tau_1 &= \frac{\Phi_D}{\varepsilon_1 \kappa_1 + \varepsilon_2 \kappa_1} \left(\sigma_1 \varepsilon_2 \frac{\kappa_2}{\kappa_1} - \sigma_3 \varepsilon_1 \frac{\kappa_1}{\kappa_2} \right) \\ &+ \frac{1}{2\pi} \int_{-\infty}^{\infty} \frac{1}{\varepsilon_1 p_1 + \varepsilon_2 p_2} \left(\frac{2\sigma_1 \sigma_3}{p_1 p_2} - \sigma_1^2 \frac{\varepsilon_2 p_2}{\varepsilon_1 p_1^3} - \sigma_3^2 \frac{\varepsilon_1 p_1}{\varepsilon_2 p_2^3} \right) dq \\ &- \frac{\varepsilon_1 \varepsilon_2 \kappa_1 \kappa_2 \Phi_D}{2(\varepsilon_1 \kappa_1 + \varepsilon_2 \kappa_3)} \left(-\frac{\sigma_1}{\varepsilon_1} \frac{1}{\kappa_1^2} + \frac{\sigma_3}{\varepsilon_2} \frac{1}{\kappa_2^2} \right) \\ &= \frac{3}{2} \frac{\Phi_D}{\varepsilon_1 \kappa_1 + \varepsilon_2 \kappa_1} \left(\sigma_1 \varepsilon_2 \frac{\kappa_2}{\kappa_1} - \sigma_3 \varepsilon_1 \frac{\kappa_1}{\kappa_2} \right) \\ &+ \frac{1}{2\pi} \int_{-\infty}^{\infty} \frac{1}{\varepsilon_1 p_1 + \varepsilon_2 p_2} \left(\frac{2\sigma_1 \sigma_3}{p_1 p_2} - \sigma_1^2 \frac{\varepsilon_2 p_2}{\varepsilon_1 p_1^3} - \sigma_3^2 \frac{\varepsilon_1 p_1}{\varepsilon_2 p_2^3} \right) dq \\ \tau_2 &= \frac{\Phi_D}{\varepsilon_1 \kappa_1 + \varepsilon_2 \kappa_1} \left(\sigma_2 \varepsilon_2 \frac{\kappa_2}{\kappa_1} - \sigma_4 \varepsilon_1 \frac{\kappa_1}{\kappa_2} \right) \end{aligned}$$

$$\begin{aligned}
& + \frac{1}{2\pi} \int_{-\infty}^{\infty} \frac{1}{\varepsilon_1 p_1 + \varepsilon_2 p_2} \left(\frac{2\sigma_2 \sigma_4}{p_1 p_2} - \sigma_2^2 \frac{\varepsilon_2 p_2}{\varepsilon_1 p_1^3} - \sigma_4^2 \frac{\varepsilon_1 p_1}{\varepsilon_2 p_2^3} \right) dq \\
& - \frac{\varepsilon_1 \varepsilon_2 \kappa_1 \kappa_2 \Phi_D}{2(\varepsilon_1 \kappa_1 + \varepsilon_2 \kappa_3)} \left(-\frac{\sigma_2}{\varepsilon_1} \frac{1}{\kappa_1^2} + \frac{\sigma_4}{\varepsilon_2} \frac{1}{\kappa_2^2} \right) \\
& = \frac{3}{2} \frac{\Phi_D}{\varepsilon_1 \kappa_1 + \varepsilon_2 \kappa_1} \left(\sigma_2 \varepsilon_2 \frac{\kappa_2}{\kappa_1} - \sigma_4 \varepsilon_1 \frac{\kappa_1}{\kappa_2} \right) \\
& + \frac{1}{2\pi} \int_{-\infty}^{\infty} \frac{1}{\varepsilon_1 p_1 + \varepsilon_2 p_2} \left(\frac{2\sigma_2 \sigma_4}{p_1 p_2} - \sigma_2^2 \frac{\varepsilon_2 p_2}{\varepsilon_1 p_1^3} - \sigma_4^2 \frac{\varepsilon_1 p_1}{\varepsilon_2 p_2^3} \right) dq \\
\omega_\tau & = \frac{\varepsilon_1 \varepsilon_2 \kappa_1 \kappa_2 \Phi_D}{4(\varepsilon_1 \kappa_1 + \varepsilon_2 \kappa_3)} \left(-\frac{\sigma_1 + \sigma_2}{\varepsilon_1} \frac{1}{\kappa_1^2} + \frac{\sigma_3 + \sigma_4}{\varepsilon_2} \frac{1}{\kappa_2^2} \right) \\
& + \frac{1}{2\pi} \int_{-\infty}^{\infty} \frac{1}{\varepsilon_1 p_1 + \varepsilon_2 p_2} \left(\frac{\sigma_2 \sigma_3 + \sigma_1 \sigma_4}{p_1 p_2} - \sigma_1 \sigma_2 \frac{\varepsilon_2 p_2}{\varepsilon_1 p_1^3} - \sigma_3 \sigma_4 \frac{\varepsilon_1 p_1}{\varepsilon_2 p_2^3} \right) \cos(qL) dq \\
& - \frac{\Phi_D}{4\pi} \int_{-\infty}^{\infty} \frac{\varepsilon_1 \varepsilon_2 p_1 p_2}{\varepsilon_1 p_1 + \varepsilon_2 p_3} \left(-\frac{\sigma_1 + \sigma_2}{\varepsilon_1} \frac{1}{p_1^2} + \frac{\sigma_3 + \sigma_4}{\varepsilon_2} \frac{1}{p_2^2} \right) \frac{\sin(qL)}{q} dq \tag{IV.6}
\end{aligned}$$

14.1 Consistency with literature

We test our expression for consistency with with the result of Ref. [20]. For this we have to set

$$L = 2L'$$

$$\sigma'_1 = \sigma_1 = \sigma_2$$

$$\sigma'_2 = \sigma_3 = \sigma_4$$

since in Ref. [20] the walls are located at $z = \pm L$ and the system therefore has a length of $2L$.

Surface interaction energy

$$\omega_{\gamma,1} = \frac{\sigma_1 \sigma_2}{2\varepsilon_1 \kappa_1} e^{-\kappa_1 L} = \frac{\sigma_1'^2}{2\varepsilon_1 \kappa_1} e^{-2\kappa_1 L'}$$

we compare with the expression from [1]

$$\begin{aligned}
\omega_{\gamma,1} & = \frac{\sigma_1'^2}{2\kappa_1 \varepsilon_1} \left(2e^{-\kappa_1 L'} \cosh(\kappa_1 L') - 1 \right) \\
& = \frac{\sigma_1'^2}{2\kappa_1 \varepsilon_1} (1 + e^{-2\kappa_1 L} - 1) \\
& = \frac{\sigma_1'^2}{2\kappa_1 \varepsilon_1} e^{-2\kappa_1 L} \quad \checkmark
\end{aligned}$$

Line interaction energy

$$\begin{aligned}
\omega_\tau & = \frac{\varepsilon_1 \varepsilon_2 \kappa_1 \kappa_2 \Phi_D}{2(\varepsilon_1 \kappa_1 + \varepsilon_2 \kappa_3)} \left(-\frac{\sigma'_1}{\varepsilon_1} \frac{1}{\kappa_1^2} + \frac{\sigma'_2}{\varepsilon_2} \frac{1}{\kappa_2^2} \right) \\
& + \frac{1}{2\pi} \int_{-\infty}^{\infty} \frac{1}{\varepsilon_1 p_1 + \varepsilon_2 p_2} \left(\frac{2\sigma'_1 \sigma'_2}{p_1 p_2} - \sigma_1'^2 \frac{\varepsilon_2 p_2}{\varepsilon_1 p_1^3} - \sigma_2'^2 \frac{\varepsilon_1 p_1}{\varepsilon_2 p_2^3} \right) \cos(2qL') dq \\
& - \frac{\Phi_D}{2\pi} \int_{-\infty}^{\infty} \frac{\varepsilon_1 \varepsilon_2 p_1 p_2}{\varepsilon_1 p_1 + \varepsilon_2 p_3} \left(-\frac{\sigma'_1}{\varepsilon_1} \frac{1}{p_1^2} + \frac{\sigma'_2}{\varepsilon_2} \frac{1}{p_2^2} \right) \frac{\sin(2qL')}{q} dq
\end{aligned}$$

we compare with the expression from [20]

$$\begin{aligned}
\omega_\tau & = \frac{\sigma_1'^2}{\kappa_1^2 \varepsilon_1} \left[\frac{\kappa_2}{\kappa_1} \left(1 + \frac{\varepsilon_2 \kappa_2}{\varepsilon_1 \kappa_1} \right) \left(\frac{\sigma_2' \kappa_1^2}{\sigma_1' \kappa_2^2} - \frac{\varepsilon_2}{\varepsilon_1} \right) \frac{\Phi_D \kappa_1 \varepsilon_1}{2\sigma_1'} \right. \\
& \left. - \frac{1}{\pi} \frac{\Phi_D \kappa_1 \varepsilon_1}{\sigma_1'} \int_0^\infty dq \frac{\sqrt{q^2 + 1} \sqrt{q^2 + \frac{\kappa_2^2}{\kappa_1^2}}}{\sqrt{q^2 + 1} + \frac{\varepsilon_2}{\varepsilon_1} \sqrt{q^2 + \frac{\kappa_2^2}{\kappa_1^2}}} \left(\frac{\sigma_2'}{\sigma_1'} - \frac{\varepsilon_2}{\varepsilon_1} \right) \frac{\sin(2q\kappa_1 L')}{q} \right]
\end{aligned}$$

$$\begin{aligned}
& + \frac{1}{\pi} \int_0^\infty dq \frac{\sqrt{q^2 + \frac{\kappa_2^2}{\kappa_1^2}}}{\sqrt{q^2 + 1} + \frac{\varepsilon_2}{\varepsilon_1} \sqrt{q^2 + \frac{\kappa_2^2}{\kappa_1^2}}} \left(\frac{\sigma_2'}{\sigma_1'} - \frac{\varepsilon_2}{\varepsilon_1} \right) \frac{\cos(2q\kappa_1 L')}{\sqrt{q^2 + 1}} \\
& - \frac{1}{\pi} \int_0^\infty dq \frac{\sqrt{q^2 + 1}}{\sqrt{q^2 + 1} + \frac{\varepsilon_2}{\varepsilon_1} \sqrt{q^2 + \frac{\kappa_2^2}{\kappa_1^2}}} \left(\frac{\sigma_2'}{\sigma_1'} - \frac{\varepsilon_2}{\varepsilon_1} \right) \frac{\sigma_2' \varepsilon_1 \cos(2q\kappa_1 L')}{\sigma_1' \varepsilon_2 \sqrt{q^2 + \frac{\kappa_2^2}{\kappa_1^2}}} \Big] \\
& = \frac{\sigma_1'^2}{\kappa_1^2 \varepsilon_1} \left[\frac{\Phi_D}{2(\varepsilon_1 \kappa_1 + \varepsilon_2 \kappa_2)} \left(\frac{\sigma_2' \kappa_1}{\sigma_1' \kappa_2} - \frac{\varepsilon_2 \kappa_2}{\varepsilon_1 \kappa_1} \right) \frac{\kappa_1^2 \varepsilon_1^2}{\sigma_1'} \right. \\
& - \frac{1}{\kappa_1} \frac{1}{\pi} \frac{\Phi_D \kappa_1 \varepsilon_1}{\sigma_1'} \int_0^\infty dq \frac{\sqrt{\frac{q^2}{\kappa_1^2} + 1} \sqrt{\frac{q^2}{\kappa_1^2} + \frac{\kappa_2^2}{\kappa_1^2}}}{\sqrt{\frac{q^2}{\kappa_1^2} + 1} + \frac{\varepsilon_2}{\varepsilon_1} \sqrt{\frac{q^2}{\kappa_1^2} + \frac{\kappa_2^2}{\kappa_1^2}}} \left(\frac{\sigma_2'}{\sigma_1'} - \frac{\varepsilon_2}{\varepsilon_1} \right) \frac{\sin(2qL')}{\frac{q}{\kappa_1}} \\
& + \frac{1}{\kappa_1} \frac{1}{\pi} \int_0^\infty dq \frac{\sqrt{\frac{q^2}{\kappa_1^2} + \frac{\kappa_2^2}{\kappa_1^2}}}{\sqrt{\frac{q^2}{\kappa_1^2} + 1} + \frac{\varepsilon_2}{\varepsilon_1} \sqrt{\frac{q^2}{\kappa_1^2} + \frac{\kappa_2^2}{\kappa_1^2}}} \left(\frac{\sigma_2'}{\sigma_1'} - \frac{\varepsilon_2}{\varepsilon_1} \right) \frac{\cos(2qL')}{\sqrt{\frac{q^2}{\kappa_1^2} + 1}} \\
& - \left. \frac{1}{\kappa_1} \frac{1}{\pi} \int_0^\infty dq \frac{\sqrt{\frac{q^2}{\kappa_1^2} + 1}}{\sqrt{\frac{q^2}{\kappa_1^2} + 1} + \frac{\varepsilon_2}{\varepsilon_1} \sqrt{\frac{q^2}{\kappa_1^2} + \frac{\kappa_2^2}{\kappa_1^2}}} \left(\frac{\sigma_2'}{\sigma_1'} - \frac{\varepsilon_2}{\varepsilon_1} \right) \frac{\sigma_2' \varepsilon_1 \cos(2qL')}{\sigma_1' \varepsilon_2 \sqrt{\frac{q^2}{\kappa_1^2} + \frac{\kappa_2^2}{\kappa_1^2}}} \right] \\
& = \frac{\Phi_D}{2(\varepsilon_1 \kappa_1 + \varepsilon_2 \kappa_2)} \left(\frac{\sigma_2' \kappa_1 \varepsilon_1}{\kappa_2} - \frac{\sigma_1' \varepsilon_2 \kappa_2}{\kappa_1} \right) \\
& - \frac{1}{\pi} \frac{\sigma_1'^2}{\varepsilon_1} \frac{\Phi_D \varepsilon_1}{\sigma_1'} \int_0^\infty dq \frac{p_1 p_2}{p_1 + \frac{\varepsilon_2}{\varepsilon_1} p_2} \left(\frac{\sigma_2'}{\sigma_1'} - \frac{\varepsilon_2}{\varepsilon_1} \right) \frac{\sin(2qL')}{q} \\
& + \frac{\sigma_1'^2}{\varepsilon_1} \frac{1}{\pi} \int_0^\infty dq \frac{p_2}{p_1 + \frac{\varepsilon_2}{\varepsilon_1} p_2} \left(\frac{\sigma_2'}{\sigma_1'} - \frac{\varepsilon_2}{\varepsilon_1} \right) \frac{\cos(2qL')}{p_1} \\
& - \frac{\sigma_1'^2}{\varepsilon_1} \frac{1}{\pi} \int_0^\infty dq \frac{p_1}{p_1 + \frac{\varepsilon_2}{\varepsilon_1} p_2} \left(\frac{\sigma_2'}{\sigma_1'} - \frac{\varepsilon_2}{\varepsilon_1} \right) \frac{\sigma_2' \varepsilon_1 \cos(2qL')}{\sigma_1' \varepsilon_2 p_2} \\
& = \frac{\Phi_D \varepsilon_1 \varepsilon_2 \kappa_1 \kappa_2}{2(\varepsilon_1 \kappa_1 + \varepsilon_2 \kappa_2)} \left(\frac{\sigma_2'}{\varepsilon_2} \frac{1}{\kappa_2^2} - \frac{\sigma_1'}{\varepsilon_1} \frac{1}{\kappa_1^2} \right) \\
& - \frac{\Phi_D}{\pi} \int_0^\infty dq \frac{p_1 p_2}{p_1 + \frac{\varepsilon_2}{\varepsilon_1} p_2} \left(\frac{\sigma_2'}{p_2^2} - \frac{\sigma_1' \varepsilon_2}{p_1^2} \right) \frac{\sin(2qL')}{q} \\
& + \frac{1}{\pi} \int_0^\infty dq \frac{p_2}{\varepsilon_1 p_1 + \varepsilon_2 p_2} \left(\frac{\sigma_1' \sigma_2'}{p_2^2} - \frac{\varepsilon_2 \sigma_1'^2}{p_1^2} \right) \frac{\cos(2qL')}{p_1} \\
& - \frac{1}{\pi} \int_0^\infty dq \frac{p_1}{\varepsilon_1 p_1 + \varepsilon_2 p_2} \left(\frac{\sigma_1' \sigma_2'}{p_2^2} - \frac{\varepsilon_2 \sigma_1'^2}{p_1^2} \right) \frac{\sigma_2' \varepsilon_1 \cos(2qL')}{\sigma_1' \varepsilon_2 p_2} \\
& = \frac{\Phi_D \varepsilon_1 \varepsilon_2 \kappa_1 \kappa_2}{2(\varepsilon_1 \kappa_1 + \varepsilon_2 \kappa_2)} \left(\frac{\sigma_2'}{\varepsilon_2} \frac{1}{\kappa_2^2} - \frac{\sigma_1'}{\varepsilon_1} \frac{1}{\kappa_1^2} \right) \\
& - \frac{\Phi_D}{\pi} \int_0^\infty dq \frac{p_1 p_2}{\varepsilon_1 p_1 + \varepsilon_2 p_2} \left(\frac{\sigma_2'}{\varepsilon_2} \frac{1}{p_2^2} - \frac{\sigma_1'}{\varepsilon_1} \frac{1}{p_1^2} \right) \frac{\sin(2qL')}{q} \\
& + \frac{1}{\pi} \int_0^\infty dq \frac{1}{\varepsilon_1 p_1 + \varepsilon_2 p_2} \left(\frac{\sigma_1' \sigma_2'}{p_1 p_2} - \frac{\varepsilon_2 p_2}{\varepsilon_1 p_1^3} \right) \cos(2qL') \\
& - \frac{1}{\pi} \int_0^\infty dq \frac{1}{\varepsilon_1 p_1 + \varepsilon_2 p_2} \left(\sigma_2'^2 \frac{\varepsilon_1 p_1}{\varepsilon_2 p_2^3} - \frac{\sigma_1' \sigma_2'}{p_1 p_2} \right) \cos(2qL') \\
& = \frac{\varepsilon_1 \varepsilon_2 \kappa_1 \kappa_2 \Phi_D}{2(\varepsilon_1 \kappa_1 + \varepsilon_2 \kappa_2)} \left(-\frac{\sigma_1'}{\varepsilon_1} \frac{1}{\kappa_1^2} + \frac{\sigma_2'}{\varepsilon_2} \frac{1}{\kappa_2^2} \right) \\
& + \frac{1}{2\pi} \int_{-\infty}^\infty \frac{1}{\varepsilon_1 p_1 + \varepsilon_2 p_2} \left(\frac{2\sigma_1' \sigma_2'}{p_1 p_2} - \sigma_1'^2 \frac{\varepsilon_2 p_2}{\varepsilon_1 p_1^3} - \sigma_2'^2 \frac{\varepsilon_1 p_1}{\varepsilon_2 p_2^3} \right) \cos(2qL') dq \\
& - \frac{\Phi_D}{2\pi} \int_{-\infty}^\infty \frac{\varepsilon_1 \varepsilon_2 p_1 p_2}{\varepsilon_1 p_1 + \varepsilon_2 p_2} \left(-\frac{\sigma_1'}{\varepsilon_1} \frac{1}{p_1^2} + \frac{\sigma_2'}{\varepsilon_2} \frac{1}{p_2^2} \right) \frac{\sin(2qL')}{q} dq \quad \checkmark
\end{aligned}$$

Conclusion Therefore we can obtain the result for the case of identical particles given in Ref. [20, 21] from our general expressions.

15 Solution Summary

15.1 Exact Solution

15.1.1 Potential

$$\begin{aligned}
\Phi_1^e(x, z) &= \frac{\sigma_1 \cosh(\kappa_1(L-z)) + \sigma_2 \cosh(\kappa_1 z)}{\varepsilon_1 \kappa_1 \sinh(\kappa_1 L)} \\
&\quad + \frac{\kappa_2 \varepsilon_2 \Phi_D}{\kappa_1 \varepsilon_1 + \kappa_2 \varepsilon_2} e^{-\kappa_1 x} \\
&\quad + \frac{1}{L} \frac{1}{\kappa_1 \varepsilon_1 + \kappa_2 \varepsilon_2} \left(\frac{\sigma_3 + \sigma_4}{\kappa_2} - \frac{1}{\kappa_1} \frac{\kappa_2 \varepsilon_2}{\kappa_1 \varepsilon_1} (\sigma_1 + \sigma_2) \right) e^{-\kappa_1 x} \\
&\quad + \sum_{n=1}^{\infty} \frac{2}{L} \frac{\varepsilon_2 p_2}{\varepsilon_1 p_1 + \varepsilon_2 p_2} \left(\frac{\sigma_3 + (-1)^n \sigma_4}{\varepsilon_2} \frac{1}{p_2^2} - \frac{\sigma_1 + (-1)^n \sigma_2}{\varepsilon_1} \frac{1}{p_1^2} \right) e^{-p_1 x} \cos\left(\frac{n\pi z}{L}\right) \\
\Phi_2^e(x, z) &= \frac{\sigma_3 \cosh(\kappa_2(L-z)) + \sigma_4 \cosh(\kappa_2 z)}{\varepsilon_2 \kappa_2 \sinh(\kappa_2 L)} \\
&\quad + \Phi_D - \frac{\kappa_1 \varepsilon_1 \Phi_D}{\kappa_1 \varepsilon_1 + \kappa_2 \varepsilon_2} e^{\kappa_2 x} \\
&\quad + \frac{1}{L} \frac{1}{\kappa_1 \varepsilon_1 + \kappa_2 \varepsilon_2} \left(\frac{\sigma_1 + \sigma_2}{\kappa_1} - \frac{1}{\kappa_2} \frac{\kappa_1 \varepsilon_1}{\kappa_2 \varepsilon_2} (\sigma_3 + \sigma_4) \right) e^{\kappa_2 x} \\
&\quad + \sum_{n=1}^{\infty} \frac{2}{L} \frac{\varepsilon_1 p_1}{\varepsilon_1 p_1 + \varepsilon_2 p_2} \left(\frac{\sigma_1 + (-1)^n \sigma_2}{\varepsilon_1} \frac{1}{p_1^2} - \frac{\sigma_3 + (-1)^n \sigma_4}{\varepsilon_2} \frac{1}{p_2^2} \right) e^{p_2 x} \cos\left(\frac{n\pi z}{L}\right)
\end{aligned}$$

15.1.2 Energy

$$\begin{aligned}
\gamma_1 &= \frac{\sigma_1^2}{2\kappa_1 \varepsilon_1} & \gamma_2 &= \frac{\sigma_2^2}{2\kappa_1 \varepsilon_1} \\
\gamma_3 &= \frac{\sigma_3^2}{2\kappa_2 \varepsilon_2} + \sigma_3 \Phi_D & \gamma_4 &= \frac{\sigma_4^2}{2\kappa_2 \varepsilon_2} + \sigma_4 \Phi_D \\
\omega_{\gamma,1}(L) &= \frac{1}{4\kappa_1 \varepsilon_1} \left((\sigma_1^2 + \sigma_2^2)(\coth(\kappa_1 L) - 1) + \frac{2\sigma_1 \sigma_2}{\sinh(\kappa_1 L)} \right) \\
\omega_{\gamma,2}(L) &= \frac{1}{4\kappa_2 \varepsilon_2} \left((\sigma_3^2 + \sigma_4^2)(\coth(\kappa_2 L) - 1) + \frac{2\sigma_3 \sigma_4}{\sinh(\kappa_2 L)} \right) \\
\gamma_{1,2} &= -\frac{\varepsilon_1 \varepsilon_2 \kappa_1 \kappa_2 \Phi_D^2}{2(\kappa_1 \varepsilon_1 + \kappa_2 \varepsilon_2)} \\
\tau_1 &= \frac{\Phi_D}{\kappa_1 \varepsilon_1 + \kappa_2 \varepsilon_2} \left(\frac{\varepsilon_2 \kappa_2}{\kappa_1} \sigma_1 - \frac{\varepsilon_1 \kappa_1}{\kappa_2} \sigma_3 \right) \\
&\quad + \int_0^{\infty} \frac{1}{\varepsilon_1 p_1(x) + \varepsilon_2 p_2(x)} \left(\frac{2\sigma_1 \sigma_3}{p_1(x) p_2(x)} - \frac{\varepsilon_2 p_2(x)}{\varepsilon_1 p_1(x)^3} \sigma_1^2 - \frac{\varepsilon_1 p_1(x)}{\varepsilon_2 p_2(x)^3} \sigma_3^2 \right) dx \\
\tau_2 &= \frac{\Phi_D}{\kappa_1 \varepsilon_1 + \kappa_2 \varepsilon_2} \left(\frac{\varepsilon_2 \kappa_2}{\kappa_1} \sigma_2 - \frac{\varepsilon_1 \kappa_1}{\kappa_2} \sigma_4 \right) \\
&\quad + \int_0^{\infty} \frac{1}{\varepsilon_1 p_1(x) + \varepsilon_2 p_2(x)} \left(\frac{2\sigma_2 \sigma_4}{p_1(x) p_2(x)} - \frac{\varepsilon_2 p_2(x)}{\varepsilon_1 p_1(x)^3} \sigma_2^2 - \frac{\varepsilon_1 p_1(x)}{\varepsilon_2 p_2(x)^3} \sigma_4^2 \right) dx \\
\omega_{\tau}(L) &= \frac{1}{L} \frac{1}{\kappa_1 \varepsilon_1 + \kappa_2 \varepsilon_2} \left(\frac{(\sigma_1 + \sigma_2)(\sigma_3 + \sigma_4)}{2\kappa_1 \kappa_2} - \frac{1}{4\kappa_1^2} \frac{\kappa_2 \varepsilon_2}{\kappa_1 \varepsilon_1} (\sigma_1 + \sigma_2)^2 - \frac{1}{4\kappa_2^2} \frac{\kappa_1 \varepsilon_1}{\kappa_2 \varepsilon_2} (\sigma_3 + \sigma_4)^2 \right) \\
&\quad + \frac{1}{2L} \sum_{n=1}^{\infty} \frac{1}{\varepsilon_1 p_1 + \varepsilon_2 p_2} \left(\frac{2(\sigma_1 + (-1)^n \sigma_2)(\sigma_3 + (-1)^n \sigma_4)}{p_1 p_2} - \frac{1}{p_1} \frac{\varepsilon_2 p_2}{\varepsilon_1 p_1^2} (\sigma_1 + (-1)^n \sigma_2)^2 - \frac{1}{p_2} \frac{\varepsilon_1 p_1}{\varepsilon_2 p_2^2} (\sigma_3 + (-1)^n \sigma_4)^2 \right) \\
&\quad - \frac{1}{2} \int_0^{\infty} \frac{1}{\varepsilon_1 p_1(x) + \varepsilon_2 p_2(x)} \left(\frac{2(\sigma_1 \sigma_3 + \sigma_2 \sigma_4)}{p_1(x) p_2(x)} - \frac{\varepsilon_2 p_2(x)}{\varepsilon_1 p_1(x)^3} (\sigma_1^2 + \sigma_2^2) - \frac{\varepsilon_1 p_1(x)}{\varepsilon_2 p_2(x)^3} (\sigma_3^2 + \sigma_4^2) \right) dx
\end{aligned}$$

15.1.3 Notation

$$\begin{aligned}
p_i &= \sqrt{\left(\frac{n\pi}{L}\right)^2 + \kappa_i^2} \\
p_i(x) &= \sqrt{x^2 \pi^2 + \kappa_i^2}
\end{aligned}$$

15.2 Superposition Solution

15.2.1 Potential

$$\begin{aligned}
\Phi_1^s(x, z) &= \frac{\sigma_1}{\varepsilon_1 \kappa_1} e^{-\kappa_1 z} + \frac{\sigma_2}{\varepsilon_1 \kappa_1} e^{\kappa_1(z-L)} \\
&\quad + \frac{2\kappa_2 \varepsilon_2 \Phi_D}{\kappa_1 \varepsilon_1 + \kappa_2 \varepsilon_2} e^{-\kappa_1 x} \\
&\quad + \frac{1}{\pi} \int_{-\infty}^{\infty} \frac{\varepsilon_2 p_2}{\varepsilon_1 p_1 + \varepsilon_2 p_2} \left(-\frac{\sigma_1}{\varepsilon_1} \frac{1}{p_1^2} + \frac{\sigma_3}{\varepsilon_2} \frac{1}{p_2^2} \right) e^{-p_1 x} \cos(qz) \, dq \\
&\quad + \frac{1}{\pi} \int_{-\infty}^{\infty} \frac{\varepsilon_2 p_2}{\varepsilon_1 p_1 + \varepsilon_2 p_2} \left(-\frac{\sigma_2}{\varepsilon_1} \frac{1}{p_1^2} + \frac{\sigma_4}{\varepsilon_2} \frac{1}{p_2^2} \right) e^{-p_1 x} \cos(-q(z-L)) \, dq \\
\Phi_2^s(x, z) &= \frac{\sigma_3}{\varepsilon_2 \kappa_2} e^{-\kappa_2 z} + \frac{\sigma_4}{\varepsilon_2 \kappa_2} e^{\kappa_2(z-L)} \\
&\quad + 2\Phi_D - 2 \frac{\kappa_1 \varepsilon_1 \Phi_D}{\kappa_1 \varepsilon_1 + \kappa_2 \varepsilon_2} e^{\kappa_2 x} \\
&\quad + \frac{1}{\pi} \int_{-\infty}^{\infty} -\frac{\varepsilon_1 p_1}{\varepsilon_1 p_1 + \varepsilon_2 p_2} \left(-\frac{\sigma_1}{\varepsilon_1} \frac{1}{p_1^2} + \frac{\sigma_3}{\varepsilon_2} \frac{1}{p_2^2} \right) e^{p_2 x} \cos(qz) \, dq \\
&\quad + \frac{1}{\pi} \int_{-\infty}^{\infty} -\frac{\varepsilon_1 p_1}{\varepsilon_1 p_1 + \varepsilon_2 p_2} \left(-\frac{\sigma_2}{\varepsilon_1} \frac{1}{p_1^2} + \frac{\sigma_4}{\varepsilon_2} \frac{1}{p_2^2} \right) e^{p_2 x} \cos(-q(z-L)) \, dq
\end{aligned}$$

15.2.2 Energy

$$\begin{aligned}
\gamma_1 &= \frac{\sigma_1^2}{2\varepsilon_1 \kappa_1} & \gamma_2 &= \frac{\sigma_2^2}{2\varepsilon_1 \kappa_1} \\
\gamma_3 &= \frac{\sigma_3^2}{2\varepsilon_2 \kappa_2} + \frac{3}{2} \Phi_D \sigma_3 & \gamma_4 &= \frac{\sigma_4^2}{2\varepsilon_2 \kappa_2} + \frac{3}{2} \Phi_D \sigma_4 \\
\omega_{\gamma,1}(L) &= \frac{\sigma_1 \sigma_2}{2\varepsilon_1 \kappa_1} e^{-\kappa_1 L} \\
\omega_{\gamma,2}(L) &= \frac{\sigma_3 \sigma_4}{2\varepsilon_2 \kappa_2} e^{-\kappa_2 L} \\
\gamma_{1,2} &= -\frac{\varepsilon_1 \varepsilon_2 \kappa_1 \kappa_2 \Phi_D^2}{\varepsilon_1 \kappa_1 + \varepsilon_2 \kappa_2} \\
\tau_1 &= \frac{3}{2} \frac{\Phi_D}{\varepsilon_1 \kappa_1 + \varepsilon_2 \kappa_1} \left(\sigma_1 \varepsilon_2 \frac{\kappa_2}{\kappa_1} - \sigma_3 \varepsilon_1 \frac{\kappa_1}{\kappa_2} \right) \\
&\quad + \frac{1}{2\pi} \int_{-\infty}^{\infty} \frac{1}{\varepsilon_1 p_1 + \varepsilon_2 p_2} \left(\frac{2\sigma_1 \sigma_3}{p_1 p_2} - \sigma_1^2 \frac{\varepsilon_2 p_2}{\varepsilon_1 p_1^3} - \sigma_3^2 \frac{\varepsilon_1 p_1}{\varepsilon_2 p_2^3} \right) \, dq \\
\tau_2 &= \frac{3}{2} \frac{\Phi_D}{\varepsilon_1 \kappa_1 + \varepsilon_2 \kappa_1} \left(\sigma_2 \varepsilon_2 \frac{\kappa_2}{\kappa_1} - \sigma_4 \varepsilon_1 \frac{\kappa_1}{\kappa_2} \right) \\
&\quad + \frac{1}{2\pi} \int_{-\infty}^{\infty} \frac{1}{\varepsilon_1 p_1 + \varepsilon_2 p_2} \left(\frac{2\sigma_2 \sigma_4}{p_1 p_2} - \sigma_2^2 \frac{\varepsilon_2 p_2}{\varepsilon_1 p_1^3} - \sigma_4^2 \frac{\varepsilon_1 p_1}{\varepsilon_2 p_2^3} \right) \, dq \\
\omega_\tau &= \frac{\varepsilon_1 \varepsilon_2 \kappa_1 \kappa_2 \Phi_D}{4(\varepsilon_1 \kappa_1 + \varepsilon_2 \kappa_3)} \left(-\frac{\sigma_1 + \sigma_2}{\varepsilon_1} \frac{1}{\kappa_1^2} + \frac{\sigma_3 + \sigma_4}{\varepsilon_2} \frac{1}{\kappa_2^2} \right) \\
&\quad + \frac{1}{2\pi} \int_{-\infty}^{\infty} \frac{1}{\varepsilon_1 p_1 + \varepsilon_2 p_2} \left(\frac{\sigma_2 \sigma_3 + \sigma_1 \sigma_4}{p_1 p_2} - \sigma_1 \sigma_2 \frac{\varepsilon_2 p_2}{\varepsilon_1 p_1^3} - \sigma_3 \sigma_4 \frac{\varepsilon_1 p_1}{\varepsilon_2 p_2^3} \right) \cos(qL) \, dq \\
&\quad - \frac{\Phi_D}{4\pi} \int_{-\infty}^{\infty} \frac{\varepsilon_1 \varepsilon_2 p_1 p_2}{\varepsilon_1 p_1 + \varepsilon_2 p_3} \left(-\frac{\sigma_1 + \sigma_2}{\varepsilon_1} \frac{1}{p_1^2} + \frac{\sigma_3 + \sigma_4}{\varepsilon_2} \frac{1}{p_2^2} \right) \frac{\sin(qL)}{q} \, dq
\end{aligned}$$

15.2.3 Notation

$$p_i = \sqrt{q^2 + \kappa_i^2}$$

16 Discussion

16.1 Surface interaction $\omega_{\gamma,1}(L)$

16.1.1 Exact Solution

$$\omega_{\gamma,1}(L) = \frac{1}{4\kappa_1\varepsilon_1} \left((\sigma_1^2 + \sigma_2^2)(\coth(\kappa_1 L) - 1) + \frac{2\sigma_1\sigma_2}{\sinh(\kappa_1 L)} \right)$$

Limits

$$\begin{aligned} \lim_{L \rightarrow \infty} \omega_{\gamma,1}(L) &= \frac{1}{4\kappa_1\varepsilon_1} \left((\sigma_1^2 + \sigma_2^2) \left(\lim_{L \rightarrow \infty} \coth(\kappa_1 L) - 1 \right) + \lim_{L \rightarrow \infty} \frac{2\sigma_1\sigma_2}{\sinh(\kappa_1 L)} \right) \\ &= \frac{1}{4\kappa_1\varepsilon_1} \left((\sigma_1^2 + \sigma_2^2)(1 - 1) + 0 \right) \\ &= 0 \end{aligned}$$

$$\begin{aligned} \lim_{L \rightarrow 0} \omega_{\gamma,1}(L) &= \lim_{L \rightarrow 0} \frac{1}{4\kappa_1\varepsilon_1} \frac{(\sigma_1^2 + \sigma_2^2)(\cosh(\kappa_1 L) - \sinh(\kappa_1 L)) + 2\sigma_1\sigma_2}{\sinh(\kappa_1 L)} \rightarrow 0 \\ &= \begin{cases} \lim_{L \rightarrow 0} \frac{2\sigma_1^2}{4\kappa_1\varepsilon_1} \frac{\cosh(\kappa_1 L) - \sinh(\kappa_1 L) - 1}{\sinh(\kappa_1 L)} & \sigma_1 = -\sigma_2 \\ +\infty & \sigma_1 \neq -\sigma_2 \end{cases} \\ &\stackrel{\text{L'Hopital}}{=} \begin{cases} \lim_{L \rightarrow 0} \frac{2\sigma_1^2}{4\kappa_1\varepsilon_1} \frac{\sin(\kappa_1 L) - \cosh(\kappa_1 L)}{\cosh(\kappa_1 L)} & \sigma_1 = -\sigma_1 \\ +\infty & \sigma_1 \neq -\sigma_2 \end{cases} \\ &= \begin{cases} -\frac{2\sigma_1^2}{4\kappa_1\varepsilon_1} & \sigma_1 = -\sigma_2 \\ +\infty & \sigma_1 \neq -\sigma_2 \end{cases} \end{aligned}$$

Asymptotics If both σ_1 and σ_2 are zero, then $\omega_{\gamma,1}(L)$ is constantly zero. This trivial case shall be excluded from the following analysis.

$$\begin{aligned} \omega_{\gamma,1}(L) &= \frac{1}{4\kappa_1\varepsilon_1} \frac{(\sigma_1^2 + \sigma_2^2)(\cosh(\kappa_1 L) - \sinh(\kappa_1 L)) + 2\sigma_1\sigma_2}{\sinh(\kappa_1 L)} \\ &= \frac{1}{4\kappa_1\varepsilon_1} \frac{(\sigma_1^2 + \sigma_2^2)(e^{\kappa_1 L} + e^{-\kappa_1 L} - e^{\kappa_1 L} + e^{-\kappa_1 L}) + 4\sigma_1\sigma_2}{e^{\kappa_1 L} - e^{-\kappa_1 L}} \\ &= \frac{2}{4\kappa_1\varepsilon_1} \frac{(\sigma_1^2 + \sigma_2^2)e^{-\kappa_1 L} + 2\sigma_1\sigma_2}{e^{\kappa_1 L} - e^{-\kappa_1 L}} \\ &= \frac{2}{4\kappa_1\varepsilon_1} \left((\sigma_1^2 + \sigma_2^2) \underbrace{\frac{1}{e^{2\kappa_1 L} - 1}}_{\in \mathcal{O}(e^{-2\kappa_1 L})} + 2\sigma_1\sigma_2 \underbrace{\frac{1}{e^{\kappa_1 L} + e^{-\kappa_1 L}}}_{\in \mathcal{O}(e^{-\kappa_1 L})} \right) \\ &\in \begin{cases} \mathcal{O}(e^{-\kappa_1 L}) & \sigma_1\sigma_2 \neq 0 \\ \mathcal{O}(e^{-2\kappa_1 L}) & \sigma_1\sigma_2 = 0 \end{cases} \end{aligned}$$

So, in general, for large L the interaction energy decays as $e^{-\kappa_1 L}$ if both σ_1 and σ_2 are non-zero. In case one of them is zero, the energy decays exponentially twice as fast due to the finite size of our system.

Zeros

$$\begin{aligned} \omega_{\gamma,1}(L) &= \frac{1}{4\kappa_1\varepsilon_1} \frac{(\sigma_1^2 + \sigma_2^2)(\cosh(\kappa_1 L) - \sinh(\kappa_1 L)) + 2\sigma_1\sigma_2}{\sinh(\kappa_1 L)} = 0 \\ &\Leftrightarrow (\sigma_1^2 + \sigma_2^2)(\cosh(\kappa_1 L) - \sinh(\kappa_1 L)) + 2\sigma_1\sigma_2 = 0 \quad \text{since } \omega_{\gamma,1}(0) \neq 0 \text{ we only need to look at } L > 0 \\ &\Leftrightarrow \cosh(\kappa_1 L) - \sinh(\kappa_1 L) = -\frac{2\sigma_1\sigma_2}{\sigma_1^2 + \sigma_2^2} \\ &\Leftrightarrow e^{-\kappa_1 L} = -\frac{2\sigma_1\sigma_2}{\sigma_1^2 + \sigma_2^2} \end{aligned}$$

So there is a zero if and only if

$$0 < -\frac{2\sigma_1\sigma_2}{\sigma_1^2 + \sigma_2^2} < 1 \quad (\text{IV.7})$$

$\sigma_1\sigma_2 < 0$ is a necessary condition for this. Under this condition we have

$$\begin{aligned} (\text{IV.7}) &\Leftrightarrow -2\sigma_1\sigma_2 < \sigma_1^2 + \sigma_2^2 \\ &\Leftrightarrow \sigma_1^2 + \sigma_2^2 + 2\sigma_1\sigma_2 > 0 \\ &\Leftrightarrow (\sigma_1 + \sigma_2)^2 > 0 \\ &\Leftrightarrow \sigma_1 \neq -\sigma_2 \end{aligned}$$

Thus if $\sigma_1\sigma_2 \geq 0$ or $\sigma_1 = -\sigma_2$ there are no zeroes and if $\sigma_1\sigma_2 < 0$ and $\sigma_1 \neq -\sigma_2$ there is exactly one zero at $L = -\frac{1}{\kappa_1} \ln\left(-\frac{2\sigma_1\sigma_2}{\sigma_1^2 + \sigma_2^2}\right)$.

Local extrema

$$\begin{aligned} \frac{d}{dL}\omega_{\gamma,1}(L) &= \frac{1}{4\varepsilon_1\kappa_1} \left((\sigma_1^2 + \sigma_2^2) \frac{-\kappa_1}{\sinh^2(\kappa_1 L)} + 2\sigma_1\sigma_2\kappa_1 \cosh(\kappa_1 L) \left(-\frac{1}{\sinh^2(\kappa_1 L)} \right) \right) \\ &= -\frac{1}{4\varepsilon_1} \left((\sigma_1^2 + \sigma_2^2) \frac{1}{\sinh^2(\kappa_1 L)} + 2\sigma_1\sigma_2 \frac{\cosh(\kappa_1 L)}{\sinh^2(\kappa_1 L)} \right) \\ &= -\frac{1}{4\varepsilon_1 \sinh^2(\kappa_1 L)} (\sigma_1^2 + \sigma_2^2 + 2\sigma_1\sigma_2 \cosh(\kappa_1 L)) \end{aligned}$$

$$\begin{aligned} \frac{d}{dL}\omega_{\gamma,1}(L) = 0 &\Leftrightarrow \sigma_1^2 + \sigma_2^2 + 2\sigma_1\sigma_2 \cosh(\kappa_1 L) = 0 \\ &\Leftrightarrow \cosh(\kappa_1 L) = -\frac{\sigma_1^2 + \sigma_2^2}{2\sigma_1\sigma_2} \end{aligned}$$

this is solvable if and only if

$$-\frac{\sigma_1^2 + \sigma_2^2}{2\sigma_1\sigma_2} \geq 1 \quad (\text{IV.8})$$

$\sigma_1\sigma_2 < 0$ is a necessary condition for this. Under this condition we have

$$\begin{aligned} (\text{IV.8}) &\Leftrightarrow -\sigma_1^2 - \sigma_2^2 \leq 2\sigma_1\sigma_2 \\ &\Leftrightarrow -\sigma_1^2 - \sigma_2^2 - 2\sigma_1\sigma_2 \leq 0 \\ &\Leftrightarrow \sigma_1^2 + \sigma_2^2 + 2\sigma_1\sigma_2 \geq 0 \\ &\Leftrightarrow (\sigma_1 + \sigma_2)^2 \geq 0 \end{aligned}$$

i.e., $\sigma_1\sigma_2 < 0$ is both necessary and sufficient. If $\sigma_1 \neq -\sigma_2$ we know that $\omega_{\gamma,1}(L)$ has exactly one zero and goes to zero in the limit to infinity, it must have at least one local minimum. Since we only have one local extremum this extremum has to be a minimum. If $\sigma_1 = -\sigma_2$ we know that $\omega_{\gamma,1} < 0$ and $\omega_{\gamma,1}(L)$ goes to zero in the limit $L \rightarrow \infty$ either $L = 0$ is a minimum or there is a local minimum with $L > 0$. Since putting $\sigma_1 = -\sigma_2$ into our equation yields only $L = 0$ we know there is no local minimum with $L > 0$ so there is a minimum at $L = 0$.

So we conclude if $\sigma_1\sigma_2 < 0$ we have one local minimum at

$$L = \frac{1}{\kappa_1} \operatorname{arcosh} \left(-\frac{1}{2} \left(\frac{\sigma_1}{\sigma_2} + \frac{\sigma_1}{\sigma_2} \right) \right)$$

and no other local extrema and if $\sigma_1\sigma_2 \geq 0$ we have no local extrema.

16.1.2 Superposition solution

$$\omega_{\gamma,1}(L) = \frac{\sigma_1\sigma_2}{2\kappa_1\varepsilon_1} e^{-\kappa_1 L}$$

Limits We see that in contrast to the exact solution, the superposition approximation result does always converge in the limit $L \rightarrow 0$.

Asymptotics We see that in the case $\sigma_1\sigma_2 = 0$ the superposition approximation result is zero, while the exact solution is of order $\mathcal{O}(e^{-2\kappa_1 L})$. In the case $\sigma_1\sigma_2 \neq 0$ the superposition solution predicts the exponential order correctly ($\mathcal{O}(e^{-\kappa_1 L})$ in accordance with the exact solution) but the prefactor is too small by a factor of two when compared to the exact solution, i.e.

$$\lim_{L \rightarrow \infty} \frac{\omega_{\gamma,1}^e(L)}{\omega_{\gamma,1}^s(L)} = 2$$

So the superposition solution is unable to give an asymptotically correct solution for $L \rightarrow \infty$. Furthermore, we can also conclude that the factor of 2 that was also found in Ref. [1] for identical particles is not a consequence of the symmetry of the system.

Zeros Except for the constant zero cases ($\sigma_1\sigma_2 = 0$) there are no further zeros.

Local extrema There are no local extremas.

16.1.3 Plots

Below, we show one plot for the surface interaction energy $\omega_{\gamma,1}(L)$ as a function of the separation distance L for each of the distinctive cases outlined above. For all the following plots of this chapter we use $\varepsilon_1 = 80\varepsilon_0$, $\varepsilon_2 = 2\varepsilon_0$, $\kappa_1 = 0.1 \text{ nm}^{-1}$, $\kappa_2 = 0.03 \text{ nm}^{-1}$, and $\Phi_D = 1 \text{ k}_B\text{T}/e$.

Case 1: $\sigma_1\sigma_2 > 0$

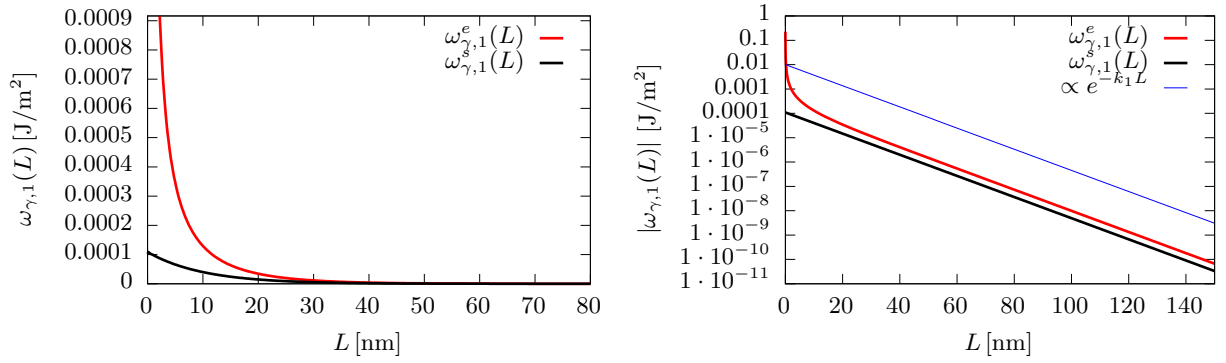


Figure IV.3: $\omega_{\gamma,1}(L)$ for $\sigma_1 = 0.02 \text{ e}/\text{nm}^2$, $\sigma_2 = 0.03 \text{ e}/\text{nm}^2$

Case 2: $\sigma_1\sigma_2 = 0$

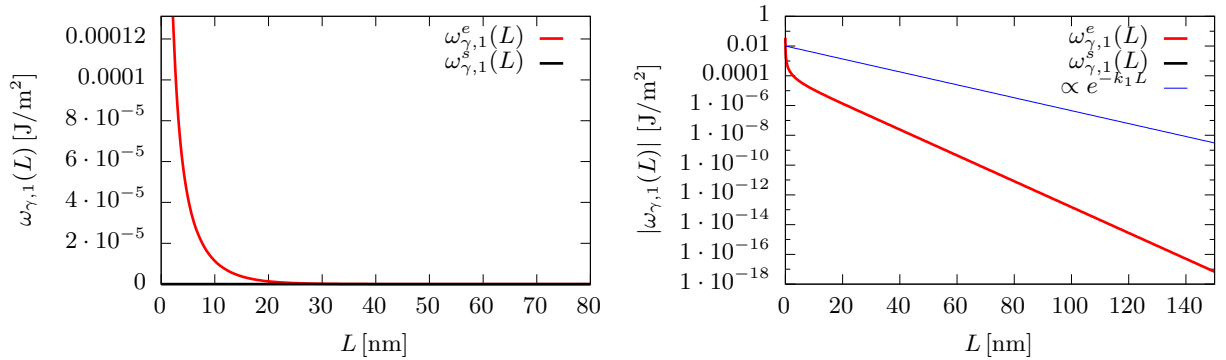


Figure IV.4: $\omega_{\gamma,1}(L)$ for $\sigma_1 = 0.02 \text{ e}/\text{nm}^2$, $\sigma_2 = 0$

Since $\omega_{\gamma,1}^s(L)$ is constantly zero, the value for the curve on the right plot of Fig. IV.4 is undefined.

Case 3: $\sigma_1\sigma_2 < 0, \sigma_1 \neq -\sigma_2$

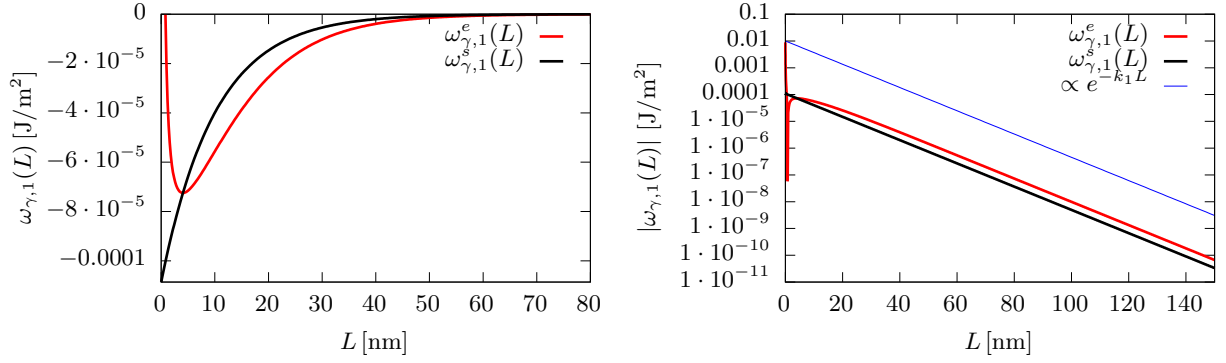


Figure IV.5: $\omega_{\gamma,1}(L)$ for $\sigma_1 = 0.02 \text{ e/nm}^2$, $\sigma_2 = -0.03 \text{ e/nm}^2$

Case 4: $\sigma_1 = -\sigma_2$

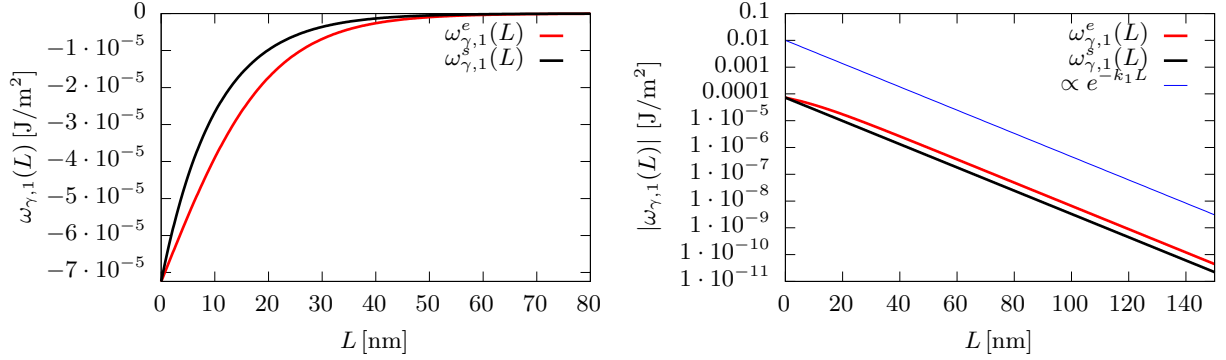


Figure IV.6: $\omega_{\gamma,1}(L)$ for $\sigma_1 = 0.02$, $\sigma_2 = -0.02$

16.2 Line tension τ_1

When comparing the expressions for τ_1 we see that while the integral term is the same for both the superposition approximation and the exact solution, they differ in the prefactor of the first term, where the superposition solution has an additional factor of $\frac{3}{2}$ compared to the exact solution. This is due to the fact that for $\sigma_2 = \sigma_4 = 0$ and $L \rightarrow \infty$ the exact solution for the potential Φ^e converges to $\Phi^{\sigma_1, \sigma_3}$ (the Fourier series becomes a Fourier integral in the limit $L \rightarrow \infty$) while the superposition approximation does not because all terms involving Φ_D are doubled when we add $\Phi^{\sigma_2, \sigma_4}(x, -(z-L))$ and these terms do not depend on the σ 's. So the superposition approximation does not correctly predict τ_1 , despite τ_1 being a property of a semi-infinite system, while the exact solution does.

16.3 Line interaction $\omega_\tau(L)$

Since an analytical analysis of the expression is hard, we will look at several different cases numerically. Since the parameter space of $\omega_\tau^e(L)$ ($\omega_\tau^s(L)$) is 8 (9) dimensional, our following analysis can of course be nothing more than a systematic exploration of a part of the possible behaviours, but it already shows a lot of interesting behaviour.

First, we plot $\omega_\tau^e(L)$ as a function of L for different values of the parameters σ_4 , κ_1 , κ_2 , ε_1 , ε_2 , and Φ_D . Then we compare the exact solution $\omega_\tau^e(L)$ and the superposition solution $\omega_\tau^s(L)$ for different combinations of the charge densities σ_1 , σ_2 , σ_3 , and σ_4 . This also includes the special case of oppositely charged plates. And finally, we discuss the case where one or more of the four charge densities equal to zero.

As shown by the plots the line interaction energy can be positive as well as negative, depending upon the parameters of the system. For a given system, it can even change sign with changing separation. Also, it is evident from the plots that for small separations the superposition approximation predicts a qualitatively wrong behaviour at short separations.

16.3.1 Variation of a charge (σ_4)

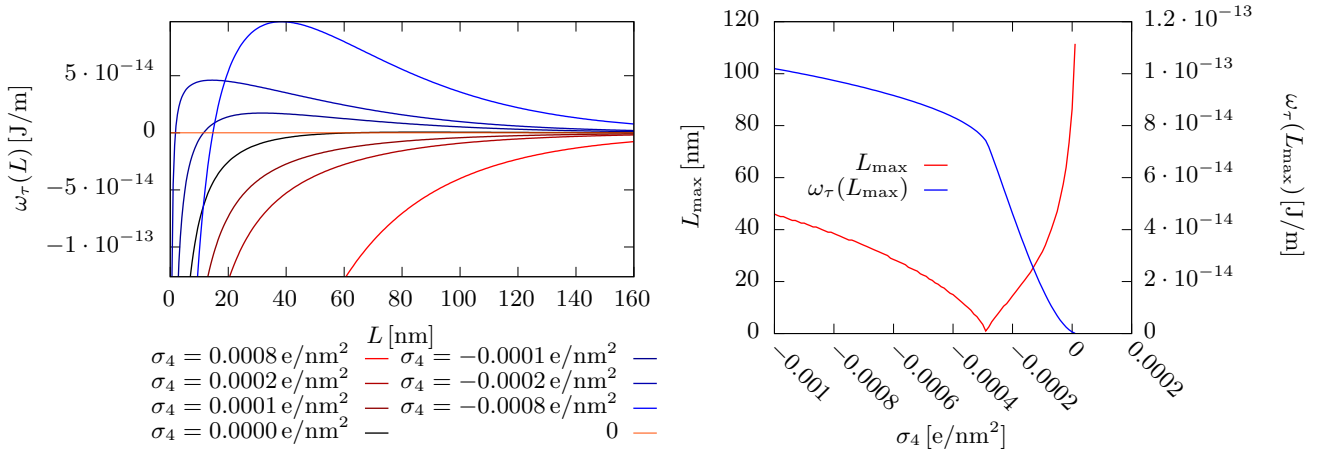


Figure IV.7: $\omega_\tau(L)$ (left) and location and magnitude of its Maximum (right) for $\sigma_1 = 0.02 \text{ e/nm}^2$, $\sigma_2 = 0.03 \text{ e/nm}^2$, $\sigma_3 = 0.0004 \text{ e/nm}^2$

So we see from Fig. IV.7 that we already have qualitatively different behaviour from that seen in [1]: For slightly positive values and for all negative values we see non-monotonic behaviour and a maximum.

16.3.2 Variation of the first inverse Debye length κ_1

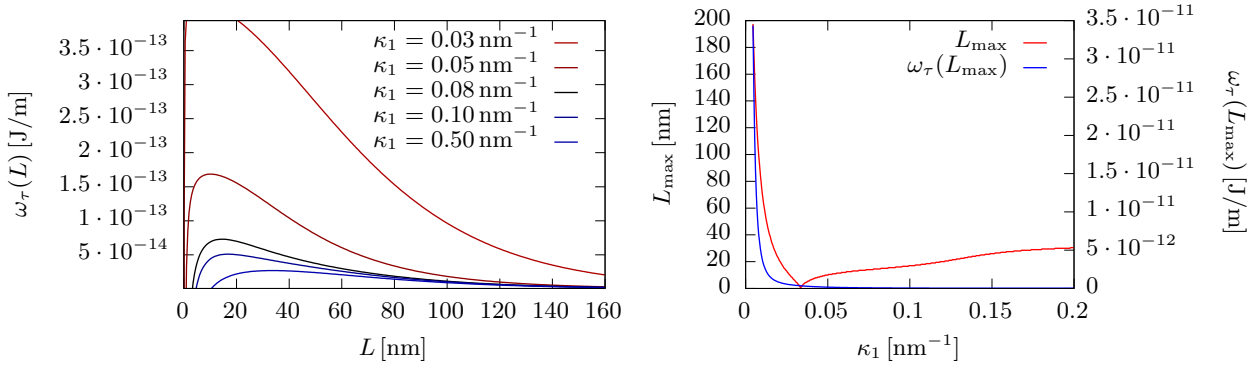


Figure IV.8: $\omega_\tau(L)$ (left) and location and magnitude of its Maximum (right) for $\sigma_1 = 0.02 \text{ e/nm}^2$, $\sigma_2 = -0.03 \text{ e/nm}^2$, $\sigma_3 = -0.0004 \text{ e/nm}^2$, $\sigma_4 = 0.0002 \text{ e/nm}^2$

16.3.3 Variation of inverse Debye length κ_2

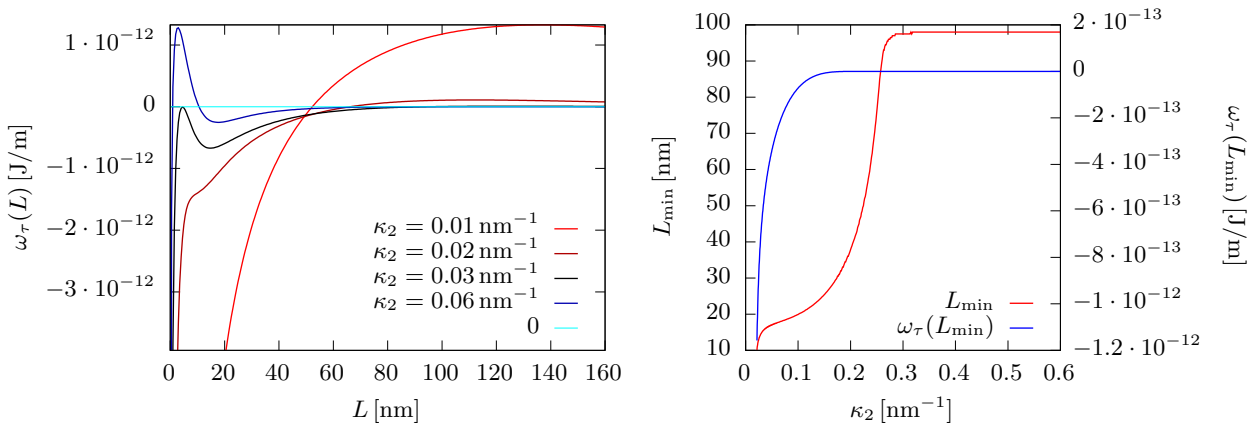


Figure IV.9: $\omega_\tau(L)$ (left) and location and magnitude of its minimum (right) for $\sigma_1 = 0.02 \text{ e/nm}^2$, $\sigma_2 = -0.03 \text{ e/nm}^2$, $\sigma_3 = 0.004 \text{ e/nm}^2$, $\sigma_4 = -0.002 \text{ e/nm}^2$, $\varepsilon_1 = 2\varepsilon_0$, $\varepsilon_2 = 20\varepsilon_0$, $\kappa_1 = 0.3 \text{ nm}^{-1}$

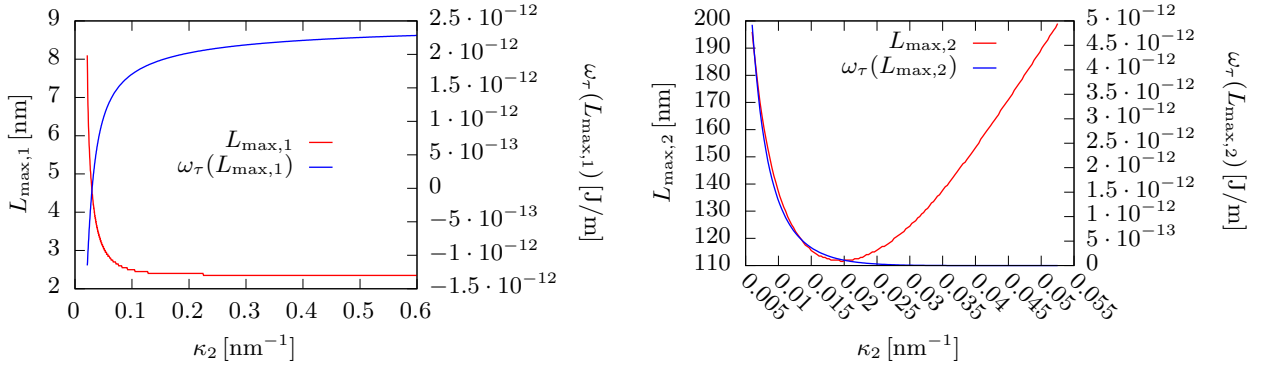


Figure IV.10: First (left) and Second (right) Maximum of $\omega_\tau(L)$ for $\sigma_1 = 0.02 \text{ e/nm}^2$, $\sigma_2 = -0.03 \text{ e/nm}^2$, $\sigma_3 = 0.004 \text{ e/nm}^2$, $\sigma_4 = -0.002 \text{ e/nm}^2$, $\epsilon_1 = 2 \epsilon_0$, $\epsilon_2 = 20 \epsilon_0$, $\kappa_1 = 0.3 \text{ nm}^{-1}$

Here we see another qualitative difference from [1]: We see in Fig. IV.9, IV.10 that it is possible to have a minimum and a maximum, but also a minimum and two maxima depending on the parameters.

16.3.4 Variation of permittivity ϵ_1

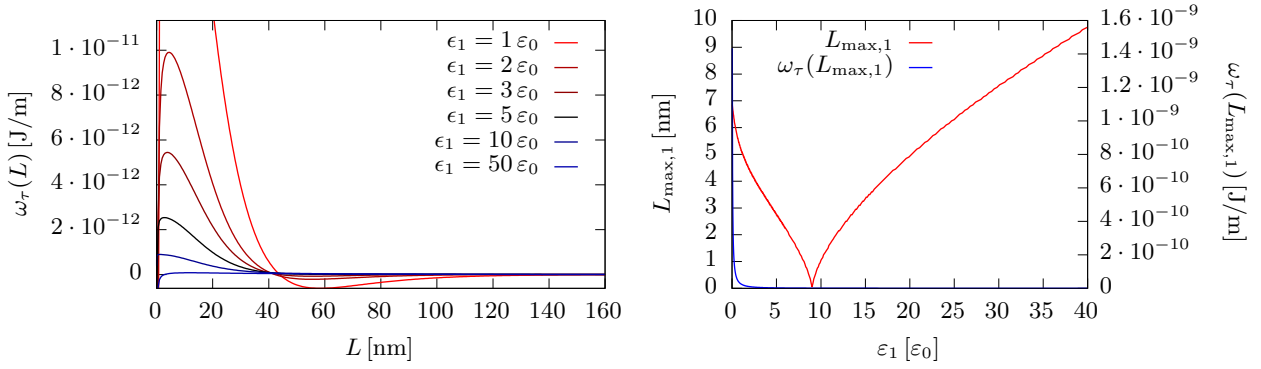


Figure IV.11: $\omega_\tau(L)$ and location and magnitude of its first maximum for $\sigma_1 = 0.02 \text{ e/nm}^2$, $\sigma_2 = -0.03 \text{ e/nm}^2$, $\sigma_3 = -0.0004 \text{ e/nm}^2$, $\sigma_4 = 0.0002 \text{ e/nm}^2$

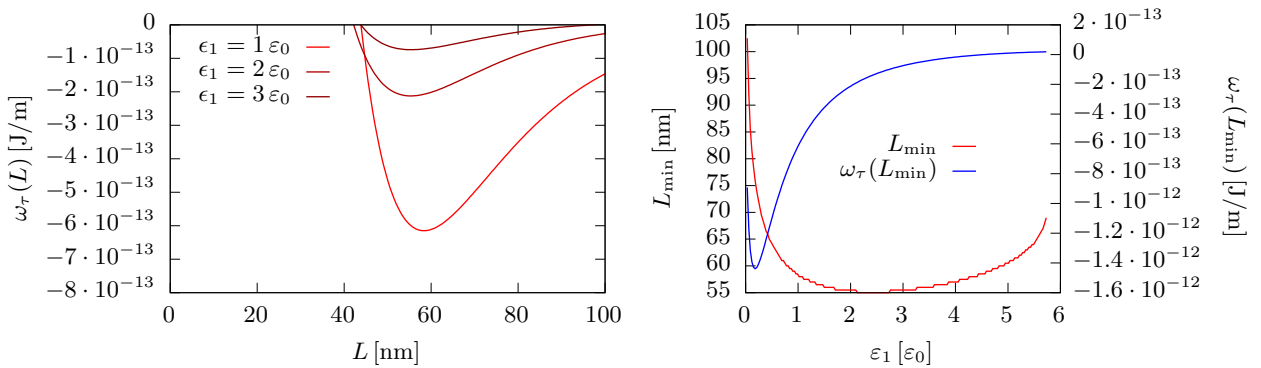


Figure IV.12: $\omega_\tau(L)$ and location and magnitude of its minimum for $\sigma_1 = 0.02 \text{ e/nm}^2$, $\sigma_2 = -0.03 \text{ e/nm}^2$, $\sigma_3 = -0.0004 \text{ e/nm}^2$, $\sigma_4 = 0.0002 \text{ e/nm}^2$

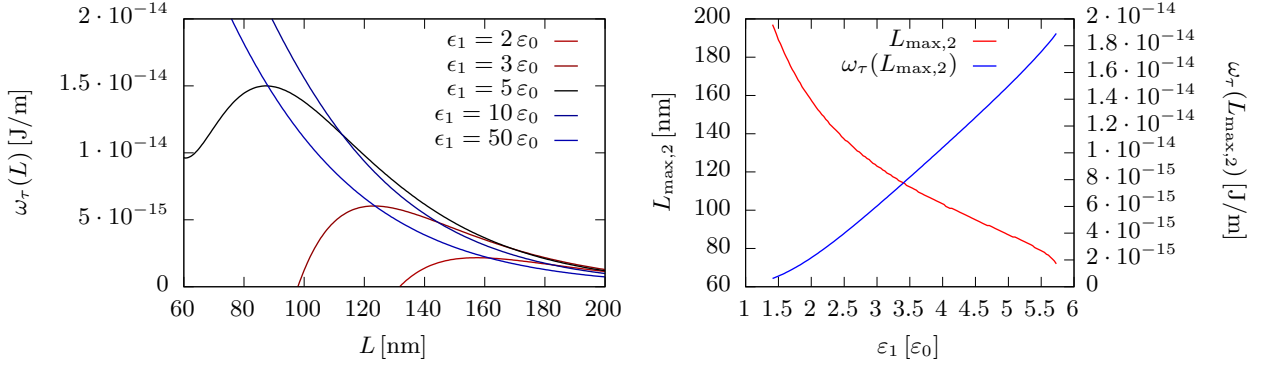


Figure IV.13: $\omega_\tau(L)$ and location and magnitude of its second maximum for $\sigma_1 = 0.02 \text{ e/nm}^2$, $\sigma_2 = -0.03 \text{ e/nm}^2$, $\sigma_3 = -0.0004 \text{ e/nm}^2$, $\sigma_4 = 0.0002 \text{ e/nm}^2$

Here we have depending on the parameter either a maximum and a minimum, two maxima and a minimum or just a maximum.

16.3.5 Variation of permittivity ϵ_2

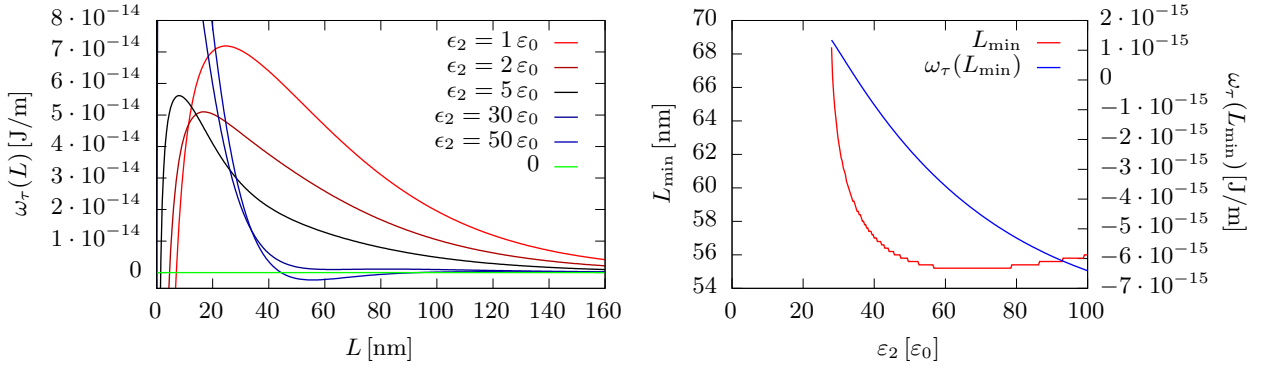


Figure IV.14: $\omega_\tau(L)$ and location and magnitude of its first minimum for $\sigma_1 = 0.02 \text{ e/nm}^2$, $\sigma_2 = -0.03 \text{ e/nm}^2$, $\sigma_3 = -0.0004 \text{ e/nm}^2$, $\sigma_4 = 0.0002 \text{ e/nm}^2$

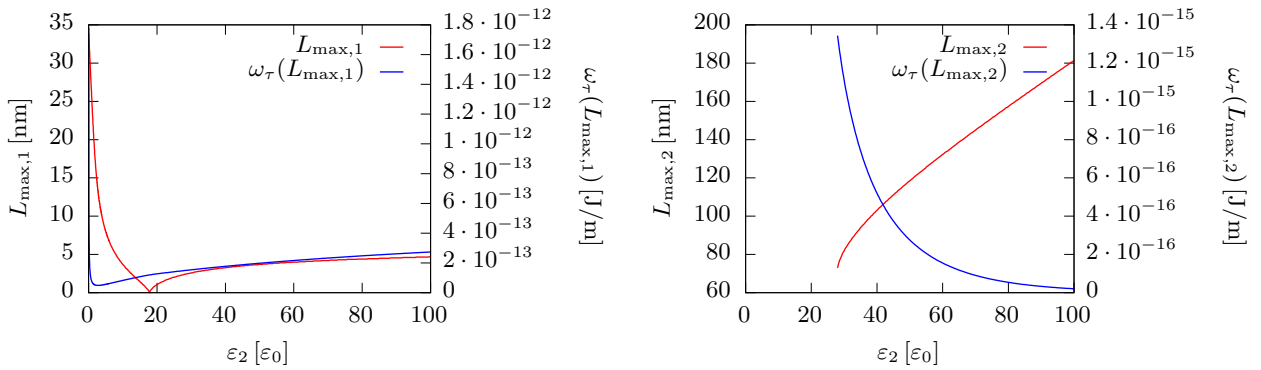


Figure IV.15: Location and magnitude of the first (left) and second (right) maximum of $\omega_\tau(L)$ for $\sigma_1 = 0.02 \text{ e/nm}^2$, $\sigma_2 = -0.03 \text{ e/nm}^2$, $\sigma_3 = -0.0004 \text{ e/nm}^2$, $\sigma_4 = 0.0002 \text{ e/nm}^2$

Here we have depending on the parameter either a maximum or a minimum and two maxima.

16.3.6 Variation of the Donnan potential Φ_D

It is clear from the analytic expressions that the exact solution for the line interaction energy does not depend upon the Donnan potential Φ_D . However, quite surprisingly, the superposition expression for the line interaction energy does depend upon Φ_D . Below we show the variation of the line interaction energy $\omega_\tau^s(L)$ with the

variation of Φ_D and discuss the asymptotic behaviour of the ratio $\omega_\tau^e(L)/\omega_\tau^s(L)$.

From this discussion we exclude the cases that do not have a three phase contact line and therefore have zero line interaction energies, as will be detailed in 16.3.10. Furthermore we distinguish two cases here. The finite size effect case and the non finite size effect case. The finite size effect occurs if one of the walls is not charged, and is analyzed in 16.3.10.

Finite size effect case If Φ_D is zero then the superposition solution is constantly zero (see 16.3.10).

If Φ_D is not zero, then the ratio converges to zero because of the different asymptotics outlined in 16.3.10, as can be seen in Figs. IV.30 and IV.31.

Non finite size effect case If Φ_D is zero then in all cases we observe, the ratio of exact solution to superposition solution converges against two.

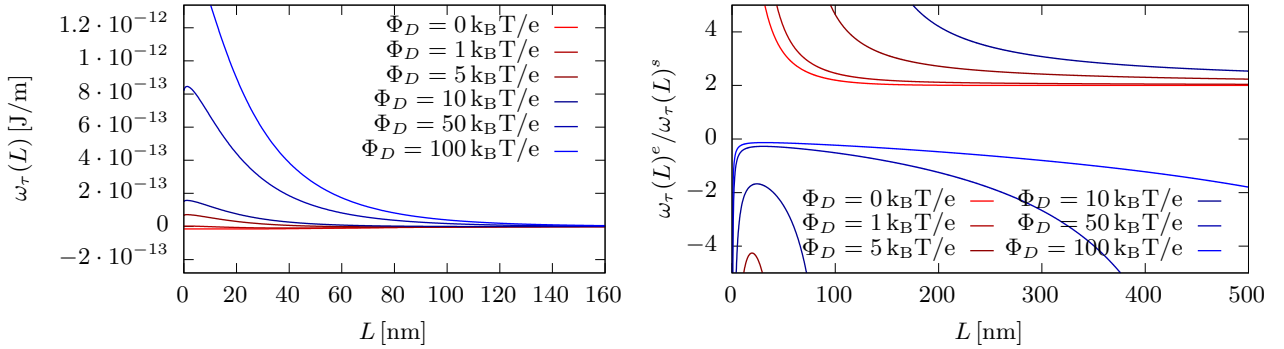


Figure IV.16: $\omega_\tau(L)$ for $\sigma_1 = 0.02 e/\text{nm}^2$, $\sigma_2 = 0.03 e/\text{nm}^2$, $\sigma_3 = 0.0004 e/\text{nm}^2$, $\sigma_4 = 0.0002 e/\text{nm}^2$

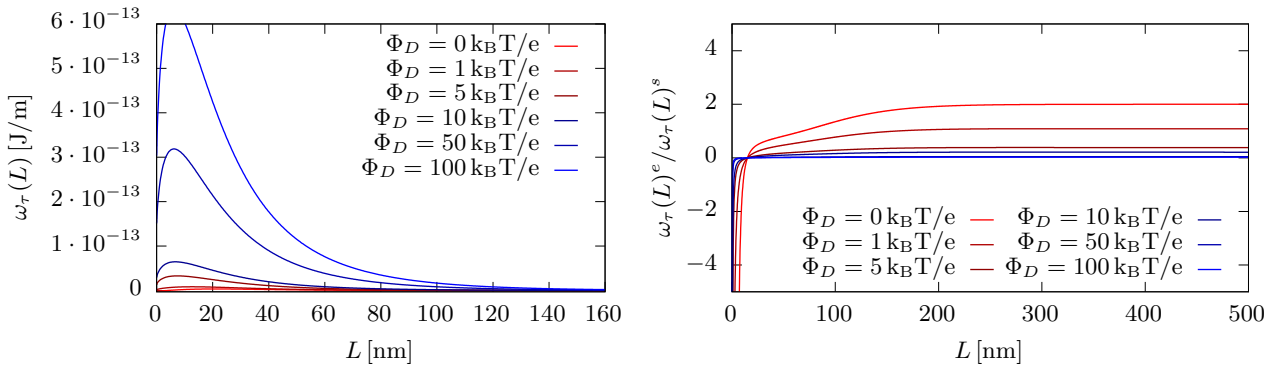


Figure IV.17: $\omega_\tau(L)$ for $\sigma_1 = 0.02 e/\text{nm}^2$, $\sigma_2 = 0.03 e/\text{nm}^2$, $\sigma_3 = 0$, $\sigma_4 = 0.0002 e/\text{nm}^2$

For most other non finite size effect cases the ratio tends to increasingly deviate from the factor of two with raising Φ_D , but the exact behaviour tends to differ. The cases outlined in 16.3.7 show behaviour similar to that displayed in Fig. IV.16, while those in 16.3.10 display behaviour similar to that displayed in Fig. IV.17.

16.3.7 All signs

In the following plots we consider all 16 possible sign combinations for the charge densities σ_1 , σ_2 , σ_3 and σ_4 . If we regard the exact solution $\omega_\tau^e(L)$ as a function of the σ 's, we have

$$\forall_{s \in \mathbb{R}} \omega_\tau^e(s\sigma_1, s\sigma_2, s\sigma_3, s\sigma_4; L) = s^2 \omega_\tau^e(\sigma_1, \sigma_2, \sigma_3, \sigma_4; L)$$

or more specifically for case $s = -1$

$$\omega_\tau^e(-\sigma_1, -\sigma_2, -\sigma_3, -\sigma_4; L) = \omega_\tau^e(\sigma_1, \sigma_2, \sigma_3, \sigma_4; L)$$

i.e., the exact solution is invariant regarding inversion of all signs. For the superposition solution this is not true and can be seen in the following plot where we have a sign combination on the left and the combination with all signs inverted on the right hand side.

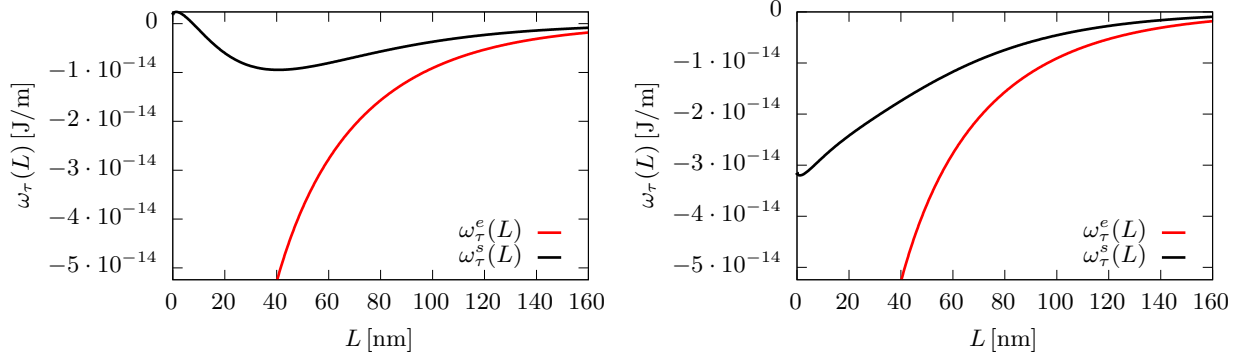


Figure IV.18: $\omega_\tau(L)$ for $\sigma_1 = 0.02 \text{ e/nm}^2$, $\sigma_2 = 0.03 \text{ e/nm}^2$, $\sigma_3 = 0.0004 \text{ e/nm}^2$, $\sigma_4 = 0.0002 \text{ e/nm}^2$ (left) and inverted signs (right)

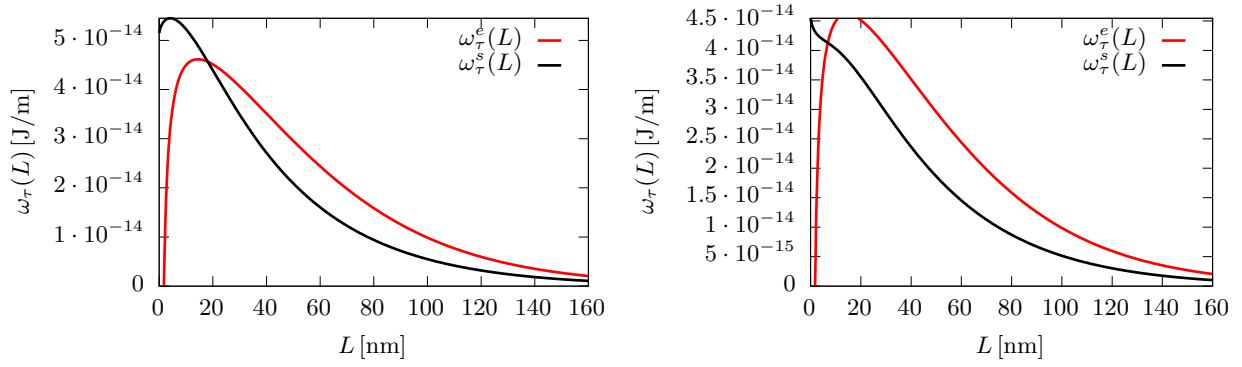


Figure IV.19: $\omega_\tau(L)$ for $\sigma_1 = 0.02 \text{ e/nm}^2$, $\sigma_2 = 0.03 \text{ e/nm}^2$, $\sigma_3 = 0.0004 \text{ e/nm}^2$, $\sigma_4 = -0.0002 \text{ e/nm}^2$ (left) and inverted signs (right)

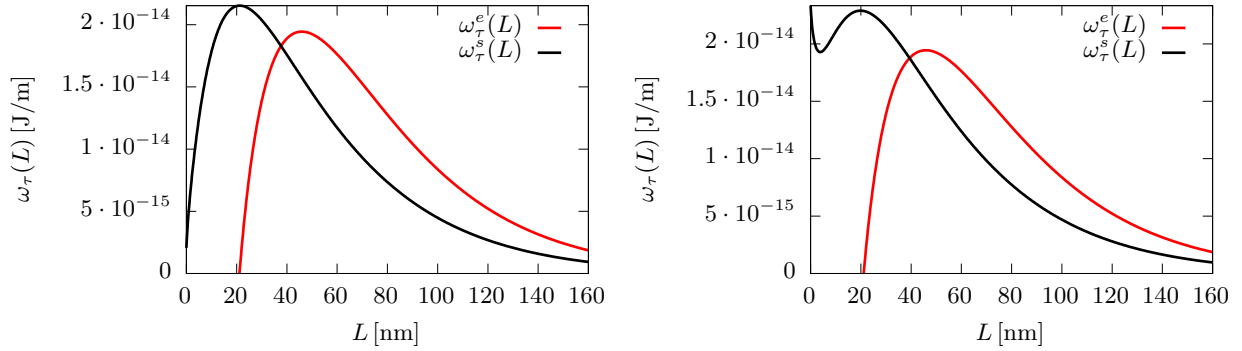


Figure IV.20: $\omega_\tau(L)$ for $\sigma_1 = 0.02 \text{ e/nm}^2$, $\sigma_2 = 0.03 \text{ e/nm}^2$, $\sigma_3 = -0.0004 \text{ e/nm}^2$, $\sigma_4 = 0.0002 \text{ e/nm}^2$ (left) and inverted signs (right)

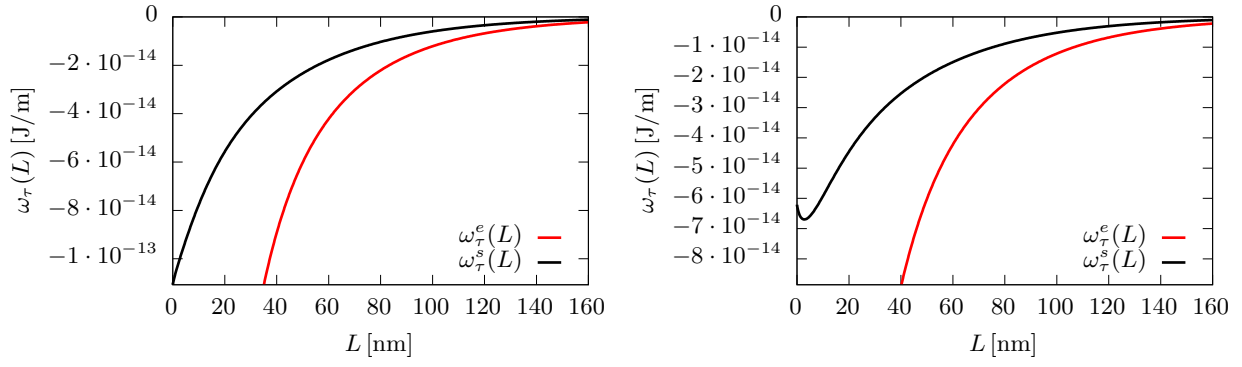


Figure IV.21: $\omega_\tau(L)$ for $\sigma_1 = 0.02 \text{ e/nm}^2$, $\sigma_2 = 0.03 \text{ e/nm}^2$, $\sigma_3 = -0.0004 \text{ e/nm}^2$, $\sigma_4 = -0.0002 \text{ e/nm}^2$ (left) and inverted signs (right)

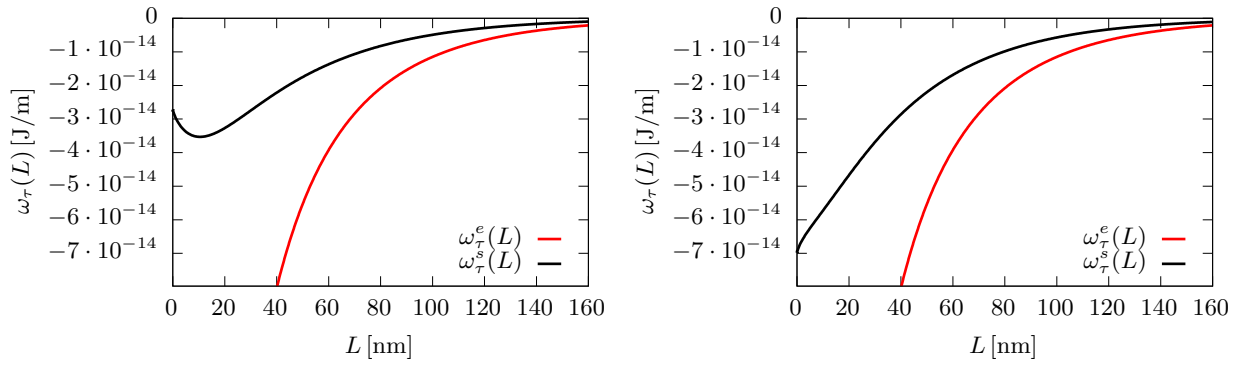


Figure IV.22: $\omega_\tau(L)$ for $\sigma_1 = 0.02 \text{ e/nm}^2$, $\sigma_2 = -0.03 \text{ e/nm}^2$, $\sigma_3 = 0.0004 \text{ e/nm}^2$, $\sigma_4 = 0.0002 \text{ e/nm}^2$ (left) and inverted signs (right)

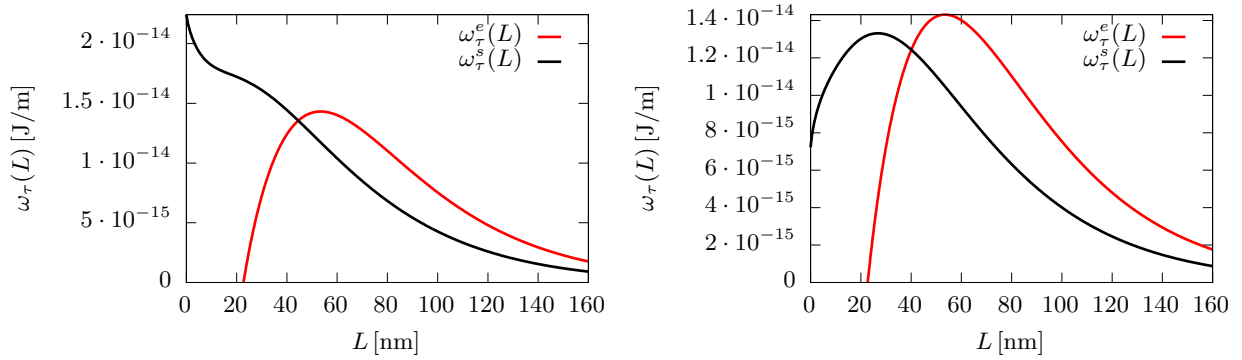


Figure IV.23: $\omega_\tau(L)$ for $\sigma_1 = 0.02 \text{ e/nm}^2$, $\sigma_2 = -0.03 \text{ e/nm}^2$, $\sigma_3 = 0.0004 \text{ e/nm}^2$, $\sigma_4 = -0.0002 \text{ e/nm}^2$ (left) and inverted signs (right)

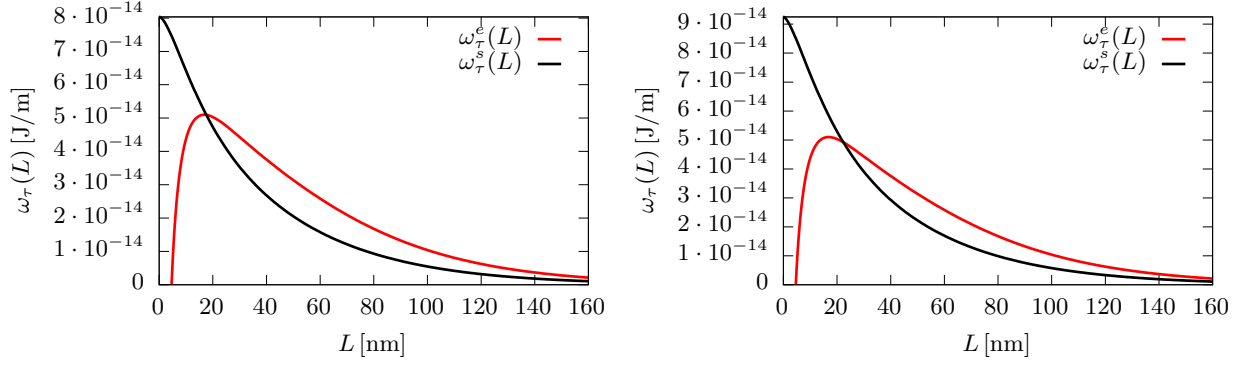


Figure IV.24: $\omega_\tau(L)$ for $\sigma_1 = 0.02 \text{ e/nm}^2$, $\sigma_2 = -0.03 \text{ e/nm}^2$, $\sigma_3 = -0.0004 \text{ e/nm}^2$, $\sigma_4 = 0.0002 \text{ e/nm}^2$ (left) and inverted signs (right)

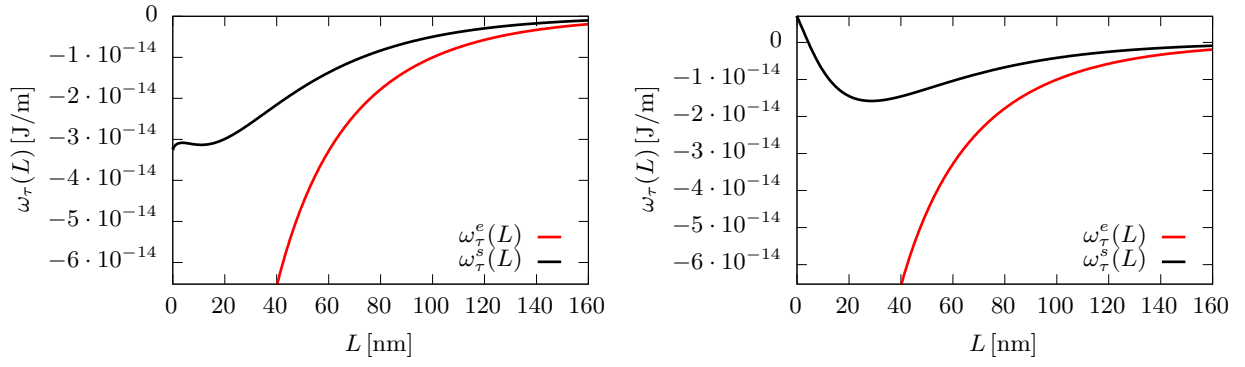


Figure IV.25: $\omega_\tau(L)$ for $\sigma_1 = 0.02 \text{ e/nm}^2$, $\sigma_2 = -0.03 \text{ e/nm}^2$, $\sigma_3 = -0.0004 \text{ e/nm}^2$, $\sigma_4 = -0.0002 \text{ e/nm}^2$ (left) and inverted signs (right)

In all the 16 cases discussed above, both $\omega_\tau^e(L)$ and $\omega_\tau^s(L)$ show similar asymptotic behaviour to that displayed in Fig. IV.26, i.e., they vary $\sim \exp(-\kappa_2 L)$ for $L \rightarrow \infty$.

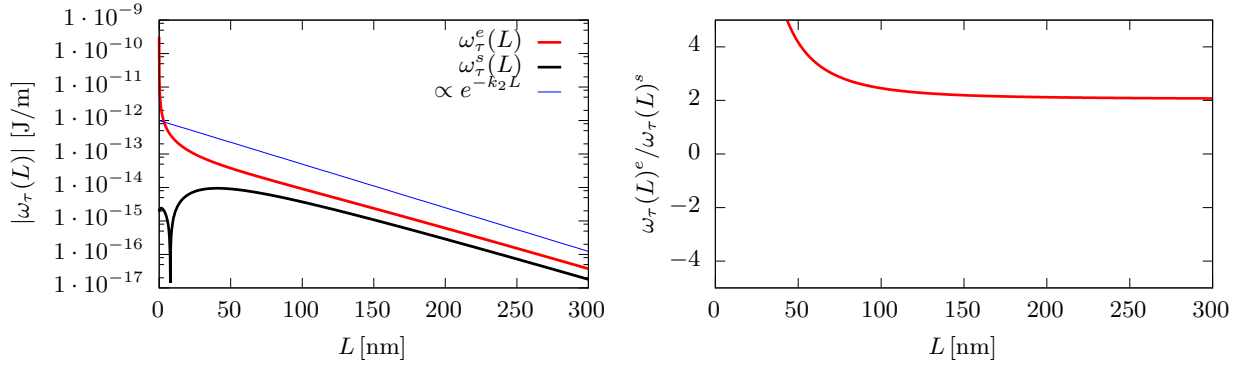


Figure IV.26: $\omega_\tau(L)$ for $\sigma_1 = 0.02 \text{ e/nm}^2$, $\sigma_2 = 0.03 \text{ e/nm}^2$, $\sigma_3 = 0.0004 \text{ e/nm}^2$, $\sigma_4 = 0.0002 \text{ e/nm}^2$

16.3.8 Lines

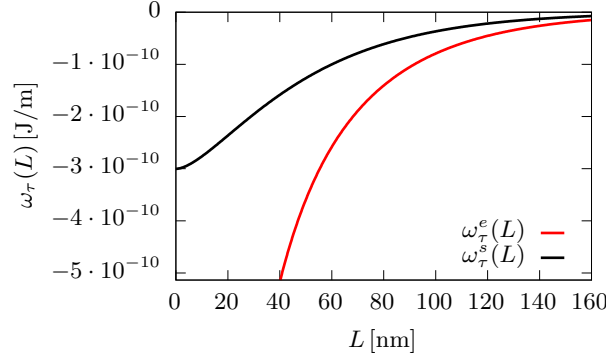


Figure IV.27: $\omega_\tau(L)$ for $\sigma_1 = 0.02 \text{ e/nm}^2$, $\sigma_2 = 0.03 \text{ e/nm}^2$, $\sigma_3 = 0.02 \text{ e/nm}^2$, $\sigma_4 = 0.03 \text{ e/nm}^2$

In the case depicted in Fig. IV.27 we still have a three-phase contact line, even though both walls are homogeneously charged because we still have non-identical fluids on both sides of the interface. If we additionally set $\kappa_1 = \kappa_2$ and $\varepsilon_1 = \varepsilon_2$ we can see directly from the formula given in Eqs. (IV.5) and (IV.6), that the line interaction energy is constantly zero for both the exact solution and superposition approximation, which is to be expected since we in that case have two identical fluids and two homogeneously charged walls, i.e. there is no line and therefore no line interaction. The same holds more generally in any case with $\sigma_1 = \sigma_3$, $\sigma_2 = \sigma_4$, $\kappa_1 = \kappa_2$ and $\varepsilon_1 = \varepsilon_2$, since all these cases have no line.

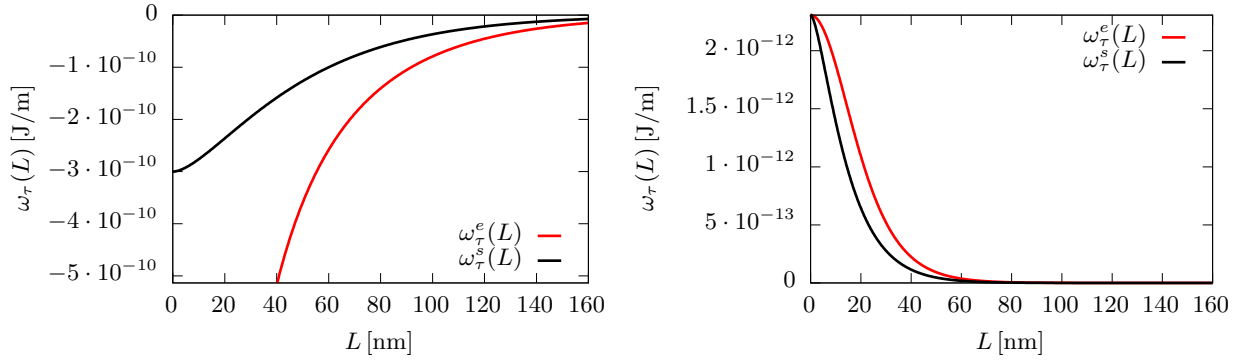


Figure IV.28: $\omega_\tau(L)$ for $\sigma_1 = 0.02 \text{ e/nm}^2$, $\sigma_2 = 0.03 \text{ e/nm}^2$, $\sigma_3 = 0.03 \text{ e/nm}^2$, $\sigma_4 = 0.02 \text{ e/nm}^2$ (left) and additionally $\varepsilon_1 = \varepsilon_2 = 2 \varepsilon_0$, $\kappa_1 = \kappa_2 = 0.1 \text{ nm}^{-1}$ (right)

In the case of the right hand side plot we still have a line, since each wall has two different charges on it, although it is not a three phase contact line anymore since the liquids on each “side” are the same.

All four of these cases have (except obviously the case of zero energy) the usual asymptotics for $L \rightarrow \infty$.

The exact solution $\omega_\tau^e(L)$ usually diverges because of its first term that is proportional to $\frac{1}{L}$, but there are two principal ways to overcome this. Either all the terms in it vanish separately, i.e. $\sigma_1 = -\sigma_2$ and $\sigma_3 = -\sigma_4$ (for a discussion of this case see 16.3.9) or the terms cancel each other. The latter can be achieved by $\kappa_1 = \kappa_2$, $\varepsilon_1 = \varepsilon_2$ and $2(\sigma_1 + \sigma_2)(\sigma_3 + \sigma_4) - (\sigma_1 + \sigma_2)^2 - (\sigma_3 + \sigma_4)^2 = -(\sigma_1 + \sigma_2 - \sigma_3 - \sigma_4)^2 = 0$, i.e. $\sigma_1 + \sigma_2 - \sigma_3 - \sigma_4 = 0$, as is the case in Fig. IV.28 on the right side and we see indeed that $\omega_\tau^e(L)$ converges this case.

It should also be noted that the $\frac{1}{L}$ term in the exact solution will always cause convergence to negative infinity since the coefficient is always ≤ 0 :

$$\begin{aligned} & \frac{1}{L} \underbrace{\frac{1}{\kappa_1 \varepsilon_1 + \kappa_2 \varepsilon_2}}_{> 0} \underbrace{\left(\frac{(\sigma_1 + \sigma_2)(\sigma_3 + \sigma_4)}{2\kappa_1 \kappa_2} - \frac{1}{4\kappa_1^2} \frac{\kappa_2 \varepsilon_2}{\kappa_1 \varepsilon_1} (\sigma_1 + \sigma_2)^2 - \frac{1}{4\kappa_2^2} \frac{\kappa_1 \varepsilon_1}{\kappa_2 \varepsilon_2} (\sigma_3 + \sigma_4)^2 \right)}_{\leq 0} \\ & = - \left(\frac{\sigma_1 + \sigma_2}{2\kappa_1 \sqrt{\frac{\kappa_1 \varepsilon_1}{\kappa_2 \varepsilon_2}}} - \frac{\sigma_3 + \sigma_4}{2\kappa_2 \sqrt{\frac{\kappa_2 \varepsilon_2}{\kappa_1 \varepsilon_1}}} \right)^2 \leq 0 \end{aligned}$$

16.3.9 Antisymmetric Charges

As discussed previously, $\omega_\tau^e(L)$ converges in the case $\sigma_1 = -\sigma_2$ and $\sigma_3 = -\sigma_4$. This is obviously an effect that can not occur in the case of identical particles discussed in Ref. [1]. We also notice that in this case $\omega_\tau^s(L)$ does not depend on Φ_D and $\omega_\tau^e(L)/\omega_\tau^s(L)$ always converges to 2 in the limit $L \rightarrow \infty$.

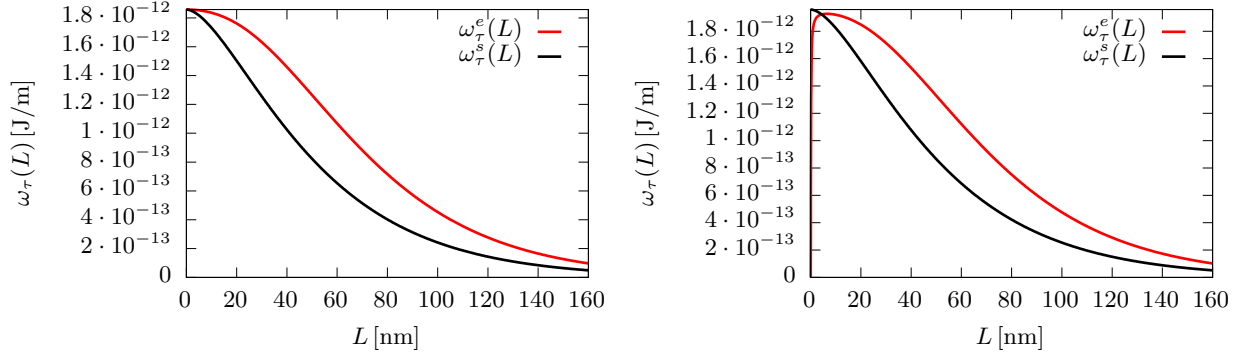


Figure IV.29: $\omega_\tau(L)$ for $\sigma_1 = 0.02 \text{ e/nm}^2$, $\sigma_2 = -0.02 \text{ e/nm}^2$, $\sigma_3 = 0.002 \text{ e/nm}^2$, $\sigma_4 = -0.002 \text{ e/nm}^2$ (left) and $\sigma_1 = 0.02 \text{ e/nm}^2$, $\sigma_2 = -0.02 \text{ e/nm}^2$, $\sigma_3 = 0.0021 \text{ e/nm}^2$, $\sigma_4 = -0.002 \text{ e/nm}^2$ (right)

In Fig. IV.29 we see such a converging case on the left side. On the right side, we see the behaviour for a small deviation in σ_3 from the previous case.

All these cases have the usual exponential decay in the asymptotic limit $L \rightarrow \infty$.

16.3.10 Zero Charges

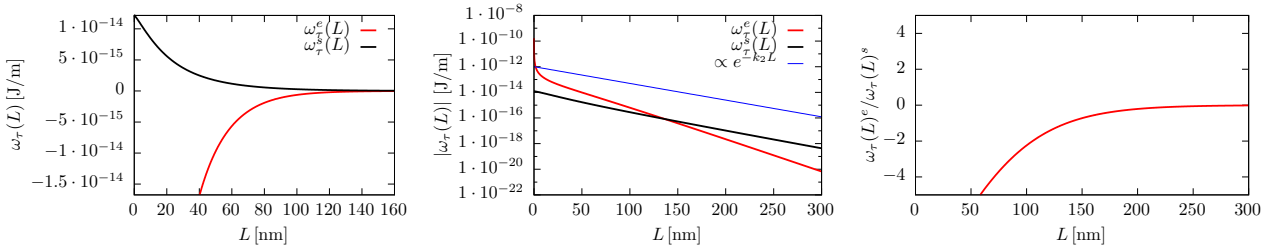


Figure IV.30: $\omega_\tau(L)$ for $\sigma_1 = 0.02 \text{ e/nm}^2$, $\sigma_2 = 0$, $\sigma_3 = 0.0004 \text{ e/nm}^2$, $\sigma_4 = 0$

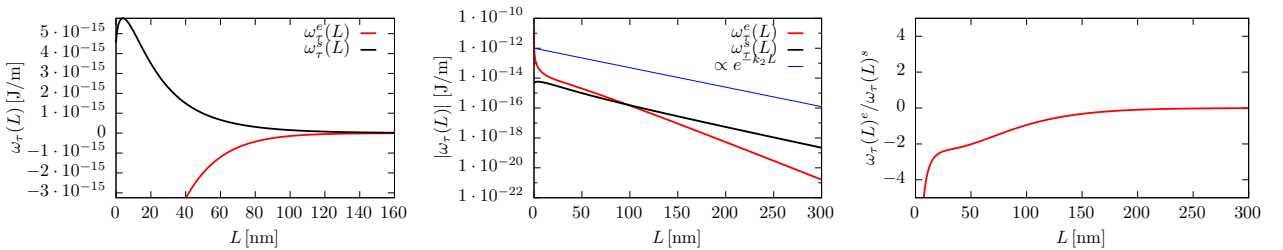


Figure IV.31: $\omega_\tau(L)$ for $\sigma_1 = 0$, $\sigma_2 = 0.03 \text{ e/nm}^2$, $\sigma_3 = 0$, $\sigma_4 = 0.0002 \text{ e/nm}^2$

If only one wall is charged, then we have an exponential decrease in the exact solution with exponent $-2\kappa_2 L$, as seen in Figs. IV.30 and IV.31. This is again a finite size effect, because the relevant distance of interaction is now twice as long. The superposition solution can of course not show a finite size effect and still shows an exponential decrease with exponent $-\kappa_2 L$ if $\Phi_D \neq 0$. If Φ_D is zero then the superposition solution is a constant zero, as can be seen from Eq. (IV.6).

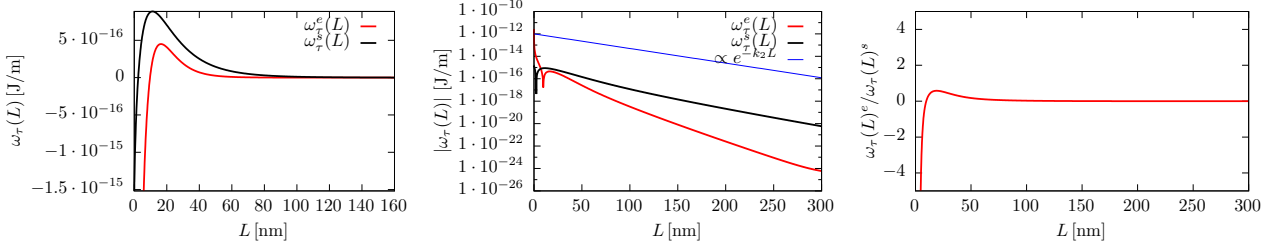


Figure IV.32: $\omega_\tau(L)$ for $\sigma_1 = 0.02 \text{ e/nm}^2$, $\sigma_2 = 0$, $\sigma_3 = 0$, $\sigma_4 = 0$

The same behaviour can be seen even if only one of the four wall parts is changed, and even if the charged wall is not on the side of the medium with the smaller κ , as can be seen in Fig. IV.32.

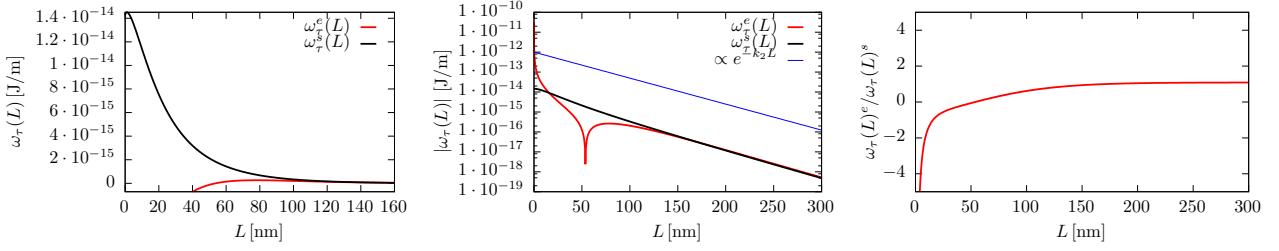


Figure IV.33: $\omega_\tau(L)$ for $\sigma_1 = 0.02 \text{ e/nm}^2$, $\sigma_2 = 0$, $\sigma_3 = 0$, $\sigma_4 = 0.0002 \text{ e/nm}^2$

The same finite size effect does not occur if the charged walls are diagonally aligned, as can be seen in Fig. IV.33. In this case a zero Φ_D leads to a convergence of $\frac{\omega_\tau^c(L)}{\omega_\tau^s(L)}$ to two, similar to the behaviour presented in 16.3.6.

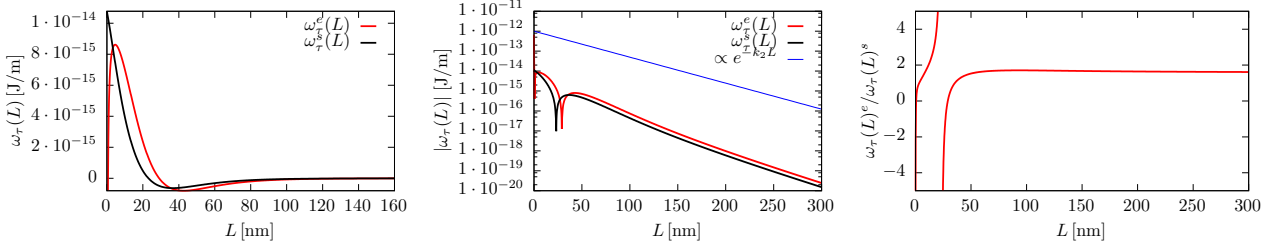


Figure IV.34: $\omega_\tau(L)$ for $\sigma_1 = 0.02 \text{ e/nm}^2$, $\sigma_2 = -0.03 \text{ e/nm}^2$, $\sigma_3 = 0$, $\sigma_4 = 0$

Since $\omega_\tau^s(L)$ changes sign around $\simeq 30 \text{ nm}$ we see a discontinuity in the plot of $\omega_\tau^c(L)/\omega_\tau^s(L)$ at that position.

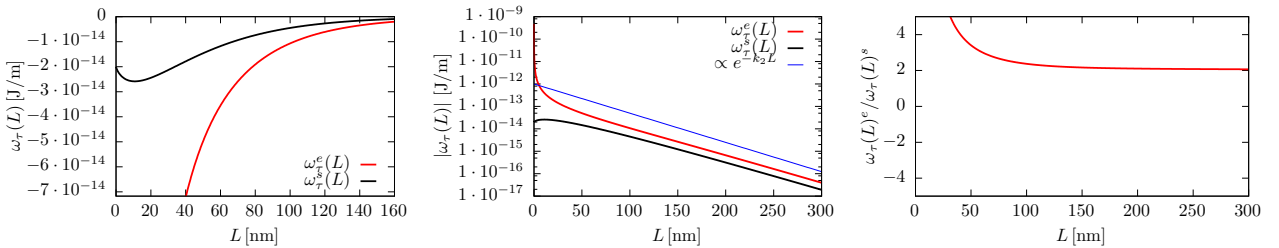


Figure IV.35: $\omega_\tau(L)$ for $\sigma_1 = 0$, $\sigma_2 = 0$, $\sigma_3 = 0.0004 \text{ e/nm}^2$, $\sigma_4 = 0.0002 \text{ e/nm}^2$

The cases where the only the walls touching one of the media are charged show no significantly different behaviour than the previous case, as can be seen in Fig. IV.34 and IV.35.

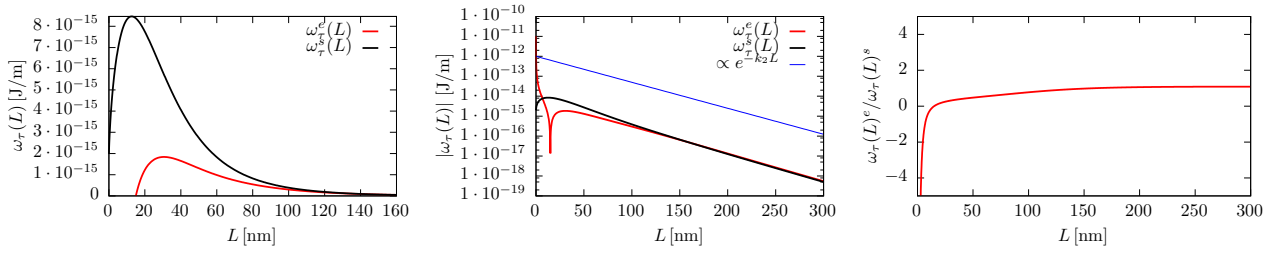


Figure IV.36: $\omega_\tau(L)$ for $\sigma_1 = 0.02 \text{ e/nm}^2$, $\sigma_2 = 0.03 \text{ e/nm}^2$, $\sigma_3 = 0$, $\sigma_4 = 0.0002 \text{ e/nm}^2$

Even the case with just one zero charge in Fig. IV.36 shows behaviour similar to the previous cases in $\frac{\omega_\tau^c(L)}{\omega_\tau^s(L)}$.

Chapter V

Conclusion

In summary, using a simplified model system with parallel plates in contact with two immiscible fluids, we have derived analytical expressions for surface and line interaction energies exactly as well as under the superposition approximation. Our results can be used to calculate the interaction between closely separated, not too strongly charged particles trapped at an electrolyte interface. We consider a general situation where the particles and therefore, the plates of our model system are not identical. As a result, they can carry different charge densities even when in contact with the same liquid. Our results clearly show a rich behaviour concerning both the surface and the line interaction energies that can not be seen for identical particles.

Surface interaction The exact solution for surface interaction $\omega_{\gamma,i}^e(L)$ ($i \in \{1,2\}$) can be non-monotonic and can have a minimum. The superposition solution always converges for $L \rightarrow 0$, but the exact solution only converges if and only if the charges are of opposite sign and equal magnitude. Otherwise the exact solution diverges against (positive) infinity. Furthermore, the exact solution can have qualitatively different asymptotic behaviour from the superposition solution $\omega_{\gamma,i}^s(L)$. In case only one of the walls is charged, the superposition solution predicts a zero surface interaction energy, while the exact solution predicts a nonzero energy that decays as $\mathcal{O}(e^{-2\kappa_i L})$ for $L \rightarrow \infty$. In the cases where both walls are charged both the exact solution and the superposition approximation decays as $\mathcal{O}(e^{-\kappa_i L})$, but we still see a factor of two asymptotically in the ratio $\omega_{\gamma,i}^e(L)/\omega_{\gamma,i}^s(L)$. The factor of two is thus not a result of the symmetry of charges in Ref. [1].

Line interaction Both the exact and the superposition solution for the line interaction can show non-monotonic behaviour and can show minima and maxima depending upon the parameters of the system. The exact solution does not depend on the Donnan potential Φ_D , while the superposition solution generally does. The superposition solution always converges for $L \rightarrow 0$, while the exact solution usually diverges against negative infinity. If $(\sigma_1 = -\sigma_2$ and $\sigma_3 = -\sigma_4)$ or $(\kappa_1 = \kappa_2$ and $\varepsilon_1 = \varepsilon_2$ and $\sigma_1 + \sigma_2 = \sigma_3 + \sigma_4)$ the exact solution does converge for $L \rightarrow 0$. In these cases the superposition solution does not depend on Φ_D . If $\kappa_1 = \kappa_2$, $\varepsilon_1 = \varepsilon_2$, $\sigma_1 = \sigma_3$ and $\sigma_2 = \sigma_4$ there is no three-phase contact line and both exact and superposition solution are constantly zero, as expected. In the cases where both walls have a charge both the exact solution and the superposition approximation asymptotically (for $L \rightarrow \infty$) decay exponentially with the smaller of the two inverse Debye lengths, which we will denote with $\kappa_i = \min\{\kappa_1, \kappa_2\}$ for the remainder of this paragraph. So, if both walls are charged, which is true for most cases, both exact and superposition solution are of order $\mathcal{O}(e^{-\kappa_i L})$. If Φ_D is zero the ratio $\omega_{\tau}^e(L)/\omega_{\tau}^s(L)$ converges to two in these cases and if Φ_D is nonzero we usually see increasingly different behaviour with increasing Φ_D . However, if only one of the walls is charged, the exact solution has qualitatively different asymptotic behaviour from the superposition solution: In case only one of the walls is charged, the superposition solution predicts a zero line interaction energy if Φ_D is zero and a line interaction energy in $\mathcal{O}(e^{-\kappa_i L})$ otherwise, while the exact solution always predicts a nonzero energy that is in $\mathcal{O}(e^{-2\kappa_i L})$. In these cases $\omega_{\tau}^e(L)/\omega_{\tau}^s(L)$ therefore converges to zero if Φ_D is non-zero and is undefined otherwise.

Possible topics of interest beyond the scope of this work:

- It would be interesting to compare the this linear model of nonidentical particles with a non-linear numerical model.
- It would be interesting to compare our solutions with a superposition solution derived from using the spherical solution for one particle from Ref. [17].
- An analytic discussion of the line interaction would be desirable.

Bibliography

- [1] Electrostatic interaction between colloidal particles trapped at an electrolyte interface
A. Majee, M. Bier, and S. Dietrich, *J. Chem. Phys.* **140**, 164906 (2014).
- [2] Separation of Solids in the Surface-Layers of Solutions and 'Suspensions' (Observations on Surface-Membranes, Bubbles, Emulsions, and Mechanical Coagulation).
W. Ramsden
Proc. R. Soc. London **72**, 156 (1903).
- [3] Food Colloids - An Overview
E. Dickinson
Colloids Surf. **42**, 191 (1989).
- [4] The effect of Colloidal Particles on Fluid-Fluid Interfacial properties and Emulsion Stability
D. E. Tambe and M. M. Sharma
Adv. Colloid Interface Sci. **52**, 1 (1994).
- [5] Colloidal Particles at Liquid Interfaces
P.B. Binks and T. S. Horozov
Cambridge University Press, Cambridge 2006
- [6] Image Charge Effects on the Formation of Pickering Emulsions
H. Wang, V. Singh, S. H. Behrens
J. Phys. Chem. Lett. **3**, 2986 (2012).
- [7] Two-Dimensional Interfacial Colloidal Crystals
P. Piranski
Phys. Rev. Lett. **45**, 569 (1980).
- [8] The electrostatic interaction between interfacial colloidal particles
A. J. Hurd
J. Phys. A **18**, L1055 (1985).
- [9] Direct Measurements of the Effects of Salt and Surfactant on Interaction Forces between Colloidal Particles at Water-Oil Interfaces
B. J. Park, J. P. Pantina, E. M. Furst, M. Oettel, S. Reynaert, and J. Vermant
Langmuir **24**, 1686 (2008).
- [10] Compression and Structure of Monolayers of Charged Latex Particles at Air/Water and Octane/Water Interfaces
R. Aveyard, J. H. Clint, D. Nees, and V. N. Paunov
Langmuir **16**, 1969 (2000).
- [11] Measurement of Long-Range Repulsive Forces between Charged Particles at an Oil-Water Interface
R. Aveyard, B. P. Binks, J. H. Clint, P. D. I. Fletcher, T. S. Horozov, B. Neumann, V. N. Paunov
Phys. Rev. Lett. **88**, 246102 (2002).
- [12] Self-assembly of nanomaterials at Fluid interfaces
A. Toor, T. Feng, and T. P. Russel
Eur. Phys. J. E **39**, 57 (2016).
- [13] Novel Stabilization of Emulsions via the Heteroaggregation of Nanoparticles
B. P. Binks, W. Liu, J. A. Rodrigues
Langmuir **24**, 4443 (2008)

- [14] Stabilization of emulsions by heterocoagulation of clay minerals and layered double hydroxides
S. Abend, N. Bonnke, U. Gutschner, and G. Lagaly
Colloid Poly. Sci. **276**, 730 (1998).
- [15] Stabilization of Pickering Emulsions with Oppositely charged Latex Particles:
Influence of Various Parameters and Particle Arrangement around droplets
T. Nallamilli, B. P. Binks, E. Mani, M. G. Basavaraj
Langmuir **31**, 11200 (2015)
- [16] Pickering emulsions stabilized by oppositely charged colloids: Stability and pattern formation
S. D. C. Pushpam, M. G. Basavaraj, E. Mani
Phys. Rev. E **92**, 052314 (2015).
- [17] Multipole expansion of the electrostatic interaction between charged colloids at interfaces
A. Dominguez, D. Frydel, M. Oettel
Phys. Rev. E **77**, 020401(R) (2008).
- [18] Lecture Notes (German) Physik der Flüssigkeiten
Kap. 2-4
M. Bier
<https://www.is.mpg.de/dietrich/lehre/PdF>
- [19] Lecture Notes (German) Physik der Flüssigkeiten
Kap. 8, 9
M. Bier
<https://www.is.mpg.de/dietrich/lehre/PdF>
- [20] Electrostatic interaction between colloidal particles trapped at an electrolyte interface:
Supplementary Material
A. Majee, M. Bier, and S. Dietrich
<http://dx.doi.org/10.1063/1.4872240>
- [21] Poisson-Boltzmann study of the effective electrostatic interaction between colloids at an electrolyte surface
A. Majee, M. Bier, and S. Dietrich, J. Chem. Phys. **145**, 064707 (2016).
- [22] Table of Integral, Series and Products
I. S. Gradshteyn and I. M. Ryzhik
- [23] Colloidal Dispersions
W. Russel, D. Saville, W. Schowalter
Cambridge University Press, Cambridge 1989
- [24] Fundamentals of Electrochemistry
V. S. Bagotsky
Wiley, Hoboken, NJ 2006

Acknowledgment

First and foremost, I want to thank my supervisor Arghya Majee for his guidance, assistance, a lot of helpful suggestions and corrections without whom this work would be a lot more taciturn.

Furthermore, I want to thank Markus Bier for the admission at the Max Planck Institute, helpful discussions and support in all official matters.

I also want to thank the staff of the Max Planck Institute and department Dietrich for providing me with a nice and friendly work environment.

And last but not least I want to thank my family for their support.

Official statement

Hiermit erkläre ich, Timo Schmetzer,

- dass ich die vorliegende Arbeit selbstständig verfasst habe
- dass ich keine anderen als die angegebenen Quellen benutze und alle wörtlich oder sinngemäß aus anderen Werken übernommenen Aussagen als solche gekennzeichnet habe
- dass die eingereichte Arbeit weder vollständig noch in wesentlichen Teilen Gegenstand eines anderen Prüfungsverfahrens gewesen ist,
- dass ich die Arbeit weder vollständig noch in Teilen bereits veröffentlicht habe
- und dass der Inhalt des elektronischen Exemplars mit dem des Druckexemplars übereinstimmt.

Timo Schmetzer