

Computationally Efficient Nonlinear Bell Inequalities for General Quantum Networks

Ming-Xing Luo

¹*Information Security and National Computing Grid Laboratory,
Southwest Jiaotong University, Chengdu 610031, China*

²*CSNMT, International Cooperation Research Center of China, Chengdu 610031, China*

³*Department of Physics, University of Michigan, Ann Arbor, MI 48109, USA*

The correlations in quantum networks have attracted strong interest with new types of violations of the locality. The standard Bell inequalities cannot characterize these multipartite correlations, which are generated by multiple sources. The main problem is that no computationally efficient method is available for constructing useful Bell inequalities for any quantum network. In this work, we show a significant improvement by presenting new, explicit Bell-type inequalities for general networks including cyclic networks. These nonlinear inequalities are related to the matching problem of an equivalent unweighted bipartite graph which allows constructing a polynomial-time algorithm. For any bipartite entangled pure states and Greenberger-Horne-Zeilinger (GHZ) states as quantum resources, we prove the generic non-multilocality of quantum networks with multiple independent observers using the new Bell inequalities. The violations are maximal with respect to the presented Tsirelson's bound for the maximally entangled Einstein-Podolsky-Rosen (EPR) states and GHZ states. Moreover, these violations hold for Werner states or some general noisy states. Our results suggest that the new Bell inequalities can be used to characterize experimental quantum networks.

Introduction

Bell's well-known theorem [1] states that the predictions of quantum mechanics are inconsistent with classical causal relations that originate from a common local hidden variable (LHV). Specifically, the correlation between the outcomes of local measurements on a remotely shared entanglement cannot be described by a locally causal model. The study of quantum nonlocality has stimulated both remarkable developments in quantum theory [2-5] and potential applications [6-10].

Quantum nonlocality has been significantly generalized by considering complex causal structures beyond the standard LHV models [11-17]. These improvements aim to provide a rigorous theoretical framework of causal relations and structures [3,18-20] and are useful for deriving similar linear Bell inequalities [2-5,9,21]. In theory, these inequalities are derived from networks of a single source. Nonetheless, for general networks, there are various independent sources to distribute hidden states to space-like separated parties in terms of the generalized locally causal model (GLCM) [3,18-20]. As reasonable extensions of a single source, the correlations should be defined using multiple sources. Meanwhile, a useful Bell-type inequality enables the characterization of these correlations across the entire network. How to feature and verify the nonlocality of multipartite correlations not only are theoretically important to prove the supremacy [10], but also are experimentally challenging in the implementation of quantum networks [22,23] and quantum repeaters [24].

Unfortunately, the standard Bell inequalities derived from a single source are useless for characterizing the correlations of general quantum networks. Recently, for the simplest network of entanglement swapping with two shared entangled states, new nonlinear Bell inequalities have been proposed to verify the non-bilocality of tripartite correlations [12,25-27]. It is then extended for a general star-shaped network with multiple parties [28]. For a small-sized general network, computational algebraic method [29] or the linear programming technique provides a reasonable route to explore polynomial Bell inequalities [30]. Another method is to iteratively expand a given network to the desired network by adding independent sources [31]. Despite these advances, no computationally efficient method is available to feature general quantum networks. Additionally, the nonlinear Bell inequalities imply that some projection subspaces of the multipartite correlation space are not convex [25,29-32], which reveal new features beyond the correlation polytopes bounded by linear Bell inequalities [1-5]. A natural problem is whether these characteristics are typical for quantum networks. One of our goals is to address this problem. Certain quantum networks have been experimentally realized using different physical systems to verify the nonlocality [33-36].

In this work, we propose simple and efficient nonlinear Bell inequalities to characterize the multipartite correlations of a general quantum network in terms of the GLCM [17-20]. Notably, our approach depends primarily on the maximal matching problem of the equivalent unweighted bipartite graph [37], which allows constructing new Bell inequalities within polynomial time complexity. We further prove that the multipartite correlations violate the presented nonlinear inequalities for all finite-size quantum networks with multiple observers who have not shared quantum resources. The violation holds for any bipartite entangled pure states and Greenberger-Horne-Zeilinger (GHZ) states as quantum resources, and are maximal with respect to the presented Tsirelson's bound of Hermitian operators. The generic non-multilocality is different from the nonlocality of a single entanglement using the linear Bell inequality [38,39] or

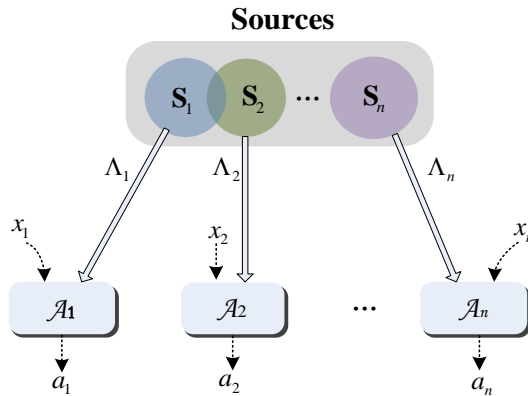

FIG. 1: (Color online) Schematic network in terms of the GLCM. There are m independent sources S_1, S_2, \dots, S_m , which are used to distribute the hidden states $\lambda_1, \lambda_2, \dots, \lambda_m$, respectively. Each party \mathcal{A}_i receives hidden states $\Lambda_i = \{\lambda_{j_1}, \lambda_{j_2}, \dots, \lambda_{j_{\ell_i}}\}$ distributed by the corresponding sources $S_i = \{S_{j_1}, S_{j_2}, \dots, S_{j_{\ell_i}}\}$, where $\cup_{i=1}^n S_i = \{S_1, S_2, \dots, S_m\}$. In the experiment, each party \mathcal{A}_i obtains one bit output a_i , which depends on the input bit x_i and hidden states Λ_i , $i = 1, 2, \dots, n$.

CHSH inequality [40,41]. Finally, we evaluate the critical visibilities of Werner states and general noisy states for which the non-multilocality is also true [30-32]. Remarkably, our result holds for lots of cyclic networks which have not been investigated [24,27-32]. The simplicity of the presented Bell inequalities makes them useful for experimental quantum networks.

Results

Multilocality structure of a network. In what follows, we consider the simplest scenario of dichotomic inputs and outputs for all parties.

Inspired from Bell inequalities of two parties [1], the multilocality of correlations of a network follows from the GLCM [3,18-20]. Formally, all systems measured in the experiment are considered to be in the hidden states of $\Lambda = (\lambda_1, \lambda_2, \dots, \lambda_m)$, where Λ is arbitrary and could exist prior to the measurement choices, and m is the number of hidden states. The dichotomic output a_i of any particular system can arbitrarily depend on the global state Λ and the type of measurement but not on the measurements performed on systems (here, one bit x_j denotes the type of measurement). Thus, the GLCM suggests a general representation of the probabilities of the measurement outcome or correlations as

$$P(\mathbf{a}|\mathbf{x}) = \int \cdots \int d\Lambda p(\Lambda) \prod_{i=1}^n P(a_i|x_i, \Lambda), \quad (1)$$

where $\mathbf{a} = (a_1, a_2, \dots, a_n)$ and $\mathbf{x} = (x_1, x_2, \dots, x_n)$, $a_i, x_i \in \{0, 1\}$. Here, $p(\Lambda)$ is the joint distribution of Λ with the normalization condition $\int \cdots \int p(\Lambda) d\Lambda = 1$; $P(a_i|x_i, \Lambda)$ is the conditional probability of outcome a_i for the i -th party with the knowledge of x_i and Λ ; and n is the number of space-like separated parties.

Now, we consider a general network of finite size shown in Fig.1 in terms of the GLCM. Assume that there are m sources S_1, S_2, \dots, S_m , which are used to distribute the corresponding hidden states $\lambda_1, \lambda_2, \dots, \lambda_m$. Each party (or observer in quantum mechanics) \mathcal{A}_i receives some hidden states $\Lambda_i = \{\lambda_{j_1}, \lambda_{j_2}, \dots, \lambda_{j_{\ell_i}}\}$ from the corresponding sources $S_i = \{S_{j_1}, S_{j_2}, \dots, S_{j_{\ell_i}}\}$, where $\cup_{i=1}^n S_i = \{S_1, S_2, \dots, S_m\}$. By combining all dependent sources into one source, we suppose that all sources are independent. The joint probability distribution of hidden states has the form $p(\Lambda) = \prod_{i=1}^m p_i(\lambda_i)$, where $p_i(\lambda_i)$ is the probability distribution of λ_i with the normalization condition $\int p_i(\lambda_i) d\lambda_i = 1$, $i = 1, 2, \dots, m$. Eq.(1) can be rewritten as

$$P(\mathbf{a}|\mathbf{x}) = \int \cdots \int d\Lambda \prod_{i=1}^m p_i(\lambda_i) \prod_{j=1}^n P(a_j|x_j, \Lambda_j). \quad (2)$$

In the case of $m = 1$, Eq.(2) reduces to the locality assumption of one source and geometrically defines a correlation polytope, which contains all LHV distributions inside with the linear Bell inequalities as facets [1,18-20]. This fact is

not true for $m \geq 2$. In particular, for the standard entanglement swapping [12], two hidden states enable a non-convex correlation polytope [24]. For some special cases of $m > 2$, the correlation polytopes may be elucidated by exploring new Bell-type inequalities according to the acyclic graph approach [42,29], the linear programming technique [30,43,44] or the expansion method [31].

Explicit nonlinear Bell inequalities for general networks. Our method is based on geometric features of a general network. A network is called k -independent if there are k parties without sharing independent sources. Geometrically, no incoming edges of the independent parties share a vertex in Fig.1. The independence of a network is equivalent to the following k -locality condition in terms of the GLCM: there are k subsets $\Lambda_{i_1}, \Lambda_{i_2}, \dots, \Lambda_{i_k}$ of hidden states such that

$$\begin{cases} \cup_{j=1}^k \Lambda_{i_j} \subseteq \Lambda, \\ \Lambda_{i_s} \cap \Lambda_{i_t} = \emptyset \text{ for } 1 \leq s < t \leq k. \end{cases} \quad (3)$$

Denote integer sets $\mathcal{I} = \{i_1, i_2, \dots, i_k\}$ and $\bar{\mathcal{I}} = \{1, 2, \dots, n\} / \{i_1, i_2, \dots, i_k\}$. Let A_{x_j} be the measurement operator of party $\mathcal{A}_j, j = 1, 2, \dots, n$. With given measurements of all parties $\mathcal{A}_j, j \in \bar{\mathcal{I}}$, we define the quantity $I_{n,k}$ of multipartite correlations for the network in Fig.1 as

$$I_{n,k} = \frac{1}{2^k} \sum_{x_i, i \in \mathcal{I}} \langle A_{x_1} A_{x_2} \cdots A_{x_n} \rangle, \quad (4)$$

where $\langle A_{x_1} A_{x_2} \cdots A_{x_n} \rangle = \sum_{\mathbf{a}} (-1)^{\sum_{i=1}^n a_i} P(\mathbf{a}|\mathbf{x})$ and $P(\mathbf{a}|\mathbf{x})$ are defined in Eq.(2). Similarly, with the other measurements of all parties \mathcal{A}_j with $j \in \bar{\mathcal{I}}$, we define the quantity $J_{n,k}$ of multipartite correlations as

$$J_{n,k} = \frac{1}{2^k} \sum_{x_i, i \in \mathcal{I}} (-1)^{\sum_{j \in \bar{\mathcal{I}}} x_j} \langle A_{x_1} A_{x_2} \cdots A_{x_n} \rangle. \quad (5)$$

One of the main results is that the following nonlinear inequality holds (Appendix A1):

$$|I_{n,k}|^{\frac{1}{k}} + |J_{n,k}|^{\frac{1}{k}} \leq 1, \quad (6)$$

when the network satisfies the k -independent condition or the equivalent k -locality.

For the quantum network of Fig.1, consider the quantum mechanical correlations between space-like separated observers. Assume that there are 2^n Hermitian observables $\mathbf{A}_{x_1}, \mathbf{A}_{x_2}, \dots, \mathbf{A}_{x_n}$ with $x_i \in \{0, 1\}$, where two observables \mathbf{A}_{x_i} ($x_i = 0, 1$) with outcomes ± 1 are defined for the observer $\mathcal{A}_i, i = 1, 2, \dots, n$. The second results is the following Cirel'son bound [45] (also written Tsirelson bound [46], Appendix A2)

$$|I_{n,k}^q|^{\frac{1}{k}} + |J_{n,k}^q|^{\frac{1}{k}} \leq \sqrt{2}, \quad (7)$$

when the quantum network has k independent observers without sharing quantum resources, where the quantities $I_{n,k}^q$ and $J_{n,k}^q$ are distinguished from those derived from the generalized locally causal model.

For a given network, there may be different subsets of hidden states that satisfy the k -locality condition in Eq.(3). Thus, various inequalities may be derived from different $I_{n,k}$ and $J_{n,k}$. The inequality in Eq.(6) reduces to linear Bell inequality [41] when $k = 1$. Generally, k is determined by the network topology. Intuitively, a larger k implies a tighter polytope for a given network because more multipartite correlations are involved in quantities $I_{n,k}$ and $J_{n,k}$ in Eq.(6). Thus, it is reasonable to find the maximum k and the corresponding independent parties. Unfortunately, the maximum k_{\max} is equivalent to the integer optimization problem, which is generally NP-hard (Appendix B1). In spite of that, an analytical method exists for some networks with simple features (see Fig.3). This suggests a great improvement to special networks [12,25-28,32]. For a general network, it is possible to find a suboptimal k as an alternative. Notably, the problem can be reduced to the maximal matching of an equivalent unweighted bipartite graph (Appendix B2), for which Hopcroft and Karp provided a polynomial algorithm to find the maximal matching [47-49]. Each maximal matching may imply a suboptimal k that always admits a useful inequality if $k \geq 2$.

The operator inequality in Eq.(7) provides a tight bound for the correlations of quantum networks. Although the upper bound is theoretically different from that in Eq.(6) for classical network in terms of the GLCM, it is difficult to verify for any quantum networks. Our following applications are to partially address this problem.

Generic non-multilocality of quantum networks with independent observers. The prediction of the quantum theory is incompatible with the local realism model [1]. This feature is generic for any entangled state of two spin- $\frac{1}{2}$ particles [38,39]. A similar result holds for any multipartite entangled states [40] by using the CHSH inequality [41]. A natural question is whether the inconsistency is typical for quantum networks. We aim to answer

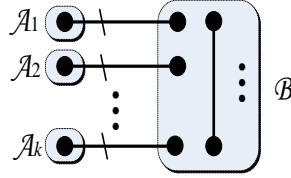

FIG. 2: (Color online) Schematic quantum network with k independent observers without sharing quantum resources. Each pair of observers \mathcal{A}_i and \mathcal{B} share some quantum resources of bipartite entangled pure states and GHZ states, $i = 1, 2, \dots, k$. The observer \mathcal{B} may have some quantum resources that are not shared with all the observers \mathcal{A}_i . Here, \mathcal{A}_i and \mathcal{A}_j have no shared entanglements for $i \neq j, i, j = 1, 2, \dots, k$.

the question for the networks consisting of bipartite entangled pure states (including Einstein-Podolsky-Rosen (EPR) states [50]) and GHZ states [51] using the inequality in Eq.(6). Consider a quantum network $G_q = (V, E)$ of finite size, where V denotes all particles, and E denotes all edges (two particles are connected by one edge if they are entangled). An equivalent quantum network in Fig.2 exists when there are $k \geq 2$ independent observers $\mathcal{A}_1, \mathcal{A}_2, \dots, \mathcal{A}_k$ (without sharing quantum resources). \mathcal{B} denotes other observers in G_q except for $\mathcal{A}_1, \mathcal{A}_2, \dots, \text{for } \mathcal{A}_k$. For each equivalent network, we prove that the multipartite quantum correlations of G_q violate the multilocality inequality in Eq.(6) for bipartite entangled pure states and GHZ states. It is formally stated as follows:

Theorem A.-For any quantum network G_q consisting of bipartite entangled pure states and GHZ states, assume that there are $k \geq 2$ independent observers. Then the following results hold:

- (1) A set of observables exists for all observers such that the multipartite quantum correlations are inconsistent with generalized local realism;
- (2) A set of observables exists for all observers such that the violation of the presented Bell inequality in Eq.(6) is maximal if and only if the maximally entangled EPR states and GHZ states are consisted of quantum resources.

Different from previous Bell inequalities for the star-shaped network consisting of EPR states [12,25,28,32], Theorem A shows that the presented inequalities in Eq.(6) are useful for almost all acyclic or cyclic networks consisting of EPR states and GHZ states. Furthermore, if the Werner states are used as quantum resources, we can evaluate the critical viabilities as follows:

Theorem B.-Assume that a quantum network G_q with $k \geq 2$ independent observers consists of Werner states: $\rho = \otimes_{i=1}^{m_1} \otimes_{j=1}^{m_2} (v_i |\Phi_i\rangle\langle\Phi_i| + \frac{1-v_i}{4} \mathbf{I}_4) \otimes (w_j |\Psi_j\rangle\langle\Psi_j| + \frac{1-w_j}{2^{s_j}} \mathbf{I}_{2^{s_j}})$, where m_1 and m_2 denote the numbers of the respective EPR states and GHZ states. Then the product of critical viabilities v_j^*, w_j^* is given by

$$\prod_{i=1}^{m_1} \prod_{j=1}^{m_2} v_i^* w_j^* = \frac{1}{(1 + \prod_{i=1}^{m_1} \prod_{j=1}^{m_2} (4a_i b_i \hat{a}_j \hat{b}_j)^{\frac{2}{k}})^{\frac{k}{2}}} \quad (8)$$

for which the multipartite correlations violate the inequality in Eq.(6), where $|\Phi_i\rangle = a_i|00\rangle + b_i|11\rangle$ are EPR states, $|\Psi_j\rangle = \hat{a}_j|0\rangle^{\otimes s_j} + \hat{b}_j|1\rangle^{\otimes s_j}$ are GHZ states of s_j particles, $\mathbf{I}_{2^{s_j}}$ is the 2^{s_j} square identity matrix, $s_j \geq 3$, and $0 \leq v_i, w_j \leq 1$.

Those results hold for any integer k satisfying $2 \leq k \leq k_{\max}$. Thus, various violations exist for the same quantum network. The relationships of different violations may provide insights of the supremacy derived from quantum networks [8,10] and are valuable for further explorations.

The main idea of the proofs is to construct proper observables for all observers [39,40]. For EPR states, these observables are dependent on specific parameters (Appendix C1). In addition, all observables of the network in Fig.2 should be equivalently defined for all observers of the original network G_q . Thus, $I_{k+1,k}$ and $J_{k+1,k}$ derived from the network in Fig.2 are essentially linear combinations of multi-partite correlations generated by all observers of G_q . A similar procedure holds for any bipartite entangled pure states (Appendix C2) or hybrid systems combined with GHZ states (Appendix C3). In particular, with these observables, the maximal violations with respect to Tsirelson's bound in Eq.(7) exist for the maximally entangled EPR states and GHZ states (Appendix C4). For the unknown EPR states and GHZ states, our proof enables us to probabilistically verify the violations (Appendix C5). The product of visibilities of noisy EPR states and GHZ states is easily obtained (Appendix D).

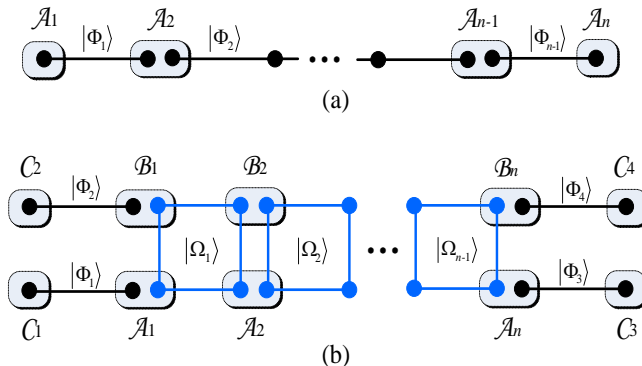

FIG. 3: (Color online) (a) Chain-shaped network of the long-distance entanglement distribution. All observers $\mathcal{A}_2, \dots, \mathcal{A}_{n-1}$ jointly distribute an EPR state to two observers \mathcal{A}_1 and \mathcal{A}_n with EPR states as quantum resources. (b) The hybrid star-shaped network. All observers $\mathcal{B}_i, \mathcal{C}_i$ jointly distribute a four-partite GHZ state to the observers \mathcal{A}_j with EPR states and four-partite GHZ states as quantum resources. (c) cyclic network with EPR states as quantum resources.

Examples

Chain-shaped network.—The tripartite correlations of the standard quantum entanglement swapping violate the inequality in Eq.(6) with $n = 3$ and $k = 2$ [12,25,32]. The long-distance entanglement distributing generates a chain-shaped network in Fig.3(a). Theorem A shows that the multipartite quantum correlations violate the k -locality inequality in Eq.(6) for any EPR states as quantum resources, where $k = \lceil \frac{n}{2} \rceil$ denotes the number of observers without sharing quantum resources, and $\lceil x \rceil$ denotes the smallest integer no less than x . From Tsirelson's bound in Eq.(7), the maximal violation exists for the maximally entangled EPR states. This answers a conjecture [25] and may beyond the violation [31]. For Werner states, the product of the critical visibilities is no less than the product of the visibility of each EPR state (Appendix E).

Hybrid star-shaped network.—Unlike the star-shaped network [12,25,32], the new network in Fig.3(b) consists of EPR states and four-partite GHZ states. Theorem A implies that the multipartite quantum correlations violate the k -locality inequality in Eq.(6) with $k = 4 + \lfloor \frac{n-1}{2} \rfloor$ for all EPR states and four-partite GHZ states, where $\lfloor x \rfloor$ denotes the maximal integer no more than x . This violation is maximal with respect to Tsirelson's bound in Eq.(7) for the maximal entanglements. A similar result holds for the noisy channels of Werner states from Theorem B. Notably, Scarani and Gisin [52] showed some partially entangled GHZ states do not violate some linear Bell inequalities [53-55]. Nevertheless, all GHZ states of even n particles violate another Bell inequality [56]. Our example and Theorem A go beyond these results in the case of the multilocality using the inequality in Eq.(6).

Cyclic network.—Consider a cyclic network in Fig.3(c) with EPR states as quantum resources. Theorem A shows that the multipartite quantum correlations violate the $\lfloor \frac{n}{2} \rfloor$ -locality inequality in Eq.(6) for any EPR states when $n \geq 4$. It is also maximal from Tsirelson's bound in Eq.(7) for the maximally entangled EPR states. A similar result holds for Werner states from Theorem B. This is the first example of the nontrivial cyclic network discussed so far, for others see Appendix F.

Discussion

For general noisy resources beyond Werner states, we provide one sufficient condition of the violation of the multilocality (Appendix G). Our condition only may be easily verified in applications. Further investigations are valuable for the non-multilocality and the entanglement witness [57]. When multiple outputs or high-dimensional resources are considered, the linear method [25] may be inefficient to characterize all multipartite quantum correlations [58]. The general representations of quantities are related to the famous conjecture of the Hadamard matrix [59]. This raises three interesting problems: (1) how to characterize the common features of these networks; (2) how to explore new Bell inequalities for these networks; (3) how to characterize cyclic quantum network [25-32] (Appendix H).

In addition to interesting applications such as randomness amplification, interactive proofs and quantum games [6-10], quantum networks allow multipartite tasks. One notable problem is to address the supremacy of quantum networks in the case of multipartite interactive proofs or computational complexities. Its improvement may provide further relevance of quantum networks and classical problems. Moreover, the generic non-multilocality of special

networks with hybrid entanglements would be fruitful for investigation because of the impossibility of classifying multipartite entanglements.

In conclusion, we presented explicit nonlinear Bell-inequalities for general networks with independent sources. These inequalities are computationally efficient and are used to prove the generic non-multilocality of quantum networks with independent observers. This result holds for any bipartite entangled pure states and GHZ states as quantum resources. The violations are maximal with respect to Tsirelson's bound for the maximally entangled EPR states and GHZ states. Furthermore, the visibilities are presented for Werner states or general noisy states. These results may stimulate investigators to employ the non-multilocality for quantum information processing or quantum Internet.

Acknowledgements

We thank the helpful discussions of Luming Duan, Yaoyun Shi, M. Orgun, Huiming Li, Xiubo Chen, Yixian Yang, Xiaojun Wang, Yuan Su. This work was supported by the National Natural Science Foundation of China (No.61303039), Sichuan Youth Science and Technique Foundation (No.2017JQ0048), Fundamental Research Funds for the Central Universities (No.2682014CX095), Chuying Fellowship, CSC Scholarship, and EU ICT COST CryptoAction (No.IC1306).

-
- [1] J. S. Bell, *Phys.* **1**, 195-200 (1964).
 - [2] J. S. Bell, *Speakable and Unsayable in Quantum Mechanics*, 2nd ed. (Cambridge University Press, Cambridge, 2004).
 - [3] R. Cleve & H. Buhrman, *Phys. Rev. A* **56**, 1201 (1997).
 - [4] D. Mayers & A. Yao, Quantum cryptography with imperfect apparatus. Proc. of the 39th IEEE Symposium on Foundations of Computer Science (IEEE Computer Society, Los Alamitos, 1998), p. 503.
 - [5] N. Brunner, D. Cavalcanti, S. Pironio, V. Scarani, & S. Wehner, *Rev. Mod. Phys.* **86**, 419 (2014).
 - [6] A. K. Ekert, *Phys. Rev. Lett.* **67**, 661(1991).
 - [7] A. Acín, N. Brunner, N. Gisin, S. Massar, S. Pironio, and V. Scarani *Phys. Rev. Lett.* **98**, 230501 (2007).
 - [8] S. Pironio, A. Acín, S. Massar, A. Boyer de la Giroday, D. N. Matsukevich, P. Maunz, S. Olmschenk, D. Hayes, L. Luo, T. A. Manning, C. Monroe, *Nature* (London) **464**, 1021-1024 (2010).
 - [9] H. Buhrman, R. Cleve, S. Massar, & R. de Wolf, *Rev. Mod. Phys.* **82**, 665 (2010).
 - [10] S. Bravyi, D. Gosset, and R. König, arXiv:1704.00690v1 (2017).
 - [11] S. Popescu, *Phys. Rev. Lett.* **74**, 2619 (1995).
 - [12] C. Branciard, N. Gisin, & S. Pironio, *Phys. Rev. Lett.* **104**, 170401 (2010).
 - [13] T. Fritz, *New J. Phys.* **14**, 103001 (2012).
 - [14] J. Henson, R. Lal, and M. F. Pusey, *New J. Phys.* **16**, 113043 (2014).
 - [15] R. Gallego, L. E. Würflinger, R. Chaves, A. Acín, and M. Navascués, *New J. Phys.* **16**, 033037 (2014).
 - [16] R. Chaves, C. Majenz, and D. Gross, *Nat. Commun.* **6**, 5766 (2015).
 - [17] T. Fritz, *Comm. Math. Phys.* **341**(2), 391-434 (2016).
 - [18] J. Pearl, *Causality* (Cambridge University Press, Cambridge, England, 2009).
 - [19] J.-M. A. Allen, J. Barrett, D. C. Horsman, C. M. Lee, Robert W. Spekkens, arXiv:1609.09487.
 - [20] P. Spirtes, N. Glymour, and R. Scheienes, *Causation, Prediction, and Search*, 2nd ed. (MIT Press, Cambridge, MA, 2001).
 - [21] D. Rosset, J.-D. Bancal, & N. Gisin, *J. Phys. A* **47**, 424022 (2014).
 - [22] A. Acín, J. I. Cirac, and M. Lewenstein, *Nature Phys.* **3**, 256 (2007).
 - [23] H. J. Kimble, *Nature* (London) **453**, 1023 (2008).
 - [24] N. Sangouard, C. Simon, H. de Riedmatten, & N. Gisin, *Rev. Mod. Phys.* **83**, 33 (2011).
 - [25] C. Branciard, D. Rosset, N. Gisin, & S. Pironio, *Phys. Rev. A* **85**, 032119 (2012).
 - [26] A. Tavakoli, P. Skrzypczyk, D. Cavalcanti, & A. Acín, *Phys. Rev. A* **90**, 062109 (2014).
 - [27] C. Branciard, N. Brunner, H. Buhrman, R. Cleve, N. Gisin, S. Portmann, D. Rosset, and M. Szegedy *Phys. Rev. Lett.* **109**, 100401 (2012).
 - [28] F. Andreoli, G. Carvacho, L. Santodonato, R. Chaves, & F. Sciarrino, arxiv1702.08316 (2017).
 - [29] C. M. Lee, Robert W. Spekkens, arXiv:1506.03880.
 - [30] R. Chaves, *Phys. Rev. Lett.* **116**, 010402 (2016).
 - [31] D. Rosset, C. Branciard, T. J. Barnea, G. Pütz, N. Brunner, and N. Gisin, *Phys. Rev. Lett.* **116**, 010403 (2016).
 - [32] N. Gisin, Q. Mei, A. Tavakoli, M. O. Renou, & N. Brunner, arxiv1702.00333 (2017).
 - [33] D. J. Saunders, A. J. Bennet, C. Branciard, & G. J. Pryde, *Science Adv.* **3**, 1602743 (2017).
 - [34] G. Carvacho, F. Andreoli, L. Santodonato, M. Bentivegna, R. Chaves, and F. Sciarrino, *Nat. Commun.* **8**, 14775 (2017).
 - [35] F. Andreoli, G. Carvacho, L. Santodonato, M. Bentivegna, R. Chaves, and F. Sciarrino, *Phys. Rev. A* **95**, 062315(2017).
 - [36] M. J. Hu, Z.-Y. Zhou, X.-M. Hu, C.-F. Li, G.-C. Guo, and Y.-S. Zhang, arxiv1609.01863 (2016).
 - [37] D. B. West, *Introduction on Graph Theory* (2nd ed.), (Prentice Hall, 1999).
 - [38] V. Capasso, D. Fortunato, and F. Selleri, *Int. J. Mod. Phys.* **7**, 319(1973).

- [39] N. Gisin, *Phys. Lett. A* **154**, 201(1991).
- [40] S. Popescu and D. Rohrlich, *Phys. Lett. A* **166**, 293 (1992).
- [41] J. F. Clauser, M. A. Horne, A. Shimony, and R. A. Holt, *Phys. Rev. Lett.* **23**, 880(1969).
- [42] D. Geiger and C. Meek, Quantifier elimination for statistical problems. *Proc. of the 15th Conf. on Uncertainty in Artificial Intelligence*, p. 226, (Morgan Kaufmann Publishers Inc., Burlington, Massachusetts, 1999).
- [43] A. Tarski, A decision method for elementary algebra and geometry. In *Quantifier elimination and cylindrical algebraic decomposition*, pp. 24-84, Springer, Vienna (1998).
- [44] C. Kang and J. Tian, arXiv:1206.5275 (2012).
- [45] B. S. Cirel'son, *Lett. Math. Phys.* **4**, 93 (1980).
- [46] B. S. Tsirelson, *Hadronic J. Suppl.* **8**, 329 (1993)
- [47] H. E. Hopcroft and R. M. Karp, *SIAM J. Computing* **2**(4), 225-231 (1973).
- [48] M. Yannakakis and F. Gavril, *SIAM J. Applied Math.* **38**, 364-372(1980).
- [49] G. Ausiello, P. Crescenzi, G. Gambosi, V. Kann, A. Marchetti-Spaccamela, & M. Protasi, *Complexity and approximation: Combinatorial optimization problems and their approximability properties* (Springer, 2003).
- [50] A. Einstein, B. Podolsky, & N. Rosen, *Phys. Rev.* **47**, 777-780 (1935).
- [51] D. M. Greenberger, M. A. Horne, & A. Zeilinger, Bell's theorem without inequalities. In *Bell's theorem, quantum theory and conceptions of the universe* (eds Kafatos, M.), 69-72 (Springer Netherlands, 1989).
- [52] V. Scarani and N. Gisin, *J. Phys. A* **34**, 6043 (2001).
- [53] N. D. Mermin, *Phys. Rev. Lett.* **65**, 1838 (1990).
- [54] M. Ardehali, *Phys. Rev. A* **46**, 5375 (1992).
- [55] A. V. Belinskii and D. N. Klyshko, *Phys. Usp.* **36**, 653 (1993).
- [56] M. Żukowski, Č. Brukner, W. Laskowski, and M. Wieśniak, *Phys. Rev. Lett.* **88**, 210402(2002).
- [57] R. Horodecki, P. Horodecki, & M. Horodecki, *Phys. Lett. A* **200**, 340-344 (1995).
- [58] D. Collins and N. Gisin, *J. Phys. A: Math. and General* **37**, 1775 (2004).
- [59] E. F. Assmus Jr. and J. D. Key, *Designs and Their Codes* (Cambridge University Press, Cambridge, 1992).

Appendix A1: Proof of the inequality in Eq.(6)

In this section, we prove the inequality in Eq.(6) for a general network in terms of the generalized locally causal model. From the definition of k -locality in Eq.(3), $P(a_1, a_2, \dots, a_n | x_1, x_2, \dots, x_n)$ has the decomposition in Eq.(2). Let $\langle A_{x_1} A_{x_2} \dots A_{x_n} \rangle = \sum_{a_1, a_2, \dots, a_n} (-1)^{\sum_{i=1}^n a_i} P(a_1, a_2, \dots, a_n | x_1, x_2, \dots, x_n)$. Define the expectation of the output A_{x_i} as

$$\langle A_{x_i} \rangle = \sum_{a_i=0}^1 (-1)^{a_i} P(a_i | x_i, \Lambda_i), \quad (\text{A1})$$

where $i = 1, 2, \dots, n$.

Denote the integer sets $\mathcal{I} = \{i_1, i_2, \dots, i_k\}$ and $\bar{\mathcal{I}} = \{1, 2, \dots, n\} / \{i_1, i_2, \dots, i_k\}$. With the inequalities $|\langle A_{x_i} \rangle| \leq 1$ for $i = 1, 2, \dots, n$, from Eqs.(4), (5) and (A1) it follows that

$$\begin{aligned} |I_{n,k}| &= \frac{1}{2^k} \int \dots \int d\Lambda_{i_1} d\Lambda_{i_2} \dots d\Lambda_{i_k} \prod_{j=1}^m p_j(\lambda_j) \prod_{i_s \in \mathcal{I}} |\langle A_{x_{i_s}=0} \rangle + \langle A_{x_{i_s}=1} \rangle| \prod_{j \in \bar{\mathcal{I}}} |\langle A_j \rangle| \\ &\leq \frac{1}{2^k} \int \dots \int d\Lambda_{i_1} d\Lambda_{i_2} \dots d\Lambda_{i_k} \prod_{j=1}^m p_j(\lambda_j) \prod_{i_s \in \mathcal{I}} |\langle A_{x_{i_s}=0} \rangle + \langle A_{x_{i_s}=1} \rangle|. \end{aligned} \quad (\text{A2})$$

By setting $\langle \Delta^\pm A_{x_{i_s}} \rangle = \frac{1}{2} (\langle A_{x_{i_s}=0} \rangle \pm \langle A_{x_{i_s}=1} \rangle)$, Eq.(A2) yields to

$$\begin{aligned} |I_{n,k}| &\leq \int \dots \int d\Lambda_{i_1} d\Lambda_{i_2} \dots d\Lambda_{i_k} \prod_{j=1}^m p_j(\lambda_j) \prod_{i_s \in \mathcal{I}} |\langle \Delta^+ A_{x_{i_s}} \rangle| \\ &\leq \prod_{i_s \in \mathcal{I}} \int \dots \int d\Lambda_{i_s} P(\Lambda_{i_s}) |\langle \Delta^+ A_{x_{i_s}} \rangle|, \end{aligned} \quad (\text{A3})$$

where $P(\Lambda_{i_s}) = \prod_{\lambda_j \in \Lambda_{i_s}} p_j(\lambda_j)$, $s = 1, 2, \dots, k$.

Similarly, we obtain that

$$\begin{aligned} |J_{n,k}| &= \left| \int \dots \int d\Lambda_{i_1} d\Lambda_{i_2} \dots d\Lambda_{i_k} \prod_{j=1}^m p_j(\lambda_j) \prod_{i_s \in \mathcal{I}} \langle \Delta^- A_{x_{i_s}} \rangle \prod_{j \in \bar{\mathcal{I}}} |\langle A_j \rangle| \right| \\ &\leq \prod_{i_s \in \mathcal{I}} \int \dots \int d\Lambda_{i_s} P(\Lambda_{i_s}) |\langle \Delta^- A_{x_{i_s}} \rangle|. \end{aligned} \quad (\text{A4})$$

From the Mahler inequality [1], Eqs.(A3) and (A4) follow that

$$\begin{aligned} |I_{n,k}|^{\frac{1}{k}} + |J_{n,k}|^{\frac{1}{k}} &\leq \left(\prod_{i_s \in \mathcal{I}} \int \dots \int d\Lambda_{i_s} P(\Lambda_{i_s}) (|\langle \Delta^+ A_{x_{i_s}} \rangle| + |\langle \Delta^- A_{x_{i_s}} \rangle|) \right)^{\frac{1}{k}} \\ &\leq \left(\prod_{i_s \in \mathcal{I}} \int \dots \int d\Lambda_{i_s} P(\Lambda_{i_s}) \right)^{\frac{1}{k}} \end{aligned} \quad (\text{A5})$$

$$= 1, \quad (\text{A6})$$

where the inequality in Eq.(A5) is from the inequalities $|\langle \Delta^+ A_{x_{i_s}} \rangle| + |\langle \Delta^- A_{x_{i_s}} \rangle| = \max\{|\langle A_{x_{i_s}=0} \rangle|, |\langle A_{x_{i_s}=1} \rangle|\} \leq 1$ for $s = 1, 2, \dots, n$; and Eq.(A6) is from the normalization condition of the probability distribution of hidden states.

Appendix A2: Proof of the inequality in Eq.(7)

In this subsection, we prove Tsirelson's bound in Eq.(7). For the network in Fig.1, assume that there are 2^n Hermitian dichotomic operators $\mathbf{A}_{x_1}, \mathbf{A}_{x_2}, \dots, \mathbf{A}_{x_n}$ with $x_i \in \{0, 1\}$, where \mathbf{A}_{x_i} with outcomes ± 1 are defined on the joint system of the quantum network. Note that these operators satisfy the commute condition $[\mathbf{A}_{x_i}, \mathbf{A}_{x_j}] = 0$ for $i \neq j$. Thus, there exist operators $\hat{\mathbf{A}}_{x_1}, \hat{\mathbf{A}}_{x_2}, \dots, \hat{\mathbf{A}}_{x_n}$ (up to proper unitary equivalence) satisfying $\mathbf{A}_{x_i} = \hat{\mathbf{A}}_{x_i} \oplus \mathbf{I}_r^i$,

where \oplus denotes the direct summation of two operators performed on different Hilbert spaces, and \mathbf{I}_r^i denotes the identity operator on the system which does not belong to observer \mathcal{A}_i . All the observables $\hat{\mathbf{A}}_{x_1}, \hat{\mathbf{A}}_{x_2}, \dots, \hat{\mathbf{A}}_{x_n}$ have the eigenvalues ± 1 and are performed on local systems.

We firstly prove the following lemma (which may be mathematically presented in some papers because of its simplicity)

Lemma 1. For any $\theta_1, \theta_2, \dots, \theta_n \in [0, \pi]$ and integer $n \geq 2$, we obtain that the following inequality

$$\left(\prod_{i=1}^n \sin \theta_i\right)^{\frac{1}{n}} \leq \sin\left(\frac{1}{n} \sum_{i=1}^n \theta_i\right), \quad (\text{A7})$$

where the equality holds if and only if $\theta_1 = \theta_2 = \dots = \theta_n$.

Proof. The proof is completed by induction. For $n = 2$, the inequality (A7) is equivalent to

$$\begin{aligned} \sin \theta_1 \sin \theta_2 &\leq \sin^2\left(\frac{\theta_1 + \theta_2}{2}\right) \\ &= \frac{1}{2}(1 - \cos(\theta_1 + \theta_2)) \\ &= \frac{1}{2}(1 - \cos \theta_1 \cos \theta_2 + \sin \theta_1 \sin \theta_2) \end{aligned} \quad (\text{A8})$$

which implies that $\cos(\theta_1 - \theta_2) \leq 1$. This is satisfied for any $\theta_1, \theta_2 \in [0, \pi]$.

Now, assume that for any $n \leq k - 1$, the inequality (A7) holds all $\theta_1, \theta_2, \dots, \theta_n \in [0, \pi]$. For even $n = k$, from the assumption we obtain that

$$\begin{aligned} \left(\prod_{i=1}^n \sin \theta_i\right)^{\frac{1}{n}} &= \sqrt{\left(\prod_{i=1}^m \sin \theta_i\right)^{\frac{1}{m}}} \sqrt{\left(\prod_{i=m+1}^n \sin \theta_i\right)^{\frac{1}{m}}} \\ &\leq \sqrt{\sin\left(\frac{1}{m} \sum_{i=1}^m \theta_i\right)} \sqrt{\sin\left(\frac{1}{m} \sum_{i=m+1}^n \theta_i\right)} \end{aligned} \quad (\text{A9})$$

$$\leq \sin\left(\frac{1}{n} \sum_{i=1}^n \theta_i\right), \quad (\text{A10})$$

where the equality in Eq.(A9) holds if and only if $\theta_1 = \theta_2 = \dots = \theta_m$ and $\theta_{m+1} = \theta_{m+2} = \dots = \theta_n$; the equality in Eq.(A10) holds if and only if $\sum_{i=1}^m \theta_i = \sum_{j=m+1}^n \theta_j$, and $m = \frac{n}{2}$. Hence, the equality in Eq.(A7) holds if and only if $\theta_1 = \theta_2 = \dots = \theta_n$.

For odd $n = k$, by introducing an ancillary variable θ_{n+1} , from the assumption we obtain that

$$\begin{aligned} \left(\prod_{i=1}^{n+1} \sin \theta_i\right)^{\frac{1}{n+1}} &= \sqrt{\left(\prod_{i=1}^m \sin \theta_i\right)^{\frac{1}{m}}} \sqrt{\left(\prod_{i=m+1}^{n+1} \sin \theta_i\right)^{\frac{1}{m}}} \\ &\leq \sqrt{\sin\left(\frac{1}{m} \sum_{i=1}^m \theta_i\right)} \sqrt{\sin\left(\frac{1}{m} \sum_{i=m+1}^{n+1} \theta_i\right)} \end{aligned} \quad (\text{A11})$$

$$\leq \sin\left(\frac{1}{n+1} \sum_{i=1}^{n+1} \theta_i\right), \quad (\text{A12})$$

where the equality in Eq.(A11) holds if and only if $\theta_1 = \theta_2 = \dots = \theta_m$ and $\theta_{m+1} = \theta_{m+2} = \dots = \theta_n$; the equality in Eq.(A12) holds if and only if $\sum_{i=1}^m \theta_i = \sum_{j=m+1}^{n+1} \theta_j$, and $m = \frac{n+1}{2}$. Now, by setting $\theta_{n+1} = \frac{1}{n} \sum_{i=1}^n \theta_i$, we get the equality $\theta_{n+1} = \frac{1}{n+1} \sum_{i=1}^{n+1} \theta_i$. Thus, the inequality in Eq.(A12) yields that

$$\left(\prod_{i=1}^n \sin \theta_i\right)^{\frac{1}{n+1}} \left(\sin \theta_{n+1}\right)^{\frac{1}{n+1}} \leq \sin(\theta_{n+1}),$$

which follows the inequality in Eq.(A7). The equality in Eq.(A7) holds if and only if $\theta_1 = \theta_2 = \dots = \theta_n$. \square

Now, we continue to prove the inequality in Eq.(7). For the simplicity of the statement, let $\mathcal{I} = \{1, 2, \dots, k\}$. Denote the norm of Hermitian operator \mathbf{X} on Hilbert space \mathbb{H} as $\|\mathbf{X}\| = \sup\{\text{Tr}(\mathbf{X}\rho), \rho \in \mathbb{H} \text{ with } \text{Tr}\rho = 1\}$. From Eqs.(4) and (5), the inequalities $\|\mathbf{A}_{x_j}\| \leq 1$, and the linearity of the expectation operation $\langle \cdot \rangle$, we obtain that

$$\begin{aligned} F &:= |I_{n,k}^q|^{\frac{1}{k}} + |J_{n,k}^q|^{\frac{1}{k}} \\ &= \left| \sum_{i_1, i_2, \dots, i_k} \frac{1}{2^k} \langle \prod_{j=1}^k \mathbf{A}_{x_j} \prod_{s \in \bar{\mathcal{I}}} \mathbf{A}_{x_s} \rangle \right|^{\frac{1}{k}} + \left| \sum_{i_1, i_2, \dots, i_k} (-1)^{\sum_{j=1}^k x_j} \frac{1}{2^k} \langle \prod_{j=1}^k \mathbf{A}_{x_j} \prod_{s \in \bar{\mathcal{I}}} \mathbf{A}_{x'_s} \rangle \right|^{\frac{1}{k}} \\ &\leq \frac{1}{2} \left| \langle \prod_{j=1}^k (\mathbf{A}_{j,0} + \mathbf{A}_{j,1}) \rangle \right|^{\frac{1}{k}} + \frac{1}{2} \left| \langle \prod_{j=1}^k (\mathbf{A}_{j,0} - \mathbf{A}_{j,1}) \rangle \right|^{\frac{1}{k}}, \end{aligned} \quad (\text{A13})$$

where $\mathbf{A}_{j,0}$ and $\mathbf{A}_{j,1}$ are given by $\mathbf{A}_{j,0} = \mathbf{A}_{x_j=0}$, $\mathbf{A}_{j,1} = \mathbf{A}_{x_j=1}$, and x_s, x'_s represent different binary values, $j = 1, 2, \dots, n$.

Moreover, using the commute conditions $[\mathbf{A}_{x_i}, \mathbf{A}_{x_j}] = 0$, Eq.(A13) yields to

$$\begin{aligned} F^2 &\leq \frac{1}{4} \left| \langle \prod_{j=1}^k (\mathbf{A}_{j,0} + \mathbf{A}_{j,1}) \rangle \right|^{\frac{2}{k}} + \frac{1}{4} \left| \langle \prod_{j=1}^k (\mathbf{A}_{j,0} - \mathbf{A}_{j,1}) \rangle \right|^{\frac{2}{k}} + \frac{1}{2} \left| \langle \prod_{j=1}^k [\mathbf{A}_{j,0}, \mathbf{A}_{j,1}] \rangle \right|^{\frac{1}{k}} \\ &\leq \frac{1}{4} \left| \langle \prod_{j=1}^k (2\mathbf{I} + \mathbf{B}_j) \rangle \right|^{\frac{1}{k}} + \frac{1}{4} \left| \langle \prod_{j=1}^k (2\mathbf{I} - \mathbf{B}_j) \rangle \right|^{\frac{1}{k}} + 1 \end{aligned} \quad (\text{A14})$$

from the equalities $\mathbf{A}_{j,0}^2 = \mathbf{A}_{j,1}^2 = \mathbf{I}$ and the inequalities $\|[\mathbf{A}_{j,0}, \mathbf{A}_{j,1}]\| \leq 2\|\mathbf{A}_{j,0}\|\|\mathbf{A}_{j,1}\| \leq 2$, where $\mathbf{B}_j = \mathbf{A}_{j,0}\mathbf{A}_{j,1} + \mathbf{A}_{j,1}\mathbf{A}_{j,0}$, $[\mathbf{A}_{j,0}, \mathbf{A}_{j,1}] = \mathbf{A}_{j,0}\mathbf{A}_{j,1} - \mathbf{A}_{j,1}\mathbf{A}_{j,0}$, and \mathbf{I} denotes the identity operator.

In what follows, denote $\hat{\mathbf{B}}_j = \hat{\mathbf{A}}_{j,0}\hat{\mathbf{A}}_{j,1} + \hat{\mathbf{A}}_{j,1}\hat{\mathbf{A}}_{j,0}$ using the operators $\hat{\mathbf{A}}_{x_1}, \hat{\mathbf{A}}_{x_2}, \dots, \hat{\mathbf{A}}_{x_n}$ which are performed on different subsystems. Note that $2 \pm \hat{\mathbf{B}}_j \geq 0$ because of $\|\hat{\mathbf{B}}_j\| \leq 2$. The inequality in Eq.(A14) is equivalent to

$$\begin{aligned} F^2 &\leq \frac{1}{4} \prod_{j=1}^k \langle 2\mathbf{I} + \hat{\mathbf{B}}_j \rangle^{\frac{1}{k}} + \frac{1}{4} \prod_{j=1}^k \langle 2\mathbf{I} - \hat{\mathbf{B}}_j \rangle^{\frac{1}{k}} + 1 \\ &= \frac{1}{4} \prod_{j=1}^k (2 + \langle \hat{\mathbf{B}}_j \rangle)^{\frac{1}{k}} + \frac{1}{4} \prod_{j=1}^k (2 - \langle \hat{\mathbf{B}}_j \rangle)^{\frac{1}{k}} + 1. \end{aligned} \quad (\text{A15})$$

By setting $2 + \langle \hat{\mathbf{B}}_j \rangle = 4 \sin^2 \theta_j$ with $\theta_j \in [0, \pi]$, we obtain that $2 - \langle \hat{\mathbf{B}}_j \rangle = 4 \cos^2 \theta_j$, $j = 1, 2, \dots, n$. The inequality in Eq.(A15) follows that

$$\begin{aligned} F^2 &\leq \left(\prod_{j=1}^k \sin \theta_j \right)^{\frac{2}{k}} + \left(\prod_{j=1}^k \sin(\frac{\pi}{2} - \theta_j) \right)^{\frac{2}{k}} + 1 \\ &\leq \sin^2 \left(\sum_{j=1}^k \theta_j \right) + \sin^2 \left(\frac{\pi}{2} - \sum_{j=1}^k \theta_j \right) + 1 \end{aligned} \quad (\text{A16})$$

$$= 2, \quad (\text{A17})$$

where the inequality in Eq.(A16) is from the presented Lemma, and the equality in Eq.(A16) is from the equalities $|\sin(\frac{\pi}{2} - \sum_{j=1}^k \theta_j)| = |\cos(\sum_{j=1}^k \theta_j)|$ and $\sin^2 \theta + \cos^2 \theta = 1$. So, $F \leq \sqrt{2}$.

Appendix B: The number k of independent parties in networks

Appendix B1: The maximum k_{\max}

In this subsection, we present the hardness of finding the maximum k_{\max} for a general network. Informally, we obtain that

Statement. The problem of finding the maximum k_{\max} of a general network is NP-Hard.

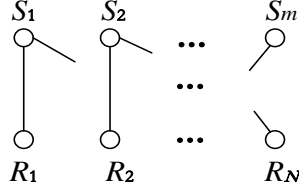

FIG. 4: (Color online) The equivalent unweighted bipartite graph. R_1, R_2, \dots, R_N denote all decomposed parties of $\mathcal{A}_1, \mathcal{A}_2, \dots, \mathcal{A}_n$, where each party \mathcal{A}_j is decomposed into ℓ_j different new parties, $N = \sum_{i=1}^n \ell_i$.

The following procedure starts from a new equivalent bipartite graph (in which the parties has not decomposed) $G = (S, A, E)$ of a given network in Fig.1. S denotes the set of m independent sources S_1, S_2, \dots, S_m . R denotes the set of n parties $\mathcal{A}_1, \mathcal{A}_2, \dots, \mathcal{A}_n$. E denotes the set of all edges which schematically represent the relations of sources and parties. Denote ℓ_i as the number of sources which connect to party \mathcal{A}_i , $i = 1, 2, \dots, n$. The maximum k_{\max} problem can be mathematically formulated as an integer program:

$$\text{maximize: } \sum_{i=1}^n y_i$$

subject to:

$$\sum_{i=1}^n x_{ij} = 1, j = 1, 2, \dots, m;$$

$$\sum_{j=1}^m x_{ij} = \ell_i y_i, i = 1, 2, \dots, n;$$

$$y_i, x_{ij} \in \{0, 1\}, 1 \leq \ell_i \leq m, i = 1, 2, \dots, n; j = 1, 2, \dots, m.$$

Here, y_i is the characteristic function of party \mathcal{A}_i , i.e., $y_i = 1$ if party \mathcal{A}_i is included in the maximal set of independent parties for evaluating k_{\max} ; $y_i = 0$ otherwise. The first condition is used to ensure each source distribute a hidden state to one party. The second condition is used to ensure that party \mathcal{A}_i is included in the set of independent parties, i.e., the number of nonzero x_{ij} should equal that of the edges connected to \mathcal{A}_i , $j = 1, 2, \dots, m$. This problem is generally NP-hard [2] (there exist integer program problems which are NP-hard). Of course, there exists P-hard subsets of integer programs for special networks (see Fig.3). \square

Appendix B2: Efficient computation of k

Despite the NP-hard problem for a general network, there exist computationally efficient algorithms to find suboptimal k or possible values of k . Let ℓ_i be the number of independent sources which distribute the hidden states to party \mathcal{A}_i , $i = 1, 2, \dots, n$. By schematically decomposing each party \mathcal{A}_i into ℓ_i different parties $R_{t_{i-1}+1}, R_{t_{i-1}+1}, \dots, R_{t_i}$, we obtain an equivalent bipartite graph $G = (S, R, E)$ in Fig.S1, where $t_i = \sum_{j=1}^i \ell_j$, $i = 1, 2, \dots, n$. All independent sources S_1, \dots, S_m of the network in Fig.1 are regarded as the upper vertices in the set S while all decomposed parties are represented by the lower vertices R_1, R_2, \dots, R_N in the set R with $N = t_k$. Each edge represents the fact that a source distributes one hidden state to a decomposed party.

For bipartite graph $G = (S, R, E)$, a matching is a subset of the edges satisfying that no two edges share a vertex [3]. For any hidden states $\Lambda_1, \Lambda_2, \dots, \Lambda_k$ of the network in Fig.1 satisfying Eq.(3), it is easy to prove that all edges between the sources and corresponding parties are consisted of a matching set of the unweighted bipartite graph G in Fig.S1. This is from the independence assumption of the corresponding parties. Conversely, given a matching $E' \subset E$ of the bipartite graph in Fig.S1, two steps are used to find the integer k of the independent parties of the network in Fig.1 as follows:

- Find all original parties \mathcal{A}_i who have at least one decomposed party in the vertex set of E' . Denote A as the desired set of all these parties;
- Check the completeness of each party in A , where the completeness means all the decomposed parties of one original party in A are in the vertex set of E' .

Note that k equals the number of original parties in Fig.1 satisfying the completeness. Hence, for each matching of the unweighted bipartite graph G , there may exist an integer $k \geq 2$ and the corresponding independent parties in A ;

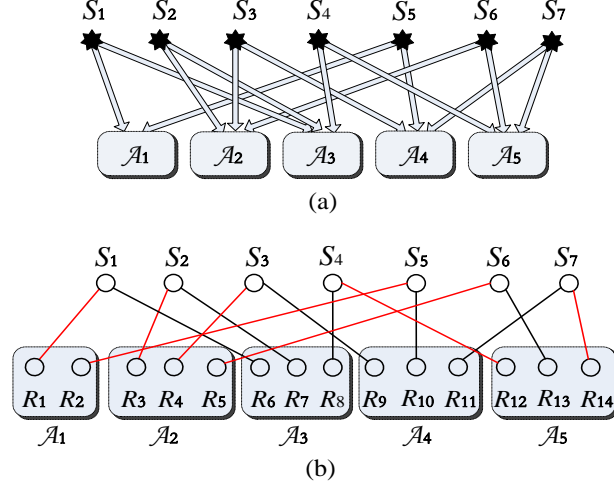

FIG. 5: (Color online) (a) Simple network with 7 independent sources S_1, S_2, \dots, S_7 . Each star denotes one source. (b) Equivalent unweighted bipartite graph. Here, $\mathcal{A}_1, \mathcal{A}_2, \dots, \mathcal{A}_5$ are decomposed into $\{R_1, R_2\}$, $\{R_3, R_4, R_5\}$, $\{R_6, R_7, R_8\}$, $\{R_9, R_{10}, R_{11}\}$, $\{R_{12}, R_{13}, R_{14}\}$, respectively. Each circle denotes a vertex. All red edges are consisted of one of the maximal matchings of the graph.

Otherwise, another matching should be used. In theory, one needs to find all matchings to obtain the largest k for the tight form of Eq.(6).

Here, we present a simple example in Fig.S2. There are five parties $\mathcal{A}_1, \mathcal{A}_2, \dots, \mathcal{A}_5$ who receive the hidden states from 7 independent sources S_1, S_2, \dots, S_7 in Fig.S2(a). We firstly decompose $\mathcal{A}_1, \mathcal{A}_2, \dots, \mathcal{A}_5$ into $\{R_1, R_2\}$, $\{R_3, R_4, R_5\}$, $\{R_6, R_7, R_8\}$, $\{R_9, R_{10}, R_{11}\}$, $\{R_{12}, R_{13}, R_{14}\}$, respectively. And then, we obtain an equivalent unweighted bipartite graph in Fig.S2(b). All the red edges are consisted of one of the maximal matchings of the graph. By checking the completeness of three parties $\mathcal{A}_1, \mathcal{A}_2, \mathcal{A}_5$, we obtain $k = 2$ from this matching. Moreover, by checking all the maximal matchings, we obtain that the maximum k equals 2.

Another accessible method is to get a small k for a very large network $G = (S, E)$ as follows, where S is the set of vertexes (parties) and E is the set of edges, and each pair of vertexes (parties) is connected with an edge if they share an entanglement.

- Randomly choose one vertex $V_1 \in S$;
- Randomly choose one vertex $V_2 \in S_1$, where $G_1 = (S_1, E_1)$ is the reduced network by deleting all vertexes which have edges connected to V_1 ;
- Continue the procedure until there is no remained vertexes.

Note that the deleting operation of one vertex is completed if there is one edge which has connected to the chosen vertex. So, this algorithm is efficient because we only need to deleting and random choosing operations which are polynomial in the total number of vertexes (not the total number of edges). In particular, one may choose one vertex with the minimal degree (the number of edges connected to it) in each step. Of course, this algorithm cannot ensure the maximal k . Fortunately, our results holds for any $k \geq 2$. So, from the suboptimal k or the minimum $k = 2$, we can obtain useful Bell inequalities.

Appendix C: Proof of Theorem A

In this section, we prove Theorem A for a general network in Fig.1 with arbitrary bipartite entangled pure states and GHZ states as quantum resources. In the following experiment of verifying the no-multilocality, after all parties except for $\mathcal{A}_1, \mathcal{A}_2, \dots, \mathcal{A}_k$ (or the combined party \mathcal{B}) perform some measurements depending on their input bits y on their particles and obtain output bits b , all parties $\mathcal{A}_1, \mathcal{A}_2, \dots, \mathcal{A}_k$ performs some measurements depending on their input bits x_1, x_2, \dots, x_k on their particles and obtain output bits a_1, a_2, \dots, a_k , where $a_i, b, x_i, y \in \{0, 1\}$.

The proof is completed by following the procedure from special quantum resources to general quantum resources. This is easy to follow the main idea.

Appendix C1: EPR states as quantum resources

In this subsection, we assume that the quantum resources consist of Einstein-Podolsky-Rosen (EPR) states [6]:

$$|\Xi\rangle = \otimes_{i=1}^m |\Phi_i\rangle, \quad (\text{C1})$$

where $|\Phi_i\rangle = a_i|00\rangle + b_i|11\rangle$ are EPR states with real coefficients a_i, b_i satisfying the normalization condition $a_i^2 + b_i^2 = 1, i = 1, 2, \dots, m$.

Assume that two observers \mathcal{A}_i and \mathcal{B} share ℓ_i EPR states $|\Phi_{t_{i-1}+1}\rangle, |\Phi_{t_{i-1}+2}\rangle, \dots, |\Phi_{t_i}\rangle$, where $t_i = \sum_{j=1}^i \ell_j, t_0 = 0$ and $\sum_{j=1}^k \ell_j \leq m$. Here, we donot need to consider these entanglements owned by single observer \mathcal{A}_i because it may be locally measured with an identity operator.

Define the operators \mathbf{A}_{x_i} on the particles of the observer \mathcal{A}_i as

$$\mathbf{A}_{x_i} = \begin{cases} \cos \theta_i \sigma_z^{\otimes \ell_i - 1} \otimes \mathbf{I}_2 + (-1)^{x_i} \sin \theta_i \sigma_x^{\otimes \ell_i}, & \text{for even } \ell_i; \\ \cos \theta_i \sigma_z^{\otimes \ell_i} + (-1)^{x_i} \sin \theta_i \sigma_x^{\otimes \ell_i}, & \text{for odd } \ell_i; \end{cases} \quad (\text{C2})$$

where σ_z and σ_x are Pauli operators, \mathbf{I}_2 is the identity operator on one qubit system, $\mathbf{X}^{\otimes l}$ denotes the l -fold tensor of the operator \mathbf{X} , and $\theta_i \in [0, \frac{\pi}{2}]$, $i = 1, 2, \dots, k$.

Define the operators \mathbf{B}_y on the particles of the observer \mathcal{B} as

$$\mathbf{B}_y = (\otimes_{i=1}^k \mathbf{B}_{i,y}) \otimes \mathbf{B}_{r,y} \quad (\text{C3})$$

where $\mathbf{B}_{i,y}$ and $\mathbf{B}_{r,y}$ are given by

$$\mathbf{B}_{i,y} = \begin{cases} (1-y)\sigma_z^{\otimes \ell_i - 1} \otimes \mathbf{I}_2 + y\sigma_x^{\otimes \ell_i}, & \text{for even } \ell_i; \\ (1-y)\sigma_z^{\otimes \ell_i} + y\sigma_x^{\otimes \ell_i}, & \text{for odd } \ell_i; \end{cases} \quad (\text{C4})$$

and

$$\mathbf{B}_{r,y} = (1-y)\sigma_z^{2m-2t_k} + y\sigma_x^{2m-2t_k}. \quad (\text{C5})$$

Before continuing the proof, we prove that $\mathbf{A}_{x_1}, \mathbf{A}_{x_2}, \dots, \mathbf{A}_{x_k}$ and \mathbf{B}_y are observables with outcomes ± 1 (eigenvalues of the measurement operator). Note that $\mathbf{A}_{x_1}, \mathbf{A}_{x_2}, \dots, \mathbf{A}_{x_k}$ and \mathbf{B}_y are performed on the local systems, they satisfy the commute condition. Moreover, since $\mathbf{A}_{x_1}, \mathbf{A}_{x_2}, \dots, \mathbf{A}_{x_k}$ and \mathbf{B}_y are symmetric, it only needs to prove that they are unitary, i.e, they are unitary Hermitian operators. For even ℓ_i , from Eq.(C2) we obtain that

$$\begin{aligned} \mathbf{A}_{x_i}^2 &= \mathbf{I}_{2^{\ell_i}} + (-1)^{x_i} \sin \theta_i \cos \theta_i (\mathbf{Y}^{\otimes \ell_i - 1} \otimes \sigma_x + (-\mathbf{Y})^{\otimes \ell_i - 1} \otimes \sigma_x) \\ &= \mathbf{I}_{2^{\ell_i}}, \end{aligned} \quad (\text{C6})$$

where $\mathbf{Y} = \sigma_z \sigma_x$, and $\mathbf{I}_{2^{\ell_i}}$ is the identity operator on the system of ℓ_i qubits. For odd ℓ_i , from Eq.(C2) we obtain that

$$\begin{aligned} \mathbf{A}_{x_i}^2 &= \mathbf{I}_{2^{\ell_i}} + (-1)^{x_i} \sin \theta_i \cos \theta_i (\mathbf{Y}^{\otimes \ell_i} + (-\mathbf{Y})^{\otimes \ell_i}) \\ &= \mathbf{I}_{2^{\ell_i}}. \end{aligned} \quad (\text{C7})$$

Eqs.(C6) and (C7) imply that all operators \mathbf{A}_{x_i} are unitary. Moreover, \mathbf{B}_y are unitary Hermitian because all operators $\mathbf{B}_{i,y}, \mathbf{B}_{r,y}$ are products of Pauli operators and identity operator \mathbf{I}_2 . In Eq.(C5), $\otimes_{i=1}^k \mathbf{B}_{i,y}$ are measurement operators on the particles shared with observers $\mathcal{A}_1, \mathcal{A}_2, \dots, \mathcal{A}_k$; $\mathbf{B}_{r,y}$ are measurement operators of observer \mathcal{B} on his own particles without being shared with other observers [8].

Now, we continue the proof. From the equalities $\langle \Phi_i | \sigma_z^{\otimes 2} | \Phi_i \rangle = 1$, $\langle \Phi_i | \sigma_x^{\otimes 2} | \Phi_i \rangle = 2a_i b_i$, and $\langle \Phi_i | \sigma_z \otimes \sigma_x | \Phi_i \rangle = \langle \Phi_i | \sigma_x \otimes \sigma_z | \Phi_i \rangle = 0$, we have $\frac{1}{2} \sum_{x_i=0}^1 \langle \Xi_i | A_{x_i} \otimes B_{i,y=0} | \Xi_i \rangle = \cos \theta_i$, where $|\Xi_i\rangle = \otimes_{j=t_{i-1}+1}^{t_i} |\Phi_j\rangle$, $i = 1, 2, \dots, k$. So, from Eqs.(4), (5), and (C1)-(C5) we obtain that

$$\begin{aligned} I_{k+1,k}^q &= \frac{1}{2^k} \sum_{x_1, x_2, \dots, x_k} \langle \Xi | (\otimes_{i=1}^k \mathbf{A}_{x_i}) \otimes \mathbf{B}_{y=0} | \Xi \rangle \\ &= \langle \Xi_r | \mathbf{B}_{r,y=0} | \Xi_r \rangle \prod_{i=1}^k \left(\frac{1}{2} \sum_{x_i=0}^1 \langle \Xi_i | \mathbf{A}_{x_i} \otimes \mathbf{B}_{i,y=0} | \Xi_i \rangle \right) \\ &= \prod_{i=1}^k \cos \theta_i, \end{aligned} \quad (\text{C8})$$

where we have taken use of the equality $\langle \Xi_r | \mathbf{B}_{r,y=0} | \Xi_r \rangle = 1$ with $|\Xi_r\rangle = \otimes_{j=m-t_k+1}^m |\Phi_j\rangle$.

Similarly, it is easy to evaluate $\frac{1}{2} \sum_{x_i=0}^1 (-1)^{x_i} \langle \Xi_i | \mathbf{A}_{x_i} \otimes \mathbf{B}_{i,y=1} | \Xi_i \rangle = 2a_i b_i \sin \theta_i$, $i = 1, 2, \dots, k$. So, we can obtain that

$$\begin{aligned} J_{k+1,k}^q &= \frac{1}{2^k} \sum_{x_1, x_2, \dots, x_k} (-1)^{\sum_{i=1}^k x_i} \langle \Xi | (\otimes_{i=1}^k \mathbf{A}_{x_i}) \otimes \mathbf{B}_{y=1} | \Xi \rangle \\ &= \langle \Xi_r | \mathbf{B}_{r,y=1} | \Xi_r \rangle \prod_{i=1}^k \left(\frac{1}{2} \sum_{x_i=0}^1 (-1)^{x_i} \langle \Xi_i | \mathbf{A}_{x_i} \otimes \mathbf{B}_{i,y=1} | \Xi_i \rangle \right) \\ &= \prod_{i=1}^k \prod_{j=1}^m \sin \theta_i c_j, \end{aligned} \quad (\text{C9})$$

where we have taken use of the equality $\langle \Xi_r | \mathbf{B}_{r,y=1} | \Xi_r \rangle = \prod_{j=m-t_k+1}^m c_j$ with $c_j = 2a_j b_j$.

From the presented Lemma in Appendix B1, and Eqs.(C8) and (C9), it is easy to prove that

$$\begin{aligned} \max_{\theta_1, \theta_2, \dots, \theta_k} \{ |I_{k+1,k}^q|^{\frac{1}{k}} + |J_{k+1,k}^q|^{\frac{1}{k}} \} &= \sqrt{1 + \prod_{i=1}^m c_i^{\frac{2}{k}}} \\ &> 1 \end{aligned} \quad (\text{C10})$$

when all parameters c_i satisfy $\prod_{i=1}^m c_i \neq 0$, where the maximum is achieved when $\cos \theta_1 = \cos \theta_2 = \dots = \cos \theta_k = 1/\sqrt{1 + \prod_{i=1}^m c_i^{\frac{2}{k}}}$.

Note that all observables of observer \mathcal{B} are products of Pauli operators and identity operator. The expectation equals mathematically to that of the same operators being separately performed by all observers except for $\mathcal{A}_1, \mathcal{A}_2, \dots, \mathcal{A}_k$ in the original network \mathbf{G}_q in Fig.1. Thus, $I_{k+1,k}^q$ and $J_{k+1,k}^q$ are essentially linear combinations of multi-partite correlations generated by all observers in \mathbf{G}_q . Combined with Eq.(C10), the multipartite quantum correlations of \mathbf{G}_q violate the nonlinear inequality in Eq.(6). Hence, there exist specific observables for each observer of \mathbf{G}_q with multiple independent observers such that the prediction of the quantum theory is inconsistent with the generalized local realism. \square

Appendix C2: Arbitrary bipartite entangled pure states as quantum resources

We assume that the quantum resources consist of pure bipartite entanglement pairs:

$$\hat{\Xi} = \otimes_{i=1}^m |\Phi_i\rangle, \quad (\text{C11})$$

where $|\Phi_i\rangle = a_i |\phi_i\rangle |\psi_i\rangle + b_i |\phi_i^\perp\rangle |\psi_i^\perp\rangle + \sum_{j \in \mathcal{I}_i} |\phi_{i,j}\rangle |\psi_{i,j}\rangle$ denote general bipartite entangled pure states with positive real coefficients a_i, b_i satisfying $a_i^2 + b_i^2 \leq 1$ in Hilbert space \mathbb{H} ; \mathcal{I}_i denotes an index set satisfying that $\{|\phi_i\rangle, |\phi_i^\perp\rangle, |\phi_{i,j}\rangle, j \in \mathcal{I}_i\}$ is a set of the orthogonal states in Hilbert space $\mathbb{H}_{i,1}$ and $\{|\psi_i\rangle, |\psi_i^\perp\rangle, |\psi_{i,j}\rangle, j \in \mathcal{I}_i\}$ is a set of the orthogonal states in Hilbert space $\mathbb{H}_{i,2}$; and $\mathbb{H}_{i,1} \otimes \mathbb{H}_{i,2} = \mathbb{H}$, $i = 1, 2, \dots, m$.

Note that each bipartite entangled pure state may be decomposed into $|\Phi_i\rangle$ with special orthogonal states $|\phi_i\rangle, |\phi_i^\perp\rangle, |\psi_i\rangle, |\psi_i^\perp\rangle, |\phi_{i,j}\rangle, |\psi_{i,j}\rangle, j \in \mathcal{I}_i$. Each bipartite pure state $|\Phi_i\rangle$ is entangled if and only if $a_i \neq 0$ and $b_i \neq 0$ (up to permutations of basis states).

Assume that two observers \mathcal{A}_i and \mathcal{B} share ℓ_i bipartite pure entanglements $|\Phi_{t_{i-1}+1}\rangle, |\Phi_{t_{i-1}+2}\rangle, \dots, |\Phi_{t_i}\rangle$ with $t_i = \sum_{j=1}^i \ell_j$ and $t_0 = 0$, $i = 1, 2, \dots, k$. Here, we donot need to consider these entanglements owned by single observer \mathcal{A}_i . Denote the matrices

$$\hat{\sigma}_{z,i} = |\phi_i\rangle \langle \phi_i| - |\phi_i^\perp\rangle \langle \phi_i^\perp|, \quad (\text{C12})$$

$$\hat{\sigma}_{x,i} = |\phi_i\rangle \langle \phi_i^\perp| + |\phi_i^\perp\rangle \langle \phi_i|, \quad (\text{C13})$$

$$\tilde{\sigma}_{z,i} = |\psi_i\rangle \langle \psi_i| - |\psi_i^\perp\rangle \langle \psi_i^\perp|, \quad (\text{C14})$$

$$\tilde{\sigma}_{x,i} = |\psi_i\rangle \langle \psi_i^\perp| + |\psi_i^\perp\rangle \langle \psi_i|, \quad (\text{C15})$$

where $i = 1, 2, \dots, m$.

Define the operators \mathbf{A}_{x_i} on the particles owned by the observer \mathcal{A}_i as

$$\mathbf{A}_{x_i} = \begin{cases} (\cos \theta_i (\otimes_{j=t_{i-1}+1}^{t_i-1} \hat{\sigma}_{z,j}) \otimes \hat{\mathbf{I}}_{2,t_i} \\ \quad + (-1)^{x_i} \sin \theta_i (\otimes_{j=t_{i-1}+1}^{t_i} \hat{\sigma}_{x,j})) \oplus \hat{\mathbf{I}}_{r,i}, & \text{for even } \ell_i; \\ (\cos \theta_i (\otimes_{j=t_{i-1}+1}^{t_i} \hat{\sigma}_{z,j}) \\ \quad + (-1)^{x_i} \sin \theta_i (\otimes_{j=t_{i-1}+1}^{t_i} \hat{\sigma}_{x,j})) \oplus \hat{\mathbf{I}}_{r,i}, & \text{for odd } \ell_i; \end{cases} \quad (\text{C16})$$

where $\hat{\mathbf{I}}_{2,t_i}$ denotes the identity operator on the subspace spanned by $\{|\phi_{t_i}\rangle, |\phi_{t_i}^\perp\rangle\}$; $\hat{\mathbf{I}}_{r,i}$ denotes the identity operator on the orthogonal complement of the subspace $\otimes_{j=t_{i-1}+1}^{t_i} \text{span}\{|\phi_j\rangle, |\phi_j^\perp\rangle\}$ in the Hilbert space $\otimes_{j=t_{i-1}+1}^{t_i} \mathbb{H}_{j,1}$; span denotes the spanned space using states $|\phi_j\rangle$ and $|\phi_j^\perp\rangle$; \oplus denotes the direct summation of two operators performed on two orthogonal subspaces; and $\theta_i \in [0, \frac{\pi}{2}]$, $i = 1, 2, \dots, k$.

Define the operators \mathbf{B}_y on the particles owned by the observer \mathcal{B} as

$$\mathbf{B}_y = (\otimes_{i=1}^k \mathbf{B}_{i,y}) \otimes \mathbf{B}_{r,y} \quad (\text{C17})$$

where $\mathbf{B}_{i,y}$ and $\mathbf{B}_{r,y}$ are given by

$$\mathbf{B}_{i,y} = \begin{cases} ((1-y)(\otimes_{j=t_{i-1}+1}^{t_i-1} \tilde{\sigma}_{z,j}) \otimes \tilde{\mathbf{I}}_{2,t_i} + y(\otimes_{j=t_{i-1}+1}^{t_i} \tilde{\sigma}_{x,j})) \oplus \tilde{\mathbf{I}}_{r,i}, & \text{for even } \ell_i; \\ ((1-y)(\otimes_{j=t_{i-1}+1}^{t_i} \tilde{\sigma}_{z,j}) + y(\otimes_{j=t_{i-1}+1}^{t_i} \tilde{\sigma}_{x,j})) \oplus \tilde{\mathbf{I}}_{r,i}, & \text{for odd } \ell_i; \end{cases} \quad (\text{C18})$$

and

$$\mathbf{B}_{r,y} = [(1-y) \otimes_{j=t_k+1}^m (\tilde{\sigma}_{z,j} \otimes \tilde{\sigma}_{z,j}) + y \otimes_{j=t_k+1}^m (\tilde{\sigma}_{x,j} \otimes \tilde{\sigma}_{x,j})] \oplus \tilde{\mathbf{I}}_r. \quad (\text{C19})$$

Here, $\tilde{\mathbf{I}}_{2,t_i}$ denotes the identity operator on the subspace spanned by $\{|\psi_{t_i}\rangle, |\psi_{t_i}^\perp\rangle\}$; $\tilde{\mathbf{I}}_{r,i}$ denotes the identity operator on the orthogonal complement of $\otimes_{j=t_{i-1}+1}^{t_i} \text{span}\{|\psi_j\rangle, |\psi_j^\perp\rangle\}$ in Hilbert space $\otimes_{j=t_{i-1}+1}^{t_i} \mathbb{H}_{j,2}$; and $\tilde{\mathbf{I}}_r$ denotes the identity operator on the orthogonal complement of the subspace $\otimes_{j=m-t_k+1}^m \text{span}\{|\phi_j\rangle, |\psi_j\rangle, |\phi_j^\perp\rangle, |\psi_j^\perp\rangle\}$ in Hilbert space $\otimes_{j=m-t_k+1}^m \mathbb{H}_j$.

Similar to Eqs.(C11)-(C15), it is easy to prove that all operators \mathbf{A}_{x_i} are unitary Hermitian, which may be used as observables of observers \mathcal{A}_i . Moreover, \mathbf{B}_y may be used as observables of observer \mathcal{B} because all operators $\mathbf{B}_{i,1}, \mathbf{B}_r$ are unitary Hermitian. Especially, in Eq.(C18), $\otimes_{i=1}^k \mathbf{B}_{i,y}$ are measurement operators of observer \mathcal{B} on the particles shared with observers $\mathcal{A}_1, \mathcal{A}_2, \dots, \mathcal{A}_k$; $\mathbf{B}_{r,y}$ in Eq.(C19) are measurement operators of observer \mathcal{B} on his own particles without being shared with other observers.

From Eqs.(C11)-(C15), we have $\langle \Phi_i | \hat{\sigma}_{z,i} \otimes \tilde{\sigma}_{z,i} | \Phi_i \rangle = a_i^2 + b_i^2$, $\langle \Phi_i | \hat{\sigma}_{x,i} \otimes \tilde{\sigma}_{x,i} | \Phi_i \rangle = 2a_i b_i$, and $\langle \Phi_i | \hat{\sigma}_{z,i} \otimes \tilde{\sigma}_{x,i} | \Phi_i \rangle = \langle \Phi_i | \hat{\sigma}_{x,i} \otimes \tilde{\sigma}_{z,i} | \Phi_i \rangle = 0$. Denote $|\hat{\Xi}_r\rangle = \otimes_{j=m-t_k+1}^m |\Phi_j\rangle$ and $|\hat{\Xi}_i\rangle = \otimes_{j=t_{i-1}+1}^{t_i} |\Phi_j\rangle$, where $i = 1, 2, \dots, k$. From Eqs.(C12)-(C19), we obtain the following equalities

$$\langle \hat{\Xi}_r | \mathbf{B}_{r,y=0} | \hat{\Xi}_r \rangle = 1, \quad (\text{C20})$$

$$\langle \hat{\Xi}_r | \mathbf{B}_{r,y=1} | \hat{\Xi}_r \rangle = 1 - \alpha + \beta, \quad (\text{C21})$$

$$\frac{1}{2} \sum_{x_i=0}^1 \langle \hat{\Xi}_i | \mathbf{A}_{x_i} \otimes \mathbf{B}_{i,y=0} | \hat{\Xi}_i \rangle = \alpha_i (\cos \theta_i - 1) + 1, \quad (\text{C22})$$

$$\frac{1}{2} \sum_{x_i=0}^1 (-1)^{x_i} \langle \hat{\Xi}_i | \mathbf{A}_{x_i} \otimes \mathbf{B}_{i,y=1} | \hat{\Xi}_i \rangle = \beta_i \sin \theta_i, \quad (\text{C23})$$

where $\alpha = \prod_{j=t_k+1}^m (a_j^2 + b_j^2)$, $\beta = \prod_{j=t_k+1}^m 2a_j b_j$, $\alpha_i = \prod_{j=t_{i-1}+1}^{t_i} (a_j^2 + b_j^2)$ and $\beta_i = \prod_{j=t_{i-1}+1}^{t_i} 2a_j b_j$, $i = 1, 2, \dots, k$.

Now, from Eqs.(4), (5), and (C18)-(C22), we obtain that

$$\begin{aligned} I_{k+1,k}^q &= \frac{1}{2^k} \sum_{x_1, x_2, \dots, x_k} \langle \hat{\Xi} | (\otimes_{i=1}^k \mathbf{A}_{x_i}) \otimes \mathbf{B}_{y=0} | \hat{\Xi} \rangle \\ &= \langle \hat{\Xi}_r | \mathbf{B}_{r,y=0} | \hat{\Xi}_r \rangle \prod_{i=1}^k \left(\frac{1}{2} \sum_{x_i=0}^1 \langle \hat{\Xi}_i | \mathbf{A}_{x_i} \otimes \mathbf{B}_{i,y=0} | \hat{\Xi}_i \rangle \right) \\ &= \prod_{i=1}^k ((\cos \theta_i - 1) \alpha_i + 1). \end{aligned} \quad (\text{C24})$$

Similarly, from Eqs.(4), (5), and (C18)-(C23), we can obtain that

$$\begin{aligned}
J_{k+1,k}^q &= \frac{1}{2^k} \sum_{x_1, x_2, \dots, x_k} (-1)^{\sum_{i=1}^k x_i} \langle \Xi | (\otimes_{i=1}^k \mathbf{A}_{x_i}) \otimes \mathbf{B}_{y=1} | \Xi \rangle \\
&= \langle \Xi_r | \mathbf{B}_{r,y=1} | \Xi_r \rangle \prod_{i=1}^k \left(\frac{1}{2} \sum_{x_i=0}^1 (-1)^{x_i} \langle \Xi_i | \mathbf{A}_{x_i} \otimes \mathbf{B}_{i,y=1} | \Xi_i \rangle \right) \\
&= (1 - \alpha + \beta) \prod_{i=1}^k \beta_i \sin \theta_i. \tag{C25}
\end{aligned}$$

Denote $\alpha_0 = \max\{\alpha_1, \alpha_2, \dots, \alpha_k\}$ and $\beta_0 = \min\{\beta_1, \beta_2, \dots, \beta_k\}$, where $0 \leq \alpha_0, \beta_0 \leq 1$. By setting $\theta_1 = \theta_2 = \dots = \theta_k = \theta$, from Eqs.(C24) and (C25) we obtain that

$$\begin{aligned}
|J_{k+1,k}^q|^{\frac{1}{k}} + |J_{k+1,k}^q|^{\frac{1}{k}} &\geq \alpha_0 \cos \theta + \beta_0 (1 - \alpha + \beta) \sin \theta - \alpha_0 + 1 \\
&= \sqrt{\alpha_0^2 + \beta_0^2 (1 - \alpha + \beta)^2} - \alpha_0 + 1 \\
&> 1 \tag{C26}
\end{aligned}$$

when $\beta_0 \neq 0$ or $\alpha - \beta \neq 1$, which are ensured by $\prod_{i=1}^m a_i b_i \neq 0$. Here, θ is given by $\cos \theta = \alpha_0 / \sqrt{\alpha_0^2 + \beta_0^2 (1 - \alpha + \beta)^2}$.

Note that all observables of observer \mathcal{B} are product operators and direct summation of identity operators. Hence, there exist observables for all observers except for $\mathcal{A}_1, \mathcal{A}_2, \dots, \mathcal{A}_k$ of the original network \mathbf{G}_q in Fig.1 such that $I_{k+1,k}^q$ and $J_{k+1,k}^q$ are functions of the multipartite correlations crossing the whole network \mathbf{G}_q . Thus, there exist specific observables for each observer of \mathbf{G}_q with multiple independent observers such that the prediction of the quantum theory is inconsistent with the generalized local realism.

Appendix C3: Hybrid resources of bipartite entangled pure states and GHZ states

We assume that the quantum resources consist of hybrid pure entanglement pairs:

$$|\Theta\rangle = \otimes_{i=1}^{m_1} \otimes_{j=1}^{m_2} |\Phi_i\rangle |\Psi_j\rangle, \tag{C27}$$

where $|\Phi_i\rangle$ are defined in Eq.(C11), and $|\Psi_j\rangle = \hat{a}_j |0\rangle^{\otimes s_j} + \hat{b}_j |1\rangle^{\otimes s_j}$ are GHZ states of s_j qubits with positive real coefficients \hat{a}_j, \hat{b}_j satisfying $\hat{a}_j^2 + \hat{b}_j^2 \leq 1, j = 1, 2, \dots, m_2$.

Firstly, we assume that all integers s_j are even. Assume that two observers \mathcal{A}_i and \mathcal{B} share ℓ_i bipartite entanglements $|\Phi_{t_{i-1}+1}\rangle, |\Phi_{t_{i-1}+2}\rangle, \dots, |\Phi_{t_i}\rangle$, and $\hat{\ell}_i$ GHZ states $|\Psi_{t_{i-1}+1}\rangle, |\Psi_{t_{i-1}+2}\rangle, \dots, |\Psi_{t_i}\rangle$, where $t_i = \sum_{j=1}^i \ell_j, \hat{t}_i = \sum_{j=1}^i \hat{\ell}_j$, and $t_0 = \hat{t}_0 = 0, i = 1, 2, \dots, k$. Here, we do not need to consider these entanglements owned by single observer \mathcal{A}_i .

Using Eqs.(C12)-(C15), if $\ell_i \neq 0$, define the operators \mathbf{A}_{x_i} on the particles owned by observer \mathcal{A}_i as

$$\mathbf{A}_{x_i} = \begin{cases} ((\cos \theta_i (\otimes_{j=t_{i-1}+1}^{t_i-1} \hat{\sigma}_{z,j}) \otimes \hat{\mathbf{I}}_2) \oplus \hat{\mathbf{I}}_{r,i}) \otimes \sigma_z^{\otimes L_i} \\ \quad + (-1)^{x_i} (\sin \theta_i (\otimes_{j=t_{i-1}+1}^{t_i-1} \hat{\sigma}_{x,j}) \oplus \hat{\mathbf{I}}_{r,i}) \otimes \sigma_x^{\otimes L_i}, & \text{for even } K_i; \\ (\cos \theta_i (\otimes_{j=t_{i-1}+1}^{t_i} \hat{\sigma}_{z,j}) \oplus \hat{\mathbf{I}}_{r,i}) \otimes \sigma_z^{\otimes L_i} \\ \quad + (-1)^{x_i} (\sin \theta_i (\otimes_{j=t_{i-1}+1}^{t_i-1} \hat{\sigma}_{x,j}) \oplus \hat{\mathbf{I}}_{r,i}) \otimes \sigma_x^{\otimes L_i}, & \text{for odd } K_i; \end{cases} \tag{C28}$$

Otherwise, define the operators \mathbf{A}_{x_i} as

$$\mathbf{A}_{x_i} = \begin{cases} \cos \theta_i (\sigma_z^{\otimes L_i-1} \otimes \mathbf{I}_2) + (-1)^{x_i} \sin \theta_i \sigma_x^{\otimes L_i}, & \text{for even } L_i; \\ \cos \theta_i \sigma_z^{\otimes L_i} + (-1)^{x_i} \sin \theta_i \sigma_x^{\otimes L_i}, & \text{for odd } L_i; \end{cases} \tag{C29}$$

where $\hat{\mathbf{I}}_2, \hat{\mathbf{I}}_{r,i}$ are defined in Eq.(C16); \mathbf{I}_2 is the identity operator on single qubit; $K_i = \ell_i + L_i$, and L_i is the number of particles (belonging to observer \mathcal{A}_i) in all GHZ state shared by observer \mathcal{A}_i and $\mathcal{B}, i = 1, 2, \dots, k$.

Using Eqs.(C12)-(C15) and (C17)-(C19), define the operators \mathbf{B}_y on the particles owned by observer \mathcal{B} as

$$\mathbf{B}_y = (\otimes_{i=1}^k \mathbf{B}_{i,y}) \otimes \mathbf{B}_{r,y}, \tag{C30}$$

where $B_{i,y}$ is given by

$$\mathbf{B}_{i,y} = \begin{cases} (1-y)((\otimes_{j=t_{i-1}+1}^{t_i-1} \tilde{\sigma}_{z,j}) \otimes \hat{\mathbf{I}}_2) \oplus \tilde{\mathbf{I}}_{r,i} \otimes \sigma_z^{\otimes N_i} \\ \quad + y((\otimes_{j=t_{i-1}+1}^{t_i} \tilde{\sigma}_{x,j}) \oplus \tilde{\mathbf{I}}_{r,j}) \otimes \sigma_x^{\otimes N_i}, & \text{for even } K_i; \\ (1-y)((\otimes_{j=t_{i-1}+1}^{t_i} \tilde{\sigma}_{z,j}) \oplus \tilde{\mathbf{I}}_{r,i}) \otimes \sigma_z^{\otimes N_i} \\ \quad + y((\otimes_{j=t_{i-1}+1}^{t_i} \tilde{\sigma}_{x,j}) \oplus \tilde{\mathbf{I}}_{r,i}) \otimes \sigma_x^{\otimes N_j}, & \text{for odd } K_i; \end{cases} \quad (\text{C31})$$

for $\ell_i \neq 0$, or

$$\mathbf{B}_{i,y} = \begin{cases} (1-y)(\sigma_z^{\otimes N_i-1} \otimes \mathbf{I}_2) + y\sigma_x^{\otimes N_i}, & \text{for even } N_i; \\ (1-y)\sigma_z^{\otimes N_i} + y\sigma_x^{\otimes N_i}, & \text{for odd } N_i; \end{cases} \quad (\text{C32})$$

for $\ell_i = 0$; and $\mathbf{B}_{r,y}$ is given by

$$\mathbf{B}_{r,y} = (1-y)((\otimes_{j=t_k+1}^m \hat{\sigma}_{z,j} \otimes \tilde{\sigma}_{z,j}) \oplus \hat{\mathbf{I}}_r) \otimes \sigma_z^{\otimes N} + y(\otimes_{j=t_k+1}^m (\hat{\sigma}_{x,j} \otimes \tilde{\sigma}_{x,j}) \oplus \hat{\mathbf{I}}_r) \otimes \sigma_x^{\otimes N}. \quad (\text{C33})$$

Here, N_i is the number of particles (belonging to observer \mathcal{B}) in all GHZ states shared by observer \mathcal{B} and \mathcal{A}_i ; and N is the number of particles in all GHZ states (belonging to observer \mathcal{B}) which has not shared with observers $\mathcal{A}_1, \mathcal{A}_2, \dots, \mathcal{A}_k$. $\tilde{\mathbf{I}}_{r,j}$ and $\tilde{\mathbf{I}}_r$ are the identity operators defined in respective Eq.(C18) and (C19).

Similar to Eqs.(C6) and (C7), we easily prove that all matrices \mathbf{A}_{x_i} are unitary Hermitian. Thus, they may be used as the observables of observers \mathcal{A}_i . Moreover, \mathbf{B}_y may be used as the observable of observer \mathcal{B} because all operators $\mathbf{B}_{i,y}$, $\mathbf{B}_{r,y}$ are direct sum of generalized Pauli matrices in Eqs.(C12)-(C15) and identity operators. In Eq.(C30), $\otimes_{i=1}^k \mathbf{B}_{i,y}$ are measurement operators of observer \mathcal{B} on the particles shared with observers $\mathcal{A}_1, \mathcal{A}_2, \dots, \mathcal{A}_k$; $\mathbf{B}_{r,y}$ are measurement operators of observer \mathcal{B} on his own particles without being shared with other observers.

Denote $|\Theta_r\rangle = \otimes_{i=t_k+1}^{m_1} \otimes_{j=\hat{t}_k+1}^{m_2} |\Phi_i\rangle |\Psi_j\rangle$ and $|\Theta_i\rangle = \otimes_{j=t_{i-1}+1}^{t_i} \otimes_{j=\hat{t}_{i-1}+1}^{\hat{t}_i} |\Phi_j\rangle |\Psi_j\rangle$, where $i = 1, 2, \dots, k$. From Eqs.(C30)-(C33), we obtain the following equalities

$$\langle \Theta_r | \mathbf{B}_{r,y=0} | \Theta_r \rangle = 1, \quad (\text{C34})$$

$$\langle \Theta_r | \mathbf{B}_{r,y=1} | \Theta_r \rangle = 1 - \gamma + \delta, \quad (\text{C35})$$

$$\frac{1}{2} \sum_{x_i=0}^1 \langle \Theta_i | \mathbf{A}_{x_i} \otimes \mathbf{B}_{i,y=0} | \Theta_i \rangle = (\cos \theta_i - 1) \gamma_i + 1, \quad (\text{C36})$$

$$\frac{1}{2} \sum_{x_i=0}^1 (-1)^{x_i} \langle \Theta_i | \mathbf{A}_{x_i} \otimes \mathbf{B}_{i,y=1} | \Theta_i \rangle = \delta_i \sin \theta_i, \quad (\text{C37})$$

where $\gamma = \prod_{j=t_k+1}^{m_1} (a_j^2 + b_j^2)$, $\delta = \prod_{j=t_k+1}^{m_1} \prod_{j=\hat{t}_k+1}^{m_2} 4a_j b_j \hat{a}_j \hat{b}_j$, $\gamma_i = \prod_{j=t_{i-1}+1}^{t_i} (a_j^2 + b_j^2)$, and $\delta_i = \prod_{j=t_{i-1}+1}^{t_i} \prod_{j=\hat{t}_{i-1}+1}^{\hat{t}_i} 4a_j b_j \hat{a}_j \hat{b}_j$, $i = 1, 2, \dots, k$.

Now, from Eqs.(4), (5), (C27) and (C34)-(C37), we obtain that

$$\begin{aligned} I_{k+1,k}^q &= \frac{1}{2^k} \sum_{x_1, x_2, \dots, x_k} \langle \Theta | (\otimes_{i=1}^k \mathbf{A}_{x_i}) \otimes \mathbf{B}_{y=0} | \Theta \rangle \\ &= \langle \Theta_r | \mathbf{B}_{r,y=0} | \Theta_r \rangle \prod_{i=1}^k \left(\frac{1}{2} \sum_{x_i=0}^1 \langle \Theta_i | \mathbf{A}_{x_i} \otimes \mathbf{B}_{i,y=0} | \Theta_i \rangle \right) \\ &= \prod_{i=1}^k (\gamma_i (\cos \theta_i - 1) + 1) \end{aligned} \quad (\text{C38})$$

and

$$\begin{aligned} J_{k+1,k}^q &= \frac{1}{2^k} \sum_{x_1, x_2, \dots, x_k} (-1)^{\sum_{i=1}^k x_i} \langle \Theta | (\otimes_{i=1}^k \mathbf{A}_{x_i}) \otimes \mathbf{B}_{y=1} | \Theta \rangle \\ &= \langle \Theta_r | \mathbf{B}_{r,y=1} | \Theta_r \rangle \prod_{i=1}^k \left(\frac{1}{2} \sum_{x_i=0}^1 (-1)^{x_i} \langle \Theta_i | \mathbf{A}_{x_i} \otimes \mathbf{B}_{i,y=1} | \Theta_i \rangle \right) \\ &= (1 - \gamma + \delta) \prod_{i=1}^k \delta_i \sin \theta_i. \end{aligned} \quad (\text{C39})$$

Denote $\gamma_0 = \max\{\gamma_1, \gamma_2, \dots, \gamma_k\}$ and $\delta_0 = \min\{\delta_1, \delta_2, \dots, \delta_k\}$, where $0 \leq \gamma_0, \delta_0 \leq 1$. Note that $\gamma \geq \delta$ and $\gamma_i \geq \delta_i$, $i = 1, 2, \dots, k$. By setting $\theta_1 = \theta_2 = \dots = \theta_k = \theta$, Eqs.(C38) and (C39) yield that

$$\begin{aligned} |I_{k+1,k}^q|^{\frac{1}{k}} + |J_{k+1,k}^q|^{\frac{1}{k}} &\geq \gamma_0 \cos \theta + \delta_0(1 - \gamma + \delta) \sin \theta - \gamma_0 + 1 \\ &= \sqrt{\gamma_0^2 + \delta_0^2(1 - \gamma + \delta)^2} - \gamma_0 + 1 \\ &> 1 \end{aligned} \quad (\text{C40})$$

when $\delta_0 \neq 0$ or $\gamma - \delta \neq 1$, which are ensured by $\prod_{i=1}^{m_1} \prod_{j=1}^{m_2} a_i b_i \hat{a}_j \hat{b}_j \neq 0$. Here, θ is given by $\cos \theta = \gamma_0 / \sqrt{\gamma_0^2 + \delta_0^2(1 - \gamma + \delta)^2}$.

Note that all observables of observer \mathcal{B} are product operators and direct sum of identity operators. Thus, there exist observables for all observers except for $\mathcal{A}_1, \mathcal{A}_2, \dots, \mathcal{A}_k$ in the network \mathcal{G}_q in Fig.1 such that $I_{k+1,k}^q$ and $J_{k+1,k}^q$ are functions of the multipartite correlations crossing the whole network \mathcal{G}_q . Hence, there exist specific observables for each observer of \mathcal{G}_q with multiple independent observers such that the prediction of the quantum theory is inconsistent with the generalized local realism.

Now, for general integers $s_j \geq 3$, assume s_1, s_2, \dots, s_d are odd integers and $s_{d+1}, s_{d+2}, \dots, s_{m_2}$ are even integers. The main idea is to replace one Pauli matrix σ_z with \mathbf{I}_2 for each GHZ state with odd number of particles. Note that all observables of observer \mathcal{B} are product operators and direct sum of identity operators. Similar to Eqs.(C30)-(C33), we can easily redefine \mathbf{B}_y by replacing one Pauli operator σ_z with \mathbf{I}_2 (In experiment, one can perform a measurement under the basis $\{|\pm\rangle\}$, and then output 1) for each GHZ state with odd number of particles. It implies that some observer may use commutative operators of $\{\mathbf{I}_2, \sigma_z\}$, which may be regarded as classical outputs. All operators \mathbf{A}_{x_i} are unchanged. Thus, we can obtain the same quantities of $I_{k+1,k}^q$ and $J_{k+1,k}^q$ in respective Eq.(C38) and (C39). The reason is derived from the fact that $\langle \Psi_j | \sigma_z^{\otimes s_j - 1} \otimes \mathbf{I}_2 | \Psi_j \rangle = 1$, $\langle \Psi_j | \sigma_x^{\otimes s_j} | \Psi_j \rangle = 2\hat{a}_j \hat{b}_j$ and $\langle \Psi_j | \sigma_z^{\otimes t} \otimes \sigma_x^{\otimes s_j - t} | \Psi_j \rangle = 0$ with $0 < t < s_j$, for odd integer s_j . The followed proof is omitted.

Appendix C4: The maximal violation of Theorem A

In this subsection we prove the possibility of the maximal violations with respect to the presented Tsirelson's bound in Eq.(7). It is sufficient to consider the inequality in Eq.(C40) for general quantum resources. In fact, the proof of the maximal violation is equivalent to $\max_{\theta_i} \{|I_{k+1,k}^q|^{\frac{1}{k}} + |J_{k+1,k}^q|^{\frac{1}{k}}\} = \sqrt{2}$. From Eqs.(C38) and (C39) and $\delta_i \leq \gamma_i$, we obtain that

$$|I_{k+1,k}^q|^{\frac{1}{k}} + |J_{k+1,k}^q|^{\frac{1}{k}} \leq \left| \prod_{i=1}^k (\gamma_i (\cos \theta_i - 1) + 1) \right|^{\frac{1}{k}} + \left| \prod_{i=1}^k \delta_i \right|^{\frac{1}{k}} \left| \prod_{i=1}^k \sin \theta_i \right|^{\frac{1}{k}} \quad (\text{C41})$$

$$= \left| \prod_{i=1}^k \cos \theta'_i \right|^{\frac{1}{k}} + \left| \prod_{i=1}^k \delta_i \right|^{\frac{1}{k}} \left| \prod_{i=1}^k \sin \theta_i \right|^{\frac{1}{k}} \quad (\text{C42})$$

$$\leq \cos\left(\frac{1}{k} \sum_{i=1}^k \theta'_i\right) + \prod_{i=1}^k \delta_i^{\frac{1}{k}} \sin\left(\frac{1}{k} \sum_{i=1}^k \theta_i\right), \quad (\text{C43})$$

where $\cos \theta'_i := \gamma_i (\cos \theta_i - 1) + 1$ with $\theta'_i \in [0, \pi/2]$ in Eq.(C42), and the inequality in Eq.(C43) is from the presented Lemma in Appendix B1. The equality in Eq.(C43) holds if and only if $\theta'_1 = \theta'_2 = \dots = \theta'_k$ (which is denoted as θ' for simplicity) and $\theta_1 = \theta_2 = \dots = \theta_k$ (which is denoted as θ). These conditions imply that $\gamma_1 = \gamma_2 = \dots = \gamma_k$, which is denoted as γ . Thus, we obtain that

$$\begin{aligned} \max_{\theta} \{|I_{k+1,k}^q|^{\frac{1}{k}} + |J_{k+1,k}^q|^{\frac{1}{k}}\} &\leq \gamma (\cos \theta - 1) + 1 + \prod_{i=1}^k \delta_i^{\frac{1}{k}} \sin \theta \\ &\leq \sqrt{\gamma^2 + \prod_{i=1}^k \delta_i^{\frac{2}{k}} + 1 - \gamma} \end{aligned} \quad (\text{C44})$$

$$\leq (\sqrt{2} - 1)\gamma + 1 \quad (\text{C45})$$

$$\leq \sqrt{2}, \quad (\text{C46})$$

where the inequality in Eq.(C44) is from the inequality $x \sin \theta + y \cos \theta \leq \sqrt{x^2 + y^2}$; the inequality in Eq.(C45) is from the inequality $\prod_{i=1}^k \delta_i^{\frac{2}{k}} \leq \prod_{i=1}^k \gamma_i^{\frac{2}{k}} = \gamma^2$; and the inequality in Eq.(C46) is from the inequality $\gamma \leq 1$.

Note that the equality in Eq.(C41) holds if and only if $\gamma = \delta$, which follows that the bipartite entanglements of $|\Phi_{t_k+1}\rangle, |\Phi_{t_k+2}\rangle, \dots, |\Phi_{m_1}\rangle$ are maximally entangled EPR states, and GHZ states $|\Phi_{\hat{t}_k+1}\rangle, |\Phi_{\hat{t}_k+2}\rangle, \dots, |\Phi_{m_2}\rangle$ are maximally entangled. The equality in Eq.(C44) holds if and only if $\cos \theta = \gamma / \sqrt{\gamma^2 + \prod_{i=1}^k \gamma_i^{\frac{2}{k}}}$. The equality in Eq.(C45) holds if and only if $a_i = b_i$ for all i . The equality in Eq.(C46) holds if and only if $\gamma = 1$ which implies $a_i = b_i = 1/\sqrt{2}$ for all i . Consequently, the violation in Eq.(C40) is maximal with respect to Tsirelson's bound in Eq.(7) if and only if the maximally entangled EPR states and GHZ states are consisted of quantum resources.

Appendix C5: Non-multilocality of quantum networks consisting of unknown EPR states and GHZ states

In some cases, all parameters of EPR states and GHZ states may be unknown or partially unknown for some observers. For an example, the maximally entangled EPR state may evolve to a partial entanglement because of a non-isolated system. This problem has not been theoretically considered in terms of the nonlocality. Fortunately, Eqs.(C38)-(C40) allow us to probabilistically complete verifying violation. By setting $\min\{\theta_1, \theta_2, \dots, \theta_k\} = \theta$, from Eqs.(C38) and (C39), we obtain that

$$\begin{aligned} |J_{k+1,k}^q|^{\frac{1}{k}} + |J_{k+1,k}^q|^{\frac{1}{k}} &\geq \gamma_0 \cos \theta + \delta_0(1 - \gamma + \delta) \sin \theta - \gamma_0 + 1 \\ &\approx \gamma_0(1 - \frac{1}{2}\theta^2) + \delta_0(1 - \gamma + \delta)\theta - \gamma_0 + 1 \\ &= \theta(\delta_0(1 - \gamma + \delta) - \frac{1}{2}\gamma_0\theta) + 1 \\ &> 1 \end{aligned} \tag{C47}$$

when $\delta_0(1 - \gamma + \delta) > \frac{1}{2}\gamma_0\theta$, which is ensured by $\theta < 2\delta_0(1 - \gamma + \delta)$ and $\delta - \gamma < 1$. This implies a simple method for each observer who chooses an observable with a small $\theta_i > 0$ for unknown EPR states and GHZ states as quantum resources.

Appendix D: Proof of Theorem B

In this section, we prove Theorem B. For convenience, we take use of the notations in Appendix C. Assume a general quantum network with n observers has an equivalent network in Fig.2, i.e, there are k independent observers without sharing quantum resources. In what follows, consider the noisy channels of Werner states:

$$\rho = (\otimes_{i=1}^{m_1} (v_i |\Phi_i\rangle\langle\Phi_i| + \frac{1-v_i}{4} \mathbf{I}_4)) \otimes (\otimes_{j=1}^{m_2} (w_j |\Psi_j\rangle\langle\Psi_j| + \frac{1-w_j}{2^{s_j}} \mathbf{I}_{2^{s_j}})), \tag{D1}$$

where $|\Phi_i\rangle$ are EPR states defined in Eq.(C1), and $|\Psi_j\rangle$ are GHZ states defined in Eq.(C27). $\mathbf{I}_{2^{s_j}}$ are the 2^{s_j} square identity matrices.

Denote the subsystems ρ_0, ρ_i as

$$\rho_0 = (\otimes_{i=t_k+1}^{m_1} (v_i |\Phi_i\rangle\langle\Phi_i| + \frac{1-v_i}{4} \mathbf{I}_4)) \otimes (\otimes_{j=\hat{t}_k+1}^{m_2} (w_j |\Psi_j\rangle\langle\Psi_j| + \frac{1-w_j}{2^{s_j}} \mathbf{I}_{2^{s_j}})), \tag{D2}$$

$$\rho_i = (\otimes_{j=t_{i-1}+1}^{t_i} (v_i |\Phi_i\rangle\langle\Phi_i| + \frac{1-v_i}{4} \mathbf{I}_4)) \otimes (\otimes_{j=\hat{t}_{i-1}+1}^{\hat{t}_i} (w_j |\Psi_j\rangle\langle\Psi_j| + \frac{1-w_j}{2^{s_j}} \mathbf{I}_{2^{s_j}})), \tag{D3}$$

where $i = 1, 2, \dots, k$.

From Eqs.(C30)-(C33) (without $\hat{\mathbf{I}}_{r,i}$ and $\tilde{\mathbf{I}}_{r,i}$), we obtain the following equalities

$$\text{Tr}(\mathbf{B}_{r,y=0}\rho_0) = \prod_{i=t_k+1}^{m_1} \prod_{j=\hat{t}_k+1}^{m_2} v_i w_j, \quad (\text{D3})$$

$$\text{Tr}(\mathbf{B}_{r,y=1}\rho_0) = \prod_{i=t_k+1}^{m_1} \prod_{j=\hat{t}_k+1}^{m_2} v_i c_i w_j \hat{c}_j, \quad (\text{D4})$$

$$\frac{1}{2} \sum_{x_i=0}^1 \text{Tr}((\mathbf{A}_{x_i} \otimes \mathbf{B}_{i,y=0})\rho_i) = \prod_{j=t_{i-1}+1}^{t_i} \prod_{j=\hat{t}_{i-1}+1}^{\hat{t}_i} \cos \theta_j v_j w_j, \quad (\text{D5})$$

$$\frac{1}{2} \sum_{x_i=0}^1 (-1)^{x_i} \text{Tr}((\mathbf{A}_{x_i} \otimes \mathbf{B}_{i,y=1})\rho_i) = \prod_{j=t_{i-1}+1}^{t_i} \prod_{j=\hat{t}_{i-1}+1}^{\hat{t}_i} \sin \theta_j v_j c_j w_j \hat{c}_j, \quad (\text{D6})$$

where $c_j = 2a_j b_j$ and $\hat{c}_j = 2\hat{a}_j \hat{b}_j$.

From Eqs.(D1)-(D6), we have

$$\begin{aligned} I_{k+1,k}^q &= \sum_{x_1, x_2, \dots, x_k} \text{Tr}[(\otimes_{i=1}^k \mathbf{A}_{x_i}) \otimes \mathbf{B}_{y=0}] \rho \\ &= \text{Tr}(\mathbf{B}_{r,y=0}\rho_0) \prod_{i=1}^k \left(\frac{1}{2} \sum_{x_i=0}^1 \text{Tr}((\mathbf{A}_{x_i} \otimes \mathbf{B}_{i,y=0})\rho_i) \right) \\ &= \prod_{i=1}^k \prod_{j=1}^{m_1} \prod_{j=1}^{m_2} \cos \theta_i v_j w_j \end{aligned} \quad (\text{D7})$$

and

$$\begin{aligned} J_{k+1,k}^q &= \sum_{x_1, x_2, \dots, x_k} (-1)^{\sum_{i=1}^k x_i} \text{Tr}[(\otimes_{i=1}^k \mathbf{A}_{x_i}) \otimes \mathbf{B}_{y=1}] \rho \\ &= \text{Tr}(\mathbf{B}_{r,y=1}\rho_0) \prod_{i=1}^k \left(\frac{1}{2} \sum_{x_i=0}^1 (-1)^{x_i} \text{Tr}((\mathbf{A}_{x_i} \otimes \mathbf{B}_{i,y=1})\rho_i) \right) \\ &= \prod_{i=1}^k \prod_{j=1}^{m_1} \prod_{j=1}^{m_2} \sin \theta_i c_j v_j \hat{c}_j w_j. \end{aligned} \quad (\text{D8})$$

From the presented Lemma in Appendix B1, we get that

$$\max_{\theta_1, \theta_2, \dots, \theta_k} \{ |I_{k+1,k}^q|^{\frac{1}{k}} + |J_{k+1,k}^q|^{\frac{1}{k}} \} = \prod_{i=1}^{m_1} \prod_{j=1}^{m_2} v_i^{\frac{1}{k}} w_j^{\frac{1}{k}} \sqrt{1 + \prod_{i=1}^{m_1} \prod_{j=1}^{m_2} c_i^{\frac{2}{k}} \hat{c}_j^{\frac{2}{k}}}, \quad (\text{D9})$$

where the maximum is achieved when $\cos \theta_1 = \cos \theta_2 = \dots = \cos \theta_k = 1/\sqrt{1 + \prod_{i=1}^{m_1} \prod_{j=1}^{m_2} (c_i \hat{c}_j)^{\frac{2}{k}}}$. Eq.(D9) implies that the product of critical viabilities v_j^*, \hat{v}_j^* is given by

$$\prod_{i=1}^{m_1} \prod_{j=1}^{m_2} v_i^* w_j^* = \frac{1}{(1 + \prod_{i=1}^{m_1} \prod_{j=1}^{m_2} c_i^{\frac{2}{k}} \hat{c}_j^{\frac{2}{k}})^{\frac{k}{2}}} \quad (\text{D10})$$

for which the multipartite correlations violate the presented Bell inequality in Eq.(6).

Appendix E: The comparison of the visibilities for the network in Fig.3(a)

For the chain-shaped network in Fig.3(a), assume that the total system consists of Werner states:

$$\rho = \otimes_{i=1}^{n-1} \rho_{\Phi_i}, \quad (\text{E1})$$

where $\rho_{\Phi_i} = v_i |\Phi_i\rangle\langle\Phi_i| + \frac{1-v_i}{4} \mathbf{I}_4$ with EPR states $|\Phi_i\rangle$ and the 4 square identity matrix \mathbf{I}_4 , and $0 < v_i < 1$, $i = 1, 2, \dots, n-1$. Here, the observers \mathcal{A}_i and \mathcal{A}_{i+1} share an EPR state in the form of ρ_{Φ_i} , $i = 1, 2, \dots, n-1$.

Note that there are at most $k = \lceil \frac{n}{2} \rceil$ independent observers without sharing entanglements, where $\lceil x \rceil$ denotes the smallest integer no less than x . From Theorem B, the product of the critical visibilities v_i^* is given by

$$\begin{aligned} \prod_{i=1}^{n-1} v_i^* &= \frac{1}{(\max_{\theta} \{|I_{n,k}^q|^{\frac{1}{k}} + |J_{n,k}^q|^{\frac{1}{k}}\})^k} \\ &= \frac{1}{(1 + \prod_{i=1}^{n-1} c_i^{\frac{2}{k}})^{\frac{k}{2}}} \\ &= \frac{1}{\sqrt{\sum_{i=0}^k f_i(c)}} \\ &\geq \frac{1}{\sum_{j=0}^{n-1} g_j(c)} \end{aligned} \quad (\text{E2})$$

$$\geq \hat{v}_i \quad (\text{E3})$$

$$= \prod_{j=1}^{n-1} \frac{1}{\sqrt{1 + c_j^2}}, \quad (\text{E4})$$

for which the multipartite correlations of this quantum network violate the inequality in Eq.(6), where $f_i(c) = \binom{k}{i} c^{2i/k}$, $g_j(c) = \binom{n}{j} c^{2j/n}$, $\binom{t}{s}$ is a binomial coefficient given by $(t(t-1)\dots(t-s+1))/(s(s-1)\dots 1)$, $c = \prod_{j=1}^{n-1} c_j$, and $c_j = 2a_j b_j$, $i = 0, 1, \dots, k$; $j = 0, 1, \dots, n-1$. Here, the inequality in Eq.(E2) is from the inequalities $f_i(c) \leq g_i(c)$ which are derived from $\binom{n}{i} \geq \binom{k}{i}$ and $c^{2i/n} > c^{2i/k}$ with $c \leq 1$, $i = 0, 1, \dots, k$; the inequality in Eq.(E3) is from the algebraic inequality $\sum_{\mathcal{J}_i} \prod_{j \in \mathcal{J}_i} c_j^2 \geq \binom{n}{i} c^{2i/n}$, where \mathcal{J}_i denotes the subset of $\{0, 1, \dots, n-1\}$ with i integers; and the summation is evaluated over all possible subsets \mathcal{J}_i , $i = 0, 1, \dots, n-1$. \hat{v}_i in Eq.(E3) denotes the visibility of EPR state $|\Phi_i\rangle$ [9].

F: Supplementary networks

In this section, we provide additional networks in Fig.S3 beyond the presented examples in main text. Specially, there are two loops in the first network shown in Fig.S3(a), where one four-partite GHZ state and 4 EPR states are consisted of hybrid quantum resources. Two independent observers are shown in the Figure as red squares. From Theorem A, the multipartite quantum correlations violate the presented Bell inequality in Eq.(6) with $k = 2$. The second is a butterfly network with one four-partite GHZ state and 5 EPR states as hybrid quantum resources in Fig.S3(b). This is an interesting example in classical network [10] or quantum network for multicast task [11]. The multipartite quantum correlations violate the presented Bell inequality in Eq.(6) with $k = 3$, where 3 independent observers are represented by red squares. There are multiple loops in the third network shown in Fig.S3(c), where two n -partite GHZ states and n EPR states are consisted of hybrid quantum resources. There are $2n$ observers, and each of them has two particles. Only two independent observers are shown with red squares. The last one is a boat-type network with 4 GHZ states and 8 EPR states as hybrid quantum resources (Fig.S3(d)). The multipartite correlations of this network violate the presented inequality (6) with $k = 5$. In addition to these examples, one may easily construct lots of networks depending on special tasks.

Appendix G: The non-multilocality of quantum network consisting of general noisy states

In this section, we provide some sufficient conditions of the non-multilocality for quantum networks consisting of general noisy states. For convenience of statements, denote $\sigma_1 := \mathbf{I}_2$, $\sigma_2 := \sigma_x$, $\sigma_3 := \sigma_y$, and $\sigma_4 := \sigma_z$.

Assume that the given quantum network has an equivalent network in Fig.2. Consider the noisy states:

$$\rho = \otimes_{i=1}^{m_1} \otimes_{j=1}^{m_2} \hat{\rho}_i \tilde{\rho}_j, \quad (\text{G1})$$

where $\hat{\rho}_i$ are two-particle systems in the state $\hat{\rho}_i = \frac{1}{4} \sum_{j_1, j_2=1}^4 v_{j_1 j_2}^i \sigma_{j_1} \otimes \sigma_{j_2}$ with $v_{11}^i = 1$, and $\tilde{\rho}_j$ are s_j -particle systems in the state $\tilde{\rho}_j = \frac{1}{2^{s_j}} \sum_{i_1, i_2, \dots, i_{s_j}=1}^4 w_{i_1 i_2 \dots i_{s_j}}^j \otimes_{t=1}^{s_j} \sigma_{i_t}$ with $w_{11 \dots 1}^j = 1$. It has been proved that $|v_{j_1 j_2}^i| \leq 1$

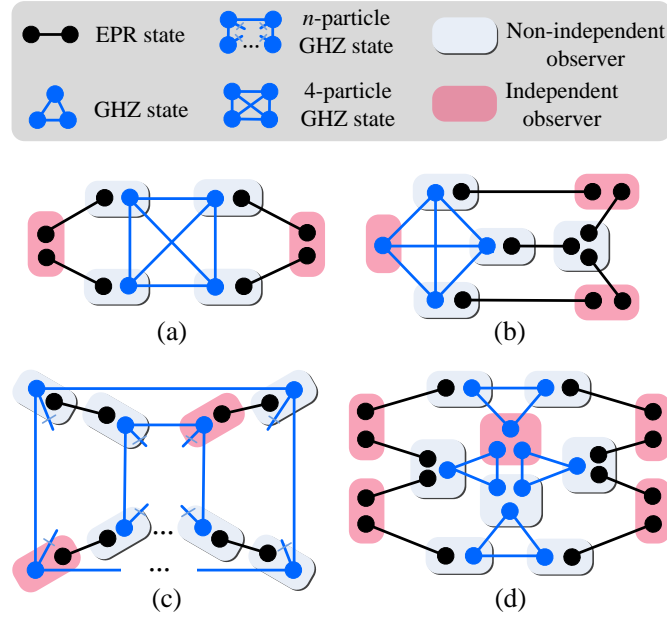

FIG. 6: (Color online) Simple networks whose multipartite correlations violate the presented Bell inequalities (6). (a) Cyclic network of two loops with one four-partite GHZ state and 4 EPR states as hybrid quantum resources. (b) Butterfly network with one four-partite GHZ state and 5 EPR states as hybrid quantum resources. (c) Hybrid network two n -partite GHZ states and n EPR states as quantum resources. Here $n \geq 2$. (d) Boat network with 4 GHZ states, and 8 EPR states as hybrid quantum resources. Here, each dot denotes one particle. Each n -partite GHZ state is represented with a complete graph of n vertices.

for every quantum states of two qubits [12]. For any quantum state of s_j qubits, we obtain that $w_{i_1 i_2 \dots i_{s_j}}^j \leq 1$ from $\text{Tr}(\hat{\rho}_j^2) \leq 1$.

Here, we take use of notations in Appendix C3. Denote the subsystems ρ_{Θ_r} , ρ_{Θ_i} as

$$\rho_0 = \otimes_{i=\hat{t}_k+1}^{m_1} \otimes_{j=\hat{t}_k+1}^{m_2} \hat{\rho}_i \otimes \tilde{\rho}_j, \quad (\text{G2})$$

$$\rho_i = \otimes_{j=\hat{t}_{i-1}+1}^{t_i} \otimes_{j=\hat{t}_{i-1}+1}^{\hat{t}_i} \hat{\rho}_j \otimes \tilde{\rho}_j, \quad (\text{G3})$$

where $i = 1, 2, \dots, k$.

From Eqs.(C30)-(C33) (without $\hat{\mathbf{I}}_{r,i}$ and $\tilde{\mathbf{I}}_{r,i}$) and Eqs.(G2)-(G3), we obtain the following results

$$\text{Tr}(\mathbf{B}_{r,y=0}\rho_0) = \prod_{i=\hat{t}_k+1}^{m_1} \prod_{j=\hat{t}_k+1}^{m_2} v_{44}^i w_{44\dots 4}^j, \quad (\text{G4})$$

$$\text{Tr}(\mathbf{B}_{r,y=1}\rho_0) = \prod_{i=\hat{t}_k+1}^{m_1} \prod_{j=\hat{t}_k+1}^{m_2} v_{22}^i w_{22\dots 2}^j, \quad (\text{G5})$$

$$\left| \frac{1}{2} \sum_{x_i=0}^1 \text{Tr}((\mathbf{A}_{x_i} \otimes \mathbf{B}_{i,y=0})\rho_i) \right| \geq \prod_{j=\hat{t}_{i-1}+1}^{t_i} \prod_{j=\hat{t}_{i-1}+1}^{\hat{t}_i} \cos \theta_j |v_{44}^j w_{44\dots 4}^j|, \quad (\text{G6})$$

$$\left| \frac{1}{2} \sum_{x_i=0}^1 (-1)^{x_i} \text{Tr}((\mathbf{A}_{x_i} \otimes \mathbf{B}_{i,y=1})\rho_i) \right| \geq \prod_{j=\hat{t}_{i-1}+1}^{t_i} \prod_{j=\hat{t}_{i-1}+1}^{\hat{t}_i} \sin \theta_j |v_{22}^j w_{22\dots 2}^j|, \quad (\text{G7})$$

where Eqs.(G6) and (G7) are derived from the inequalities $v_{11}^j = 1 \geq v_{44}^j$ and $w_{11\dots 1}^j = 1 \geq w_{44\dots 4}^j$ when K_i is even and $\ell_i \neq 0$; or L_i is even and $\ell_i = 0$.

From Eqs.(G1)-(G9), we obtain that

$$\begin{aligned}
|I_{k+1,k}^q| &= \left| \sum_{x_1, x_2, \dots, x_k} \text{Tr}(\left(\left(\otimes_{i=1}^k \mathbf{A}_{x_i}\right) \otimes \mathbf{B}_{y=0}\right)\rho) \right| \\
&= |\text{Tr}(\mathbf{B}_{r,y=0}\rho_0)| \prod_{i=1}^k \left| \frac{1}{2} \sum_{x_i=0}^1 \text{Tr}(\mathbf{A}_{x_i} \otimes \mathbf{B}_{i,y=0})\rho_i \right| \\
&\geq \prod_{i=1}^k \prod_{j=1}^{m_1} \prod_{j=1}^{m_2} \cos \theta_i v_{44}^j w_{44\dots 4}^j
\end{aligned} \tag{G8}$$

and

$$\begin{aligned}
|J_{k+1,k}^q| &= \left| \sum_{x_1, x_2, \dots, x_k} (-1)^{\sum_{i=1}^k x_i} \text{Tr}(\left(\left(\otimes_{i=1}^k \mathbf{A}_{x_i}\right) \otimes \mathbf{B}_{y=1}\right)\rho) \right| \\
&= |\text{Tr}(\mathbf{B}_{r,y=1}\rho_0)| \prod_{i=1}^k \left| \frac{1}{2} \sum_{x_i=0}^1 (-1)^{x_i} \text{Tr}(\mathbf{A}_{x_i} \otimes \mathbf{B}_{i,y=1})\rho_i \right| \\
&\geq \prod_{i=1}^k \prod_{j=1}^{m_1} \prod_{j=1}^{m_2} \sin \theta_i v_{22}^j w_{22\dots 2}^j.
\end{aligned} \tag{G9}$$

From the presented Lemma in Appendix B1, we get that

$$\max_{\theta_1, \theta_2, \dots, \theta_k} \{|I_{k+1,k}^q|^{\frac{1}{k}} + |J_{k+1,k}^q|^{\frac{1}{k}}\} \geq \sqrt{\prod_{i=1}^{m_1} \prod_{j=1}^{m_2} (v_{22}^i w_{22\dots 2}^j)^{\frac{2}{k}} + \prod_{i=1}^{m_1} \prod_{j=1}^{m_2} (v_{44}^i w_{44\dots 4}^j)^{\frac{2}{k}}}, \tag{G10}$$

where the maximum is achieved when $\cos \theta_1 = \cos \theta_2 = \dots = \cos \theta_k = \prod_{i=1}^{m_1} \prod_{j=1}^{m_2} (v_{22}^i w_{22\dots 2}^j)^{\frac{1}{k}}$
 $/ \sqrt{\prod_{i=1}^{m_1} \prod_{j=1}^{m_2} (v_{22}^i w_{22\dots 2}^j)^{\frac{2}{k}} + \prod_{i=1}^{m_1} \prod_{j=1}^{m_2} (v_{44}^i w_{44\dots 4}^j)^{\frac{2}{k}}}$.

Eq.(G10) implies a sufficient condition

$$\prod_{i=1}^{m_1} \prod_{j=1}^{m_2} (v_{22}^i w_{22\dots 2}^j)^{\frac{2}{k}} + \prod_{i=1}^{m_1} \prod_{j=1}^{m_2} (v_{44}^i w_{44\dots 4}^j)^{\frac{2}{k}} > 1 \tag{G11}$$

for which that the multipartite quantum correlations violate the Bell inequality in Eq.(6). A simple sufficient condition is given by

$$v_{22}^i, v_{44}^i, w_{22\dots 2}^j, w_{44\dots 4}^j \geq \frac{\sqrt{2}}{2} \tag{G12}$$

for all $i = 1, 2, \dots, m_1; j = 1, 2, \dots, m_2$.

Moreover, if $v_{22}^i = v_{44}^i = w_{44\dots 4}^j = w_{22\dots 2}^j = 1$, the violation is maximal with respect to the presented bound in Eq.(7). Note that the condition in Eq.(G11) is independent of all coefficients except for $v_{22}^i, v_{44}^i, w_{44\dots 4}^j, w_{22\dots 2}^j$. This property may useful for applications.

Appendix H: Inefficient networks

Here, we provide some simple networks which cannot be characterized with the presented Bell inequalities in Eq.(6). The first one is the cyclic network in Fig.S4(a) with EPR states as quantum resources. This network is also different from the triangle cyclic network with 2 GHZ states as quantum resources. For the second in Fig.S4(b), there are three cyclic subnetworks, where 2 GHZ states and one EPR state are consisted of hybrid quantum resources. There are 4 cyclic subnetworks in the network shown in Fig.S4(c), where one four-partite GHZ state and 2 GHZ states are consisted of hybrid quantum resources. The last one is a door-type network in Fig.S4(d) with 4 cyclic subnetworks, where 3 four-partite GHZ states are consisted of quantum resources. For these simple cyclic networks, there does not exist $k \geq 2$ independent observers who have no shared entanglements. Hence, it is interesting to explore new

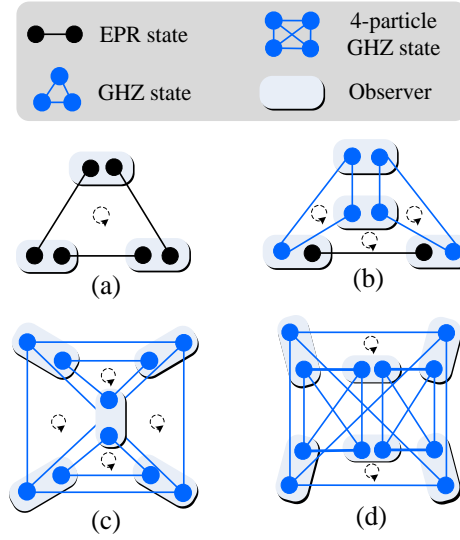

FIG. 7: (Color online) Simple networks cannot be characterized with the presented Bell inequalities. (a) Triangle cyclic network with 3 EPR states as quantum resources. (b) Special cyclic network with 2 GHZ states and one EPR state as hybrid quantum resources. (c) Symmetric cyclic network with multi-partite GHZ states as hybrid quantum resources. (d) Door-type network with 3 four-partite GHZ states as quantum resources. Each colored square denotes one observer of a network.

Bell inequalities for these special networks. Actually, we conjecture the linear inequalities should be useful for these networks.

-
- [1] https://en.wikipedia.org/wiki/Mahler%27s_inequality
- [2] J. K. Karlof, *Integer programming: theory and practice*, (CRC Press 2006).
- [3] D. B. West, *Introduction on Graph Theory* (2nd ed.), (Prentice Hall, 1999).
- [4] N. Gisin, *Phys. Lett. A* **154**, 201(1991).
- [5] S. Popescu and D. Rohrlich, *Phys. Lett. A* **166**, 293 (1992).
- [6] A. Einstein, B. Podolsky, & N. Rosen, *Phys. Rev.* **47**, 777-780 (1935).
- [7] D. M. Greenberger, M. A. Horne, & A. Zeilinger, Bell's theorem without in-equalities. In Bell's theorem, quantum theory and conceptions of the universe (eds Kafatos, M.), 69-72 (Springer Netherlands, 1989).
- [8] In these definitions of observables A_{x_i}, B_y , there exist no shared EPR state that is measured with an identity operator by two parties. For an even ℓ_i , if the particle of the t_j -th EPR states of the observer \mathcal{B}_y belongs to the observer \mathcal{C} in the network G_a , \mathcal{C} should have other particles; Otherwise, \mathcal{C} has only one particle. By replacing the observer \mathcal{A}_i with the observe \mathcal{C} , it follows a new equivalent network with at least k independent observers, where $\ell_i = 1$.
- [9] N. Gisin, Q. Mei, A. Tavakoli, M. O. Renou, & N. Brunner, arxiv1702.00333 (2017).
- [10] R. Ahlswede, N. Cai, S.-Y. Li, and R. W. Yeung, *IEEE Trans. Inf. Theory* **46**, 1204-1216 (2000).
- [11] M. Hayashi, *Phys. Rev. A* **76**, 040301 (2007).
- [12] R. Horodecki, P. Horodecki, & M. Horodecki, *Phys. Lett. A* **200**, 340-344 (1995).