

Personal Food Computer: A new device for controlled-environment agriculture

Eduardo Castelló Ferrer, Jake Rye, Gordon Brander,
Tim Savas, Douglas Chambers, Hildreth England and Caleb Harper
MIT Media Lab,
75 Amherst St.,
Cambridge, MA 02139

Email: {ecstll, jrye, gordonb, tsavas, leon8556, hildreth, calebh}@media.mit.edu

Abstract—Due to their interdisciplinary nature, devices for controlled-environment agriculture have the possibility to turn into ideal tools not only to conduct research on plant phenology but also to create curricula in a wide range of disciplines. Controlled-environment devices are increasing their functionalities as well as improving their accessibility. Traditionally, building one of these devices from scratch implies knowledge in fields such as mechanical engineering, digital electronics, programming, and energy management. However, the requirements of an effective controlled-environment device for personal use brings new constraints and challenges. This paper presents the OpenAg™ Personal Food Computer (PFC); a low cost desktop size platform, which not only targets plant phenology researchers but also hobbyists, makers, and teachers from elementary to high-school levels (K-12). The PFC is completely open-source and it is intended to become a tool that can be used for collective data sharing and plant growth analysis. Thanks to its modular design, the PFC can be used in a large spectrum of activities.

Keywords—Controlled-environment agriculture; Agricultural Robotics; Educational Robotics; Decentralised Farming; Open-source Hardware; Open-source Software; Citizen science

I. INTRODUCTION

In the coming decades, it is expected that humanity will need to double the quantity of food, fiber, and fuel produced to meet global demands. However, growing seasons are predicted to become more volatile, and arable land (80% is already being used) is expected to significantly decrease, due to global warming [1]. Concurrently, public and private institutions are starting to take an increasing interest in producing specific compounds and chemical elements using innovative agricultural platforms (e.g., controlled-environment devices) for several applications (medical, cosmetics, environmental, etc.) [2], [3], [4].

In the last years, the field of phenomics [5] has provided key insights about how different organisms can be optimized under certain environmental conditions. These observations have uncovered the possibility of creating “climate recipes” [6] for specific organisms where a certain trait (e.g., volume, taste, chemical concentration, etc.) is maximized. The creation and optimization of such “recipes” can increase the production of valuable compounds as well as improve crop yield, which still represents a state-of-the-art problem in the field of modern agriculture.

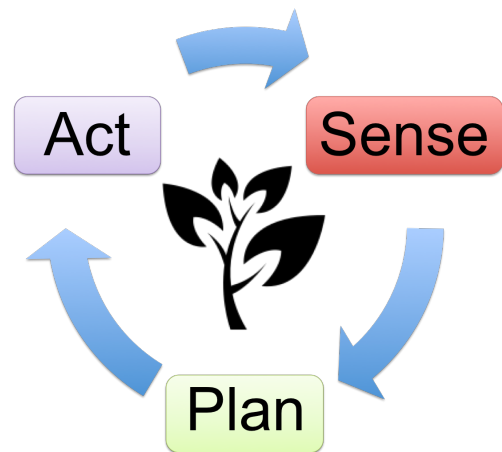

Fig. 1: Classical feedback control loop extensively used in robotics research. This loop is composed of three main phases (Sense, Plan, Act), which in combination with modern controlled-environment agricultural devices allow treating plants as “robotic” agents.

Furthermore, a new framework whereby plants and crops are controlled and monitored by computer-based algorithms has emerged recently in the precision, and cellular agriculture fields [7], [8]. Agriculture Cyber-Physical Systems (ACPS) provide the possibility not only to replicate experiments easily, but also to collect, analyze, and learn from the data obtained to discover new traits and patterns. ACPS have the potential to assist plant optimization methods achieving more autonomous, efficient, and intelligent plant growth models through the integration of robotic control loops (Fig. 1) into novel agricultural devices for both indoor and outdoor environments.

Currently, controlled-environment platforms are either based on open-source and open-hardware standards or they have the capability to precisely control the environment around plants and other organisms. Moreover, very few of these devices have a suitable size for operating outside a fully-equipped research lab. Therefore, hindering the adoption of this technology by other user profiles. However, the controlled-environment devices that fulfill these size constraints suffer from a lack of customizability capabilities due to proprietary hardware and software solutions.

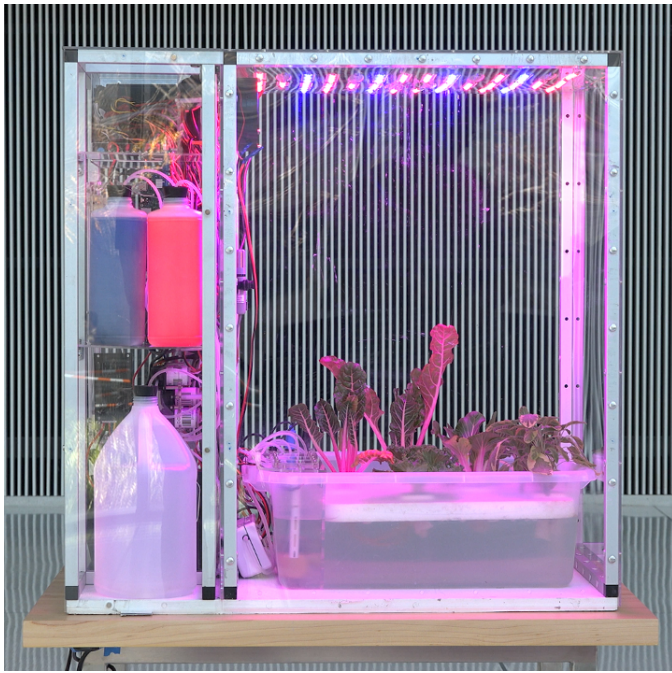

Fig. 2: OpenAg™ Personal Food Computer (PFC) v2. Compared to previous versions (v1), v2 has an improved software controller and additional sensor and actuation capabilities.

The OpenAg™ Personal Food Computer is the first to fulfill these characteristics in the same device. In addition, the OpenAg™ Personal Food Computer allows its user to create, store, and share the data generated during the growth cycle. Therefore, providing the possibility of creating “climate recipes” and allowing other suitable devices to recreate the same environmental conditions, improving the reproducibility of the experiments.

This paper presents the design approach resulting in the OpenAg™ Personal Food Computer named throughout the paper as PFC (depicted in Fig. 2), a desktop size controlled-environment device developed at the Open Agriculture Initiative¹ at the Massachusetts Institute of Technology (MIT) for a wide range of activities. The main objectives of this development were:

- To explore the synergy between state-of-the-art robotics methods and controlled-environment devices to discover, analyze, and integrate new techniques to improve plant growth models.
- To use a personal controlled-environment device to generate, share, and reproduce “climate recipes” among a community of users.
- To use a personal controlled-environment device to produce academic curricula from elementary to high school levels (K-12).

II. EXISTING ROBOTS FOR PERSONAL AGRICULTURE

The number of agricultural devices available on the market is increasing. In this section, we summarize a small subset of them that can be used as personal platforms. Table I summarizes the main characteristics of the devices and technologies cited in this section.

A. Farmbot

The Farmbot³ is an open-source Computer Numeric Control (CNC) machine that allows the user to plant small herbs and vegetables in an outdoor 2D grid layout (4.5 m^2 or 14.7 ft^2). Optimized for backyard usage, the Farmbot can perform operations such as watering, spraying, and seed spacing with a single end effector due to its exchangeable head tool. Even though it incorporates data acquisition and analysis tools, the Farmbot cannot control the environment since it is designed for outdoor use. On the other hand, the Farmbot is open source, fully documented and customizable.

B. AeroGarden

The AeroGarden platform⁴ is a consumer kit for growing herbs, small flowers, and plants. Ranging from \$99-\$379 in price, AeroGarden devices provide enhanced capabilities such as WiFi connectivity to smartphones or 45 Watts of LED lighting. However, AeroGarden is a closed platform. In addition, the environment is uncontrolled and affected by the surrounding climate. Finally, the customizability of the system is low and its inputs are proprietary.

C. Leaf

The Leaf platform⁵ is a medium-size ($600 \times 600 \times 1520 \text{ mm}$ or $24 \times 24 \times 60 \text{ inches}$) indoor farming solution specially designed to grow cannabis and other medicinal plants. Leaf is more expensive (\$1500) than the AeroGarden platform. However, Leaf provides the possibility to control and adapt the environment around the plants. On the other hand, it is still a closed platform (both hardware and software) and its customizability is low.

D. Grove

Grove offers a solution named “The Garden”⁶. This medium-size device ($830 \times 400 \times 1900 \text{ mm}$ or $33 \times 16 \times 75 \text{ inches}$) includes an aquarium to complement the system (i.e., plants receive the nutrients from fish organic material). The system comes with a smartphone application that can track pH and bacteria levels, send reminders to the user, offer growing tips, etc. However, this device cannot control or adapt the environment around the plants since it does not rely on a sealed chamber and its customizability is also low. The Garden’s retail price is higher than previous platforms (\$4500).

¹<http://openag.media.mit.edu/>

²Total cost of all needed components described in section IV.

³<http://farmbot.io/>

⁴<http://www.aerogarden.com/>

⁵<http://www.getleaf.co/>

⁶<http://grovegrown.com>

Characteristics	Farmbot	AeroGarden	Leaf	Grove	Conviron A1000	PFC
Target Consumer	Consumer	Consumer	Consumer	Consumer	Scientist	Consumer
Price	\$3100	\$99-\$379	\$1500	\$4500	On request	\$3000 ²
Platform	Open	Closed	Closed	Closed	Closed	Open
Adaptive Env.	No	No	Controlled	No	Controlled	Controlled
Customizability	High	Low	Low	Low	Low	High

TABLE I: Comparison of several agricultural devices for personal and scientific use.

E. Conviron A1000

The A1000⁷ platform is targeted towards small labs and plant scientists interested in plant growth research. Even though the primary customer base of the A1000 isn't the end-user as previous platforms, Conviron chambers such as the A1000 have turned into the standard for running plant experiments within the academic community. Therefore, the comparison of its technology with other devices provides important information. The A1000 is a large device ($1040 \times 825 \times 2020$ mm or $41.75 \times 32.5 \times 79.5$ inches) with the possibility of controlling environmental variables like photoperiod, light intensity, air temperature, humidity, CO_2 , etc. In spite of the controllable environment capabilities, the A1000 is a closed platform with low customizability. Its price is on request. However, it runs on the order of tens of thousands of dollars, which makes it the most expensive solution within our list.

III. ROBOT DESIGN FOR PERSONAL ENVIRONMENT-CONTROLLED APPLICATIONS

Most of the commercial devices mentioned above are exclusively non-adaptive systems (i.e., do not allow the user to change the environment around the plant) or they are based on closed systems that provide very low customizability capabilities. Finally, the relatively high prices of systems such as that proposed by Grove Labs or Conviron hinder the adoption of this technology by end users or research institutes. Therefore, a device that tries to overcome these problems would need to satisfy the following criteria:

A. Desktop size

A controlled-environment device that can operate on a desk in an indoor research environment (e.g., classroom) or inside a typical apartment setting increases the possibilities of using this technology and experimenting with different environmental conditions. We consider that a suitable size might match the specifications of traditional home appliances. Thus, the device should not be bigger than 1000 mm^3 or $39 \frac{3}{8} \text{ inches}^3$.

B. Wide range of possibilities

In order to make this tool useful for diverse disciplines such as plant phenotyping research or robotics academic curricula, the proposed device should allow a broad range of possibilities in its basic version. A modular design to which different sensors and actuators can be added is a crucial aspect in order to customize the system for a wide audience.

C. User friendly

The interfaces that allow users to communicate with and extract information from the device must be intuitive, simple, and efficient. These are important points in order to engage a wide variety of users with the proposed system. 'Plug and play' connections with the sensing, actuation, and computing parts of the system need to be emphasized. Finally, the capability of creating, storing, and sharing relevant data generated by the device is also an important feature of the user interface.

D. Low cost

To assure the adoption of this technology by different types of users (e.g., makers, food enthusiasts, researchers, etc.), the proposed device needs to be affordable. We propose reducing the cost of the system by using non-proprietary software and hardware solutions.

E. Open Information

This platform needs to be shared among different types of users with different requirements such as teachers, students, or scientific staff. To provide a suitable platform to replicate experiments and analyse the data obtained by the device, an open-source hardware/software development model is an effective approach.

None of the platforms outlined above and currently on the market fulfills these criteria. Most controlled-environment devices are large and thus need to operate in outdoor environments or special locations. Also, very few are based on open standards. Due to the current gap in the field, we propose the latest version (v2) of the PFC. The following sections present the PFC v2 design.

IV. THE OPENAG™ PERSONAL FOOD COMPUTER (PFC)

The PFC is an open-source open-hardware platform; its design prioritizes the criteria mentioned above: desktop size, low cost, customizability, user friendliness, and open information. These five constraints imply the following actions: First, to reduce the size of a system with a large number of components. Second, to reduce the price of the device using cheap "off-the-shelf" components and mass production manufacturing techniques. Third, to obtain a user-friendly device by providing an intuitive and interactive user interface as well as a modular hardware system to add or remove sensing, actuation, or computing devices.

In this design process, a central aspect is the choice of the PFC capabilities. This particular choice is one of the innovations of the PFC design. The sensors, actuators, and interfaces of the PFC represent a wide range of devices one

⁷<http://www.conviron.com/products/a1000-reach-in-plant-growth-chamber>

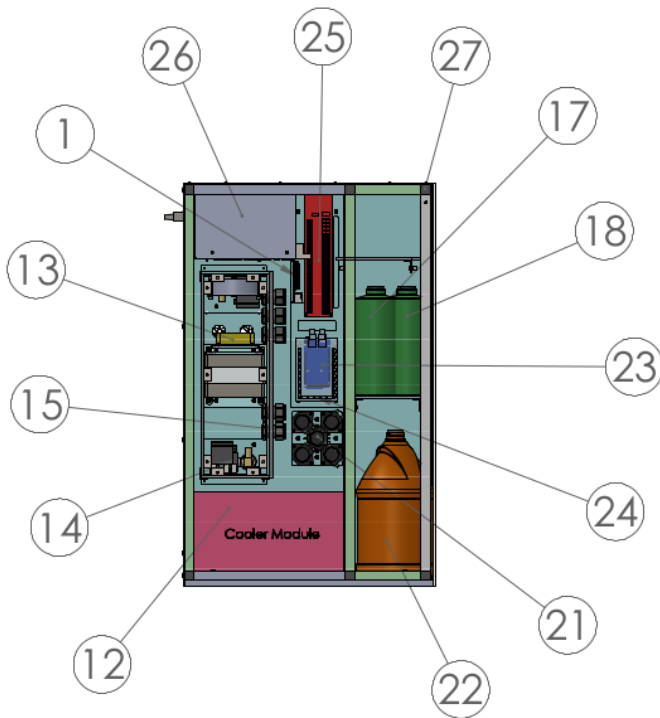

Fig. 3: Side view of the PFC v2. The main electronic panel and its components are described.

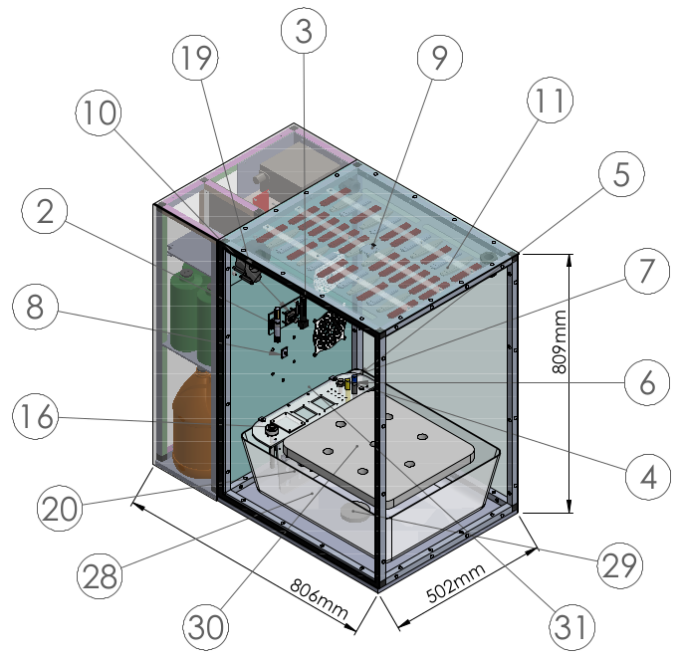

Fig. 4: Orthogonal view of the PFC v2. Device measures and the main elements of the growing chamber are described.

can find in several engineering sub-domains. Fig. 3 and Fig. 4 show the mechanical structure and the different hardware components composing the PFC. Fig. 5 outlines the connection diagram of these components. The following section explains the hardware and software design choices in detail.

A. The PFC Hardware

1) *Single Board Computer (SBC)*: The electronic structure of the PFC is built around the open-hardware platform Raspberry Pi 3⁸ (depicted in Fig. 3 ①). The Raspberry Pi has a strong community of users. This SBC provides enough flexibility because it embeds both multi-purpose ports such as Universal Serial Bus (USB) as well as General Purpose Input/Output (GPIO) ports, which allow the integration of more complex circuits. The Raspberry Pi 3 CPU runs at A 1.2GHz 64-bit quad-core with an ARMv8 architecture. This architecture is supported by most of the Linux distributions, allowing access to relevant tools such as different programming languages and compilers, robotics-related software, etc.

2) *Sensors and actuators*: To allow a wide range of experimentation possibilities, the PFC contains various sensing devices:

- The AM2315 sensor (②) was used as an air temperature and humidity sensor. This sensor has a resolution of 0.1 units for both relative humidity (%RH) and temperature (°C). Its temperature sensing range is -40 to 125°C with a humidity repeatability of ± 0.1 in %RH. These capabilities are sufficient to fulfill

the needs of the controlled-environment agricultural applications.

- The MHZ16 sensor (③) was used as a CO_2 sensor. Its CO_2 detection range is 0-2000 ppm. Even though it requires up to 2-3 minutes to warm up before reporting valid data, its Universal Asynchronous Receiver/Transmitter (UART) connectivity provides an easy way to set up the sensor.
- The Atlas pH sensor (④) was chosen as a solution to measure the pH in the reservoir tub (⑳). This sensor has a pH range of 0 - 14 (Na⁺ error at > 12.3 pH). Its small size (12 mm \times 150 mm) is ideal to meet the constraints of our personal-size system.
- Complementarily, the Atlas EC sensor (⑤) was used for measuring the electrical conductivity (EC). With similar measures and connecting interfaces as the Atlas pH sensor, it was easy to integrate it into our system. With a conductivity range of 5 μ S/cm to 200,000 μ S/cm, it was more than sufficient to meet the needs of an agricultural system.
- The 1-Wire interface DS18B29 sensor (⑥) was chosen as the water temperature sensing unit. With a $\pm 0.5^\circ$ C accuracy from -10° C to $+85^\circ$ C and the possibility to conduct underwater measurements, this device was suitable for the PFC specifications.
- A water level sensor (⑦) provides the PFC with the possibility to detect when the water in the bay needs to be refilled. We chose the LLE102000 sensor, which offers an accurate resolution of ± 1 mm.
- The TSL2561 developed by Adafruit was chosen as the light intensity sensor (⑧). With an I2C interface

⁸<http://www.raspberrypi.org/products/raspberry-pi-3-model-b/>

and light ranges from up to 0.1 - 40000+ Lux, the TSL2561 provides enough resolution to meet our system's specifications.

- Two USB ELP 3.6mm Lens 5 Megapixel cameras are used to obtain images from the plants and run computer vision algorithms. The first one is located at the top of the PFC (9). The second one is located at the side of the box (10).

Regarding the actuation side of the system, the following components were selected:

- Grow Lights: GE Light modules (11) with Red, Blue, White (individually controllable / PWM) channels were chosen as the main lighting actuator.
- Air Cooler: A KippKitts cooling unit (12) with 200W was selected as the main chiller mechanism.
- Air Heater: A 12V 150W electric ceramic thermostatic PTC heating element (13) was chosen as the main heating element.
- Fresh air valve: A 1/2 inch DC12V motorized ball (14) valve was selected in order to manage the exchange of air between the growth chamber and its exterior environment.
- Cable gland: Four 3/4 inch NPT thread cable glands (15) were used as connecting points for the passing wires and cables from and to the air manifold. In addition, they are designed as modular air connection points for CO₂ dosing or other gas dosing (e.g., NO₂, particulate matter, aerosols, etc.).
- Humidifier: Phtronics portable bottle cap air humidifier with bottle (16) was chosen as the main source of humidity for our system.
- pH and Nutrients solutions: Two liquid bottles (pH Up & pH Down) (17) from General Hydroponics (1-Quart) and two FloraDuo (A & B) (18) fertilizers were chosen as main solution units respectively.
- Air circulation fan: A DC blower (19) with rated current of 1 Amp and voltage of 12V was used as a circulation fan within the growing chamber.
- Water circulation pump: A 12V submersible circulation pump (20) was chosen as the main device to activate the water manifold.
- Peristaltic Liquid Pumps: Five homecube 12V DC peristaltic liquid pumps are located at the side of the PFC (21). Two of them are in charge of pumping the pH solutions (17) into the tub (28). Another two are in charge of pumping the nutrients into the tub. Finally, the remaining one is in charge of pumping fresh water from the water reservoir (22).

In order to connect sensory input with actuation power, the following electronic equipment was used:

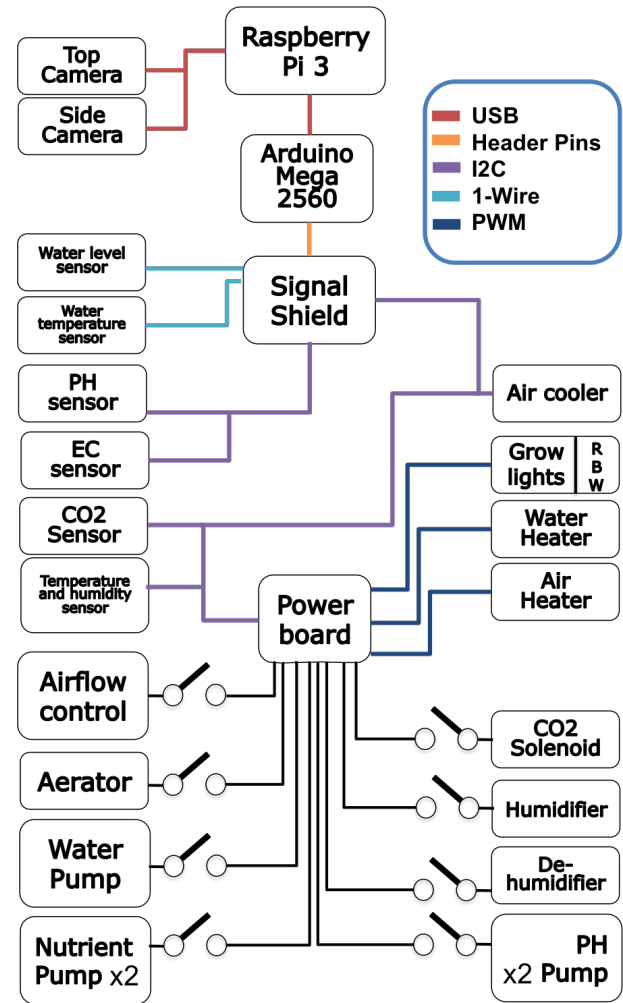

Fig. 5: Electronics and connection diagram for the PFC.

- Arduino Mega 2560: This board (23) was used in order to easily add and remove the low-level sensors as well as to make the most of the code and community already built around this family of boards.
- Signal shield: The SainSmart Sensor Shield v2 (24) was chosen as the main signal board. This shield is directly mounted on top of the Arduino Mega 2560 and its main functionality is to read from the multiple sensors of the system and send commands to the power board.
- Power board: A customized PCB (25) board composed of MOSFETS & Relays electronic components was used for high power switching. This board has a standard interface that can be controlled directly by the Arduino Mega 2560 board.
- Power Supply: A 500W power supply unit (26) is in charge of powering the whole system.

3) Mechanics:

- Structural Frame: The outer frame (27) is a 806 × 502 × 809 mm (31.7 × 19.7 × 31.8 inches) structure

composed of 3/4 inch (19 mm) anodized aluminum extrusion tubing connected by push-in brackets that assemble different edges of the frame.

- Reservoir Tub: The purpose of the reservoir tub (28) is to hold nutrient-rich water and to keep the root zone dark to reduce algae growth. The water in the tank will do the same job that soil does when plants are grown outdoors.
- Aerator, tubing, and stone: (29) Plant roots need oxygen in the water for respiration. This system increases the dissolved oxygen content of the water in the reservoir tub as well as agitates the water to prevent root mold and disease.
- Styrofoam float tray: This board is the structural anchor where the seedlings are planted (30). The foam tray is like a raft that floats on top of the nutrient rich water, creating a barrier between the leaf zone and the root zone. This piece also helps to prevent algae growth by blocking light to the root zone.
- Outer Shell: The shell (31) is what separates the internal climate of the growth chamber from the outside environment. This part of the PFC provides a physical barrier and styrofoam insulation to help maintaining internal conditions. The shell has a transparent window so users can observe their plants without disturbing the inner climate.

Detailed information about every sensor, actuator, and mechanical part used in the system, can be found in a BOM (Bill Of Materials) file⁹ provided within the Wiki page of the project¹⁰. In this extensive list, information such as part supplier, description, cost, and datasheet links are provided. Finally, assembly instructions and a complete list of building resources can be found within the official PFC (v2) repository¹¹.

B. The PFC software

1) *User interface:* In order to provide a user-friendly environment to operate the PFC, we developed a web-based interface using the Javascript language. Several features of this UI include:

- Visualization of environmental data points and progress of plant growth (Fig. 6).
- Loading, modifying, and exporting climate recipes and output data in CSV format.
- Creation of time-lapse videos and visualization of camera feeds (Fig. 7).
- Manually actuating different devices in the PFC such as pumps, heater, cooler, etc.

The UI is designed to run on any device with a web browser (e.g., tablets, mobile phones, desktop computers, etc.). This

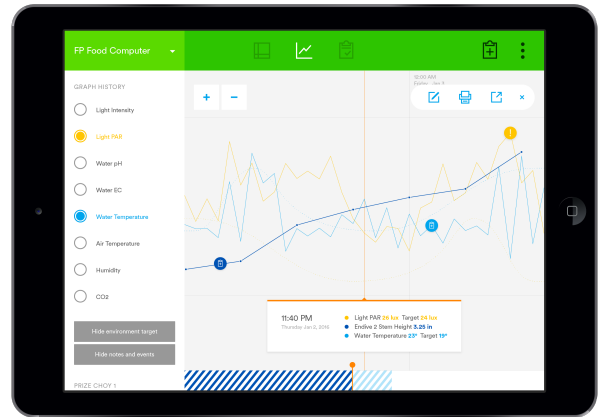

Fig. 6: Screenshot of the User Interface (UI) where a sequence of environmental sensor data points (a.k.a. “climate recipe”) is visualized. This feature of the UI provides the possibility to change the time scale of the recipe as well as bookmark certain parts of it for future reference.

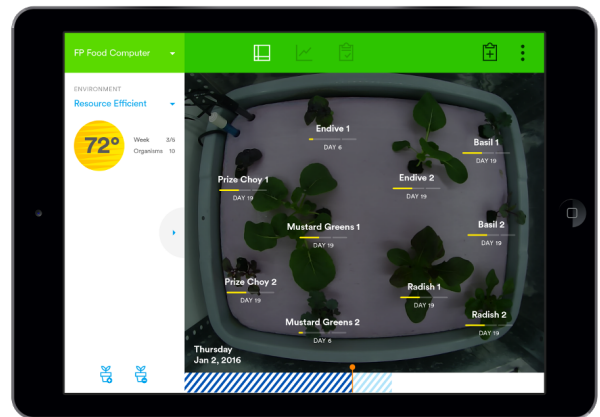

Fig. 7: Screenshot of the UI where an image of the growing chamber is displayed. This feature of the UI allows the user to create time-lapse videos and monitor plant growth with progression bars.

feature allows the user to operate the PFC from a proximity scenario using the local WiFi network or a remote scenario using the internet. This capability increases the flexibility of the PFC users to monitor their experiments. The source code of the UI can be found here¹².

2) *Climate Recipes:* As commented before, climate recipes embedded a sequence of environmental sensor data points that represent climates where an organism is grown. Currently, the PFC only supports one “simple” recipe format. However, the system is designed to allow new formats to be developed over time. This “simple” recipe format conceptualizes recipes as a sequential list of set points for environmental variables. In particular, a “simple” recipe is a list of 3-element lists with the following structure:

```
[<offset>, <variable_type>, <value>]
```

⁹<http://goo.gl/7zfGsB>

¹⁰<http://wiki.openag.media.mit.edu/>

¹¹http://github.com/OpenAgInitiative/openag_pfc2

¹²http://github.com/OpenAgInitiative/openag_ui

Where `<offset>` is the number of seconds since the start of the recipe at which this set point should take effect, `<variable_type>` is the variable type to which the set point refers (e.g. “`air_temperature`”), and `<value>` is the value of the set point. The set point stays in effect until a new set point for that variable type is reached. The list of set points is ordered by offset. The recipe will end as soon as the last set point is emitted. Recipes are encoded into JSON files that are inputted into the PFC control system. A sample of this simple recipe format can be depicted in the following example:

```
{ "_id": "7ca3134e91aec96acd17a74764000bb8",
  "format": "simple",
  "operations": [
    [0, "air_temperature", 25],
    [0, "air_humidity", 25],
    [0, "light_illuminance", 60],
    [43200, "air_temperature", 23],
    [108000, "light_illuminance", 0],
    [172800, "air_humidity", 20],
    .
    .
    .
  ]
}
```

3) *On-board software structure*: Fig. 8 outlines the PFC’s on-board software structure and its interaction with external components such as the UI. A NoSQL database (CouchDB) was chosen to store the data coming from the PFC sensors as well as previous completed recipes. The UI uses this local database to visualize the current sensor values and monitor the progression of the current climate recipe.

To control the PFC hardware we decided to use ROS [9] (Robot Operating System). We made that choice to reuse already developed control schemes (e.g. PID controllers), sensing packages, debug tools, etc. and to be able to interface with other robots in the future. Within our ROS infrastructure different ROS modules are in charge of controlling the PFC. For instance, one module loads and stores information from and to the local CouchDB database (Client DB), another flashes the Arduino board to provide different sensor capabilities or communicates with the Flask REST API to provide HTTP control points to the whole system. The behavior of these modules can be changed online by the use of different ROS parameters. A detailed list of ROS modules and its parameters can be found within the `openag_brain` package¹³. Two Docker containers are used to accomplish this whole setup. Docker containers allow us to package the software to be reproducible, easy to deploy, and ready to operate the PFC. Docker containers are stateless, which means that to create a certain configuration data needs to be saved outside the containers (Docker Volume).

V. PFC DESIGN CHALLENGES

During the design phase of the PFC, we faced several challenges in order to meet the criteria introduced in section III. We describe three of these challenges in the following lines:

A. Hardware agnostic control

Due to the high-customizability capabilities of a system such as the PFC, we realised that a wide range of hardware components might be added, removed, substituted, or sourced locally by end users. In order to cope with this hardware variability, we decided to program the software stack of the PFC with hardware agnostic orders (e.g., “dose 20 ml of solution”) rather than component specific commands (e.g., “turn the pump on for 2 secs”). Using this approach we can achieve feedback control models like the one described in Fig. 1 without specific or specialized hardware components. This hardware agnostic control represents an improvement from previous controlled-environment platforms (e.g., Conv-iron A1000⁷, Leaf⁵, etc.), which heavily depend on explicit hardware.

B. Frame modularity and scalability

The PFC is designed as a desktop size system. However, major crops such as corn, wheat, or soy (of great interest to the scientific community) require bigger chambers to grow. The PFC’s structural frame is made out of standardized aluminum extrusion tubing connected by push-in brackets. This structural approach was chosen to allow the user to expand the growth chamber horizontally and vertically (depending the needs of the plant or crop) maintaining the same sensing, actuation and control components. The assembly of the different edges as well as the expansion of the frame to bigger size chambers requires minimal changes and no specialised tooling. The possibility of scaling the PFC to accommodate different types of plants and crops represents an improvement from previous controlled-environment platforms, which are unable to adapt their growing space.

C. Open Database for plant growth data

To provide a suitable platform to replicate experiments and analyse the data obtained, we envision an open database for plant growth data¹⁴, where controlled-environment devices such as the PFC act as end-effectors. For this purpose, we decided to implement a client/server database architecture, where the PFC local database (Client DB) can operate offline while a cloud database instance (Server DB) can be synchronized once the PFC comes online. A filtered replication method between both database instances has been developed to save bandwidth and space on the client side. Client databases only download the changes that take place in the cloud database. However, local PFC databases upload all their content to the cloud.

VI. PREVIOUS DEPLOYMENTS

A. Evaluation of the PFC by teachers

In September 2015, six high schools in Massachusetts were selected to conduct a pilot program to use PFCs in classrooms. A total of 200 students (30 students per 6 classrooms) were engaged in building and programming a PFC to create academic curricula.

After this pilot program, teachers were asked to give feedback about the use of the PFC and its capabilities to create

¹³http://github.com/OpenAgInitiative/openag_brain

¹⁴<http://www.media.mit.edu/research/groups/open-phenome-project>

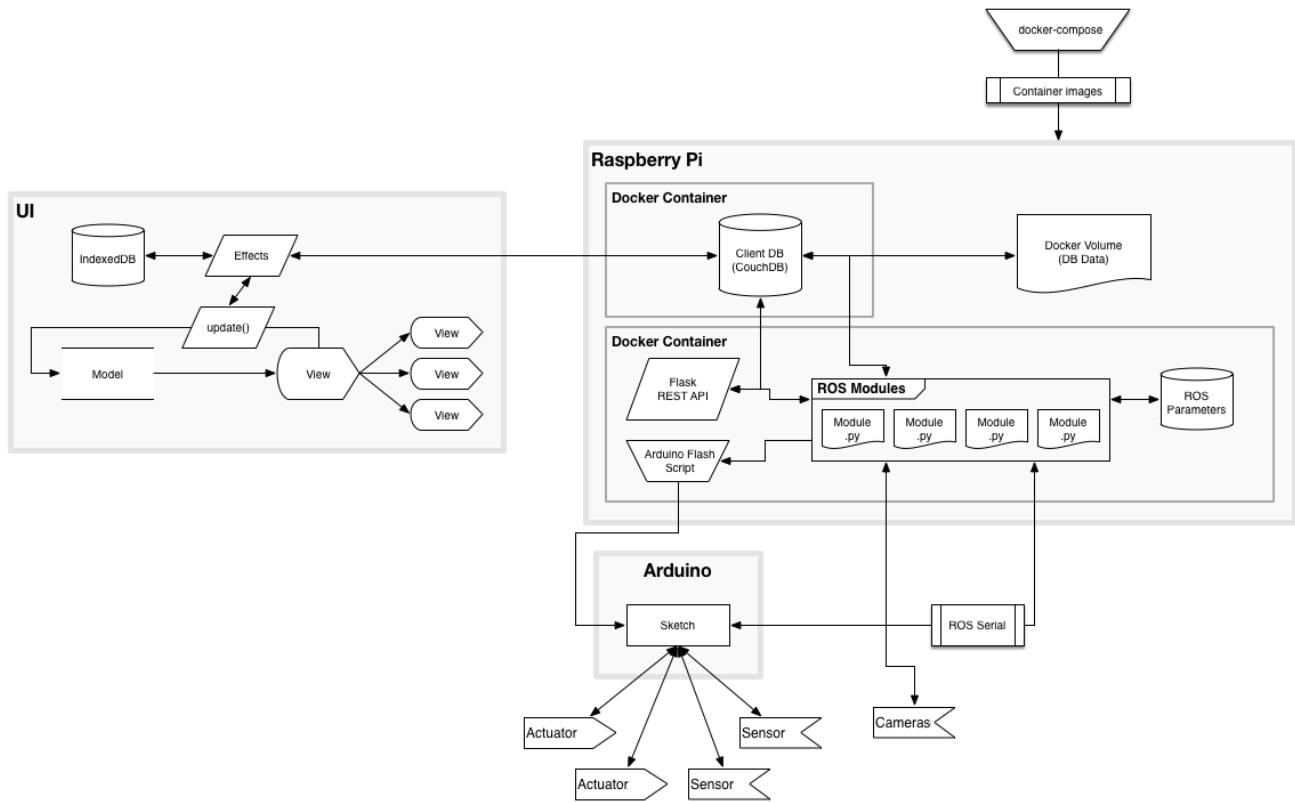

Fig. 8: Layout of the on-board software structure of the PFC. Two Docker containers are responsible for the whole system setup and configuration. The first container starts and loads a local CouchDB instance. This NoSQL database stores all sensor data and previous climate recipes. The second container is responsible for setting up the ROS infrastructure and applying the control algorithms for climate recipe handling.

The PFC is a good tool to teach different disciplines (e.g. Biology, Chemistry, Mechanics, Electronics, Programming)

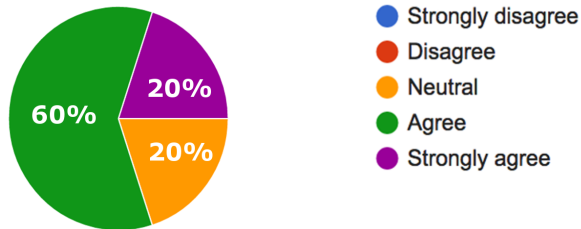

Fig. 9: Results depicted from the survey distributed to 5 teachers during the pilot program.

curricula in different disciplines such as biology, chemistry, programming, electronics, etc. Fig. 9 depicts the results of this survey and shows that more than 80% of the teachers agree or strongly agree that the PFC is a good tool to teach different disciplines and generate academic curricula.

As a result of this pilot program, an educator’s user guide and associated curricula was created [10]. The research that lead to this user’s guide suggests that the PFC introduces an opportunity for students to grow their food with an exciting and fun tool that they can take ownership of. The PFC also introduces opportunities for students to engage in exciting,

cutting-edge technologies. This pilot program led to a 2016 Edison Award (Bronze Category)¹⁵.

B. User Community



Fig. 10: Locations where different PFCs (v1 or v2) are being built.

We created an open online forum¹⁶ and a Wiki page to disseminate the research progress on the PFC project.

¹⁵<http://www.edisonawards.com/winners2016.php>

¹⁶<http://forum.openag.media.mit.edu>

Moreover, we are in the preliminary stages of providing non-English translations of our documentation. Since launching the OpenAg community in May 2016, we gathered a total of 855 users from every continent, 297 topic threads, and about 3500 posts. Currently, different PFCs are being built in 33 countries around the world (Fig. 10).

Which of the following is the most appealing aspect of the PFC for you?

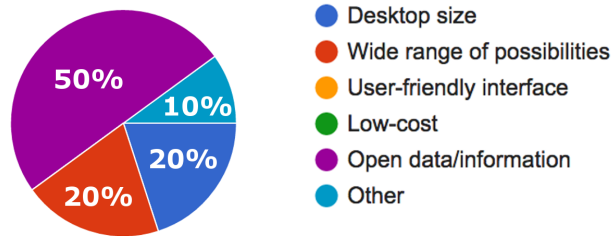

Fig. 11: Results depicted from the survey distributed to 20 users which recently completed the PFC building process.

Another survey was distributed to a limited group of users which recently completed the PFC building process. These users were asked about what were the most appealing aspects of the PFC for them. Fig. 11 shows that 90% of the users find PFC aspects such as the open information, wide range of possibilities (i.e., customizability), or its desktop size appealing in order to build and use this kind of solution. These results correlate to our design premises described at the beginning of this paper.

VII. AVAILABILITY

The first kits (hardware and building instructions) for the PFC (v2) were ready for shipment by early 2017. However, all software (e.g., source code and development tools) and hardware components (e.g., CAD drawings) are accessible online.

VIII. CONCLUSIONS

The PFC is an innovative personal controlled-environment device for growing plants. However, it is also useful to teach a wide range of topics. For its size, price, and capabilities the PFC is a complex system that can be used not only as a research platform but also as an educational tool. The open-source nature of the PFC improves the quality of the support for the end users by providing full access to knowledge at every level. This paper presents the main hardware, software and design components behind the PFC as well as provides information about previous deployments and evaluations of the proposed platform. For future work, we envision an open-source digital library for plant growth data, where controlled-environment devices such as the PFC act as distributed data collecting stations.

IX. ACKNOWLEDGEMENTS

We thank MIT Media Lab, Target Corporation, Welspun, LKK, Google, Pentair and Partners in Food Solutions for funding the development of the PFC project.

REFERENCES

- [1] "The state of food and agriculture: Climate change agriculture and food security," Food and Agriculture Organization of the United Nations (FAO), Rome, Tech. Rep., 2016.
- [2] K. Lee, "Turning plants into drug factories," *Scientific American*, feb 2016.
- [3] J. L. Fox, "Turning plants into protein factories," *Nature Biotechnology*, vol. 24, no. 10, pp. 1191–1193, Oct. 2006.
- [4] G. G. Olinger, J. Pettitt, D. Kim, C. Working, O. Bohorov, B. Bratcher, E. Hiatt, S. D. Hume, A. K. Johnson, J. Morton, M. Pauly, K. J. Whaley, C. M. Lear, J. E. Biggins, C. Scully, L. Hensley, and L. Zeitlin, "Delayed treatment of Ebola virus infection with plant-derived monoclonal antibodies provides protection in rhesus macaques," *Proceedings of the National Academy of Sciences of the United States of America*, vol. 109, no. 44, pp. 18 030–18 035, oct 2012.
- [5] R. T. Furbank and M. Tester, "Phenomics – technologies to relieve the phenotyping bottleneck," *Trends in Plant Science*, vol. 16, no. 12, pp. 635 – 644, 2011.
- [6] C. Harper and M. Siller, "OpenAG: A Globally Distributed Network of Food Computing," *IEEE Pervasive Computing*, vol. 14, no. 4, pp. 24–27, 2015.
- [7] A. Abdullah, S. A. Enazi, and I. Damaj, "Agrisys: A smart and ubiquitous controlled-environment agriculture system," pp. 1–6, March 2016.
- [8] L. Zhou, N. Chen, Z. Chen, and C. Xing, "ROSCC: An Efficient Remote Sensing Observation-Sharing Method Based on Cloud Computing for Soil Moisture Mapping in Precision Agriculture," *IEEE Journal of Selected Topics in Applied Earth Observations and Remote Sensing*, vol. PP, no. 99, pp. 1–11, 2016.
- [9] M. Quigley, K. Conley, B. P. Gerkey, J. Faust, T. Foote, J. Leibs, R. Wheeler, and A. Y. Ng, "ROS: an open-source Robot Operating System," in *ICRA Workshop on Open Source Software*, 2009.
- [10] J. Rogoff, "Food Computers in the Classroom," Cambridge College, Tech. Rep., 2016.