

ON DISSOLVING KNOT SURGERY 4-MANIFOLDS UNDER A $\mathbb{C}\mathbb{P}^2$ -CONNECTED SUM

HAKHO CHOI, JONGIL PARK, AND KI-HEON YUN

ABSTRACT. In this article we prove that, if X is a smooth 4-manifold containing an embedded double node neighborhood, all knot surgery 4-manifolds X_K are mutually diffeomorphic to each other after a connected sum with $\mathbb{C}\mathbb{P}^2$. Hence, by applying to the simply connected elliptic surface $E(n)$, we also show that every knot surgery 4-manifold $E(n)_K$ is almost completely decomposable.

1. INTRODUCTION

Since gauge theory was introduced in 1982, topologists and geometers working on 4-manifolds have developed various techniques and they have obtained many fruitful and remarkable results on 4-manifolds in last 30 years. Among them, a knot-surgery technique introduced by R. Fintushel and R. Stern turned out to be one of most effective techniques to modify smooth structures without changing the topological type of a given 4-manifold [FS98b]. Note that Fintushel-Stern's knot surgery 4-manifold X_K is following: Suppose that X is a smooth 4-manifold containing an embedded torus T of square 0. Then, for any knot $K \subset S^3$, one can construct a new smooth 4-manifold, called a *knot surgery 4-manifold*,

$$X_K = X \#_{T=T_m} (S^1 \times M_K)$$

by taking a fiber sum along a torus T in X and $T_m = S^1 \times m$ in $S^1 \times M_K$, where M_K is a 3-manifold obtained by doing 0-framed surgery along K and m is the meridian of K . Then Fintushel and Stern proved that, under a mild condition on X and T , the knot surgery 4-manifold X_K is homeomorphic, but not diffeomorphic, to a given X . Furthermore, they initially conjectured for the simply connected elliptic surface $E(2)$ that the classification of all knot surgery 4-manifolds of the form $E(2)_K$ up to diffeomorphism is the same as the classification of all knots in S^3 up to knot equivalence [FS98a]. Although some partial progresses related to the conjecture were obtained by S. Akbulut [Akb02] and M. Akaho [Aka06], the full conjecture is still remained open. That is, it is not settled down yet whether the smooth classification of knot surgery 4-manifolds is equivalent to the classification of prime knots in S^3 up to mirror image.

On the other hand, C.T.C. Wall [Wal64] proved a stabilization property of smooth 4-manifolds: If two simply connected smooth 4-manifolds X and X' have isomorphic intersection forms, then there exists an integer k such that $X \# k(S^2 \times S^2)$ and $X' \# k(S^2 \times S^2)$ are diffeomorphic to each other. One of the interesting questions on the stabilization problem is to find the smallest such an integer k . S.

Date: April 25, 2017.

2010 Mathematics Subject Classification. 14J27, 57N13, 57R55.

Key words and phrases. Almost completely decomposable, knot surgery 4-manifold.

Akbulut [Akb02] and D. Auckly [Auc03] showed that $k = 1$ is enough for a family of knot surgery 4-manifolds X_K . That is, $X_K \sharp(S^2 \times S^2)$ is diffeomorphic to $X \sharp(S^2 \times S^2)$ and $X_K \sharp(S^2 \tilde{\times} S^2)$ is also diffeomorphic to $X \sharp(S^2 \tilde{\times} S^2)$ for any knot K in S^3 . R. Baykur and N. Sunukjian [BaSu13] also proved a single stabilization for a family of 4-manifolds obtained by logarithmic transforms.

In the same spirit as stabilization problems, topologists have also studied whether two smooth 4-manifolds with isomorphic intersection forms are diffeomorphic to each other after a connected sum with $\mathbb{C}\mathbb{P}^2$. In this article, we obtain an affirmative answer to this problem for a large family of knot surgery 4-manifolds. That is, we prove that, if X is a smooth 4-manifold containing an embedded double node neighborhood, a codimension zero submanifold obtained from $(S^1 \times S^1) \times D^2$ by attaching two (-1) -framed 2-handles along the first S^1 factor in $\partial((S^1 \times S^1) \times D^2)$, then all knot surgery 4-manifolds X_K obtained by performing a knot surgery operation along a torus in the double node neighborhood become mutually diffeomorphic after a connected sum with $\mathbb{C}\mathbb{P}^2$. Explicitly, we get

Theorem 1.1. *Suppose that X is a smooth 4-manifold containing an embedded double node neighborhood. Let X_K be a knot surgery 4-manifold obtained by performing a knot surgery operation along a torus in the double node neighborhood. Then $X_K \sharp \mathbb{C}\mathbb{P}^2$ is diffeomorphic to $X \sharp \mathbb{C}\mathbb{P}^2$ for any knot K in S^3 .*

Remark 1.2. Recently S. Akbulut suggested to us that Theorem 1.1 above is still true for a smooth 4-manifold containing a fishtail neighborhood. The essential part is that, by using the $(+1)$ -framed 2-handle coming from $\mathbb{C}\mathbb{P}^2$ blow-up and a (-1) -framed 2-handle in a fishtail neighborhood, we can get a 0-framed 2-handle in a meridian of the slice 1-handle which is linked with a $(+1)$ -framed 2-handle. We slide this $(+1)$ -framed 2-handle over the slice 1-handle and then cancel the slice 1-handle and a 0-framed 2-handle pair. By this way the slice 1-handle turns into $(+1)$ -framed 2-handle, then by the 2-handle slides indicated in [Akb16a, Figure 6.13 of p.72], we can dissolve the manifold.

Finally, people also studied an *almost completely decomposable* (ACD) property for simply connected smooth 4-manifolds. Note that a simply connected smooth 4-manifold X is *completely decomposable* if X is diffeomorphic to $\sharp k \mathbb{C}\mathbb{P}^2 \sharp \ell \overline{\mathbb{C}\mathbb{P}^2}$ for some integers k and ℓ , and *almost completely decomposable* if $X \sharp \mathbb{C}\mathbb{P}^2$ is completely decomposable. R. Mandelbaum and B. Moishezon showed that many complex surfaces are almost completely decomposable. For example, they showed that smooth hypersurfaces in $\mathbb{C}\mathbb{P}^3$, simply connected elliptic surfaces $E(n)$ and $E(n)_{p,q}$ are almost completely decomposable [MM76, Moi77, MM80, Gom89]. In this article, we also investigate this problem for knot surgery 4-manifolds $E(n)_K$, where $E(n)$ is the simply connected elliptic surface with Euler characteristic $12n$. Since it is well known that the Dolgachev surface $E(1)_{2,3}$ can be identified with a knot surgery 4-manifold $E(1)_K$, where K is the trefoil knot, it is natural to ask whether every knot surgery 4-manifold $E(n)_K$ is almost completely decomposable or not. By applying Theorem 1.1 above to $E(n)$ and combining a Moishezon's old result [Moi77] that every simply connected elliptic surface is almost completely decomposable, we conclude that

Corollary 1.3. *For any knot K in S^3 , $E(n)_K \sharp \mathbb{C}\mathbb{P}^2$ is completely decomposable.*

Remark 1.4. Shortly after this article was announced, R. Baykur gave an alternative proof of Corollary 1.3 using 5-dimensional cobordism arguments [Bay17].

Acknowledgements. The authors would like to thank Selman Akbulut, Ronald Fintushel, Robert Gompf, Daniel Ruberman and Ronald Stern for their valuable comments. Jongil Park was supported by Samsung Science and Technology Foundation under Project Number SSTF-BA1602-02. He also holds a joint appointment at KIAS and in the Research Institute of Mathematics, SNU. Ki-Heon Yun was partially supported by the Basic Science Research Program through the National Research Foundation of Korea funded by the Ministry of Education (2015R1D1A1A01058941).

2. A KIRBY DIAGRAM OF KNOT SURGERY 4-MANIFOLDS

In this section we first briefly review how to draw a Kirby diagram of $E(K) \times S^1$, where $E(K) = S^3 - \nu(K)$ denotes the knot complement of S^3 . And then we find some conditions on the Kirby diagram so that we can get a smooth operation in a knot surgery 4-manifold X_K which changes the knot K to K' by adding a full twist to K but $X_{K'}$ remains diffeomorphic to X_K .

2.1. Kirby diagram of $E(K) \times S^1$. It is well known how to draw a Kirby diagram of $E(K) \times S^1$, which is following (refer to [Akb02, Akb16a] or [GS99]): Let us

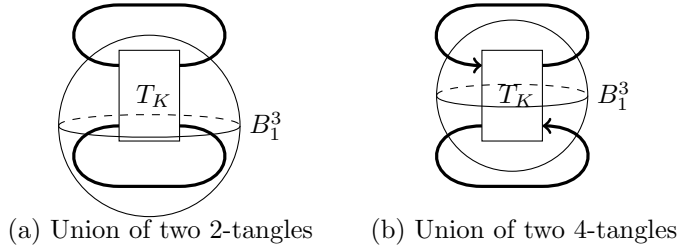

FIGURE 1. Decomposition of S^3 and K

consider S^3 as a union of two 3-balls $B_1^3 \cup B_2^3$, $B_1^3 \cap B_2^3 = \partial B_1^3 = \partial B_2^3$, as in Figure 1 (a), so that $K_i = K \cap B_i^3$ is a 2-tangle for each $i = 1, 2$. Then $E(K) \times S^1$ is obtained from $E(K) \times [0, 1]$ by identifying one end $E(K) \times \{0\}$ with the other end $E(K) \times \{1\}$ and $E(K) = (B_1^3 - \nu(K_1)) \cup (B_2^3 - \nu(K_2))$. Since $(B_1^3 - \nu(K_1)) \times [0, 1]$ is the complement of an embedded disk from the 4-ball $B^4 = B_1^3 \times [0, 1]$, we can draw it as a carving 1-handle which is dotted $K \sharp K^*$ as in Figure 2, where K^* is the mirror image of K . We will get one 1-handle, the dotted circle at the bottom of Figure 2, and one 0-framed 2-handle per each 1-handle in $(B_1^3 - \nu(K_1))$ drawn as a 0-framed 2-handle going through the dotted circle at the bottom of Figure 2.

Since the knot surgery 4-manifold X_K is constructed as a union $(X - \nu(F)) \cup_\phi (E(K) \times S^1)$, where F is an embedded torus of square 0 in X and a diffeomorphism $\phi : \partial(E(K) \times S^1) \rightarrow \partial(X - \nu(F)) = \partial(F \times D^2)$ is chosen so that $\phi([m_K \times S^1]) = [F]$ and $\phi([\ell_K]) = [\partial D^2]$, we have to identify the images of three simple closed curves named a , b and c under the map ϕ . It is well known that the map ϕ sends a , b and c in the left figure to the same lettered circle in the right figure as in Figure 2 [Akb02] respectively. Here ℓ denotes the negative of the blackboard framing of K and the small box with letter ℓ means $|\ell|$ times right-handed full twists if ℓ is a positive integer and left-handed full twists if ℓ is a negative integer. In this article we

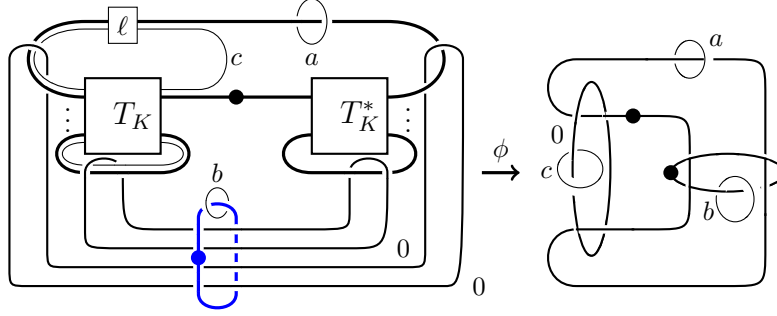

FIGURE 2. A Kirby diagram of $E(K) \times S^1$ and a boundary diffeomorphism

always assume that the curve c in left side of Figure 2, which is corresponding to a 0-framed longitude of K , is given by blackboard framing in the 4-tangle part drawn as T_K in a rectangle.

2.2. Smooth operation on X_K . Recently R. Gompf [Gom16a, Gom16b] constructed an infinite order cork, which is a contractible 4-manifold C with an infinite-order self-diffeomorphism of its boundary $f : \partial C \rightarrow \partial C$ not extending to a diffeomorphism of C . S. Akbulut [Akb16b] and M. Tange [Tan16] also constructed an example of infinite order corks. It is known that the existence of cork is closely related to that of exotic smooth structures on 4-manifolds and the construction of an infinite order cork is based on how a knot surgery 4-manifold is changed under torus twist or δ -move. Gompf also found a condition on torus twist which does not change a smooth structure. Similarly, we try to find a smooth operation in the Kirby diagram of a knot surgery 4-manifold which does not change a smooth structure. For this purpose, we first review torus twist or δ -move. Here is a description of Akbulut's δ -move ([Akb16b, Gom16b]): Let X be any 4-manifold with boundary, γ be a circle in ∂X , and $\delta \subset X$ be an unknot in ∂X obtained by connected summing two parallel copies of γ along a possibly complicated band. Then δ -move is a diffeomorphism $f_\delta : \partial X \rightarrow \partial X$ obtained by first introducing a 2-handle/3-handle canceling pair whose 2-handle is attached along δ with 0-framing, then blowing up along γ_\pm a (± 1) -framed circle, sliding it along the 0-framed δ , and then blowing down along γ_\mp circle again. This procedure is explained in Figure 3 below.

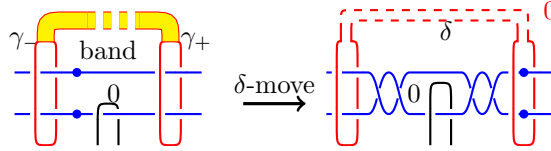

FIGURE 3. δ -move

We note that δ -move is a boundary diffeomorphism and this diffeomorphism usually does not extend to the whole 4-manifold X . The main reason is that blowing-up and blowing-down operations along γ_\pm in δ -move are boundary operation, not a

4-dimensional operation. But in some case the boundary diffeomorphism can extend to the whole 4-manifold and such a phenomenon was already observed by Gompf [Gom16b, Section 4]. In a Kirby diagram of knot surgery 4-manifolds, when we perform Kirby moves, it is not easy to control a carving 1-handle, coming from carving out a slice disk. But we can observe that, if we have a (± 1) -framed 2-handle along γ_- , two strands of a 1-handle (or two 1-handles) going through γ_- and a 0-framed 2-handle located as in Figure 3, then there is a method to introduce a pair of opposite twists on these two strands: If we slide twice this 0-framed 2-handle in Figure 3 over (± 1) -framed 2-handle parallel to γ_- , then it gives a pair of twists on the two strands passing through the circle γ . So we can generate a pair of opposite twists between two strands, a part of 1-handles, without blowing-up/blowing-down operations. This operation sends the (± 1) -framed 2-handle along γ_- to the (± 1) -framed 2-handle along γ_+ (Figure 7). Now assume that K' is a knot obtained from K by adding a full twist corresponding to the above operation. Then we have to find a sequence of handle slides which sends the (± 1) -framed 2-handle along γ_+ back to the (± 1) -framed 2-handle along γ_- and also sends a 0-framed longitude of K to a 0-framed longitude of K' in the Kirby diagram because we need an operation without changing its smooth structure. Under the conditions that

- (1) there is a (± 1) -framed 2-handle along γ_- and a 0-framed 2-handle as in Figure 3 so that Kirby moves in Figure 7 can be applied,
- (2) there is a sequence of Kirby moves which sends the (± 1) -framed 2-handle along γ_+ to the (± 1) -framed 2-handle along γ_- and
- (3) the two strands are oriented oppositely when we consider K as an oriented knot so that this process sends a 0-framed longitude of K to that of K' ,

we can get a smooth operation in a knot surgery 4-manifold X_K which changes the knot K to K' by adding a full twist to K but $X_{K'}$ remains diffeomorphic to X_K . We will prove in Section 3 that, if we take a connected sum of $\mathbb{C}\mathbb{P}^2$ with a smooth 4-manifold X which contains an embedded double node neighborhood and if we perform a knot surgery operation in the double node neighborhood, then these conditions are satisfied.

3. PROOF OF THEOREM 1.1

Let X be a smooth 4-manifold which contains an embedded double node neighborhood, a codimension zero submanifold obtained from $(S^1 \times S^1) \times D^2$ by attaching two (-1) -framed 2-handles along along the first S^1 factor in $\partial((S^1 \times S^1) \times D^2)$, and K be any knot in S^3 . We perform a knot surgery operation along this torus and let X_K be the resulting knot surgery 4-manifold.

First we will show that $X_K \sharp \mathbb{C}\mathbb{P}^2$ is diffeomorphic to $X_{K'} \sharp \mathbb{C}\mathbb{P}^2$ using a Kirby diagram of $E(K) \times S^1$ explained in Section 2, where K' is a knot obtained by changing a crossing in K . If we perform a knot surgery along the torus of square 0 in the embedded double node neighborhood, then the two vanishing cycles, (-1) -framed 2-handles, can be drawn as in Figure 4. Note that Figure 4 without the two (-1) -framed 2-handles is diffeomorphic to Figure 2 because they are related by a sequence of 1-handle slides over 1-handle and 1-handle/2-handle pair cancellations (refer to ribbon move [GS99, Chapter 6]).

If we take a connected sum with $\mathbb{C}\mathbb{P}^2$, then a disjoint $(+1)$ -framed unknot is introduced. Now we perform a series of 2-handle slides as in Figure 5: First slide the $(+1)$ -framed 2-handle over two (-1) -framed 2-handles coming from vanishing

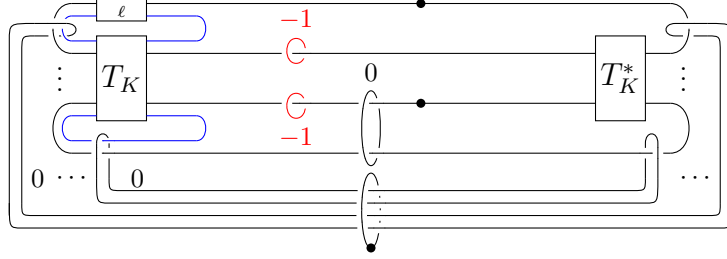
FIGURE 4. $E(K) \times S^1$ in a double node neighborhood

cycles in the double node neighborhood, so that we get a (-1) -framed 2-handle as in the middle of Figure 5. And slide again two vanishing cycles over the (-1) -framed 2-handle to get a linked 0-framed 2-handles in the last of Figure 5. By using this process, we get Figure 6 from Figure 4. Now we get Figure 8 by sliding the 0-framed 2-handle in the middle of Figure 6 as in Figure 7. And then slide the (-1) -framed 2-handle over two 0-framed 2-handles passing through the bottom dotted circle to get Figure 9. We slide twice an embedded circle corresponding to the 0-framed longitude of the knot K over the (-1) -framed 2-handle in order to get Figure 10. Let $T_{K'}$ be a 4-tangle obtained from T_K by adding a right-handed full twist as in Figure 11. Then we apply a reversed sequence of Kirby moves of Figure 5, so that we get Figure 12.

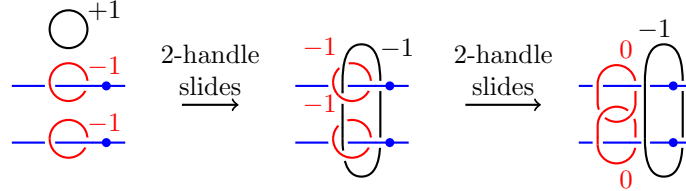

FIGURE 5. Kirby moves

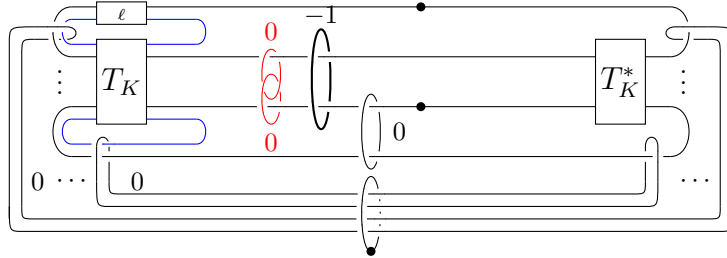

FIGURE 6.

Since we select an orientation of a knot diagram of K and we choose a 4-tangle as in Figure 1 (b), the knot K' obtained by closing the tangle $T_{K'}$ as in Figure 1

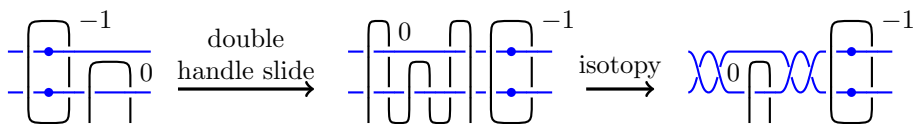

FIGURE 7. Double slides of a 0-framed 2-handle over a (-1)-framed 2-handle

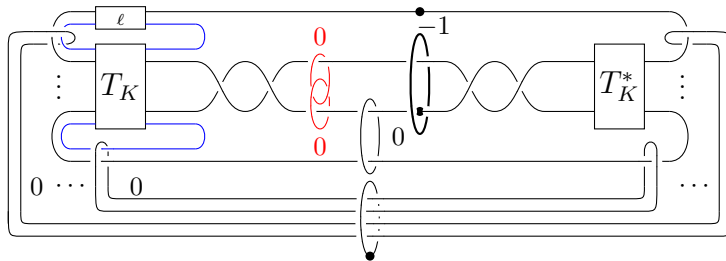

FIGURE 8.

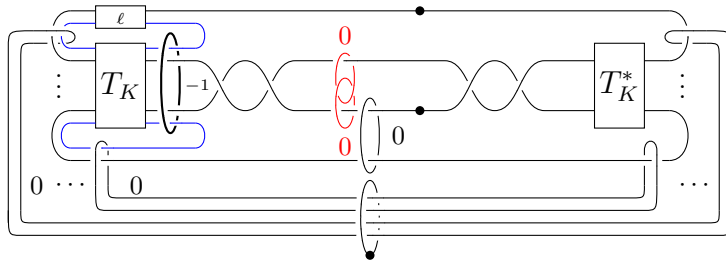

FIGURE 9.

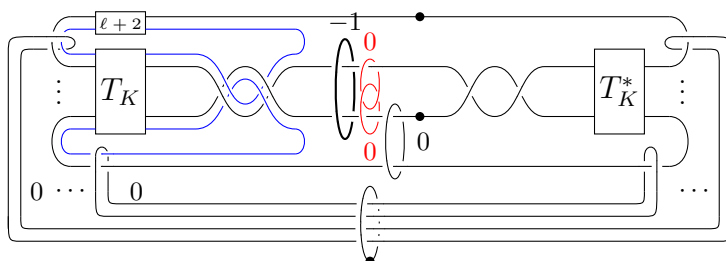

FIGURE 10.

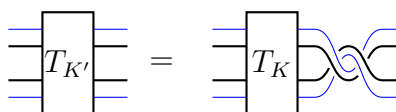
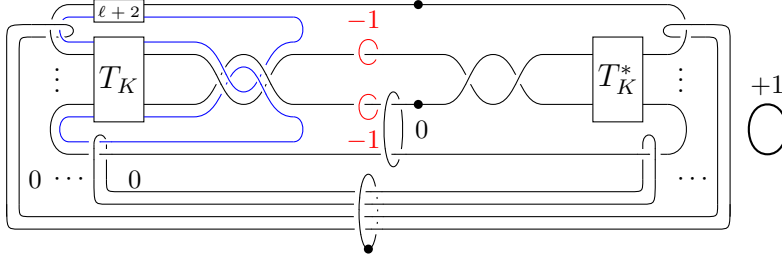

FIGURE 11. A longitude given by a blackboard framing in a 4-tangle diagram

FIGURE 12. $(E(K') \times S^1) \# \mathbb{C}\mathbb{P}^2$ in a double node neighborhood

has a blackboard framing $-(\ell + 2)$, so that the embedded circle in Figure 12 is a 0-framed longitude of K' , where $-\ell$ is the blackboard framing of K . Hence it implies that $X_K \# \mathbb{C}\mathbb{P}^2$ is diffeomorphic to $X_{K'} \# \mathbb{C}\mathbb{P}^2$.

Note that, in the process of Kirby moves in Figure 7, if we start from a (-1) -framed 2-handle located in the right-handed side of the 0-framed 2-handle and we slide it from the left to the right of the (-1) -framed 2-handle, then it will give a left-handed full twist in $T_{K'}$ and its blackboard framing will be $-(\ell - 2)$. So this operation also sends 0-framing of K to 0-framing of K' . Hence, when we get $T_{K'}$ from T_K , we may add a right-handed full twist or a left-handed full twist and this operation sends 0-framing of K to 0-framing of K' . It implies that we can perform this operation in the direction of reducing the unknotting number of K , *i.e.* the unknotting number of K' is less than the unknotting number of K . Since unknotting number is a nonnegative integer, we get the unknot only after finitely many steps. Therefore we conclude that $X_K \# \mathbb{C}\mathbb{P}^2$ is diffeomorphic to $X_U \# \mathbb{C}\mathbb{P}^2$, where U is the unknot. Furthermore, when we perform a knot surgery on X using the unknot U , the knot surgery 4-manifold X_U is the same as the original X . Hence we are done. \square

Proof of Corollary 1.3. Note that the simply connected elliptic surface $E(n)$ with Euler characteristic 12 has a monodromy factorization of the form $(\alpha\beta)^{6n}$, where α and β are right-handed Dehn twists along simple closed curves in a generic fiber F which are parallel to the circle a and b in Figure 2 respectively. By using the braid relation $\alpha\beta\alpha = \beta\alpha\beta$, we always have a portion of the form $\alpha\alpha$ in the monodromy factorization of $E(n)$ because $\alpha\beta\alpha\beta = \alpha\alpha\beta\alpha$. Since $E(n)_K = E(n) \#_{F=m_K \times S^1} (M_K \times S^1)$ and F is a generic elliptic fiber of $E(n)$ which is the core torus in a double node neighborhood $N(\alpha\alpha)$, Theorem 1.1 above implies that $E(n)_K \# \mathbb{C}\mathbb{P}^2$ is diffeomorphic to $E(n) \# \mathbb{C}\mathbb{P}^2$. Furthermore, since it is a well-known fact that $E(n)$ is almost completely decomposable, *i.e.*, $E(n) \# \mathbb{C}\mathbb{P}^2$ is diffeomorphic to $(2n)\mathbb{C}\mathbb{P}^2 \# (10n - 1)\overline{\mathbb{C}\mathbb{P}^2}$ [MM80, Moi77], corollary follows. \square

4. EXAMPLES

In this section, we provide a global Kirby diagram for two families of knot surgery 4-manifolds in order to explain almost complete decomposability. The first example is the Dolgachev surface $E(1)_{2,3}$, whose almost complete decomposability was already known before. We explain this fact using an argument in the proof of main theorem. Note that the Dolgachev surface $E(1)_{2,3}$ is diffeomorphic to a knot

surgery 4-manifold $E(1)_{3_1}$ (equivalently, $E(1)_{3_1^*}$), where 3_1 and 3_1^* denote a left- and right-handed trefoil knot in S^3 respectively. Hence it suffices to see how $E(1)_{3_1^*}$ is untwisted after a connected sum with $\mathbb{C}\mathbb{P}^2$.

$E(1)_{3_1^*}$ case: A Kirby diagram of $E(1)_{3_1^*}$ can be drawn as in Figure 13 (up to 3-handles and a 4-handle). If we take a connected sum with $\mathbb{C}\mathbb{P}^2$, then we get a disjoint $(+1)$ -framed 2-handle on unknot. This Kirby diagram satisfies all conditions in Theorem 1.1 above so that we can apply all operations used in the proof of it. Therefore the tangle part is changed as in Figure 12 and a curve corresponding to the 0-framed longitude goes to the 0-framed longitude of a newly generated knot which is the unknot with two positive crossings and one negative crossing. The other parts coming from $E(1) - \nu(F)$ remain unchanged, so that $E(1)_{3_1^*} \# \mathbb{C}\mathbb{P}^2$ is diffeomorphic to $E(1)_U \# \mathbb{C}\mathbb{P}^2$, where U is the unknot. Here is a detailed proof: Let us first consider a portion of the Kirby diagram in Figure 13 and an extra $(+1)$ -framed 2-handle coming from $\mathbb{C}\mathbb{P}^2$ in Figure 14. We slide this $(+1)$ -framed 2-handle over two (-1) -framed 2-handles as in Figure 5, so that we get Figure 15. Now we apply the operation in Figure 7 to get Figure 16. We slide the (-1) -framed 2-handle over a 0-framed 2-handle to get Figure 17, and we slide again this 2-handle over two 0-framed 2-handles passing through the bottom dotted 1-handle in Figure 13 to get Figure 18 and Figure 19. And then we slide (-1) -framed 2-handle along a 0-framed longitude of K over this (-1) -framed 2-handle twice to get Figure 20. Finally, by using an isotopy and a reversed operation of Figure 5, we get Figure 21 and Figure 22. It gives a Kirby diagram of $E(1)_U \# \mathbb{C}\mathbb{P}^2$.

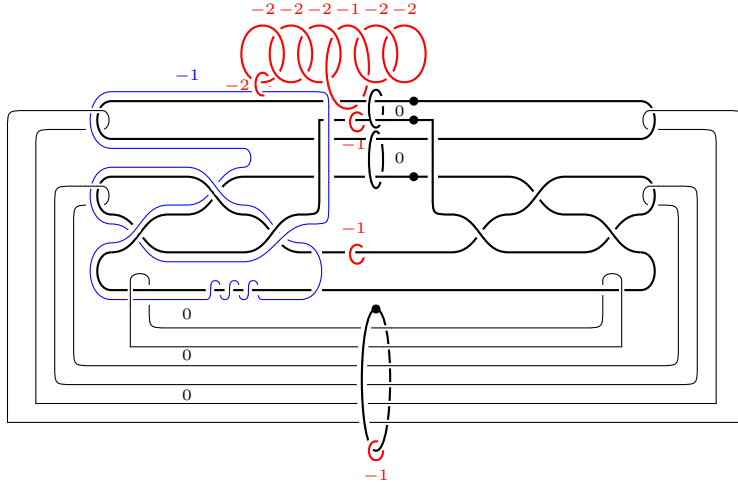

FIGURE 13. A Kirby diagram of $E(1)_{3_1^*}$

$E(1)_{K_n}$ case: Let us consider the Stallings knot K_n which is obtained from $3_1 \# 3_1^*$ by applying Stallings twist n times. A Kirby diagram of $E(1)_{K_0}$ is drawn in Figure 23 (up to 3-handles and a 4-handle). By an operation explained in Figure 5, we get a (-1) -framed 2-handle along a simple closed curve γ_1 or γ_2 in Figure 23. By using

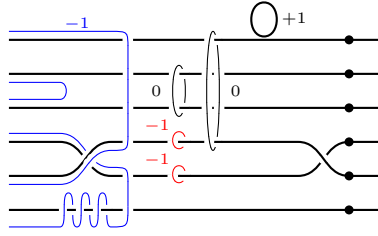

FIGURE 14.

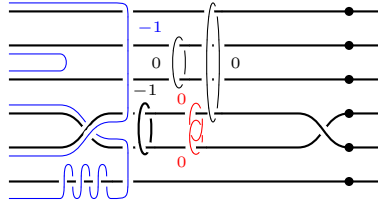

FIGURE 15.

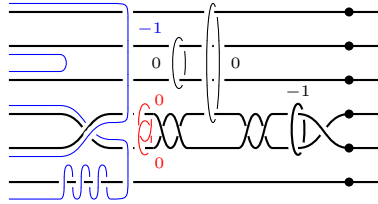

FIGURE 16.

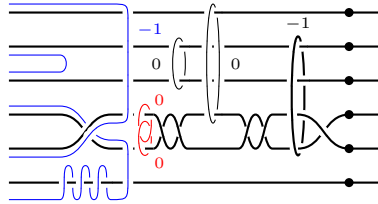

FIGURE 17.

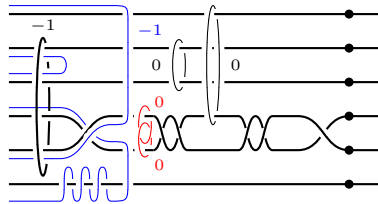

FIGURE 18.

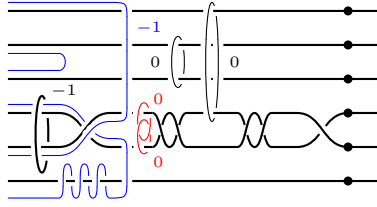

FIGURE 19.

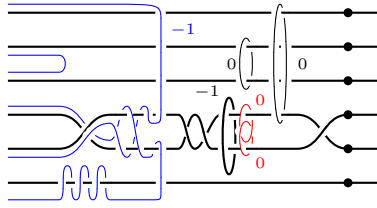

FIGURE 20.

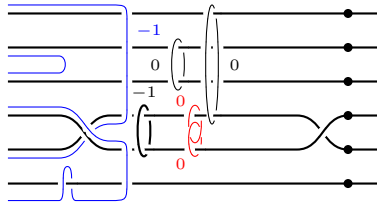

FIGURE 21.

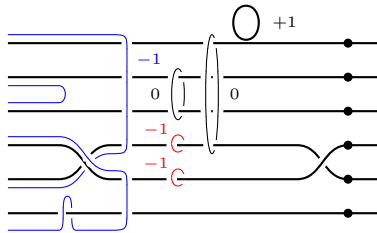
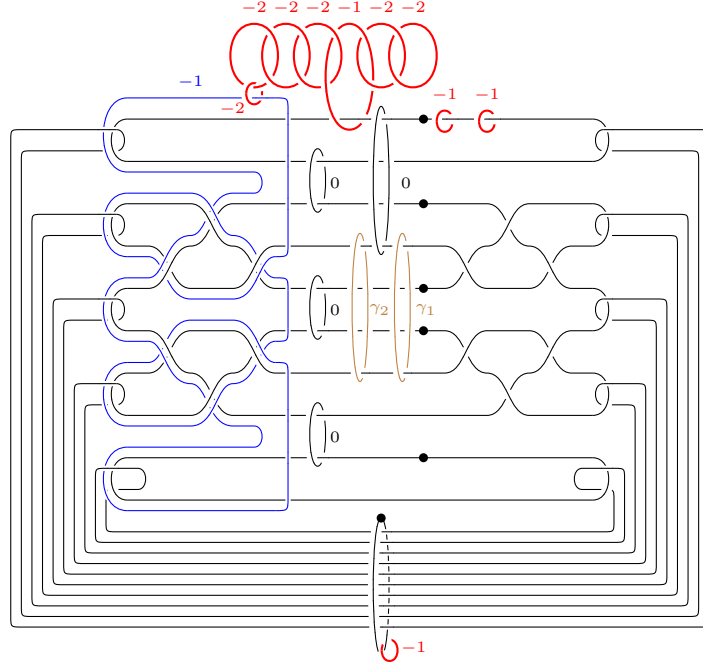

FIGURE 22.

this (-1) -framed 2-handle and by operations explained in proof of Theorem 1.1, we can show that $E(1)_{K_0} \sharp \mathbb{C}P^2$ is diffeomorphic to $E(1)_{K_n} \sharp \mathbb{C}P^2$ for any integer n . Here is a sketch of proof: For a positive integer n , we perform the following sequence of Kirby moves n times repeatedly. (For a negative integer n , we put a (-1) -framed 2-handle along γ_1 and we perform all operations from right to left direction.)

- First we locate two (-1) -framed 2-handles on the fourth and seventh strands (counted from the top) and then we perform an operation in Figure 5, so that we get a (-1) -framed 2-handle along γ_2 .

FIGURE 23. A Kirby diagram of $E(1)_{K_0}$

- We perform an operation in Figure 7. Then this 2-handle will be located at γ_1 and the fourth and seventh strands will be twisted correspondingly.
- We slide this (-1) -framed 2-handle over three 0-framed 2-handles located at the top, middle and bottom left sides and then we slide it over two 0-framed 2-handles passing through the bottom dotted 1-handle which are located at the first and fifth counted from the bottom. We slide it again over the three 0-framed 2-handles located at the top, middle and bottom left sides.
- We slide a (-1) -framed 2-handle on the 0-framed longitude of K_0 over this (-1) -framed 2-handle twice. Then the 2-handle goes back to its original position γ_2 with a framing (-1) , the knot K_0 is changed to K_1 and a 0-framed longitude of K_0 becomes a 0-framed longitude of K_1 .
- We perform an operation in Figure 5 reversely to get a disjoint $(+1)$ -framed 2-handle and this process sends back two vanishing cycles to its original position.

Finally we can show that $E(1)_{K_0} \# \mathbb{C}P^2$ is diffeomorphic to $E(1) \# \mathbb{C}P^2$ by using the same argument as in $E(1)_{3_1^*}$ case with Figure 24.

Remark 4.1. As mentioned in Section 2, R. Gompf [Gom16a, Gom16b] constructed an infinite order cork and M. Tange [Tan16] also constructed an example of infinite order corks, a \mathbb{Z}^k -cork. Note that Gompf's \mathbb{Z} -cork is related to a knot surgery 4-manifold $E(n)_{K_k}$, where K_k is the twisted knot and Tange's \mathbb{Z}^k -cork is related to $E(k)_{K(n_1, n_2, \dots, n_k)}$, where $K(n_1, n_2, \dots, n_k) = K_{1, n_1} \# K_{2, n_2} \# \dots \# K_{k, n_k}$ and $K_{m, n}$

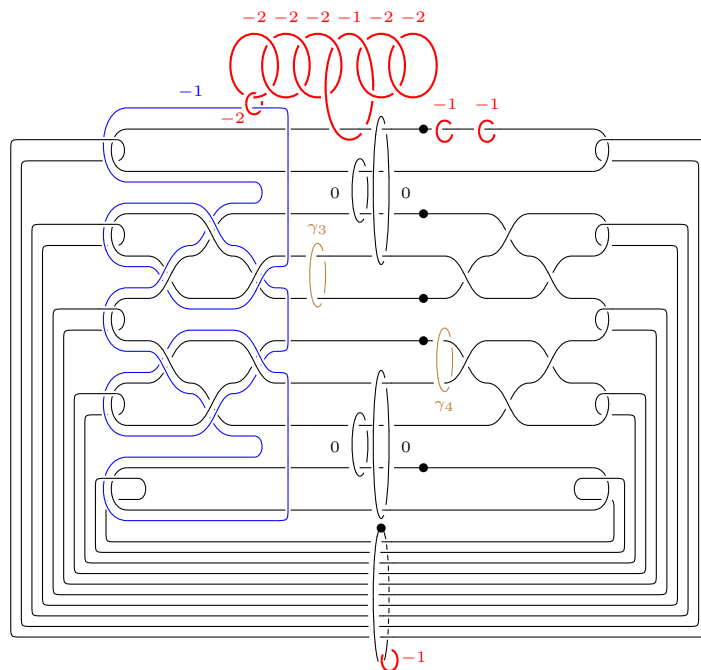
 FIGURE 24. Another Kirby diagram of $E(1)_{K_0}$

is a 2-bridge knot of type $C(2m + 1, -2n, 2)$. So all these examples can also be dissolved under a connected sum with $\mathbb{C}P^2$.

Remark 4.2. Although it is known that every elliptic Lefschetz fibration is almost completely decomposable [Man85], it is not sure whether every simply connected symplectic Lefschetz fibration over S^2 with a high genus fiber is almost completely decomposable or not. Nevertheless, since a family of knot surgery 4-manifolds $E(n)_K$ with a fibered knot K admit a symplectic Lefschetz fibration over S^2 with a high genus fiber [FS04] and they are almost completely decomposable, it is an intriguing question whether all simply connected symplectic Lefschetz fibration over S^2 are almost completely decomposable or not.

REFERENCES

- [Aka06] M. Akaho, *A connected sum of knots and Fintushel-Stern knot surgery on 4-manifolds*, Turkish J. Math. **30** (2006), no. 1, 87–93.
- [Akb02] S. Akbulut, *Variations on Fintushel-Stern knot surgery on 4-manifolds*, Turkish J. Math. **26** (2002), no. 1, 81–92.
- [Akb16a] S. Akbulut, *4-manifolds*, Oxford Graduate Texts in Mathematics, vol. 25, Oxford University Press, Oxford, 2016.
- [Akb16b] S. Akbulut, *On infinite order corks*, arXiv:1605.09348.
- [Auc03] D. Auckly, *Families of four-dimensional manifolds that become mutually diffeomorphic after one stabilization*, Proceedings of the Pacific Institute for the Mathematical Sciences Workshop “Invariants of Three-Manifolds” (Calgary, AB, 1999), vol. 127, 2003, pp. 277–298.
- [Bay17] R. Baykur, *Dissolving knot surgered 4-manifolds by classical cobordism arguments*, arXiv:1704.04491.

- [BaSu13] R. Baykur and N. Sunukjian, *Round handles, logarithmic transforms, and smooth 4-manifolds*, Jour. of Topology **6** (2013), no. 1, 49–63.
- [FS98a] R. Fintushel and R. Stern, *Constructions of smooth 4-manifolds*, Proceedings of the International Congress of Mathematicians, Vol. II (Berlin, 1998), no. Extra Vol. II, 1998, pp. 443–452 (electronic).
- [FS98b] ———, *Knots, links, and 4-manifolds*, Invent. Math. **134** (1998), no. 2, 363–400.
- [FS04] ———, *Families of simply connected 4-manifolds with the same Seiberg-Witten invariants*, Topology **43** (2004), no. 6, 1449–1467.
- [Gom89] R. Gompf, *On the topology of algebraic surfaces*, London Math. Soc. Lecture Note (1989).
- [Gom16a] ———, *Infinite order corks*, Geometry and Topology, arXiv:1603.05090.
- [Gom16b] ———, *Infinite order corks via handle diagrams*, Algebraic and Geometric Topology, arXiv:1607.04354.
- [GS99] R. Gompf and A. Stipsicz, *4-manifolds and Kirby calculus*, American Mathematical Society, Providence, RI, 1999.
- [Man85] R. Mandelbaum, *Lefschetz fibrations of Riemann surfaces and decompositions of complex elliptic surfaces*, Combinatorial methods in topology and algebraic geometry (Rochester, N.Y., 1982), 291–310, Amer. Math. Soc., Providence, RI, 1985.
- [MM76] R. Mandelbaum and B. Moishezon, *On the topological structure of non-singular algebraic surfaces in $\mathbb{C}P^3$* , Topology **15** (1976), no. 1, 23–40.
- [MM80] ———, *On the topology of simply-connected algebraic-surfaces*, Trans. Am. Math. Soc. **260** (1980), no. 1, 195–222.
- [Moi77] B. Moishezon, *Complex surfaces and connected sums of complex projective planes*, Lecture Notes in Mathematics, Vol. 603, Springer-Verlag, Berlin-New York, 1977, With an appendix by R. Livne.
- [Tan16] M. Tange, *Notes on Gompf’s infinite order cork*, arXiv:1609.04345
- [Wal64] C.T.C. Wall, *On simply connected 4-manifolds*, J. London Math. Soc **39** (1964), no. 1, 141–149.

DEPARTMENT OF MATHEMATICAL SCIENCES, SEOUL NATIONAL UNIVERSITY, SEOUL 08826, KOREA

E-mail address: hako85@snu.ac.kr

DEPARTMENT OF MATHEMATICAL SCIENCES, SEOUL NATIONAL UNIVERSITY, SEOUL 08826, KOREA & KOREA INSTITUTE FOR ADVANCED STUDY, SEOUL 02455, KOREA

E-mail address: jipark@snu.ac.kr

DEPARTMENT OF MATHEMATICS, SUNGSHIN WOMEN’S UNIVERSITY, SEOUL 02844, KOREA

E-mail address: kyun@sungshin.ac.kr