

Topological classification of Morse-Smale diffeomorphisms without heteroclinic curves on 3-manifolds

Ch. Bonatti V. Grines F. Laudenbach O. Pochinka *

Contents

1	Introduction and formulation of the result	2
2	Dynamics of diffeomorphisms in the class $G(M)$	4
3	Compatible foliations	7
4	Proof of the classification theorem	12
4.1	Necessity	13
4.2	Sufficiency	13
5	Topological background	27

Abstract

We show that, up to topological conjugation, the equivalence class of a Morse-Smale diffeomorphism without heteroclinic curves on a 3-manifold is completely defined by an embedding of two-dimensional stable and unstable heteroclinic laminations to a characteristic space.

Key words: Morse-Smale diffeomorphism, topological classification, heteroclinic lamination
MSC: 37C05, 37C15, 37C29, 37D15.

*The dynamics and necessary and sufficient conditions of the topological conjugation of Morse-Smale diffeomorphisms without heteroclinic curves on 3-manifolds (Sections 2, 4) were investigated with the support of the Russian Science Foundation (project 17-11-01041). The construction of the compatible foliations and topological research (Sections 3, 5) partially supported by RFBR (project nos. 15-01-03687-a, 16-51-10005-Ko_a), BRP at the HSE (project 90) in 2017 and by ERC Geodycon.

1 Introduction and formulation of the result

In 1937 A. Andronov and L. Pontryagin [2] introduced the notion of a *rough system* of differential equation given in a bounded part of the plane, that is a system which preserves its qualitative properties under parameters variation if the variation is small enough. They proved that the flows generated by such systems are exactly the flows having the following properties:

1. the set of fixed points and periodic orbits is finite and all its elements are hyperbolic;
2. there are no separatrices going from one saddle to itself or to another one;
3. all ω - and α -limit sets are contained in the union of fixed points and periodic orbits (limit cycles).

The above description characterizes the rough flows on the two-dimensional sphere also. After A. Mayer [16] in 1939, a similar result holds true on the 2-torus for flows having a closed section and no equilibrium states. A. Andronov and L. Pontryagin have shown also in [2] that the set of the rough flows is dense in the space of C^1 -flows¹. In 1962 M. Peixoto proved ([22], [23]) that the properties 1-3 are necessary and sufficient for a flow on any orientable surface of genus greater than zero to be structurally stable. He proved the density for these flows as well. Direct generalization of the properties of rough flows on surfaces leads to the following class of dynamical systems continuous or discrete, that is, flows or diffeomorphisms (cascades).

Definition 1.1 *A smooth dynamical system given on an n -dimensional manifold ($n \geq 1$) M^n is called Morse-Smale if:*

1. *its non-wandering set consists of a finite number of fixed points and periodic orbits where each of them is hyperbolic;*
2. *the stable and unstable manifolds W_p^s , W_q^u of any pair of non-wandering points p and q intersect transversely.*

Let M be a given closed 3-dimensional manifold and $f : M \rightarrow M$ be a Morse-Smale diffeomorphism.

For $q = 0, 1, 2, 3$ denote by Ω_q the set of all periodic points of f with q -dimensional unstable manifold. Let Ω_f be the union of all periodic points. Let us represent the dynamics of f in the form “source-sink” in the following way. Set

$$A_f = W_{\Omega_0 \cup \Omega_1}^u, \quad R_f = W_{\Omega_2 \cup \Omega_3}^s, \quad V_f = M \setminus (A_f \cup R_f).$$

We recall that a compact set $A \subset M$ is said to be an *attractor* of f if there is a compact neighborhood N of the set A such that $f(N) \subset \text{int } N$ and $A = \bigcap_{n \in \mathbb{N}} f^n(N)$; and $R \subset M$ is said to be a *repeller* of f if it is an attractor of f^{-1} .

¹This statement was not explicitly formulated in [2] and was mentioned for the first time in papers by E. Leontovich [15] and M. Peixoto [21]. G. Baggis [3] in 1955 made explicit some details of the proofs which were not completed in [2].

By [11, Theorem 1.1] the set A_f (resp. R_f) is an attractor (resp. a repeller) of f whose topological dimension is equal to 0 or 1. By [11, Theorem 1.2] the set V_f is a connected 3-manifold and $V_f = W_{A_f \cap \Omega_f}^s \setminus A_f = W_{R_f \cap \Omega_f}^u \setminus R_f$. Moreover, the quotient $\hat{V}_f = V_f/f$ is a closed connected 3-manifold and when \hat{V}_f is orientable, then it is either irreducible or diffeomorphic to $\mathbb{S}^2 \times \mathbb{S}^1$. The natural projection $p_f : V_f \rightarrow \hat{V}_f$ is an infinite cyclic covering. Therefore, there is a natural epimorphism from the the first homology group of \hat{V}_f to \mathbb{Z} ,

$$\eta_f : H_1(\hat{V}_f; \mathbb{Z}) \rightarrow \mathbb{Z},$$

defined as follows: if γ is a path in V_f joining x to $f^n(x)$, $n \in \mathbb{Z}$, then η_f maps the homology class of the cycle $p_f \circ \gamma$ to n .

The intersection with V_f of the 2-dimensional stable manifolds of the saddle points of f is an invariant 2-dimensional lamination Γ_f^s , with finitely many leaves, and which is closed in V_f . Each leaf of this lamination is obtained by removing from a stable manifold its set of intersection points with the 1-dimensional unstable manifold; this intersection is at most countable. As Γ_f^s is invariant under f , it descends to the quotient in a compact 2-dimensional lamination $\hat{\Gamma}_f^s$ on \hat{V}_f . Note that each 2-dimensional stable manifold is a plane on which f acts as a contraction, so that the quotient by f of the punctured stable manifold is either a torus or a Klein bottle. Thus the leaves of $\hat{\Gamma}_f^s$ are either tori or Klein bottles which are punctured along at most countable set.

One defines in the same way the unstable lamination $\hat{\Gamma}_f^u$ as the quotient by f of the intersection with V_f of the 2-dimensional unstable manifolds. The laminations $\hat{\Gamma}_f^s$ and $\hat{\Gamma}_f^u$ are transverse.

Definition 1.2 *The sets $\hat{\Gamma}_f^s$ and $\hat{\Gamma}_f^u$ are called the two-dimensional stable and unstable laminations associated with the diffeomorphism f .*

A precise definition of what a lamination is will be given in Definition 2.1.

Definition 1.3 *The collection $S_f = (\hat{V}_f, \eta_f, \hat{\Gamma}_f^s, \hat{\Gamma}_f^u)$ is called the scheme of the diffeomorphism f .*

Definition 1.4 *The schemes S_f and $S_{f'}$ of two Morse-Smale diffeomorphisms $f, f' : M \rightarrow M$ are said to be equivalent if there is a homeomorphism $\hat{\varphi} : \hat{V}_f \rightarrow \hat{V}_{f'}$ with following properties:*

- (1) $\eta_f = \eta_{f'} \hat{\varphi}_*$;
- (2) $\hat{\varphi}(\hat{\Gamma}_f^s) = \hat{\Gamma}_{f'}^s$ and $\hat{\varphi}(\hat{\Gamma}_f^u) = \hat{\Gamma}_{f'}^u$, meaning that $\hat{\varphi}$ maps leaf to leaf.

Using the above notion of a scheme in a series of papers by Ch. Bonatti, V. Grines, V. Medvedev, E. Pecou, O. Pochinka [5], [7], [8], [9], the problem of classification up to topological conjugacy of Morse-Smale diffeomorphisms on 3-manifolds has been solved in some particular cases. Recall that two diffeomorphisms f and f' of M are said to be *topologically conjugate* if there is a homeomorphism $h : M \rightarrow M$ which satisfies $f'h = hf$.

In the present article, we give the topological classification of the Morse-Smale diffeomorphisms belonging to the subset $G(M)$ of the Morse-Smale diffeomorphisms $f : M \rightarrow M$ which have no heteroclinic curves (see Section 2). According to [6], when the ambient manifold is orientable, then it is either sphere \mathbb{S}^3 or the connected sum of a finite number copies of $\mathbb{S}^2 \times \mathbb{S}^1$.

Theorem 1 *Two Morse-Smale diffeomorphisms in $G(M)$ are topologically conjugate if and only if their schemes are equivalent.*

The structure of the paper is the following:

- In Section 2 we describe the dynamics of Morse-Smale diffeomorphisms and their space of wandering orbits.
- In Section 3 we construct a compatible system of neighborhoods, which is a key point for the construction of a conjugating homeomorphism.
- In Section 4 we construct a conjugating homeomorphism.
- Section 5 is an appendix of 3-dimensional topology. We prove there some topological lemmas which are used in Section 4.

2 Dynamics of diffeomorphisms in the class $G(M)$

In this section we introduce some notions connected with Morse-Smale diffeomorphisms on 3-manifold M . More detailed information on Morse-Smale diffeomorphisms is contained in [13] for example.

Let $f : M \rightarrow M$ be a Morse-Smale diffeomorphism. If x is a periodic point its *Morse index* is the dimension of its unstable manifold W_x^u ; the point x is called a *saddle point* when its two invariant manifolds have positive dimension, that is, its Morse index is not extremal. A *sink point* has Morse index 0 and a *source point* has Morse index 3. The following notions are key concepts for describing how the stable manifolds of saddle points intersect the unstable ones. If x, y are distinct saddle points of f and $W_x^u \cap W_y^s \neq \emptyset$, then:

- if $\dim W_x^s < \dim W_y^s$, any connected component of $W_x^u \cap W_y^s$ is 1-dimensional and called a *heteroclinic curve* (see figure 1);
- if $\dim W_x^s = \dim W_y^s$, the set $W_x^u \cap W_y^s$ is countable; each of its points is called a *heteroclinic point*; the orbit of a heteroclinic point is called a *heteroclinic orbit*.

According to S. Smale [24], it is possible to define a partial order in the set of saddle points of a given Morse-Smale diffeomorphism f as follows: for different periodic orbits $p \neq q$, one sets $p \prec q$ if and only if $W_q^u \cap W_p^s \neq \emptyset$. Smale proved that this relation is a partial order. In that case, it follows from [18, Lemma 1.5] that there is a sequence of different periodic orbits p_0, \dots, p_n satisfying the following conditions: $p_0 = p$, $p_n = q$ and $p_i \prec p_{i+1}$. The sequence p_0, \dots, p_n is said to be an *n-chain connecting p to q*. The length of the longest chain connecting p to q is denoted by $beh(q|p)$. If $W_q^u \cap W_p^s = \emptyset$, we pose $beh(q|p) = 0$. For a subset P of the periodic orbits let us set $beh(q|P) = \max_{p \in P} \{beh(q|p)\}$. The present paper is devoted to studying Morse-Smale diffeomorphisms in dimension 3 which have no heteroclinic curves. We recall from the introduction that this class of diffeomorphisms is denoted by $G(M)$. Let $f \in G(M)$. It follows from [11] that if the set Ω_2 is empty then R_f consists of a unique source. If $\Omega_2 \neq \emptyset$,

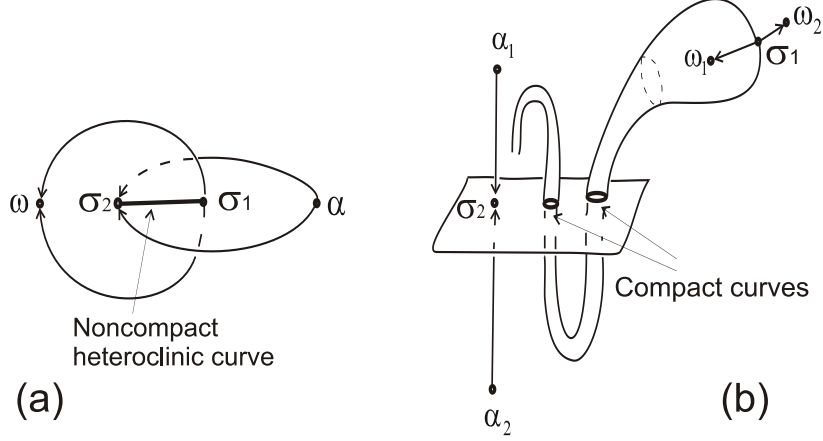

Figure 1: Heteroclinic curves

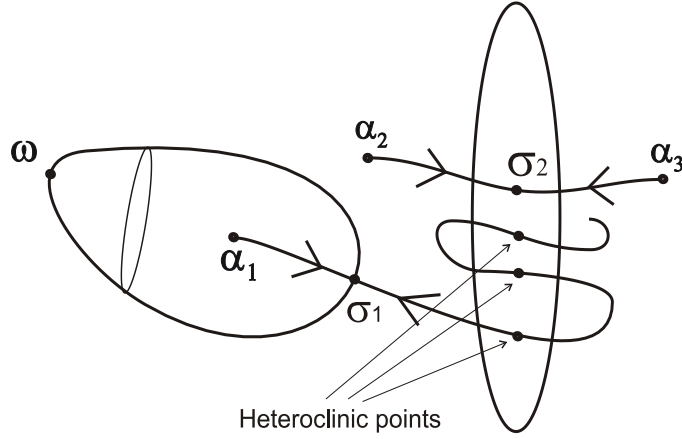

Figure 2: Heteroclinic points

denote by n the length of the longest chain connecting two points of Ω_2 . Divide the set Ω_2 into f -invariant disjoint parts $\Sigma_0, \Sigma_1, \dots, \Sigma_n$ using the rule: $beh(q|\Omega_2 \setminus q) = 0$ for each orbit $q \in \Sigma_0$ and $beh(q|\Sigma_i) = 1$ for each orbit $q \in \Sigma_{i+1}$, $i \in \{0, \dots, n-1\}$. Since Ω_1 for f is Ω_2 for f^{-1} , then it is possible to divide the periodic orbits of the set Ω_1 into parts in a similar way. The absence of heteroclinic curves means that there are no chains connecting a saddle from Ω_2 with a saddle from Ω_1 . Thus we explain all material for Ω_2 and say that all is similar for Ω_1 .

Set $W_i^u := W_{\Sigma_i}^u$, $W_i^s := W_{\Sigma_i}^s$. Then, $R_f := \bigcup_{i=0}^n cl(W_i^s)$, where $cl(\cdot)$ stands for the closure of (\cdot) . We now specify what a lamination is and which sort of regularity it may have. There are different possible notations. Here, we use the one which is given in [10, Definition 1.1.22].

Definition 2.1 *Let X be a n -dimensional and $Y \subset X$ be a closed subset. Let q be an integer $0 < q < n$. A codimension- q lamination with support Y is a decomposition $Y = \bigcup_{j \in J} L_j$ into pairwise disjoint smooth $(n-q)$ -dimensional connected manifolds L_j , which are called the leaves.*

The family $L = \{L_j, j \in J\}$ is said to be a $C^{1,0}$ -lamination² if for every point $x \in Y$ the following conditions hold:

- (1) There are an open neighborhood $U_x \subset X$ of x and a homeomorphism $\psi : U_x \rightarrow \mathbb{R}^n$ such that ψ maps every plaque, that is a connected component of $U_x \cap L_j$, into a codimension- q subspace $\{(x^1, \dots, x^n) \in \mathbb{R}^n \mid x^{n-q+1} = c^{n-q+1}, \dots, x^n = c^n\}$. If $Y = X$ one says that \mathcal{L} is foliation.
- (2) The tangent plane field $TY := \bigcup_{j \in J} TL_j$ exists on Y and is continuous.

By definition, two points belong to the same *leaf* of a lamination if they are linked by a path which is covered by finitely many plaques.

By abuse, a lamination and its support are generally denoted in the same way. We recall the λ -Lemma in the strong form which is proved in [19, Remarks p. 85].

Lemma 2.2 (λ -lemma.) *Let $f : X \rightarrow X$ be a diffeomorphism of an n -manifold, and let p be a fixed point of f . Denote W_p^u and W_p^s be the unstable and stable manifold respectively; say $\dim W_p^u = m$, $0 < m < n$. Let B^s be a compact subset of W_p^s (containing p or not) and let $F : B^s \rightarrow C^1(\mathbb{D}^m, X)$ be a continuous family of embedded closed m -disks of class C^1 transverse to W_p^s and meeting B^s ; set $F(x) := D_x^u$. Let $D^u \subset W_p^u$ be a compact m -disk and let $V \subset X$ be a compact n -ball such that D^u is a connected component of $W_p^u \cap V$. Then, when k goes to $+\infty$, the sequence $f^k(D_x^u) \cap V$ converges to D^u in the C^1 topology uniformly for $x \in B^s$.*

Notice that it is important for applications that B^s may not contain the point p . Going back to our setting, a first application of the λ -lemma is that we have $W_i^u \subset cl(W_{i+1}^u)$ and the closure of $cl(W_0^u) = W_0^u \cup \Omega_0$. Moreover, $cl(W_n^u) \cap (M \setminus \Omega_0)$ is a $C^{1,0}$ -lamination of codimension one. From this one derives that \hat{L}_f^u is also a $C^{1,0}$ -lamination. Here is a typical example.

On Figure 3 there is a phase portrait of a diffeomorphism $f \in G(M)$ whose non-wandering set Ω_f consists of fixed points: one sink ω , three saddle points $\Sigma_0 = \sigma_0$, $\Sigma_1 = \sigma_1$, $\Sigma_2 = \sigma_2$ with two-dimensional unstable manifolds and four sources $\alpha_0, \alpha_1, \alpha_2, \alpha_3$. We will illustrate all further proofs with this diffeomorphism. For this case $V_f := W_\omega^s \setminus \{\omega\}$. As the restriction of f to the basin W_ω^s of ω is topologically conjugate to any homothety, \hat{V}_f is diffeomorphic to $\mathbb{S}^2 \times \mathbb{S}^1$. As $f|_{W_i^u}$ is topologically conjugate to a homothety then $(W_i^u \setminus \Sigma_i)/f$ is diffeomorphic to the 2-torus; but this torus does not embed to \hat{V}_f , except when $i = 0$. On Figure 4 there is the lamination associated with the diffeomorphism $f \in G(M)$ whose phase portrait is on Figure 3. On the left, the lamination is embedded in $\mathbb{S}^2 \times \mathbb{S}^1$ which is seen as the double of $\mathbb{S}^2 \times \mathbb{D}^1$.

We are going to show that the topological classification of diffeomorphisms in the class $G(M)$ reduces to classifying some appropriate laminations $\hat{\Gamma}_f^u$ and $\hat{\Gamma}_f^s$. The technical key to the proof consists of constructing special foliations in some neighborhoods of the laminations.

²There are different possible notations. Here, we use the one which is given in [10, Definition 1.1.22].

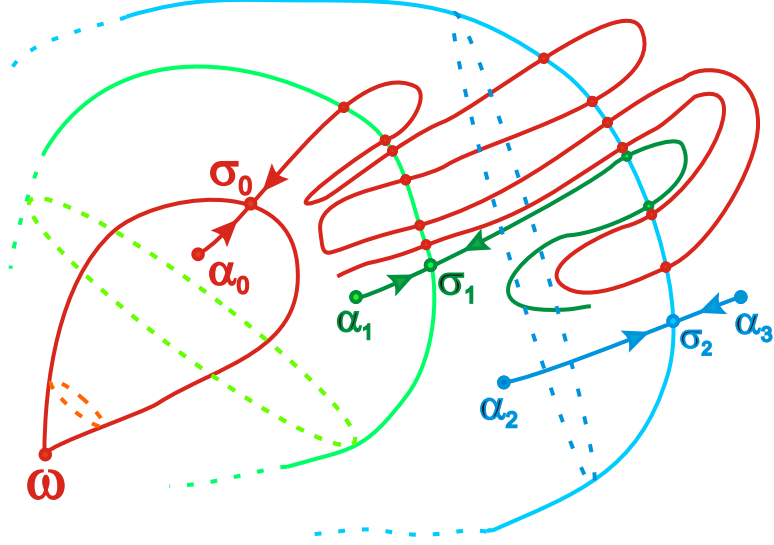

Figure 3: A phase portrait of a diffeomorphism from the class $G(M)$.

3 Compatible foliations

Let $f \in G(M)$. Recall that we divided the set Ω_2 into the f -invariant parts $\Sigma_0, \dots, \Sigma_n$. Using this partition, we explain how to construct compatible foliations (see Definition 3.3) around $W_{\Omega_2}^u \cup W_{\Omega_2}^s$. Similarly, it is possible to construct compatible foliations around $W_{\Omega_1}^s \cup W_{\Omega_1}^u$. In what follows, we give ourselves four models of concrete hyperbolic linear isomorphisms $\mathcal{E}_{\kappa, \nu} \in GL(\mathbb{R}^3)$, $\kappa, \nu \in \{-, +\}$ given by the following formula:

$$\mathcal{E}_{\kappa, \nu}(x_1, x_2, x_3) = (\kappa 2x_1, 2x_2, \nu \frac{x_3}{4}).$$

The origin O is the unique fixed point which is a saddle point with unstable manifold $W_O^u = Ox_1x_2$ and stable manifold $W_O^s = Ox_3$. If $\kappa = +$ (resp. $-$), the orientation of the unstable manifold is preserved (resp. reversed), and similarly for the orientation of the stable manifold with respect to ν . We refer to each of them as the *canonical diffeomorphism*; it will be denoted by \mathcal{E} ignoring the sign. For $p \in \Omega_2$, let $per(p)$ denote the period of f at p .

Definition 3.1 *A neighborhood N_p of a saddle point $p \in \Omega_2$ is called linearizable if there is a homeomorphism $\mu_p : N_p \rightarrow \mathcal{N}$ which conjugates the diffeomorphism $f^{per(p)}|_{N_p}$ to the canonical diffeomorphism $\mathcal{E}|_{\mathcal{N}}$.*

According to the local topological classification of hyperbolic fixed point [19, Theorem 5.5], every $p \in \Omega_2$ has a linearizable neighborhood N_p . For $t \in (0, 1)$, set $\mathcal{N}^t := \{(x_1, x_2, x_3) \in \mathbb{R}^3 \mid -t < (x_1^2 + x_2^2)x_3 < t\}$ and $\mathcal{N} := \mathcal{N}^1$. The set \mathcal{N}^t is invariant by the canonical diffeomorphism \mathcal{E} . By [24], W_p^s and W_p^u are smooth submanifolds of M . The *boundary* of \mathcal{N} is the surface in \mathbb{R}^3 defined by the equations $(x_1^2 + x_2^2)x_3 = \pm 1$. The open manifold N_p has a similar boundary

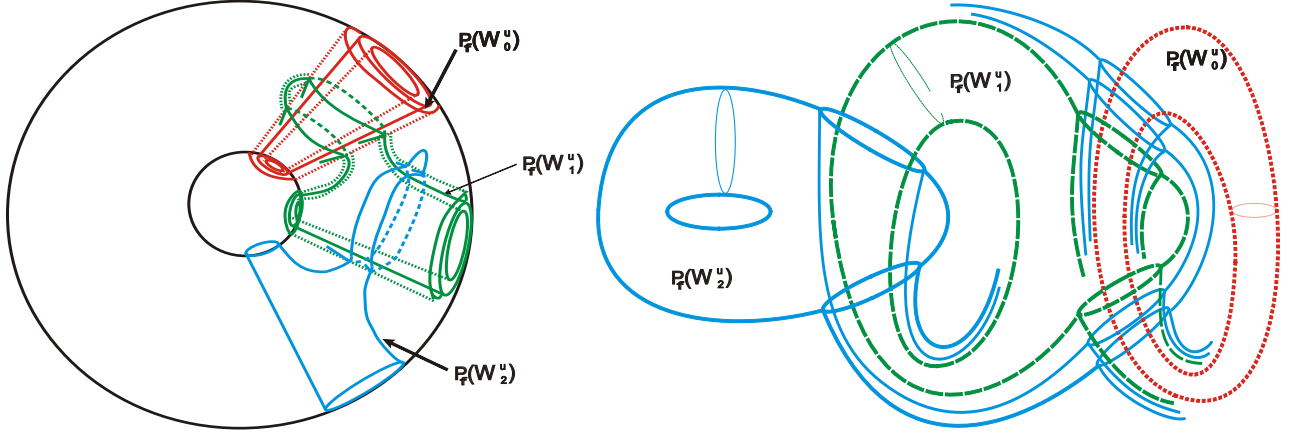

Figure 4: A lamination associated with the diffeomorphism $f \in G(M)$ whose phase portrait is pictured in Figure 3.

in M denoted by ∂N_p . This boundary is formed by points which are not in N_p but are limit points of arcs in N_p ; it is distinct from its closure as a subset of M . Clearly, the linearizing homeomorphism μ_p extends to ∂N_p . For each $i \in \{0, \dots, n\}$, choose some $p \in \Sigma_i$ and μ_p conjugating $f^{per(p)}$ to $\mathcal{E}|_{\mathcal{N}}$. Then, for $k \in \{1, \dots, per(p) - 1\}$ define $\mu_{f^k(p)}$ so that the next formula holds for every $x \in N_{f^{k-1}(p)}$:

$$\mu_{f^k(p)}(f(x)) = \mu_{f^{k-1}(p)}(x).$$

We define a pair of transverse foliations $(\mathcal{F}^u, \mathcal{F}^s)$ in \mathcal{N} in the following way:

- the leaves of \mathcal{F}^u are the fibres in \mathcal{N} of the projection $(x_1, x_2, x_3) \mapsto x_3$;
- the leaves of \mathcal{F}^s are the fibres in \mathcal{N} of the projection $(x_1, x_2, x_3) \mapsto (x_1, x_2)$.

By construction, W_O^u and W_O^s are leaves of \mathcal{F}^u and \mathcal{F}^s respectively. Let N_i denote the union $\bigcup_{p \in \Sigma_i} N_p$. This is an f -invariant neighborhood of Σ_i . Let $\mu_i : N_i \rightarrow \mathcal{N}$ be the map whose restriction to N_p is μ_p . Thus, taking the pullback of them by μ_i gives a pair of f -invariant foliations (F_i^u, F_i^s) on N_i which are said to be *linearizable*. By construction, W_i^u and W_i^s are made of leaves of F_i^u and F_i^s respectively. Sometimes we want to deform the linearizable neighborhood N_p by *shrinking*. Observe that the homotheties of ratio $\rho \in (0, 1)$ act on \mathcal{N} preserving \mathcal{F}^u and \mathcal{F}^s and map \mathcal{N} to \mathcal{N}^{ρ^3} . By conjugation, similar contractions c_ρ are available in N_p for every $p \in \Omega_2$. The neighborhood $c_\rho(N_p)$ is said to be obtained from N_p by *shrinking*.

Lemma 3.2 *For every $\rho \in (0, 1)$, the shrunk neighborhood $c_\rho(N_p)$ is linearizable. Generically, the boundary of $c_\rho(N_p)$ does not contain any heteroclinic point.*

Proof: For a given μ_p , we define μ_p^ρ as follows: its domain is $\mu_p^{-1}(\mathcal{N}^{\rho^3})$ and, on this domain, it is defined by $\mu_p^\rho = c_\rho^{-1} \circ \mu_p$. Its range is \mathcal{N} . Since the heteroclinic points form a countable

set, for almost every $\rho \in (0, 1)$ the boundary of the domain of μ_p^ρ avoids the heteroclinic points. \diamond

Observe that the canonical diffeomorphism and the contraction c_ρ keep both foliations invariant. Recall the f -invariant partition $\Omega_2 = \Sigma_0 \sqcup \Sigma_1 \sqcup \dots \sqcup \Sigma_n$. Let us introduce the following notations:

- for any $t \in (0, 1)$, set $N_p^t := \mu_p^{-1}(\mathcal{N}^t)$ and $N_i^t := \bigcup_{p \in \Sigma_i} N_p^t$;
- for any point $x \in N_i$, denote $F_{i,x}^u$ (resp. $F_{i,x}^s$) the leaf of the foliation F_i^u (resp. F_i^s) passing through x ;
- for each point $x \in N_i$, set $x_i^u = W_i^u \cap F_{i,x}^s$ and $x_i^s = W_i^s \cap F_{i,x}^u$. Thus, we have $x = (x_i^u, x_i^s)$ in the coordinates defined by μ_i .

We also introduce the *radial functions* $r_i^u, r_i^s : N_i \rightarrow [0, +\infty)$ defined by:

$$r_i^u(x) = \|\mu_i(x_i^u)\|^2 \quad \text{and} \quad r_i^s(x) = |\mu_i(x_i^s)|.$$

With this definition at hand, the neighborhood N_i^t of Σ_i is defined by the inequality

$$r_i^u(x)r_i^s(x) < t.$$

Observe that the radial function r_i^s endows each stable separatrix of $p \in \Sigma_p$ with a natural order which will be used later in the proof of Theorem 1.

Definition 3.3 *The linearizable neighborhoods N_0, \dots, N_n are called compatible if, for any $0 \leq i < j \leq n$ and $x \in N_i \cap N_j$, the following holds:*

$$F_{j,x}^s \cap N_i \subset F_{i,x}^s \quad \text{and} \quad F_{i,x}^u \cap N_j \subset F_{j,x}^u.$$

If linearizable neighborhoods are compatible, they remain so after some of them are shrunk.

Remark 3.4 The notion of compatible foliations is a modification of the admissible systems of tubular families introduced by J. Palis and S. Smale in [18] and [20].

We introduce the following notation:

- For $i \in \{0, \dots, n\}$, set $A_i := A_f \cup \bigcup_{j=0}^i W_j^u$,
 $V_i := W_{A_i \cap \Omega_f}^s \setminus A_i$, $\hat{V}_i := V_i/f$. Observe that f acts freely on V_i and denote the natural projection by $p_i : V_i \rightarrow \hat{V}_i$.
- For $j, k \in \{0, \dots, n\}$ and $t \in (0, 1)$, set $\hat{W}_{j,k}^s = p_k(W_j^s \cap V_k)$, $\hat{W}_{j,k}^u = p_k(W_j^u \cap V_k)$,
 $\hat{N}_{j,k}^t = p_k(N_j^t \cap V_k)$.
- $L^u := \bigcup_{i=0}^n W_i^u$, $L^s := \bigcup_{i=0}^n W_i^s$, $L_i^u := L^u \cap V_i$, $L_i^s := L^s \cap V_i$, $\hat{L}_i^u := p_i(L_i^u)$, $\hat{L}_i^s := p_i(L_i^s)$.

Theorem 2 For each diffeomorphism $f \in G(M)$ there exist compatible linearizable neighborhoods of all saddle points whose Morse index is 2.

Proof: The proof consists of three steps.

Step 1. Here, we prove the following claim.

Lemma 3.5 There exist f -invariant neighborhoods U_0^s, \dots, U_n^s of the sets $\Sigma_0, \dots, \Sigma_n$ respectively, equipped with two-dimensional f -invariant foliations F_0^u, \dots, F_n^u of class $C^{1,0}$ such that the following properties hold for each $i \in \{0, \dots, n\}$:

- (i) the unstable manifolds W_i^u are leaves of the foliation F_i^u and each leaf of the foliation F_i^u is transverse to L_i^s ;
- (ii) for any $0 \leq i < k \leq n$ and $x \in U_i^s \cap U_k^s$, we have the inclusion $F_{k,x}^u \cap U_i^s \subset F_{i,x}^u$.

Proof: Let us prove this by a decreasing induction on i from $i = n$ to $i = 0$. For $i = n$, it follows from the definition of V_n that $(W_n^s \setminus \Sigma_n) \subset V_n$. Since f acts freely and properly on W_n^s , the quotient $\hat{W}_{n,n}^s$ is a smooth submanifold of \hat{V}_n ; it consists of finitely many circles. The lamination \hat{L}_n^s accumulates on $\hat{W}_{n,n}^s$. Choose an open tubular neighborhood \hat{N}_n^s of $\hat{W}_{n,n}^s$ in \hat{V}_n ; denote its projection by $\pi_n^u : \hat{N}_n^s \rightarrow \hat{W}_{n,n}^s$. Its fibers form a 2-disc foliation $\{d_{n,x}^u \mid x \in \hat{W}_{n,n}^s\}$ transverse to $\hat{W}_{n,n}^s$. Since \hat{L}_n^s is a $C^{1,0}$ -lamination containing $\hat{W}_{n,n}^s$, each plaque of $\hat{W}_{n,n}^s$ is the C^1 -limit of any sequence of plaques approaching it C^0 . Therefore, if the tube \hat{N}_n^s is small enough, its fibers are transverse to \hat{L}_n^s .

Set $U_n^s := p_n^{-1}(\hat{N}_n^s) \cup W_n^u$. This is an open set of M which carries a foliation F_n^u defined by taking the preimage of the fibers of π_n^u and by adding W_n^u as extra leaves. This is the requested foliation satisfying (i) and (ii) for $i = n$. Notice that the plaques of F_n^u are smooth and by the λ -lemma, for any compact disc B in W_n^u there is $\varepsilon > 0$ such that every plaque of F_n^u which is ε -close to B in topology C^0 is also ε -close to B in topology C^1 . Hence, F_n^u is a $C^{1,0}$ -foliation.

For the induction, we assume the construction is done for every $j > i$ and we have to construct an f -invariant neighborhood U_i^s of the saddle points in Σ_i carrying an f -invariant foliation F_i^u satisfying (i) and (ii). Moreover, by genericity the boundary ∂U_j^s , $j > i$, is assumed to avoid all heteroclinic points. For $j > i$, let $\hat{U}_{j,i}^s := p_i(U_j^s \cap V_i)$ and $\hat{F}_{j,i}^u := p_i(F_j^u \cap V_i)$. For the same reason as in the case $i = n$, the set $\hat{W}_{i,i}^s$ is a smooth submanifold of \hat{V}_i consisting of circles. Choose a tubular neighborhood \hat{N}_i^s of $\hat{W}_{i,i}^s$ with a projection $\pi_i^u : \hat{N}_i^s \rightarrow \hat{W}_{i,i}^s$ whose fibers are 2-discs. Similarly, $(W_{i+1}^u \setminus \Sigma_i) \subset V_i$ and, hence, $\hat{W}_{i+1,i}^u$ is a compact submanifold, consisting of finitely many tori or Klein bottles. The set \hat{L}_i^u is a compact lamination and its intersection with $\hat{W}_{i,i}^s$ consists of a countable set of points which are the projections of the heteroclinic points belonging to the stable manifolds W_i^s . Actually, there is a hierarchy in $\hat{L}_i^u \cap \hat{W}_{i,i}^s$ which we are going to describe in more details.

Set $H_k := \hat{W}_{i+k,i}^u \cap \hat{W}_{i,i}^s$ for $k > 0$. Since $\hat{W}_{i+1,i}^u$ is compact, H_1 is a finite set: $H_1 = \{h_1^1, \dots, h_{t(1)}^1\}$. We are given neighborhoods, called *boxes*, B_ℓ^1 , $\ell = 1, \dots, t(1)$, about these points, namely, the connected components of $\hat{U}_{i+1,i}^s \cap \hat{N}_i^s$. Due to the fact that $\partial \hat{U}_{i+1,i}^s$ contains no heteroclinic point, $\partial \hat{U}_{i+1,i}^s \cap \hat{W}_{i,i}^s$ is isolated from \hat{L}_i^u . Therefore, if the tube \hat{N}_i^s is small enough,

\hat{L}_i^u does not intersect $\partial\hat{U}_{i+1,i}^s \cap \hat{N}_i^s$. Then, by shrinking U_j^s , $j > i + 1$ (in the sense of Lemma 3.2) if necessary, we may guarantee that $\hat{U}_{j,i}^s \cap \hat{N}_i^s$ is disjoint from $\partial\hat{U}_{i+1,i}^s \cap \hat{N}_i^s$.

Since $\hat{W}_{i+2,i}^u$ accumulates on $\hat{W}_{i+1,i}^u$, there are only finitely many points of H_2 outside of all boxes B_ℓ^1 , $\ell = 1, \dots, t(1)$. Let $\bar{H}_2 := \{h_1^2, \dots, h_{t(2)}^2\}$ be this finite set. The open set $\hat{U}_{i+2,i}^s$ is a neighborhood of \bar{H}_2 . The connected components of $\hat{U}_{i+2,i}^s \cap \hat{N}_i^s$ which contain points of \bar{H}_2 will be the box B_ℓ^2 for $\ell = 1, \dots, t(2)$. We argue with B_ℓ^2 with respect to \hat{L}_i^u and the neighborhoods $\hat{U}_{j,i}$, $j > i + 1$, in a similar manner as we do with B_ℓ^1 . And so on, until \bar{H}_n .

Due to the induction hypothesis, each above-mentioned box is foliated. Namely, B_ℓ^1 is foliated by $\hat{F}_{i+1,i}^u$; the box B_ℓ^2 is foliated by $\hat{F}_{i+2,i}^u$, and so on. But the leaves are not contained in fibres of \hat{N}_i^s ; even more, not every leaf intersects $\hat{W}_{i,i}^s$. We have to correct this situation in order to construct the foliation F_i^u satisfying the requested conditions (i) and (ii). For every $j > i$, the foliation F_j^u may be extended to the boundary ∂U_j^s and a bit beyond. Once this is done, if \hat{N}_i^s is enough shrunk, each leaf of $\hat{F}_{i+k,i}^u$ through $x \in B_\ell^k$ intersects $\hat{W}_{i,i}^s$ (it is understood that the boxes are intersected with the shrunk tube without changing their names). Thus, we have a projection along the leaves $\pi_{k,\ell} : B_\ell^k \rightarrow \hat{W}_{i,i}^s$; but, the image of $\pi_{k,\ell}$ is larger than $B_\ell^k \cap \hat{W}_{i,i}^s$. Then, we choose a small enlargement $B_\ell^{k'}$ of B_ℓ^k such that $B_\ell^{k'} \setminus B_\ell^k$ is foliated by $\hat{F}_{i+k,i}^u$ and avoids the lamination \hat{L}_i^u . On $B_\ell^{k'} \setminus B_\ell^k$ we have two projections: one is $\hat{\pi}_i^u$ and the other one is $\pi_{k,\ell}$. We are going to interpolate between both using a partition of unity (we do it for B_ℓ^k but it is understood that it is done for all boxes). Let $\phi : \hat{N}_i^s \rightarrow [0, 1]$ be a smooth function which equals 1 near B_ℓ^k and whose support is contained in $B_\ell^{k'}$. Define a global C^1 retraction $\hat{q} : \hat{N}_i^s \rightarrow \hat{W}_{i,i}^s$ by the formula

$$\hat{q}(x) = (1 - \phi(x))\hat{\pi}_i^u(x) + \phi(x)(\pi_{k,\ell}(x)).$$

Here, we use an affine manifold structure on each component of $\hat{W}_{i,i}^s$ by identifying it with the 1-torus $\mathbb{T} := \mathbb{R}/\mathbb{Z}$. So, any positively weighted barycentric combination makes sense for a pair of points sufficiently close. When $x \in \hat{W}_{i,i}^s$, we have $\hat{q}(x) = x$. Then, by shrinking the tube \hat{N}_i^s once more if necessary we make \hat{q} be a fibration whose fibres are transverse to the lamination \hat{L}_i^s and we make each leaf of $\hat{F}_{j,i}^u$, $j > i$, in every box B_ℓ^k be contained in a fibre of \hat{q} . Henceforth, taking the preimage of that tube (and its fibration) by p_i and adding the unstable manifold W_i^u provide the requested U_i^s and its foliation F_i^u satisfying the required properties. Thus, the induction is proved. \diamond

We also have the following statement.

Lemma 3.6 *There exist f -invariant neighborhoods U_0^u, \dots, U_n^u of the sets $\Sigma_0, \dots, \Sigma_n$ respectively, equipped with one-dimensional f -invariant foliations F_0^s, \dots, F_n^s of class $C^{1,0}$ such that the following properties hold for each $i \in \{0, \dots, n\}$:*

(iii) *the stable manifold W_i^s is a leaf of the foliation F_i^s and each leaf of the foliation F_i^s is transverse to L_i^u ;*

(iv) *for any $0 \leq j < i$ and $x \in U_i^u \cap U_j^u$, we have the inclusion $(F_{j,x}^s \cap U_i^u) \subset F_{i,x}^s$.*

Proof: The proof is done by an increasing induction from $i = 0$; it is skipped due to similarity to the previous one. \diamond

Before entering Step 2, we recall the definition of fundamental domain for a free action.

Definition 3.7 Let $g : X \rightarrow X$ be a homeomorphism acting freely on X . A closed subset $D \subset X$ is said to be a fundamental domain for the action of g if the following properties hold:

1. D is the closure of its interior $\overset{\circ}{D}$;
2. $g^k(\overset{\circ}{D}) \cap D = \emptyset$ for every integer $k \neq 0$;
3. X is the union $\cup_{k \in \mathbb{Z}} g^k(D)$.

Step 2. We prove the following statement for each $i = 0, \dots, n$.

Lemma 3.8 (v) *There exists an f -invariant neighborhood \tilde{N}_i of the set Σ_i contained in $U_i^s \cap U_i^u$ and such that the restrictions of the foliations F_i^u and F_i^s to \tilde{N}_i are transverse.*

Proof: For this aim, let us choose a fundamental domain K_i^s of the restriction of f to $W_i^s \setminus \Sigma_i$ and take a tubular neighborhood $N(K_i^s)$ of K_i^s whose disc fibres are contained in leaves of F_i^u . By construction, F_i^u is transverse to W_i^s and, according to the Lemma 3.6, F_i^s is a $C^{1,0}$ -foliation. Therefore, if the tube $N(K_i^s)$ is small enough, F_i^u is transverse to F_i^s in $N(K_i^s)$. Set

$$\tilde{N}_i := W_i^u \bigcup_{k \in \mathbb{Z}} f^k(N(K_i^s)).$$

This is a neighborhood of Σ_i ; it satisfies condition (v) and the previous properties (i)–(iv) still hold. A priori the boundary of \tilde{N}_i is only piecewise smooth; but, by choosing $N(K_i^s)$ correctly at its corners we may arrange that $\partial\tilde{N}_i$ be smooth. \diamond

Step 3. For proving Theorem 2 it remains to show the existence of linearizable neighborhoods $N_i \subset \tilde{N}_i$, $i = 0, \dots, n$, for which the required foliations are the restriction to N_i of the foliations F_i^u and F_i^s . For each orbit of f in Σ_i , choose one p . Let \tilde{N}_p be a connected component of \tilde{N}_i containing p . There is a homeomorphism $\varphi_p^u : W_p^u \rightarrow W_O^u$ (resp. $\varphi_p^s : W_p^s \rightarrow W_O^s$) conjugating the diffeomorphisms $f^{per(p)}|_{W_p^u}$ and $\mathcal{E}|_{W_O^u}$ (resp. $f^{per(p)}|_{W_p^s}$ and $\mathcal{E}|_{W_O^s}$). In addition, for any point $z \in \tilde{N}_p$ there is unique pair of points $z_s \in W_p^s$, $z_u \in W_p^u$ such that $z = F_{i,z_u}^s \cap F_{i,z_s}^u$. We define a topological embedding $\tilde{\mu}_p : \tilde{N}_p \rightarrow \mathbb{R}^3$ by the formula $\tilde{\mu}_p(z) = (x_1, x_2, x_3)$ where $(x_1, x_2) = \varphi_p^u(z_u)$ and $x_3 = \varphi_p^s(z_s)$. Since the foliations F_i^u and F_i^s are f -invariant, this definition makes $\tilde{\mu}_p$ conjugate the restriction $f^{per(p)}|_{\tilde{N}_p}$ to $\mathcal{E}^{per(p)}$. For $k = 1, \dots, per(p) - 1$, set $\tilde{N}_{f^k(p)} := f^k(\tilde{N}_p)$ and define $\tilde{\mu}_{f^k(p)}$ so that the equivariance formula holds: $\tilde{\mu}_{f^k(p)}(f^k(x)) = a^k \tilde{\mu}_p(x)$ for every $x \in \tilde{N}_p$. Choose $t_0 \in (0, 1]$ such that $\mathcal{N}^{t_0} \subset \tilde{\mu}_p(\tilde{N}_p)$ for every $p \in \Sigma_i$. Observe that $\mathcal{E}|_{\mathcal{N}^{t_0}}$ is conjugate to $\mathcal{E}|_{\mathcal{N}}$ by the suitable homothety h . Set $N_p = \tilde{\mu}_p^{-1}(\mathcal{N}^{t_0})$ and $\mu_p = h\tilde{\mu}_p : N_p \rightarrow \mathcal{N}$. Then, N_p is the requested neighborhood with its linearizing homeomorphism μ_p . This finishes the proof of Theorem 2. \diamond

4 Proof of the classification theorem

Let us prove that the diffeomorphisms f and f' in $G(M)$ are topologically conjugate if and only if there is a homeomorphism $\hat{\varphi} : \hat{V}_f \rightarrow \hat{V}_{f'}$ such that

- (1) $\eta_f = \eta_{f'} \hat{\varphi}_*$;
- (2) $\hat{\varphi}(\hat{\Gamma}_f^s) = \hat{\Gamma}_{f'}^s$ and $\hat{\varphi}(\hat{\Gamma}_f^u) = \hat{\Gamma}_{f'}^u$.

4.1 Necessity

Let $f : M \rightarrow M$ and $f' : M \rightarrow M$ be two elements in $G(M)$ which are topologically conjugated by some homeomorphism $h : M \rightarrow M$. Then h conjugates the invariant manifolds of periodic points of f and f' . More precisely, if p is a periodic point of f , then $h(p)$ is a periodic point of f' and $h(W^u(p)) = W^u(h(p))$, $h(W^s(p)) = W^s(h(p))$. In particular, h maps V_f to $V_{f'}$ by a homeomorphism noted φ . Moreover, if x is any points of V_f , for every $n \in \mathbb{Z}$ the following holds:

$$\varphi(f^n(x)) = f'^n(\varphi(x)).$$

This formula says exactly that φ is the lift of a map $\hat{\varphi} : \hat{V}_f \rightarrow \hat{V}_{f'}$. By construction of η_f , the same formula says that $\eta_f = \eta_{f'} \circ \hat{\varphi}_*$, where $\hat{\varphi}_* : H_1(\hat{V}_f; \mathbb{Z}) \rightarrow H_1(\hat{V}_{f'}; \mathbb{Z})$ denotes the map induced in homology. By definition of the quotient topology, $\hat{\varphi}$ is continuous. Since the same holds for φ^{-1} , one checks that $\hat{\varphi}$ is a homeomorphism. As φ conjugates the laminations Γ_f^s (resp. Γ_f^u) to $\Gamma_{f'}^s$ (resp. $\Gamma_{f'}^u$), the same holds for $\hat{\varphi}$ in the quotient spaces with respect the projections of the laminations.

4.2 Sufficiency

For proving the sufficiency of the conditions in Theorem 1, let us consider a homeomorphism $\hat{\varphi} : \hat{V}_f \rightarrow \hat{V}_{f'}$ such that:

- (1) $\eta_f = \eta_{f'} \hat{\varphi}_*$;
- (2) $\hat{\varphi}(\hat{\Gamma}_f^s) = \hat{\Gamma}_{f'}^s$ and $\hat{\varphi}(\hat{\Gamma}_f^u) = \hat{\Gamma}_{f'}^u$.

From now on, the dynamical objects attached to f' will be denoted by $L'^u, L'^s, \Sigma'_i, \dots$ with the same meaning as $L^u, L^s, \Sigma_i, \dots$ have with respect to f . By (1), $\hat{\varphi}$ lifts to an *equivariant* homeomorphism $\varphi : V_f \rightarrow V_{f'}$, that is: $f'|_{V_{f'}} = \varphi f \varphi^{-1}|_{V_f}$ (for brevity, equivariance stands for (f, f') -equivariance). By (2), φ maps Γ_f^u to $\Gamma_{f'}^u$ and Γ_f^s to $\Gamma_{f'}^s$. Thanks to Theorem 2 we may use compatible linearizable neighborhoods of the saddle points of f (resp. f').

An idea of the proof is the following: we modify the homeomorphism φ in a neighborhood of Γ_f^u such that the final homeomorphism preserves the compatible foliations, then we do similar modification near Γ_f^s . So we get a homeomorphism $h : M \setminus (\Omega_0 \cup \Omega_3) \rightarrow M \setminus (\Omega'_0 \cup \Omega'_3)$ conjugating $f|_{M \setminus (\Omega_0 \cup \Omega_3)}$ with $f'|_{M \setminus (\Omega'_0 \cup \Omega'_3)}$. Notice that $M \setminus (W_{\Omega_1}^s \cup W_{\Omega_2}^s \cup \Omega_3) = W_{\Omega_0}^s$ and $M \setminus (W_{\Omega'_1}^s \cup W_{\Omega'_2}^s \cup \Omega'_3) = W_{\Omega'_0}^s$. Since $h(W_{\Omega_1}^s) = W_{\Omega'_1}^s$ and $h(W_{\Omega_2}^s) = W_{\Omega'_2}^s$ then $h(W_{\Omega_0}^s \setminus \Omega_0) = W_{\Omega'_0}^s \setminus \Omega'_0$. Thus for each connected component A of $W_{\Omega_0}^s \setminus \Omega_0$ there is a sink $\omega \in \Omega_0$ such that $A = W_{\omega}^s \setminus \omega$. Similarly $h(A)$ is a connected component of $W_{\Omega'_0}^s \setminus \Omega'_0$ such that $h(A) = W_{\omega'}^s \setminus \omega'$ for a sink $\omega' \in \Omega'_0$. Then we can continuously extend h to Ω_0 assuming $h(\omega) = \omega'$ for every $\omega \in \Omega_0$. A similar extension of h to Ω_3 finishes the proof. Thus below in a sequence of lemmas we explain only how to modify the homeomorphism φ in a neighborhood of Γ_f^u such that the final homeomorphism preserves the compatible foliations.

Recall the partition $\Sigma_0 \sqcup \dots \sqcup \Sigma_n$ associated with the Smale order on the periodic points of index 2.

Lemma 4.1 *For every $i = 0, \dots, n$ the following equality holds $\varphi(W_i^u \cap V_f) = W_i^{u'} \cap V_{f'}$ and there is a unique continuous extension of $\varphi|_{W_i^u \cap V_f}$ to Σ_i which is equivariant and bijective from Σ_i to Σ_i' .*

Proof: Let $p \in \Sigma_0$. Denote its orbit by $orb_f(p)$. The punctured unstable manifold $W^u(p) \setminus \{p\}$ projects by p_f to one compact leaf $\ell(p)$. Both sides of the next equality are f -invariant and project to the same leaf, thus:

$$p_f^{-1}(\ell(p)) = W^u(orb_f(p)) \setminus \{orb_f(p)\}.$$

Then, the number of connected components of $p_f^{-1}(\ell(p))$ is $per(p)$, the period of p . The image $\hat{\varphi}(\ell(p))$ is a compact leaf of $\hat{\Gamma}_{f'}^u$. By the previous argument, it is $\ell'(p')$ for some $p' \in \Sigma_0'$. Since $\hat{\varphi}$ lifts to φ , then $\varphi[p_f^{-1}(\ell(p))] = p_{f'}^{-1}(\ell'(p'))$ which implies the equality of the number of connected components. Thus $per(p) = per(p')$. From this, we can deduce that, up to replacing p' with $f'^k(p')$ for some integer k , we have $\varphi(W^u(p) \setminus \{p\}) = W^u(p') \setminus \{p'\}$. Using the property $p = \lim_{n \rightarrow -\infty} f^n(x)$ for every $x \in W^u(p)$ and the similar property for p' in addition to the equivariance of φ , one extends continuously $\varphi|_{W_p^u}$ by defining $\varphi(p) = p'$. Doing the same for every orbit of Σ_0 , we get a continuous extension of $\varphi|_{W_0^u}$ to Σ_0 which is still equivariant. One easily checks that this extension is continuous, unique, and hence equivariant. Then, arguing similarly with $\hat{\varphi}^{-1}$, we derive that the extension of φ maps Σ_0 bijectively onto Σ_0' .

Denote $\ell_0 := \bigcup_{p \in \Sigma_0} \ell(p)$. We have $\hat{\varphi}(\ell_0) = \ell_0'$. Let now $p \in \Sigma_1$. The closure in \hat{V}_f of $\ell(p) := p_f(W^u(p) \setminus \{p\})$ is contained in $\ell(p) \cup \ell_0$. We deduce that $\hat{\varphi}(\ell(p))$ is a leaf of $\hat{\Gamma}_{f'}^u$ of the form $\ell'(p')$ for some $p' \in \Sigma_1'$ and we can continue inductively. Thus, there is a continuous extension of $\varphi|_{W_i^u}$ to every Σ_i for $i = 0, 1, \dots, n$ which is a bijection $\Sigma_i \rightarrow \Sigma_i'$. Arguing with $\hat{\varphi}^{-1}$, we derive that $n' = n$. \diamond

Recall the radial functions $r_i^u, r_i^s : N_i \rightarrow [0, +\infty)$ which are introduced above Definition 3.3; recall also the order which is defined by r_i^s on each stable separatrix γ_p of $p \in \Sigma_i$. Analogous functions are associated with the dynamics of f' .

Lemma 4.2 *There is a unique continuous extension of $\varphi|_{\Gamma_f^u}$*

$$\varphi^{us} : \Gamma_f^u \cup (L^u \cap L^s) \longrightarrow \Gamma_{f'}^u \cup (L'^u \cap L'^s)$$

such that the following holds:

- (1) *If $x \in W_j^u \cap W_i^s$, $j > i$, then $\varphi^{us}(x) \in W_j'^u \cap W_i'^s$.*
- (2) *If x and y lie in $\gamma_p \cap L^u$ with $r_p^s(x) < r_p^s(y)$, then $\varphi^{us}(x)$ and $\varphi^{us}(y)$ lie in $\gamma_{\varphi(p)}' \cap L'^u$ with $r_{\varphi(p)}'^s(\varphi^{us}(x)) < r_{\varphi(p)}'^s(\varphi^{us}(y))$.*

Notice that $\varphi|_{\Gamma_f^u}$ being equivariant, its continuous extension is also equivariant.

Proof: This statement is proved by induction on i . We recall that $V_i \setminus L_i^s = V_f \setminus cl(W_i^u)$ is a dense open set in V_f (and similarly with $'$), and according to Lemma 4.1, φ maps $V_i \setminus L_i^s$ to $V_i' \setminus L_i'^s$ homeomorphically and conjugates f to f' . Thus, for every $i = 0, \dots, n$, we have an equivariant homeomorphism $\varphi_i : V_i \setminus L_i^s \rightarrow V_i' \setminus L_i'^s$ which maps $W_j^u \setminus L_i^s$ to $W_j'^u \setminus L_i'^s$ for every $j > i$, again as a consequence of Lemma 4.1.

First, take $i = 0$. The manifold \hat{V}_0 is closed and three-dimensional. We have $\hat{L}_0^s = \hat{W}_{0,0}^s$, which consists of finite number disjoint smooth circles, and similarly with $'$.

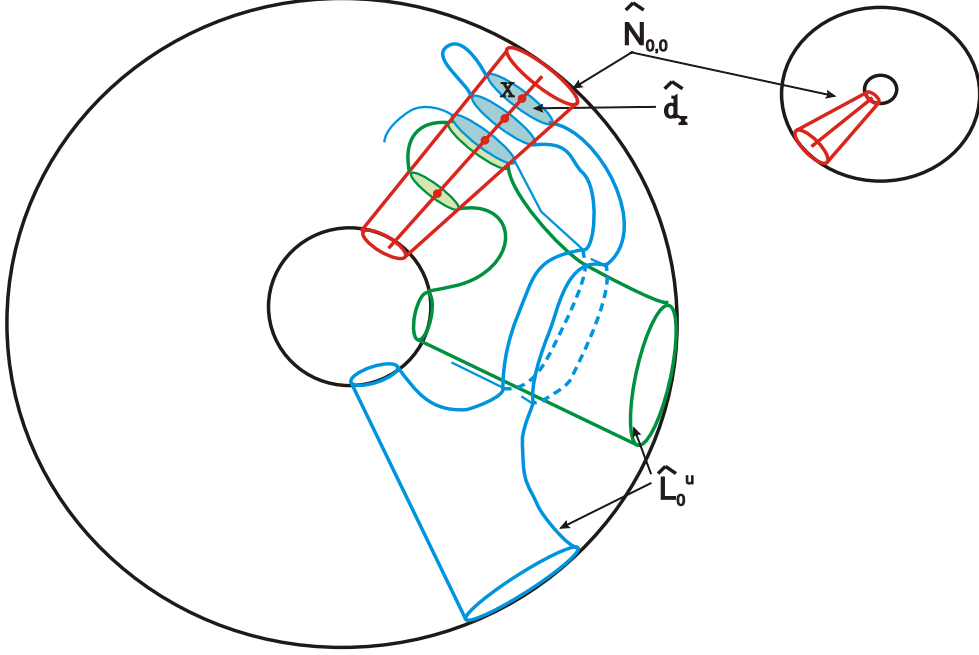

Figure 5: Case $i = 0$ in proof of Lemma 4.2 for the diffeomorphism from Figure 3.

We look for an extension $\hat{\varphi}_0^{us}$ of $\hat{\varphi}_0|_{\hat{L}_0^u}$ to $\hat{L}_0^s \cap \hat{L}_0^u$. If N_0 is the neighborhood of Σ_0 extracted from a compatible system given by Theorem 2 and if $\hat{N}_{0,0}$ denotes the corresponding tubular neighborhood of \hat{L}_0^s in \hat{V}_0 , the trace of \hat{L}_0^u in that tube is a lamination by disks:

$$\hat{L}_0^u \cap \hat{N}_{0,0} = \{\hat{d}_x \mid x \in \hat{L}_0^u \cap \hat{L}_0^s\},$$

where \hat{d}_x denotes the fiber of the tube over $x \in \hat{L}_0^s$ (see figure 5).

The complement in \hat{V}_0' of the interior of $\hat{N}'_{0,0}$ is a compact set contained in $\hat{V}_0' \setminus \hat{L}_0'^s$. Then its preimage K by the homeomorphism $\hat{\varphi}_0$ is a compact set contained in $\hat{V}_0 \setminus \hat{L}_0^s$. When $t = 0$, we have $\hat{N}_{0,0}^t = \hat{L}_0^s$ and hence disjoint from K . Then, if t is small enough, $\hat{\varphi}_0(\hat{N}_{0,0}^t \setminus \hat{L}_0^s) \subset \hat{N}'_{0,0} \setminus \hat{L}_0'^s$. Finally, the map $\hat{\varphi}_0$ (which is not defined on \hat{L}_0^s) possesses the two following properties:

1. If N_0 is shrunk enough, we have $(\hat{\varphi}_0(\hat{N}_{0,0}) \cap \hat{L}_0^u) \subset (\hat{N}'_{0,0} \cap \hat{L}_0'^u)$, where $\hat{N}'_{0,0}$ denotes the tube associated with the chosen linearizable neighborhood N'_0 of Σ'_0 .

2. If \hat{d}_x is a plaque of $\hat{L}_0^u \cap \hat{N}_{0,0}$, the image $\hat{\varphi}_0(\hat{d}_x \setminus \{x\})$ is contained in some fiber $\hat{d}_{x'}$, with $x' \in \hat{L}_0'^u \cap L_0'^s$.

As a consequence, the requested extension may be defined by $\hat{\varphi}_0^{us}(x) = x'$. As the considered plaques are arcwise connected, the construction lifts to the cover and yields a continuous map $\varphi_0^{us} : \Gamma_f^u \cup (L_0^s \cap L_0^u) \rightarrow \Gamma_{f'}^u \cup (L_0'^s \cap L_0'^u)$ which is a continuous equivariant extension of $\varphi|_{\Gamma_f^u}$.

It remains to prove that φ_0^{us} is increasing on its domain in each separatrix of Σ_0 . For this aim, consider a point $p \in \Sigma_0$, one of its separatrices γ_p and a connected component N_{γ_p} of $N_p \setminus W_p^u$ containing γ_p . Take an infinite proper arc C in $N_{\gamma_p} \setminus W_p^s$ which crosses transversely each leaf of the foliation F_0^u and which has one end in p . We orient C so that its projection onto γ_p is positive. Its image through φ_0 is a proper arc C' contained in $N'_{\varphi(p)} \setminus W'_{\varphi(p)}{}^u$. Moreover, $\varphi(p)$ is one end of C' . For $x, y \in \gamma_p \cap L^u$, the inequality $r_p^s(x) < r_p^s(y)$ implies $r'_{\varphi(p)}{}^s(\varphi_0^{us}(x)) < r'_{\varphi(p)}{}^s(\varphi_0^{us}(y))$ if we are sure that C' intersects each leaf of $L_0'^u \cap N'_{\varphi(p)}$ at most in one point. That is true since φ_0 is a homeomorphism on its image from $N_0 \setminus W_0^s$ to $N'_0 \setminus W_0'^s$ mapping L_0^u into $L_0'^u$.

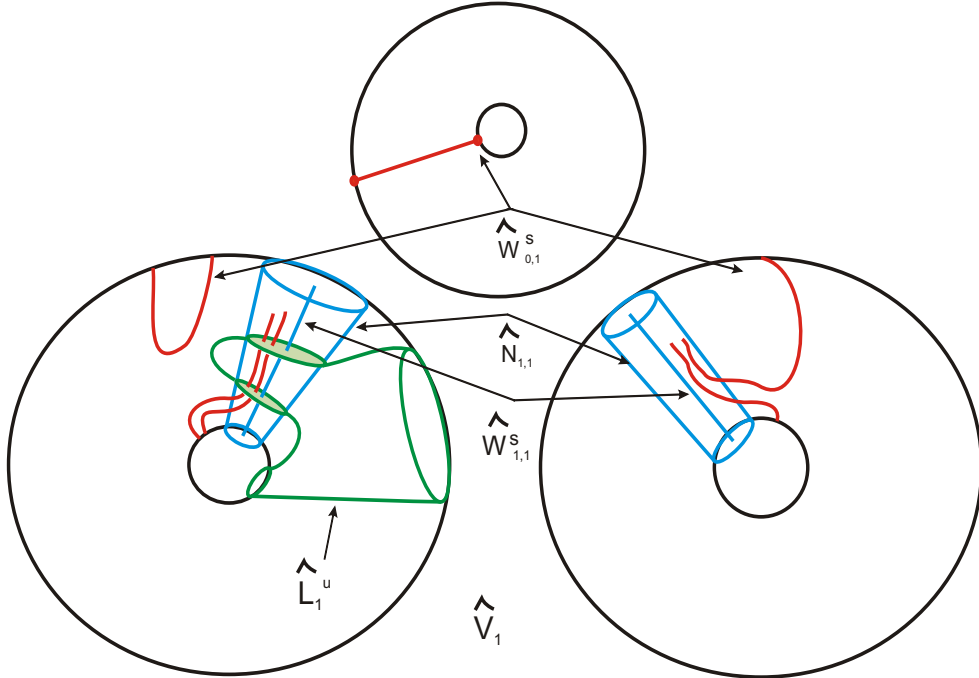

Figure 6: Illustration of induction in Lemma 4.2 for the diffeomorphism from Figure 3.

For the induction, let $i \in \{1, \dots, n\}$ and let us assume that there is a continuous extension

$$\varphi_{i-1}^{us} : \Gamma_f^u \cup \bigcup_{j=0}^{i-1} (L_j^s \cap L_j^u) \rightarrow \Gamma_{f'}^u \cup \bigcup_{j=0}^{i-1} (L_j'^s \cap L_j'^u),$$

which is monotone on each separatrix of Σ_j , $j < i$. The image $\hat{W}_{i,i}^s$ of W_i^s by the projection $p_i : V_i \rightarrow \hat{V}_i$ is made of finitely many disjoint circles which are the images of the stable separatrices

of Σ_i . About $\hat{W}_{i,i}^s$, there is a tube $\hat{N}_{i,i}$ which is the projection by p_i of a neighborhood N_i of Σ_i extracted from a compatible system given by Theorem 2 (see Figure 6). The trace of \hat{L}_i^u in that tube is a lamination by disks:

$$\hat{L}_i^u \cap \hat{N}_{i,i} = \{\hat{d}_x \mid x \in \hat{L}_i^u \cap \hat{W}_{i,i}^s\},$$

where \hat{d}_x denotes the fiber of the tube over $x \in \hat{W}_{i,i}^s$.

In V_i , there are two laminations L_i^u and L_i^s (and the corresponding objects with $'$). The map φ_i , not defined on L_i^s , sends $L_i^u \setminus L_i^s$ homeomorphically onto $L_i'^u \setminus L_i'^s$. By the induction hypothesis, the restriction $\varphi_i|_{(L_i^u \setminus L_i^s)}$ extends continuously to $L_i^u \setminus W_i^s$; this extension, automatically equivariant, is denoted by ψ_i . This induces on the quotient space \hat{V}_i a homeomorphism

$$\hat{\psi}_i : \hat{L}_i^u \setminus \hat{W}_{i,i}^s \rightarrow \hat{L}_i'^u \setminus \hat{W}_{i,i}'^s.$$

In order to extend $\hat{\psi}_i$ to $\hat{L}_i^u \cap \hat{L}_i^s$, we use the fact that \hat{L}_i^u is compact for arguing as in the case $i = 0$. Consider the tube $\hat{N}_{i,i}^t$ depending on $t \in (0, 1)$ and look at its compact lamination by disks $\hat{L}_i^u \cap \hat{N}_{i,i}^t$. After removing $\hat{W}_{i,i}^s$ which marks one puncture on each leaf, it is leaf-wise mapped by $\hat{\psi}_i$ into $\hat{V}_i' \setminus \hat{W}_{i,i}'^s$. As in case $i = 0$, the above-mentioned compactness allows us to conclude that there exists some $t \in (0, 1)$ such that $\hat{L}_i^u \cap (\hat{N}_{i,i}^t \setminus \hat{W}_{i,i}^s)$ is mapped into $\hat{N}_{i,i}'^t$ where $\hat{N}_{i,i}'^t$ denotes the tube associated with the chosen linearizable neighborhood N_i' of Σ_i' . Finally, the map $\hat{\psi}_i$ possesses the two following properties:

1. If N_i is shrunk enough, we have $(\hat{\psi}_i(\hat{N}_{i,i}) \cap \hat{L}_i^u) \subset (\hat{N}_{i,i}' \cap \hat{L}_i'^u)$.
2. If \hat{d}_x is a plaque of $\hat{L}_i^u \cap \hat{N}_{i,i}$, the image $\hat{\psi}_i(\hat{d}_x \setminus \{x\})$ is contained in some fiber $\hat{d}_{x'}$, with $x' \in \hat{L}_i'^u \cap \hat{W}_{i,i}'^s$.

Now, the extension $\hat{\varphi}_i^{us}$ of $\hat{\psi}_i$ is defined by $x \mapsto x'$. One checks it is a continuous extension. The requested φ_i^{us} is the lift of $\hat{\varphi}_i^{us}$ to V_i . It has the required properties allowing us to finish the induction. \diamond

Remark 4.3 Due to Lemma 3.2 we may assume that in all lemmas below the chosen values $t = \beta_i, a_i, \dots$ are such that the boundary of the linearizable neighborhood N_i^t does not contain any heteroclinic point.

Lemma 4.4 *There are numbers $\beta_0, \dots, \beta_n \in (0, 1)$ such that, for every $i \in \{0, \dots, n\}$, for every point $p \in \Sigma_i$ and $x \in N_p^{\beta_i} \cap L^u$, the following inequality holds:*

$$r_i'^u(\varphi^{us}(x_i^u)) r_i'^s(\varphi^{us}(x_i^s)) < \frac{1}{2}.$$

Proof: As $N_n \cap L^u = W_n^u$ and $\varphi^{us}(W_n^u) = W_n'^u$, it is possible to chose any $\beta_n \in (0, 1)$.

Indeed, for $p \in \Sigma_n$ and $x \in W_p^u$, we have $r_{\varphi(p)}^{/s}(\varphi^{us}(x_i^s)) = 0$. For $i \in \{0, \dots, n-1\}$ and $p \in \Sigma_i$, choose some heteroclinic point $y \in W_p^s \cap L^u$ arbitrarily. Set:

$$\lambda_p^{/u}(t) = \sup_x \{r_{\varphi(p)}^{/u}(\varphi^{us}(x_i^u)) \mid x \in N_p^t \cap F_{i,y}^u\} \quad \text{and} \quad \lambda_p^{/s} = r_{\varphi(p)}^{/s}(\varphi^{us}(y)).$$

When t goes to 0, the arc $N_p^t \cap F_{i,y}^u$ shrinks to the point y . Then, according to Lemma 4.2, $\lambda_p^{/u}(t)$ also goes to 0. Therefore, there exists some $\beta_p \in (0, 1)$ such that $\lambda_p^{/u}(\beta_p)\lambda_p^{/s} < \frac{1}{8}$. Denote by Q_p the compact subset of M bounded by $\partial N_p^{\beta_p}, F_{i,y}^u$ and $f^{per(p)}(F_{i,y}^u)$. Notice that Q_p is a fundamental domain for the restriction of $f^{per(p)}$ to the connected component of $N_p^{\beta_p} \setminus W_p^u$ containing y . For every $x \in Q_p$, we have $r_{\varphi(p)}^{/u}(\varphi^{us}(x_i^u)) \leq 4\lambda_p^{/u}(\beta_p)$ and $r_{\varphi(p)}^{/s}(\varphi^{us}(x_i^s)) \leq \lambda_p^{/s}$. Then, for every $x \in Q_p \cap L^u$ we have:

$$r_p^{/u}(\varphi^{us}(x_i^u)) r_p^{/s}(\varphi^{us}(x_i^s)) \leq 4\lambda_p^{/u}(\beta_p) \lambda_p^{/s} < \frac{1}{2}.$$

Set $\beta_i = \min_{p \in \Sigma_i} \{\beta_p\}$. Hence, β_i is the required number. \diamond

Lemma 4.5 *When $n > 0$, there exist real numbers $a_j \in (0, \beta_j]$ fulfilling the following property: for every $j = 1, \dots, n$ and every integer $i < j$, each connected component of $\hat{W}_{i,i}^s \cap \hat{N}_{j,i}^{a_j}$ is an open interval which is either disjoint from $A_j^i := \bigcup_{k=i+1}^{j-1} \hat{N}_{k,i}^{a_k}$ or included in A_j^i . Moreover, only finitely many of these intervals are not covered by A_j^i .*

Proof: The proof is done by induction on j from 1 to n . For $j = 1$, one is allowed to take $a_1 = \beta_1$. Indeed, $\hat{W}_{0,0}^s$ is a smooth curve and $\hat{W}_{1,0}^u$ is a smooth closed surface which is transverse to $\hat{W}_{0,0}^s$. Therefore, there are finitely many intersection points. By the choice of β_1 , the projection in \hat{V}_0 of $N_1^{a_1}$ is a tubular neighborhood of $\hat{W}_{1,0}^u$. Moreover, each component of $\hat{W}_{0,0}^s \cap \hat{N}_{1,0}^{a_1}$ is a fiber of this tube.

For the induction, assume the numbers a_1, \dots, a_{j-1} are given with the required properties and let us find a_j . In particular, the subset A_j^i is assumed to be defined. According to Remark 4.3, the boundary of A_j^i contains no heteroclinic point.

First, fix $i < j$. Consider the projection $\hat{W}_{j,i}^u$ of W_j^u in \hat{V}_i . This is a union of leaves in the lamination \hat{L}_i^u . The following is a well-known fact (see, for example, Statement 1.1 in [12]): if x is a point from \hat{L}_i^u which is accumulated by a sequence of plaques from $\hat{W}_{j,i}^u$, then x does not lie in $\hat{W}_{j,i}^u$ but belongs to some $\hat{W}_{k,i}^u$ with $k < j$. Then the part of $\hat{W}_{j,i}^u$ which is covered by A_j^i contains every intersection points $\hat{W}_{i,i}^s \cap \hat{W}_{j,i}^u$ except finitely many of them. From this finiteness and the fact that $A_j^i \cap \hat{W}_{i,i}^s \cap \hat{W}_{j,i}^u$ is actually contained in A_j^i , an easy compactness argument allows us to find a positive number a_j^i such that the collection of disjoint intervals made by $\hat{W}_{i,i}^s \cap \hat{N}_{j,i}^{a_j^i}$ fulfills the requested property with respect to the considered i . Indeed, let $B(t)$ be the closure of $\partial A_j^i \cap \hat{W}_{i,i}^s \cap \hat{N}_{j,i}^t$. The intersection $\bigcap_{k \in \mathbb{N}} B(\frac{1}{k})$ is empty. Then $B(t)$ is empty when t is small enough.

By defining $a_j := \inf\{a_j^0, \dots, a_j^{j-1}\}$, we are sure that $\hat{N}_j^{a_j}$ satisfies all the requested properties. \diamond

The corollary below follows from Lemma 4.5 immediately.

Corollary 4.6 *For each $i \in \{0, \dots, n-1\}$ the intersection $\hat{W}_{i,i}^s \cap (\bigcup_{j=i+1}^n \hat{N}_{j,i}^{a_j})$ consists of finitely many open arcs $\hat{I}_1^i, \dots, \hat{I}_{r_i}^i$ such that, for each $l = 1, \dots, r_i$, the arc \hat{I}_l^i is a connected component of $\hat{W}_{i,i}^s \cap \hat{N}_{j,i}^{a_j}$ for some $j > i$.*

For brevity, for $i = 0, \dots, n$, we denote by φ_i^u the restriction $\varphi^{us}|_{W_i^u}$ in the rest of the proof of Theorem 1. Let $\psi_i^s : W_i^s \rightarrow W_i'^s$ be any equivariant homeomorphism which extends $\varphi^{us}|_{W_i^s \cap L^u}$ and let $t_i \in (0, 1)$ be a small enough number so that, for every $x \in N_i^{t_i}$, the next inequality holds:

$$(*)_i \quad r'^s(\varphi_i^u(x_i^u)) r'^u(\psi_i^s(x_i^s)) < 1.$$

In this setting, one derives an equivariant embedding $\phi_{\varphi_i^u, \psi_i^s} : N_i^{t_i} \rightarrow N_i'$ which is defined by sending $x \in N_i^{t_i}$ to $(\varphi_i^u(x_i^u), \psi_i^s(x_i^s))$.

Lemma 4.7 *There is an equivariant homeomorphism $\psi^s : L^s \rightarrow L'^s$ consisting of conjugating homeomorphisms $\psi_0^s : W_0^s \rightarrow W_0'^s, \dots, \psi_n^s : W_n^s \rightarrow W_n'^s$ such that for each $i \in \{0, \dots, n\}$:*

- (1) $\psi_i^s|_{W_i^s \cap L^u} = \varphi_i^u|_{W_i^s \cap L^u}$;
- (2) the topological embedding $\phi_{\varphi_i^u, \psi_i^s}$ is well-defined on $N_i^{a_i}$;
- (3) if $x \in (W_i^s \cap N_j^{a_j})$, $j > i$, then $\psi_i^s(x) = \phi_{\varphi_j^u, \psi_j^s}(x)$.

Proof: We are going to construct ψ_i^s by a decreasing induction on i from $i = n$ to $i = 0$. The stable manifolds of the saddles in Σ_n have no heteroclinic points. Therefore, the only constraints on ψ_n^s imposed by the first item is its value on Σ_n . In particular, we are allowed to change ψ_n^s to $f^k \circ \psi_n^s$ if k is *admissible* in the sense that k is a multiple of all periods $per(p)$, $p \in \Sigma_n$.

This remark is used in the following way. One starts with any equivariant homeomorphism ψ_n^s such that for any $p \in \Sigma_n$ the stable manifold W_p^s is mapped to the stable manifold of $\varphi_n^u(p)$; hence, item 1 is fulfilled. Choose a fundamental domain I of $f|_{W_n^s \setminus \Sigma_n}$. Consider the fundamental domain of $f|_{N_n^{a_n} \setminus W_n^u}$ defined by $N_I := \{x \in N_n^{a_n} \mid x_n^s \in I\}$; set $\lambda_n'^u := \sup\{r'^u(\varphi_n^u(x_n^u)) \mid x \in N_I\}$ and $\lambda_n'^s := \sup\{r'^s(\psi_n^s(x_n^s)) \mid x \in N_I\}$. If the product $\lambda_n'^u \lambda_n'^s$ is less than 1, the inequality $(*)_n$ is fulfilled by the pair (φ_n^u, ψ_n^s) and hence, the embedding $\phi_{\varphi_n^u, \psi_n^s}$ is well-defined on $N_n^{a_n}$.

If not, we replace ψ_n^s with $f^k \circ \psi_n^s$ with k admissible and large enough. Indeed, the effect of this change is to multiply $\lambda_n'^s$ by some positive factor bounded by $(\frac{1}{4})^k$ while $\lambda_n'^u$ is kept fixed and hence, $(*)_n$ becomes fulfilled when k is large enough. Since the third item is empty for $i = n$, we have built some ψ_n^s as desired.

For the induction, let us build ψ_i^s , $i < n$, with the required properties assuming that the homeomorphisms $\psi_n^s, \dots, \psi_{i+1}^s$ have already been built. The stable manifolds of saddles in Σ_i have heteroclinic intersections with unstable manifolds of saddles in Σ_j with $j > i$ only. The

image $\widehat{W}_{i,i}^s$ of W_i^s under $p_i : V_i \rightarrow \widehat{V}_i$ is a closed smooth 1-dimensional submanifold. According to Corollary 4.6, the intersection $\widehat{W}_{i,i}^s \cap (\bigcup_{j=i+1}^n \widehat{N}_j^{a_j})$ consists of finitely many open arcs $\widehat{I}_1^i, \dots, \widehat{I}_{r_i}^i$ such that \widehat{I}_l^i for each $l = 1, \dots, r_i$ is a connected component of $\widehat{W}_{i,i}^s \cap \widehat{N}_{j,i}^{a_j}$ for some $j > i$.

In order to satisfy the third item of the statement, ψ_i^s is defined on $p_i^{-1}(\widehat{I}_l^i)$ in an equivariant way. Denote by $\psi_{i,l}^s$ this partial definition of ψ_i^s ; its image is contained in $W_{i,i}^s$.

More precisely, if $I_{l,\alpha}^i$ is a connected component of $p_i^{-1}(\widehat{I}_l^i)$ it is a proper arc in some $N_i^{a_j}$ and it intersects W_j^u in a unique point $x_{l,\alpha}^i$. Set $x_{l,\alpha}^i = \varphi^{us}(x_{l,\alpha}^i)$ and denote $I_{l,\alpha}^i$ the connected component of $W_i^s \cap N_j^u$ passing through the point $x_{l,\alpha}^i$. Then, the restriction of $\psi_{i,l}^s$ to the arc $I_{l,\alpha}^i$ reads:

$$\psi_{i,l,\alpha}^s = \phi_{\varphi_j^u, \psi_j^s}|_{I_{l,\alpha}^i} : I_{l,\alpha}^i \rightarrow I_{l,\alpha}^i.$$

By Lemma 4.2, the map φ^{us} sends $W_i^s \cap L^u$ to $W_i^s \cap L'^u$ preserving the order on each separatrix of $W_i^s \setminus \Sigma_i$ and $W_i^s \setminus \Sigma'_i$. On the other hand, $\psi_{i,l,\alpha}^s$ is also order preserving. Both together imply that $\psi_{i,l}^s$ is order preserving since we know that it is an injective map. Moreover, the union of all $\psi_{i,l}^s$ – which makes sense as their respective domains are mutually disjoint – is order preserving. Therefore, there is an equivariant homeomorphism $\psi_i^s : W_i^s \setminus \Sigma_i \rightarrow W_i^s \setminus \Sigma_i$ which extends all $\psi_{i,l}^s$.

Since φ^{us} is continuous, the above homeomorphism extends continuously to $\psi_i^s : W_i^s \rightarrow W_i^s$. At this point of the construction items 1 and 3 of the statement are satisfied. The condition of item 2 follows from Lemma 4.4 for stable separatrices that contain heteroclinic points. If some stable separatrix has no heteroclinic points, one changes ψ_i^s to $f^{lk} \circ \psi_i^s$ on the separatrix where k is a large common multiple of the period of the separatrix, like to the construction made in the case $i = n$. \diamond

PROOF OF THEOREM 1 CONTINUED. Let us recall that we denoted by $\mathcal{E} : \mathbb{R}^3 \rightarrow \mathbb{R}^3$ the canonical linear diffeomorphism with the unique fixed point $O = (0, 0, 0)$ which is a saddle point whose unstable manifold is the plane Ox_1x_2 and stable manifold is the axis Ox_3 ; for simplicity, we assume that \mathcal{E} has a sign $\nu = +$ (see the beginning of Section 3). Let

$$N = \{(x_1, x_2, x_3) \in \mathbb{R}^3 : 0 \leq (x_1^2 + x_2^2)x_3 \leq 1\}.$$

Let $\rho > 0$, $\delta \in (0, \frac{\rho}{4})$ and

$$\begin{aligned} d &= \{(x_1, x_2, x_3) \in \mathbb{R}^3 : x_1^2 + x_2^2 \leq \rho^2, x_3 = 0\}, \\ U &= \{(x_1, x_2, x_3) \in \mathbb{R}^3 : (\rho - \delta)^2 \leq x_1^2 + x_2^2 \leq \rho^2, x_3 = 0\}, \\ c &= \{(x_1, x_2, x_3) \in \mathbb{R}^3 : x_1^2 + x_2^2 = \rho^2, x_3 = 0\}, \\ c^0 &= \{(x_1, x_2, x_3) \in \mathbb{R}^3 : x_1^2 + x_2^2 = (\rho - \frac{\delta}{2})^2, x_3 = 0\}, \\ c^1 &= \{(x_1, x_2, x_3) \in \mathbb{R}^3 : x_1^2 + x_2^2 = (\rho - \delta)^2, x_3 = 0\}. \end{aligned}$$

Let $K = d \setminus \text{int } \mathcal{E}^{-1}(d)$, $V = (K \cup \mathcal{E}(K)) \cap \{(x_1, x_2, x_3) \in \mathbb{R}^3 : x_1 \geq 0, x_3 = 0\}$ and $\beta = U \cap Ox_1^+$, where $Ox_1^+ = \{(x_1, x_2, x_3) \in \mathbb{R}^3 : x_3^2 + x_2^2 = 0, x_1 > 0\}$.

Choose a point $Z^0 = (0, 0, z^0) \in Ox_3^+$ such that $\rho^2 z^0 < \frac{1}{4}$ (see Figure 7). Then, choose a point $Z^1 = (0, 0, z^1)$ in Ox_3^+ so that $z^0 > z^1 > \frac{z^0}{4}$. Let $\Pi(z) = \{(x_1, x_2, x_3) \in \mathbb{R}^3 : x_3 = z\}$. In what follows, for every subset $A \subset Ox_1x_2$, we denote by \tilde{A} will denote the cylinder $\tilde{A} = A \times [0, z^0]$. Denote by \mathcal{W} the 3-ball bounded by the annulus \tilde{c} and the two planes $\Pi(z^0)$ and $\Pi(\frac{z^0}{4})$. Let Δ be a closed 3-ball bounded by the surface \tilde{c}^1 and the two planes Ox_1x_2 and $\Pi(z^1)$. Let

$$\mathcal{T} = \bigcup_{k \in \mathbb{Z}} \mathcal{E}^k(\tilde{d}) \quad \text{and} \quad \mathcal{H} = \bigcup_{k \in \mathbb{Z}} \mathcal{E}^k(\Delta).$$

Notice that the construction yields $\mathcal{H} \subset \text{int } \mathcal{T}$ and makes \mathcal{W} a fundamental domain for the action of \mathcal{E} on \mathcal{T} .

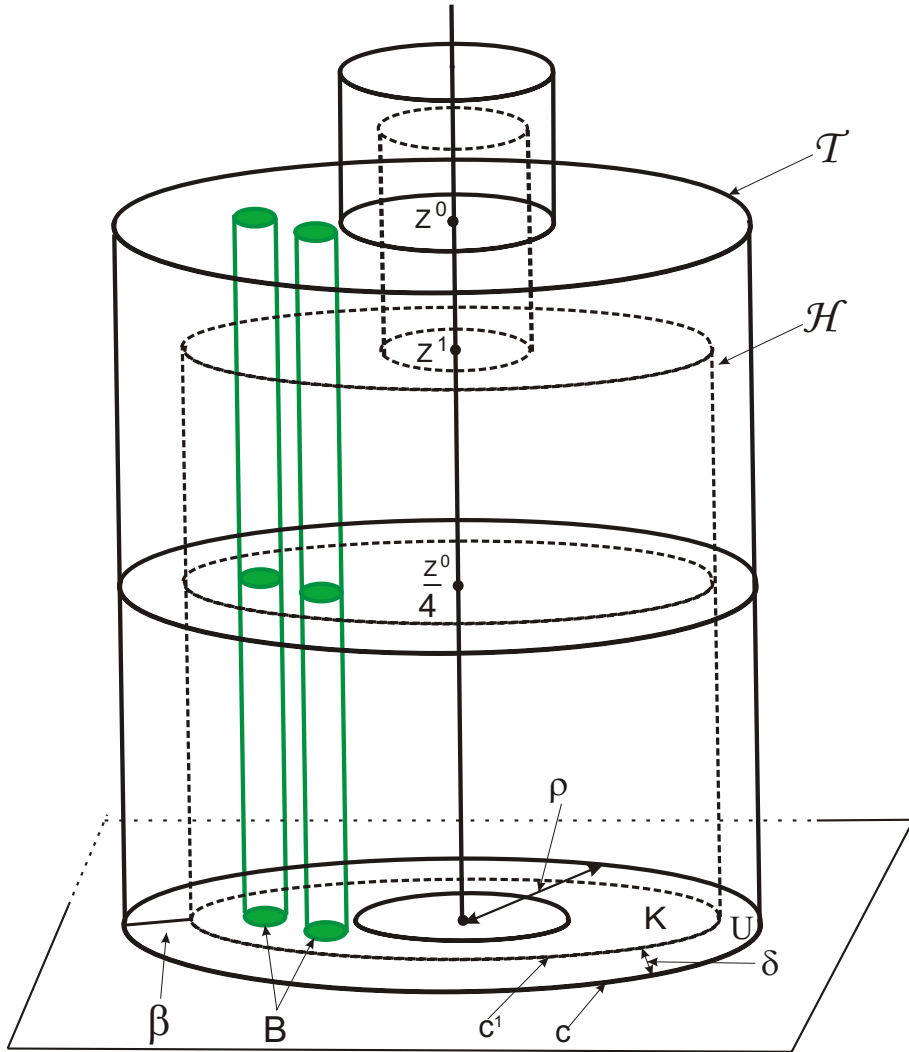

Figure 7: A linear model

Now, we come back to f and construct some neighborhoods $\mathcal{H}_\gamma \subset \mathcal{T}_\gamma$ around each separatrix γ which contains heteroclinic points. Therefore, we consider only the case $n \geq 1$ and separatrices

of the saddle points from Σ_i for $i \in \{0, \dots, n-1\}$, but not those from Σ_n since their one-dimensional separatrices do not contain heteroclinic points. Let G_i be the union of all stable separatrices of saddle points in Σ_i that contain heteroclinic points. Let $\check{G}_i \subset G_i$ be the union of separatrices in G_i such that $G_i = \bigcup_{\gamma \in \check{G}_i} \text{orb}(\gamma)$ and, for every pair (γ_1, γ_2) of distinct separatrices in \check{G}_i and every $k \in \mathbb{Z}$, one has $\gamma_2 \neq f^k(\gamma_1)$. For $\gamma \in G_i$ with the end point $p \in \Sigma_i$ and a point $q \in \Sigma_j$, $j > i$, let us consider a sequence of different periodic orbits $p = p_0 \prec p_1 \prec \dots \prec p_k = q$ such that $\gamma \cap W_{p_1}^u \neq \emptyset$, the length of the longest such chain is denoted by $\text{beh}(q|\gamma)$.

Let $\gamma \in \check{G}_i$ be a separatrix of $p \in \Sigma_i$ and let N_γ^t be the connected component of $N_p^t \setminus W_p^u$ which contains γ . We endow with the index γ (resp. p) the preimages in M (through the linearizing map μ_p) of all objects from the linear model \mathcal{N} associated with the separatrix γ (resp. p); for being precise we decide that $\mu_p(\gamma) = Ox_3^+$. For a separatrix γ in \check{G}_i , let us fix a saddle point q_γ such that $\text{beh}(q_\gamma|\gamma) = 1$. Notice that the intersection $\gamma \cap W_{q_\gamma}^u$ consists of a finite number of heteroclinic orbits.

Lemma 4.8 *Let $n \geq 1$, $i \in \{0, \dots, n-1\}$. For every $\gamma \in \check{G}_i$ there are positive numbers ρ , δ and ε (depending on γ) such that for every heteroclinic point $Z_\gamma^0 \in (\gamma \cap W_{q_\gamma}^u)$ with $z^0 < \varepsilon$ the following properties hold:*

- (1) U_p avoids all heteroclinic points;
- (2) $\varphi(\tilde{d}_p) \subset \phi_{\varphi_i^u, \psi_i^s}(N_i^{a_i})$;
- (3) $\varphi(\tilde{c}_p) \cap \phi_{\varphi_i^u, \psi_i^s}(\tilde{c}_p^0) = \emptyset$, $\varphi(\tilde{c}_p^1) \cap \phi_{\varphi_i^u, \psi_i^s}(\tilde{c}_p^0) = \emptyset$ and $\varphi(\tilde{\beta}_\gamma) \subset \phi_{\varphi_i^u, \psi_i^s}(\tilde{V}_\gamma)$.

Proof: Let $\gamma \in \check{G}_i$, $i \in \{0, \dots, n-1\}$. Due to Lemma 3.2, there is a generic $\rho > 0$ such that the curve c_γ avoids all heteroclinic points. Since W_l^s accumulates on W_k^s for every $l < k$, then $K_p \cap W_{i-1}^s$ is made of a finite number of heteroclinic points y_1, \dots, y_r which we can cover by closed 2-discs $b_1, \dots, b_r \subset \text{int} K_p$. In $K_p \setminus \text{int}(b_1 \cup \dots \cup b_r)$ there is a finite number of heteroclinic points from W_{i-2}^s which we cover by the union of a finite number of closed 2-discs, and so on. Thus we get that all heteroclinic points in K_p belong to the union of finitely many closed 2-discs avoiding ∂K_p . Therefore, there is $\delta \in (0, \frac{\rho}{4})$ such that U_p avoids heteroclinic points. This proves item (1).

By assumption of Theorem 1, φ is defined on the complement of the stable manifolds and, by definition, $\phi_{\varphi_i^u, \psi_i^s}$ coincides with φ on $W_i^u \setminus L^s$, and hence on U_p . As φ and $\phi_{\varphi_i^u, \psi_i^s}$ are continuous, we can choose $\varepsilon > 0$ sufficiently small so that, if Z_γ^0 is any heteroclinic point in the intersection $\gamma \cap W_{q_\gamma}^u$ with $z^0 < \varepsilon$, the requirements of (2) and (3) are fulfilled. \diamond

Let us fix U_p satisfying item (1) of Lemma 4.8 and define

$$U_i = \bigcup_{p \in \Sigma_i} \left(\bigcup_{k=0}^{\text{per}(p)-1} f^k(U_p) \right), \quad K_i = \bigcup_{p \in \Sigma_i} \left(\bigcup_{k=0}^{\text{per}(p)-1} f^k(K_p) \right).$$

Until the end of Section 4, we assume that for every $\gamma \in \check{G}_{n-1}$ the neighborhoods \mathcal{T}_γ and \mathcal{H}_γ have the parameters $\rho, \delta, \varepsilon, z^0$ as in Lemmas 4.8 and z^1 is chosen such that the arc $(z_\gamma^0, z_\gamma^1) \subset \gamma$ does not contain heteroclinic points. But, when $\gamma \in \check{G}_i$, $i \in \{0, \dots, n-2\}$, the parameter ε will be still more specified in Lemma 4.9 below.

Lemma 4.9 *Let $n \geq 2$. For every $i \in \{0, \dots, n-2\}$ and $\gamma \in \check{G}_i$, there is a heteroclinic point $Z_\gamma^0 \in \gamma$ satisfying the conditions of Lemma 4.8 and in addition:*

$$\mathcal{T}_\gamma \cap \tilde{U}_j = \emptyset \quad \text{for } j \in \{i+1, \dots, n-1\}.$$

In this statement, it is meant that \tilde{U}_{n-1} is associated with the points $Z_{\gamma'}, \gamma' \in \check{G}_{n-1}$ given by Lemma 4.8 and \tilde{U}_j is associated with the points $Z_{\gamma''}, \gamma'' \in \check{G}_j$ given by Lemma 4.9 for every $j > i$. Therefore, it makes sense to prove Lemma 4.9 by decreasing induction on i from $i = n-2$ to 0. This is what is done below.

Proof: Let us first prove the lemma for $i = n-2$. Let $\gamma \in \check{G}_{n-2}$ and let p be the saddle end point of γ . Notice that the intersection $\gamma \cap K_{n-1}$ consists of a finite number points a_1, \dots, a_l avoiding U_{n-1} . Let $d_1, \dots, d_l \subset K_{n-1}$ be compact discs with centres a_1, \dots, a_l and radius r_* (in linear coordinates of N_p) avoiding U_{n-1} . Let us choose a number $n^* \in \mathbb{N}$ such that $\frac{\rho}{2^{n^*}} < r_*$. Let $Z_\gamma^* \subset \gamma$ be a point such that the segment $[p, Z_\gamma^*]$ of γ avoids \tilde{K}_{n-1} and $\mu_p(Z_\gamma^*) = Z^* = (0, 0, z^*)$ where $z^* < \varepsilon$. Then every heteroclinic point z_γ^0 so that $z^0 < \frac{z^*}{2^{n^*}}$ possesses the property: $\mathcal{T}_\gamma \cap \tilde{K}_{n-1}$ avoids \tilde{U}_{n-1} .

For the induction, let us assume now that the construction of the desired heteroclinic points is done for $i+1, i+2, \dots, n-2$. Let us do it for i . Let $\gamma \in \check{G}_i$. By assumption of the induction $(\bigcup_{k=i+1}^{j-1} \mathcal{T}_k) \cap \tilde{U}_j = \emptyset$ for $j \in \{i+2, \dots, n-1\}$. Since W_{k-1}^s accumulates on W_k^s for every $k \in \{0, \dots, n\}$, then $(\bigcup_{k=i+1}^{j-1} \mathcal{T}_k) \cap K_j$ is a compact subset of K_j and the intersection $(\gamma \setminus (\bigcup_{k=i+1}^{j-1} \mathcal{T}_k)) \cap K_j$ consists of a finite number points a_1, \dots, a_l avoiding U_j . Let $d_1, \dots, d_l \subset K_j$ be compact discs with centres a_1, \dots, a_l and radius r_* (in linear coordinates of N_p) avoiding U_j and such that r_* is less than the distance between $\partial(K_j \setminus U_j)$ and $(\bigcup_{k=i+1}^{j-1} \mathcal{T}_k) \cap K_j$. Similar to the case $i = n-2$ it is possible to choose a heteroclinic point Z_γ^0 sufficiently close to the saddle p where γ ends such that the set $(\mathcal{T}_\gamma \setminus (\bigcup_{k=i+1}^{j-1} \mathcal{T}_k)) \cap \tilde{K}_j$ avoids \tilde{U}_j . \diamond

In what follows, we assume that, for every $\gamma \subset \check{G}_i$, $i \in \{0, \dots, n-2\}$, the neighborhoods \mathcal{T}_γ and \mathcal{H}_γ have parameters $\rho, \delta, \varepsilon, z^0$ as in Lemma 4.8 and moreover ε satisfies to Lemma 4.9. For $i \in \{0, \dots, n-1\}$, we set

$$\mathcal{T}_i = \bigcup_{\gamma \subset \check{G}_i} \left(\bigcup_{k=0}^{\text{per}(\gamma)-1} f^k(\mathcal{T}_\gamma) \right).$$

For $\gamma \subset \check{G}_i$, $j > i$, let us denote by $\mathcal{J}_{\gamma,j}$ the union of all connected components of $W_j^u \cap \mathcal{T}_\gamma$

which do not lie in $\text{int } \mathcal{T}_k$ with $i < k < j$. Let $\mathcal{J}_\gamma = \bigcup_{j=i+1}^n \mathcal{J}_{\gamma,j}$ and

$$\mathcal{J}_i = \bigcup_{\gamma \subset \check{G}_i} \left(\bigcup_{k=0}^{\text{per}(\gamma)-1} f^k(\mathcal{J}_\gamma) \right).$$

Let \mathcal{W}_γ be the fundamental domain of $f^{\text{per}(\gamma)}|_{\mathcal{T}_\gamma \setminus W_p^u}$ limited by the plaques of the two heteroclinic points Z_γ^0 and $f^{\text{per}(\gamma)}Z_\gamma^0$. Notice that $\gamma \cap \mathcal{W}_\gamma$ is a fundamental domain of $f^{\text{per}(\gamma)}|_\gamma$. Since W_k^u accumulates on W_l^u only when $l < k$, then the set $\mathcal{J}_{\gamma,j} \cap \mathcal{W}_\gamma$ consists of a finite number of closed 2-discs. Hence, the set $\mathcal{J}_\gamma \cap \gamma \cap \mathcal{W}_\gamma$ consists of a finite number of heteroclinic points; denote them $Z_\gamma^2, \dots, Z_\gamma^m$ (m depends on γ). Finally, choose an arbitrary point $Z_\gamma^1 \in \gamma$ so that the arc $(z_\gamma^0, z_\gamma^1) \subset \gamma$ does not contain heteroclinic points from \mathcal{J}_γ . Let us construct \mathcal{H}_γ using the point $Z^1 = \mu_p(Z_\gamma^1)$ and the parameter δ from Lemma 4.8. Without loss of generality we will assume that $\mu_p(Z_\gamma^i) = Z^i = (0, 0, z^i)$ for $z^0 > z^1 > \dots > z^m > \frac{z^0}{4}$. For $i = 0, \dots, n-1$ let

$$\mathcal{H}_i = \bigcup_{\gamma \subset \check{G}_i} \left(\bigcup_{k=0}^{\text{per}(\gamma)-1} f^k(\mathcal{H}_\gamma) \right) \quad \text{and} \quad \mathcal{M}_i = V_f \cup \bigcup_{k=0}^i (G_k \cup \Sigma_k).$$

Lemma 4.10 *There is an equivariant topological embedding $\varphi_0 : \mathcal{M}_0 \rightarrow M'$ with following properties:*

- (1) φ_0 coincides with φ out of \mathcal{T}_0 ;
- (2) $\varphi_0|_{\mathcal{H}_0} = \phi_{\psi_0^u, \psi_0^s}|_{\mathcal{H}_0}$, where $\psi_0^u = \varphi|_{W_0^u}$;
- (3) $\varphi_0(W_1^u) = W_1^{tu}$ and $\varphi_0(W_k^u \setminus \bigcup_{j=1}^{k-1} \text{int } \mathcal{T}_j) \subset W_k^{tu}$ for every $k \in \{2, \dots, n\}$.

Proof: The desired φ_0 should be an interpolation between $\varphi : V_f \setminus \mathcal{T}_0 \rightarrow M'$ and $\phi_{\varphi_0^u, \psi_0^s}|_{\mathcal{H}_0}$. Due to Lemma 4.8 (2) and the equivariance of the considered maps, the embedding

$$\xi_0 = \phi_{\psi_0^u, \psi_0^s}^{-1} \varphi : \mathcal{T}_0 \setminus W_0^s \rightarrow M$$

is well-defined. Let $\gamma \subset \check{G}_0$ be a separatrix ending at $p \in \Sigma_0$ and $\xi_\gamma = \xi_0|_{\mathcal{T}_\gamma}$. By construction, the topological embedding $\xi = \mu_p \xi_\gamma \mu_p^{-1} : \mathcal{T} \rightarrow N$ has the following properties:

- (i) $\xi \mathcal{E} = \mathcal{E} \xi$ (as $\mathcal{E} \mu_p = \mu_p f^{\text{per}(\gamma)}$ and $\xi_\gamma f^{\text{per}(\gamma)} = f^{\text{per}(\gamma)} \xi_\gamma$);
- (ii) ξ is the identity on Ox_1x_2 (as $\phi_{\psi_0^u, \psi_0^s}|_{W_0^u} = \varphi|_{W_0^u}$);
- (iii) $\xi(\Pi(z^0) \cap \mathcal{T}) \subset \Pi(z^0)$ and $\xi(\Pi(z^i) \cap \partial \mathcal{T}) \subset \Pi(z^i)$, $i \in \{2, \dots, m\}$ (as $\xi_\gamma(L^u \cap \mathcal{T}_\gamma \setminus \gamma) \subset L^u$);
- (iv) $\xi(\tilde{c}) \cap \tilde{c}^0 = \emptyset$, $\xi(\tilde{c}^1) \cap \tilde{c}^0 = \emptyset$ and $\xi(\tilde{\beta}) \subset \tilde{V}$ (due to Lemma 4.8 (3)).

Thus, ξ satisfies all conditions of Proposition 5.1 and, hence, there is an embedding $\zeta : \mathcal{T} \rightarrow N$ such that:

- (I) $\zeta a = a \zeta$;
- (II) ζ is the identity on \mathcal{H} ;
- (III) $\zeta(\Pi(z^i) \cap \mathcal{T}) \subset \Pi(z^i)$, $i \in \{0, 2, \dots, m\}$

(IV) ζ is ξ on $\partial\mathcal{T}$.

Then the embedding $\zeta_\gamma = \mu_p^{-1}\zeta\mu_p : \mathcal{T}_\gamma \rightarrow N_\gamma$ satisfies the properties:

- (I') $\zeta_\gamma f^{per(\gamma)} = f^{per(\gamma)}\zeta_\gamma$;
- (II') ζ_γ is the identity on \mathcal{H}_γ ;
- (III') $\zeta(\mathcal{J}_\gamma) \subset L^u$
- (IV') ζ_γ is ξ_γ on $\partial\mathcal{T}_\gamma$.

Independently, one does the same for every separatrix $\gamma \in \check{G}_0$. Then, it is extended to all separatrices in G_0 by equivariance. As a result, we get a homeomorphism ζ_0 of \mathcal{T}_0 onto $\xi_0(\mathcal{T}_0)$ which coincides with ξ_0 on $\partial\mathcal{T}_0$. Now, define the embedding $\varphi_0 : \mathcal{M}_0 \rightarrow M'$ to be equal to $\phi_{\psi_0^u, \psi_0^s}\zeta_0$ on \mathcal{T}_0 and to φ on $\mathcal{M}_0 \setminus \mathcal{T}_0$. One checks the next properties:

- (1) φ_0 coincides with φ out of \mathcal{T}_0 ;
- (2) $\varphi_0|_{\mathcal{H}_0} = \phi_{\psi_0^u, \psi_0^s}|_{\mathcal{H}_0}$;
- (3') $\varphi_0(\mathcal{J}_0) \subset L^u$.

The last property and the definition of the set \mathcal{J}_γ imply that $\varphi_0(W_1^u) = W_1'^u$ and $\varphi_0(W_k^u \setminus \bigcup_{j=1}^{k-1} \text{int } \mathcal{T}_j) \subset W_k'^u$ for every $k \in \{2, \dots, n\}$. Thus φ_0 satisfies all required conditions of the lemma. \diamond

Lemma 4.11 *Assume $n \geq 2$, $i \in \{0, \dots, n-2\}$, and assume there is an equivariant topological embedding $\varphi_i : \mathcal{M}_i \rightarrow M'$ with following properties:*

- (1) φ_i coincides with φ_{i-1} out of \mathcal{T}_i ;
- (2) $\varphi_i|_{\mathcal{H}_i} = \phi_{\psi_i^u, \psi_i^s}$, where $\psi_i^u = \varphi_{i-1}|_{W_i^u}$ and $\varphi_{-1} = \varphi$;
- (3) *there is an f -invariant union of tubes $\mathcal{B}_i \subset (\mathcal{T}_i \cap \bigcup_{j=0}^{i-1} \mathcal{H}_j)$ containing $(\mathcal{T}_i \cap (\bigcup_{j=0}^{i-1} W_j^s))$ where*

φ_i coincides with φ_{i-1} (we assume $\mathcal{B}_0 = \emptyset$);

- (4) $\varphi_i(W_{i+1}^u) = W_{i+1}'^u$ and $\varphi_i(W_k^u \setminus \bigcup_{j=i+1}^{k-1} \text{int } \mathcal{T}_j) \subset W_k'^u$ for every $k \in \{i+2, \dots, n\}$.

Then there is a homeomorphism φ_{i+1} with the same properties (1)-(4)

Proof: The desired φ_{i+1} should be an interpolation between $\varphi_i : \mathcal{M}_{i+1} \setminus \mathcal{T}_{i+1} \rightarrow M'$ and $\phi_{\psi_{i+1}^u, \psi_{i+1}^s}|_{\mathcal{H}_{i+1}}$ where $\psi_{i+1}^u = \varphi_i|_{W_{i+1}^u}$. Let $\gamma \in \check{G}_{i+1}$ be a separatrix ending at $p \in \Sigma_{i+1}$. It follows from the definition of the set \mathcal{J}_i and the choice of the point q_γ that $(W_{q_\gamma}^u \cap \mathcal{T}_i) \subset \mathcal{J}_i$. Then, due to condition (4) for φ_i we have $\varphi_i(W_{q_\gamma}^u \cap \mathcal{T}_i) \subset W_{q_\gamma}'^u$. By the property (1) of the homeomorphism φ_i and the properties of \mathcal{T}_{i+1} from Lemmas 4.8 (1) and 4.9, we get that $\varphi_i|_{\tilde{U}_p} = \varphi|_{\tilde{U}_p}$. Then $\phi_{\varphi_{i+1}^u, \psi_{i+1}^s}|_{\tilde{U}_p} = \phi_{\psi_{i+1}^u, \psi_{i+1}^s}|_{\tilde{U}_p}$. Thus it follows from the property (2) in Lemma 4.8 that the following embedding is well-defined: $\xi_\gamma = \phi_{\psi_{i+1}^u, \psi_{i+1}^s}^{-1} \varphi_i : \mathcal{T}_\gamma \setminus (\gamma \cup p) \rightarrow M'$.

By construction, the topological embedding $\xi = \mu_p \xi_\gamma \mu_p^{-1}$ satisfies to all conditions of Proposition 5.1. Let ζ be the embedding which is yielded by that proposition. Define $\zeta_\gamma = \mu_p^{-1} \zeta \mu_p$. Notice that by the property (3) of the homeomorphism ψ^s in Lemma 4.7 and by the properties $\psi_{i+1}^u = \varphi_i|_{W_{i+1}^u}$, we have that ζ_γ is the identity on a neighborhood $\tilde{B}_\gamma \subset (\mathcal{T}_\gamma \cap \bigcup_{j=0}^i \mathcal{H}_j)$ of

$\mathcal{T}_\gamma \cap (\bigcup_{j=0}^i W_j^s)$. Independently, one does the same for every separatrix $\gamma \in \check{G}_{i+1}$. Assuming that

$\zeta_{f(\gamma)} = f' \zeta_\gamma f^{-1}$ and $\tilde{B}_{i+1} = \bigcup_{\gamma \in \check{G}_{i+1}} \left(\bigcup_{k=0}^{per(\gamma)-1} f^k(\tilde{B}_\gamma) \right)$ we get a homeomorphism ζ_{i+1} on \mathcal{T}_{i+1} .

Thus the required homeomorphism coincides with $\phi_{\psi_{i+1}^u, \psi_{i+1}^s}$ on \mathcal{H}_{i+1} and with φ_i out of \mathcal{T}_{i+1} .
 \diamond

Let G be the union of all stable one-dimensional separatrices which do not contain heteroclinic points, $N_G^t = \bigcup_{\gamma \in G} N_\gamma^t$ and

$$\mathcal{M} = \mathcal{M}_{n-1} \cup G.$$

Lemma 4.12 *There are numbers $0 < \tau_1 < \tau_2 < 1$ and an equivariant embedding $h_{\mathcal{M}} : \mathcal{M} \rightarrow M'$ with the following properties:*

- (1) $h_{\mathcal{M}}$ coincides with φ_{n-1} out of $N_G^{\tau_2}$;
- (2) $h_{\mathcal{M}}$ coincides with $\phi_{\varphi_{n-1}, \psi^s}$ on $N_G^{\tau_1}$, where $\psi^s : L^s \rightarrow L'^s$ is yielded by Lemma 4.7;
- (3) there is an f -invariant neighborhood of the set $N_G \cap (G_0 \cup \dots \cup G_{n-1})$ where $h_{\mathcal{M}}$ coincides with φ_{n-1} .

Proof: Let $\check{G} \subset G$ be a union of separatrices from G such that $\gamma_2 \neq f^k(\gamma_1)$ for every $\gamma_1, \gamma_2 \in \check{G}$, $k \in \mathbb{Z} \setminus \{0\}$ and $G = \bigcup_{\gamma \in \check{G}} orb(\gamma)$. Let $i \in \{0, \dots, n\}$, $p \in \Sigma_i$ and $\gamma \in G$.

Notice that $(N_\gamma \setminus (\gamma \cup p)) / f^{per(\gamma)}$ is homeomorphic to $X \times [0, 1]$ where X is 2-torus and the natural projection $\pi_\gamma : N_\gamma \setminus (\gamma \cup p) \rightarrow X \times [0, 1]$ sends ∂N_γ^t to $X \times \{t\}$ for each $t \in (0, 1)$ and sends $W_p^u \setminus p$ to $X \times \{0\}$. Let $\xi_\gamma = \phi_{\varphi_{n-1}|_{W_i^u, \psi_i^s}}^{-1} \varphi_{n-1}|_{N_\gamma^{a_i} \setminus (\gamma \cup p)}$ and $\hat{\xi}_\gamma = \pi_\gamma \xi_\gamma \pi_\gamma^{-1}|_{X \times [0, a_i]}$. Due to item (3) of Lemma 4.11, the homeomorphism $\hat{\xi}_\gamma$ coincides with the identity in some neighborhood of $\pi_\gamma(N_\gamma^{a_i} \cap (G_0 \cup \dots \cup G_{n-1}))$. Let us choose this neighborhood of the form $B_\gamma \times [0, a_i]$. Let us choose numbers $0 < \tau_{1,\gamma} < \tau_{2,\gamma} < a_i$ such that $\hat{\xi}_\gamma(X \times [0, \tau_{2,\gamma}]) \subset X \times [0, \tau_{1,\gamma}]$. By construction, $\hat{\xi}_\gamma : X \times [0, \tau_{2,\gamma}] \rightarrow X \times [0, 1]$ is a topological embedding which is the identity on $X \times \{0\}$ and $\hat{\xi}_\gamma|_{B_\gamma \times [0, \tau_{2,\gamma}]} = id|_{B_\gamma \times [0, \tau_{2,\gamma}]}$. Then, by Proposition 5.2,

1. there is a homeomorphism $\hat{\zeta}_\gamma : X \times [0, \tau_{2,\gamma}] \rightarrow \hat{\xi}_\gamma(X \times [0, \tau_{2,\gamma}])$ such that $\hat{\zeta}_\gamma$ is identity on $X \times [0, \tau_{1,\gamma}]$ and is $\hat{\xi}_\gamma$ on $X \times \{\tau_{2,\gamma}\}$.

2. $\hat{\zeta}_\gamma|_{B_\gamma \times [0, \tau_{2,\gamma}]} = id|_{B_\gamma \times [0, \tau_{2,\gamma}]}$.

Let ζ_γ be a lift of $\hat{\zeta}_\gamma$ on $N_\gamma^{\tau_{2,\gamma}}$ which ξ_γ on $\partial N_\gamma^{\tau_{2,\gamma}}$. Thus $\varphi_\gamma = \phi_{\varphi_{n-1}|_{W_i^u, \psi_i^s}} \zeta_\gamma$ is the desired extension of φ_{n-1} to N_γ . Doing the same for every separatrix $\gamma \in \check{G}$ and extending it to the other separatrices from G by equivariance, we get the required homeomorphism $h_{\mathcal{M}}$ for $\tau_1 = \min_{\gamma \in \check{G}} \{\tau_{1,\gamma}\}$ and $\tau_2 = \min_{\gamma \in \check{G}} \{\tau_{2,\gamma}\}$.
 \diamond

So far in this section, we have modified the homeomorphism φ in a union of suitable linearizable neighborhoods of Ω_2 (with their 1-dimensional separatrices removed) so that the modified homeomorphism extends equivariantly to $W^s(\Omega_2)$. At the same time, we can perform a similar modification about Ω_1 since the involved linearizable neighborhoods of Ω_2 and Ω_1 are

mutually disjoint. Thus, we get a homeomorphism $h : M \setminus (\Omega_0 \cup \Omega_3) \rightarrow M \setminus (\Omega'_0 \cup \Omega'_3)$ conjugating $f|_{M \setminus (\Omega_0 \cup \Omega_3)}$ with $f'|_{M \setminus (\Omega'_0 \cup \Omega'_3)}$. Notice that $M \setminus (W_{\Omega_1}^s \cup W_{\Omega_2}^s \cup \Omega_3) = W_{\Omega_0}^s$ and $M \setminus (W_{\Omega'_1}^s \cup W_{\Omega'_2}^s \cup \Omega'_3) = W_{\Omega'_0}^s$. Since $h(W_{\Omega_1}^s) = W_{\Omega'_1}^s$ and $h(W_{\Omega_2}^s) = W_{\Omega'_2}^s$, then $h(W_{\Omega_0}^s \setminus \Omega_0) = W_{\Omega'_0}^s \setminus \Omega'_0$. Thus for each connected component A of $W_{\Omega_0}^s \setminus \Omega_0$, there is a sink $\omega \in \Omega_0$ such that $A = W_{\omega}^s \setminus \omega$. Similarly, $h(A)$ is a connected component of $W_{\Omega'_0}^s \setminus \Omega'_0$ such that $h(A) = W_{\omega'}^s \setminus \omega'$ for a sink $\omega' \in \Omega'_0$. Then we can continuously extend h to Ω_0 by defining $h(\omega) = \omega'$ for every $\omega \in \Omega_0$. A similar extension of h to Ω_3 finishes the proof of Theorem 1.

5 Topological background

We use below the notations which have been introduced before Lemma 4.8.

Proposition 5.1 *Let $z^0 > z^1 > \dots > z^m > \frac{z^0}{4} > 0$ and $\xi : \mathcal{T} \setminus Ox_3 \rightarrow N$ be a topological embedding with the following properties:*

- (i) $\xi\mathcal{E} = \mathcal{E}\xi$;
- (ii) ξ is the identity on Ox_1x_2 ;
- (iii) $\xi(\Pi(z^0 \cap \mathcal{T})) = \Pi(z^0)$ and $\xi(\Pi(z^i) \cap \partial\mathcal{T}) \subset \Pi(z^i)$, $i \in \{2, \dots, m\}$;
- (iv) $\xi(\tilde{c}) \cap \tilde{c}^0 = \emptyset$, $\xi(\tilde{c}^1) \cap \tilde{c}^0 = \emptyset$ and $\xi(\tilde{\beta}) \subset \tilde{V}$.

Then there is a homeomorphism $\zeta : \mathcal{T} \rightarrow N$ such that

- (I) $\zeta\mathcal{E} = \mathcal{E}\zeta$;
- (II) ζ is the identity on \mathcal{H} – and consequentially on Ox_1x_2 ;
- (III) $\zeta(\Pi(z^i) \cap \mathcal{T}) \subset \Pi(z^i)$, $i \in \{0, 2, \dots, m\}$
- (IV) ζ is ξ on $\partial\mathcal{T}$.

Moreover, if ξ is identity on \tilde{B} for a set $B \subset (K \setminus U)$ then ζ is also identity on \tilde{B} .

Proof: For $j = 0, \dots, m$, we denote by E_j the domain of \mathbb{R}^3 located between the horizontal planes $\Pi(z_j)$ and $\Pi(z_{j+1})$, with $z_{m+1} = \frac{z_0}{4}$. Since the requested ζ has to be equivariant with respect to \mathcal{E} , it is useful to describe a fundamental domain \mathcal{V} for the action of \mathcal{E} on the closure of $\mathcal{T} \setminus \mathcal{H}$; the natural one is

$$\mathcal{V} = cl(\mathcal{T} \setminus \mathcal{H}) \cap \left(\bigcup_{j=0}^m E_j \right),$$

where $cl(-)$ stands for *closure of* $(-)$. The domain \mathcal{V} is sliced by the horizontal planes $\Pi(z_j)$, $j = 2, \dots, m$, and the vertical cylinders $\mathcal{E}^{-1}(\tilde{c})$ and \tilde{c}^1 , yielding the decomposition $\mathcal{V} = R_0 \cup R_1 \cup Q_0 \cup Q_2 \cup \dots \cup Q_m$ into solid tori whose interiors are mutually disjoint. Notice that the plane $\Pi(z_1)$ is not used in this decomposition.

More precisely, $R_0 \subset E_0$ is limited by the cylinders $\mathcal{E}^{-1}(\tilde{c}^1)$ and $\mathcal{E}^{-1}(\tilde{c})$; then, $R_1 \subset E_0$ is limited by the cylinders $\mathcal{E}^{-1}(\tilde{c})$ and \tilde{c}^1 . The others of the list are obtained from \tilde{U} by slicing \mathcal{V} with horizontal planes. The first of the latter, namely Q_0 , is special as it is bounded by $\Pi(z_0)$ and $\Pi(z_2)$; then, Q_j is bounded by $\Pi(z_j)$ and $\Pi(z_{j+1})$ for $j = 2, \dots, m$. The vertical parts in the boundaries of the above-mentioned solid tori are provided by the vertical slices or the vertical parts of $\partial\mathcal{T} \cup \partial\mathcal{H}$.

For $j = 0, 2, \dots, m$, let $U(z_j) := \tilde{U} \cap \Pi(z_j)$. By construction, the top face of R_0 is $U'(z_0) := \mathcal{E}^{-1}(U(z_{m+1})) = \Pi(z_0) \cap \mathcal{E}^{-1}(\tilde{U})$; its bottom is $U'(z_1) := \Pi(z_1) \cap \mathcal{E}^{-1}(\tilde{U})$. Similarly, the top of R_1 is $U''(z_0) := \Pi(z_0) \cap \tilde{K}$ and its bottom is $U''(z_1) := \Pi(z_1) \cap \tilde{K}$.

It is important that each horizontal or vertical annulus Ann from the previous list is marked with a special arc noted $\beta(Ann)$ linking the two boundary components of Ann and defined as follows:

$$\beta(Ann) = Ann \cap \{x_1 > 0, x_2 = 0\}.$$

According to assumption (iv), all these arcs (except when $Ann = U''(z_0)$ or $U''(z_1)$) fulfill the next condition, referred to as the β -condition, namely: they are mapped by ξ into $\{x_1 > 0\}$.

First of all, we define $\zeta|_{R_1}$ by rescaling $\zeta|_{\tilde{K}}$ in the next way. There is a homeomorphism $\kappa : \tilde{K} \rightarrow R_1$ of the form: $(x_1, x_2, x_3) \mapsto (x_1, x_2, \rho(x_3))$ where $\rho : [0, z_0] \rightarrow [z_1, z_0]$ is any increasing continuous function. Then, we define $\zeta|_{R_1} = \kappa \xi|_{\tilde{K}} \kappa^{-1}$. Observe that ζ equals ξ on $U''(z_0)$ and coincide with the identity on $U''(z_1)$. As a consequence, the complement part of the statement follows directly. Indeed, if B lies in K and $\xi|_{\tilde{B}} = Id$ then its conjugate by κ is the identity on $\tilde{B} \cap R_1$.

We continue by defining ζ on the other horizontal annuli from the previous list. As required, ζ is the identity when this annulus lies in \mathcal{H} . For the others, that is, $U'(z_0)$ and $U(z_j)$, $j = 0, 2, \dots, m$, Lemma 5.4 is applicable as it is explained right below.

Each of these annuli is bounded by two curves; one of the two lies in the frontier of \mathcal{T} on which ζ has to coincide with ξ and is mapped in the respective plane $\Pi(z_j)$ – according to (iii); and the other lies in \mathcal{H} where ζ has to coincide with $Id|_{\mathcal{H}}$. In order to satisfy the equivariance property 3), we choose

$$(*) \quad \zeta|_{U(z_{m+1})} = \mathcal{E} \zeta|_{U'(z_0)} \mathcal{E}^{-1}.$$

Moreover, due to the β -condition, Lemma 5.4 holds and yields ζ on each of the listed horizontal annuli.

We continue by defining ζ on the vertical annuli in the above splitting of \mathcal{V} . When such an annulus lies in ∂H (resp. $\partial \mathcal{T}$), we must take $\zeta = Id$ (resp. $\zeta = \xi$) over there. The last two annuli are $R_0 \cap R_1$ and $R_1 \cap Q_0$ on which ζ is already defined by conjugating by κ . Notice that the β -condition holds for these two annuli because conjugating by κ preserves the β -condition.

Let us look more precisely to ∂Q_0 . It is made of the following: two horizontal annuli $U(z_0)$ and $U(z_2)$, and three vertical ones $R_1 \cap Q_0$, $\tilde{c}^1 \cap E_1$ (lying in \mathcal{H}) and $\tilde{c} \cap (E_0 \cup E_1)$. The β -condition holds for each of these latter annuli.

For finishing the proof, it remains to extend the ζ which we have defined right above on the tori ∂R_0 , ∂Q_0 and ∂Q_j , $j = 2, \dots, m$ to embeddings of the solid tori $R_0, Q_0, Q_2, \dots, Q_m$ with values in $E_0, E_0 \cup E_1, E_2, \dots, E_m$ respectively. The boundary data consists of annuli where ζ fulfills the β -condition. Therefore, the assumptions of Proposition 5.5 are fulfilled; then the conclusion holds true and yields the desired extension of ζ to the listed solid tori.

According to (*), we can extend the ζ which is built above on a fundamental domain to $\mathcal{T} \setminus \mathcal{H}$ equivariantly. Since this extension coincides with the identity on \mathcal{H} , it extends by $Id|_{Ox_1x_2}$. This is a continuous extension because any point of the plane Ox_1x_2 adheres only to $\mathcal{H} \setminus Ox_1x_2$ when considering the closure of $\mathcal{T} \setminus Ox_1x_2$.

◇

Proposition 5.2 *Let X be a compact topological space, $0 < \tau_1 < \tau_2 < 1$ and $\hat{\xi} : X \times [0, \tau_2] \rightarrow X \times [0, 1]$ be a topological embedding which is the identity on $X \times \{0\}$, $X \times [0, \tau_1] \subset \hat{\xi}(X \times [0, \tau_2])$. Then*

1. *there is a homeomorphism $\hat{\zeta} : X \times [0, \tau_2] \rightarrow \xi(X \times [0, \tau_2])$ such that $\hat{\zeta}$ is identity on $X \times [0, \tau_1]$ and is $\hat{\xi}$ on $X \times \{\tau_2\}$.*
2. *if for a set $B \subset X$ the equality $\hat{\xi}|_{B \times [0, \tau_2]} = id|_{B \times [0, \tau_2]}$ is true then $\hat{\zeta}|_{B \times [0, \tau_2]} = id|_{B \times [0, \tau_2]}$.*

Proof: Let us choose $l \in (\tau_1, \tau_2)$ such that $X \times [0, l] \subset \hat{\xi}(X \times [0, \tau_2])$. Define a homeomorphism $\kappa : [\tau_1, 1] \rightarrow [0, 1]$ by the formula

$$\kappa(t) = \begin{cases} (x, \frac{l(t-\tau_1)}{l-\tau_1}), & t \in [\tau_1, l]; \\ (x, t), & t \in [l, 1]. \end{cases}$$

Let $\mathcal{K}(x, t) = (x, \kappa(t))$ on $X \times [\tau_1, 1]$. Then the required homeomorphism can be defined by the formula

$$\hat{\zeta}(x, t) = \begin{cases} (x, t), & t \in [0, \tau_1]; \\ \mathcal{K}^{-1}\xi(\mathcal{K}((x, s))), & s \in [\tau_1, \tau_2]. \end{cases}$$

Property 2 automatically follows from this formula. ◇

We now collect some facts of geometric topology in dimension 2 and 3 on which the proof of Proposition 5.1 is based. We begin with the Schönflies Theorem (see Theorem 10.4 in [17]).

Proposition 5.3 *Every topological embedding of \mathbb{S}^1 into \mathbb{R}^2 is the restriction of a global homeomorphism of \mathbb{R}^2 which is the identity map outside some compact set of the plane.*

One can derive the Annulus Theorem in dimension 2; we state and prove it in the only case which we use. The coordinates of \mathbb{R}^2 are (x_1, x_2) . The unit closed disc in \mathbb{R}^2 is denoted by \mathbb{D}^2 ; its boundary is \mathbb{S}^1 . The annulus $2\mathbb{D}^2 \setminus \text{int}(\mathbb{D}^2)$ is denoted by \mathbb{A} . Let \mathbb{I} denote the arc $\{1 \leq x_1 \leq 2, x_2 = 0\}$.

Lemma 5.4 *Let $g : 2\mathbb{S}^1 \cup \mathbb{I} \rightarrow \mathbb{R}^2 \setminus (0, 0)$ be a topological embedding which surrounds the origin in the direct sense and has the next properties: $g(\mathbb{I}) \subset \{x_1 > 0\}$, the image $g(2\mathbb{S}^1)$ avoids the circle C of radius $\frac{3}{2}$ and $g(1, 0)$ lies inside $\frac{3}{2}\mathbb{D}^2$. Then $g|_{2\mathbb{D}^2}$ extends to an embedding $G : \mathbb{A} \rightarrow \mathbb{R}^2 \setminus \text{int}(\mathbb{D}^2)$ which coincides with the identity on \mathbb{S}^1 and maps \mathbb{I} into $\{x_1 > 0\}$.*

Proof: Let p be the last point on $g(\mathbb{I})$ starting from $g(1, 0)$ which belongs to C . Let q be its inverse image in \mathbb{I} . Define G on the segment $[(1, 0), q]$ as the affine map whose image is $[(1, 0), p]$ and take G coinciding with g on $[q, (2, 0)]$. The image $G(\mathbb{I})$ is a simple arc in $\{x_1 > 0\}$. Because, any simple arc is tame in the plane, this definition of G on \mathbb{I} and the values which are imposed on the two circles \mathbb{S} and $2\mathbb{S}^1$ extends to a neighborhood N of $\mathbb{S}^1 \cup \mathbb{I} \cup 2\mathbb{S}^1$ in \mathbb{R}^2 . By taking one boundary component of N one derives a parametrized simple curve C' in $\mathbb{R}^2 \setminus \mathbb{D}^2$ which does not surround the origin. Therefore, by the Schönflies Theorem, C' bounds a disc D in $\mathbb{R}^2 \setminus \mathbb{D}^2$

and the parametrization of C' extends to a parametrization of D . This yields the complete definition of G . \diamond

We are now going to apply famous theorems of geometric topology in dimension 3 to a concrete situation emanating from the problem we are facing in Proposition 5.1. The setting is the following. We look at the 3-space

$$Y = \mathbb{A} \times [0, 1] = \{(x_1, x_2, x_3) \in \mathbb{R}^3 \mid 1 \leq x_1^2 + x_2^2 \leq 4, 0 \leq x_3 \leq 1\}.$$

Denote Q_0 the solid torus in Y limited by the next two annuli:

- the vertical annulus $A_v := \{x_1^2 + x_2^2 = 1, 0 \leq x_3 \leq 1\}$;
- the *standard curved* annulus $A_0 := \{x_1^2 + x_2^2 + (x_3 - \frac{1}{2})^2 = \frac{5}{4}\} \cap Y$.

Observe that A_0 is contained in Y and contains the two horizontal circles forming ∂A_v .

Proposition 5.5 *Let $g : A_0 \rightarrow Y$ a bi-collared (meaning that g extends to an embedding $A_0 \times (-\varepsilon, +\varepsilon)$ for some $\varepsilon > 0$) topological embedding. It is assumed that g coincides with the identity on ∂A_0 and maps the arc $\Gamma_0 := A_0 \cap \{x_1 > 0, x_2 = 0\}$ to an arc Γ in $Y \cap \{x_1 > 0\}$. Then, g extends to an embedding $G : Q_0 \rightarrow Y$ which coincides with the identity on A_v .*

Proof: The image $A := g(A_0)$ separates Y in two components X and X^* . Since A is bi-collared, these two domains of Y are topological 3-manifolds. Therefore, we are allowed to apply E. Moise's Theorem (See [17, Chap.23 & Theorem 35.3] for existence and [17, 36.2] for uniqueness), including the *Hauptvermutung* in dimension 3:

Every 3-manifold has a unique PL-structure, up to an arbitrarily small topological isotopy. Moreover, its topological boundary is a PL-submanifold.

As a consequence, X and X^* have *PL*-structures which agree on their intersection A . By uniqueness applied for $X \cup X^*$, the *PL*-structure on the union is the standard one after some C^0 -small ambient isotopy. Denote by P the planar surface $\{x_2 = 0, x_1 > 0\} \cap Y$. After a new C^0 -small ambient isotopy in Y , we may assume that A and P are in general position. In what follows, we borrow the idea of proof from [14, Theorem 3.1]³.

Since P intersects each connected component of ∂A in one point only, we are sure that in general position $P \cap A$ is made of finitely many simple closed curves c_1, \dots, c_k in $\text{int}A$ and one arc γ which links the two components of ∂A . One of the above curves is *innermost* in P , meaning that it bounds a disc in P whose interior avoids A ; let say that c_1 is so. More precisely, c_1 bounds a disc d in P and a disc δ in A . By innermost position, $d \cup \delta$ is an embedded *PL* 2-sphere σ . As Y lies in \mathbb{R}^3 , this sphere bounds a 3-ball $\Delta \subset Y$. We are going to use these data in two ways.

First, we use δ for finding an isotopy h_t of A in itself from $Id|_A$ to $h_1 : A \rightarrow A$ such that $h_1(\Gamma) \cap \delta = \emptyset$. This is easily done as $\Gamma \cap \delta$ avoids one point z_δ in δ : one pushes $\Gamma \cap \delta$ along the rays of δ issued z_δ . Notice that $h_1(\Gamma)$ still lies in $\{x_1 > 0\}$, but this could be no longer true for $h_t(\Gamma)$, $t \neq 0, 1$, when δ is not contained in $\{x_1 > 0\}$.

³In this article which we referred to, it should be meant that the *PL*-category (or smooth category) is used. Indeed, there is no *general position* statement in topological geometry without more specific assumption.

Once, this is done, the ball Δ is used for finding an ambient isotopy of Y which is supported in a neighborhood of B , small enough so that $h_1(\Gamma)$ is kept fixed, and which moves $A \cap \Delta$ to the complement of P . Hence, this isotopy cancels c_1 from $A \cap P$; all intersection curves contained in $\text{int } \delta$ are cancelled at the same time. By repeating isotopies similar to the two previous ones, as many times as necessary, we get an embedding $g' : A_0 \rightarrow Y$ which coincides with the identity on ∂A_0 , still maps Γ_0 into $\{x_1 > 0\}$ and fulfills the following property: $A' := g'(A_0) \cap P$ is made of one arc γ' only which links the two components of $g'(\partial A_0)$. The annulus A' divides Y into two (closed) domains X' and X'^* which come from the splitting $X \cup_A X^*$ by an ambient isotopy fixing $\{x_3 = 0, 1\}$ pointwise.

As γ' is the only intersection component of $P \cap A'$, one knows that γ' divides P into a disc $\mu' \subset X'$ (meaning a *meridian* disc in a solid torus) and its complement in P . Removing from X' a regular neighborhood of μ' yields a PL embedded 2-sphere S . According to the Alexander theorem [1], this sphere bounds a ball $B_{X'}$ in \mathbb{R}^3 , as $Y \subset \mathbb{R}^3$. It is not possible that $B_{X'}$ contains μ' in its interior; in the contrary, $B_{X'}$ would get out of X'^* and have a non-bounded interior. As a consequence, X' is a *solid torus* since it is made of a ball and a 1-handle attached. The same holds for X as it is ambient isotopic to X' in Y .

This is not sufficient for concluding. It would be necessary to prove the same for the curve $g'(\Gamma_0)$, after making it a closed curve by adding the vertical arc $\gamma_0^* \subset A_v$ which links the two points of $g'(\Gamma_0) \cap A_v = \Gamma_0 \cap A_v = g(\Gamma_0) \cap A_v = \Gamma_0 \cap A_v = \gamma' \cap A_v$. That is the place where the assumption about $g(\Gamma_0)$ is used.

CLAIM. There exists an ambient isotopy from $Id|_Y$ to k_1 which is stationary on the vertical annulus A_v , which maps A' into itself and moves $g'(\Gamma_0)$ to γ' .

PROOF OF THE CLAIM. Assume first that the arcs $g'(\Gamma_0)$ and γ' meet in their end points only. Consider the closed curve α which is made of $\gamma \cup g'(\Gamma_0)$; it is contained in $\{x_1 > 0\} \cap A'$. By construction, the homological intersection of α with γ' is zero. Therefore, α bounds a disc $\delta' \subset A'$. Notice that it could be not contained in $\{x_1 > 0\}$. The disc δ' allows one to move $g'(\Gamma_0)$ to γ' by an isotopy of A' into itself with the required properties.

In case where $g'(\Gamma_0) \cap \text{int } \gamma'$ is non-empty, in general position this intersection is made of finitely many points. Among them, choose the point x which is the closest to $\gamma' \cap \{x_3 = 1\}$ when traversing γ' starting from bottom. Denote by x_0 the point $\gamma' \cap \{x_3 = 1\}$. One forms a closed curve $\tau \subset A'$ made of two arcs in A' , from x to x_0 respectively in γ' and $g'(\Gamma_0)$. For the same reason as for α above, the curve τ bounds a disc in A' which allows one to cancel x from $g'(\Gamma_0) \cap \gamma'$ by an isotopy of A' into itself with the required properties. Iterating this process reduces us to the first case. The claim is proved. \diamond

Let $g'' := k_1 g' : A_0 \rightarrow A'$. As a consequence of the claim, the closed curve $g''(\Gamma_0) \cup \gamma_0^*$ is the boundary of the *meridian* disc μ' . We are going to show that g'' extends to an embedding $G'' : Q_0 \rightarrow X'$ which coincides with the identity on A_v . In this aim, we denote by μ_0 the meridian of Q_0 defined by $\mu_0 = Q_0 \cap P$. For beginning with, we consider regular neighborhoods $N(\mu_0)$ and $N(\mu')$ of both meridians and we extend $g''|_{N(\mu_0) \cap A_0}$ to a homeomorphism $G''_0 : N(\mu_0) \rightarrow N(\mu')$ which is the identity on $N(\mu_0) \cap A_v$.

Let B_{Q_0} be the ball in Q_0 which is the closure of $Q_0 \setminus N(\mu_0)$. The restricted map $G_0''|_{\partial B_{Q_0}}$ glued with the restriction of g'' to the closure of $A_0 \setminus N(\mu_0)$ yields a homeomorphism

$$G_1'' : \partial B_{Q_0} \rightarrow \partial B_{X'}.$$

The desired G'' is obtained by extending G_1'' to B_{Q_0} by the cone construction (seeing a ball as the cone on its boundary). Since g and g'' are related one to the other by an ambient isotopy fixing A_v pointwise, an extension of g follows from an extension of g'' . \diamond

References

- [1] J. Alexander, *On the subdivision of 3-spaces by polyhedron*, Proc. Nat. Acad. Sci. USA 10 (1924), 6–8.
- [2] A. Andronov, L. Pontryagin, *Rough systems*, DAN. 14 No 5 (1937), 247–250.
- [3] G. de Baggis, *Rough systems of two differential equations* Uspehi Matem. Nauk. 10 No 4 (1955), 101–126.
- [4] R. Bing, *The Geometric Topology of 3-Manifolds*, Colloquium Publications 40, Amer. Math. Soc., 1983.
- [5] Ch. Bonatti, V. Grines, *Knots as topological invariant for gradient-like diffeomorphisms of the sphere S^3* , Journal of Dynamical and Control Systems 6 No 4 (2000), 579–602.
- [6] Ch. Bonatti, V. Grines, V. Medvedev, E. Pecou, *Three-manifolds admitting Morse-Smale diffeomorphisms without heteroclinic curves*, Topology and its Applications 117 (2002), 335–344.
- [7] Ch. Bonatti, V. Grines, V. Medvedev, E. Pecou, *Topological classification of gradient-like diffeomorphisms on 3-manifolds*, Topology 43 (2004), 369–391.
- [8] Ch. Bonatti, V. Grines, O. Pochinka, *Classification of the Morse-Smale diffeomorphisms with the finite set of heteroclinic orbits on 3-manifolds*, Trudy math. inst. im. V. A. Steklova 250 (2005), 5–53.
- [9] Ch. Bonatti, V. Grines, O. Pochinka, *Classification of Morse-Smale diffeomorphisms with the chain of saddles on 3-manifolds*, 121–147 in: *Foliations 2005* World Scientific, Singapore, 2006.
- [10] A. Candel, *Laminations with transverse structure*, Topology 38 No 1 (1999), 141–165.
- [11] V. Grines, V. Medvedev, O. Pochinka, E. Zhuzhoma, *Global attractors and repellers for Morse-Smale diffeomorphisms*, Trudy math. inst. im. V. A. Steklova 271 (2010), 111–133.

- [12] V. Grines, O. Pochinka, *Morse-Smale cascades on 3-manifolds*, Russian Mathematical Surveys 68 No 1 (2013), 117–173.
- [13] V. Grines, T. Medvedev, O. Pochinka, *Dynamical Systems on 2- and 3-Manifolds*, Springer, 2016.
- [14] V. Grines, E. Zhuzhoma, V. Medvedev, *New relations for Morse-Smale systems with trivially embedded one dimensional separatrices*, Sbornik Math. 194 No 7 (2003), 979-1007.
- [15] E. Leontovich, *Some mathematical works of Gorky school of A. Andronov*, 116–125 in: *Proc. of the third All-Union mathematical congress V. 3*, 1958.
- [16] A. Mayer, *Rough map circle to circle*, Uch. Zap. GGU 12 (1939), 215–229.
- [17] E. Moise, *Geometric Topology In dimensions 2 and 3*, GTM 47, Springer, 1977.
- [18] J. Palis, *On Morse-Smale dynamical systems*, Topology 8 No 4 (1969), 385–404.
- [19] J. Palis, W. de Melo, *Geometrical theory of dynamical systems*, Mir, Moscow, 1998, Springer, 1982, ISBN: 978-1-4612-5703-5 (Online).
- [20] J. Palis, S. Smale, *Structural stability Theorems*, Proceedings of the Institute on Global Analysis, V. 14, 223–231, Amer. Math. Soc., 1970.
- [21] M. Peixoto, *On structural stability*, Ann. of Math. 69 No 1 (1959), 199–222.
- [22] M. Peixoto, *Structural stability on two-dimensional manifolds*, Topology 1 No 2 (1962), 101–120.
- [23] M. Peixoto, *Structural stability on two-dimensional manifolds (a further remarks)*, Topology 2 No 2 (1963), 179–180.
- [24] S. Smale, *Differentiable dynamical systems* Bull. Amer. Math. Soc. 73. No 6. (1967), 747–817.

address: Laboratoire de Topologie, UMR 5584 du CNRS, Dijon, France
email: bonatti@u-bourgogne.fr

address: National Research University Higher School of Economics, 603005, Russia, Nizhny Novgorod, B. Pecherskaya, 25
email: vgrines@yandex.ru

address: Université de Nantes, LMJL, UMR 6629 du CNRS, 44322 Nantes, France
email: francois.laudenbach@univ-nantes.fr

address: National Research University Higher School of Economics, 603005, Russia, Nizhny
Novgorod, B. Pecherskaya, 25
email: olga-pochinka@yandex.ru