

COMPUTING THE MINIMAL MODEL FOR THE QUANTUM SYMMETRIC ALGEBRA

DANIEL BARTER

ABSTRACT. In this note, we use some of the tensor categorical machinery developed by the quantum algebra community to study algebraic objects which appear in representation stability. In [SS16], Sam and Snowden prove that the twisted commutative algebra Sym is Morita equivalent to the horizontal strip category. Their proof relies on a lemma proved by Olver in [Olv87]. We give a self contained proof that replaces Olver's lemma with information about the associator in the underlying category of polynomial $\text{GL}(\infty)$ -representations. In fact, we prove a quantum analogue of the theorem. The classical version follows by letting the parameter converge to 1.

1. INTRODUCTION

Let \mathcal{S} be the category of polynomial $\text{GL}(\infty)$ -representations studied by Sam and Snowden in [SS16]. This category contains the algebra $\text{Sym} = \mathbb{C}[x_1, x_2, \dots]$ which is Morita equivalent to \mathbf{FI} , the category of finite sets with injections. A proof can be found in [SS17]. In Section 3 of [SS16], Sam and Snowden prove that Sym is Morita equivalent to \mathbf{HS} , the category whose objects are partitions and whose morphisms are defined by

$$\mathbf{HS}(\lambda, \mu) = \begin{cases} \mathbb{C}\{\mu \setminus \lambda\} & \lambda \subseteq \mu, \mu \setminus \lambda \in \mathbf{HS} \\ 0 & \text{otherwise} \end{cases}$$

Composition is defined as follows: Assume that $\mu \setminus \lambda$ and $\nu \setminus \mu$ are horizontal strips. If $\nu \setminus \lambda$ is a horizontal strip, then

$$(\nu \setminus \mu)(\mu \setminus \lambda) = \nu \setminus \lambda.$$

If $\nu \setminus \lambda$ is not a horizontal strip, then the composition is zero. Now let \mathcal{H} be the category of polynomial type 1 representations of $U_a(\mathfrak{gl}_\infty)$ defined in Definition 6. Inside \mathcal{H} , we have the quantum symmetric algebra QSym . In this chapter, we prove the following:

Theorem 1. *The quantum symmetric algebra QSym is Morita equivalent to \mathbf{HS} for generic a .*

Theorem 1 implies that many of the results in [SS16] which hold for Sym are also true for QSym .

The author would like to thank Corey Jones, Scott Morrison, Andrew Snowden and Phil Tosteson for many useful conversations and their support.

2. PRELIMINARIES

Definition 2. Let \mathbf{X} be a semi-simple tensor category. Index the simple objects with a set Λ . Choose a basis for each $\mathbf{X}(\mu, \lambda \otimes \nu)$ denoted by

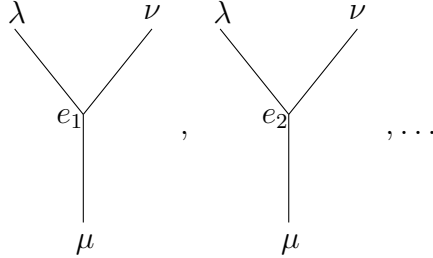

and let

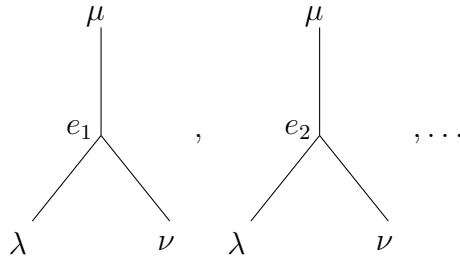

be the dual basis of $\mathbf{X}(\lambda \otimes \nu, \mu)$. We call these diagrams **trivalent vertices**. It is important to notice that trivalent vertices are not canonically defined.

Definition 3. Pick a distinguished simple object $X \in \mathbf{X}$. The **fusion graph** of X has vertices Λ and the edges from λ to μ are the distinguished basis vectors in $\mathbf{X}(\mu, \lambda \otimes X)$.

Proposition 4. Fix $\lambda \in \Lambda$. Then $\mathbf{X}(\lambda, X^{\otimes n})$ has dimension the number of paths from the tensor unit to λ in the fusion graph for X of length n . Moreover, an explicit basis is given by string diagrams of the form

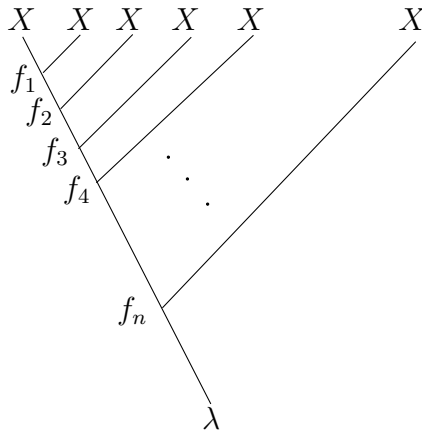

In this diagram, each f_i is a trivalent vertex of the form

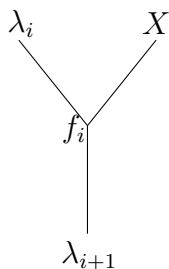

we call such string diagrams **trivalent basis vectors**

Proof. Decompose $X^{\otimes n}$ using the fusion graph for X . □

Definition 5. If \mathbf{X} is a semi-simple tensor category over \mathbb{C} with finite dimensional morphism spaces, the Artin-Wedderburn Theorem implies that $\text{End}(X^{\otimes n})$ is a product of matrix algebras. Proposition 4 implies that in the trivalent basis, the matrix units in $\text{End}(X^{\otimes n})$ look like

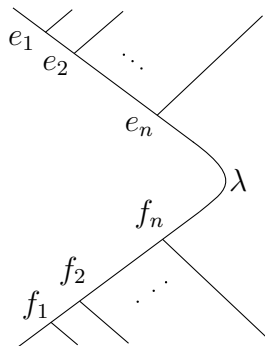

Equivalently, the irreducible representations of $\text{End}(X^{\otimes n})$ are parameterized by the simple objects in \mathbf{X} which have a length n path from the tensor unit in the fusion graph for X . The string diagrams defined in Proposition 4 form a basis for the corresponding representation.

Definition 6. The **Iwahori-Hecke algebra**, denoted by H_m , is the algebra generated over $\mathbb{C}(a)$ by $1, g_1, \dots, g_{m-1}$ subject to the relations

$$\begin{aligned} g_i g_{i+1} g_i &= g_{i+1} g_i g_{i+1} \\ g_i g_j &= g_j g_i \quad \text{if } |i - j| \geq 2 \\ g_i^2 &= (a - a^{-1})g_i + 1. \end{aligned}$$

We define the category H which has objects the natural numbers and morphisms

$$H(m, n) = \begin{cases} H_m & m = n \\ 0 & \text{otherwise.} \end{cases}$$

The inclusion $H_m \otimes H_n \rightarrow H_{m+n}$ defined by $g_i \otimes g_j \mapsto g_i g_{m+j}$ equips H with a tensor structure. We define $\mathcal{H} \subseteq [H^{\text{op}}, \mathbf{Vec}]$ to be the idempotent completion of H . The monoidal structure on H extends to \mathcal{H} via Day convolution. Morally, the category \mathcal{H} can be described as finite dimensional type 1 representations of the quantum group $U_a(\mathfrak{gl}_\infty)$. The Grothendieck ring for \mathcal{H} has basis given by partitions and multiplication given by the Littlewood-Richardson

rule. A special case of the Littlewood-Richardson rule is the Pieri rule:

$$\lambda \otimes \square = \sum_{\lambda \subset \mu \vdash n+1} \mu$$

This implies that the fusion graph for \square is Young's graph:

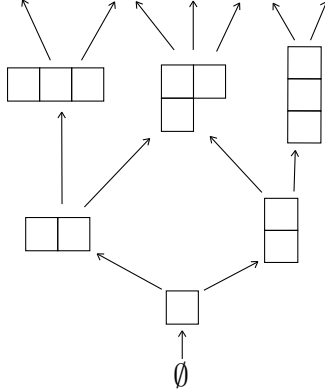

Paths in the Young graph are in bijection with standard partition fillings. It follows that the trivalent basis vectors

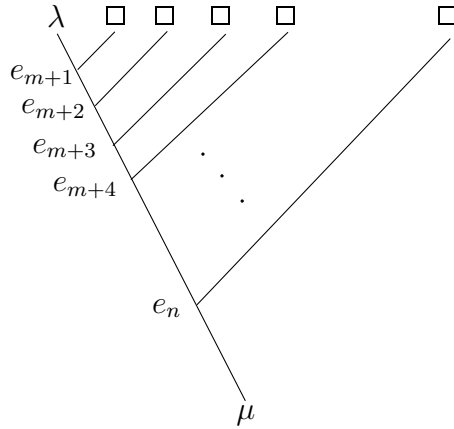

are in bijection (up to scaling) with standard skew tableaux of shape $\mu \setminus \lambda$. We abuse notation and identify these tree basis vectors with the corresponding standard skew tableaux. In [LR97], Ram and Leduc computed semi-normal forms for the Iwahori-Hecke algebras. More precisely, suppose that $\lambda \subseteq \mu \vdash n+2$ are partitions such that $\mu \setminus \lambda$ is not contained in a single row or column. Then there are exactly two partitions which satisfy $\lambda \subseteq \nu \subseteq \mu$. Call them ν and ν' . The multiplicity space $\mathcal{H}(\mu, \lambda \otimes \square \otimes \square)$ is 2-dimensional with basis

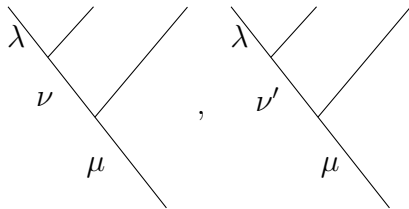

and g_1 acts via the matrix

$$m(g_1) = \begin{pmatrix} a^d/[d] & [d-1][d+1]/[d]^2 \\ 1 & a^{-d}/[-d] \end{pmatrix}$$

where

$$[n] = \frac{a^n - a^{-n}}{a - a^{-1}}$$

and $d = d_1 + d_2$ is the axial distance in $\mu \setminus \lambda$:

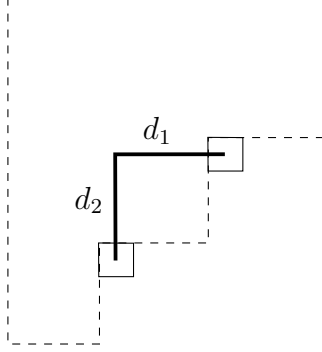

More formally, if $\mu \setminus \lambda$ contains the boxes $(a_1, b_1), (a_2, b_2)$, then the axial distance is defined by $d = |a_1 - a_2| + |b_1 - b_2|$. These formulas are quantum analogues of the well known Young semi-normal form for the representation theory of the symmetric group [JK81]. Indeed, when $a \rightarrow 1$, they recover they classical Young semi-normal formulas.

3. MORITA THEORY

In this section, we prove a very mild generalization of classical Morita theory. In classical Morita theory, we replace an object with its presentation with respect to a single projective. We are going to replace an object with its presentation with respect to a family of projectives. For the remainder of this section, \mathbf{X} is an abelian category enriched over \mathbf{Vec}_k , closed under colimits, \mathbf{D} is a category enriched over \mathbf{Vec}_k and $D : \mathbf{D}^{\text{op}} \rightarrow \mathbf{X}$ is a functor.

Theorem 7. *If \mathbf{X} has enough projectives, then \mathbf{X} is equivalent to the category of representations of \mathbf{D} where \mathbf{D}^{op} is a full subcategory of \mathbf{X} whose objects are compact, projective and generate \mathbf{X} .*

We can prove this in a very clean way using coends. They can be motivated as follows: Suppose that A is a k -algebra, M is a left A -module and N is a right A -module. Then we can form the tensor product $M \otimes_A N$ which is a vector space. It is built by taking the tensor product $M \otimes_k N$ and quotienting by the relations

$$am \otimes n = m \otimes na.$$

We can generalize the second step in the following way. Suppose that $F : \mathbf{D} \otimes_k \mathbf{D}^{\text{op}} \rightarrow \mathbf{Vec}_k$ is a bifunctor. Then we can form the vector space

$$\int^{d \in \mathbf{D}} F = \bigoplus_{d \in \mathbf{D}} F(d, d) / fv = vf \quad v \in F(d, d'), f : d' \rightarrow d.$$

This vector space is called the **coend** of F . We can use coends to generalize tensor products from modules to functors. Suppose that $F : \mathbf{D} \rightarrow \mathbf{Vec}$ and $G : \mathbf{D}^{\text{op}} \rightarrow \mathbf{Vec}$ are functors. Then we define

$$F \otimes_{\mathbf{D}} G = \int^{d \in \mathbf{D}} F(d) \otimes G(d).$$

A clear exposition of the theory of coends can be found in [Rie14]. Let \mathbf{D} a category enriched over \mathbf{Vec} . Suppose that we have a functor $D : \mathbf{D}^{\text{op}} \rightarrow \mathbf{X}$. Then we get a functor

$$\begin{aligned} \mathbf{X} &\rightarrow [\mathbf{D}, \mathbf{Vec}] \\ X &\mapsto \mathbf{X}(D(-), X) \end{aligned}$$

This functor has a left adjoint given by

$$\begin{aligned} [\mathbf{D}, \mathbf{Vec}] &\rightarrow \mathbf{X} \\ V &\mapsto V \otimes_{\mathbf{D}} D = \int^d V_d \otimes D^d \end{aligned}$$

The following computation demonstrates why these functors are adjoint:

$$\begin{aligned} \mathbf{X}(V \otimes_{\mathbf{D}} D, X) &= \mathbf{X}\left(\int^d V_d \otimes D^d, X\right) \\ &= \int_d \mathbf{X}(V_d \otimes D^d, X) \\ &= \int_d \text{hom}(V_d, \mathbf{X}(D^d, X)) \\ &= [\mathbf{D}, \mathbf{Vec}](V, \mathbf{X}(D(-), X)) \end{aligned}$$

Definition 8. We call $X \in \mathbf{X}$ a **compact** object if $\mathbf{X}(X, -)$ commutes with filtered colimits.

Proposition 9. *Assume that D is fully faithful and each $D(d)$ is projective and compact. Then $[\mathbf{D}, \mathbf{Vec}] \rightarrow \mathbf{X}$ is fully faithful.*

Proof. We need to prove that the unit

$$V \rightarrow \mathbf{X}(D(-), V \otimes_{\mathbf{D}} D)$$

is an isomorphism. It suffices to prove this pointwise, so we need to prove that the linear map

$$V(d) \rightarrow \mathbf{X}(D(d), V \otimes_{\mathbf{D}} D)$$

is an isomorphism. Since $D(d)$ is projective and compact, it follows that $\mathbf{X}(D(d), -)$ commutes with all colimits. Therefore

$$\begin{aligned} \mathbf{X}\left(D(d), \int^x V(x) \otimes D(x)\right) &= \int^x V(x) \otimes \mathbf{X}(D(d), D(x)) \\ &= \int^x V(x) \otimes \mathbf{D}(x, d) \\ &= V(d) \end{aligned}$$

The second equality is true because \mathbf{D} is fully faithful. □

Proposition 10. *In addition to the hypotheses of proposition 9, assume that every $X \in \mathbf{X}$ admits an epimorphism $\bigoplus_i D(d_i) \rightarrow X$ for some family $\{d_i\}$. Then $[\mathbf{D}, \mathbf{Vec}] \rightarrow \mathbf{X}$ is essentially surjective.*

Proof. By assumption, it follows that for every $X \in \mathbf{X}$, the counit

$$\mathbf{X}(D(-), X) \otimes_{\mathbf{D}} D \rightarrow X$$

is an epimorphism. Then we have an exact sequence

$$0 \rightarrow K \rightarrow \mathbf{X}(D(-), X) \otimes_{\mathbf{D}} D \rightarrow X \rightarrow 0$$

This gives us an exact sequence

$$\mathbf{X}(D(-), K) \otimes_{\mathbf{D}} D \rightarrow \mathbf{X}(D(-), X) \otimes_{\mathbf{D}} D \rightarrow X \rightarrow 0$$

Since $- \otimes_{\mathbf{D}} D$ is fully faithful, we can write the first map as $f \otimes_{\mathbf{D}} D$ for some map $f : \mathbf{X}(D(-), K) \rightarrow \mathbf{X}(D(-), X)$. Since $- \otimes_{\mathbf{D}} D$ is right exact, it follows that $X = \text{coker } f \otimes_{\mathbf{D}} D$. This proves essential surjectivity. \square

Proof of theorem 7. Let \mathbf{D}^{op} be a full subcategory of \mathbf{X} whose objects are compact, projective and generate \mathbf{X} . Let $D : \mathbf{D}^{\text{op}} \rightarrow \mathbf{X}$ be the embedding. By proposition, 9, the functor $- \otimes_{\mathbf{D}} D : [\mathbf{D}, \mathbf{Vec}] \rightarrow \mathbf{X}$ is fully faithful. By Proposition 10, the functor is essentially surjective. \square

Definition 11. If \mathbf{X} is an abelian category with enough compact projectives, define $M(\mathbf{X})$ to be the opposite of the full subcategory with objects the indecomposable compact projectives. We call $M(\mathbf{X})$ the **minimal model** for \mathbf{X} . By theorem 7, the functor category $[M(\mathbf{X}), \mathbf{Vec}]$ is equivalent to \mathbf{X} .

4. MODULES OVER TENSOR ALGEBRAS

In this section, we work inside a fixed semi-simple tensor category \mathcal{C} . We use Morita theory to study the category of modules over an algebra internal to \mathcal{C} . Choose a distinguished simple object $X \in \mathcal{C}$. Define

$$T = \bigoplus_{n \geq 0} X^{\otimes n}$$

This is the tensor algebra generated by X . Define $\text{Rep}(T)$ to be the category of right modules over T internal to \mathcal{C} . The forgetful functor $F : \text{Rep}(T) \rightarrow \mathcal{C}$ has left adjoint $L : \mathcal{C} \rightarrow \text{Rep}(T)$ defined by $V \mapsto V \otimes T$. Since the right adjoint F is exact, it follows that L preserves projectives. Define

$$T^+ = \bigoplus_{n \geq 1} X^{\otimes n}$$

Lemma 12. If $V \in \mathcal{C}$ is irreducible, then $V \otimes T$ is an indecomposable projective in $\text{Rep}(T)$.

Proof. Since $V \otimes T = L(V)$, the module is projective. Suppose that $V \otimes T = A \oplus B$ as T -modules. When we tensor with T/T^+ , we get

$$V = A/AT^+ \oplus B/BT^+$$

in \mathcal{C} . Since V is irreducible in \mathcal{C} , we can assume without loss of generality that $A/AT^+ = 0$. Suppose that $A \neq 0$. Choose $0 \neq Y \subseteq A \subseteq V \otimes T$ irreducible in \mathcal{C} . This implies that

$$Y \subseteq \bigoplus_{n=0}^N V \otimes X^{\otimes n}$$

for some large N . Since $A = A(T^+)^{N+1}$, it follows that

$$Y \subseteq A(T^+)^{N+1} \subseteq \bigoplus_{n \geq N+1} V \otimes X^{\otimes n}.$$

This implies that $Y = 0$, which is a contradiction. Therefore we must have $A = 0$. \square

Proposition 13. *Let G be the fusion graph for X considered as a category where the objects are vertices and the morphisms are paths. Then $\text{Rep}(T)$ is Morita equivalent to $[G, \mathbf{Vec}]$.*

Proof. The indecomposable compact projectives $\lambda \otimes T$, where λ is an irreducible in \mathcal{C} , generate $\text{Rep}(T)$. Using the adjunction $(L, F) : \text{Rep}(T) \rightarrow \mathcal{C}$, we have

$$\text{hom}_T(\mu \otimes T, \lambda \otimes T) = \mathcal{C}(\mu, \lambda \otimes T).$$

The right hand side has a basis consisting of vectors of the form

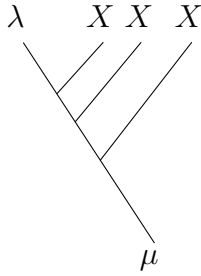

which is exactly a path in the fusion graph for X from λ to μ . Post composing with the corresponding morphism in $\text{hom}_T(\mu \otimes T, \lambda \otimes T)$ is the map

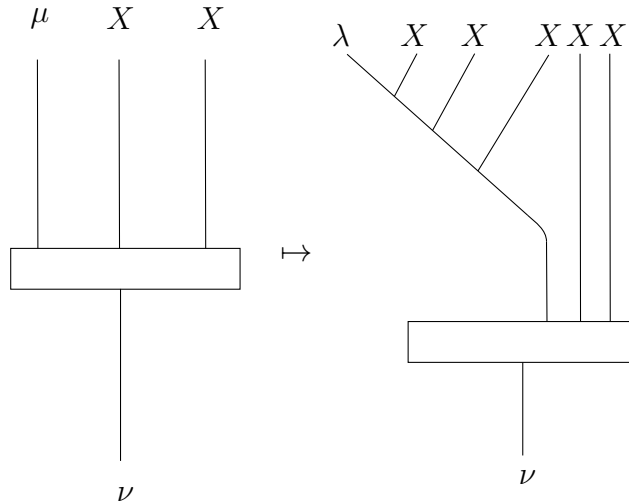

This implies that composition of basis vectors is exactly concatenation of paths in the fusion graph for X . This completes the proof. \square

Example 14. Let $\mathcal{C} = \mathcal{H}$, which was defined in Example 6, and let $X = \square$. The fusion graph for X has objects partitions and the edges $G(\lambda, \mu)$ are the standard skew tableaux of shape $\mu \setminus \lambda$.

5. MODULES OVER THE QUANTUM SYMMETRIC ALGEBRA

In this section, we work inside the category \mathcal{H} defined in Example 6. Define $T = \bigoplus_{n \geq 0} \square^{\otimes n}$. Consider the submodule I of T spanned by all maps

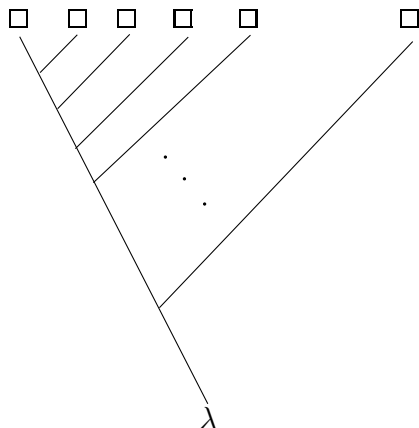

where λ is a partition with two or more rows. The grading on the Grothendieck ring implies that I is a 2-sided ideal in T , so we can form the quotient algebra $S = T/I$. We have

$$S = \emptyset \oplus \square \oplus \square\square \oplus \square\square\square \oplus \dots$$

Define $\text{Rep}(S)$ to be category of right modules over S internal to the category \mathcal{H} . Just like the tensor algebra, every projective S -module is free and the indecomposable projectives are of the form $\lambda \otimes S$ where λ is a partition. Define F to be the fusion graph for \square inside \mathcal{H} interpreted as a category. Define M to be the category whose objects are partitions and whose morphisms are defined by

$$M(\lambda, \mu) = \text{hom}_S(\mu \otimes S, \lambda \otimes S).$$

Then we have the functor $Q = - \otimes_T S : F \rightarrow M$. By definition, this functor is the identity on objects. Since all the projectives involved are free, it follows that Q is full. We can describe Q more concretely as follows. Each hom space in F is a skew representation of some Iwahori-Hecke algebra. We have:

Lemma 15. On morphisms, Q projects onto the Hecke algebra invariants.

Proof. Recall that given a vector $f \in F(\lambda, \mu)$, post composition by the induced map $\text{hom}_T(\mu \otimes T, \lambda \otimes T)$ is given by

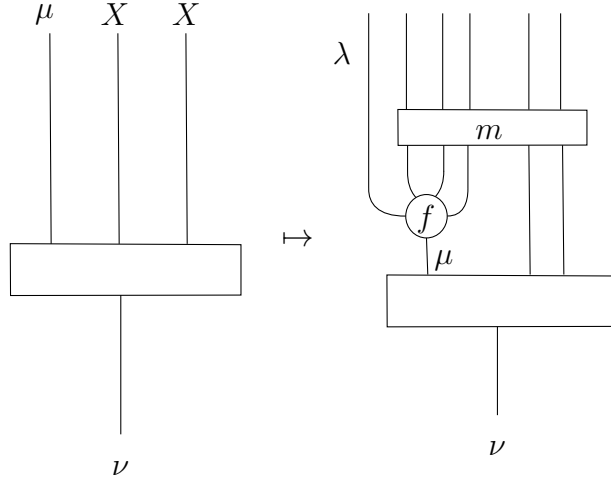

More precisely, the map $f : \mu \rightarrow \lambda \otimes X^{\otimes n}$ induces a map $\mu \otimes T \rightarrow \lambda \otimes T$ defined by

$$g : \mu \otimes T \xrightarrow{f \otimes 1} \lambda \otimes X^{\otimes n} \otimes T \xrightarrow{1 \otimes m} \lambda \otimes T$$

where m is the multiplication map. The diagram depicts post composing a map $\nu \rightarrow \mu \otimes T$ with g . By Yoneda's lemma, this determines g . If we tensor along the projection $p : T \rightarrow S$ we have

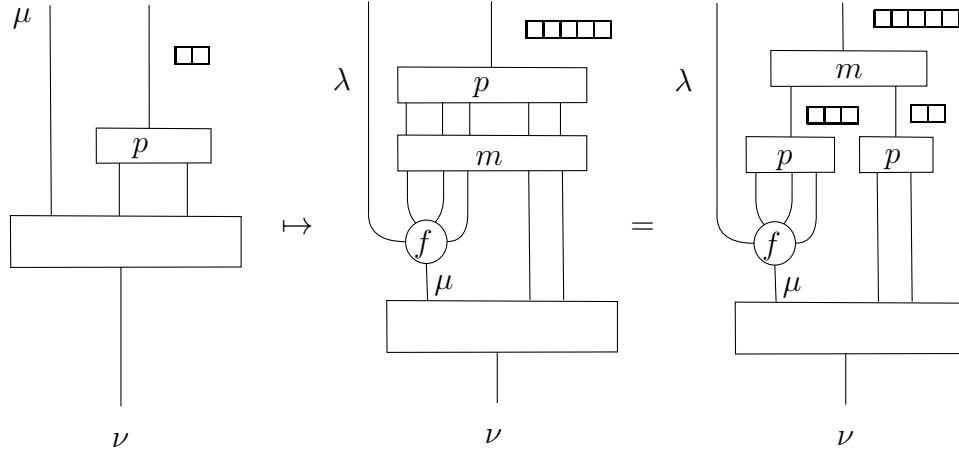

The second equality is true because p is an algebra homomorphism, so it commutes with multiplication. \square

Proposition 16. *Suppose that $\lambda \subseteq \mu$ are partitions. Then $\mathcal{H}(\mu, \lambda \otimes \square^{\otimes n})$ has Hecke algebra invariants if and only if $\mu \setminus \lambda$ is a horizontal strip. In this case, the invariants are 1-dimensional and any skew tableaux projects onto a nonzero invariant.*

Proof. The invariants in $\mathcal{H}(\mu, \lambda \otimes \square^{\otimes n})$ are the same as maps

$$\mu \rightarrow \lambda \otimes \underbrace{\square \square \square \square}_n$$

By Pieri's rule, $\mathcal{H}(\mu, \lambda \otimes \square^{\otimes n})$ has invariants if and only if $\mu \setminus \lambda$ is a horizontal strip. Suppose that $\mu \setminus \lambda$ is a horizontal strip and P is a skew tableau of shape $\mu \setminus \lambda$. Then from the semi-normal form, we know that P generates $\mathcal{H}(\mu, \lambda \otimes \square^{\otimes n})$. This implies that $\mathcal{H}(\mu, \lambda \otimes \square^{\otimes n})$ has a 1-dimensional space of invariants and P projects onto a nonzero invariant. \square

Proof of Theorem 1. The minimal model for S is M . From Lemma 15, $Q : F \rightarrow M$ is a full functor which is projection onto the Hecke algebra invariants. From Proposition 16, we have

$$M(\mu, \lambda) = F(\mu, \lambda)^{H_n} = \mathcal{H}(\mu, \lambda \otimes \square)^{H_n} = \mathbf{HS}(\mu, \lambda).$$

\square

REFERENCES

- [JK81] Gordon James and Adalbert Kerber. *The representation theory of the symmetric group*, volume 16 of *Encyclopedia of Mathematics and its Applications*. Addison-Wesley Publishing Co., Reading, Mass., 1981. With a foreword by P. M. Cohn, With an introduction by Gilbert de B. Robinson.
- [LR97] Robert Leduc and Arun Ram. A ribbon Hopf algebra approach to the irreducible representations of centralizer algebras: the Brauer, Birman-Wenzl, and type A Iwahori-Hecke algebras. *Adv. Math.*, 125(1):1–94, 1997.
- [Olv87] Peter J. Olver. Invariant theory and differential equations. In *Invariant theory*, volume 1278 of *Lecture Notes in Math.*, pages 62–80. Springer, Berlin, 1987.
- [Rie14] Emily Riehl. *Categorical homotopy theory*, volume 24 of *New Mathematical Monographs*. Cambridge University Press, Cambridge, 2014.
- [SS16] Steven V. Sam and Andrew Snowden. GL-equivariant modules over polynomial rings in infinitely many variables. *Trans. Amer. Math. Soc.*, 368(2):1097–1158, 2016.
- [SS17] Steven V. Sam and Andrew Snowden. Gröbner methods for representations of combinatorial categories. *J. Amer. Math. Soc.*, 30(1):159–203, 2017.