

# Dynamical Systems and Sheaves

David I. Spivak,\*    Christina Vasilakopoulou,\*    Patrick Schultz\*

December 9, 2024

## Abstract

A categorical framework for modeling and analyzing systems in a broad sense is proposed. These systems should be thought of as ‘machines’ with inputs and outputs, carrying some sort of signal that occurs through some notion of time. Special cases include discrete, continuous, and hybrid dynamical systems. A central goal is to understand the systems that result from arbitrary interconnection of component subsystems.

The fundamental categorical tools used here include lax functors out of monoidal categories, which provide a language of compositionality, as well as sheaf theory, which flexibly captures the crucial notion of time. Continuous- and discrete-time systems are related via functors, and a new sheaf-theoretic perspective on hybrid systems is proposed. A multitude of examples is offered in an appendix.

## Contents

<b>1</b>	<b>Introduction</b>	<b>2</b>
<b>2</b>	<b>Wiring diagrams and algebras</b>	<b>6</b>
2.1	Background on monoidal categories and operads . . . . .	7
2.2	The operad of labeled boxes and wiring diagrams . . . . .	9
2.3	Discrete and continuous dynamical systems . . . . .	13
<b>3</b>	<b>Interval sheaves</b>	<b>15</b>
3.1	The interval site <b>Int</b> . . . . .	16
3.2	<b>Int</b> -sheaves . . . . .	17
3.3	Synchronization . . . . .	21

---

\*Spivak, Vasilakopoulou, and Schultz were supported by AFOSR grant FA9550-14-1-0031 and NASA grant NNH13ZEA001N.

<b>4</b>	<b>Generalizations of Dynamical Systems</b>	<b>24</b>
4.1	Continuous machines . . . . .	25
4.2	Total, deterministic, and inertial machines . . . . .	27
4.3	Closure under feedback . . . . .	31
4.4	Discrete and synchronous variations . . . . .	33
4.5	Safety contracts . . . . .	35
<b>5</b>	<b>Comparing dynamical systems and machines</b>	<b>37</b>
5.1	Realizing dynamical systems as machines . . . . .	38
5.2	Maps between machines . . . . .	41
<b>A</b>	<b>Examples of Int-sheaves and machines</b>	<b>48</b>
A.1	Interval sheaves coming from spaces . . . . .	49
A.2	Hybrid sheaves . . . . .	50
A.3	From graphs to <b>Int</b> -sheaves . . . . .	54
A.4	Examples of machines . . . . .	56
<b>B</b>	<b>Discrete Conduché fibrations</b>	<b>58</b>
B.1	Johnstone coverage . . . . .	58
B.2	Comparing discrete fibrations, op-fibrations, and Conduché fibrations . . . . .	60
B.3	The equivalence $\widetilde{\mathbf{Int}} \cong \mathbf{DCF}/\mathcal{R}$ . . . . .	62
	<b>References</b>	<b>63</b>

## 1 Introduction

The broad goal of this paper is to suggest a solid categorical framework for modeling, understanding, and simulating systems of systems. While the current work is certainly theoretical, our ultimate interest is to make the case that category theory can be useful for modeling real-world systems. Cyber-physical systems, the Internet of Things (IoT), smart cities etc., provide examples of a technological paradigm—emerging in the 21st century—where the ‘mathematics of interconnection’ should play a major role. Hardware and software components, at scales from micro-processors to self-driving cars, may be put together in a myriad of novel arrangements. The interaction between these components is highly complex, and it is important to be able to describe and analyze the behavior that results from such interactions.

We refer to systems that take in, process, and send out material—broadly defined—as *open dynamical systems*. As a special case, one may consider a dynamical system that acts in isolation as a *closed dynamical system*. Since these do not interact with their environment (and thus are not very useful) we consider open systems as the general case. The complexity

level of (open) dynamical systems varies greatly; for example, they can be used to model anything from an electric circuit, to a chemistry experiment, to a robot.

Dynamical systems are designed to be interconnected: the material output by one system is sent to, and received by, another. For example, this notion generalizes the finite element and finite difference methods used for modeling partial differential equations, where a single PDE is considered as a network of interconnected ODEs. This notion also generalizes the networks of interconnected dynamical systems that emerge when considering systems of systems, such as the National Air Space.

Below we depict an interconnected system of five dynamical systems, which inhabit boxes  $X_1, \dots, X_5$ :

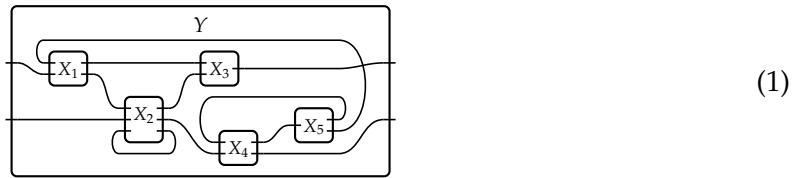

We refer to such an interaction pattern as a *wiring diagram*; it includes not only the five inner boxes, but also the outer box  $Y$  encapsulating the organized system. Wires represent channels by which material flows through the organization: either from one subsystem  $X_i$  to another, or into and out of their encapsulation  $Y$ . The idea is that a single dynamical system may arise by wiring together any number of component dynamical systems.

Systems theory studies the behavior of interconnected systems, offering multiple analyses. Analyzing a composite system is often intractable, because its complexity is generally exponential in the number of subsystems. Hence it is often crucial that the analysis be *compositional* [SY13] because such analyses can be applied to the subsystems independently, and the results composed.

Compositional analyses are robust to redesign. Large-scale systems are built from many component systems, each of which has many parts and subparts; improvements can arise from reconfiguring any one of these parts (see Figure 1) at any level of a hierarchy (which can itself be re-structured). Compositionality allows the reuse of the previously-computed intermediary results, facilitating design changes.

Category theory, and in particular the theory of operads, is an excellent formalism in which to study compositionality; this idea will be presented in detail, as it is a cornerstone for the present work. Wiring diagrams will be formalized as morphisms in an operad  $\mathcal{W}$ , e.g. (1) depicts a morphism  $\varphi: X_1, \dots, X_5 \rightarrow Y$  in  $\mathcal{W}$ . In this way, wiring diagrams become the algebraic operations for combining dynamical systems.

While we do not concentrate on applications specifically, they have certainly influenced our research. As an example, it is important to know whether a given system is deterministic or not, i.e. whether the system state could potentially evolve in more than one way, subject to the same input stream. One may also want to ensure that the system is total, meaning there is at least one state evolution that can occur for a given input stream. With our focus on systems of systems, we consider the above questions in terms of how they

compose. Feedback loops are the norm in a complex system, and these can break totality or determinism if care is not taken. We will provide necessary and sufficient conditions to ensure that totality and determinism are preserved under composition, even in the presence of feedback.

On a different note, a fundamental issue of this work is the notion of time. As mentioned above, each component in a system may send and receive ‘material’ of a very general sort: anything from integers and strings, to movies and computing applications, to chemicals and forces. To model this flow of material, including the internal processes of components themselves, we must decide whether changes are happening continuously, at discrete time steps, or in some combination.

Dynamical systems are often classified according to the sort of time by which material—be it physical or informational—flows through them. For a discrete dynamical system, the flow occurs on the ticks of a global clock; for continuous dynamical systems, it occurs continuously throughout intervals of time, and for hybrid dynamical systems, it occurs continuously but with discrete jumps that can happen at arbitrary moments.

Formalizing a notion of time is critical when co-designing multiple systems which need to interact. When different dynamical systems are integrated, their notions of time must be faithfully translated into a *lingua franca*, a common language or framework. On the other hand, there is no *best* notion of time: as a general rule, the more expressive a language is for describing systems, the more difficult it is to answer questions about those systems. While a large-scale system may require a very general sort of time, certain subsystems may require less generality and thus be more amenable to analysis.

In this paper we provide several notions of time and connections between them. These include discrete time, continuous time, and synchronized continuous time in which each moment is assigned a phase  $\theta \in [0, 1)$ . We do make certain commitments with regards to time: we consider time as occurring in intervals which have orientation and measure: a span of time has a beginning, an end, and a duration. Flows, signals, forces, etc. are all

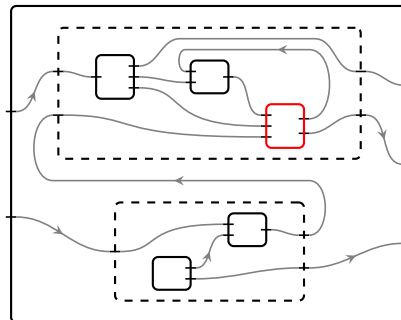

Figure 1: Compositional analyses facilitate the computation of global invariants, under rearrangement and replacement of internal components.

answers to the question of *what can possibly occur* over a time interval. Given a behavior  $B$  that can possibly occur over a time-interval  $[a, b]$ , and given a subinterval  $[a', b'] \subseteq [a, b]$ , the restriction  $B|_{[a', b']}$  of  $B$  must be a behavior (that can possibly occur) over the subinterval. This notion of restriction is combined with a notion of composing, or gluing. That is, compatible behaviors over two overlapping subintervals can be combined to produce a behavior over their union.

Together, these commitments can be formalized into various categories, depending on the exact meaning of the word “interval”—e.g. discrete or continuous—and some of these will be described in detail, though we concentrate most on continuous time. We will define a category  $\mathbf{Int}$ , whose objects are oriented subintervals of  $\mathbb{R}$ , and whose maps are orientation-preserving isometries. We will also define a coverage on  $\mathbf{Int}$ , giving it the structure of a *site* that encodes our notion of time. What we have been calling (continuous-time) behaviors are formalized as *sheaves* on this site. Replacing  $\mathbb{R}$  by  $\mathbb{Z}$ , we obtain a discrete notion of time.

While there are several examples of behaviors (i.e. sheaves on  $\mathbf{Int}$ ) and dynamical systems throughout the text, we include a good deal more in the appendix. Hopefully, these will help readers invent new dynamical systems and sheaves for themselves.

All of our models of time assume a common reference frame for time, so that all observers (components in the system) observe time to be progressing at the same rate. If one wants a more flexible model for non-interacting parallel subsystems (i.e. concurrency), or to allow for relativistic effects, our notion of  $\mathbf{Int}$ -sheaves would have to be replaced by a different formalism. For example, event structures [Win87] achieve this by removing any quantitative measure of time, keeping only a causality relation. However, they are only able to model discrete behaviors.

## Plan of the paper

We begin in Chapter 2 by discussing our general operadic framework for compositionality. We briefly review (colored) operads, recalling their relationship to monoidal categories as well as the notion of operad-algebras, before defining our operads of interest. All of these operads formalize boxes and wiring diagrams; the only difference between them is what flows on the wires. We give a few examples of algebras in which boxes are inhabited by dynamical systems, but for which wires carry only static information—the set of symbols or the space of parameters that drive the system—which turns out to be sufficient for defining composition.

We bring time into the picture in Chapter 3, where we define a site  $\mathbf{Int}$  of continuous time intervals.<sup>1</sup> We also define a site  $\mathbf{Int}_{\mathbb{N}}$  of discrete-time intervals for which the sheaf topos  $\widetilde{\mathbf{Int}}_{\mathbb{N}}$  is equivalent to the category  $\mathbf{Grph}$  of graphs. We provide a geometric morphism

<sup>1</sup>According to [Joh99], the topos  $\widetilde{\mathbf{Int}}$  of sheaves on  $\mathbf{Int}$  was studied by Lawvere in [Law86] for similar purposes, although we were not able to track down the preprint.

between  $\widetilde{\mathbf{Int}}_N$  and a slice topos  $\widetilde{\mathbf{Int}}/\text{Sync}$ , where  $\text{Sync}$  is a “synchronizing” sheaf whose sections can be thought of as phase shifts.

We define abstract dynamical systems, which we call *machines*, in Chapter 4. We prove that machines form an algebra on the wiring diagrams operad, as do various subclasses of machines, such as machines that are total and/or deterministic. As mentioned above, we must be a bit careful to define these notions so that they are indeed compositional. We also briefly discuss a notion of *safety contracts* for machines. These are local behavioral guarantees on a machine, which bound the set of output streams that can occur given a certain input stream.

In Chapter 5 we provide functors that translate between almost every combination of machines discussed previously. In particular, we convert our older, static definitions of discrete and continuous dynamical systems from Section 2.3 into our new language of time-based machines. We also give a high-level formalism for translating between various sorts of machines on various sorts of wiring diagram operads. We give sufficient conditions for these translations to preserve totality and determinism.

Finally, in the Appendix we include material that is not necessary for reading the paper. It includes two completely different parts. In Appendix A, we provide numerous examples of  $\mathbf{Int}$ -sheaves and machines. Here we also provide a construction of hybrid sheaves whose sections are sequences of continuous sections connected together by stochastic jumps. In Appendix B, we give an alternative categorical construction of the sheaf topos  $\widetilde{\mathbf{Int}}$ , namely as the category of *discrete Conduché fibrations* over the monoid of nonnegative real numbers. This equivalence (immediately derived from results in [Joh99]) gives two orthogonal viewpoints on the same objects: whereas for sheaves the basic structure (held by presheaves) is restriction and the extra property is gluing/composition, for discrete Conduché fibrations the basic property (held by categories) is gluing/composition and the extra property is restriction.

## Acknowledgments

We greatly appreciate our collaboration with Alberto Speranzon and Srivatsan Varadarajan, who have helped us to understand how the ideas presented here can be applied in practice (specifically for modeling the National Air Space) and who provided motivating examples with which to test and often augment the theory.

## 2 Wiring diagrams and algebras

This paper is about interconnecting machines in order to build more complex machines. The notion of building one object from many is nicely captured using operads and their algebras: an operad describes the ways ‘objects’ can be combined, and an algebra describes the ‘objects’ themselves. Each of the operads we use in this article will in fact underlie

a monoidal category. While we assume the reader has seen monoidal categories before, we review lax and strong functors between them, as well as their relationship to operads. Standard references include [JS93] and [Lei04].

In Section 2.2 we restrict our interest to a certain monoidal category  $\mathcal{W}$  (and its associated operad), studied in previous works like [VSL15; Spi15]. The objects and morphisms in  $\mathcal{W}$  classify a certain sort of string diagrams, which for reasons explained elsewhere [SSR16] we call wiring diagrams. Each algebra, i.e. functor  $\mathcal{W} \rightarrow \mathbf{Cat}$ , constitutes a semantics for wiring diagrams. In later sections of the paper we will give several examples, including discrete and continuous dynamical systems.

## 2.1 Background on monoidal categories and operads

Recall that a *lax monoidal* functor  $F: \mathcal{V} \rightarrow \mathcal{W}$  comes equipped with natural *structure morphisms*

$$F_{c,d}: F(c) \otimes_{\mathcal{W}} F(d) \rightarrow F(c \otimes_{\mathcal{V}} d) \quad \text{and} \quad F_I: I_{\mathcal{W}} \rightarrow F(I_{\mathcal{V}})$$

satisfying well-known coherence axioms; in particular for any  $n \in \mathbb{N}$  there is a canonical induced natural transformation with components

$$F_{c_1, \dots, c_n}: F(c_1) \otimes_{\mathcal{W}} \cdots \otimes_{\mathcal{W}} F(c_n) \rightarrow F(c_1 \otimes_{\mathcal{V}} \cdots \otimes_{\mathcal{V}} c_n).$$

The functor  $F$  is *strong monoidal* if these structure morphisms are isomorphisms. If the monoidal categories are symmetric, then  $F$  is *symmetric* if the structure maps appropriately commute with the symmetry isomorphisms. A *monoidal* natural transformation  $\alpha: F \Rightarrow G$  between monoidal functors is an ordinary natural transformation whose components furthermore commute with the structure morphisms.

We denote by  $\mathbf{SMC}_{\ell}$  the 2-category of symmetric monoidal categories, symmetric lax monoidal functors and monoidal natural transformations, and by  $\mathbf{SMC}_s$  the corresponding 2-category with strong monoidal functors.

*Remark 2.1.1.* If  $\mathcal{W}$  is a (finitely) complete category viewed as a cartesian monoidal category, i.e. if the tensor product is the usual categorical product, then  $\mathbf{SMC}_{\ell}(\mathcal{V}, \mathcal{W})$  is a (finitely) complete category. In particular, the product  $F \times G$  of two monoidal functors is given by  $(F \times G)c = Fc \times Gc$  with structure maps  $F_{c,d} \times G_{c,d}$  and  $F_I \times G_I$ .

Two fundamental examples of cartesian monoidal categories are  $(\mathbf{Set}, \times, \{*\})$  and  $(\mathbf{Cat}, \times, \mathbf{1})$ . In our context, we will often refer to lax monoidal functors  $\mathcal{V} \rightarrow \mathbf{Cat}$  as *(Cat-valued)  $\mathcal{V}$ -algebras*, and to monoidal natural transformations between them as  *$\mathcal{V}$ -algebra maps*; hence we denote  $\mathcal{V}\text{-Alg} := \mathbf{SMC}_{\ell}(\mathcal{V}, \mathbf{Cat})$ . The terminology comes from the closely-connected world of operads, to which we next turn.

Recall [Lei04, §2] that a *colored operad*, or *multicategory*,  $\mathcal{P}$  consists of a set of objects (colors)  $\text{ob } \mathcal{P}$ , a hom-set of  $n$ -ary operations  $\mathcal{P}(c_1, \dots, c_n; c)$  for each  $(n+1)$ -tuple of objects,

an identity operation  $\text{id}_c \in \mathcal{P}(c; c)$ , and a composition formula (see [Lei04, Fig. 2-B])

$$\mathcal{P}(c_1, \dots, c_n; c) \times \mathcal{P}(d_{1,1}, \dots, d_{1,k_1}; c_1) \times \dots \times \mathcal{P}(d_{n,1}, \dots, d_{n,k_n}; c_n) \rightarrow \mathcal{P}(d_{1,1}, \dots, d_{n,k_n}; c).$$

This data is subject to associativity and unitality axioms, and the operad is moreover *symmetric* if there are compatible permutation actions on the hom-sets,  $\mathcal{P}(c_1, \dots, c_n; c) \xrightarrow{\simeq} \mathcal{P}(c_{\sigma(1)}, \dots, c_{\sigma(n)}; c)$ . An *operad functor*  $F: \mathcal{P} \rightarrow \mathcal{P}'$  consists of a mapping on objects, and a mapping on hom-sets  $\mathcal{P}(c_1, \dots, c_n; c) \rightarrow \mathcal{P}'(Fc_1, \dots, Fc_n; Fc)$  that preserves composition, symmetries, and identities. An *operad transformation*  $\alpha: F \Rightarrow G$  consists of unary operations  $\alpha_c \in \mathcal{P}'(Fc; Gc)$  that are compatible with respect to the composition formula. Therefore we obtain a 2-category **SOpd**, often denoted **SMulticat** in the literature, of symmetric colored operads.

There exists a 2-functor, called the *underlying operad functor* ([Lei04, Example 2.1.3])

$$\mathcal{O}: \mathbf{SMC}_\ell \rightarrow \mathbf{SOpd} \quad (2)$$

mapping each symmetric monoidal category  $\mathcal{V}$  to the operad with  $\text{ob}(\mathcal{O}\mathcal{V}) := \text{ob } \mathcal{V}$  and  $\mathcal{O}\mathcal{V}(c_1, \dots, c_n; c) := \mathcal{V}(c_1 \otimes \dots \otimes c_n, c)$ . Note that for  $c = c_1 \otimes \dots \otimes c_n$ , there is a unique morphism in  $\mathcal{O}\mathcal{V}$  corresponding to  $\text{id}_c$ , called the *universal morphism* for  $(c_1, \dots, c_n)$ . Assigned to each lax monoidal functor  $F: \mathcal{V} \rightarrow \mathcal{W}$  is an operad functor  $\mathcal{O}F$  with the same mapping on objects; it sends the morphism  $f: c_1 \otimes \dots \otimes c_n \rightarrow c$  in  $\mathcal{V}$  to the composite

$$Fc_1 \otimes \dots \otimes Fc_n \xrightarrow{F_{c_1, \dots, c_n}} F(c_1 \otimes \dots \otimes c_n) \xrightarrow{Ff} Fc$$

in  $\mathcal{W}$ . Lastly, a monoidal natural transformation  $\alpha$  involves exactly the data needed to define the operad transformation  $\mathcal{O}\alpha$ .

The functor  $\mathcal{O}$  is clearly faithful, but it is also full: for any operad map  $G: \mathcal{O}\mathcal{V} \rightarrow \mathcal{O}\mathcal{W}$ , we can define a functor  $F: \mathcal{V} \rightarrow \mathcal{W}$  via the action of  $G$  on objects and unary morphisms, equipped with lax monoidal structure maps given by the action of  $G$  on universal morphisms. Moreover, there is also a bijection between the respective 2-cells, which exhibits  $\mathcal{O}$  as a fully faithful 2-functor; see [Her00, Remark 9.5] for relevant results. Not all operads underlie monoidal categories—the functor  $\mathcal{O}$  is not essentially surjective—however, all operads of interest in this paper do happen to be in the image of  $\mathcal{O}$ .

For typographical reasons, we denote the operad  $\mathcal{O}\mathbf{Cat}$  underlying the cartesian monoidal category of categories using the same symbol **Cat**, when no confusion arises. If  $\mathcal{P}$  is an operad, a (**Cat**-valued)  $\mathcal{P}$ -*algebra* is an operad functor  $\mathcal{P} \rightarrow \mathbf{Cat}$ . The category of  $\mathcal{P}$ -algebras is denoted  $\mathcal{P}\text{-Alg} := \mathbf{SOpd}(\mathcal{P}, \mathbf{Cat})$ ; see [Lei04, Def 2.1.12]. This nomenclature agrees with that above: for any monoidal category  $\mathcal{V}$ , the fully faithful  $\mathcal{O}$  induces an isomorphism between the corresponding categories of algebras

$$\mathcal{V}\text{-Alg} \xrightarrow{\simeq} (\mathcal{O}\mathcal{V})\text{-Alg}. \quad (3)$$



*Remark 2.1.2.* In this article, we will in fact work with pseudo-algebras  $A: \mathcal{W} \rightarrow \mathbf{Cat}$  for various monoidal categories  $\mathcal{W}$ . First, this means that  $A$  is a pseudo-functor: for pair of maps  $\psi, \phi$  in  $\mathcal{W}$ , we have only a natural isomorphism of functors  $A(\psi \circ \phi) \cong A(\psi) \circ A(\phi)$ , rather than a strict equality. Second the lax structure is pseudo, meaning any diagram which must commute as part of the axioms for lax functors must only commute up to natural isomorphism (with certain coherence conditions tying them together). Similarly, the maps between pseudo-algebras are monoidal pseudo-natural transformations.

Standard monoidal 2-category material as found for example in [DS97] (where the term *weak monoidal homomorphism* is used) define the category  $\mathbf{WMonHom}(\mathcal{A}, \mathcal{B})$  for monoidal 2-categories  $\mathcal{A}, \mathcal{B}$ , and there is an equivalence  $\mathcal{W}\text{-Alg} \simeq \mathbf{WMonHom}(\mathcal{W}, \mathbf{Cat})$ .

Due to coherence theorems, we can safely elide these details in the presentation below, to keep the already-technical material more readable. Thus we will speak of the pseudo-algebra  $A$  as above simply as a  $\mathcal{W}$ -algebra and the pseudo-maps between them simply as  $\mathcal{W}$ -algebra morphisms.

## 2.2 The operad of labeled boxes and wiring diagrams

Operads (or monoidal categories) of various ‘wiring diagram shapes’ have been considered in [Spi13; RS13]. More recently, [SSR16] showed a strong relationship between the category of algebras on a certain operad (namely **Cob**, the operad of oriented 1-dimensional cobordisms) and the category of traced monoidal categories; results along similar lines were proven in [Fon16]. The operads  $\mathcal{W}$  we use here are designed to model what could be called “cartesian traced categories without identities”.<sup>2</sup>

For any category  $\mathcal{C}$ , [Spi13] defined a  $\mathcal{C}$ -typed finite set to be a finite set  $X$  together with a function  $\tau: X \rightarrow \text{ob } \mathcal{C}$  assigning to every element  $x \in X$  an object  $\tau(x) \in \mathcal{C}$ , called its *type*. We often elide the typing function in notation, writing  $X$  rather than  $(X, \tau)$ . The  $\mathcal{C}$ -typed finite sets form a category  $\mathbf{TFS}_{\mathcal{C}}$ , where morphisms are functions  $f: X \rightarrow X'$  that respect the types, i.e.  $\tau(fx) = \tau(x)$ ; we call such an  $f$  a  $\mathcal{C}$ -typed function.<sup>3</sup> Thus we have

$$\mathbf{TFS}_{\mathcal{C}} \cong \mathbf{FinSet}/\text{ob } \mathcal{C}.$$

Notice that  $(\mathbf{TFS}_{\mathcal{C}}, +, \emptyset)$  is a cocartesian monoidal category:

$$(X, \tau) + (X', \tau') = (X + X', (\tau, \tau'))$$

where  $X + X'$  denotes the coproduct of sets and  $(\tau, \tau')$  denotes the co-pairing of functions.

<sup>2</sup>The reason to study traced categories without identities is that there is no “identity” dynamical system. Attempting to define such a thing, one loses the trace structure; similar problems arise throughout computer science and engineering applications: see [Age96; Sel97]. A solution to this problem was described in [ABP99], using trace ideals. The present operadic approach is another solution, which appears to be roughly equivalent.

<sup>3</sup>The category  $\mathbf{TFS}_{\mathcal{C}}$  of typed finite sets in  $\mathcal{C}$  is closely related to the *finite family fibration*  $\mathbf{Fam}(\mathcal{C}^{\text{op}}) \rightarrow \mathbf{FinSet}$  (see [Jac99, Definition 1.2.1]); namely  $\mathbf{TFS}_{\mathcal{C}}$  is the category of cartesian arrows in  $\mathbf{Fam}(\mathcal{C}^{\text{op}})$ , or equivalently cartesian arrows in  $\mathbf{Fam}(\mathcal{C})$ . Replacing  $\mathbf{TFS}_{\mathcal{C}}$  with  $\mathbf{Fam}(\mathcal{C}^{\text{op}})$  throughout the paper would yield similar definitions and results; for example, dependent product as in (4) is well-defined in this context,  $\prod: \mathbf{Fam}(\mathcal{C}^{\text{op}})^{\text{op}} \rightarrow \mathcal{C}$ .

Moreover, any functor  $F: \mathcal{C} \rightarrow \mathcal{D}$  induces a (symmetric strong monoidal) functor  $\mathbf{TFS}_F: \mathbf{TFS}_{\mathcal{C}} \rightarrow \mathbf{TFS}_{\mathcal{D}}$ , sending  $(X, \tau)$  to  $(X, F \circ \tau)$ . We have thus constructed a functor  $\mathbf{TFS}_{(-)}: \mathbf{Cat} \rightarrow \mathbf{SMC}_s$ .

If  $\mathcal{C}$  has finite products, then we can assign to each  $\mathcal{C}$ -typed finite set  $(X, \tau)$  its *dependent product*, denoted  $\widehat{X} \in \mathcal{C}$ :

$$\widehat{X} := \prod_{x \in X} \tau(x) \quad (4)$$

This induces a functor  $(-)_e: \mathbf{TFS}_{\mathcal{C}}^{\text{op}} \rightarrow \mathcal{C}$ , which is strong monoidal because there are isomorphisms  $\widehat{X}_1 \times \widehat{X}_2 \cong \widehat{X_1 + X_2}$  and  $\widehat{\emptyset} \cong 1$ . In fact, if  $\mathbf{FPCat}$  is the category of finite-product categories and functors which preserve them, and  $i: \mathbf{FPCat} \rightarrow \mathbf{SMC}_s$  realizes a finite-product category with its canonical cartesian monoidal structure, then the dependent product functors  $(-)_e$  are the components of a pseudonatural transformation

$$\begin{array}{ccc}
 & \mathbf{Cat} & \\
 \mathbf{FPCat} & \xrightarrow{\quad} & \mathbf{SMC}_s \\
 & \downarrow (-)_e & \\
 & \mathbf{SMC}_s & \\
 & \xleftarrow{i} & 
 \end{array}$$

where the ordinary category  $\mathbf{FPCat}$  and functor  $\mathbf{TFS}$  are viewed as 2-structures with the trivial 2-cells and mappings respectively.

*Example 2.2.1.* Typed finite sets will be used in the context of wiring diagrams; here we consider a few typing categories  $\mathcal{C}$  which are going to be used later. In general, if  $(X, \tau)$  is a typed finite set, we think of each element  $x \in X$  as a *port*. Its associated type  $\tau(x)$  specifies what sort of information passes through that port.

1. When  $\mathcal{C} = \mathbf{Set}$ , each port carries a *set* of possible signals. There is no notion of time. Ports of this type are relevant when specifying discrete dynamical systems.
2. When  $\mathcal{C} = \mathbf{Man}$ , (a small category equivalent to) the category of second-countable smooth manifolds and smooth maps between them, each port carries a manifold of possible signals, again without a notion of time. Ports of this type are relevant when specifying continuous dynamical systems: machines that behave according to (ordinary) differential equations on manifolds.
3. When  $\mathcal{C} = \widetilde{\mathbf{Int}}$ , the category of *interval sheaves* defined in Section 3.1, each port carries a very general kind of time-based signal. The two types of dynamical systems described above in terms of sets and manifolds can be translated into this language, at which point the time-based dynamics itself becomes evident. The topos of interval sheaves will be central in our construction of machines (see Chapter 4).

We are now in position to define a symmetric monoidal category  $(\mathcal{W}_{\mathcal{C}}, \oplus, 0)$  for any typing category  $\mathcal{C}$ , see [VSL15, §3] or [Spi15, §3.3]. Its objects will be called  $\mathcal{C}$ -labeled boxes; they are pairs  $X = (X^{\text{in}}, X^{\text{out}}) \in \mathbf{TFS}_{\mathcal{C}} \times \mathbf{TFS}_{\mathcal{C}}$  of  $\mathcal{C}$ -typed finite sets. We can picture such an

$X$  as



Here,  $X^{\text{in}} = \{a_1, \dots, a_m\}$  is the set of input ports, and  $X^{\text{out}} = \{b_1, \dots, b_n\}$  is the set of output ports. Each port  $a_i$  or  $b_j$  comes with its associated  $\mathcal{C}$ -type  $\tau(a_i)$  or  $\tau(b_j) \in \mathcal{C}$ , though we often elide this for typographical reasons.

A morphism  $\phi: X \rightarrow Y$  in  $\mathcal{W}_{\mathcal{C}}$  is called a *wiring diagram*. It consists of a pair of  $\mathcal{C}$ -typed functions

$$\begin{cases} \phi^{\text{in}}: X^{\text{in}} \rightarrow X^{\text{out}} + Y^{\text{in}} \\ \phi^{\text{out}}: Y^{\text{out}} \rightarrow X^{\text{out}} \end{cases} \quad (6)$$

which express ‘which port is fed information by which’. Graphically, we can picture such a map  $\phi$ , going from the inside box  $X$  to the outside box  $Y$ , as

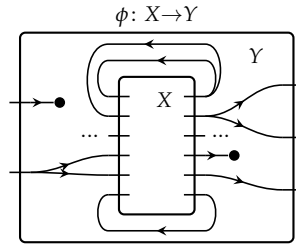

The identity wiring diagram  $1_X = (1_X^{\text{in}}: X^{\text{in}} \rightarrow X^{\text{out}} + X^{\text{in}}, 1_X^{\text{out}}: X^{\text{out}} \rightarrow X^{\text{out}})$  is given by the coproduct inclusion and identity respectively. Given another wiring diagram  $\psi = (\psi^{\text{in}}, \psi^{\text{out}}): Y \rightarrow Z$ , their composite  $\psi \circ \phi =: \omega = (\omega^{\text{in}}, \omega^{\text{out}})$  in  $\mathcal{W}_{\mathcal{C}}$  given by the composites in  $\mathbf{TFS}_{\mathcal{C}}$ :

$$\begin{aligned} \omega^{\text{in}}: X^{\text{in}} &\xrightarrow{\phi^{\text{in}}} X^{\text{out}} + Y^{\text{in}} \xrightarrow{\psi^{\text{in}}} X^{\text{out}} + Y^{\text{out}} + Z^{\text{in}} \xrightarrow{\psi^{\text{out}}} X^{\text{out}} + Z^{\text{in}} \\ \omega^{\text{out}}: Z^{\text{out}} &\xrightarrow{\psi^{\text{out}}} Y^{\text{out}} \xrightarrow{\phi^{\text{out}}} X^{\text{out}} \end{aligned}$$

Associativity and unitality is straightforward; see [Spi15, Def 3.10] for details.

There is a monoidal structure on  $\mathcal{W}_{\mathcal{C}}$ , where the tensor product given by  $X_1 \oplus X_2 = (X_1^{\text{in}} + X_2^{\text{in}}, X_1^{\text{out}} + X_2^{\text{out}})$  amounts to parallel composition

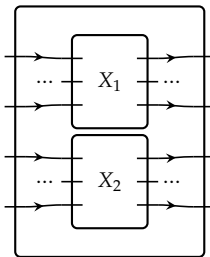

and the monoidal unit is  $0 = (\emptyset, \emptyset)$ .

**Definition 2.2.2.** We refer to the monoidal category  $\mathcal{W}_{\mathcal{C}}$ , defined above, as the category of  $\mathcal{C}$ -labeled boxes and wiring diagrams.

Now suppose that the typing category  $\mathcal{C}$  has finite products. By forming the dependent products  $\widehat{X}^{\text{in}} = \prod_{x \in X^{\text{in}}} \tau(x)$  and  $\widehat{X}^{\text{out}} = \prod_{x \in X^{\text{out}}} \tau(x)$  as in (4), we can associate to the entire input side (all the ports) a single object  $\widehat{X}^{\text{in}} \in \mathcal{C}$ , and similarly associate  $\widehat{X}^{\text{out}} \in \mathcal{C}$  to the entire output side. Since the dependent product functor is contravariant and strong monoidal, a wiring diagram  $\phi = (\phi^{\text{in}}, \phi^{\text{out}})$  induces two morphisms in  $\mathcal{C}$

$$\left\{ \begin{array}{l} \widehat{\phi}^{\text{in}}: \widehat{Y}^{\text{in}} \times \widehat{X}^{\text{out}} \rightarrow \widehat{X}^{\text{in}} \\ \widehat{\phi}^{\text{out}}: \widehat{X}^{\text{out}} \rightarrow \widehat{Y}^{\text{out}} \end{array} \right. \quad (7)$$

Together, these intuitively describe the direction of information flow in the wiring diagram.

An arbitrary functor  $F: \mathcal{C} \rightarrow \mathcal{D}$  induces a strong monoidal functor  $\mathcal{W}_F: \mathcal{W}_{\mathcal{C}} \rightarrow \mathcal{W}_{\mathcal{D}}$ . Its action on objects sends  $X = ((X^{\text{in}}, \tau^{\text{in}}), (X^{\text{out}}, \tau^{\text{out}}))$  to  $\mathcal{W}_F(X) = ((X^{\text{in}}, F \circ \tau^{\text{in}}), (X^{\text{out}}, F \circ \tau^{\text{out}}))$  which consists of the same finite set of input and output ports, but with new typing functions defined by  $F$ . The action of  $\mathcal{W}_F$  on morphisms is even more straightforward, and we thus have a strict functor

$$\mathcal{W}_{(-)}: \mathbf{Cat} \rightarrow \mathbf{SMC}_s \quad (8)$$

Even though this is defined on arbitrary categories and functors, it turns out that in many of the algebra maps which will later be considered, using dependent products (4) and pullbacks is essential; thus we often restrict to finitely complete categories  $\mathbf{FCCat} \rightarrow \mathbf{Cat}$  as the domain of  $\mathcal{W}_{(-)}$ , e.g. see Proposition 5.2.1.

As in Example 2.2.1, some labeling categories we will use include  $\mathbf{Set}$ ,  $\mathbf{Euc}$ , and  $\widetilde{\mathbf{Int}}$ , with associated wiring diagram categories  $\mathcal{W}_{\mathbf{Set}}$ ,  $\mathcal{W}_{\mathbf{Euc}}$  and  $\mathcal{W}_{\widetilde{\mathbf{Int}}}$ . An example of an induced strong monoidal functor is given by the limit-preserving  $U: \mathbf{Euc} \rightarrow \mathbf{Set}$  which maps a Euclidean space to its underlying set, inducing the strong functor

$$\mathcal{W}_U: \mathcal{W}_{\mathbf{Euc}} \rightarrow \mathcal{W}_{\mathbf{Set}} \quad (9)$$

between the respective categories of wiring diagrams.

If we apply the underlying operad functor (2) to any monoidal category  $\mathcal{W}_{\mathcal{C}}$ , we obtain the operad of wiring diagrams  $\mathcal{O}\mathcal{W}_{\mathcal{C}}$ . In what follows, our goal is to model various processes as objects of  $(\mathcal{O}\mathcal{W}_{\mathcal{C}})\text{-Alg}$ , i.e. algebras for this operad. Due to the isomorphism (3) between algebras for a monoidal category and its underlying operad, we can identify such an operad algebra with a lax monoidal functor from  $(\mathcal{W}_{\mathcal{C}}, +, 0)$  to  $(\mathbf{Cat}, \times, \mathbf{1})$ . As mentioned in Section 2.1, we will refer to lax monoidal functors  $\mathcal{W}_{\mathcal{C}} \rightarrow \mathbf{Cat}$  as  $\mathcal{W}_{\mathcal{C}}\text{-algebras}$ .

Given a  $\mathcal{W}_{\mathcal{C}}$ -algebra  $F: \mathcal{W}_{\mathcal{C}} \rightarrow \mathbf{Cat}$  and an object  $X \in \mathcal{W}_{\mathcal{C}}$ , we refer to the objects of the category  $F(X)$  as *inhabitants* of the box  $X$ . An algebra provides semantics to the boxes (5), examples of which we will encounter at Section 2.3 as well as Chapter 4. Whereas the formal description of the algebras will be completely in terms of lax monoidal functors, having an associated operadic interpretation provides meaningful pictorial representations;

for example, a 5-ary morphism  $\phi \in \mathcal{OW}(X_1, \dots, X_5; Y)$  in the operad of wiring diagrams can be drawn as follows:

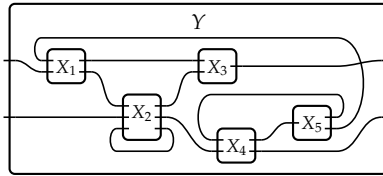

(10)

An algebra  $F$  constructs an inhabitant of the outside box, given inhabitants of each inside box and the wiring diagram  $\phi$ , thus associating a sort of *composition formula* to  $\phi$ . Indeed, for any algebra  $F: \mathcal{W}_c \rightarrow \mathbf{Cat}$ , the composite functor

$$F(X_1) \times \dots \times F(X_5) \xrightarrow{F_{X_1, \dots, X_5}} F(X_1 + \dots + X_5) \xrightarrow{F(\phi)} F(Y) \quad (11)$$

performs the following two steps. The  $F$ -inhabitants of five boxes  $X_1, \dots, X_5$  are first combined—using the lax structure morphisms of  $F$ —to form a single inhabitant of the parallel composite box  $X := X_1 + \dots + X_5$ . The wiring diagram  $\phi$  can then be considered 1-ary, and the functor  $F(\phi)$  converts the inhabitant of  $X$  to an inhabitant of the outer box  $Y$ . A similar story holds for morphisms between inhabitants.

*Remark 2.2.3.* Through all examples of  $\mathcal{W}_c$ -algebras  $F: \mathcal{W}_c \rightarrow \mathbf{Cat}$  found in this paper, a pattern arises:  $\mathcal{C}$  will be a finitely complete category, and we always begin by taking dependent products, as in (7). That is, all of our example  $F$ 's factor as

$$\begin{array}{ccc} \mathcal{W}_c & \xrightarrow{F} & \mathbf{Cat} \\ & \searrow_{X \mapsto \widehat{X}} & \nearrow_{\bar{F}} \\ & & \bar{\mathcal{W}}_c \end{array}$$

where  $\bar{\mathcal{W}}_c$  is the monoidal category with objects  $\text{ob}(\mathcal{C} \times \mathcal{C})$ , and morphisms  $(A_1, B_1) \rightarrow (A_2, B_2)$  pairs of  $\mathcal{C}$ -morphisms

$$\begin{cases} f: A_2 \times B_1 \rightarrow A_1 \\ g: B_1 \rightarrow B_2 \end{cases}$$

with appropriate composition and identities and the cartesian monoidal structure. The map  $\mathcal{W}_c \rightarrow \bar{\mathcal{W}}_c$  sends  $X = (X^{\text{in}}, X^{\text{out}}) \mapsto (\widehat{X}^{\text{in}}, \widehat{X}^{\text{out}})$ . We will never mention  $\bar{\mathcal{W}}_c$  again, though we often slightly abuse notation by writing  $F$  in place of  $\bar{F}$ .

### 2.3 Discrete and continuous dynamical systems

As our primary examples, we consider two well-known classes of dynamical systems, namely *discrete* and *continuous*, which have already been studied within the context of the operad of wiring diagrams in previous works; see e.g. [RS13; Spi15]. A broad goal of this paper is to group these, as well as other notions of systems, inside a generalized framework. This will be accomplished by constructing algebra maps from the special case systems, described in this section, to the abstracted ones, described in Chapter 5.

**Definition 2.3.1.** A discrete dynamical system with input set  $A$  and output set  $B$  consists of a set  $S$ , called the *state set*, together with two functions

$$\begin{cases} f^{\text{upd}}: A \times S \rightarrow S \\ f^{\text{rdt}}: S \rightarrow B \end{cases}$$

respectively called *update* and *readout functions*, which express the transition operation and the produced output of the machine. We refer to  $(S, f^{\text{upd}}, f^{\text{rdt}})$  as an  $(A, B)$ -discrete dynamical system or  $(A, B)$ -DDS. If additionally an element  $s_0 \in S$  is chosen, we refer to  $(S, s_0, f^{\text{upd}}, f^{\text{rdt}})$  as an *initialized*  $(A, B)$ -DDS.<sup>4</sup>

A morphism  $(S_1, f_1^{\text{upd}}, f_1^{\text{rdt}}) \rightarrow (S_2, f_2^{\text{upd}}, f_2^{\text{rdt}})$  of  $(A, B)$ -DDS's is a function  $h: S_1 \rightarrow S_2$  which commutes with the update and readout functions elementwise, i.e. with  $h(f_1^{\text{upd}}(s, x)) = f_2^{\text{upd}}(hs, x)$  and  $f_1^{\text{rdt}}(s) = f_2^{\text{rdt}}(hs)$ . We denote by  $\text{DDS}(A, B)$  the category of  $(A, B)$ -discrete dynamical systems.

We have now defined the on-objects part of a functor  $\text{DDS}: \mathcal{W}_{\text{Set}} \rightarrow \mathbf{Cat}$ , as in [Spi15, Def. 4.1,4.6,4.11]. That is, to an object  $X = (X^{\text{in}}, X^{\text{out}}) \in \mathcal{W}_{\text{Set}}$  we assign the category  $\text{DDS}(X) := \text{DDS}(\widehat{X^{\text{in}}}, \widehat{X^{\text{out}}})$  as defined above. To a morphism (wiring diagram)  $\phi: X \rightarrow Y$  (7) let  $\text{DDS}(\phi): \text{DDS}(X) \rightarrow \text{DDS}(Y)$  be the functor which sends the system  $(S, f^{\text{upd}}, f^{\text{rdt}}) \in \text{DDS}(X)$  to the system  $(S, g^{\text{upd}}, g^{\text{rdt}}) \in \text{DDS}(Y)$  having the same state set  $S$ , and new update and readout functions given by

$$g^{\text{upd}}(y, s) := f^{\text{upd}}(\phi^{\text{in}}(y, f^{\text{rdt}}(s)), s) \quad \text{and} \quad g^{\text{rdt}}(s) := \phi^{\text{out}}(f^{\text{rdt}}(s)) \quad (12)$$

The mapping  $\text{DDS}(\phi)$  preserves composition and identities in  $\mathcal{W}_{\text{Set}}$ . The lax monoidal structure is given by cartesian product: given  $F_1 = (S_1, f_1^{\text{upd}}, f_1^{\text{rdt}}) \in \text{DDS}(X_1)$  and  $F_2 = (S_2, f_2^{\text{upd}}, f_2^{\text{rdt}}) \in \text{DDS}(X_2)$ , we define  $F_1 \otimes F_2 \in \text{DDS}(X_1 + X_2)$  to be  $(S_1 \times S_2, f_1^{\text{upd}} \times f_2^{\text{upd}}, f_1^{\text{rdt}} \times f_2^{\text{rdt}})$ .

We have thus formally described a  $\mathcal{W}_{\text{Set}}$ -algebra, for which discrete dynamical systems are the objects inhabiting the boxes. Notice that the minor abuse of notation  $\text{DDS}(X) := \text{DDS}(\widehat{X^{\text{in}}}, \widehat{X^{\text{out}}})$  is explained by Remark 2.2.3. The algebra in Definition 2.3.1 is a prototype of many algebras throughout this paper, e.g. the abstract systems in Chapter 4. One will see strong similarities in what we describe next, the algebra of continuous dynamical systems (details on which can be found in [VSL15, §4] or [Spi15, §2.4]).

**Definition 2.3.2.** Let  $A, B$  be Euclidean spaces. An  $(A, B)$ -continuous dynamical system is a Euclidean space  $S$ , called the *state space*, equipped with smooth functions

$$\begin{cases} f^{\text{dyn}}: A \times S \rightarrow TS \\ f^{\text{rdt}}: S \rightarrow B \end{cases}$$

<sup>4</sup> Note that if  $A, B, S$  are finite, what we have called an initialized  $(A, B)$ -DDS is often called a *Moore machine*.

where  $TS$  is the tangent bundle of  $S$ , such that  $f^{\text{dyn}}$  commutes with the projections to  $S$ . That is,  $f^{\text{dyn}}(a, s) = (s, v)$  for some vector  $v$ ; it is standard notation to write  $(f^{\text{dyn}})_{a,s} := v$ . The maps  $f^{\text{dyn}}$  and  $f^{\text{rdt}}$  are respectively called the *dynamics* and *readout* functions. The first is an ordinary differential equation (with parameters in  $A$ ), and the second is an output function for the system.

A morphism of  $(A, B)$ -continuous dynamical systems  $(S_1, f_1^{\text{dyn}}, f_1^{\text{rdt}}) \rightarrow (S_2, f_2^{\text{dyn}}, f_2^{\text{rdt}})$  is a smooth map  $h: S_1 \rightarrow S_2$  such that  $h(f_1^{\text{upd}}(s, x)) = f_2^{\text{upd}}(hs, x)$  and  $f_1^{\text{rdt}}(s) = f_2^{\text{rdt}}(hs)$ . We denote by  $\text{CDS}(A, B)$  the category of  $(A, B)$ -continuous dynamical systems.

We have now defined the on-objects part of a functor  $\text{CDS}: \mathcal{W}_{\text{Euc}} \rightarrow \mathbf{Cat}$  as in [VSL15]. That is, to an object  $X = (X^{\text{in}}, X^{\text{out}})$  we assign the category  $\text{CDS}(X) := \text{CDS}(\widehat{X}^{\text{in}}, \widehat{X}^{\text{out}})$  as defined above. To a morphism  $\phi: X \rightarrow Y$ , let  $\text{CDS}(\phi): \text{CDS}(X) \rightarrow \text{CDS}(Y)$  be the functor which sends a continuous system  $(S, f^{\text{dyn}}, f^{\text{rdt}})$  to the continuous system  $(S, g^{\text{dyn}}, g^{\text{rdt}})$  where

$$g^{\text{dyn}}(y, s) := f^{\text{dyn}}(\phi^{\text{in}}(y, f^{\text{rdt}}(s)), s) \quad \text{and} \quad g^{\text{rdt}}(s) := \phi^{\text{out}}(f^{\text{rdt}}(s)) \quad (13)$$

Even though discrete and continuous dynamical systems have quite different notions of time and continuity, one can compare (12) and (13) to see that their algebraic structure (e.g. the action of wiring diagrams) is very similar. In [Spi15], one aspect of this similarity was summarized as follows.

**Proposition 2.3.3.** [Spi15, Theorem 4.26] *For each  $\epsilon > 0$ , we have a  $\mathcal{W}_{\text{Euc}}$ -algebra map*

$$\begin{array}{ccc} & \text{CDS} & \\ & \curvearrowright & \\ \mathcal{W}_{\text{Euc}} & & \mathbf{Cat} \\ & \Downarrow \alpha_\epsilon & \\ & \mathcal{W}_{\text{Set}} & \\ \mathcal{W}_U & \xrightarrow{\quad} & \text{DDS} \end{array}$$

where  $\mathcal{W}_U$  is as in (9) and  $\alpha_\epsilon$  is given by Euler's method of linear approximation.

Thus any continuous  $(A, B)$ -dynamical system  $(S, f^{\text{dyn}}, f^{\text{rdt}})$  gives rise to a discrete  $(UA, UB)$  dynamical system  $(US, f_\epsilon^{\text{upd}}, f_\epsilon^{\text{rdt}})$  with readout function  $f_\epsilon^{\text{rdt}} := Uf^{\text{rdt}}$  and with update function given by the linear combination of vectors  $f_\epsilon^{\text{upd}}(a, s) := s + \epsilon \cdot (f^{\text{dyn}})_{a,s}$ .

### 3 Interval sheaves

In this section, using standard material from topos theory found e.g. in [Joh02], we define a site  $\mathbf{Int}$ , whose objects can be considered as closed intervals of nonnegative length, and whose morphisms are inclusions of subintervals. A family of subintervals covers an interval if they are jointly surjective on points. We give several examples of sheaves on  $\mathbf{Int}$ , which we call *interval sheaves*, or sometimes *continuous interval sheaves*. We then elaborate on variations of this site, giving rise to *discrete* and *synchronous* interval sheaves; these ultimately correspond to different notions of time for our system models at Chapter 4.

Additional examples of  $\mathbf{Int}$ -sheaves are given in Appendix A, where in particular we discuss *hybrid* sheaves, which mix continuous and discrete behavior. In Appendix B we discuss an equivalence between the topos of  $\mathbf{Int}$ -sheaves and the category of *discrete Conduché fibrations* over the additive monoid of nonnegative real numbers, due to Peter Johnstone [Joh99].

### 3.1 The interval site $\mathbf{Int}$

Let  $\mathbb{R}_{\geq 0}$  denote the linearly ordered poset of nonnegative real numbers, and for any  $p \in \mathbb{R}_{\geq 0}$ , let  $\mathrm{Tr}_p: \mathbb{R}_{\geq 0} \rightarrow \mathbb{R}_{\geq 0}$  denote the translation-by- $p$  function  $\mathrm{Tr}_p(\ell) := p + \ell$ .

**Definition 3.1.1.** The category of *continuous intervals*, denoted  $\mathbf{Int}$ , is defined to have:

- objects  $\mathrm{ob} \mathbf{Int} = \{\ell \in \mathbb{R}_{\geq 0}\}$ ,
- morphisms  $\mathbf{Int}(\ell', \ell) = \{\mathrm{Tr}_p \mid p \in \mathbb{R}_{\geq 0} \text{ and } p \leq \ell - \ell'\}$ ,
- composition  $\mathrm{Tr}_p \circ \mathrm{Tr}_{p'} := \mathrm{Tr}_{p+p'}$ , and
- $\mathrm{id}_\ell = \mathrm{Tr}_0$ .

We will sometimes denote  $\mathrm{Tr}_p$  simply by  $p: \ell' \rightarrow \ell$ .

The category  $\mathbf{Int}$  above is the skeleton of (and hence equivalent to) the category whose objects are closed, positively-oriented intervals  $[a, b] \in \mathbb{R}$ , and whose morphisms are orientation-preserving isometries, i.e. translations by which one interval becomes a subinterval of another. Under the inclusion of the skeleton, an object  $\ell \in \mathbf{Int}$  is sent to the interval  $[0, \ell] \subseteq \mathbb{R}$ , and we can consider a map  $\mathrm{Tr}_p: \ell' \rightarrow \ell$  as a translation such that  $[0, \ell'] \cong [p, p + \ell'] \subseteq [0, \ell]$ :

$$\begin{array}{ccccccc} \longleftarrow & \lrcorner & \lrcorner & \lrcorner & \lrcorner & \lrcorner & \longrightarrow \\ & 0 & p & p + \ell' & & \ell & \end{array}$$

The following analogous definition is obtained by replacing  $\mathbb{R}_{\geq 0}$  by the linear order  $\mathbb{N}$  of natural numbers.

**Definition 3.1.2.** The category of *discrete intervals*  $\mathbf{Int}_{\mathbb{N}}$  has as objects the set of natural numbers,  $\mathrm{ob} \mathbf{Int}_{\mathbb{N}} = \{n \in \mathbb{N}\}$ , as morphisms  $n \rightarrow n'$  the set of translations  $\mathrm{Tr}_p$ , where  $p \in \mathbb{N}$  and  $p \leq n' - n$ . The composition and identities are given by  $+$  and  $0$ , as in Definition 3.1.1.

In what follows, fix  $\mathcal{R}$  (resp.  $\mathcal{N}$ ) to be the additive monoid of nonnegative real (resp. natural) numbers, viewed as a category with one object  $*$ . Proposition 3.1.4 gives a natural context for the interval categories  $\mathbf{Int}$  and  $\mathbf{Int}_{\mathbb{N}}$  from Definitions 3.1.1 and 3.1.2: they are the twisted arrow categories of  $\mathcal{R}$  and  $\mathcal{N}$  respectively.

**Definition 3.1.3.** [Joh99, §2] For any category  $\mathcal{C}$ , the *twisted arrow category* of  $\mathcal{C}$ , denoted  $\mathcal{C}_{\mathrm{tw}}$ , has morphisms of  $\mathcal{C}$  as objects, and for  $f: x \rightarrow y$  and  $g: w \rightarrow z$  in  $\mathcal{C}$ , a morphism  $f \rightarrow g$  in



$\mathcal{C}_{\text{tw}}$  is a pair  $(u, v)$  making the diagram commute:

$$\begin{array}{ccc} x & \xleftarrow{u} & w \\ f \downarrow & & \downarrow g \\ y & \xrightarrow{v} & z \end{array}$$

**Proposition 3.1.4.** *There is an isomorphism of categories*

$$\mathbf{Int} \cong \mathcal{R}_{\text{tw}} \quad \text{and} \quad \mathbf{Int}_N \cong \mathcal{N}_{\text{tw}}.$$

*Proof.* The objects of  $\mathcal{R}_{\text{tw}}$  are nonnegative real numbers  $\ell: * \rightarrow *$ , and a morphism  $\ell' \rightarrow \ell$  in  $\mathcal{R}_{\text{tw}}$  is a pair of nonnegative real numbers  $(p, q)$  such that  $p + \ell' + q = \ell$ . But  $q$  is completely determined by  $p, \ell$ , and  $\ell'$ , hence we can identify  $(p, q)$  with the morphism  $\text{Tr}_p: \ell' \rightarrow \ell$  of Definition 3.1.1. Similarly for the discrete intervals.  $\square$

**Notation 3.1.5.** Consider an **Int**-presheaf  $A: \mathbf{Int}^{\text{op}} \rightarrow \mathbf{Set}$ . For any continuous interval  $\ell$ , we refer to elements  $x \in A(\ell)$  as *sections of  $A$  on  $\ell$* . We refer to sections of length  $\ell = 0$  as *germs of  $A$* . For any section  $x \in A(\ell)$  and any map  $\text{Tr}_p: \ell' \rightarrow \ell$ , we write  $x|_{[p, p+\ell']}$  to denote the restriction  $A(\text{Tr}_p)(x) \in A(\ell')$ .

Certain classes of restrictions will come up often, so we create some special notation for them. For any  $0 \leq \ell' \leq \ell$ , we write  $\lambda_{\ell'}, \rho_{\ell'}: A(\ell) \rightarrow A(\ell')$  to denote the restrictions along the maps  $[0, \ell'] \subseteq [0, \ell]$  and  $[\ell - \ell', \ell] \subseteq [0, \ell]$  respectively. We refer to them as the *left* and *right* restrictions of length  $\ell'$ . In particular if  $\ell' = 0$ , we will often use the notation

$$\lambda_0(x) := x|_{[0,0]} \in A(0) \quad \text{and} \quad \rho_0(x) := x|_{[\ell,\ell]} \in A(0)$$

to denote the left and right endpoints of  $x$ . Similar notation applies to  $\mathbf{Int}_N$ .

We can graphically depict a section  $x$  on a continuous interval  $\ell \in \mathbf{Int}$ , together with a restriction, and a section  $y$  on a discrete interval  $n \in \mathbf{Int}_N$ , as

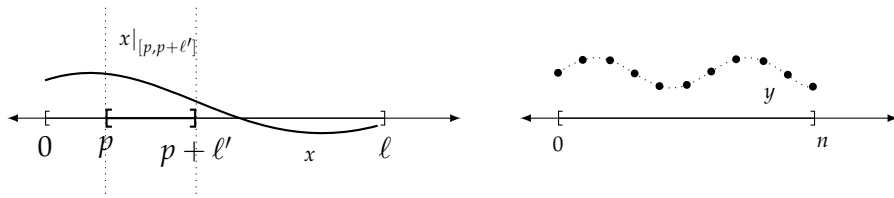

For a small category  $\mathcal{C}$  (such as  $\mathbf{Int}$  or  $\mathbf{Int}_N$ ), we denote the category of presheaves by  $\text{Psh}(\mathcal{C})$ .

## 3.2 Int-sheaves

We now wish to equip each of the categories  $\mathbf{Int}$  and  $\mathbf{Int}_N$  with a coverage. In [Joh99], Peter Johnstone defined such a coverage for certain twisted arrow categories  $\mathcal{C}_{\text{tw}}$ , of which  $\mathbf{Int}$  and  $\mathbf{Int}_N$  are special cases. For such  $\mathcal{C}$ , he proved that the category of sheaves on  $\mathcal{C}_{\text{tw}}$  is equivalent to the category of discrete Conduché fibrations over  $\mathcal{C}$ . While this perspective is interesting, we will postpone discussing it until Appendix B, so as to reduce the length of the main text. We proceed to define the coverage on  $\mathbf{Int}$  and  $\mathbf{Int}_N$  by hand.

**Definition 3.2.1.** For any interval  $\ell \in \mathbf{Int}$ , and any real number  $p \in [0, \ell]$ , we say that the pair of subintervals  $[0, p]$  and  $[p, \ell]$ , or more precisely the morphisms  $\text{Tr}_0: p \rightarrow \ell$  and  $\text{Tr}_p: (\ell - p) \rightarrow \ell$ , form a cover, which we call the *p-covering family* for  $\ell$ .

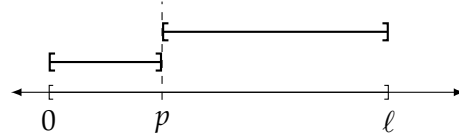

(Similarly, the pairs  $([0, p], [p, n])$  for any natural number  $p \in \{0, \dots, n\}$  form the *p-covering family* for  $n \in \mathbf{Int}_N$ .) It is not hard to show that this forms a coverage; see Corollary B.1.4.

If  $X$  is an  $\mathbf{Int}$ -presheaf, we say that sections  $x_1 \in X(\ell_1)$  and  $x_2 \in X(\ell_2)$  are *compatible* if the right endpoint of  $x_1$  matches the left endpoint of  $x_2$ , i.e. if  $\rho_0(x_1) = \lambda_0(x_2)$ . Thus  $X$  satisfies the sheaf axiom for the above coverage if, whenever  $x_1$  and  $x_2$  are compatible, there is a unique section  $x_1 * x_2 \in X(\ell_1 + \ell_2)$ , called the *gluing* of  $x_1$  and  $x_2$ , such that  $\lambda_{\ell_1}(x_1 * x_2) = x_1$  and  $\rho_{\ell_2}(x_1 * x_2) = x_2$ .

We refer to an  $\mathbf{Int}$ -presheaf satisfying the sheaf axiom as a *continuous interval sheaf*, or simply  $\mathbf{Int}$ -sheaf. We denote the full subcategory of  $\text{Psh}(\mathbf{Int})$  spanned by the sheaves by  $\widetilde{\mathbf{Int}}$ ; it has the structure of a topos. Similarly, we define *discrete interval sheaves* or  $\mathbf{Int}_N$ -sheaves and the topos  $\widetilde{\mathbf{Int}}_N$  thereof.

Each of the inclusions  $\widetilde{\mathbf{Int}} \subseteq \text{Psh}(\mathbf{Int})$  and  $\widetilde{\mathbf{Int}}_N \rightarrow \text{Psh}(\mathbf{Int}_N)$  has a left adjoint. In each case we denote it as  $\text{Sh}$  and call it the *associated sheaf* or *sheafification* functor.

The category of  $\mathbf{Int}$ -sheaves is certainly more complex than that of  $\mathbf{Int}_N$ -sheaves; indeed the latter is just the category of graphs.

**Proposition 3.2.2.** *There is an equivalence of categories  $\widetilde{\mathbf{Int}}_N \simeq \mathbf{Grph}$ , between the category of discrete interval sheaves and the category of graphs.*

*Proof.* To every sheaf  $X \in \widetilde{\mathbf{Int}}_N$ , we associate the graph  $G = (V, E, \text{src}, \text{tgt})$  with  $V := X(0)$ ,  $E := X(1)$ ,  $\text{src} := X(\text{Tr}_0)$ , and  $\text{tgt} := X(\text{Tr}_1)$ , where  $\text{Tr}_0, \text{Tr}_1: 0 \rightarrow 1$  are the two inclusions; see Definition 3.1.2. To every graph  $G$  we associate the  $\mathbf{Int}_N$ -sheaf  $\text{Path}(G)$  for which  $\text{Path}(G)(n)$  is the set of length- $n$  paths in  $G$  with the obvious restriction maps. This is indeed a sheaf because two paths match if the ending vertex of one is the starting vertex of the other, in which case the paths can be concatenated.

The above constructions are clearly functorial; we need to check that these functors are mutually inverse. The roundtrip functor for a graph  $G$  returns a graph with the length-0 and length-1 paths in  $G$ , which is clearly isomorphic to  $G$ . For an  $\mathbf{Int}_N$ -sheaf  $X$ , the roundtrip is again  $X$  because the coverage on  $\mathbf{Int}_N$  ensures that every section is completely determined by the length-0 and length-1 data.  $\square$

*Example 3.2.3.* We do not include many examples of  $\mathbf{Int}_N$ -sheaves, assuming the reader is familiar with graphs. However, we do give two examples which will be used later.

1. For any set  $S$ , consider the complete graph  $K(S) := (S \times S \rightrightarrows S) \in \mathbf{Grph}$ , having a vertex for each  $s \in S$  vertices and an edge from  $s \rightarrow s'$  for each  $(s, s') \in S \times S$ . By Proposition 3.2.2, there is a canonical way to view any graph  $G$  as an  $\mathbf{Int}_N$ -sheaf, under which  $K(S)$  becomes the  $\mathbf{Int}_N$ -sheaf whose length- $n$  sections are  $S$ -lists  $\langle s_0, \dots, s_n \rangle$  of length  $n + 1$ , namely  $K(S)(n) = S^{n+1}$ . This induces a functor  $K: \mathbf{Set} \rightarrow \widetilde{\mathbf{Int}}_N$ .
2. For any set  $Q$ , let  $\text{Loop}(Q)$  be the graph with one vertex and an edge (a loop) for each  $q \in Q$ ; that is,  $\text{Loop}(Q) = (Q \rightrightarrows \{*\})$ . This extends to a functor  $\text{Loop}: \mathbf{Set} \rightarrow \widetilde{\mathbf{Int}}_N$ .

*Example 3.2.4.* We collect some examples of  $\mathbf{Int}$ -sheaves that we will use in the main text; many more examples are included in Appendix A.

1. For any  $\ell \in \mathbf{Int}$ , we have the representable presheaf  $\text{Yon}_\ell = \text{Hom}_{\mathbf{Int}}(-, \ell)$ . For each object  $\ell'$  we have  $\text{Yon}_\ell(\ell') \cong \{p \in \mathbb{R}_{\geq 0} \mid p \leq \ell - \ell'\}$ , so in particular  $\text{Yon}_\ell(\ell') = \emptyset$  if  $\ell' \geq \ell$ . For each morphism  $\text{Tr}_q: \ell' \rightarrow \ell$  it assigns the function  $p \mapsto p + q$ . The coverage on  $\mathbf{Int}$  is sub-canonical, meaning that each representable presheaf is in fact a sheaf  $\text{Yon}_\ell \in \widetilde{\mathbf{Int}}$ .
2. For any set  $S$ , the sheaf of functions  $\text{Fnc}(S)$  assigns to each interval  $\ell$  the set of functions  $\text{Fnc}(S)(\ell) = \{f: [0, \ell] \rightarrow S\}$ , with the obvious restriction maps. The functor  $\text{Fnc}: \mathbf{Set} \rightarrow \widetilde{\mathbf{Int}}$  is a right adjoint.
3. For any set  $S$ , the constant sheaf  $\text{cnst}(S)$  is defined by  $\text{cnst}(S)(\ell) = S$  for any  $\ell \in \mathbf{Int}$ , and identity restrictions maps. The functor  $\text{cnst}: \mathbf{Set} \rightarrow \widetilde{\mathbf{Int}}$  is a left adjoint.
4. If  $X$  is  $C^n$ , there is a sheaf of  $C^n$  curves in  $X$ ; we just need to be careful with the length-0 sections. Define a sheaf  $C^n(X)$  of  $C^n$  curves through  $X$  by

$$C^n(X)(\ell) := \{(\epsilon, f) \mid \epsilon > 0, f \in C^n((-\epsilon, \ell + \epsilon), X)\} / \sim \quad (14)$$

where we set  $(\epsilon, f) \sim (\epsilon', f')$  if one is the restriction of the other, say  $f'|_{(-\epsilon, \ell + \epsilon)} = f$ . For  $\ell > 0$ , the closed interval  $[0, \ell]$  is a manifold with boundary, so in fact the isomorphism  $C^n(X) \cong \{f: [0, \ell] \rightarrow X \mid f \in C^n\}$  is the usual definition of continuously  $n$ -times differentiable functions out of  $[0, \ell]$ . However, (14) makes sense when  $\ell = 0$  also: it defines the set of  $n$ -jets in  $X$ . It should be emphasized that the length-0 sections of  $C^n(X)$  are not the points in  $X$ , so the notation  $C^n(X)$  could be considered misleading. However, it is the right definition to define a sheaf of  $C^n$  curves, because gluing two  $C^n$  curves whose endpoints have the same  $n$ -jet results in a  $C^n$  curve.

If  $m \leq n$ , there is a sheaf morphism  $C^n(X) \rightarrow C^m(X)$ .

5. For any nonnegative real  $s \in \mathbb{R}_{\geq 0}$ , the *scaling-by- $s$*  functor, denoted  $(\_ * s): \mathbf{Int} \rightarrow \mathbf{Int}$ , is given by sending  $\ell \mapsto \ell * s$ . It induces a *scaling-by- $s$*  functor  $(\_ * s): \widetilde{\mathbf{Int}} \rightarrow \widetilde{\mathbf{Int}}$ .
6. Let  $0, 1: \text{Yon}_0 \rightarrow \text{Yon}_1$  denote image under  $\text{Yon}: \mathbf{Int} \rightarrow \widetilde{\mathbf{Int}}$  of the left and right endpoint inclusions  $\text{Tr}_0, \text{Tr}_1: 0 \rightarrow 1$  in  $\mathbf{Int}$ . Then we define the *periodic synchronizing sheaf* to be the quotient  $\text{Sync} := \text{Yon}_1 / (0 = 1)$ . For an interval  $\ell$ , we may identify

$$\text{Sync}(\ell) \cong \mathbb{R}/\mathbb{Z} \cong \{0 \leq [\theta] < 1\}$$

where  $[\theta]$  denotes the equivalence class modulo  $\mathbb{Z}$  of  $\theta \in \mathbb{R}$  and may be called the *phase*. Given a subinterval  $\text{Tr}_p: \ell' \rightarrow \ell$ , we have  $\text{Sync}(\text{Tr}_p)(\theta) = [\theta + p]$ .

**Proposition 3.2.5.** *Consider the functor  $\text{Stk}_0: \widetilde{\mathbf{Int}} \rightarrow \mathbf{Set}$ , given by  $\text{Stk}_0(A) := A(0)$ . It is the inverse image of an essential geometric morphism*

$$\mathbf{Set} \begin{array}{c} \xrightarrow{(-) \cdot \text{Yon}_0} \\ \xleftarrow{\text{Stk}_0} \\ \xrightarrow{\text{Fnc}} \end{array} \widetilde{\mathbf{Int}}$$

i.e.  $\text{Stk}_0$  is an essential point of the topos  $\widetilde{\mathbf{Int}}$ .

*Proof.* The right adjoint of  $\text{Stk}_0$  is  $\text{Fnc}(-)$ , defined in Example 3.2.4, 2. The left adjoint of  $\text{Stk}_0$  sends  $S$  to the copower  $S \cdot \text{Yon}_0 \in \widetilde{\mathbf{Int}}$ , where  $\text{Yon}_0$  is as in Example 3.2.4, 1.  $\square$

### 3.2.1 Extensions of Int-sheaves

We conclude this section by discussing the notions of *extension* for a section and a sheaf, which will be of central importance in Chapter 4.

**Definition 3.2.6.** Let  $A \in \widetilde{\mathbf{Int}}$  be a sheaf, let  $a \in A(\ell)$  be a section, and suppose  $\epsilon \geq 0$ . If  $a' \in A(\ell + \epsilon)$  is a section with  $a'|_{[0,\ell]} = a$ , we call  $a'$  an  $\epsilon$ -*extension* of  $a$  and, if  $\epsilon > 0$ , we say that  $a$  has a *nontrivial extension*.

For any  $\epsilon \geq 0$ , we define the  $\epsilon$ -*extension sheaf*  $\text{Ext}_\epsilon(A)$  of  $A$  by assigning to  $\ell$  the set<sup>5</sup>

$$\text{Ext}_\epsilon(A)(\ell) := A(\ell + \epsilon)$$

induced by the functor  $\mathbf{Int} \rightarrow \mathbf{Int}$  sending  $\ell \mapsto \ell + \epsilon$  and  $\text{Tr}_p \mapsto \text{Tr}_p$ . This defines an endofunctor  $\text{Ext}_\epsilon: \widetilde{\mathbf{Int}} \rightarrow \widetilde{\mathbf{Int}}$ . For  $A \in \widetilde{\mathbf{Int}}$  there are two natural maps  $\lambda, \rho: \text{Ext}_\epsilon(A) \rightarrow A$ , defined by left and right restrictions as in Notation 3.1.5. That is, for  $x \in A(\ell + \epsilon)$  we have  $\lambda(x) := \lambda_\ell(x) = x|_{[0,\ell]}$  and  $\rho(x) := \rho_\ell(x) = x|_{[\epsilon,\ell+\epsilon]}$ .

Similarly for a discrete-interval sheaf  $A \in \widetilde{\mathbf{Int}}_{\mathbb{N}}$  and  $n \in \mathbb{N}$ , we define the extension sheaf  $\text{Ext}_n(A)$  and the natural transformations  $\lambda, \rho: \text{Ext}_n(A) \rightarrow A$ .

We collect a few lemmas that will be of use later.

**Lemma 3.2.2.** *For any  $\epsilon \geq 0$  the functor  $\text{Ext}_\epsilon: \widetilde{\mathbf{Int}} \rightarrow \widetilde{\mathbf{Int}}$  commutes with all limits.*

*Proof.* Limits in  $\widetilde{\mathbf{Int}}$  are taken pointwise.  $\square$

**Lemma 3.2.3.** *Suppose given a commutative triangle of  $\widetilde{\mathbf{Int}}$ -sheaves, where  $\lambda$  is as in Definition 3.2.6:*

$$\begin{array}{ccc} \text{Ext}_\epsilon S & \xrightarrow{h} & S' \\ & \searrow \lambda & \downarrow \lambda' \\ & & S \end{array}$$

<sup>5</sup>It should be clear that this functor  $\text{Ext}$  has nothing to do with the  $\text{Ext}$  functor from homological algebra.

Then  $h$  is an epimorphism (monomorphism) if and only if all components of the underlying presheaf morphism  $Uh$  are surjective (injective).

*Proof.* The functor  $U: \widetilde{\mathbf{Int}} \subseteq \mathbf{Psh}(\mathbf{Int})$  is faithful, so if  $h$  is any sheaf map and  $Uh$  is an epimorphism (monomorphism) then so is  $h$ . Since  $U$  is a right adjoint, it preserves monomorphisms.

Now suppose  $h$  is an epimorphism; we will show that  $h_\ell$  is a surjection, for any  $\ell \in \mathbf{Int}$ , so choose  $s' \in S'(\ell)$ . Recall that  $h$  being an epimorphism means that there exists a cover  $0 = \ell_0 \leq \dots \leq \ell_n = \ell$  such that each restriction  $s'_i := s'|_{[\ell_i, \ell_{i+1}]} = h_{\ell_{i+1} - \ell_i}(s_i)$  for some  $s_i \in \text{Ext}_\epsilon S(\ell_{i+1} - \ell_i)$ . We may assume  $n = 2$ . Since the  $s'_i$  are compatible in  $S'$  and since  $\lambda(s_i) = \lambda'(s'_i)$ , we have that  $\lambda(s_1)$  and  $\lambda(s_2)$  are compatible sections of  $S$ . Thus we can glue  $s := \lambda(s_1) * s_2 \in S(\ell_2 + \epsilon)$ , giving  $s \in \text{Ext}_\epsilon S(\ell)$  with  $h_\ell(s) = s'$ .  $\square$

### 3.3 Synchronization

For certain constructions that follow, it is essential that we compare the toposes  $\widetilde{\mathbf{Int}}_N$  and  $\widetilde{\mathbf{Int}}$ . Let  $i: \mathbf{Int}_N \rightarrow \mathbf{Int}$  be the evident inclusion. As we will see in Proposition 3.3.6, this functor leads to a geometric morphism of toposes, but not directly.

**Proposition 3.3.1.** *The functor  $i: \mathbf{Int}_N \rightarrow \mathbf{Int}$  preserves covering families, but it is not a site morphism because it is not covering flat.*

*Proof.* Clearly  $i$  preserves covering families, by Definition 3.2.1. Recall from [Kar04] that  $i$  is called *covering flat* if it satisfies the following condition: for any finite diagram  $D: I \rightarrow \mathbf{Int}_N$  and any cone  $T$  over  $i \circ D$  with vertex  $u$ ,

$$\begin{array}{ccc} I & \xrightarrow{D} & \mathbf{Int}_N \\ \downarrow ! & \uparrow T & \downarrow i \\ \{*\} & \xrightarrow{u} & \mathbf{Int} \end{array}$$

the sieve  $S := \{h: v \rightarrow u \mid T \circ h \text{ factors through the } i\text{-image of some cone over } D\}$  is a covering sieve for  $u$  in  $\mathbf{Int}$ . Take  $I = \{*\}$ , let  $D$  be the interval of length 1, choose  $u \in \mathbf{Int}$  such that  $0 < u < 1$ , and choose  $T: u \rightarrow 1$  to be  $\frac{1-u}{2}$ , the midpoint-preserving inclusion (all that matters in our choice of  $T$  is that neither of the maps  $\text{Tr}_0, \text{Tr}_1: 0 \rightarrow 1$  in  $\mathbf{Int}$  factor through  $T$ ). Then the sieve  $S$  is empty, and thus does not cover  $u$ .  $\square$

Although the inclusion  $i: \mathbf{Int}_N \rightarrow \mathbf{Int}$  is not a site morphism, the fact that it is covering-preserving is enough to deduce the following well-known fact. Let  $i^*: \mathbf{Psh}(\mathbf{Int}) \rightarrow \mathbf{Psh}(\mathbf{Int}_N)$  denote the functor given by pre-composing a presheaf  $X: \mathbf{Int}^{\text{op}} \rightarrow \mathbf{Set}$  with  $i^{\text{op}}$ , and let  $\text{asSh}$  denote the sheafification as in Definition 3.2.1.

**Proposition 3.3.2.** *The functor  $i: \mathbf{Int}_N \rightarrow \mathbf{Int}$  induces an adjunction  $\Sigma_i \dashv \Delta_i$  between sheaf toposes*

$$\begin{array}{ccc}
 \widetilde{\mathbf{Int}}_N & \begin{array}{c} \xrightarrow{\Sigma_i} \\ \perp \\ \xleftarrow{\Delta_i} \end{array} & \widetilde{\mathbf{Int}} \\
 \begin{array}{c} \uparrow \text{asSh} \\ \downarrow U \end{array} & & \begin{array}{c} \uparrow \text{asSh} \\ \downarrow U \end{array} \\
 \mathbf{Psh}(\mathbf{Int}_N) & \begin{array}{c} \xrightarrow{\text{Lan}_i} \\ \perp \\ \xleftarrow{i^*} \end{array} & \mathbf{Psh}(\mathbf{Int})
 \end{array} \tag{15}$$

such that  $U \circ \Delta_i = U \circ i^*$ , hence also  $\Sigma_i \circ \text{asSh} \cong \text{asSh} \circ \text{Lan}_i$ .

*Proof.* Because  $i$  preserves covers, the composite  $\widetilde{\mathbf{Int}} \xrightarrow{U} \mathbf{Psh}(\mathbf{Int}) \xrightarrow{i^*} \mathbf{Psh}(\mathbf{Int}_N)$  factors through  $\widetilde{\mathbf{Int}}_N$ , defining  $\Delta_i$ . Since  $U$  is fully faithful and has a left adjoint  $\text{asSh}$ , it can be seen that the composite  $\Sigma_i := \text{asSh} \circ \text{Lan}_i \circ U$  is left adjoint to  $\Delta_i$ .  $\square$

Proposition 3.3.1 implies that  $\Sigma_i \dashv \Delta_i$  is not in general a geometric morphism, e.g. as in [Joh02, C2.3.4]. In particular, the left adjoint  $\Sigma_i$  preserves neither the terminal object nor binary products. However, what is important for our purposes is to see that it preserves pullbacks; this will be deduced from a direct formula calculation for  $\Sigma_i$ . For any  $x \in \mathbb{R}$ , let  $\lfloor x \rfloor, \lceil x \rceil \in \mathbb{Z}$  denote the floor (resp. ceiling) of  $x$ , i.e. the largest integer  $\lfloor x \rfloor \leq x$  (resp. the smallest integer  $\lceil x \rceil \geq x$ ).

**Proposition 3.3.3.** *For any discrete-interval sheaf  $X \in \widetilde{\mathbf{Int}}_N$ , there is an isomorphism*

$$\Sigma_i X(\ell) \cong \bigsqcup_{r \in [0,1)} X(\lceil r + \ell \rceil) \tag{16}$$

Moreover,  $\Sigma_i$  commutes with the forgetful functor  $U$  in (15), i.e.  $U \circ \Sigma_i \cong \text{Lan}_i \circ U$ .

*Proof.* The pointwise left Kan extension  $C := \text{Lan}_i X$  is computed as a colimit (or a coend)

$$C(\ell) = \text{colim}_{\substack{n \in \mathbf{Int}_N \\ (i(n) \rightarrow \ell) \in \mathbf{Int}^{\text{op}}}} X(n) = \int^{n \in \mathbf{Int}_N} \mathbf{Int}^{\text{op}}(i(n), \ell) \times X(n) \tag{17}$$

The indexing category  $(i^{\text{op}} \downarrow \ell)$  is a poset with the property that every element maps to a unique maximal element. Such maximal elements correspond to maps  $r: \ell \rightarrow n$  in  $\mathbf{Int}$ , for which  $0 \leq r < 1$  and  $0 \leq n - (r + \ell) < 1$ , i.e.  $n = \lceil r + \ell \rceil$ .<sup>6</sup> Thus for each  $\ell$ , the set  $C(\ell)$  is exactly as in the formula (16): an element of  $C(\ell)$  is a pair  $(r, x)$ , where  $0 \leq r < 1$  and  $x \in X(n)$ . We need to show that  $C$  is a sheaf, but to do so we must better understand the restriction maps.

<sup>6</sup> Here is a picture of a map  $r: \ell \rightarrow n$  in  $\mathbf{Int}$ , where  $n = 6$ ,  $r = \frac{2}{3}$ , and  $r + \ell = \frac{11}{2}$ :

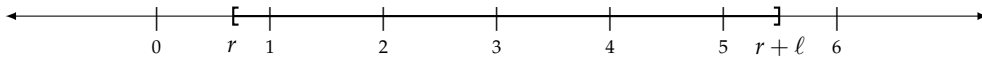

Given a map  $p: \ell' \rightarrow \ell$  and an element  $r \in [0, 1]$ , let  $a := \lfloor p + r \rfloor$ ,  $b := \lceil p + r + t' \rceil$ ,  $n' = b - a$ , and  $r' := p + r - a$ , so  $0 \leq r' < 1$ . We have  $a: n' \rightarrow n$  in  $\mathbf{Int}_N$  such that  $r \circ p = a \circ r'$ . (Adding the subinterval  $[p + r, p + r + \ell']$  to the picture in Footnote 6 may help with intuition.) Given a section  $x \in X(\lceil r + \ell \rceil)$ , the restriction map is given by

$$C(p)(r, x) = (r', x|_{[a, b]}).$$

Suppose given sections  $(r, x) \in C(\ell)$  and  $(r', x') \in C(\ell')$ , where  $x \in X(n)$  and  $x' \in X(n')$ . If they are compatible then, by the above restriction formula, we must have  $r' = t + r - \lfloor t + r \rfloor$

$$x|_{\lfloor t+r \rfloor, \lceil t+r \rceil} = (r, x)|_{[a, b]} = (r', x')|_{[0, 0]} = x'|_{\lfloor r' \rfloor, \lceil r' \rceil}.$$

If we denote by  $n_0$  the the length of this section, then  $n_0$  is either 0 or 1, depending on whether  $t + r = \lfloor t + r \rfloor$  or not. Either way,  $x$  and  $x'$  are compatible sections and can be glued to form  $x * x' \in X(n - n_0 + n')$ . Thus we have shown that  $C = \mathbf{Lan}_i X$  is a sheaf. It follows that  $U \circ \mathbf{asSh} \circ \mathbf{Lan}_i = \mathbf{Lan}_i$ , so  $U \circ \Sigma_i = \mathbf{Lan}_i \circ U$ .  $\square$

**Corollary 3.3.4.** *The functor  $\Sigma_i$  preserves pullbacks.*

*Proof.* The fact that  $\Sigma_i$  preserves pullbacks can be checked by hand; formally, it follows because the indexing category  $(i^{\text{op}} \downarrow \ell)$  in (17) is a coproduct of filtered categories, see [Adá+02, Ex. 1.3(vi)].  $\square$

*Remark 3.3.5.* Note that  $\Sigma_i$  can be regarded as a functor  $\Sigma_i: \mathbf{Grph} \rightarrow \widetilde{\mathbf{Int}}$  by Proposition 3.2.2. Using (17) one can check that the image of the single-vertex graph  $\blacksquare$  is the sheaf  $\mathbf{Yon}_0$  and that the image of the walking edge graph  $E = \blacksquare^{\bullet^0 \rightarrow \bullet^1}$  is  $\mathbf{Yon}_1$ . The terminal  $\mathbf{Int}_N$ -sheaf  $\mathbf{1}$  corresponds to the quotient graph  $E/(0 = 1)$ . Since  $\Sigma_i$  preserves colimits, we recover the synchronizing sheaf of Example 3.2.4, 6:

$$\Sigma_i(\mathbf{1}) \cong \mathbf{Sync}.$$

Our next goal is to compare the discrete-interval sheaf topos  $\widetilde{\mathbf{Int}}_N$  with the slice topos  $\widetilde{\mathbf{Int}}/\mathbf{Sync}$ , whose objects  $X \rightarrow \mathbf{Sync}$  we sometimes call *synchronous sheaves*; they are  $\mathbf{Int}$ -sheaves for which each section has been assigned a phase  $\theta \in [0, 1]$ . Intuitively, given a section  $x \in X(\ell)$ , we could say “ $x$  begins  $\theta$  seconds after a clock tick”.

**Proposition 3.3.6.** *The adjunction  $\Sigma_i \dashv \Delta_i: \widetilde{\mathbf{Int}} \rightarrow \widetilde{\mathbf{Int}}_N$  from Proposition 3.3.2 factors through a geometric morphism*

$$\widetilde{\mathbf{Int}}_N \begin{array}{c} \xrightarrow{\Sigma'_i} \\ \perp \\ \xleftarrow{\Delta'_i} \end{array} \widetilde{\mathbf{Int}}/\mathbf{Sync} \quad (18)$$

in which the left adjoint  $\Sigma'_i$  is fully faithful.

*Proof.* Define a functor  $\Sigma'_i$  which sends  $X \in \widetilde{\mathbf{Int}}_N$  to the synchronous sheaf  $\Sigma_i(X \xrightarrow{!} \mathbf{1})$ . Because  $\Sigma_i$  preserves pullbacks, it can be verified that  $\Sigma'_i$  preserves all finite limits.

We now construct its right adjoint. First note that  $\Delta_i: \widetilde{\mathbf{Int}} \rightarrow \widetilde{\mathbf{Int}}_N$  is given by pre-composing with the inclusion  $i: \mathbf{Int}_N \rightarrow \mathbf{Int}$ . Applying it to  $\text{Sync}$  results in the constant sheaf  $\Delta_i(\text{Sync}) \cong \text{cnst}(\mathbb{R}/\mathbb{Z}) \in \widetilde{\mathbf{Int}}_N$  by (16). Hence, given a synchronous sheaf  $Y \rightarrow \text{Sync}$ , define  $\Delta'_i(Y)$  to be the following pullback in  $\mathbf{Int}_N$ :

$$\begin{array}{ccc} \Delta'_i(Y) & \longrightarrow & \Delta_i(Y) \\ \downarrow & \lrcorner & \downarrow \\ \text{cnst}\{*\} & \xrightarrow{\text{cnst}(0)} & \Delta_i(\text{Sync}) \end{array}$$

Since  $\text{cnst}\{*\} \in \widetilde{\mathbf{Int}}_N$  is a terminal object, it follows immediately that  $\Delta'_i$  is right adjoint to  $\Sigma'_i$ .

The adjunction  $\Sigma_i \dashv \Delta_i$  can be verified to be the composite of  $\Sigma'_i \dashv \Delta'_i$  with the adjunction

$$\widetilde{\mathbf{Int}}/\text{Sync} \begin{array}{c} \xrightarrow{\Sigma_{\text{Sync}!}} \\ \perp \\ \xleftarrow{\Delta_{\text{Sync}!}} \end{array} \widetilde{\mathbf{Int}} \quad (19)$$

between slice categories as induced by the unique map  $\text{Sync}!: \text{Sync} \rightarrow \{*\}$  in  $\widetilde{\mathbf{Int}}$ . That is,  $\Sigma_{\text{Sync}!}(X \rightarrow \text{Sync}) = X$  and  $\Delta_{\text{Sync}!}(Y) = (Y \times \text{Sync} \rightarrow \text{Sync})$ . Finally, using Proposition 3.3.3, one checks that the unit  $\eta: X \rightarrow \Delta'_i \Sigma'_i X$  is an isomorphism, so  $\Sigma'_i$  is fully faithful.  $\square$

## 4 Generalizations of Dynamical Systems

In the remainder of the paper, our goal is to describe several sorts of machines in terms of interval sheaves; these machines take on many forms, from discrete and continuous dynamical systems to more general deterministic or total systems, to even more abstract objects which barely fit the description “machine”. What all these examples have in common is that a collection of machines can be interconnected to form a new machine, and this operation is coherent with respect to nesting of wiring diagrams. In other words, all of our machines will be algebras on an operad of wiring diagrams, as defined in Chapter 2. In Chapter 5, we will produce algebra maps that relate all of the various examples.

In this chapter, each machine will have an interface consisting of input and output ports. Each port carries a sheaf of “possible signal behaviors”. Thus we associate to each machine a box, here shown with just one input port and one output port, for simplicity:

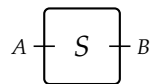

The possible behaviors of the whole machine—including what occurs on its ports—is also represented by a sheaf  $S$ .



We will consider various related notions. For example, we can restrict our attention to *total* processes, which have the property that for any initial state and compatible input behavior, there exists a compatible state evolution. We can also consider *deterministic* processes, which have the property that the state evolution is unique given any input. Total and discrete machines will be discussed in Section 4.2 and their closure under feedback will be proven in Section 4.3. We will see that while discrete dynamical systems as defined in Definition 2.3.1 are always both total and deterministic, this is not the case for continuous dynamical systems (basically because solutions to general ODEs on unbounded domains may not exist and may not be unique; see Remark 5.1.3). In Section 4.5 we will discuss another related notion, namely that of *contracts* on machines—which may or may not be satisfied by a given machine—that express behavioral guarantees in terms of inputs and outputs. We will show that contracts also form a wiring diagram algebra.

#### 4.1 Continuous machines

We begin with the most abstract notion of machine that we will use. It primarily serves the purpose of being all-inclusive, so that the various systems of interest can be seen as special cases. While such machines ostensibly have a notion of input and output, the definition is in fact symmetric, so it fits in with the work of [WP13].

**Definition 4.1.1.** Let  $A, B \in \widetilde{\mathbf{Int}}$  be continuous interval sheaves. A *continuous  $(A, B)$ -machine* is a span

$$\begin{array}{ccc} & S & \\ p^i \swarrow & & \searrow p^o \\ A & & B \end{array}$$

in the topos  $\widetilde{\mathbf{Int}}$ ; equivalently, it is a sheaf  $S$  together with a sheaf map  $p: S \rightarrow A \times B$ .

We refer to  $A$  as the *input sheaf*, to  $B$  as the *output sheaf*, and to  $S$  as the *state sheaf*. We call  $p^i$  the *input sheaf map* and  $p^o$  the *output sheaf map*. We denote by  $\mathbf{Mch}(A, B) := \widetilde{\mathbf{Int}}/(A \times B)$ , or sometimes by  $\mathbf{Mch}_C(A, B)$ , the topos of all continuous  $(A, B)$ -machines.

Suppose a continuous machine is in a state  $s_0 \in S(0)$  corresponding to a certain input  $a_0 := p^i(s_0) \in A(0)$ . If  $a_0$  is extended to some longer input behavior  $a \in A(\ell)$ , there may be a way to extend  $s_0$  to some state behavior  $s$  that accommodates input  $a$ , i.e. with  $p^i(s) = a$ . However, there may be more than one such extension, or none at all.

$$\begin{array}{ccc} s_0 & \xrightarrow{\text{dashed}} & s \\ \downarrow & & \downarrow \\ a_0 & \xrightarrow{\text{solid}} & a \\ 0 & & \ell \end{array} \quad \begin{array}{c} S(\ell) \\ \downarrow p^i \\ A(\ell) \end{array} \quad (20)$$

In other words, continuous machines are generally neither total not deterministic, but we will consider both of these special cases, and their compositional properties, in Sections 4.2 and 4.3.

*Example 4.1.2.* Here we collect some examples of continuous machines.

1. If  $f: A \rightarrow B$  is a morphism of **Int**-sheaves, there is a continuous  $(A, B)$ -machine given by  $(\text{id}_A, f): A \rightarrow A \times B$ .
2. If  $A$  and  $B$  are **Int**-sheaves, the identity span  $A \times B \rightarrow A \times B$  corresponds to the machine for which input and output are completely uncoupled.
3. For any sheaf  $A$  and  $\epsilon > 0$ , there is a machine (described in Example 4.2.6), which acts as an  $\epsilon$ -delay.
4. In Section 2.3 we discussed discrete and continuous dynamical systems. In Propositions 5.1.1 and 5.1.2, we will give algebra maps realizing them as classes of machines.

As in the case of discrete and continuous dynamical systems, the important aspect of these newly-defined machines is that they can be arbitrarily wired together to form new continuous machines.

Let  $\mathcal{W}_{\widetilde{\mathbf{Int}}}$  denote the category of  $\widetilde{\mathbf{Int}}$ -labeled boxes and wiring diagrams, as in Definition 2.2.2. Recall from (4) that to each object  $X \in \mathcal{W}_{\widetilde{\mathbf{Int}}}$  we can associate two sheaves,  $\widehat{X}^{\text{in}}, \widehat{X}^{\text{out}} \in \widetilde{\mathbf{Int}}$ , the input and output sheaves of  $X$ .

**Proposition 4.1.3.** *Continuous machines form a  $\mathcal{W}_{\widetilde{\mathbf{Int}}}$ -algebra, which we denote  $\text{Mch}: \mathcal{W}_{\widetilde{\mathbf{Int}}} \rightarrow \mathbf{Cat}$ .*

*Proof.* For each box  $X = (X^{\text{in}}, X^{\text{out}}) \in \text{ob } \mathcal{W}_{\widetilde{\mathbf{Int}}}$ , we define  $\text{Mch}(X) := \text{Mch}(\widehat{X}^{\text{in}}, \widehat{X}^{\text{out}})$ <sup>7</sup> to be the category of **Int**-sheaf spans  $S \rightarrow \widehat{X}^{\text{in}} \times \widehat{X}^{\text{out}}$ , as in Definition 4.1.1. Recall from (7) that a wiring diagram  $\phi: X \rightarrow Y$  determines sheaf maps

$$\widehat{\phi}^{\text{in}}: \widehat{Y}^{\text{in}} \times \widehat{X}^{\text{out}} \rightarrow \widehat{X}^{\text{in}} \quad \text{and} \quad \widehat{\phi}^{\text{out}}: \widehat{X}^{\text{out}} \rightarrow \widehat{Y}^{\text{out}}.$$

We must show that  $\phi$  induces a functor  $\text{Mch}(\phi): \text{Mch}(X) \rightarrow \text{Mch}(Y)$ .

On objects,  $\text{Mch}(\phi)$  maps the span  $(p^i, p^o): S \rightarrow \widehat{X}^{\text{in}} \times \widehat{X}^{\text{out}}$  to the span  $(q^i, q^o): T \rightarrow \widehat{Y}^{\text{in}} \times \widehat{Y}^{\text{out}}$  formed by taking the pullback and composing, as shown:

$$\begin{array}{ccc}
 T & \xrightarrow{\quad} & S \\
 \downarrow & \lrcorner & \downarrow (p^i, p^o) \\
 \widehat{Y}^{\text{in}} \times \widehat{X}^{\text{out}} & \xrightarrow{(\widehat{\phi}^{\text{in}}, \pi_2)} & \widehat{X}^{\text{in}} \times \widehat{X}^{\text{out}} \\
 \downarrow 1 \times \widehat{\phi}^{\text{out}} & & \\
 \widehat{Y}^{\text{in}} \times \widehat{Y}^{\text{out}} & & 
 \end{array}
 \tag{21}$$

<sup>7</sup> See also Remark 2.2.3 which explains a minor abuse of notation used here.

Since limits in  $\widetilde{\mathbf{Int}}$  are formed pointwise, we can describe the set of length- $\ell$  sections of the new state sheaf  $T$  explicitly:

$$T(\ell) \cong \left\{ (s, y) \in S(\ell) \times \widehat{Y}^{\text{in}}(\ell) \mid p_\ell^{\text{i}}(s) = \widehat{\phi}_\ell^{\text{in}}(y, p_\ell^{\text{o}}(s)) \right\}. \quad (22)$$

Roughly,  $T$  represents state evolutions of the machine  $(S, p^{\text{i}}, p^{\text{o}})$  inhabiting  $X$  together with  $\phi$ -compatible sections of  $Y$ -input. With this representation, the input sheaf map is  $q_\ell^{\text{i}}(s, y) = y$ , and the output sheaf map is  $q^{\text{o}} = \widehat{\phi}^{\text{out}} \circ p^{\text{o}}$ .

The mapping on arrows, as well as functoriality and unitality, follow from universal properties of pullbacks. Finally, the functor  $\text{Mch}$  is lax monoidal:

$$\begin{aligned} \text{Mch}_{X,Z}: \text{Mch}(X) \times \text{Mch}(Z) &\longrightarrow \text{Mch}(X + Z) \\ ((p^{\text{i}}, p^{\text{o}}), (q^{\text{i}}, q^{\text{o}})) &\longmapsto (p^{\text{i}} \times q^{\text{i}}, p^{\text{o}} \times q^{\text{o}}) \end{aligned} \quad (23)$$

and the coherence properties follow easily.  $\square$

*Remark 4.1.4.* Recall that if  $\mathcal{C}$  has pullbacks, any map  $f: A \rightarrow B$  in  $\mathcal{C}$  induces an adjunction  $(f_! \dashv f^*)$  between the slice categories, where  $f^*: \mathcal{C}/B \rightarrow \mathcal{C}/A$ . From this perspective, for  $\mathcal{C} = \widetilde{\mathbf{Int}}$ , the functor  $\text{Mch}(\phi): \text{Mch}(X) \rightarrow \text{Mch}(Y)$  from (21) is in fact the composite functor

$$\mathcal{C}/(\widehat{X}^{\text{in}} \times \widehat{X}^{\text{out}}) \xrightarrow{(\widehat{\phi}^{\text{in}}, \pi_2)^*} \mathcal{C}/(\widehat{Y}^{\text{in}} \times \widehat{X}^{\text{out}}) \xrightarrow{(1 \times \widehat{\phi}^{\text{out}})_!} \mathcal{C}/(\widehat{Y}^{\text{in}} \times \widehat{Y}^{\text{out}})$$

between the slice toposes; functoriality and unitality can be checked directly from that. For example, consider the composite  $\widehat{\psi} \circ \widehat{\phi}$  by applying the dependent product on the formulas (7); verifying the commutativity (up to iso, see Remark 2.1.2) of the middle rectangle below establishes  $\text{Mch}(\psi \circ \phi) = \text{Mch}(\psi) \circ \text{Mch}(\phi)$ :

$$\begin{array}{ccc} \mathcal{C}/\widehat{X}^{\text{in}} \times \widehat{X}^{\text{out}} & \xrightarrow{(\widehat{\phi}^{\text{in}}, \pi_2)^*} & \mathcal{C}/\widehat{Y}^{\text{in}} \times \widehat{X}^{\text{out}} \xrightarrow{((1 \times \widehat{\psi}^{\text{in}}) \circ (1 \times \widehat{\phi}^{\text{out}} \times 1) \circ (\Delta \times 1), \pi_2)^*} & \mathcal{C}/\widehat{Z}^{\text{in}} \times \widehat{X}^{\text{out}} \\ & \searrow \text{Mch}(\phi) & \downarrow (1 \times \widehat{\phi}^{\text{out}})_! & \downarrow (1 \times \widehat{\phi}^{\text{out}})_! \\ & \mathcal{C}/\widehat{Y}^{\text{in}} \times \widehat{Y}^{\text{out}} & \xrightarrow{(\widehat{\psi}^{\text{in}}, \pi_2)^*} & \mathcal{C}/\widehat{Z}^{\text{in}} \times \widehat{Y}^{\text{out}} \\ & & \searrow \text{Mch}(\psi) & \downarrow (1 \times \widehat{\psi}^{\text{out}})_! \\ & & & \mathcal{C}/\widehat{Z}^{\text{in}} \times \widehat{Z}^{\text{out}} \end{array} \quad (24)$$

Although for a topos, such as  $\widetilde{\mathbf{Int}}$ , the functor  $\text{Mch}(\phi)$  has a right adjoint and preserves pullbacks, it does not preserve the terminal object, so it is not the inverse image part of a geometric morphism.

## 4.2 Total, deterministic, and inertial machines

Our goal in this section is to describe some subclasses of continuous machines, Definition 4.1.1, namely those that are total and/or deterministic. Given an arbitrary initial state

and compatible input extension, as in (20), the machine is total if there is at least one state extension, and it is deterministic if there is at most one.

Recall the  $\epsilon$ -extension functor  $\text{Ext}_\epsilon: \widetilde{\mathbf{Int}} \rightarrow \widetilde{\mathbf{Int}}$  introduced in Definition 3.2.6, where for a sheaf  $A$  we have  $\text{Ext}_\epsilon A(\ell) = A(\ell + \epsilon)$ . Recall the two natural transformations  $\lambda, \rho: \text{Ext}_\epsilon \rightarrow \text{id}_{\widetilde{\mathbf{Int}}}$  whose component on  $A$  is given by applying either left or right restriction,

$$\text{Ext}_\epsilon A(\ell) = A(\ell + \epsilon) \begin{array}{c} \xrightarrow{\lambda_\ell = (-)|_{[0, \ell]}} \\ \xrightarrow{\rho_\ell = (-)|_{[\epsilon, \ell + \epsilon]}} \end{array} A(\ell). \quad (25)$$

Below, we will have much more occasion to use  $\lambda$  than to use  $\rho$ .

**Proposition 4.2.1.** *Let  $p: S \rightarrow A$  be a sheaf map. For any  $\epsilon \geq 0$ , consider the diagram of sheaves*

$$\begin{array}{ccc} \text{Ext}_\epsilon S & \xrightarrow{\lambda_S} & S \\ \downarrow h^\epsilon & \searrow & \downarrow p \\ S' & \xrightarrow{\quad} & S \\ \downarrow p' & \lrcorner & \downarrow p \\ \text{Ext}_\epsilon A & \xrightarrow{\lambda_A} & A \end{array} \quad (26)$$

where  $h^\epsilon$  is the induced map to the pullback  $S'$ . The following are equivalent

1. for all  $\epsilon > 0$ , the sheaf map  $h^\epsilon: \text{Ext}_\epsilon S \rightarrow S'$  is an epimorphism (resp. monomorphism);
2. for all  $\epsilon > 0$ , the function  $h_0^\epsilon: S(\epsilon) \rightarrow S'(0)$  is surjective (resp. injective).
3. there exists  $\delta > 0$  such that for all  $0 \leq \delta' \leq \delta$  the sheaf map  $h^{\delta'}: \text{Ext}_{\delta'} S \rightarrow S'$  is an epimorphism (resp. monomorphism).
4. there exists  $\delta > 0$  such that for all  $0 \leq \delta' \leq \delta$  the function  $h_0^{\delta'}: S(\delta') \rightarrow S'(0)$  is surjective (resp. injective).

*Proof.* When  $\epsilon = 0$ , we have that  $\lambda_A = \text{id}$  and  $\lambda_S = \text{id}$ , so  $h^\epsilon = \text{id}$ . Thus it is clear that  $1 \Rightarrow 3$  and that  $2 \Rightarrow 4$ , e.g. choose  $\delta := 1$ . By Lemma 3.2.3, the sheaf map  $h^\epsilon$  is an epi (resp. mono) iff for all  $\ell \in \mathbf{Int}$  the function  $h_\ell^\epsilon$  is epi (resp. mono). In particular taking  $\ell = 0$  we have  $1 \Rightarrow 2$  and  $3 \Rightarrow 4$ .

It thus suffices to prove  $4 \Rightarrow 1$ ; so assume 4 holds for some  $\delta > 0$ , and choose  $\epsilon > 0$ . Any  $s' \in S'(\ell)$  can be identified with a pair  $(s, a) \in S(\ell) \times A(\ell + \epsilon)$  such that  $p(s) = a|_{[0, \ell]}$ . For the surjectivity claim, we have that  $h_0^{\delta'}$  is surjective for all  $0 \leq \delta' \leq \delta$ , and the goal is to show  $h_\ell^\epsilon$  is surjective; it suffices to find an extension  $\bar{s} \in S(\ell + \epsilon)$  of  $s$  over  $a$ .

Since  $\mathbb{R}$  is a Euclidean domain, there exists a unique  $N \in \mathbb{N}$  and  $0 \leq \delta' \leq \delta$  such that  $\epsilon = N\delta + \delta'$ . Then  $(a|_{[\ell, \ell + \delta']}, \rho_0(s)) \in S'(0)$  and since  $h_0^{\delta'}$  is surjective, there exists an extension  $s'_0 \in S(\delta')$  emanating from  $\rho_0(s)$  above  $a|_{[\ell, \ell + \delta']}$ . Gluing this to  $s$  we obtain  $s_0 := s * s'_0 \in S(\ell + \delta')$  extending  $s$  over  $a_0 := a|_{[0, \ell + \delta']}$ .

If  $N = 0$  we are done, so we proceed by induction on  $N$ . Given  $s_n \in S(\ell + \delta' + n\delta)$ , extending  $s$  over  $a_n := a|_{[0, \ell + \delta' + n\delta]}$ , we use the surjectivity of  $h_0^{\delta'}$  to extend it, exactly as above, to find  $s'_n$  emanating from  $\lambda_0(s_n)$  over  $a_n$ . At the end, we have the desired lift  $s_N \in S(\ell + \epsilon)$ .

Assume now that  $h_0^{\delta'}$  is injective for all  $0 \leq \delta' \leq \delta$ . Then there is at most one extension  $s'_0 \in S(\delta')$  emanating from  $\rho_0(s)$  over  $a|_{[\ell, \ell + \delta']}$ . Thus there is at most one  $s_0 \in S(\ell + \delta')$  extending  $s$  over  $a|_{[0, \ell + \delta']}$ . The proof concludes analogously to the surjective case above.  $\square$

A generalization and purely formal proof of the above result will be given in Section 5.2.2.

**Definition 4.2.2.** We will say that a sheaf morphism  $p: S \rightarrow A$  is *total* (resp. *deterministic*) if it satisfies the equivalent conditions of Proposition 4.2.1.

It would be reasonable to define a continuous machine  $(p^i, p^o): S \rightarrow A \times B$  to be total (resp. deterministic) iff the input map  $p^i$  is, as this matches our intuitive notion (20) from the beginning of Chapter 4. Indeed, condition 2 says that for every pair  $(s_0, a) \in S(0) \times A(\epsilon)$  with  $a|_{[0, \epsilon]} = p_0^i(s_0)$ , there exists some  $s \in S(\epsilon)$  above  $a$  which extends  $s_0$ , for every  $\epsilon > 0$ . However, such a definition is not closed under feedback composition, so it is not suitable for our purposes. In order for total (resp. deterministic) machines to form a  $\mathcal{W}$ -algebra, we must add an extra condition, this time on the output map of the machine. We introduce a notion of *inertia*, in which a machine's current state determines not only its current output, but also a small amount more output.

**Definition 4.2.3.** A sheaf map  $p: S \rightarrow B$  is called  $\epsilon$ -*inertial* when there exists a factorization

$$\begin{array}{ccc}
 S & \xrightarrow{\bar{p}} & \text{Ext}_\epsilon B \\
 p \downarrow & & \swarrow \lambda_\epsilon \\
 B & & 
 \end{array} \tag{27}$$

through the  $\epsilon$ -extension of  $B$ ; it is called *inertial* when it is  $\epsilon$ -inertial for some  $\epsilon > 0$ .

We say a continuous machine  $(p^i, p^o): S \rightarrow A \times B$  is *inertial* (resp.  $\epsilon$ -*inertial*) if the output map  $p^o$  is. Inside  $\text{Mch}(A, B)$ , the full category of inertial (resp.  $\epsilon$ -inertial) machines is denoted  $\text{Mch}^{\text{in}}(A, B)$  (resp.  $\text{Mch}^{\text{ffl-in}}(A, B)$ ).

*Remark 4.2.4.* In most cases of interest, if a map  $p: S \rightarrow B$  is inertial then the lift  $\bar{p}$  in (27) is unique. Consider the diagram below

$$\begin{array}{ccc}
 S(\epsilon) & \xrightarrow{p(\epsilon)} & B(\epsilon) \\
 \lambda \downarrow & \nearrow \bar{p}(0) & \downarrow \lambda \\
 S(0) & \xrightarrow{p(0)} & B(0)
 \end{array}$$

It is easy to show that for any extension  $\bar{p}: S \rightarrow \text{Ext}_\epsilon B$ , not only does the bottom triangle commute, but the top one does also. Thus if  $\lambda: S(\epsilon) \rightarrow S(0)$  is surjective then the lift  $\bar{p}$  is indeed unique. This argument is easily generalized to show that if  $S$  is *extensible*—meaning there exists  $\epsilon > 0$  such that the map  $\lambda: \text{Ext}_\epsilon S \rightarrow S$  is an epimorphism—then there is no choice in (27).

Note that if  $p$  is  $\epsilon$ -inertial and  $\delta \leq \epsilon$ , then  $p$  is  $\delta$ -inertial as well. Thus, for any pair of sheaves  $A, B$  there is a fully faithful functor  $\text{Mch}^{\text{ffi-in}}(A, B) \rightarrow \text{Mch}^{\text{ffi-in}}(A, B)$  given by left restriction, and the colimit of the directed system is  $\text{Mch}^{\text{in}}$ :

$$\text{Mch}^{\text{in}}(A, B) \cong \text{colim}_{\epsilon > 0} \left( \text{Mch}^{\text{ffi-in}}(A, B) \right). \quad (28)$$

We are now ready to define total and deterministic machines in such a way that they are closed under all wiring diagram compositions; this will be proved in Proposition 4.3.2.

**Definition 4.2.5.** We say that a continuous machine  $(p^i, p^o): S \rightarrow A \times B$  is *total* (resp. *deterministic*) if

- the input map  $p^i$  is *total* (resp. *deterministic*) in the sense of Definition 4.2.2; and
- the output map  $p^o$  is inertial in the sense of Definition 4.2.3.

Inside  $\text{Mch}(A, B)$ , we denote the full subcategory of total, resp. deterministic,  $(A, B)$ -machines by  $\text{Mch}^{\text{t}}(A, B)$ , resp.  $\text{Mch}^{\text{d}}(A, B)$ . Their intersection  $\text{Mch}^{\text{td}}(A, B) := \text{Mch}^{\text{t}}(A, B) \cap \text{Mch}^{\text{d}}(A, B)$  is the set of machines that are both total and deterministic, i.e. machines for which the sheaf map  $h^\epsilon$ , as induced by  $p^i$  in Proposition 4.2.1, is an isomorphism.

*Example 4.2.6* (Delay Box). For any sheaf  $B$ , we can define a total, deterministic  $(B, B)$ -machine  $B \xrightarrow{\text{D}^\epsilon} B$  that takes input of type  $B$  and delays it for time  $\epsilon$ . It is defined to be the span

$$B \xleftarrow{\rho} \text{Ext}_\epsilon B \xrightarrow{\lambda} B,$$

in  $\widetilde{\mathbf{Int}}$ , where  $\rho$  and  $\lambda$  are the right and left restrictions as in (25). It is clear that  $\lambda$  is  $\epsilon$ -inertial. To see that  $\rho$  is both total and deterministic, one checks that the map  $h^\epsilon: \text{Ext}_\epsilon B \rightarrow \text{Ext}_\epsilon B \times_B \text{Ext}_\epsilon B$  in (26) is an isomorphism.

We defined the action of wiring diagrams on machines in Proposition 4.1.3. It is easy to show that for any  $(A, B)$ -machine  $p$ , the result of serially composing  $p$  with the  $\epsilon$ -delay  $(B, B)$ -machine will also be inertial.

*Example 4.2.7.* Being inertial is indeed required for the notions of totality and determinism to be closed under composition, as we now show.

Let  $C = \text{cst}(\underline{2})$  denote the constant sheaf on the set  $\underline{2} := \{1, 2\}$ . Note that  $\text{Ext}_\epsilon C \cong C$  for any  $\epsilon$ . Define  $p, q: \underline{2} \rightarrow \underline{2} \times \underline{2}$  to be the diagonal and the function  $q(1) = q(2) = (1, 2)$ , respectively. Consider the wiring diagram  $\phi: X \rightarrow 0$  (see Definition 2.2.2) shown below

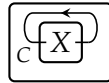

The machine  $P := \text{cst}(p): C \rightarrow C \times C$  is such that its input map  $p^i = \text{id}_C$  is deterministic; however,  $\text{Mch}(\phi)(P)$  is the machine  $C \rightarrow \text{cst}(1) \times \text{cst}(1)$ , and its input map is not deterministic. The machine  $Q := \text{cst}(q)$  is such that its input map is total, but  $\text{Mch}(\phi)(Q)$  is the machine  $\emptyset \rightarrow \text{cst}(1) \times \text{cst}(1)$  and its input map is not total.

### 4.3 Closure under feedback

For the remainder of this section, we write  $\mathcal{W}$  to denote the symmetric monoidal category  $\mathcal{W}_{\widetilde{\mathbf{Int}}}$  of  $\widetilde{\mathbf{Int}}$ -labeled boxes and wiring diagrams (Definition 2.2.2). We saw in Proposition 4.1.3 that continuous machines form a  $\mathcal{W}$ -algebra  $\mathbf{Mch} : \mathcal{W} \rightarrow \mathbf{Cat}$ ; now we show that inertial, deterministic, and total machines do too.

**Proposition 4.3.1.** *Inertial continuous machines (resp.  $\epsilon$ -inertial machines, for any  $\epsilon > 0$ ) as in Definition 4.2.3 are closed under composition in  $\mathbf{Mch}$ ; that is, they form a subalgebra  $\mathbf{Mch}^{\text{in}} : \mathcal{W} \rightarrow \mathbf{Cat}$  (resp.  $\mathbf{Mch}^{\text{ffl-in}} : \mathcal{W} \rightarrow \mathbf{Cat}$ ). Moreover, we have a colimit of algebras*

$$\mathbf{Mch}^{\text{in}} \cong \operatorname{colim}_{\epsilon > 0} (\mathbf{Mch}^{\text{ffl-in}}).$$

*Proof.* Given a morphism  $\phi : X \rightarrow Y$ , we restrict to obtain a functor

$$\mathbf{Mch}^{\text{ffl-in}}(X) \subseteq \mathbf{Mch}(X) \xrightarrow{\mathbf{Mch}(\phi)} \mathbf{Mch}(Y);$$

we need to show that it factors through the full subcategory  $\mathbf{Mch}^{\text{ffl-in}}(Y)$ . Suppose that  $p = (p^i, p^o) : S \rightarrow \widehat{X}^{\text{in}} \times \widehat{X}^{\text{out}}$  is a machine and that  $p^o$  factors as  $\lambda \circ \bar{p}$  for some  $\epsilon > 0$ . This is shown in the upper-middle square below:

$$\begin{array}{ccccc}
 T & \xrightarrow{\quad} & S & \xrightarrow{\quad \bar{p} \quad} & \operatorname{Ext}_{\epsilon}(\widehat{X}^{\text{out}}) & \xrightarrow{\quad} & \operatorname{Ext}_{\epsilon}(\widehat{Y}^{\text{out}}) \\
 \downarrow & \lrcorner & \downarrow (p^i, p^o) & & \downarrow \lambda & \xrightarrow{\operatorname{Ext}_{\epsilon}(\phi^{\text{out}})} & \downarrow \lambda \\
 \widehat{Y}^{\text{in}} \times \widehat{X}^{\text{out}} & \xrightarrow{(\widehat{\phi}^{\text{in}}, \pi_2)} & \widehat{X}^{\text{in}} \times \widehat{X}^{\text{out}} & \xrightarrow{\pi_2} & \widehat{X}^{\text{out}} & \xrightarrow{\widehat{\phi}^{\text{out}}} & \widehat{Y}^{\text{out}} \\
 & & \downarrow 1 \times \widehat{\phi}^{\text{out}} & & & & \\
 \widehat{Y}^{\text{in}} \times \widehat{X}^{\text{out}} & \xrightarrow{1 \times \widehat{\phi}^{\text{out}}} & \widehat{Y}^{\text{in}} \times \widehat{Y}^{\text{out}} & \xrightarrow{\pi_2} & \widehat{Y}^{\text{out}} & & 
 \end{array} \tag{29}$$

The construction for  $\mathbf{Mch}(\phi)(S, p) = (T, q)$  as in (21) is the left-hand pullback, along with the bottom-left horizontal morphism, thus defining  $q : T \rightarrow \widehat{Y}^{\text{in}} \times \widehat{Y}^{\text{out}}$ . The bottom (trapezoid-shaped) sub-diagram commutes, and the right-hand diagram commutes because  $\lambda$  is a natural transformation. Thus the outer square commutes, exhibiting a factorization of  $q^o$  through  $\operatorname{Ext}_{\epsilon}(\widehat{Y}^{\text{out}})$ .

Hence we have a functor  $\mathbf{Mch}^{\text{ffl-in}} : \mathcal{W} \rightarrow \mathbf{Cat}$ . If  $0 < \delta \leq \epsilon$  the diagram of categories commutes:

$$\begin{array}{ccc}
 \mathbf{Mch}^{\text{ffl-in}}(X) & \longrightarrow & \mathbf{Mch}^{\text{ffl-in}}(Y) \\
 \downarrow & & \downarrow \\
 \mathbf{Mch}^{\text{ffi-in}}(X) & \longrightarrow & \mathbf{Mch}^{\text{ffi-in}}(Y)
 \end{array}$$

so we have a natural transformation  $\mathbf{Mch}^{\text{ffl-in}} \rightarrow \mathbf{Mch}^{\text{ffi-in}}$ , and the colimit of the directed system is  $\mathbf{Mch}^{\text{in}}$ . It remains to show that all these functors  $\mathcal{W} \rightarrow \mathbf{Cat}$ , and maps between them, are monoidal.

It is easy to see that the monoidal product of  $\epsilon$ -inertial machines is  $\epsilon$ -inertial, because  $\text{Ext}_\epsilon$  preserves products of sheaves. Thus  $\text{Mch}^{\text{ffi-in}}$  is indeed a  $\mathcal{W}$ -algebra, and moreover, the natural transformation  $\text{Mch}^{\text{ffi-in}} \rightarrow \text{Mch}^{\text{ffi-in}}$  between functors  $\mathcal{W} \rightarrow \mathbf{Cat}$  is clearly monoidal. We still need to define a monoidal structure on the colimit  $\text{Mch}^{\text{in}}$ . Given sheaf maps  $p_1: S_1 \rightarrow \text{Ext}_{\epsilon_1}(\widehat{X}_1^{\text{out}})$  and  $p_2: S_2 \rightarrow \text{Ext}_{\epsilon_2}(\widehat{X}_2^{\text{out}})$  for  $\epsilon_1, \epsilon_2 > 0$ , let  $\epsilon := \min(\epsilon_1, \epsilon_2)$  be their minimum. Then by left restriction (if necessary), we have a sheaf map  $S_1 \times S_2 \rightarrow \text{Ext}_\epsilon(\widehat{X}_1^{\text{out}} \times \widehat{X}_2^{\text{out}})$ , which we define to be the monoidal product of  $p_1$  and  $p_2$ . It is easy to see that the natural transformation  $\text{Mch}^{\text{ffi-in}}(X) \rightarrow \text{Mch}^{\text{in}}(X)$  is monoidal, completing the proof.  $\square$

**Proposition 4.3.2.** *Total machines are closed under composition in  $\text{Mch}$ ; that is, they form a subalgebra  $\text{Mch}^{\text{t}}: \mathcal{W} \rightarrow \mathbf{Cat}$ . Similarly, deterministic machines form a subalgebra  $\text{Mch}^{\text{d}}: \mathcal{W} \rightarrow \mathbf{Cat}$ . Their intersection is a subalgebra  $\text{Mch}^{\text{td}} := \text{Mch}^{\text{t}} \cap \text{Mch}^{\text{d}}$ .*

*Proof.* Given an object  $X = (X^{\text{in}}, X^{\text{out}})$ , we define the full subcategories  $\text{Mch}^{\text{t}}(X), \text{Mch}^{\text{d}}(X)$  of  $\text{Mch}(\widehat{X}^{\text{in}}, \widehat{X}^{\text{out}})$  as in Definition 4.2.5, and we define  $\text{Mch}^{\text{td}} := \text{Mch}^{\text{t}} \cap \text{Mch}^{\text{d}}$  to be their intersection. Given a morphism  $\phi: X \rightarrow Y$ , we restrict to obtain functors

$$\text{Mch}^{\text{t}}(X) \subseteq \text{Mch}(X) \xrightarrow{\text{Mch}(\phi)} \text{Mch}(Y) \quad \text{and} \quad \text{Mch}^{\text{d}} \subseteq \text{Mch}(X) \xrightarrow{\text{Mch}(\phi)} \text{Mch}(Y);$$

we need to show that they factor through the respective full subcategories  $\text{Mch}^{\text{t}}(Y)$  and  $\text{Mch}^{\text{d}}(Y)$ . The result for  $\text{Mch}^{\text{td}}$  follows trivially; it was only included in the statement for completeness.

A total (resp. deterministic) machine  $p = (p^i, p^o): S \rightarrow \widehat{X}^{\text{in}} \times \widehat{X}^{\text{out}}$  is  $\epsilon$ -inertial for some  $\epsilon > 0$ , meaning that  $p^o$  is the composite  $\lambda \circ \bar{p}: S \rightarrow \text{Ext}_\epsilon \widehat{X}^{\text{out}} \rightarrow \widehat{X}^{\text{out}}$ . By Proposition 4.3.1, its image  $q = (q^i, q^o): T \rightarrow \widehat{Y}^{\text{in}} \times \widehat{Y}^{\text{out}}$  under  $\text{Mch}(\phi)$  is also  $\epsilon$ -inertial, so  $q^o = \lambda \circ \bar{q}$  for some  $\bar{q}$ .

It suffices to check that the resulting input sheaf map  $q^i$  is total (resp. deterministic). We use the formulation in Proposition 4.2.1 (3); that is, we will show that the sheaf map  $h^{\epsilon'}$  in (26) is an epimorphism (resp. monomorphism) for arbitrary  $\epsilon' \leq \epsilon$ . But note that if  $q^o$  is  $\epsilon$ -inertial then it is also  $\epsilon'$ -inertial, so we may assume  $\epsilon = \epsilon'$ .

The bottom squares below are pullbacks; define  $S'$  and  $T'$  to also be pullbacks:

$$\begin{array}{ccc} S' & \xrightarrow{\quad} & S \\ \downarrow & \lrcorner & \downarrow (p^i, \bar{p}) \\ \text{Ext}_\epsilon \widehat{X}^{\text{in}} \times \text{Ext}_\epsilon \widehat{X}^{\text{out}} & \xrightarrow{\lambda \times 1} & \widehat{X}^{\text{in}} \times \text{Ext}_\epsilon \widehat{X}^{\text{out}} \\ \pi_1 \downarrow & \lrcorner & \downarrow \pi_1 \\ \text{Ext}_\epsilon \widehat{X}^{\text{in}} & \xrightarrow{\lambda} & \widehat{X}^{\text{in}} \end{array} \quad \begin{array}{ccc} T' & \xrightarrow{\quad} & T \\ \downarrow & \lrcorner & \downarrow (q^i, \bar{q}) \\ \text{Ext}_\epsilon \widehat{Y}^{\text{in}} \times \text{Ext}_\epsilon \widehat{X}^{\text{out}} & \xrightarrow{\lambda \times 1} & \widehat{Y}^{\text{in}} \times \text{Ext}_\epsilon \widehat{X}^{\text{out}} \\ \downarrow & \lrcorner & \downarrow \\ \text{Ext}_\epsilon \widehat{Y}^{\text{in}} & \xrightarrow{\lambda} & \widehat{Y}^{\text{in}} \end{array} \quad (30)$$

Note that the left composite  $S' \rightarrow \text{Ext}_\epsilon \widehat{X}^{\text{in}}$  is the map  $p'$  as defined in Proposition 4.2.1, and similarly for  $T' \rightarrow \text{Ext}_\epsilon \widehat{Y}^{\text{in}}$ .



Now consider the diagram below. The sides are pullbacks by (30), the front rectangle is a pullback by definition (21) and one can check that the lower bottom square is a pullback as well.

$$\begin{array}{ccccc}
 T' & \xrightarrow{\quad} & S' & & \\
 \downarrow & \searrow & \downarrow & \searrow & \\
 \text{Ext}_\epsilon \widehat{Y}^{\text{in}} \times \text{Ext}_\epsilon \widehat{X}^{\text{out}} & \xrightarrow{\quad} & \text{Ext}_\epsilon \widehat{X}^{\text{in}} \times \text{Ext}_\epsilon \widehat{X}^{\text{out}} & \xrightarrow{\quad} & S \\
 & \searrow & \downarrow (q^i, \bar{q}) & \searrow & \downarrow (p^i, \bar{p}) \\
 & & \widehat{Y}^{\text{in}} \times \text{Ext}_\epsilon \widehat{X}^{\text{out}} & \xrightarrow{\quad} & \widehat{X}^{\text{in}} \times \text{Ext}_\epsilon \widehat{X}^{\text{out}} \\
 & & \downarrow & & \downarrow \\
 & & \widehat{Y}^{\text{in}} \times \widehat{X}^{\text{out}} & \xrightarrow{\quad} & \widehat{X}^{\text{in}} \times \widehat{X}^{\text{out}}
 \end{array}$$

Therefore the back face is a pullback, which we re-write as the bottom square below. Since  $\text{Ext}_\epsilon$  commutes with limits (see Lemma 3.2.2), the big rectangle is a pullback, so the top square is too:

$$\begin{array}{ccc}
 \text{Ext}_\epsilon T & \xrightarrow{\quad} & \text{Ext}_\epsilon S \\
 i^\epsilon \downarrow & \lrcorner & \downarrow h^\epsilon \\
 T' & \xrightarrow{\quad} & S' \\
 \downarrow & \lrcorner & \downarrow \\
 \text{Ext}_\epsilon \widehat{Y}^{\text{in}} \times \text{Ext}_\epsilon \widehat{X}^{\text{out}} & \xrightarrow{\quad} & \text{Ext}_\epsilon \widehat{X}^{\text{in}} \times \text{Ext}_\epsilon \widehat{X}^{\text{out}}
 \end{array}$$

This diagram takes place in a topos—in particular, a regular category—so if the  $h^\epsilon$  is epi (resp. mono) then  $i^\epsilon$  is too.

Finally, it is easy to check that if  $p_1^i: S_1 \rightarrow \widehat{X}_1^{\text{in}}$  and  $p_2^i: S_2 \rightarrow \widehat{X}_2^{\text{in}}$  are total (resp. deterministic), their product  $p_1^i \times p_2^i$  is too, and lax monoidality follows.  $\square$

#### 4.4 Discrete and synchronous variations

One of the central purposes of the current work is to allow discrete-time and continuous-time systems to be incorporated within the same framework. Our first goal is to define a discrete analogue of the machines described so far. All the results go through with nearly identical proofs, so we only need give the definitions and statements. We will produce mappings between the discrete and continuous versions in Chapter 5.

Discrete machines have  $\mathbf{Int}_N$ -sheaves, rather than  $\mathbf{Int}$ -sheaves, labeling their input and output ports. All of the ideas of Sections 4.2 and 4.3 can be modified to this setting, with the main difference being that the positive real  $\epsilon \in \mathbb{R}_{\geq 0}$  used in extension sheaves is replaced by the positive integer  $1 \in \mathbb{N}$ .

**Definition 4.4.1.** Let  $p: S \rightarrow A$  be an  $\mathbf{Int}_N$ -sheaf morphism. Define  $h_1: \text{Ext}_1 S \rightarrow S'$  to be the universal map to the pullback sheaf:

$$\begin{array}{ccccc}
 \text{Ext}_1 S & & \xrightarrow{\lambda} & & S \\
 \downarrow h_1 & & & & \downarrow p \\
 S' & \longrightarrow & & & S \\
 \downarrow p' & \lrcorner & & & \downarrow p \\
 \text{Ext}_1 A & \xrightarrow{\lambda} & & & A \\
 \downarrow \text{Ext}_1 p & & & & \\
 & & & & 
 \end{array}$$

Then  $p$  is *total* (resp. *deterministic*) if  $h_1$  is surjective (resp. injective);  $p$  is *inertial* if it factors through  $\lambda: \text{Ext}_1 A \rightarrow A$ .

A *discrete machine* is a span  $p = (p^i, p^o): S \rightarrow A \times B$  in  $\widetilde{\mathbf{Int}}_N$ . It is *inertial* if the output map  $p^o$  is. The machine is *total* (resp. *deterministic*) if both the output map  $p^i$  is inertial and the input map  $p^i$  is *total* (resp. *deterministic*).

*Remark 4.4.2.* By an argument similar to that in Proposition 4.2.1, we can simplify Definition 4.4.1 a great deal. Recall from Proposition 3.2.2 that  $p: S \rightarrow C$  can be identified with a graph homomorphism; write  $S = ( S_1 \xrightarrow[\text{tgt}]{\text{src}} S_0 )$  where we let  $S_n := S(n)$  denote the set of length- $n$  sections of  $S$ , and similarly for  $C$ . Consider the diagram of sets

$$\begin{array}{ccccc}
 S_1 & & \xrightarrow{\text{src}} & & S_0 \\
 \downarrow h & & & & \downarrow p_0 \\
 S' & \longrightarrow & & & S_0 \\
 \downarrow p_1 & \lrcorner & & & \downarrow p_0 \\
 C_1 & \xrightarrow{\text{src}} & & & C_0
 \end{array} \tag{31}$$

where  $S'$  is the pullback and  $h$  is the induced function. Then  $p$  is total (resp. deterministic) if and only if  $h$  is surjective (resp. injective).

The proof of Proposition 4.4.3 follows that of Propositions 4.1.3, 4.3.1 and 4.3.2.

**Proposition 4.4.3.** *Discrete machines form a  $\mathcal{W}_{\widetilde{\mathbf{Int}}_N}$ -algebra, denoted  $\text{Mch}_N$ . Inertial, total, deterministic discrete machines form subalgebras  $\text{Mch}_N^{\text{in}}$ ,  $\text{Mch}_N^{\text{t}}$ ,  $\text{Mch}_N^{\text{d}}$  (and  $\text{Mch}_N^{\text{td}}$ ).*

To compare discrete and continuous systems in Chapter 5, it will be useful to have a mediating construct that handles synchronization in continuous systems. Recall the synchronizing sheaf  $\text{Sync} \in \widetilde{\mathbf{Int}}$  from Section 3.3. Given an object (resp. map, span) in  $\widetilde{\mathbf{Int}}/\text{Sync}$ , we refer to its image under the functor  $\widetilde{\mathbf{Int}}/\text{Sync} \rightarrow \widetilde{\mathbf{Int}}$ , sending  $(X \rightarrow \text{Sync})$  to  $X$ , as the *underlying* object (resp. map, span) in  $\widetilde{\mathbf{Int}}$ .

**Definition 4.4.4.** A morphism  $p: S \rightarrow A$  in  $\widetilde{\mathbf{Int}}/\text{Sync}$  is *inertial* (resp. *total*, *deterministic*) if the underlying map in  $\widetilde{\mathbf{Int}}$  is.

A *synchronous machine* is a span  $p = (p^i, p^o): S \rightarrow A \times B$  in  $\widetilde{\mathbf{Int}}/\text{Sync}$ . It is *inertial* (resp. *total*, *deterministic*) if the underlying continuous machine  $p$  in  $\widetilde{\mathbf{Int}}$  is.

Again, the proof of Proposition 4.4.5 is similar to the analogous results proven above.

**Proposition 4.4.5.** *Synchronous machines form a  $\mathcal{W}_{\widetilde{\mathbf{Int}}_N}$ -algebra, denoted  $\text{Mch}_{\text{Sync}}$ . Inertial, total, deterministic synchronous machines form subalgebras  $\text{Mch}_{\text{Sync}}^{\text{in}}$ ,  $\text{Mch}_{\text{Sync}}^{\text{t}}$ ,  $\text{Mch}_{\text{Sync}}^{\text{d}}$  (and  $\text{Mch}_{\text{Sync}}^{\text{td}}$ ).*

## 4.5 Safety contracts

We conclude this chapter by a short discussion on *contracts* that we can impose on machines. Intuitively, a contract for a machine should be a set of logical formulas that dictate what sort of input/output behavior is *valid*. If the machine inhabits some box  $X$ , the contract should be relative to sections of the input and output sheaves  $\widehat{X}^{\text{in}}, \widehat{X}^{\text{out}}$ .

For example, suppose we have a box  $X$  and consider the following natural language contract for a machine inhabiting  $X$ : “if I ever receive two True’s in a row, I will output a False within 5 seconds”. For any input/output pair  $(i, j) \in \widehat{X}^{\text{in}}(n) \times \widehat{X}^{\text{out}}(n)$ , we can evaluate whether the machine satisfies the contract, at least on the interval  $[0, 6]$ : if the first two inputs are True,  $i|_{[0,1]} = \langle \text{True}, \text{True} \rangle$ , then the last five outputs  $j|_{[2,6]}$  should include a False. For any section  $s$  of longer length  $n \geq 6$ , we say the machine satisfies the contract if it does on every subinterval  $[a, a + 6] \subseteq [0, n]$ .

But on shorter sections, it is unclear what to do: should one say the contract is satisfied on short intervals or not? One choice is what is sometimes called a *safety contract*. These have the property that if a section validates the contract, then so does any restriction of it. Thus we formalize safety contracts on  $X$  as sub-presheaves  $C \subseteq U(\widehat{X}^{\text{in}} \times \widehat{X}^{\text{out}}) \cong U\widehat{X}^{\text{in}} \times U\widehat{X}^{\text{out}}$ : if a section  $x = (i, j)$  is in  $C$  then it is valid.<sup>8</sup> Thus we arrive at the following definition.

**Definition 4.5.1.** Let  $A, B \in \widetilde{\mathbf{Int}}$  be continuous interval sheaves, and  $U: \widetilde{\mathbf{Int}} \rightarrow \text{Psh}(\mathbf{Int})$  the forgetful functor. A *safety contract* is a sub-presheaf  $C \subseteq UA \times UB$ . We say a section  $(a, b) \in A \times B$  *validates* the contract if  $(a, b) \in C$ .

If  $p = (p^i, p^o): S \rightarrow \widehat{X}^{\text{in}} \times \widehat{X}^{\text{out}}$  is a continuous machine as in Definition 4.1.1, we say that it *validates* the contract, denoted  $p \models C$ , if the image  $\text{im}(Up)$  is contained in  $C$ , or equivalently  $Up$  factors through it:

$$\begin{array}{ccc}
 & & C \\
 & \nearrow & \downarrow \\
 US & \xrightarrow{Up} & UA \times UB
 \end{array}$$

In other words,  $p$  validates  $C$  if, for every section  $s \in S$ , the associated input and output validates the contract as above,  $(p^i(s), p^o(s)) \in C$ .

<sup>8</sup>Using sheaves, rather than presheaves, for safety contracts does not have the intended semantics, because the sheaf condition would imply that the concatenation of any two valid behaviors is valid. It thus effectively disallows historical context from being a consideration in validity. In the example above, any section of length 4 is valid, but some sections of length 8 are not so the gluing of two valid sections is not always valid.

The collection of all  $(A, B)$ -contracts is a poset, which we denote

$$\text{Cntr}(A, B) := \text{SubPsh}(A \times B) \equiv \text{Sub}_{\text{Psh}(\mathbf{Int})}(UA \times UB). \quad (32)$$

In what follows, we often elide the forgetful functor  $U$  so we may write  $C \subseteq A \times B$  to denote  $C \subseteq UA \times UB$ ; in diagrams involving both sheaves and presheaves, everything should be regarded as a presheaf.

*Remark 4.5.2.* As mentioned at the beginning of this section, contracts should really be written in a logical formalism. What we call safety contracts in Definition 4.5.1 are a reasonable semantics for this formalism; we leave its logical specification for future work.

**Proposition 4.5.3.** *Safety contracts form a  $\mathcal{W}_{\widetilde{\mathbf{Int}}}$ -algebra.*

*Proof.* The proof proceeds like the ones for machines earlier, e.g. Proposition 4.1.3. To any box  $X \in \mathcal{W}_{\widetilde{\mathbf{Int}}}$ , we associate the posetal category  $\text{Cntr}(\widehat{X}^{\text{in}}, \widehat{X}^{\text{out}})$  of (32). Given a wiring diagram  $\phi: X \rightarrow Y$  and a contract  $C \subseteq \widehat{X}^{\text{in}} \times \widehat{X}^{\text{out}}$ , we form  $D := \text{Cntr}(\phi)(C)$

$$\begin{array}{ccc}
 & C' & \longrightarrow & C \\
 & \downarrow & \lrcorner & \downarrow \\
 D & \widehat{Y}^{\text{in}} \times \widehat{X}^{\text{out}} & \xrightarrow{(\widehat{\phi}^{\text{in}}, \pi_2)} & \widehat{X}^{\text{in}} \times \widehat{X}^{\text{out}} \\
 & \downarrow 1 \times \widehat{\phi}^{\text{out}} & & \\
 & \widehat{Y}^{\text{in}} \times \widehat{Y}^{\text{out}} & & 
 \end{array} \quad (33)$$

as the subpresheaf of  $\widehat{Y}^{\text{in}} \times \widehat{Y}^{\text{out}}$  which is the image of the pullback  $C'$ . Analogously to Remark 4.1.4, if  $(\exists_f \dashv f^*): \text{Sub}(B) \rightarrow \text{Sub}(A)$  are the induced adjunctions for any  $f: A \rightarrow B$  in the topos  $\text{Psh}(\mathbf{Int})$ , the functor  $\text{Cntr}(\phi)$  is the composite

$$\text{SubPsh}(\widehat{X}^{\text{in}} \times \widehat{X}^{\text{out}}) \xrightarrow{(\widehat{\phi}^{\text{in}}, \pi_2)^*} \text{SubPsh}(\widehat{Y}^{\text{in}} \times \widehat{X}^{\text{out}}) \xrightarrow{\exists_{(1 \times \widehat{\phi}^{\text{out}})}} \text{SubPsh}(\widehat{Y}^{\text{in}} \times \widehat{Y}^{\text{out}}).$$

Functoriality and unitality follow from this expression, e.g. by checking similarly to (24) that  $\exists_{(1 \times \widehat{\phi}^{\text{out}})} \circ \left( (1 \times \widehat{\psi}^{\text{in}}) \circ (1 \times \widehat{\phi}^{\text{out}} \times 1) \circ (\Delta \times 1), \pi_2 \right)^* = (\widehat{\psi}^{\text{in}}, \pi_1)^* \circ \exists_{(1 \times \widehat{\phi}^{\text{out}})}$ .

The lax monoidal structure is again given by the cartesian product, i.e. natural maps  $\text{SubPsh}(X) \times \text{SubPsh}(Y) \rightarrow \text{SubPsh}(X \times Y)$  for any sheaves  $X, Y$ .  $\square$

Finally, we may consider the inhabitant of a wiring diagram box to be a machine with an associated contract, namely any contract validated by it. These also form an algebra, essentially combining Propositions 4.1.3 and 4.5.3; the composed inhabitant is the composite machine, validating the associated composite contract.

**Definition 4.5.4.** Let  $A, B \in \widetilde{\mathbf{Int}}$  be sheaves. An  $(A, B)$ -contracted machine is a pair  $(S, C) \in \text{Mch}(A, B) \times \text{Cntr}(A, B)$ , such that  $S \models C$ .

Contracted machines form a full subcategory  $\text{CM}(A, B)$  of  $(\text{Mch} \times \text{Cntr})(A, B)$ .

**Proposition 4.5.5.** *Contracted machines form a  $\mathcal{W}_{\text{Int}}$ -subalgebra of  $\text{Mch} \times \text{Cntr}$ , see Remark 2.1.1.*

*Proof.* For any  $X = (X^{\text{in}}, X^{\text{out}})$ , define

$$\text{CM}(X) := \text{CM}(\widehat{X}^{\text{in}}, \widehat{X}^{\text{out}}) \subseteq \text{Mch}(\widehat{X}^{\text{in}}, \widehat{X}^{\text{out}}) \times \text{Cntr}(\widehat{X}^{\text{in}}, \widehat{X}^{\text{out}}).$$

Suppose  $\phi: X \rightarrow Y$  is a wiring diagram. Given  $(p: S \rightarrow \widehat{X}^{\text{in}} \times \widehat{X}^{\text{out}}, m: C \rightarrow U\widehat{X}^{\text{in}} \times U\widehat{X}^{\text{out}}) \in \text{CM}(\widehat{X}^{\text{in}}, \widehat{X}^{\text{out}})$ , applying  $\text{Mch}(\phi) \times \text{Cntr}(\phi)$  produces a pair  $(q: T \rightarrow \widehat{Y}^{\text{in}} \times \widehat{Y}^{\text{out}}, n: D \rightarrow U\widehat{Y}^{\text{in}} \times U\widehat{Y}^{\text{out}})$  given by (21) and (33). The following diagram verifies that  $q$  validates  $n$ :

$$\begin{array}{ccccc}
 & & T & \xrightarrow{\quad} & S \\
 & \exists! \curvearrowright & \downarrow \lrcorner & & \downarrow p \\
 C' & \xrightarrow{\quad} & C & & \\
 \downarrow \lrcorner & \searrow & \downarrow & \searrow m & \\
 D & & \widehat{Y}^{\text{in}} \times \widehat{X}^{\text{out}} & \xrightarrow{\quad} & \widehat{X}^{\text{in}} \times \widehat{X}^{\text{out}} \\
 \downarrow n & & \downarrow & & \\
 & & \widehat{Y}^{\text{in}} \times \widehat{Y}^{\text{out}} & & 
 \end{array} \tag{34}$$

The left hand side composite is precisely the new machine  $q$ , due to the upper-side pullback formed; clearly it factors through  $n$ . Monoidality is inherited from  $\text{Mch} \times \text{Cntr}$ , given by the cartesian product.  $\square$

We could of course replace  $\text{Mch}$  with any other version of a machine (total, deterministic and discrete, synchronous) as described in Sections 4.2 and 4.4, and express safety contracts on those.

## 5 Comparing dynamical systems and machines

In this final chapter of the main text, we produce algebra maps from dynamical systems of Section 2.3 to the various machines considered in Chapter 4, as well as maps between the different kinds of machines (continuous, discrete, etc.) and contracts. These maps allow us to translate one sort of algebra to another, while ensuring consistency of serial, parallel, and feedback composition.

We will briefly elaborate on the previous sentence for two  $\mathcal{W}$ -algebras  $F$  and  $G$ . Recall that, given a wiring diagram  $\phi: X_1, \dots, X_n \rightarrow Y$  like (10) and  $F$ -inhabitants of the boxes  $f_i \in F(X_i)$ , we obtain an inhabitant  $F(\phi)(f_1, \dots, f_n) \in F(Y)$  of the outer box via (11); we call it the *composite*. Given a map of  $\mathcal{W}$ -algebras  $\alpha: F \Rightarrow G$  i.e. a monoidal natural transformation, which we think of as a translation from  $F$ -inhabitants to  $G$ -inhabitants. Its axioms dictate

the commutativity of

$$\begin{array}{ccccc}
 F(X_1) \times \dots \times F(X_n) & \xrightarrow{F_{X_1, \dots, X_n}} & F(X_1 + \dots + X_n) & \xrightarrow{F(\phi)} & F(Y) \\
 \alpha_{X_1} \times \dots \times \alpha_{X_n} \downarrow & & \alpha_{X_1 + \dots + X_n} \downarrow & & \downarrow \alpha_Y \\
 G(X_1) \times \dots \times G(X_n) & \xrightarrow{G_{X_1, \dots, X_n}} & G(X_1 + \dots + X_n) & \xrightarrow{G(\phi)} & G(Y)
 \end{array}$$

Intuitively, this means that whether we first compose the interior systems and then translate via  $\alpha$ , or first translate and then compose, the results are the same.

We explain in Section 5.1 how to translate from various sorts of dynamical systems to various sorts of machines, in Section 5.2 how to translate between various sorts of machines.

## 5.1 Realizing dynamical systems as machines

Understanding how the motivating examples of discrete and continuous dynamical systems of Section 2.3 fit into our generalized framework of abstract machines, makes the latter much more concrete and accomplishes one of the main goals of this work.

To begin with, discrete dynamical systems (Definition 2.3.1) are **Set**-based—the input and output signals to each machine are elements of a set, as are the states—so we need to compare the category of sets with the category of  $\mathbf{Int}_N$ -sheaves. In Example 3.2.3, 1, for any set  $S$  we defined the  $\widetilde{\mathbf{Int}}_N$ -sheaf  $K(S)$ , with length- $n$  sections  $K(S)(n) = S^{n+1} = \text{Hom}_{\mathbf{Set}}(\{0, \dots, n\}, S)$ , i.e. lists of length  $n + 1$  in  $S$ . This mapping extends to a (finite-limit preserving) functor  $K: \mathbf{Set} \rightarrow \widetilde{\mathbf{Int}}_N$ , and therefore by (8), there is an induced strong monoidal functor  $\mathcal{W}_K: \mathcal{W}_{\mathbf{Set}} \rightarrow \mathcal{W}_{\widetilde{\mathbf{Int}}_N}$  which sends a pair of typed finite sets  $(\tau, \tau'): (X^{\text{in}}, X^{\text{out}}) \rightarrow \mathbf{Set} \times \mathbf{Set}$  to the composites  $(K \circ \tau, K \circ \tau'): (X^{\text{in}}, X^{\text{out}}) \rightarrow \widetilde{\mathbf{Int}}_N \times \widetilde{\mathbf{Int}}_N$ .

As in Proposition 4.4.3, let  $\text{Mch}_N^{\text{td}}: \mathcal{W}_{\widetilde{\mathbf{Int}}_N} \rightarrow \mathbf{Cat}$  denote the algebra of total and deterministic discrete machines, and recall from Definition 2.3.1 the algebra  $\text{DDS}: \mathcal{W}_{\mathbf{Set}} \rightarrow \mathbf{Cat}$ .

**Proposition 5.1.1.** *There exists a morphism of  $\mathcal{W}_{\mathbf{Set}}$ -algebras*

$$\begin{array}{ccc}
 \mathcal{W}_{\mathbf{Set}} & \xrightarrow{\mathcal{W}_K} & \mathcal{W}_{\widetilde{\mathbf{Int}}_N} \\
 \text{DDS} \searrow & \xRightarrow{\beta} & \swarrow \text{Mch}_N^{\text{td}} \\
 & \mathbf{Cat} &
 \end{array}$$

*Proof.* We first define the component functor  $\beta_X: \text{DDS}(X) \rightarrow \text{Mch}_N^{\text{td}}(\mathcal{W}_K(X))$  for each box  $X = (X^{\text{in}}, X^{\text{out}}) \in \mathcal{W}_{\mathbf{Set}}$ , mapping a discrete dynamical system on  $X$  to a total and deterministic discrete machine on  $\mathcal{W}_K(X)$ . We then we check that the  $\beta_X$ 's satisfy the necessary naturality and monoidality conditions. For simplicity, denote  $\mathcal{X}^{\text{in}} := K(\widehat{X^{\text{in}}})$  and  $\mathcal{X}^{\text{out}} := K(\widehat{X^{\text{out}}})$ .

A discrete dynamical system on  $X$  is a tuple  $F = (S, f^{\text{upd}}, f^{\text{rdt}})$ , where  $S$  is a set, and  $f^{\text{upd}}: \widehat{X}^{\text{in}} \times S \rightarrow S$  and  $f^{\text{rdt}}: S \rightarrow \widehat{X}^{\text{out}}$  are functions. Define a sheaf  $\mathcal{S} \in \widetilde{\mathbf{Int}}_N$  by

$$\mathcal{S}(n) := \left\{ (x, s): \{0, \dots, n\} \rightarrow \widehat{X}^{\text{in}} \times S \mid s_{i+1} = f^{\text{upd}}(x_i, s_i), \quad 0 \leq i < n \right\} \quad (35)$$

so that the  $(i+1)^{\text{st}}$  state is determined by the  $i^{\text{th}}$  state and input. We can now define  $\beta_X(F)$  to be the span  $(p^i, p^o): \mathcal{S} \rightarrow \mathcal{X}^{\text{in}} \times \mathcal{X}^{\text{out}}$ , where  $p^i(x, s) = x$  and  $p^o(x, s) = f^{\text{rdt}}(s)$ .

The discrete machine  $\beta_X(F)$  is inertial (27), because we can factor  $p^o$  through  $\mathcal{S} \rightarrow \text{Ext}_1 \mathcal{X}^{\text{out}}$ , sending  $(x, s) \in \mathcal{S}(n)$  to the sequence  $\langle f^{\text{rdt}}_{s_0}, \dots, f^{\text{rdt}}_{s_n}, f^{\text{rdt}}(f^{\text{upd}}(x_n, s_n)) \rangle \in \mathcal{X}^{\text{out}}(n+1)$ . Since  $s_{n+1} = f^{\text{upd}}(x_n, s_n)$ , this factorization is compatible with restrictions. The machine is also total and deterministic because the square below as in (31) is a pullback:

$$\begin{array}{ccc} \widehat{X}^{\text{in}} \times \widehat{X}^{\text{in}} \times S & \xrightarrow{(\pi_1, \pi_3)} & \widehat{X}^{\text{in}} \times S \\ (\pi_1, \pi_2) \downarrow & \lrcorner & \downarrow \pi_1 \\ \widehat{X}^{\text{in}} \times \widehat{X}^{\text{in}} & \xrightarrow{\pi_1} & \widehat{X}^{\text{in}} \end{array}$$

For any map of dynamical systems  $F \rightarrow F'$  described in Section 2.3, the function  $h: S \rightarrow S'$  induces a machine morphism given by  $(1 \times h)^{n+1}: \mathcal{S}(n) \rightarrow \mathcal{S}'(n)$ , so  $\beta_X$  is a functor. These are natural in  $X$  because if  $\phi: X \rightarrow Y$  is a wiring diagram, then the following commutes (up to iso):

$$\begin{array}{ccc} \text{DDS}(\widehat{X}^{\text{in}}, \widehat{X}^{\text{out}}) & \xrightarrow{\text{DDS}(\phi)} & \text{DDS}(\widehat{Y}^{\text{in}}, \widehat{Y}^{\text{out}}) \\ \beta_X \downarrow & & \downarrow \beta_Y \\ \text{Mch}_N^{\text{td}}(\mathcal{X}^{\text{in}}, \mathcal{X}^{\text{out}}) & \xrightarrow{\text{Mch}_N^{\text{td}}(K\phi)} & \text{Mch}_N^{\text{td}}(\mathcal{Y}^{\text{in}}, \mathcal{Y}^{\text{out}}) \end{array} \quad (36)$$

Indeed, given a wiring diagram  $\phi: X \rightarrow Y$  as in (7), the formulas (12) for  $\text{DDS}(\phi)$  can be applied to a discrete dynamical system  $(S, f^{\text{upd}}, f^{\text{rdt}})$  to give rise to a new discrete system  $(S, g^{\text{upd}}, g^{\text{rdt}})$ . This is sent by  $\beta_Y$  to the machine

$$\mathcal{T}(n) = \left\{ (y, s): \{0, \dots, n\} \rightarrow \widehat{Y}^{\text{in}} \times S \mid s_{i+1} = f^{\text{upd}}(\widehat{\phi}^{\text{in}}(y_i, f^{\text{rdt}}(s_i)), s_i) \right\}$$

and appropriate input and output maps. On the other hand, one can apply the formula  $\text{Mch}_N(\phi)$  from (21) to the machine  $\mathcal{S} \rightarrow \mathcal{X}^{\text{in}} \times \mathcal{X}^{\text{out}}$  from (35), i.e. take the pullback along  $(\widehat{\phi}^{\text{in}}, \pi_2)$  and post-compose with  $1 \times \widehat{\phi}^{\text{out}}$ . The resulting machines  $\mathcal{T} \rightarrow \mathcal{Y}^{\text{in}} \times \mathcal{Y}^{\text{out}}$  are isomorphic.

Finally we see that  $\beta$  is monoidal, by checking that  $\beta_{X_1+X_2} \circ \text{DDS}_{X_1, X_2} = (\text{Mch}_N^{\text{td}})_{X_1, X_2} \circ (\beta_{X_1} \times \beta_{X_2})$ . This uses DDS-monoidality from Section 2.3 and (23).  $\square$

We now find an analogous map that transforms continuous dynamical systems (Definition 2.3.2) to continuous machines (Definition 4.1.1). Because we will be comparing different sorts of machines, we will denote continuous machines by  $\text{Mch}_C$  rather than simply by  $\text{Mch}$ .

Let  $C^\infty: \mathbf{Euc} \rightarrow \widetilde{\mathbf{Int}}$  be the functor mapping a space  $A$  to the sheaf  $C^\infty(A)$  of  $C^\infty$ -trajectories in  $X$ , as described in Example 3.2.4 # 4, which has as length- $\ell$  sections all smooth functions  $f: [0, \ell] \rightarrow A$ . This functor preserves all finite limits, and it induces a strong monoidal functor  $\mathcal{W}_{C^\infty}: \mathcal{W}_{\mathbf{Euc}} \rightarrow \mathcal{W}_{\widetilde{\mathbf{Int}}}$  again by (8).

**Proposition 5.1.2.** *There exists a  $\mathcal{W}_{\mathbf{Euc}}$ -algebra map*

$$\begin{array}{ccc} \mathcal{W}_{\mathbf{Euc}} & \xrightarrow{\mathcal{W}_{C^\infty}} & \mathcal{W}_{\widetilde{\mathbf{Int}}} \\ & \searrow \text{CDS} & \swarrow \text{Mch}_C \\ & \text{Cat} & \end{array} \quad \begin{array}{c} \delta \\ \cong \end{array}$$

*Proof.* We first define the components  $\delta_X: \text{CDS}(X) \rightarrow \text{Mch}_C(\mathcal{W}_{C^\infty}(X))$  for each box  $X = (X^{\text{in}}, X^{\text{out}}) \in \mathcal{W}_{\mathbf{Euc}}$ , mapping a continuous dynamical system on  $X$  to a continuous machine on  $\mathcal{W}_{C^\infty}(X)$ . We then check that the  $\delta_X$  satisfy the necessary naturality and monoidality conditions. Denote by  $\mathcal{X}_1, \mathcal{X}_2$  the sheaves  $C^\infty(\widehat{X}^{\text{in}}), C^\infty(\widehat{X}^{\text{out}})$  associated to the box  $\mathcal{W}_{C^\infty}(X)$  from Example 3.2.4 # 4.

By Definition 2.3.2 a continuous dynamical system on  $X$  is a tuple  $F = (S, f^{\text{dyn}}, f^{\text{rdt}})$ , where  $S$  is a smooth manifold,  $f^{\text{dyn}}: \widehat{X}^{\text{in}} \times S \rightarrow TS$  is the dynamics, and  $f^{\text{rdt}}: S \rightarrow \widehat{X}^{\text{out}}$  is a smooth map. Define a sheaf  $\mathcal{S} \in \widetilde{\mathbf{Int}}$  by

$$\mathcal{S}(\ell) := \left\{ (x, s): [0, \ell] \rightarrow \widehat{X}^{\text{in}} \times S \mid x, s \text{ are smooth and } \frac{ds}{dt} = f^{\text{dyn}}(x, s) \right\} \quad (37)$$

where  $\frac{ds}{dt}$  is the derivative of  $s: [0, \ell] \rightarrow S$ ; notice that the trajectory  $s$  is a solution to the differential equation defining the dynamical system. We can now define  $\delta_X(F)$  to be the span  $\mathcal{X}^{\text{in}} \leftarrow \mathcal{S} \rightarrow \mathcal{X}^{\text{out}}$  where the maps send  $(x, s)$  to  $x$  and to  $f^{\text{rdt}}(s)$  respectively.

We next define  $\delta_X$  on morphisms, using the chain rule. Given a second dynamical system  $F' = (S', f'^{\text{dyn}}, f'^{\text{rdt}})$  inhabiting  $X$ , a map  $F \rightarrow F'$  consists of a smooth function  $q: S \rightarrow S'$  such that  $f'^{\text{rdt}} \circ q = f^{\text{rdt}}$  and such that the right-hand square commutes in the diagram below:

$$\begin{array}{ccccc} [0, \ell] & \xrightarrow{(x, s)} & \widehat{X}^{\text{in}} \times S & \xrightarrow{\text{id}_{\widehat{X}^{\text{in}}} \times q} & \widehat{X}^{\text{in}} \times S' \\ & \searrow \frac{ds}{dt} & \downarrow f^{\text{dyn}} & & \downarrow f'^{\text{dyn}} \\ & & TS & \xrightarrow{\frac{dq}{ds}} & TS' \end{array}$$

We want  $\delta_X: \delta_X(F) \rightarrow \delta_X(F')$ , which consists of a sheaf map  $\mathcal{S} \rightarrow \mathcal{S}'$  over  $\mathcal{X}^{\text{in}} \times \mathcal{X}^{\text{out}}$ . For any  $(x, s) \in \mathcal{S}(\ell)$ , the left-hand triangle commutes, i.e.  $\frac{ds}{dt} = f^{\text{dyn}}(x, s)$ . Thus the outer shape does too, so we find that  $(x, q(s)) \in \mathcal{S}'(\ell)$  by the chain rule:

$$f'^{\text{dyn}}(x, q(s)) = \frac{dq}{ds} \frac{ds}{dt} = \frac{d(q \circ s)}{dt}.$$

It is easy to check that this map commutes with the projections to  $\mathcal{X}^{\text{in}} \times \mathcal{X}^{\text{out}}$ .



We will now show naturality and monoidality of  $\delta$ , similarly to (36). Suppose  $\phi: X \rightarrow Y$  like (7). The new machine  $T := \text{Mch}_C(\phi)(\delta_X(F))$  is defined by

$$\mathcal{T}(\ell) = \left\{ (y, s): [0, \ell] \rightarrow \widehat{Y}^{\text{in}} \times S \mid \frac{ds}{dt} = f^{\text{dyn}}(s, \widehat{\phi}^{\text{in}}(y, f^{\text{rdt}}(s))) \right\}$$

by applying construction (21): first take  $S$ 's pullback along  $(\widehat{\phi}^{\text{in}}, \pi_2)$  and the post-compose with  $(1 \times \widehat{\phi}^{\text{out}})$ . This composite  $\mathcal{T} \rightarrow \mathcal{Y}^{\text{in}} \times \mathcal{Y}^{\text{out}}$  is equal to  $\delta_X(\text{CDS}(\phi)(F))$  as can be seen through (13). It can also be verified that  $\delta$  is a monoidal transformation, by checking that  $\delta_{X_1+X_2} \circ \text{CDS}_{X_1, X_2} = \text{Mch}_{x_1, x_2} \circ (\delta_{X_1} \times \delta_{X_2})$ .  $\square$

*Remark 5.1.3.* Unlike in Proposition 5.1.1, the algebra map  $\delta$  from Proposition 5.1.2 does not factor through  $\text{Mch}_C^{\text{td}}$ . For example, the dynamical system  $\dot{y} = y^2$  (inhabiting the closed box  $\square$ ) is not total. Indeed, the initial value  $y(0) = 1$  extends to a solution  $y = \frac{1}{1-t}$  that exists only for  $t < 1$ . Similarly, the dynamical system  $\dot{y} = 2\sqrt{|y|}$  is not deterministic. Indeed, the initial value  $y(0) = 0$  has the following solution for any  $a$ :

$$\begin{cases} y = 0 & \text{if } t \leq a \\ y = (t - a)^2 & \text{if } t \geq a \end{cases}$$

*Remark 5.1.4.* For certain applications it is necessary to slightly generalize the machine obtained from a continuous dynamical system. For any  $-1 \leq m \leq n \leq \infty$  we can define  $\delta^{m,n}: \text{CDS}(A, B) \rightarrow \text{Mch}_C(C^{m,n}A, C^{m+1, n+1}B)$  as the span  $C^{m,n}(\widehat{X}^{\text{in}}) \leftarrow S \rightarrow C^{m+1, n+1}(\widehat{X}^{\text{out}})$  where  $S$  is a sheaf generalizing that in (37). Namely, its length- $\ell$  sections are defined to be:

$$\mathcal{S}(\ell) := \left\{ (x, s): [0, \ell] \rightarrow \widehat{X}^{\text{in}} \times S \mid \begin{array}{l} x \in C^{m,n}(\widehat{X}^{\text{in}}), s \in C^{m+1, n+1}(S), \text{ and} \\ x \in C^n \Rightarrow \left( s \in C^{n+1} \text{ and} \right. \\ \left. \frac{ds}{dt} = f^{\text{dyn}}(x, s) \right) \end{array} \right\}$$

## 5.2 Maps between machines

In this section, we provide maps between machines over the toposes of continuous, discrete, and synchronous sheaves discussed in Chapter 4. These algebra maps naturally group together according to whether they refer to only abstract machines, or to total or deterministic variations. To put this into a convenient framework, we will generalize many earlier constructions.

Define the category of *wiring-diagram algebras*, denoted  $\mathbf{WD-Alg}$ , to be the lax slice category  $\mathbf{WD-Alg} := \mathbf{SMC}_\ell / \mathbf{Cat}$ , which has a forgetful functor  $U: \mathbf{WD-Alg} \rightarrow \mathbf{SMC}_\ell$ . To be explicit, the objects of  $\mathbf{WD-Alg}$  are pairs  $(\mathcal{W}, A)$ , where  $\mathcal{W}$  is a symmetric monoidal category and  $A: \mathcal{W} \rightarrow \mathbf{Cat}$  is a lax symmetric monoidal functor,<sup>9</sup> and the morphisms of  $\mathbf{WD-Alg}$  are

<sup>9</sup>In fact,  $A$  should be a lax symmetric monoidal pseudofunctor and  $\alpha: A \rightarrow A'H$  should pseudo-natural; we sweep these details under the rug as discussed in Remark 2.1.2.

lax monoidal functors together with monoidal natural transformations

$$\begin{array}{ccc} \mathcal{W} & \xrightarrow{H} & \mathcal{W}' \\ & \searrow A \quad \xRightarrow{\alpha} \quad \swarrow A' & \\ & \mathbf{Cat} & \end{array}$$

Our algebras  $A: \mathcal{W} \rightarrow \mathbf{Cat}$  from Chapter 4 are typical objects of  $\mathbf{WD-Alg}$ , and our present goal is to find maps between them. In this article, we will not have occasion to consider 2-morphisms in  $\mathbf{WD-Alg}$ .

### 5.2.1 Abstract machines

Recall the functor  $\mathcal{W}_{(-)}: \mathbf{Cat} \rightarrow \mathbf{SMC}_s \subseteq \mathbf{SMC}_\ell$  from (8). Let  $\mathbf{FCCat}$  denote the category of finitely-complete categories and finite limit preserving functors between them.

**Proposition 5.2.1.** *There exists a dotted lift making the diagram below commute:*

$$\begin{array}{ccc} & & \mathbf{WD-Alg} \\ & \nearrow \text{Mch}_{(-)} & \downarrow U \\ \mathbf{FCCat} & \xrightarrow{\mathcal{W}_{(-)}} & \mathbf{SMC}_\ell \end{array}$$

*Proof.* The functor  $\text{Mch}_{(-)}$  applied to an object  $\mathcal{C} \in \mathbf{FCCat}$  is supposed to be a lax monoidal functor  $\text{Mch}_{\mathcal{C}}: \mathcal{W}_{\mathcal{C}} \rightarrow \mathbf{Cat}$ . We define it on an object  $X = (X^{\text{in}}, X^{\text{out}}) \in \mathcal{W}_{\mathcal{C}}$  to be the category

$$\text{Mch}_{\mathcal{C}}(X) := \mathcal{C} / (\widehat{X^{\text{in}}} \times \widehat{X^{\text{out}}}).$$

For a morphism, i.e. wiring diagram,  $\phi = (\phi^{\text{in}}, \phi^{\text{out}}): X \rightarrow Y$ , we define  $\text{Mch}_{\mathcal{C}}(\phi): \text{Mch}_{\mathcal{C}}(X) \rightarrow \text{Mch}_{\mathcal{C}}(Y)$  to be the functor

$$\text{Mch}_{\mathcal{C}}(\phi) := (1 \times \widehat{\phi^{\text{out}}})_! \circ (\widehat{\phi^{\text{in}}}, \pi_2)^*$$

as in Remark 4.1.4. The lax monoidal structure is given by the cartesian product as in (23).

Now given a functor  $F: \mathcal{C} \rightarrow \mathcal{D}$  which preserves finite limits, we have a monoidal functor  $\mathcal{W}_F: \mathcal{W}_{\mathcal{C}} \rightarrow \mathcal{W}_{\mathcal{D}}$  as in (8). We need a monoidal natural transformation  $\text{Mch}_F$  as in the diagram below:

$$\begin{array}{ccc} \mathcal{W}_{\mathcal{C}} & \xrightarrow{\mathcal{W}_F} & \mathcal{W}_{\mathcal{D}} \\ & \searrow \text{Mch}_{\mathcal{C}} \quad \xRightarrow{\text{Mch}_F} \quad \swarrow \text{Mch}_{\mathcal{D}} & \\ & \mathbf{Cat} & \end{array}$$

For each box  $X \in \mathcal{W}_{\mathcal{C}}$ , we need a component  $\text{Mch}_F(X): \text{Mch}_{\mathcal{C}}(X) \rightarrow \text{Mch}_{\mathcal{D}}(FX)$ . To any span  $p: S \rightarrow \widehat{X^{\text{in}}} \times \widehat{X^{\text{out}}}$  we assign  $\text{Mch}_F(X)(p) := Fp$ , where  $Fp: FS \rightarrow F(\widehat{X^{\text{in}}} \times \widehat{X^{\text{out}}}) \cong F\widehat{X^{\text{in}}} \times F\widehat{X^{\text{out}}}$ . Monoidality follows by  $F(p \times q) \cong Fp \times Fq$  and pseudonaturality follows from the fact that  $F$  preserves pullbacks.  $\square$

For  $\mathcal{C} = \widetilde{\mathbf{Int}}, \widetilde{\mathbf{Int}}_N$ , and  $\widetilde{\mathbf{Int}}_{\text{Sync}}$ , the functor  $\text{Mch}_{(-)}$  from Proposition 5.2.1 recovers the algebras  $\text{Mch}_C$ ,  $\text{Mch}_N$ , and  $\text{Mch}_{\text{Sync}}$  described at Propositions 4.1.3, 4.4.3 and 4.4.5. Because the functors  $\Sigma'_i: \widetilde{\mathbf{Int}}_N \rightarrow \widetilde{\mathbf{Int}}/\text{Sync}$  from (18) and  $\Delta_{\text{Sync}!}: \widetilde{\mathbf{Int}} \rightarrow \widetilde{\mathbf{Int}}/\text{Sync}$  from (19) preserve finite limits, they induce algebra morphisms.

**Corollary 5.2.2.** *There exist algebra maps  $\text{Mch}_{\Sigma'_i}$  and  $\text{Mch}_{\Delta_{\text{Sync}!}}$  realizing any continuous or discrete machine as a synchronous one:*

$$\begin{array}{ccc}
 \mathcal{W}_{\widetilde{\mathbf{Int}}_N} & \xrightarrow{\mathcal{W}_{\Sigma'_i}} & \mathcal{W}_{\widetilde{\mathbf{Int}}/\text{Sync}} \\
 \searrow \text{Mch}_N & \Downarrow \text{Mch}_{\Sigma'_i} \Rightarrow & \swarrow \text{Mch}_{\text{Sync}} \\
 & \mathbf{Cat} & 
 \end{array}
 \qquad
 \begin{array}{ccc}
 \mathcal{W}_{\widetilde{\mathbf{Int}}} & \xrightarrow{\mathcal{W}_{\Delta_{\text{Sync}!}}} & \mathcal{W}_{\widetilde{\mathbf{Int}}/\text{Sync}} \\
 \searrow \text{Mch}_C & \Downarrow \text{Mch}_{\Delta_{\text{Sync}!}} \Rightarrow & \swarrow \text{Mch}_{\text{Sync}} \\
 & \mathbf{Cat} & 
 \end{array}$$

Similarly, we have algebra maps  $\text{Mch}_U: \text{Mch}_C \Rightarrow \text{Mch}_{\text{Psh}(\mathbf{Int})} \circ \mathcal{W}_U$  and  $\text{Mch}_{\text{asSh}}: \text{Mch}_{\text{Psh}(\mathbf{Int})} \Rightarrow \text{Mch}_C \circ \mathcal{W}_{\text{asSh}}$  associated to the underlying presheaf functor  $U: \widetilde{\mathbf{Int}} \rightarrow \text{Psh}(\mathbf{Int})$  and sheafification  $\text{asSh}: \text{Psh}(\mathbf{Int}) \rightarrow \widetilde{\mathbf{Int}}$ .

### 5.2.2 Maps preserving totality and determinism

Totality and determinism of machines requires a notion of extension: for any extension of input there exists (or is at most one) extension of state to match. In this section we abstract all the necessary structure to make sense of this at the level of generality of Section 5.2.1. Doing so will allow us to express conditions of inertiality and totality/determinism from Proposition 4.2.1 and Definition 4.2.3. We begin with a preliminary definition.

**Definition 5.2.3.** We define a *Euclidean poset* to be a poset  $(E, \leq)$  equipped with a symmetric monoidal structure  $(0, +)$  such that

- the unit is minimal:  $0 \leq e$  for all  $e \in E$ ,
- for all  $a, b \in E$ , if  $b \neq 0$  then there exists  $N \in \mathbb{N}$  and  $r \in E$  such that

$$a = N \cdot b + r \quad \text{and} \quad r \leq b$$

where  $N \cdot b := b + \dots + b$  ( $N$  times).

A *morphism* of Euclidean posets is a strong monoidal functor.

**Lemma 5.2.3.** *Suppose  $v: E \rightarrow E'$  is a morphism of Euclidean posets. If there exists  $b \neq 0$  such that  $v(b) = 0$  then  $v(a) = 0$  for all  $a$ .*

If  $v(e) = 0$  for all  $e \in E$ , we call  $v$  a *trivial morphism*; otherwise we call it a *nontrivial morphism*.

To cast totality at this level of generality, we need our categories and functors to be regular, rather than just finitely-complete. Recall that every topos is a regular category and every epimorphism in a topos is regular. Let  $\mathbf{RegCat}$  denote the 2-category of regular categories and functors, with all natural transformations between them. See [Bar71] or [Joh02] for more on regular categories and functors.

**Definition 5.2.4.** Suppose  $\mathcal{C} \in \mathbf{RegCat}$  is a regular category. Let  $\text{End}(\mathcal{C})$  denote the monoidal category of endomaps of  $\mathcal{C}$ , i.e. its objects are regular functors  $\mathcal{C} \rightarrow \mathcal{C}$ , its monoidal structure is given by functor composition, and its morphisms are natural transformations  $\lambda$ . We define an *extension structure* on  $\mathcal{C}$  to be a pair  $(E, \text{Ext})$ , where  $(E, \leq, 0, +)$  is a Euclidean poset and  $\text{Ext}: E^{\text{op}} \rightarrow \text{End}(\mathcal{C})$  is a strong monoidal functor.

Given an extension structure on  $\mathcal{C}$ , we say that a map  $p: S \rightarrow A$  in  $\mathcal{C}$  is *Ext-inertial* if there exists  $0 \neq e \in E$  such that  $p$  factors through  $\lambda_e: \text{Ext}_e(A) \rightarrow \text{Ext}_0(A) = A$ . For any box  $X \in \mathcal{W}_{\mathcal{C}}$ , we say that a machine  $(p^i, p^o): S \rightarrow \widehat{X}^{\text{in}} \times \widehat{X}^{\text{out}}$  is *Ext-inertial* if  $p^o$  is. Define  $\text{Mch}_{\mathcal{C}}^{\text{in}}(X) \subseteq \text{Mch}_{\mathcal{C}}(X)$  to be the full subcategory of all Ext-inertial machines on  $X$ .

Let us briefly spell out what it means for the functor  $\text{Ext}: E^{\text{op}} \rightarrow \text{End}(\mathcal{C})$  to be strong monoidal. This means:

- for all  $e \in E$ , the functor  $\text{Ext}_e: \mathcal{C} \rightarrow \mathcal{C}$  preserves finite limits and regular epimorphisms;
- $\text{Ext}_0 = \text{id}_{\mathcal{C}}$ , and for all  $a, b \in E$ , we have  $\text{Ext}_{a+b} = \text{Ext}_a \circ \text{Ext}_b$ ;
- for any  $e' \leq e$  there is a chosen map which we will denote  $\lambda_{e,e'}: \text{Ext}_e \rightarrow \text{Ext}_{e'}$ . When  $e' = 0$  we write abbreviate  $\lambda_{e,0}$  by  $\lambda_e: \text{Ext}_e \rightarrow \text{id}_{\mathcal{C}}$ ; and
- for all  $a, b \in E$ , there exist  $N \in \mathbb{N}$  and  $r \in E$  such that  $\text{Ext}_a = \text{Ext}_b^N \circ \text{Ext}_r$ .

**Lemma 5.2.4.** Let  $\mathcal{C}$  be a regular category with extension structure  $\text{Ext}: E^{\text{op}} \rightarrow \text{End}(\mathcal{C})$ . Given  $e \in E$  and  $p: S \rightarrow A$ , define  $h_e: \text{Ext}_e S \rightarrow S_e$  to be the induced map, where  $S_e$  is the pullback:

$$\begin{array}{ccccc}
 \text{Ext}_e S & & \xrightarrow{\lambda_e S} & & S \\
 \downarrow h_e & & \searrow & & \downarrow \lambda'_e \\
 S_e & \xrightarrow{\lambda'_e} & S & & \\
 \downarrow p_e & \lrcorner & \downarrow p & & \\
 \text{Ext}_e A & \xrightarrow{\lambda_e A} & A & & 
 \end{array} \tag{38}$$

Then the following are equivalent:

1. For all  $e \in E$  the map  $h_e: \text{Ext}_e S \rightarrow S_e$  is a regular epimorphism (resp. a monomorphism, an isomorphism).
2. There exists  $0 \neq d \in E$  such that for all  $d' \leq d$ , the map  $h_{d'}: \text{Ext}_{d'} S \rightarrow S_{d'}$  is a regular epimorphism (resp. a monomorphism, an isomorphism).

*Proof.* Clearly  $1 \Rightarrow 2$ , so assume the latter holds for  $d \neq 0$ . By the assumption that  $E$  is a Euclidean poset, it suffices to show that for any  $a, b \in E$  and  $p: S \rightarrow A$ , if both  $h_a$  and  $h_b$  have property **P**, where **P** is the property of being a regular epimorphism (resp. a monomorphism, an isomorphism) then so does  $h_{a+b}$ .

Consider the two diagrams below, where the left-hand diagram is as in (38):

$$\begin{array}{ccc}
 & & \text{Ext}_{a+b}S \\
 & & \text{Ext}_b h_a \downarrow \\
 \text{Ext}_a S & & \text{Ext}_b S_a \xrightarrow{\text{Ext}_b \lambda_a} \text{Ext}_b S \\
 h_a \downarrow & & \lrcorner \quad \quad \quad \lrcorner \\
 S_a \xrightarrow{\lambda'_a} S & & S_{a+b} \xrightarrow{\lambda'_a} S_b \xrightarrow{\lambda'_b} S \\
 p_a \downarrow \lrcorner & & \lrcorner \quad \quad \quad \lrcorner \quad \quad \quad \lrcorner \\
 \text{Ext}_a A \xrightarrow{\lambda_a} A & & \text{Ext}_{a+b} A \xrightarrow{\lambda_a(\text{Ext}_b A)} \text{Ext}_b A \xrightarrow{\lambda_b} A \\
 & & \text{Ext}_b p_a \curvearrowright
 \end{array}$$

For the right-hand diagram, begin by forming the two bottom pullback squares. By definition of  $h_b$  (38), we have  $\text{Ext}_b p = p_b \circ h_b$ , so the vertical rectangle is an application of  $\text{Ext}_b$  to the left-hand diagram, and is thus a pullback because  $\text{Ext}_b$  is regular. There is an induced map  $h: \text{Ext}_b S_a \rightarrow S_{a+b}$ , and we now have that each indicated square in the diagram is a pullback.

Since  $\text{Ext}_{a+b} p = \text{Ext}_b \text{Ext}_a p = \text{Ext}_b p_a \circ \text{Ext}_b h_a$  is the long vertical map, the universal property of pullback implies that  $h \circ \text{Ext}_b h_a = h_{a+b}$ . If  $h_a$  and  $h_b$  have property **P** then so does  $h_{a+b}$  because its factors  $h$  and  $\text{Ext}_b h_a$  do: **P** is stable under pullbacks and  $\text{Ext}_b$  preserves **P**.  $\square$

**Definition 5.2.5.** Let  $\mathcal{C}$  be a regular category with extension structure  $\text{Ext}: E^{\text{op}} \rightarrow \text{End}(\mathcal{C})$ , and let  $p: S \rightarrow B$  be a morphism. We say that  $p$  is *Ext-total* (resp. *Ext-deterministic*, *Ext-total-deterministic*) if the map  $h_e$  in (38) is a regular epimorphism (resp. a monomorphism, an isomorphism) for all  $e \in E$ .

Let  $X \in \mathcal{W}_{\mathcal{C}}$  be a box, and let  $\text{Mch}_{\mathcal{C}}^{\text{in}}(X)$  be the category of Ext-inertial machines as in Definition 5.2.4. We say that an Ext-inertial machine  $(p^i, p^o) \in \text{Mch}_{\mathcal{C}}^{\text{in}}(X)$  is *Ext-total* (resp. *Ext-deterministic*, *Ext-total-deterministic*) if  $p^i$  is. Define  $\text{Mch}_{\mathcal{C}}^{\text{t}}(X), \text{Mch}_{\mathcal{C}}^{\text{d}}(X), \text{Mch}_{\mathcal{C}}^{\text{td}}(X) \subseteq \text{Mch}_{\mathcal{C}}^{\text{in}}(X)$  to be the full subcategories of all Ext-total (resp. Ext-deterministic, Ext-total-deterministic) machines on  $X$ .

*Example 5.2.6.* For any  $\epsilon \geq 0$  the functor  $\text{Ext}_{\epsilon}: \widetilde{\mathbf{Int}} \rightarrow \widetilde{\mathbf{Int}}$ , as in Definition 3.2.6, is an endomorphism of  $\widetilde{\mathbf{Int}}$ ; we showed it is finitely complete in Lemma 3.2.2, and it is not hard to check that it preserves epimorphisms (all of which are regular). The poset  $E = (\mathbb{R}_{>0}, \geq)$  of positive reals is a Euclidean poset, and the left restriction maps  $\text{Ext}_{\epsilon} \rightarrow \text{Ext}_{\epsilon'}$  for any  $\epsilon \geq \epsilon'$  constitute an extension structure  $\text{Ext}: E^{\text{op}} \rightarrow \text{End}(\widetilde{\mathbf{Int}})$ . This extension structure can be lifted to one on  $\widetilde{\mathbf{Int}}/\text{Sync}$ . Namely, for every  $e \in \mathbb{R}_{\geq 0}$ , we define  $\text{Ext}_e(X \rightarrow \text{Sync})$  to be the composite  $\text{Ext}_e X \rightarrow \text{Ext}_e(\text{Sync}) \xrightarrow{\lambda_e} \text{Sync}$ . There is also an extension structure on  $\widetilde{\mathbf{Int}}_N$ , such that Definition 5.2.4 generalizes the definitions in Section 4.4, by taking  $E = \mathbb{N}$ .

In all the above cases, the notions of inertial, total, deterministic, and total-deterministic morphisms and machines from Definition 5.2.4 generalize the older notions.

**Proposition 5.2.7.** *Let  $\mathcal{C}$  be a finitely complete category and  $\text{Ext}: E^{\text{op}} \rightarrow \text{End}(\mathcal{C})$  an extension structure on it. Then there are lax monoidal functors*

$$\text{Mch}_{\mathcal{C}}^{\text{in}}, \text{Mch}_{\mathcal{C}}^{\text{t}}, \text{Mch}_{\mathcal{C}}^{\text{d}}, \text{Mch}_{\mathcal{C}}^{\text{td}}: \mathcal{W}_{\mathcal{C}} \longrightarrow \mathbf{Cat}$$

which are subalgebras of  $\text{Mch}_{\mathcal{C}}$  and which agree with Definition 5.2.4 when applied to any  $X \in \mathcal{W}_{\mathcal{C}}$ .

*Proof.* The proof for inertiality closely follows that of Proposition 4.3.1, and totality and determinism follow that of Proposition 4.3.2.  $\square$

**Definition 5.2.8.** Let  $(\mathcal{C}, E, \text{Ext})$  and  $(\mathcal{C}', E', \text{Ext}')$  be regular categories with extension structures. A *morphism* between them is a pair  $(F, \nu)$  where  $F: \mathcal{C} \rightarrow \mathcal{C}'$  is a regular functor,  $\nu: E \rightarrow E'$  is a nontrivial morphism of Euclidean posets, and such that for all  $e \in E$  the following diagram commutes (up to natural isomorphism)

$$\begin{array}{ccc} \mathcal{C} & \xrightarrow{\text{Ext}_e} & \mathcal{C} \\ F \downarrow & & \downarrow F \\ \mathcal{C}' & \xrightarrow{\text{Ext}'_{\nu(e)}} & \mathcal{C}' \end{array}$$

Thus we have described a category of *regular categories with extensions*, denoted  $\mathbf{RegCat}_e$ . It comes with a forgetful functor  $U: \mathbf{RegCat}_e \rightarrow \mathbf{RegCat} \rightarrow \mathbf{FCCat}$ .

**Theorem 5.2.9.** *Recall the functor  $\text{Mch}_{(-)}: \mathbf{FCCat} \rightarrow \mathbf{WD-Alg}$  from Proposition 5.2.1. There are subfunctors  $\text{Mch}_{(-)}^{\text{in}}, \text{Mch}_{(-)}^{\text{t}}, \text{Mch}_{(-)}^{\text{d}}, \text{Mch}_{(-)}^{\text{td}}$  as in the diagram*

$$\begin{array}{ccc} \mathbf{RegCat}_e & \xrightarrow{U} & \mathbf{FCCat} \\ & \searrow & \swarrow \\ & \mathbf{WD-Alg} & \end{array}$$

$\text{Mch}_{(-)}^{\text{in}}, \text{Mch}_{(-)}^{\text{t}}, \text{Mch}_{(-)}^{\text{d}}, \text{Mch}_{(-)}^{\text{td}}$        $\text{Mch}_{(-)}$

which agree with Proposition 5.2.7 when applied to any object  $\text{Ext}: E^{\text{op}} \rightarrow \text{End}(\mathcal{C})$  in  $\mathbf{RegCat}_e$ .

*Proof.* These subfunctors of  $\text{Mch}_{(-)} \circ U$  have been defined on objects of  $\mathbf{RegCat}_e$ , so suppose given a morphism  $(F, \nu): (\mathcal{C}, E, \text{Ext}) \rightarrow (\mathcal{C}', E', \text{Ext}')$  as in Definition 5.2.8. We need a 2-cell in each diagram below

$$\begin{array}{ccc} \mathcal{W}_{\mathcal{C}} & \xrightarrow{\mathcal{W}_F} & \mathcal{W}_{\mathcal{C}'} \\ \text{Mch}_{\mathcal{C}}^{\text{in}} \searrow & \xRightarrow{\text{Mch}_F^{\text{in}}} & \swarrow \text{Mch}_{\mathcal{C}'}^{\text{in}} \\ & \mathbf{Cat} & \end{array} \quad \begin{array}{ccc} \mathcal{W}_{\mathcal{C}} & \xrightarrow{\mathcal{W}_F} & \mathcal{W}_{\mathcal{C}'} \\ \text{Mch}_{\mathcal{C}}^{\text{t}} \searrow & \xRightarrow{\text{Mch}_F^{\text{t}}} & \swarrow \text{Mch}_{\mathcal{C}'}^{\text{t}} \\ & \mathbf{Cat} & \end{array} \quad \begin{array}{ccc} \mathcal{W}_{\mathcal{C}} & \xrightarrow{\mathcal{W}_F} & \mathcal{W}_{\mathcal{C}'} \\ \text{Mch}_{\mathcal{C}}^{\text{d}} \searrow & \xRightarrow{\text{Mch}_F^{\text{d}}} & \swarrow \text{Mch}_{\mathcal{C}'}^{\text{d}} \\ & \mathbf{Cat} & \end{array}$$

Since each of these variations is a subalgebra of  $\text{Mch}_{(-)}$ , it suffices to choose an object  $X \in \mathcal{W}_{\mathcal{C}}$  and prove that a dashed arrow exist for each diagram below, making it commute

in  $\mathbf{Cat}$ :

$$\begin{array}{ccccc}
 \text{Mch}_{\mathcal{C}}^{\text{in}}(X) & \dashrightarrow & \text{Mch}_{\mathcal{C}'}^{\text{in}}(FX) & & \text{Mch}_{\mathcal{C}}^{\text{t}}(X) & \dashrightarrow & \text{Mch}_{\mathcal{C}'}^{\text{t}}(FX) & & \text{Mch}_{\mathcal{C}}^{\text{d}}(X) & \dashrightarrow & \text{Mch}_{\mathcal{C}'}^{\text{d}}(FX) \\
 \downarrow & & \downarrow & & \downarrow & & \downarrow & & \downarrow & & \downarrow \\
 \text{Mch}_{\mathcal{C}}(X) & \longrightarrow & \text{Mch}_{\mathcal{C}'}(FX) & & \text{Mch}_{\mathcal{C}}(X) & \longrightarrow & \text{Mch}_{\mathcal{C}'}(FX) & & \text{Mch}_{\mathcal{C}}(X) & \longrightarrow & \text{Mch}_{\mathcal{C}'}(FX)
 \end{array}$$

For inertial machines the existence of a dashed arrow is implied by the fact that  $\nu$  is nontrivial and  $F\text{Ext}_e \cong \text{Ext}_{\nu(e)}F$  for all  $e \in E$ . For total (resp. deterministic) machines, the existence of a dashed arrow is implied by the fact that  $\text{Ext}_e$  preserves regular epimorphisms (resp. monomorphisms) for all  $e$ .  $\square$

We can apply Theorem 5.2.9 to the regular categories  $\widetilde{\mathbf{Int}}$ ,  $\widetilde{\mathbf{Int}}_{\mathbb{N}}$ , and  $\widetilde{\mathbf{Int}}/\text{Sync}$  and to the regular functors  $\Sigma'_i: \widetilde{\mathbf{Int}}_{\mathbb{N}} \rightarrow \widetilde{\mathbf{Int}}/\text{Sync}$  and  $\Delta_{\text{Sync!}}: \widetilde{\mathbf{Int}} \rightarrow \widetilde{\mathbf{Int}}/\text{Sync}$ .

**Corollary 5.2.10.** *Let  $\mathbf{x} \in \{\text{i}, \text{t}, \text{d}, \text{td}\}$  stand for inertial, total, deterministic, or total-deterministic. There are algebra maps*

$$\begin{array}{ccc}
 \mathcal{W}_{\widetilde{\mathbf{Int}}_{\mathbb{N}}} & \xrightarrow{\mathcal{W}_{\Sigma'_i}} & \mathcal{W}_{\widetilde{\mathbf{Int}}/\text{Sync}} \\
 \searrow \text{Mch}_{\mathbb{N}}^{\mathbf{x}} & \text{Mch}_{\Sigma'_i}^{\mathbf{x}} \Rightarrow & \swarrow \text{Mch}_{\text{Sync}}^{\mathbf{x}} \\
 & \mathbf{Cat} & 
 \end{array}
 \qquad
 \begin{array}{ccc}
 \mathcal{W}_{\widetilde{\mathbf{Int}}} & \xrightarrow{\mathcal{W}_{\Delta_{\text{Sync!}}}} & \mathcal{W}_{\widetilde{\mathbf{Int}}/\text{Sync}} \\
 \searrow \text{Mch}_{\mathcal{C}}^{\mathbf{x}} & \text{Mch}_{\Delta_{\text{Sync!}}}^{\mathbf{x}} \Rightarrow & \swarrow \text{Mch}_{\text{Sync}}^{\mathbf{x}} \\
 & \mathbf{Cat} & 
 \end{array}$$

*Proof.* Both  $\Sigma'_i: \widetilde{\mathbf{Int}}_{\mathbb{N}} \rightarrow \widetilde{\mathbf{Int}}/\text{Sync}$  and  $\Delta_{\text{Sync!}}: \widetilde{\mathbf{Int}} \rightarrow \widetilde{\mathbf{Int}}/\text{Sync}$  are the inverse image parts of geometric morphisms, so they are regular. Clearly  $(\Delta_{\text{Sync!}}, \text{id}_{\mathbb{R}_{\geq 0}})$  is a map in  $\mathbf{RegCat}_e$  so the result follows from Theorem 5.2.9 in that case. The inclusion  $\nu: \mathbb{N} \rightarrow \mathbb{R}_{\geq 0}$  is a nontrivial morphism of Euclidean posets, so to complete the proof, we need to show that  $\Sigma'_i \circ \text{Ext}_n \cong \text{Ext}_{\nu(n)} \circ \Sigma'_i$  for any  $n \in \mathbb{N}$ . It suffices to show this for  $n = 1$ , whence  $\nu(n) = 1$ .

Recall from Proposition 3.3.3 the formula

$$\Sigma'_i X(\ell) \cong \bigsqcup_{r \in [0,1)} X(\lceil r + \ell \rceil)$$

where the extra data of  $\Sigma'_i X$  is just the map  $\Sigma_X \rightarrow \text{Sync}$  given by  $r$ . Thus the result follows from the equation  $\lceil \ell + r + 1 \rceil = \lceil \ell + r \rceil + 1$ .  $\square$

*Remark 5.2.11.* The only reason we need to work with regular categories and functors is for totalness. We can replace  $\mathbf{RegCat}$  by  $\mathbf{FCCat}$  and Theorem 5.2.9 will still hold for inertial, deterministic, and total-deterministic machines. That is, in Definition 5.2.4, we could ask only that  $\mathcal{C}$  be finitely complete, and that endofunctors  $(\mathcal{C} \rightarrow \mathcal{C}) \in \text{End}(\mathcal{C})$  preserve finite limits. Similarly we can drop condition that our functors  $F: \mathcal{C} \rightarrow \mathcal{C}'$  be regular, insisting only that they be finitely-complete. Then Lemma 5.2.4 holds for monomorphisms and isomorphisms, and we can define inertial, deterministic, (not total), and total-deterministic maps and machines as in Definition 5.2.5. Definition 5.2.8 and finally Theorem 5.2.9 go through (except for  $\mathbf{x}=\text{total}$ ) with “regular” replaced by “finitely-complete”.

**Proposition 5.2.12.** *There exists a dotted lift*

$$\begin{array}{ccc}
 & & \mathbf{WD-Alg} \\
 & \nearrow \text{Cntr}_{(-)} & \downarrow U \\
 \mathbf{RegCat} & \xrightarrow{\mathcal{W}_{(-)}} & \mathbf{SMC}_\ell
 \end{array}$$

extending the definition of contracts for **Int**-sheaves given in Section 4.5. There is also a natural transformation  $\text{Img}: \text{Mch}_{(-)} \rightarrow \text{Cntr}_{(-)}$ .

*Proof.* To any regular category  $\mathcal{C}$  we will define a lax monoidal functor  $\text{Cntr}_{\mathcal{C}}: \mathcal{W}_{\mathcal{C}} \rightarrow \mathbf{Cat}$  such that  $\text{Cntr}_{\mathcal{C}}(X) := \text{Sub}_{\mathcal{C}}(\widehat{X}^{\text{in}} \times \widehat{X}^{\text{out}})$  for any box  $X \in \mathcal{W}_{\mathcal{C}}$ . There is an obvious image map to this from  $\text{Mch}_{\mathcal{C}}(X) = \mathcal{C}/(\widehat{X}^{\text{in}} \times \widehat{X}^{\text{out}})$ , which we denote  $\text{Img}$ . The lax structure of  $\text{Cntr}_{\mathcal{C}}$  is obvious because products of inclusions are inclusions, as is the monoidal structure of  $\text{Img}$ . For any  $\phi: X \rightarrow Y$  in  $\mathcal{C}$  both the functor  $\text{Cntr}_{\mathcal{C}}(\phi)$  and the naturality of  $\text{Img}$  follow from Diagram (34).

A regular functor  $F: \mathcal{C} \rightarrow \mathcal{D}$  preserves epi-mono factorization and pullbacks, so it induces a map  $\text{Cntr}_F: \text{Cntr}_{\mathcal{C}} \rightarrow \text{Cntr}_{\mathcal{D}} \circ \mathcal{W}_F$  as to the left, such that the diagram to the right commutes:

$$\begin{array}{ccc}
 \mathcal{W}_{\mathcal{C}} & \xrightarrow{\mathcal{W}_F} & \mathcal{W}_{\mathcal{D}} \\
 \searrow \text{Cntr}_{\mathcal{C}} & \xRightarrow{\text{Cntr}_F} & \swarrow \text{Cntr}_{\mathcal{D}} \\
 & \mathbf{Cat} & 
 \end{array}
 \qquad
 \begin{array}{ccc}
 \text{Mch}_{\mathcal{C}} & \xrightarrow{\text{Mch}_F} & \text{Mch}_{\mathcal{D}} \circ \mathcal{W}_F \\
 \text{Img}_{\mathcal{C}} \downarrow & & \downarrow \text{Img}_{\mathcal{D}} \\
 \text{Cntr}_{\mathcal{C}} & \xrightarrow{\text{Cntr}_F} & \text{Cntr}_{\mathcal{D}}
 \end{array}$$

Indeed, for any  $X \in \mathcal{W}_{\mathcal{C}}$  the map  $\text{Cntr}_F: \text{Cntr}_{\mathcal{C}}(X) \rightarrow \text{Cntr}_{\mathcal{D}}(FX)$  is just application of  $F$ , and the rest of the restructure follows just as easily.  $\square$

## A Examples of Int-sheaves and machines

This paper has two appendices. The present one gives a variety of examples of **Int**-sheaves and machines, including a notion of hybrid sheaves. In Appendix B, we discuss an equivalence of categories between **Int**-sheaves and *discrete Conduché fibrations* over the monoid of nonnegative reals.

The present appendix is divided into three sections. In Appendix A.1 we discuss **Int**-sheaves that arise from topological or geometric objects, such as topological spaces, directed spaces,  $C^n$ -manifolds, Riemannian manifolds, etc. In Appendix A.2 we discuss hybrid sheaves, which are **Int**-sheaves constructed from a mix of continuous and discrete data. The hybrid construction provides new functors (beyond  $\Sigma_i$  from Proposition 3.3.2) for converting graphs to **Int**-sheaves, which we discuss in Appendix A.3. Finally in Appendix A.4 we give a few examples of abstract machines in the sense of Section 4.1.



## A.1 Interval sheaves coming from spaces

Some examples of interval sheaves were given in Chapter 3. Here we collect a few more that arise from various sorts of spaces.

*Example A.1.1.* Let  $X$  be a topological space. The set of parameterized continuous curves forms an **Int**-sheaf, denoted  $C^0(X)$ . That is, to each interval  $\ell$ , we assign the set

$$C^0(X)(\ell) := \{f: [0, \ell] \rightarrow X \mid f \text{ is } C^0\}.$$

Restriction along  $[0, \ell'] \subseteq [0, \ell]$  is obvious, as is the fact that compatible sections (which must agree on a common parameterized sub-curve of  $X$ ) are uniquely glued. Note that the length-0 sections of  $C^0X(0) \cong |X|$  are just the points in  $X$ . The functor  $C^0: \mathbf{Top} \rightarrow \widetilde{\mathbf{Int}}$  is fully faithful on  $\Delta$ -generated spaces.<sup>10</sup>

*Example A.1.2.* If  $X$  is a  $C^n$ -manifold (for  $n \in \{1, \dots, \infty\}$ ), the analogously-defined presheaf

$$C_{\text{psh}}^n(X)(\ell) := \{f: [0, \ell] \rightarrow X \mid f \text{ is } C^n\} \tag{39}$$

of parameterized  $C^n$ -curves through  $X$  does not form a sheaf. The reason is that the set  $C_{\text{psh}}^n(X)(0) = C^0(X)(0) = |X|$  of length-0 sections only contains enough data to know when two curves have the same endpoints—not the same derivatives—so the result of some gluing may not be  $C^n$  for  $n > 0$ . To produce a sheaf from  $C_{\text{psh}}^n$ , the simplest thing to do is to sheafify; the result will be the sheaf  $C^{0,n}X$  whose sections are continuous and piecewise- $C^n$  curves in  $X$ .

*Example A.1.3.* In 4 we saw that for any  $C^n$ -manifold  $X$ , there is a sheaf  $C^nX$  of  $C^n$ -curves in  $X$ , with the caveat that  $C^nX(0)$  is the set of  $n$ -jets, not points, in  $X$ .

If  $m \leq n$ , there is a sheaf morphism  $q^{m,n}: C^n(X) \rightarrow C^m(X)$ . Its underlying functions  $q^{m,n}(\ell)$  for  $0 < \ell \in \mathbf{Int}$  are inclusions, because  $n$ -times differentiable implies  $m$ -times differentiable; however  $q^{m,n}(0): C^n(X)(0) \rightarrow C^m(X)(0)$  is a quotient sending  $n$ -jets to  $m$ -jets. Using  $q^{m,n}(0)$  we can form a sheaf  $C^{m,n}(X)$  of piecewise  $C^n$  curves in  $X$  that are  $C^m$  everywhere as the following pushout in  $\widetilde{\mathbf{Int}}$ :

$$\begin{array}{ccc} C^n(X)(0) \times \mathbf{Yon}_0 & \xrightarrow{\eta} & C^n(X) \\ q^{m,n}(0) \times \mathbf{Yon}_0 \downarrow & \lrcorner & \downarrow \\ C^m(X)(0) \times \mathbf{Yon}_0 & \longrightarrow & C^{m,n}(X) \end{array}$$

The map  $\eta$  is the unit of the adjunction from Proposition 3.2.5.

*Example A.1.4.* A d-space [Gra01] is a pair  $(X, dX)$  where  $X$  is a topological space and  $dX$  is a subset of all continuous maps  $a: [0, 1] \rightarrow X$  (an element  $a \in dX$  is called a *directed path*),

<sup>10</sup>A  $\Delta$ -generated space  $X$  is one whose topology is final with respect to curves in  $X$ . The category of  $\Delta$ -generated spaces is a convenient category in the sense of Steenrod [Ste67] and includes any space that is first-countable and locally path-connected.

satisfying three axioms.<sup>11</sup> D-Spaces are the objects in a category  $\mathbf{dSpc}$  whose morphisms are continuous maps that send directed paths to directed paths. There is a functor  $S: \mathbf{dSpc} \rightarrow \widetilde{\mathbf{Int}}$  given by

$$S(X, \mathbf{d}X)(\ell) := \{(a, r) \mid a \in \mathbf{d}X \text{ and } r: [0, \ell] \rightarrow [0, 1] \text{ increasing}\}.$$

which is fully faithful when restricted to the full subcategory of nice enough d-spaces — namely, those  $(X, \mathbf{d}X)$  for which the topology on  $X$  is final with respect to the set of directed paths  $a \in \mathbf{d}X$ .

*Example A.1.5.* The sheaves  $S$  considered in each of the examples above all have a common property that not all  $\mathbf{Int}$ -sheaves share: there is a natural isomorphism between  $S(\ell) \cong S(\ell')$  for all  $\ell, \ell' > 0$ . We can find many sources of examples where that is not the case, for example the representable sheaf  $\mathbf{Yon}_p$  for any  $p \neq 0$ . To find an example coming from spaces, we need to involve geometry.

Suppose  $X$  is a Riemannian manifold; then there is a well-defined notion of unit-speed curves in  $X$  (see [Lee97]). We define a sheaf  $\widetilde{X}$  which assigns to the interval  $\ell \in \mathbf{Int}$  the set of unit-speed maps  $[0, \ell] \rightarrow X$ . These can be restricted and glued, so  $\widetilde{X}$  is indeed a sheaf.

## A.2 Hybrid sheaves

In this section we consider *hybrid* systems, which mix continuous behavior with discrete signals that can arrive at arbitrary times. As a special case, we will obtain a finitely complete functor  $\mathbf{RW}: \widetilde{\mathbf{Int}}_N \rightarrow \widetilde{\mathbf{Int}}$ . Another functor finitely complete  $\Sigma'_i: \widetilde{\mathbf{Int}}_N \rightarrow \widetilde{\mathbf{Int}}$  was constructed previously in Proposition 3.3.2. The difference between them is that while  $\Sigma'_i$  traverses the edges of a graph at unit speed,  $\mathbf{RW}$  moves stochastically through the graph. However, the functor  $\mathbf{RW}$  is a very special case of a far more general method for constructing  $\mathbf{Int}$ -sheaves from hybrid (continuous+discrete) data, as we now discuss.

### A.2.1 Hybrid sheaf data and realization

Recall that there is an indexing category  $\mathbf{rg}$  for *reflexive* graphs; it has two objects, say  $0$  and  $E$ , two morphisms  $s, t: 0 \rightarrow E$  and a morphism  $i: E \rightarrow 0$ , such that  $i \circ s = \text{id}_0 = i \circ t$ . A reflexive graph can be identified with a functor  $\mathbf{rg}^{\text{op}} \rightarrow \mathbf{Set}$ . On the other hand, the category  $\mathbf{Int}$  also has an object called  $0$ , so we can take the pushout of  $\mathbf{rg}$  and  $\mathbf{Int}$  along the inclusion of  $0$  to define a category  $\mathbf{rgInt}$ :

$$\begin{array}{ccc} \{*\} & \xrightarrow{0} & \mathbf{Int} \\ 0 \downarrow & \lrcorner & \downarrow \\ \mathbf{rg} & \longrightarrow & \mathbf{rgInt} \end{array} \quad (40)$$

<sup>11</sup>The axioms are that any constant path, any increasing re-parameterization of a directed path, and any concatenation of two directed paths is again directed.

We endow  $\mathbf{rgInt}$  the weakest Grothendieck topology such that the inclusion  $\mathbf{Int} \subseteq \mathbf{rgInt}$  preserves covers. Then a sheaf on  $\mathbf{rgInt}$  consists of a pair  $(V, G)$ , where  $V \in \widetilde{\mathbf{Int}}$  is a sheaf and  $G: \mathbf{rg}^{\text{op}} \rightarrow \mathbf{Set}$  is a reflexive graph, such that  $G(0) = V(0)$ : the vertices of  $G$  are the germs of  $V$ . We have source and target functions  $\text{src}, \text{tgt}: G(E) \rightarrow V(0)$  and reflexive edge map  $\text{ids}: V(0) \rightarrow G(E)$ . Recall from Notation 3.1.5 the notation  $\lambda_0, \rho_0: V(\ell) \rightarrow V(0)$  for the left and right endpoints of a section.

**Definition A.2.1.** Let  $V \in \widetilde{\mathbf{Int}}$  be an  $\mathbf{Int}$ -sheaf, and let  $G = (V(0), G(E), \text{src}, \text{tgt}, \text{ids})$  be a reflexive graph; the pair can be identified with a sheaf  $H = (V, G) \in \widetilde{\mathbf{rgInt}}$ . We call  $H$  a *hybrid sheaf datum*. We refer to elements of  $G(E)$  as *jumps* (or *transitions*) and to elements of  $V(0)$  as *vertices*. We refer to  $V \in \widetilde{\mathbf{Int}}$  as the *continuous part* of  $H$  and for  $\ell > 0$  we may refer to the sections  $v \in V(\ell)$  as *flows*. Given  $e \in G(E)$  and  $v \in V(\ell)$ , if  $\lambda_0(v) = \text{tgt}(e)$  (resp. if  $\rho_0(v) = \text{src}(e)$ ), we say that  $e$  is a jump *into*  $v$  (resp. *out of*  $v$ ).

We now give a concrete construction of a functor  $R: \widetilde{\mathbf{rgInt}} \rightarrow \widetilde{\mathbf{Int}}$ , called the *realization functor*; we will define it more concisely and prove that it is finitely-complete in Proposition A.2.3. Let  $H = (V, G) \in \widetilde{\mathbf{rgInt}}$  be a hybrid sheaf datum, as in Definition A.2.1. We will define  $R$  by first constructing a presheaf  $\overline{H}$ , functorial in  $H$ , and then sheafifying.

Define the presheaf  $\overline{H} \in \text{Psh}(\mathbf{Int})$  from  $H$  as follows. For length-0 sections we put  $\overline{H}(0) := G(E)$  and for  $\ell > 0$  we define the set  $\overline{H}(\ell)$  of length- $\ell$  sections by a pullback in  $\mathbf{Set}$ :

$$\overline{H}(0) := G(E), \quad \ell > 0: \quad \begin{array}{ccc} \overline{H}(\ell) & \longrightarrow & G(E) \times G(E) \\ \downarrow & \lrcorner & \downarrow \text{tgt} \times \text{src} \\ V(\ell) & \xrightarrow{(\lambda_0, \rho_0)} & V(0) \times V(0) \end{array} \quad (41)$$

In pictures, an element of  $\overline{H}(\ell)$ , where  $\ell > 0$ , is a length- $\ell$  section  $v \in V(\ell)$  together with a jump into  $v$  and a jump out of  $v$ :

$$\begin{array}{c} e_0 \downarrow \\ \text{---} \curvearrowright \text{---} v \text{---} \curvearrowleft \text{---} \\ \downarrow e_\ell \end{array} \quad (42)$$

We still need to provide the restriction maps for  $\overline{H}$ . Suppose that  $p: \ell' \rightarrow \ell$  is an inclusion of intervals, and let  $q := \ell - (\ell' + p)$ ; so  $q$  represents space at the right of the inclusion, just like  $p$  represents space at the left. We may assume  $\ell' < \ell$  because if  $\ell' = \ell$  then the restriction is the identity, so we have either  $p \neq 0$  or  $q \neq 0$ . We break into two cases based on whether or not  $\ell' = 0$ .

First suppose that  $0 = \ell' < \ell$ . Let  $(e_0, v, e_\ell) \in \overline{H}(\ell)$  be a section, and let  $v' = v|_{[p, p]}$  be the restriction of the continuous part and let  $e' = \text{ids}(v')$  be the reflexive edge at that point.

Then we define  $\overline{H}(p): \overline{H}(\ell) \rightarrow \overline{H}(0)$ :

$$\overline{H}(p)(e_0, v, e_\ell) := \begin{cases} e_0 & \text{if } p = 0 \\ e_\ell & \text{if } q = 0 \\ e' & \text{if } p \neq 0 \text{ and } q \neq 0 \end{cases}$$

Second suppose that  $0 < \ell' < \ell$ . Let  $(e_0, v, e_\ell) \in \overline{H}(\ell)$  be a section, and let  $v' := v|_{[p, p+\ell]}$  be the restriction of the continuous part, and let  $e'_0 := \text{ids}(\lambda_0(v'))$  and  $e'_\ell := \text{ids}(\rho_0(v'))$  be the reflexive edges at its left and right endpoints. Then we define  $\overline{H}(p): \overline{H}(\ell) \rightarrow \overline{H}(\ell')$ :

$$\overline{H}(p)(e_0, v, e_\ell) := \begin{cases} (e_0, v', e'_\ell) & \text{if } p = 0 \text{ and } q \neq 0 \\ (e'_0, v', e_\ell) & \text{if } p \neq 0 \text{ and } q = 0 \\ (e'_0, v', e'_\ell) & \text{if } p \neq 0 \text{ and } q \neq 0 \end{cases}$$

Intuitively, if  $\ell > 0$  then a length- $\ell$  section of  $\overline{H}$  includes a choice of flow  $v$  and a choice of two jumps—one into and one out of  $v$ —which occur at its left and right endpoints, as in (42). A subinterval of  $[0, \ell]$  can either include one of the endpoints or not. When it does, the chosen jump is used; when it does not, a reflexive jump is used.

**Definition A.2.2.** Given a hybrid sheaf datum  $H \in \widetilde{\mathbf{rgInt}}$ , let  $\overline{H} \in \mathbf{Psh}(\mathbf{Int})$  be the presheaf described above. We define the *realization* of  $H$ , denoted  $R(H) := \text{asSh}(\overline{H})$ , to be its sheafification.

The sections of  $R(H)$  can be identified with finite sequences of sections in  $\overline{H}$ , stitched together by edges  $e \in G(E)$ . Here is a picture with  $n = 3$ :

$$\begin{array}{c} v_1 \\ \swarrow e_1 \\ v_2 \\ \swarrow e_2 \\ v_3 \end{array} \quad (43)$$

The absence of an edge from a point within a flow does not imply there is no edge at that point. Indeed, a section of  $R(H)$  is equivalent to any one obtained by inserting a reflexive edge on the interior of a flow.

The above construction of the realization functor  $R: \widetilde{\mathbf{rgInt}} \rightarrow \widetilde{\mathbf{Int}}$  as the sheafification of a presheaf  $\overline{H}$  has the advantage of being relatively concrete, but the disadvantage of seeming ad hoc and being unwieldy. We return to the notation of (40) to prove that  $R$  is the composite of (parts of) geometric morphisms and thus preserves finite limits.

Recall that every geometric morphism  $f: A \rightarrow B$  between toposes consists of a direct image part denoted  $f_*: A \rightarrow B$ , and an inverse image part denoted  $f^*: B \rightarrow A$ , such that  $f^*$  is finitely complete and left adjoint to  $f_*$ .

**Proposition A.2.3.** *There exists a site  $\mathbf{rgInt}'$ , a site co-morphism  $k: \mathbf{rgInt} \rightarrow \mathbf{rgInt}'$ , and a site co-morphism  $j: \mathbf{Int} \rightarrow \mathbf{rgInt}'$ , such that the realization functor  $R: \widetilde{\mathbf{rgInt}} \rightarrow \widetilde{\mathbf{Int}}$  from Definition A.2.2 can be identified with the composite  $j^* \circ k_* \cong R$ . Hence,  $R$  preserves finite limits.*

*Proof.* First we construct a new site  $\mathbf{rgInt}'$  and a wide inclusion  $k: \mathbf{rgInt} \subseteq \mathbf{rgInt}'$  (i.e.  $\text{ob } \mathbf{rgInt}' := \text{ob } \mathbf{rgInt}$ ). The multiplication tables for  $\mathbf{rgInt}$  and  $\mathbf{rgInt}'$ , respectively, are shown below:<sup>12</sup>

$\mathbf{rgInt} :$			
$\swarrow$	$\ell' > 0$	$\ell = 0$	$E$
$\ell > 0$	$\{p \in [0, \ell - \ell']\}$	$\{p \in [0, \ell]\}$	$\{pi \mid p \in [0, \ell]\}$
$\ell = 0$	$\emptyset$	$\{\text{id}_0\}$	$\{i\}$
$E$	$\emptyset$	$\{s, t\}$	$\{\text{id}_E, si, ti\}$

$\mathbf{rgInt}' :$			
$\swarrow$	$\ell' > 0$	$\ell = 0$	$E$
$\ell > 0$	$\{p \in [0, \ell - \ell']\}$	$\{p \in [0, \ell]\} \sqcup \{e_0s, e_\ell t\}$	$\{pi \mid p \in [0, \ell]\} \sqcup \{e_0, e_\ell, e_0si, e_\ell ti\}$
$\ell = 0$	$\emptyset$	$\{\text{id}_0\}$	$\{i\}$
$E$	$\emptyset$	$\{s, t\}$	$\{\text{id}_E, si, ti\}$

The composition formula for  $\mathbf{rgInt}'$  is fairly straightforward, given a few facts listed below. Suppose  $\ell > 0$  and  $0 < q' \leq \ell - \ell'$  and  $0 \leq q'' < \ell - \ell'$ .

$$e_0 \circ t = 0, \quad e_\ell \circ s = \ell, \quad 0 \circ e_0 = e_0, \quad (\ell - \ell') \circ e_\ell = e_\ell,$$

$$q' \circ e_0 = q' \circ i, \quad q'' \circ e_\ell = q'' \circ i.$$

We equip  $\mathbf{rgInt}'$  with the weakest coverage such that the inclusion functor  $k$  is cover-preserving, thus defining a site. With this definition, one can check that in fact  $k$  is also cover-reflecting, i.e. a site co-morphism. Thus the right Kan extension along  $k$  is precisely the direct image part  $k_*: \widetilde{\mathbf{rgInt}} \rightarrow \widetilde{\mathbf{rgInt}'}$  of a geometric morphism.

We also have an inclusion  $j: \mathbf{Int} \rightarrow \mathbf{rgInt}'$  defined as follows. On objects we put  $j(\ell) = \ell$  for  $\ell > 0$  and  $j(0) = E$ . On morphisms  $p: \ell' \rightarrow \ell$  such that either  $\ell' > 0$  or  $0 < p < \ell$ , we put  $j(p) = p$ . In the remaining case we have  $\ell' = 0$  and either  $p = 0$  or  $p = \ell$ ; we put  $j(0) = e_0$  and  $j(\ell) = e_\ell$ . It is easy to check that this defines a functor  $j$  and that  $j$  is cover-reflecting. Thus for any  $X \in \widetilde{\mathbf{rgInt}'}$ , the composite  $\mathbf{Int}^{\text{op}} \xrightarrow{j^{\text{op}}} (\mathbf{rgInt}')^{\text{op}} \xrightarrow{X} \mathbf{Set}$  returns an  $\mathbf{Int}$ -presheaf, and sheafifying defines the inverse image part  $j^*: \mathbf{rgInt} \rightarrow \mathbf{Int}$  of a geometric morphism.

<sup>12</sup>Here is a schematic for the hom-sets  $\mathbf{rgInt}'(-, \ell)$ , where  $\ell > 0$ ,  $q \in [0, \ell - \ell']$ , and  $p \in [0, \ell]$ :

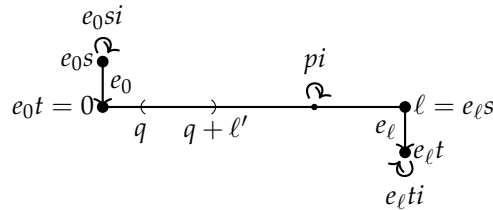

Given a hybrid sheaf datum  $H \in \widetilde{\mathbf{rgInt}}$ , we first apply  $k_*$  as above. Composing  $k_*(H) : (\mathbf{rgInt}')^{\text{op}} \rightarrow \mathbf{Set}$  with  $j^{\text{op}}$  we get an  $\mathbf{Int}$ -presheaf. In fact, because the right Kan extension is computed pointwise, one can check that we have  $\overline{H} \cong k_*(H) \circ j^{\text{op}}$  where  $\overline{H}$  is the presheaf described in (41). Thus we have  $R(H) = \text{asSh}(\overline{H}) = j^* \circ k_*(H)$ . Since both  $j^*$  and  $k_*$  preserve finite limits, so does  $R$ .  $\square$

*Example A.2.4.* We define a functor  $\text{PW} : \widetilde{\mathbf{Int}} \rightarrow \widetilde{\mathbf{Int}}$ , as follows for  $V \in \widetilde{\mathbf{Int}}$ . Let  $K_0 := K(V(0))$  denote the complete graph from Example 3.2.3 on the set  $V(0)$  of germs. In fact, it can naturally be considered a reflexive graph, so  $(V, K_0)$  is a hybrid sheaf datum as in Definition A.2.1. Define  $\text{PW}(V) := R(V, K_0)$  to be its realization; we call it the sheaf of *piecewise sections in  $V$* .

There are natural maps  $\eta_A : A \rightarrow \text{PW}(A)$  and  $\mu_A : \text{PW}(\text{PW}(A)) \rightarrow \text{PW}(A)$ , making  $\text{PW}$  a monad on  $\widetilde{\mathbf{Int}}$ . Moreover, since  $K$  and  $R$  both preserve finite limits, so does  $\text{PW}$ .

Note that if  $X$  is a  $C^n$  manifold, we can use  $\text{PW}$  to extend Example A.1.3: define  $C^{-1,n}(X) := \text{PW}(C^n(X))$ .

### A.3 From graphs to Int-sheaves

A graph  $G = (N, T, \text{src}, \text{tgt})$ , where  $N, T \in \mathbf{Set}$  stand for ‘nodes’ and ‘transitions’, can be turned into a continuous sheaf in many ways. In Proposition 3.3.2, we defined a finite limit-preserving functor  $\Sigma'_i : \mathbf{Grph} = \widetilde{\mathbf{Int}}_N \rightarrow \widetilde{\mathbf{Int}}/\text{Sync}$ . Now we give another such functor which appears to be more useful in applications.

**Proposition A.3.1.** *There exists a finitely complete functor  $\text{RW} : \mathbf{rGrph} \rightarrow \widetilde{\mathbf{Int}}$ , given as the composite of inverse image and direct image parts of geometric morphisms. The same statement holds if we replace  $\mathbf{rGrph}$  with  $\mathbf{Grph}$ .*

*Proof.* Throughout this proof, we refer to a composite of inverse image and direct image parts of geometric morphisms as a *zigzag*. Any zigzag is finitely-complete.

By the universal property of pushout (40), the unique functor  $\mathbf{Int} \rightarrow \{*\}$  induces a functor  $\mathbf{rgInt} \rightarrow \mathbf{rg}$  sending every interval  $\ell \mapsto 0$ . This functor is cover-preserving and representably flat, hence induces a geometric morphism with inverse image  $\mathbf{rGrph} = \widetilde{\mathbf{rg}} \rightarrow \widetilde{\mathbf{rgInt}}$ . It was shown in Proposition A.2.3 that the functor  $R : \widetilde{\mathbf{rgInt}} \rightarrow \widetilde{\mathbf{Int}}$  is a zigzag, so we obtain a zigzag  $\mathbf{rGrph} \rightarrow \widetilde{\mathbf{Int}}$ .

Given this zigzag, once we find a geometric morphism connecting  $\mathbf{Grph}$  to  $\mathbf{rGrph}$ , we will have proved the second claim. The inclusion of the graph-indexing category into  $\mathbf{rg}$  is cover-reflecting (both sites have the trivial topology), so the right-Kan extension  $\mathbf{Grph} \rightarrow \mathbf{rGrph}$  is the direct image of a geometric morphism.  $\square$

We will refer to the functor  $\text{RW} : \mathbf{rGrph} \rightarrow \widetilde{\mathbf{Int}}$  defined in Proposition A.3.1 as the *random walk functor*, because a section of it consists of a finite number of jumps from vertex to vertex

(a path in  $G$ ) that rest for a finite amount of time on each intermediate vertex. We now explain this in a bit more detail.

Let  $G = (V_0, E, \text{src}, \text{tgt}, \text{ids})$  be an ordinary reflexive graph. Let  $V = \text{cst}(V_0)$  be the constant sheaf on  $V_0$ , so in particular  $V(0) = V_0$ . Then we have a hybrid sheaf datum  $H = (V, G)$  in the sense of Definition A.2.1. Applying the realization functor, we have a hybrid sheaf  $R(H)$  whose sections we can picture as in (43), except the flows are constant:

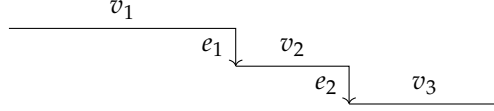

The result is the sheaf  $\text{RW}(G) \in \widetilde{\mathbf{Int}}$ .

The functor  $\text{RW}: \mathbf{Grph} \rightarrow \widetilde{\mathbf{Int}}$  (see Proposition A.3.1) also induces an algebra morphism in the spirit of Section 5.2 which realizes any discrete machine as a continuous one, as yet another corollary to Proposition 5.2.1:

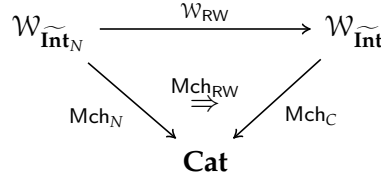

The functor  $\mathbf{Grph} \rightarrow \widetilde{\mathbf{Int}}$  described in Proposition A.3.1 first transforms a graph  $G$  into a reflexive graph  $G'$  by taking the self-loops in  $G$  as the vertices in  $G'$ . This was done to make the functor  $\mathbf{Grph} \rightarrow \widetilde{\mathbf{Int}}$  finitely complete. In Example A.3.2 we describe a variant that is not limit-preserving, but still interesting. In Example A.3.3 we will give yet another construction for converting a graph to an  $\mathbf{Int}$ -sheaf, which is somehow between the two extremes of periodic and stochastic.

*Example A.3.2.* As mentioned above, the sheaf  $\text{RW}(G) \in \widetilde{\mathbf{Int}}$ , constructed in Proposition A.3.1, is obtained by first replacing the set of nodes by the set of self-loops in order to obtain a reflexive graph. We do the opposite: apply the left adjoint  $\mathbf{Grph} \rightarrow \mathbf{rGrph}$ , which adds a self-loop to each node. We obtain a hybrid sheaf datum  $H = (V, G)$ , where  $V := \text{cst}(N)$  is the constant sheaf on  $N$ .

*Example A.3.3.* Fix real numbers  $0 \leq a \leq b$ ; we will construct a sheaf whose sections are paths through  $G = (N, T, \text{src}, \text{tgt})$ , where each node is assigned a length of time between  $a$  and  $b$ . For example if  $a = 1$  and  $b = 4$ , a section of length 6 might be denoted something like  $(n_1@3, t_{12}, n_2@2.5, t_{23}, n_3@.5)$ . This section starts on  $n_1$  and remains there for 3 seconds before an instantaneous transition  $t_{12}$  connects it to  $n_2$ , etc. Note that a section may start or end on either a node or a transition; i.e.  $(t, n@4, t', n@2, t'')$  would also be a valid section of length 6.

To construct a sheaf whose sections match this description, we will define a hybrid sheaf datum  $H = (V, G')$ . We begin by defining a sheaf  $V$  and a set  $E$  as follows:

$$V := N \times \text{Yon}_b \quad \text{and} \quad E := T \times \{p \mid a \leq p \leq b\}$$

Then  $V(0) = N \times \{p \mid 0 \leq p \leq b\}$  and we define  $\text{src}', \text{tgt}' : E \rightarrow V(0)$  by

$$\text{src}'(t, p) := (\text{src}(t), p) \quad \text{and} \quad \text{tgt}'(t, p) = (\text{tgt}(t), 0).$$

Defining  $G'$  to be the free reflexive graph on  $E \rightrightarrows V(0)$ , we have a hybrid sheaf datum  $H := (V, G')$ , as in Definition A.2.1, for which the realization  $R(H) \in \widetilde{\mathbf{Int}}$  (see Proposition A.2.3) is the desired sheaf.

*Remark A.3.4.* Suppose that we fix  $a = b = 1$ , so that the construction in Example A.3.3 gives a hybrid sheaf datum  $H$  and a sheaf  $R(H)$  whose sections are “walks through  $G$  that rest for 1 second on a node, before transitioning to another”. That same description could be applied to a sheaf which arises from another construction altogether.

Recall the functor  $\Sigma_i : \mathbf{Grph} \simeq \widetilde{\mathbf{Int}}_N \rightarrow \widetilde{\mathbf{Int}}$  from Proposition 3.3.2. Let  $G'' = (T \times_N T \rightrightarrows T)$  be the graph whose vertices are transitions in  $G$  and whose edges are length-2 paths in  $G$ . Then we conjecture that the sheaf  $\Sigma_i(G'') \in \widetilde{\mathbf{Int}}$  is equivalent to the sheaf  $R(H)$  described above.

## A.4 Examples of machines

Below we describe three types of machines—in the sense of Section 4.1—which may be useful in applications. The first is for switching between input streams, the second is for storing material (e.g. for queueing), and the third is for traversing a labeled transition system.

*Example A.4.1.* Let  $m \in \mathbb{N}$ , and let  $\underline{m} = \text{cst}(\{1, \dots, m\})$  be the constant sheaf on  $m$  elements. A *switch* between  $m$ -input wires, each of type  $A \in \widetilde{\mathbf{Int}}$ , can be defined as follows. Recall from Example A.2.4 the “piecewise-ification” functor  $\text{PW} : \widetilde{\mathbf{Int}} \rightarrow \widetilde{\mathbf{Int}}$ —which is finitely complete—and the natural transformation  $\eta : \text{id}_{\widetilde{\mathbf{Int}}} \rightarrow \text{PW}$ .

The switch inhabits a box with the following shape (having  $m$  inputs of type  $A$ ):

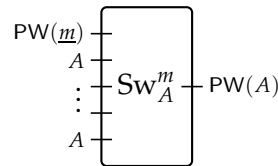

The output sheaf is piecewise sections in  $A$ , because the switch can be thrown—i.e. there can be a transition in the input sheaf  $\text{PW}(\underline{m})$ —at any time, at which point a transition must also occur in the output.

To build a machine of this type, it suffices by Example 4.1.2 (1) to construct a sheaf map  $p^\circ : \text{PW}(\underline{m}) \times A^m \rightarrow \text{PW}(A)$ .<sup>13</sup> Let  $\text{ev} : \underline{m} \times A^m \rightarrow A$  denote the evaluation map, sending  $(i, a_1, \dots, a_n) \mapsto a_i$ . Then define  $p^\circ$  to be the composite

$$\text{PW}(\underline{m}) \times A^m \xrightarrow{\eta_{(A^m)}} \text{PW}(\underline{m}) \times \text{PW}(A^m) \xrightarrow{\cong} \text{PW}(\underline{m} \times A^m) \xrightarrow{\text{PW}(\text{ev})} \text{PW}(A).$$

<sup>13</sup>To be explicit, the state sheaf will be  $\text{Sw}_A^m := \text{PW}(\underline{m}) \times A^m$ , and the input map will be  $p^i = \text{id}$ .



*Example A.4.2.* We discuss a prototypical storage machine; we think of it like a bank account, receiving credit and debit signals and adjusting its balance accordingly. Fix a commutative monoid  $(M, 0, +)$ ; for example, if one is storing unlimited amounts of energy or money, one could use  $(\mathbb{R}_{\geq 0}, 0, +)$ ; if one wishes to cap amounts at 100 one could use instead  $\mathbb{R}_{\geq 0}/(100 + a) \sim 100$ . If memory should consist of a set  $L$  of locations to be filled or not, one might use  $(\mathbb{P}(L), \emptyset, \cup)$ , where  $\mathbb{P}(L)$  denotes the power set of  $L$ .

Let  $S := \text{Loop}(M)$  be the graph with one vertex and an edge for every element  $m \in M$ , see Example 3.2.3, 2. We consider  $\text{Loop}(M)$  a reflexive graph, using  $0 \in M$  as the unique reflexive edge. An edge in  $S$  stands for either a credit or a debit transaction signal sent to the account. Let  $B = (M \times M \times M \rightrightarrows M)$  be the (reflexive) graph shown in the middle column of (44), where  $i(m) = (0, m, 0)$ , and let  $S$  be the graph shown on the left and right:

$$\begin{array}{ccccc}
 M & \xleftarrow{\pi_1} & M \times M \times M & \xrightarrow{\pi_3} & M \\
 \begin{array}{c} \uparrow \\ \downarrow \\ \uparrow \\ \downarrow \\ \uparrow \\ \downarrow \end{array} & & \begin{array}{c} \uparrow \\ \downarrow \\ \uparrow \\ \downarrow \\ \uparrow \\ \downarrow \end{array} & & \begin{array}{c} \uparrow \\ \downarrow \\ \uparrow \\ \downarrow \\ \uparrow \\ \downarrow \end{array} \\
 \{*\} & \xleftarrow{\quad} & M & \xrightarrow{\quad} & \{*\}
 \end{array} \tag{44}$$

A vertex in  $B$ , i.e. an element  $b \in M$  stands for a possible balance. An edge is given by a triple  $(c, b, d)$ , and it connects  $b + d$  to  $c + b$ ; it stands for a transaction between these two balances. One may think of  $c$  as a credit, of  $d$  as a debit, and of  $b$  as the balance after the debit and before the credit. As shown in diagram in (44), the leftward map  $p^i: B \rightarrow S$  sends  $(c, b, d) \mapsto c$ , and the rightward map  $p^o: B \rightarrow S$  sends  $(c, b, d) \mapsto d$ .

Applying the random walk functor  $\text{RW}: \mathbf{rGrph} \rightarrow \widetilde{\mathbf{Int}}$  from Proposition A.3.1 to this span of reflexive graphs, we obtain a span of  $\mathbf{Int}$ -sheaves

$$\text{RW}(S) \xleftarrow{\text{RW}(p^i)} \text{RW}(B) \xrightarrow{\text{RW}(p^o)} \text{RW}(S),$$

which is the desired storage machine. Both maps  $\text{RW}(p^i)$  and  $\text{RW}(p^o)$  are total, and the map  $(\text{RW}(p^i), \text{RW}(p^o))$  is total-deterministic.

Suppose that  $M = (\mathbb{N}, 0, +)$  is the additive monoid of natural numbers. The input and output sheaves  $\text{RW}(M \rightrightarrows \{*\})$  signals as shown to the left and right; its state sheaf  $\text{RW}(M^3 \rightrightarrows M)$  carries a balance as shown in the middle:

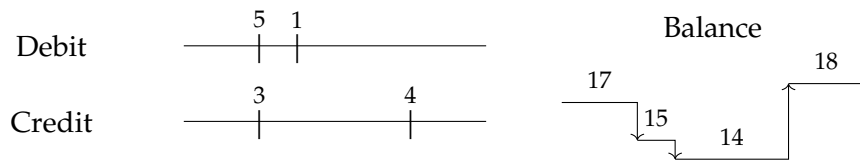

This paragraph and the picture below seem off

Here, we have a debit of 5 simultaneously with a credit of 3, then a debit of 1 (and a credit of 0), and finally (a debit of 0 and) a credit of 4. The balance has the following trajectory, where the  $\mapsto$  symbol denotes a transition through some edge in  $B$ :

$$\boxed{17} = 12 + 5 \xrightarrow{(5,3)} 3 + 12 = \boxed{15} = 14 + 1 \xrightarrow{(1,0)} 0 + 14 = \boxed{14} = 14 + 0 \xrightarrow{(0,4)} 4 + 14 = \boxed{18}$$

Arranging a number of storage machines in series and parallel, we obtain queuing behavior which can be studied in its own right. To do it justice, the above concrete structure should probably be generalized from a commutative to an arbitrary monoid, and from the regular  $(M, M)$ -bimodule to a general  $(M, N)$ -bimodule. Because the formalism in this paper has wiring diagrams with wires that can split or terminate, this formalism is only appropriate for studying a sort of informational (copyable), rather than physical (linear), queueing.

*Example A.4.3.* Suppose given a labeled transition system, consisting of set  $\Lambda, \Omega$  of *input* and *output labels*, a set  $S$  of *states*, a subset  $E \subseteq \Lambda \times S$  of *edges*, a *transition* function  $\tau: E \rightarrow S$ , and an output map  $O: S \rightarrow \Omega$ . For an edge  $(\lambda, s)$ , we call  $s$  its *source* and  $\tau(\lambda, s)$  its *target*; thus we have a graph  $G = (E \rightrightarrows S)$ , and we take  $G'$  to be the free reflexive graph on  $G$ .

Recall from Example 3.2.3 the complete graph and loop-graph constructions. Let  $\text{Loop}'(\Lambda)$  denote the free reflexive graph on  $\text{Loop}(\Lambda)$ . There are reflexive graph homomorphisms  $f: G' \rightarrow \text{Loop}'(\Lambda)$  and  $g: G' \rightarrow K(S)$ , sending a generating edge  $(\lambda, s)$  to  $\lambda \in \Lambda$  and to  $(O(s), O\tau(\lambda, s))$ , respectively. Using the random walk functor  $\text{RW}: \mathbf{rGrph} \rightarrow \widetilde{\mathbf{Int}}$  from Proposition A.3.1, we obtain a deterministic machine as the span:

$$\text{RW}(\text{Loop}'(\Lambda)) \xleftarrow{\text{RW}(f)} \text{RW}(G') \xrightarrow{\text{RW}(g)} \text{RW}(K(S)).$$

The input behaviors are stochastic sequences of signals  $\lambda \in \Lambda$ . At any point a new input  $\lambda$  arrives, if the machine is in a state  $s$  such that  $(\lambda, s) \in E$ , then the machine will instantly transition to state  $s' := \tau(\lambda, s) \in S$ . It will output the new state  $s'$  constantly until the next transition; thus the output is a sequence of states in  $\Omega$ .

This machine will not necessarily be total—an unexpected input signal will have no compatible state evolution—because the inclusion  $E \subseteq \Lambda \times S$  could be ‘proper’. However, this is easily remedied in a variety of ways. The most reasonable may be to keep  $S$  the same but to extend  $\tau$  to  $\tau': \Lambda \times S \rightarrow S$  defined as follows. For an edge  $e' = (\lambda, s) \in \Lambda \times S$ , if  $e' \in E$  put  $\tau'(e) := \tau(e)$ ; if  $e' \notin E$  put  $\tau'(e) := s$ .

## B Discrete Conduché fibrations

In this section, we will discuss an equivalent view of interval sheaves  $X \in \widetilde{\mathbf{Int}}$  from Section 3.2 in terms of “discrete Conduché fibrations”, which are categories mapping to the monoid  $\mathcal{R}$ , satisfying a certain fibrancy condition. This view largely follows material found in [Joh99]. Recall our notation that  $\mathcal{R}$  is the monoid  $(\mathbb{R}_{\geq 0}, 0, +)$  viewed as a single-object category, and similarly  $\mathcal{N}$  is the monoid  $(\mathbb{N}, 0, +)$ .

### B.1 Johnstone coverage

**Definition B.1.1.** For any category  $\mathcal{C}$  and morphism  $q: a \rightarrow b$  in  $\mathcal{C}$ , define the *q-factorization category*, denoted  $\text{Fact}(q)$ , as follows. Its objects are triples  $M = (m, f, g)$ , where  $f: a \rightarrow m$

and  $g: m \rightarrow b$  are arrows in  $\mathcal{C}$  composing to  $q = g \circ f$ . If  $M' = (m', f', g')$ , a morphism  $M \rightarrow M'$  in  $\text{Fact}(q)$  is an arrow  $k: m \rightarrow m'$  in  $\mathcal{C}$  making the triangles commute:

$$\begin{array}{ccc}
 a & \xrightarrow{f'} & m' \\
 \downarrow f & \searrow k & \downarrow g' \\
 m & \xrightarrow{g} & b
 \end{array}$$

We say that  $\mathcal{C}$  is *factorization-linear* if for every morphism  $q$ , the  $q$ -factorization category  $\text{Fact}(q)$  is a linear preorder, i.e. if for any pair of objects  $M, M' \in \text{Fact}(q)$ ,

1. there is at most one morphism  $M \rightarrow M'$ , and
2. there exists either a morphism  $M \rightarrow M'$  or a morphism  $M' \rightarrow M$ .

*Example B.1.2.* We collect a few examples and non-examples of factorization-linear categories.

- For any directed graph  $G$ , the free category  $\mathcal{C} = \text{Fr}(G)$  on  $G$  is factorization-linear. Since the monoid  $\mathcal{N}$  is the free category on the terminal graph, it is factorization-linear.
  - The category  $\mathcal{R}$  is also factorization-linear. Indeed, if  $f, g, f', g'$  are nonnegative real numbers with  $f + g = f' + g'$ , then there is exactly one real number  $k$  such that  $k + f = f'$  (iff  $g' + k = g$ ), and  $k \geq 0$  iff there is a map  $(f, g) \rightarrow (f', g')$ .
  - If  $\mathcal{C}$  is factorization-linear and  $\mathcal{D} \rightarrow \mathcal{C}$  is a discrete Conduché fibration (defined later in Definition B.2.1), then  $\mathcal{D}$  is factorization-linear.
  - The cyclic monoid generated by  $\{f\}$  modulo the relation  $f^2 = f$ , considered as a category with one object  $\{*\}$ , is *not* factorization-linear: the object  $(*, f, f)$  in  $\text{Fact}(f)$  has two distinct endomorphisms,  $\text{id}_*$  and  $f$ , so  $\text{Fact}(f)$  is not a preorder. For the same reason, neither the monoid  $\mathbb{R} \cup \{\infty\}$  of extended real numbers nor the multiplicative monoid  $[0, 1]$  is factorization linear. (However, the monoid  $(0, 1]$  is factorization-linear.)
- The commutative square category

$$\begin{array}{ccc}
 a & \rightarrow & b \\
 \downarrow & & \downarrow \\
 c & \rightarrow & d
 \end{array}$$

is not factorization linear for the opposite reason: although all its factorization categories are preorders, the factorization category  $\text{Fact}(a \rightarrow d)$  is not a linear order:  $(b, !, !)$  and  $(c, !, !)$  are incomparable.

**Definition B.1.3.** Let  $\mathcal{C}$  be a factorization-linear category and  $\mathcal{C}_{\text{tw}}$  its twisted arrow category (see Definition 3.1.3); we will define what we call the *Johnstone coverage* on  $\mathcal{C}_{\text{tw}}$  as follows. A covering family for an object  $(h: x \rightarrow z) \in \mathcal{C}_{\text{tw}}$  is any pair of maps  $(\text{id}_x, g): f \rightarrow h$  and

$(f, \text{id}_z): g \rightarrow h$  in  $\mathcal{C}_{\text{tw}}$ , where  $g \circ f = h$  in  $\mathcal{C}$ :

$$\begin{array}{ccc} x & \xleftarrow{\text{id}_x} & x \\ f \downarrow & & \downarrow h \\ y & \xrightarrow{g} & z \end{array} \qquad \begin{array}{ccc} y & \xleftarrow{f} & x \\ g \downarrow & & \downarrow h \\ z & \xrightarrow{\text{id}_z} & z \end{array}$$

It can be checked that this is indeed a coverage [Joh99, §3.6], and we refer to the associated site as the *Johnstone site* for  $\mathcal{C}_{\text{tw}}$ .<sup>14</sup>

Applying the above definition to  $\mathcal{R}$  and  $\mathcal{N}$ , which are factorization-linear by Example B.1.2, we obtain the Johnstone sites  $\mathbf{Int}$  and  $\mathbf{Int}_{\mathcal{N}}$  on their twisted-arrow categories; see Proposition 3.1.4.

**Corollary B.1.4.** *The Johnstone coverage on  $\mathbf{Int}$  (resp.  $\mathbf{Int}_{\mathcal{N}}$ ) coincides with that given in Definition 3.2.1.*

**Definition B.1.5.** To every  $\mathbf{Int}$ -sheaf  $A$ , we may associate a category  $\overline{A}$ , which we call the *associated category*, as well as a functor  $\text{len}: \overline{A} \rightarrow \mathcal{R}$ , which we call the *length functor*, as follows. The object set of  $\overline{A}$  is the set  $\text{ob } \overline{A} := A(0)$  of germs in  $A$ ; morphisms in  $\overline{A}$  are sections  $a \in A(\ell)$  of arbitrary length; composition is given by gluing sections. The functor  $\text{len}$  assigns to each morphism  $a$  its length  $\text{len}(a) := \ell$ .

In fact we will see that the functor  $\text{len}: \overline{A} \rightarrow \mathcal{R}$  has additional structure, which comes from the operation of restricting sections. This will correspond to a certain sort of fibrancy condition:  $\text{len}$  is a discrete Conduché fibration, a notion we explain in Appendix B.2. In Appendix B.3 we establish the equivalence between  $\mathbf{Int}$ -sheaves and discrete Conduché fibrations over  $\mathcal{R}$ .

## B.2 Comparing discrete fibrations, op-fibrations, and Conduché fibrations

For any category  $\mathcal{C}$ , consider the diagram of sets and functions

$$C_2 \rightrightarrows C_1 \rightrightarrows C_0$$

where  $C_0$  is the set of objects,  $C_1$  is the set of morphisms, and  $C_2$  is the set of composable morphisms in  $\mathcal{C}$ . The two functions  $C_1 \rightarrow C_0$  send a morphism  $f$  to its source (domain) and its target (codomain); the three functions  $C_2 \rightarrow C_1$  send a composable pair  $(g, f)$  to  $g$ ,  $g \circ f$ , and  $f$ . We have left out of our diagram the  $(i + 1)$  functions  $C_i \rightarrow C_{i+1}$  induced by identity morphisms. Out of all these functions and their composites, we want to give special names to three: the source, target, a composition maps:

$$s, t: C_1 \rightarrow C_0, \quad c: C_2 \rightarrow C_1 \tag{45}$$

<sup>14</sup>In fact, [Joh99, p. 3.6] explains that  $\mathcal{C}$  being factorization linear is stronger than necessary to define a coverage on  $\mathcal{C}_{\text{tw}}$ . However, this stronger condition is necessary for Corollary B.3.2 to hold.

For any functor  $F: \mathcal{C} \rightarrow \mathcal{D}$ , there is a function  $F_i: C_i \rightarrow D_i$  for each  $i \in \{0, 1, 2\}$ , and each is induced by the function  $F_0$  on objects and the function  $F_1$  on morphisms.

**Definition B.2.1.** For a functor  $F: \mathcal{C} \rightarrow \mathcal{D}$ , consider the commutative diagrams

$$\begin{array}{ccc}
 C_1 \xrightarrow{t} C_0 & C_1 \xrightarrow{s} C_0 & C_2 \xrightarrow{c} C_1 \\
 F_1 \downarrow & F_1 \downarrow & F_2 \downarrow \\
 D_1 \xrightarrow{t} D_0 & D_1 \xrightarrow{s} D_0 & D_2 \xrightarrow{c} D_1
 \end{array}$$

Then  $F$  is (respectively) called a *discrete fibration* (resp. a *discrete op-fibration*, a *discrete Conduché fibration*) if the first (resp. second, third) square is a pullback.

**Lemma B.2.1.** *If  $F$  is a discrete op-fibration (resp. a discrete fibration), then it is a discrete Conduché fibration.*

*Proof.* The top, bottom, and front of the following cube are pullbacks, so the back is too:

$$\begin{array}{ccccc}
 C_2 & \longrightarrow & C_1 & & \\
 \downarrow & \searrow & \downarrow & \searrow & \\
 & & C_1 & \longrightarrow & C_0 \\
 & & \downarrow & & \downarrow \\
 D_2 & \longrightarrow & D_1 & & \\
 & \searrow & \downarrow & \searrow & \\
 & & D_1 & \longrightarrow & D_0
 \end{array}$$

□

**Lemma B.2.2.** *If  $F: \mathcal{C} \rightarrow \mathcal{D}$  and  $G: \mathcal{D} \rightarrow \mathcal{E}$  are functors and  $G$  is a discrete Conduché fibration, then  $G \circ F$  is discrete Conduché if and only if  $F$  is. The same holds if we replace discrete Conduché with discrete (op)-fibrations.*

*Proof.* This is just the pasting lemma for pullback squares. □

Small discrete Conduché fibrations form a wide subcategory of the category of small categories,  $\mathbf{DCF} \subseteq \mathbf{Cat}$ . In particular,  $\mathbf{DCF}/\mathcal{C}$  denotes the slice category of discrete Conduché fibrations over any  $\mathcal{C} \in \mathbf{Cat}$ . Our main case of interest is the case  $\mathcal{C} = \mathcal{R}$ , the monoid  $\mathbb{R}_{\geq 0}$  considered as a category with one object.<sup>15</sup> A discrete Conduché fibration  $\text{len}: \mathcal{C} \rightarrow \mathcal{R}$  for any category  $\mathcal{C}$  amounts to a commutative diagram as to the left

$$\begin{array}{ccc}
 C_2 \begin{array}{c} \xrightarrow{\pi_1} \\ \xrightarrow{c} \\ \xrightarrow{\pi_2} \end{array} C_1 \xrightarrow[t]{s} C_0 & & C_2 \xrightarrow[c]{c} C_1 \\
 \text{len} \times \text{len} \downarrow & & \downarrow \text{len} \\
 \mathbb{R}_{\geq 0} \times \mathbb{R}_{\geq 0} \begin{array}{c} \xrightarrow{\pi_1} \\ \xrightarrow{+} \\ \xrightarrow{\pi_2} \end{array} \mathbb{R}_{\geq 0} \xrightarrow[!]{!} \{*\} & & \mathbb{R}_{\geq 0} \times \mathbb{R}_{\geq 0} \xrightarrow{+} \mathbb{R}_{\geq 0}
 \end{array}$$

<sup>15</sup>According to [Joh99], this category was considered by Lawvere in [Law86], although this preprint has become difficult to obtain.

for which the sub-diagram to the right is a pullback in  $\mathbf{Set}$ . In other words, every morphism  $f$  in  $\mathcal{C}$  has a length  $\text{len}(f) \in \mathbb{R}_{\geq 0}$  and, for any way to write  $\text{len}(f) = \ell_1 + \ell_2$  as a sum of nonnegative numbers, there is a unique pair of composable morphisms  $f = f_1 \circ f_2$  in  $\mathcal{C}$  having those lengths  $\text{len}(f_1) = \ell_1$  and  $\text{len}(f_2) = \ell_2$ .

**Proposition B.2.2.** *For any small category  $\mathcal{C}$ , the slice category  $\mathbf{DCF}/\mathcal{C}$  is reflective in  $\mathbf{Cat}/\mathcal{C}$ . Moreover, if  $F: \mathcal{C} \rightarrow \mathcal{D}$  is any functor, there is a diagram*

$$\begin{array}{ccc}
 \mathbf{DCF}/\mathcal{C} & \begin{array}{c} \xrightarrow{\Sigma_F} \\ \perp \\ \xleftarrow{\Delta_F} \end{array} & \mathbf{DCF}/\mathcal{D} \\
 \begin{array}{c} \uparrow \\ L_{\mathcal{C}} \dashv \mid \\ \downarrow \\ U_{\mathcal{C}} \end{array} & & \begin{array}{c} \uparrow \\ L_{\mathcal{D}} \dashv \mid \\ \downarrow \\ U_{\mathcal{D}} \end{array} \\
 \mathbf{Cat}/\mathcal{C} & \begin{array}{c} \xrightarrow{F \circ (-)} \\ \perp \\ \xleftarrow{F^*} \end{array} & \mathbf{Cat}/\mathcal{D}
 \end{array}$$

which commutes for the right (and hence left) adjoints, where  $F^*$  is given by pullback along  $F$ .

*Proof.* The existence of a left adjoint  $L_{\mathcal{C}}$  to the inclusion  $U_{\mathcal{C}}: \mathbf{DCF}/\mathcal{C} \rightarrow \mathbf{Cat}/\mathcal{C}$  is proven in [Joh99, Prop. 1.3], by showing that  $U_{\mathcal{C}}$  preserves all limits and satisfies a solution set condition.

If  $\mathcal{A} \rightarrow \mathcal{D}$  is a discrete Conduché fibration, then its pullback  $F^*(\mathcal{A}) \rightarrow \mathcal{C}$  is also discrete Conduché by the pasting lemma for pullbacks. Hence  $\Delta_F$  is defined as the restriction of  $F^*$  on  $\mathbf{DCF}/\mathcal{D}$ , and  $F^* \circ U_{\mathcal{D}} = U_{\mathcal{C}} \circ \Delta_F$ .

Let  $F_! = F \circ (-): \mathbf{Cat}/\mathcal{C} \rightarrow \mathbf{Cat}/\mathcal{D}$  be the left adjoint of  $F^*$ . We define  $\Sigma_F: \mathbf{DCF}/\mathcal{C} \rightarrow \mathbf{DCF}/\mathcal{D}$  to be the composite  $L_{\mathcal{D}} \circ F_! \circ U_{\mathcal{C}}$ . Using the fact that  $U_{\mathcal{C}}$  is fully faithful, a calculation shows that  $\Sigma_F$  is indeed left adjoint to  $\Delta_F$ :

$$[\Sigma_F \mathcal{A}, \mathcal{B}] = [(L_{\mathcal{D}} \circ F_! \circ U_{\mathcal{C}}) \mathcal{A}, \mathcal{B}] \cong [U_{\mathcal{C}} \mathcal{A}, (F^* \circ U_{\mathcal{D}}) \mathcal{B}] \cong [U_{\mathcal{C}} \mathcal{A}, (U_{\mathcal{C}} \circ \Delta_F) \mathcal{B}] = [\mathcal{A}, \Delta_F \mathcal{B}]. \quad \square$$

### B.3 The equivalence $\widetilde{\mathbf{Int}} \cong \mathbf{DCF}/\mathcal{R}$

Having discussed discrete Conduché fibrations and their properties, we are ready to show that the topos of interval sheaves is a special case. The notion of a category  $\mathcal{C}$  being factorization-linear (Definition B.1.1) turns out to capture all the necessary structure for the slice category  $\mathbf{DCF}/\mathcal{C}$  to be a sheaf topos.

**Theorem B.3.1.** [Joh99, Prop. 3.6] *Suppose that  $\mathcal{C}$  is a factorization-linear category, let  $\mathcal{C}_{\text{tw}}$  be its twisted arrow category with its Johnstone coverage Definition B.1.3, and let  $\widetilde{\mathcal{C}}_{\text{tw}}$  be the associated sheaf topos. Then there is an equivalence of categories*

$$\mathbf{DCF}/\mathcal{C} \simeq \widetilde{\mathcal{C}}_{\text{tw}}.$$

**Corollary B.3.2.** *There is an equivalence between the topos of continuous sheaves (resp. discrete-interval sheaves) and discrete Conduché fibrations over  $\mathcal{R}$  (resp. over  $\mathcal{N}$ ):*

$$\mathbf{DCF}/\mathcal{R} \simeq \widetilde{\mathbf{Int}} \quad \text{and} \quad \mathbf{DCF}/\mathcal{N} \simeq \widetilde{\mathbf{Int}}_{\mathcal{N}} \tag{46}$$

*Remark B.3.3.* Note that Proposition B.2.2 does not follow from Proposition 3.3.2, even though  $\mathbf{DCF}/\mathcal{N} \simeq \widetilde{\mathbf{Int}}_{\mathcal{N}}$  and  $\mathbf{DCF}/\mathcal{R} \simeq \widetilde{\mathbf{Int}}$  and the upper adjunctions are essentially the same; this is because discrete Conduché fibrations and sheaves give different perspectives. Categories emphasize composition, and adding the Conduché condition enforces that morphisms can be factorized. Conversely, presheaves emphasize restriction, and adding the sheaf condition enforces that sections can be glued.

These two perspectives compare as follows. Let  $\mathbf{wGrph}$  denote the category of weighted graphs (with nonnegative edge weights), i.e. objects are  $G = \{E \rightrightarrows V, E \rightarrow \mathbb{R}_{\geq 0}\}$ . If we define  $\mathcal{J}$  to be the category with objects  $\mathbb{R}_{\geq 0} \sqcup \{v\}$  and two morphisms  $s_\ell, t_\ell: v \rightarrow \ell$  for each  $\ell \in \mathbb{R}_{\geq 0}$ , then we have  $\mathbf{wGrph} \cong \mathbf{Psh}(\mathcal{J})$ .

There is a functor  $\mathcal{J} \rightarrow \mathbf{Int}$  sending  $v \mapsto 0$  and  $\ell \mapsto \ell$  for all  $\ell \in \mathbb{R}_{\geq 0}$ , and sending  $s_\ell \mapsto \text{Tr}_0$  and  $t_\ell \mapsto \text{Tr}_\ell$ , the left and right endpoints. This induces a left Kan extension between the presheaf categories,  $\mathbf{wGrph} \rightarrow \mathbf{Psh}(\mathbf{Int})$ . We also have a left adjoint  $\mathbf{wGrph} \rightarrow \mathbf{Cat}/\mathcal{R}$ , given by the free category construction, whose functor to  $\mathcal{R}$  sends a path to the sum of its weights. The diagram of left adjoints commutes:

$$\begin{array}{ccccc}
 \mathbf{Grph} & \xrightarrow{\quad} & \mathbf{Psh}(\mathbf{Int}_{\mathcal{N}}) & & \\
 \downarrow & \searrow & \downarrow & \searrow & \\
 & \mathbf{wGrph} & \xrightarrow{\quad} & \mathbf{Psh}(\mathbf{Int}) & \\
 \downarrow & \downarrow & \downarrow & \downarrow & \\
 \mathbf{Cat}/\mathcal{N} & \xrightarrow{\quad} & \mathbf{DCF}/\mathcal{N} \simeq \widetilde{\mathbf{Int}}_{\mathcal{N}} & & \\
 \downarrow & \searrow & \downarrow & \searrow & \\
 & \mathbf{Cat}/\mathcal{R} & \xrightarrow{\quad} & \mathbf{DCF}/\mathcal{R} \simeq \widetilde{\mathbf{Int}} & 
 \end{array}$$

## References

- [ABP99] Samson Abramsky, Richard Blute, and Prakash Panangaden. “Nuclear and trace ideals in tensored  $*$ -categories”. In: *J. Pure Appl. Algebra* 143.1-3 (1999). Special volume on the occasion of the 60th birthday of Professor Michael Barr (Montreal, QC, 1997), pp. 3–47. ISSN: 0022-4049. DOI: [10.1016/S0022-4049\(98\)00106-6](https://doi.org/10.1016/S0022-4049(98)00106-6). URL: [http://dx.doi.org/10.1016/S0022-4049\(98\)00106-6](http://dx.doi.org/10.1016/S0022-4049(98)00106-6).
- [Adá+02] Jiří Adámek, Francis Borceux, Stephen Lack, and Jiří Rosický. “A classification of accessible categories”. In: *J. Pure Appl. Algebra* 175.1-3 (2002). Special volume celebrating the 70th birthday of Professor Max Kelly, pp. 7–30. ISSN: 0022-4049. URL: [http://dx.doi.org/10.1016/S0022-4049\(02\)00126-3](http://dx.doi.org/10.1016/S0022-4049(02)00126-3).
- [Age96] Pierre Ageron. “Effective taxonomies and crossed taxonomies”. In: *Cahiers Topologie Géom. Différentielle Catég.* 37.2 (1996), pp. 82–90. ISSN: 0008-0004.
- [Bar71] Michael Barr. “Exact categories”. In: *Exact categories and categories of sheaves*. Springer, 1971, pp. 1–120.
- [DS97] Brian Day and Ross Street. “Monoidal bicategories and Hopf algebroids”. In: *Adv. Math.* 129.1 (1997), pp. 99–157. ISSN: 0001-8708. URL: <http://dx.doi.org/10.1006/aima.1997.1291>.

- [Fon16] Brendan Fong. “The Algebra of Open and Interconnected Systems”. PhD thesis. University of Oxford, 2016.
- [Gra01] Marco Grandis. “Directed homotopy theory, I. the fundamental category”. In: *Cahiers Top. Géom. Diff. Catég* (2001).
- [Her00] Claudio Hermida. “Representable multicategories”. In: *Adv. Math.* 151.2 (2000), pp. 164–225. ISSN: 0001-8708. URL: <http://dx.doi.org/10.1006/aima.1999.1877>.
- [Jac99] Bart Jacobs. *Categorical logic and type theory*. Vol. 141. Studies in Logic and the Foundations of Mathematics. North-Holland Publishing Co., Amsterdam, 1999, pp. xviii+760. ISBN: 0-444-50170-3.
- [Joh02] Peter T. Johnstone. *Sketches of an elephant: a topos theory compendium*. Vol. 43. Oxford Logic Guides. New York: The Clarendon Press Oxford University Press, 2002, pp. xxii+468+71. ISBN: 0-19-853425-6.
- [Joh99] Peter Johnstone. “A note on discrete Conduché fibrations”. In: *Theory Appl. Categ.* 5 (1999), No. 1, 1–11. ISSN: 1201-561X.
- [JS93] André Joyal and Ross Street. “Braided tensor categories”. In: *Adv. Math.* 102.1 (1993), pp. 20–78. ISSN: 0001-8708. URL: <http://dx.doi.org/10.1006/aima.1993.1055>.
- [Kar04] Panagis Karazeris. “Notions of flatness relative to a Grothendieck topology”. In: *Theory Appl. Categ.* 12 (2004), No. 5, 225–236. ISSN: 1201-561X.
- [Law86] Bill Lawvere. “State categories and response functors”. 1986.
- [Lee97] John M. Lee. *Riemannian manifolds*. Vol. 176. Graduate Texts in Mathematics. An introduction to curvature. Springer-Verlag, New York, 1997, pp. xvi+224. ISBN: 0-387-98271-X. DOI: [10.1007/b98852](https://doi.org/10.1007/b98852). URL: <http://dx.doi.org/10.1007/b98852>.
- [Lei04] Tom Leinster. *Higher operads, higher categories*. London Mathematical Society Lecture Note Series 298. Cambridge University Press, Cambridge, 2004. ISBN: 0-521-53215-9. DOI: [10.1017/CB09780511525896](https://doi.org/10.1017/CB09780511525896).
- [RS13] Dylan Rupel and David I. Spivak. *The operad of temporal wiring diagrams: formalizing a graphical language for discrete-time processes*. 2013. eprint: [arXiv:1307.6894](https://arxiv.org/abs/1307.6894).
- [Sel97] Peter Selinger. “First-order axioms for asynchrony”. In: *International Conference on Concurrency Theory*. Springer. 1997, pp. 376–390.
- [Spi13] David I. Spivak. “The operad of wiring diagrams: formalizing a graphical language for databases, recursion, and plug-and-play circuits”. In: *CoRR abs/1305.0297* (2013). URL: <http://arxiv.org/abs/1305.0297>.
- [Spi15] David I Spivak. “The steady states of coupled dynamical systems compose according to matrix arithmetic”. In: *arXiv preprint: 1512.00802* (2015).
- [SSR16] David I. Spivak, Patrick Schultz, and Dylan Rupel. “String diagrams for traced and compact categories are oriented 1-cobordisms”. In: (2016). URL: <http://arxiv.org/abs/1508.00000>.



- [Ste67] N. E. Steenrod. "A convenient category of topological spaces." In: *Michigan Math. J.* 14.2 (May 1967), pp. 133–152. DOI: [10.1307/mmj/1028999711](https://doi.org/10.1307/mmj/1028999711). URL: <http://dx.doi.org/10.1307/>
- [SY13] Janos Sztipanovits and Susan Ying. *Strategic R&D Opportunities for 21st century Cyber-Physical Systems*. Tech. rep. National Institute of Standards and Technology, Jan. 2013. URL: [http://www.nist.gov/el/upload/12-Cyber-Physical-Systems020113\\_final.pdf](http://www.nist.gov/el/upload/12-Cyber-Physical-Systems020113_final.pdf)
- [VSL15] Dmitry Vagner, David I. Spivak, and Eugene Lerman. "Algebras of open dynamical systems on the operad of wiring diagrams". In: *Theory Appl. Categ.* 30 (2015), Paper No. 51, 1793–1822. ISSN: 1201-561X.
- [Win87] Glynn Winskel. "Event structures". In: *Petri Nets: Applications and Relationships to Other Models of Concurrency: Advances in Petri Nets 1986, Part II Proceedings of an Advanced Course Bad Honnef, 8.–19. September 1986*. Ed. by W. Brauer, W. Reisig, and G. Rozenberg. Berlin, Heidelberg: Springer Berlin Heidelberg, 1987, pp. 325–392. ISBN: 978-3-540-47926-0. DOI: [10.1007/3-540-17906-2\\_31](https://doi.org/10.1007/3-540-17906-2_31). URL: <http://dx.doi.org/10.1007/>
- [WP13] Jan C Willems and Jan W Polderman. *Introduction to mathematical systems theory: a behavioral approach*. Vol. 26. Springer Science & Business Media, 2013.