

# Excisive Hierarchical Clustering Methods for Network Data

Gunnar Carlsson, Facundo Mémoli, Alejandro Ribeiro, and Santiago Segarra

**Abstract**—We introduce two practical properties of hierarchical clustering methods for (possibly asymmetric) network data: excisiveness and linear scale preservation. The latter enforces imperviousness to change in units of measure whereas the former ensures local consistency of the clustering outcome. Algorithmically, excisiveness implies that we can reduce computational complexity by only clustering a data subset of interest while theoretically guaranteeing that the same hierarchical outcome would be observed when clustering the whole dataset. Moreover, we introduce the concept of representability, i.e. a generative model for describing clustering methods through the specification of their action on a collection of networks. We further show that, within a rich set of admissible methods, requiring representability is equivalent to requiring both excisiveness and linear scale preservation. Leveraging this equivalence, we show that all excisive and linear scale preserving methods can be factored into two steps: a transformation of the weights in the input network followed by the application of a canonical clustering method. Furthermore, their factorization can be used to show stability of excisive and linear scale preserving methods in the sense that a bounded perturbation in the input network entails a bounded perturbation in the clustering output.

**Index Terms**—Hierarchical clustering, Networks, Excisiveness.

## I. INTRODUCTION

The concept of clustering, i.e. partitioning a dataset into groups such that objects in one group are more similar to each other than they are to objects outside the group, is a fundamental tool for the advancement of knowledge in a wide range of disciplines from, e.g., medicine [1] to marketing [2]. Motivated by its relevance, literally hundreds of clustering algorithms have been developed in the past decades [3]–[9] mainly for the application to finite metric spaces but also for asymmetric networks [10], in which the dissimilarity from node  $x$  to node  $x'$  may differ from the one from  $x'$  to  $x$  [11]–[19]. This prolific application-based clustering literature contrasts with a relatively barren landscape of theoretical understanding.

Although the theoretical underpinnings of clustering are not in general as well developed as its practice [20]–[22], the foundations of clustering in metric spaces have been developed over the past decade [23]–[29]. Even for the case of hierarchical clustering [8], [9], [19] where, instead of a

single partition we look for a family of partitions indexed by a resolution parameter, some theoretical understanding has been achieved for the case of finite metric spaces [25] and for the more general case of asymmetric networks [30]–[33]. Of special interest to our work is [30], where admissibility of hierarchical clustering methods is formulated in terms of two axioms and an infinite but bounded family of methods is shown to be admissible. However, the disadvantage of this approach is that admissibility is not a sufficient requirement to ensure practical relevance of clustering methods.

In the current paper we build upon [26] and [30], and deepen the characterization of hierarchical clustering methods on asymmetric networks to identify those with desirable practical properties. A particular aspect of our contribution is that we highlight the value of excisiveness and linear scale preservation as desirable conditions that one may require from such methods. After introducing basic concepts about clustering and networks (Section II), in Section III we present the notion of excisiveness to describe those methods which only utilize local data for the formation of clusters. This characteristic provides computational advantages which facilitate the application of excisive clustering methods in big datasets. In Section III-A, we present the notion of a linear scale preserving method, i.e. one in which the fundamental clustering structure of a dataset is independent of the units used to measure the dissimilarities across objects. The idea of idempotency is also introduced in Section III-B, although we show that this property has no discriminating power to further winnow the set of admissible clustering methods.

Representability, a notion introduced in Section IV, provides a generative model for clustering where a method is defined through the specification of its behavior in a set of special networks called representers. Although seemingly unrelated with the practical properties previously mentioned, representability is a key notion to characterize clustering methods. Indeed, in Section IV-A we show that an admissible clustering method is representable if and only if it is excisive and linear scale preserving. The value of this characterization result relies on stating an equivalence between a generative model for the construction of clustering methods with desirable properties for their implementation. Furthermore, in Section IV-B we show that every representable clustering method can be decomposed into a symmetrizing operation followed by the application of single linkage clustering. Leveraging this decomposition result, in Section V we show that every excisive and linear scale preserving method is stable in the sense that the clustering outputs of two networks which are similar are also similar. Finally, in Section VI, we illustrate the main result by implementing a representable clustering method, testing it on a

Authors are ordered alphabetically. Work in this paper is supported by NSF CCF-1217963, NSF CAREER CCF-0952867, NSF IIS-1422400, NSF CCF-1526513, AFOSR FA9550-09-0-1-0531, AFOSR FA9550-09-1-0643, NSF DMS-0905823, and NSF DMS-0406992. G. Carlsson is with the Dept. of Mathematics, Stanford Univ. F. Mémoli is with the Dept. of Mathematics and the Dept. of Computer Sc. and Eng., Ohio State Univ. A. Ribeiro and S. Segarra are with the Dept. of Electrical and Systems Eng., Univ. of Pennsylvania. Email: gunnar@math.stanford.edu, memoli@math.osu.edu, and {aribeiro, ssegarra}@seas.upenn.edu.

real-world economic network, and confirming its excisiveness.

## II. PRELIMINARIES

A network  $N$  is defined as a pair  $(X, A_X)$  where  $X$  is a finite set of  $n$  points or nodes and  $A_X : X \times X \rightarrow \mathbb{R}_+$  is a dissimilarity function. Dissimilarities  $A_X(x, x')$  from  $x$  to  $x'$  are non-negative, and null if and only if  $x = x'$ , but may not satisfy the triangle inequality and may be asymmetric, i.e.  $A_X(x, x') \neq A_X(x', x)$  for some  $x, x' \in X$ . Given a positive real  $\alpha$ , define the multiple of a network  $\alpha * N := (X, \alpha A_X)$ . Let  $\mathcal{N}$  denote the set of all networks. Networks  $N \in \mathcal{N}$  can have different node sets  $X$  and different dissimilarities  $A_X$ . We focus our study on asymmetric networks since these general structures include, as particular cases, symmetric networks and finite metric spaces.

The output of hierarchically clustering the network  $N = (X, A_X)$  is a dendrogram  $D_X$ , that is a nested collection of partitions  $D_X(\delta)$  indexed by the resolution parameter  $\delta \geq 0$ . Partitions in a dendrogram  $D_X$  must satisfy two boundary conditions: for the resolution parameter  $\delta = 0$  each point  $x \in X$  must form its own cluster, i.e.,  $D_X(0) = \{\{x\}, x \in X\}$ , and for some sufficiently large resolution  $\delta_0$  all nodes must belong to the same cluster, i.e.,  $D_X(\delta_0) = \{X\}$ . The requirement of nested partitions means that if  $x$  and  $x'$  are in the same partition at resolution  $\delta$ , then they stay co-clustered for all larger resolutions  $\delta' > \delta$ . From these requirements and a technical condition of continuity it follows that dendrograms can be represented as trees [34]. The interpretation of a dendrogram is that of a structure which yields different clusterings at different resolutions. When  $x$  and  $x'$  are co-clustered at resolution  $\delta$  in  $D_X$  we say that they are equivalent at that resolution and write  $x \sim_{D_X(\delta)} x'$ .

Given a network  $(X, A_X)$  and  $x, x' \in X$ , a chain  $C(x, x')$  is an ordered sequence of nodes in  $X$ ,  $C(x, x') = [x = x_0, x_1, \dots, x_{l-1}, x_l = x']$ , which starts at  $x$  and finishes at  $x'$ . The *links* of a chain are the edges connecting consecutive nodes of the chain in the direction given by it. We define the *cost* of chain  $C(x, x')$  as the maximum dissimilarity  $\max_{i|x_i \in C(x, x')} A_X(x_i, x_{i+1})$  encountered when traversing its links in order. The directed minimum chain cost  $\tilde{u}_X^*(x, x')$  between  $x$  and  $x'$  is defined as the minimum cost among all the chains connecting  $x$  to  $x'$ ,

$$\tilde{u}_X^*(x, x') := \min_{C(x, x')} \max_{i|x_i \in C(x, x')} A_X(x_i, x_{i+1}). \quad (1)$$

An ultrametric  $u_X$  on the set  $X$  is a function  $u_X : X \times X \rightarrow \mathbb{R}_+$  that satisfies symmetry  $u_X(x, x') = u_X(x', x)$ , identity  $u_X(x, x') = 0 \iff x = x'$  and the strong triangle inequality

$$u_X(x, x') \leq \max(u_X(x, x''), u_X(x'', x')), \quad (2)$$

for all  $x, x', x'' \in X$ . For a given dendrogram  $D_X$  consider the minimum resolution at which  $x$  and  $x'$  are co-clustered and define

$$u_X(x, x') := \min \{ \delta \geq 0 \mid x \sim_{D_X(\delta)} x' \}. \quad (3)$$

It can be shown that the function  $u_X$  as defined in (3) is an ultrametric on the set  $X$ , thus proving that dendrograms and finite ultrametric spaces are equivalent, [25]. However,

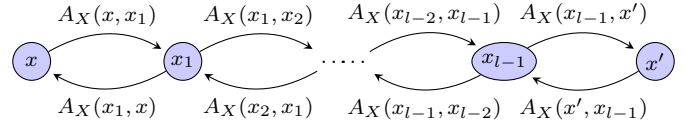

Fig. 1. Reciprocal clustering. Nodes  $x, x'$  cluster at resolution  $\delta$  if they can be joined with a bidirectional chain of maximum dissimilarity  $\delta$  [cf. (6)].

ultrametrics are more convenient than dendrograms for the results developed in this paper.

A hierarchical clustering method is defined as a map  $\mathcal{H} : \mathcal{N} \rightarrow \mathcal{D}$  from the set of networks  $\mathcal{N}$  to the set of dendrograms  $\mathcal{D}$ , or, equivalently, as a map  $\mathcal{H} : \mathcal{N} \rightarrow \mathcal{U}$  mapping every asymmetric network into the set  $\mathcal{U}$  of networks with ultrametrics as dissimilarity functions.

This loose definition of a hierarchical clustering method allows the existence of a wide variety of methods, most of them of little practical utility. Thus, in Section II-A we recall an axiomatic construction built to select a subfamily of admissible clustering methods.

For future reference, we say that two methods  $\mathcal{H}$  and  $\mathcal{H}'$  are *equivalent*, denoted  $\mathcal{H} \equiv \mathcal{H}'$ , if  $\mathcal{H}(N) = \mathcal{H}'(N)$  for all networks  $N \in \mathcal{N}$ . We also recall the definition of single linkage hierarchical clustering  $\mathcal{H}^{\text{SL}}$  of *symmetric* networks with output ultrametrics  $u_X^{\text{SL}}(x, x') := \min_{C(x, x')} \max_i A_X(x_i, x_{i+1})$ .

### A. Admissible hierarchical clustering methods

In [30], the authors impose the following two requirements on clustering methods:

(A1) *Axiom of Value.* Given a two-node network  $N = (\{p, q\}, A_{p,q})$  with  $A_{p,q}(p, q) = \alpha$ , and  $A_{p,q}(q, p) = \beta$ , the ultrametric  $(X, u_{p,q}) = \mathcal{H}(N)$  output by  $\mathcal{H}$  satisfies

$$u_{p,q}(p, q) = \max(\alpha, \beta). \quad (4)$$

(A2) *Axiom of Transformation.* Given networks  $N_X = (X, A_X)$  and  $N_Y = (Y, A_Y)$  and a dissimilarity reducing map  $\phi : X \rightarrow Y$ , i.e. a map  $\phi$  such that for all  $x, x' \in X$  it holds  $A_X(x, x') \geq A_Y(\phi(x), \phi(x'))$ , the outputs  $(X, u_X) = \mathcal{H}(N_X)$  and  $(Y, u_Y) = \mathcal{H}(N_Y)$  satisfy

$$u_X(x, x') \geq u_Y(\phi(x), \phi(x')). \quad (5)$$

We say that node  $x$  is able to influence node  $x'$  at resolution  $\delta$  if the dissimilarity from  $x$  to  $x'$  is not greater than  $\delta$ . In two-node networks, our intuition dictates that a cluster is formed if nodes  $p$  and  $q$  are able to influence each other. Thus, axiom (A1) states that in a network with two nodes, the dendrogram  $D_X$  has them merging at the maximum value of the two dissimilarities between them. Axiom (A2) captures the intuition that if a network is transformed such that some nodes become more similar but no pair of nodes increases its dissimilarity, then the transformed network should cluster at lower resolutions than the original one. Formally, (A2) states that a contraction of the dissimilarity function  $A_X$  entails a contraction of the associated ultrametric  $u_X$ .

A hierarchical clustering method  $\mathcal{H}$  is *admissible* if it satisfies axioms (A1) and (A2). Two admissible methods of interest

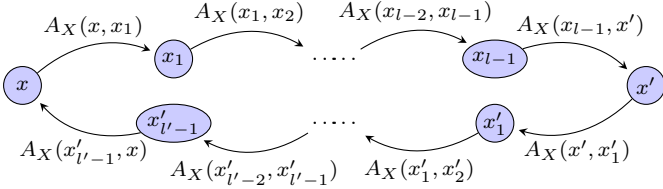

Fig. 2. Nonreciprocal clustering. Nodes  $x, x'$  cluster at resolution  $\delta$  if they can be joined in both directions with possibly different chains of maximum dissimilarity  $\delta$  [cf. (7)].

are reciprocal and nonreciprocal clustering. The *reciprocal* clustering method  $\mathcal{H}^R$  outputs the ultrametric  $(X, u_X^R) = \mathcal{H}^R(X, A_X)$  defined as

$$u_X^R(x, x') := \min_{C(x, x')} \max_{i|x_i \in C(x, x')} \bar{A}_X(x_i, x_{i+1}), \quad (6)$$

where  $\bar{A}_X(x, x') := \max(A_X(x, x'), A_X(x', x))$  for all  $x, x' \in X$ . Intuitively, in (6) we search for chains  $C(x, x')$  linking nodes  $x$  and  $x'$ . Then, for a given chain, we walk from  $x$  to  $x'$  and determine the maximum dissimilarity, in either the forward or backward direction, across all links in the chain. The reciprocal ultrametric  $u_X^R(x, x')$  is the minimum of this value across all possible chains; see Fig. 1.

Reciprocal clustering joins  $x$  and  $x'$  at resolution  $\delta$  if it is possible to go back and forth at maximum cost  $\delta$  through the same chain. By contrast, *nonreciprocal* clustering  $\mathcal{H}^{\text{NR}}$  permits different chains. We define the nonreciprocal ultrametric between  $x$  and  $x'$  as the maximum of two directed minimum chain costs (1) from  $x$  to  $x'$  and  $x'$  to  $x$

$$u_X^{\text{NR}}(x, x') := \max(\tilde{u}_X^*(x, x'), \tilde{u}_X^*(x', x)). \quad (7)$$

In (7) we implicitly consider forward chains  $C(x, x')$  going from  $x$  to  $x'$  and backward chains  $C(x', x)$  from  $x'$  to  $x$ . We then determine the respective maximum dissimilarities and search independently for the forward and backward chains that minimize the respective maximum dissimilarities. The nonreciprocal ultrametric  $u_X^{\text{NR}}(x, x')$  is the maximum of these two minimum values; see Fig. 2.

These two methods exemplify extremal behaviors. Indeed, reciprocal and nonreciprocal clustering bound the ultrametries generated by all admissible methods, as stated next.

**Theorem 1 ([30])** Consider an arbitrary network  $N = (X, A_X)$  and let  $u_X^R$  and  $u_X^{\text{NR}}$  be the associated reciprocal and nonreciprocal ultrametries as defined in (6) and (7). Then, for any admissible method  $\mathcal{H}$  the output ultrametric  $(X, u_X) = \mathcal{H}(X, A_X)$  is such that for all pairs  $x, x'$ ,

$$u_X^{\text{NR}}(x, x') \leq u_X(x, x') \leq u_X^R(x, x'). \quad (8)$$

In particular,  $u_X^{\text{NR}} = u_X^R$  whenever  $(X, A_X)$  is symmetric.

According to Theorem 1, nonreciprocal clustering yields uniformly minimal ultrametries while reciprocal clustering yields uniformly maximal ultrametries among all methods satisfying (A1)-(A2). Moreover, the existence of admissible methods strictly different from  $\mathcal{H}^{\text{NR}}$  and  $\mathcal{H}^R$  has been shown [35]. For symmetric networks, reciprocal and nonreciprocal clustering coincide, implying that there is a unique admissible

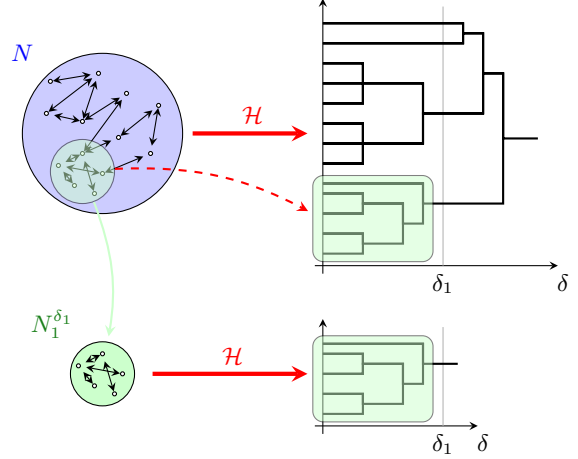

Fig. 3. The clustering method  $\mathcal{H}$  is excisive. Given an arbitrary network  $N$  (blue) the method  $\mathcal{H}$  outputs the dendrogram on the top right, where the green branch corresponds to the subnetwork  $N_1^{\delta_1}$ . If we consider the isolated subnetwork  $N_1^{\delta_1}$  and apply  $\mathcal{H}$ , excisiveness guarantees that the obtained dendrogram is equivalent to the green branch in the original one.

method, which is equivalent to the well-known single linkage hierarchical clustering method [9, Ch. 4]. In Sections III and III-A, we present practical properties – excisiveness and linear scale preservation – which are not shared by every admissible method and we use them to further winnow the set of clustering methods of practical relevance.

### III. EXCISIVENESS

Consider a clustering method  $\mathcal{H}$  and a given network  $N = (X, A_X)$ . Denote by  $(X, u_X) = \mathcal{H}(X, A_X)$  the ultrametric output, as  $D_X$  the output dendrogram and, for a given resolution  $\delta$ , denote the dendrogram's partition by  $D_X(\delta) = \{B_1(\delta), \dots, B_{J(\delta)}(\delta)\}$  where each block  $B_i(\delta)$  represents a cluster at resolution  $\delta$ . Consider then the induced subnetworks  $N_i^\delta$  associated with each block  $B_i(\delta)$  of  $D_X(\delta)$  defined as

$$N_i^\delta := \left( B_i(\delta), A_X|_{B_i(\delta) \times B_i(\delta)} \right), \quad (9)$$

where  $A_X|_{B_i(\delta) \times B_i(\delta)}$  denotes the restriction of  $A_X$  to the nodes in  $B_i(\delta)$ . In terms of ultrametries, networks  $N_i^\delta$  are such that their node set  $B_i(\delta)$  satisfies

$$\begin{aligned} u_X(x, x') &\leq \delta, & \text{for all } x, x' \in B_i(\delta), \\ u_X(x, x'') &> \delta, & \text{for all } x \in B_i(\delta), x'' \notin B_i(\delta). \end{aligned} \quad (10)$$

Two related ultrametries can be defined on the node set represented by any block  $B_i(\delta)$ . First, the result of restricting the output clustering ultrametric  $u_X$  to  $B_i(\delta)$ . Second, the ultrametric obtained when applying the clustering method  $\mathcal{H}$  to the subnetwork  $N_i^\delta$ . If the two intervening ultrametries are the same for every network  $N$ , all  $i$ , and all  $\delta > 0$ , then we say that the method  $\mathcal{H}$  is excisive as we formally define next.

(P1) *Excisiveness.* Consider a hierarchical clustering method  $\mathcal{H}$ , an arbitrary network  $N = (X, A_X)$  with ultrametric output  $(X, u_X) = \mathcal{H}(N)$ , and the corresponding subnetworks  $N_i^\delta$  defined in (9). We say the method  $\mathcal{H}$  is

excisive if for all subnetworks  $N_i^\delta$  at all resolutions  $\delta > 0$  it holds that

$$\mathcal{H}(N_i^\delta) = \left( B_i(\delta), u_X|_{B_i(\delta) \times B_i(\delta)} \right). \quad (11)$$

The appeal of excisive methods is that they exhibit local consistency in the following sense. For a given resolution  $\delta$ , when we cluster the subnetworks as defined in (9), we obtain a dendrogram on the node set  $B_i(\delta)$  for every  $i$ . Excisiveness ensures that when clustering the whole network and cutting the output dendrogram at resolution  $\delta$ , the branches obtained coincide with the previously computed dendrograms for every subnetwork, see Fig. 3. Our notion of excisiveness is inspired in [26], where a related concept was analyzed for non-hierarchical clustering of finite metric spaces.

Excisiveness entails a tangible practical advantage when hierarchically clustering big data. Often in practical applications, one begins by performing a coarse clustering at an exploratory phase. Notice that the computational cost of obtaining this coarse partition, which corresponds to *one* particular resolution, is smaller than that of computing the whole dendrogram. After having done this and having identified blocks in the resulting partition that contain a relevant subset of the original data, one focuses on these blocks – via the subsequent application of the clustering method – in order to reveal the whole hierarchical structure of this subset of the data. It is evident that the computational cost of clustering a subset of the data is smaller than the cost of clustering the whole dataset and then restricting the output to the relevant data subset. However, an excisive method guarantees that the results obtained through both procedures are identical, thus, reducing computational effort with no loss of clustering information. A specific example of the aforementioned computational gain is presented next.

**Example 1 (single linkage computation)** Focus on the application of single linkage hierarchical clustering to a finite metric space of  $n$  points. Single linkage is an excisive clustering method as can be concluded by combining Proposition 1 with the fact that, for finite metric spaces, reciprocal and nonreciprocal clustering coincide with single linkage (cf. Theorem 1). Consider two different ways of computing the output dendrogram for a subspace of the aforementioned finite metric space. The first approach is to hierarchically cluster the whole finite metric space and then extract the relevant branch. The computational cost of single linkage is equivalent to that of finding a minimum spanning tree in an undirected graph which, for a complete graph, is of cost  $\mathcal{O}(n^2)$  [36]. The second approach consists of first obtaining the partition given by single linkage corresponding to *one* coarse resolution. This is equivalent to finding the connected components in a graph where only the edges of weight smaller than the resolution are present. Assuming that the average degree of each node in this graph is  $\alpha$ , the computational cost of finding the connected components is  $\mathcal{O}(\max(n, n\alpha/2)) = \mathcal{O}(n\alpha/2)$  as long as  $\alpha \geq 2$  [37]. After this, we pick the subspace of interest and find its minimum spanning tree. Assuming that the subspace contains  $\beta n$  nodes, the cost of finding the minimum spanning tree is  $\mathcal{O}(\beta^2 n^2)$ . Consequently, the cost of the first

approach is  $\mathcal{O}(n^2)$  whereas the cost of the second one is  $\mathcal{O}(n\alpha/2) + \mathcal{O}(\beta^2 n^2)$ . This entails an asymptotic reduction of order  $\beta^{-2}$ . Excisiveness ensures that the output of both approaches coincide, allowing us to follow the second – more efficient – approach.

There exist clustering methods that, while satisfying axioms (A1)-(A2), are also excisive. Indeed, the reciprocal and non-reciprocal clustering methods introduced in Section II-A are excisive as we state next.

**Proposition 1** *The reciprocal  $\mathcal{H}^R$  and the nonreciprocal  $\mathcal{H}^{NR}$  clustering methods with output ultrametrics defined in (6) and (7) respectively, are excisive as defined in (P1).*

**Proof:** Given an arbitrary network  $N = (X, A_X)$ , denote by  $(X, u_X^R) = \mathcal{H}^R(N)$  the output ultrametric when applying reciprocal clustering  $\mathcal{H}^R$  to  $N$ . Pick an arbitrary resolution  $\delta$  and focus on a subnetwork  $N_i^\delta = (X_i^\delta, A_{X_i^\delta})$  as defined in (9). Denote by  $(X_i^\delta, u_{X_i^\delta}^R) = \mathcal{H}^R(N_i^\delta)$  the clustering output when applying  $\mathcal{H}^R$  to the subnetwork  $N_i^\delta$ . We want to show that

$$u_{X_i^\delta}^R \equiv u_X^R|_{X_i^\delta \times X_i^\delta}. \quad (12)$$

Since the network  $N$ , the resolution  $\delta$  and the subnetwork index  $i$  were chosen arbitrarily, (12) would imply that the reciprocal clustering method  $\mathcal{H}^R$  is excisive [cf. (P1)], as wanted. We first show that

$$u_{X_i^\delta}^R(x, x') \geq u_X^R(x, x'), \quad (13)$$

for all nodes  $x, x' \in X_i^\delta$ . Notice that the inclusion map  $\phi: X_i^\delta \rightarrow X$  from network  $N_i^\delta$  to  $N$  such that  $\phi(x) = x$  is a dissimilarity reducing map as defined in (A2). Hence, since  $\mathcal{H}^R$  satisfies the Axiom of Transformation (A2), inequality (13) must hold. In order to show the opposite inequality, pick arbitrary nodes  $x, x' \in X_i^\delta$  and assume that

$$u_X^R(x, x') = \alpha. \quad (14)$$

From (10), we know that  $\alpha \leq \delta$ . From the definition of  $\mathcal{H}^R$  in (6), equality (14) implies that there exists a chain  $C(x, x') = [x = x_0, x_1, \dots, x_l = x']$  where the maximum dissimilarity in both directions between consecutive nodes is  $\alpha$ . However, notice that part of this chain can be used to join any two nodes  $x_j$  and  $x_k$  where  $j, k \in \{0, 1, \dots, l\}$  with dissimilarities not larger than  $\alpha$ . This implies that  $u_X^R(x_j, x_k) = \alpha$  for  $j, k \in \{0, 1, \dots, l\}$  and from the definition of subnetwork [cf. (10)] we must have that  $x_j \in X_i^\delta$  for all  $j \in \{0, 1, \dots, l\}$ . Consequently, when applying the reciprocal clustering method  $\mathcal{H}^R$  to  $N_i^\delta$ , the nodes in the chain  $C(x, x')$  are contained in its node set  $X_i^\delta$ , allowing us to write [cf. (6)]

$$u_{X_i^\delta}^R(x, x') \leq \max_{j|x_j \in C(x, x')} \bar{A}_{X_i^\delta}(x_j, x_{j+1}) = \alpha = u_X^R(x, x'), \quad (15)$$

where the inequality comes from the fact that we picked one particular chain  $C(x, x')$  instead of minimizing across the set of all possible chains. Since  $x, x' \in X_i^\delta$  were picked arbitrarily, (15) implies that  $u_{X_i^\delta}^R(x, x') \leq u_X^R(x, x')$  for all  $x, x' \in X_i^\delta$ .

Combining this inequality with (13), equivalence (12) follows and we show excisiveness of  $\mathcal{H}^R$ , as wanted.

A similar argument can be used to show excisiveness of the nonreciprocal clustering method  $\mathcal{H}^{\text{NR}}$ . ■

Despite Proposition 1, excisiveness is not implied by admissibility with respect to (A1) and (A2). To see this, consider the admissible semi-reciprocal clustering method  $\mathcal{H}^{\text{SR}(t)}$  introduced in [35] and briefly explained next.

Semi-reciprocal clustering presents an intermediate behavior between reciprocal and nonreciprocal clustering. In reciprocal clustering, we minimize the cost of a chain in both directions simultaneously whereas in nonreciprocal clustering we minimize the cost in both directions separately. However, semi-reciprocal clustering adopts an intermediate position. In order to formalize this, we denote by  $C_t(x, x')$  a chain starting at  $x$  and finishing at  $x'$  with at most  $t$  nodes while we reserve the notation  $C(x, x')$  to denote a chain linking  $x$  with  $x'$  with no maximum imposed on the number of nodes in the chain. Given a network  $N = (X, A_X)$ , define as  $A_X^{\text{SR}(t)}(x, x')$  the minimum cost incurred when traveling from node  $x$  to node  $x'$  using a chain of at most  $t$  nodes. I.e.,

$$A_X^{\text{SR}(t)}(x, x') := \min_{C_t(x, x')} \max_{i | x_i \in C_t(x, x')} A_X(x_i, x_{i+1}). \quad (16)$$

The family of semi-reciprocal clustering methods  $\mathcal{H}^{\text{SR}(t)}$  with output  $(X, u_X^{\text{SR}(t)}) = \mathcal{H}^{\text{SR}(t)}(X, A_X)$  is defined as

$$u_X^{\text{SR}(t)}(x, x') := \min_{C(x, x')} \max_{i | x_i \in C(x, x')} \bar{A}_X^{\text{SR}(t)}(x_i, x_{i+1}), \quad (17)$$

where the function  $\bar{A}_X^{\text{SR}(t)}(x_i, x_{i+1})$  is computed as follows

$$\bar{A}_X^{\text{SR}(t)}(x_i, x_{i+1}) := \max(A_X^{\text{SR}(t)}(x_i, x_{i+1}), A_X^{\text{SR}(t)}(x_{i+1}, x_i)). \quad (18)$$

We can interpret (17) as the application of reciprocal clustering [cf. (6)] to a network with dissimilarities given by  $A_X^{\text{SR}(t)}$  in (16), i.e., a network with dissimilarities given by the optimal choice of chains of constrained length  $t$ . Semi-reciprocal clustering methods satisfy axioms (A1)-(A2); see [31], [35].

To see that admissibility does not imply excisiveness, consider the network in Fig. 4 and its dendrogram corresponding to the semi-reciprocal clustering method  $\mathcal{H}^{\text{SR}(3)}$ . For a resolution  $\delta = 1.5$ , focus on the subnetwork  $N_1^{1.5} = (\{x_1, x_3\}, A_{\{1,3\}})$  with  $A_{\{1,3\}}(x_1, x_3) = A_{\{1,3\}}(x_3, x_1) = 2$ . When the clustering method  $\mathcal{H}^{\text{SR}(3)}$  is applied to this subnetwork, the output dendrogram (red) differs from the corresponding branch in the original dendrogram (green). This counterexample shows that excisiveness cannot be derived from axioms (A1) and (A2).

#### A. Linear scale preservation

Another desirable property of hierarchical clustering methods is that of linear scale preservation as stated next.

(P2) *Linear Scale Preservation.* Consider a network  $N_X = (X, A_X)$  and a linear function  $\psi : \mathbb{R}_+ \rightarrow \mathbb{R}_+$  where  $\psi(z) = \alpha z$ , for some  $\alpha > 0$ . Define the network

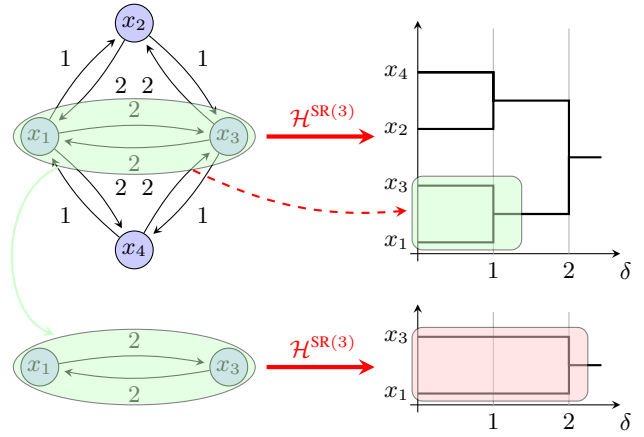

Fig. 4. Admissibility does not imply excisiveness. The admissible method  $\mathcal{H}^{\text{SR}(3)}$  does not satisfy the excisiveness condition since the green branch in the top dendrogram differs from the red branch in the lower one [cf. Fig. 3].

$N_X^\psi := (X, \psi \circ A_X)$  with the same set of nodes and linearly scaled dissimilarities. A hierarchical clustering method  $\mathcal{H}$  is said to be *linear scale preserving* if for an arbitrary network  $N_X = (X, A_X)$  and a function  $\psi$  satisfying the above requirements, the outputs  $(X, u_X) := \mathcal{H}(X, A_X)$  and  $(X, u_X^\psi) := \mathcal{H}(X, \psi \circ A_X)$  satisfy

$$u_X^\psi = \psi \circ u_X. \quad (19)$$

For linear scale preserving methods, the ultrametric outcomes vary according to the same linear function that transforms the dissimilarity function. Consequently, the hierarchical structure output by these methods is invariant with respect to units. In terms of dendrograms, linear scale preservation entails that a transformation of dissimilarities with an appropriate linear function  $\psi$  results in a dendrogram where the order in which nodes are clustered together is the same while the resolution at which mergings occur changes linearly according to  $\psi$ .

In practice, linear scale preservation is a desirable property. E.g., if we want to hierarchically cluster finite metric spaces – which are particular cases of asymmetric networks where every dissimilarity is symmetric and the triangle inequality is satisfied – the hierarchy of the output should not depend on the unit used to measure distances. Equivalently, the choice of units does not alter the nature of a given metric space, thus, if we measure distances in, e.g., meters or centimeters we should obtain the same structure when clustering both. Linear scale preserving methods guarantee this behavior for arbitrary asymmetric networks.

The reciprocal and nonreciprocal clustering methods introduced in Section II-A are linear scale preserving.

**Proposition 2** *The reciprocal  $\mathcal{H}^R$  and the nonreciprocal  $\mathcal{H}^{\text{NR}}$  clustering methods with output ultrametrics defined in (6) and (7) respectively, are linear scale preserving as defined in (P2).*

**Proof:** To prove that  $\mathcal{H}^R$  is linear scale preserving, define two networks  $N_X = (X, A_X)$  and  $N_Y = (Y, A_Y)$  with  $X = Y$  and  $A_Y = \psi \circ A_X$  where  $\psi$  is an increasing linear function as in (P2). Denote by  $(X, u_X^R) = \mathcal{H}^R(N_X)$  and  $(Y, u_Y^R) = \mathcal{H}^R(N_Y)$  the corresponding output ultrametrics.



Consider one minimizing chain  $C_X^*(x, x') = [x = x_0, \dots, x_l = x']$  in definition (6) and focus on the chain  $C_Y(y, y')$  in  $N_Y$  with  $y_i = x_i$  for all  $i$ . Notice that this is a particular chain joining  $y$  and  $y'$ . Hence, we can state,

$$u_Y^R(y, y') \leq \max_{i|y_i \in C_Y(y, y')} \bar{A}_Y(y_i, y_{i+1}) = \psi(u_X^R(x, x')). \quad (20)$$

We now want to show that the inequality in (20) cannot be strict, thus implying equality and proving the linear scale preservation of reciprocal clustering.

Suppose that  $u_Y^R(y, y') < \psi(u_X^R(x, x'))$  for some minimizing chain  $C^*(y, y') = [y = y_0, \dots, y_{l'} = y']$  such that, for some  $s$  between 0 and  $l'$ , we can write

$$\max_{i|y_i \in C^*(y, y')} \bar{A}_Y(y_i, y_{i+1}) = \bar{A}_Y(y_s, y_{s+1}) < \psi(u_X^R(x, x')). \quad (21)$$

Consider the chain  $C(x, x') = [x = x_0, \dots, x_{l'} = x']$  in  $N_X$  with  $x_i = y_i$  for all  $i$ . From the definition of reciprocal clustering (6) we can state that,

$$u_X^R(x, x') \leq \max_{i|x_i \in C(x, x')} \bar{A}_X(x_i, x_{i+1}) = \bar{A}_X(x_s, x_{s+1}), \quad (22)$$

where the last equality holds because  $\psi$  is an increasing function and, as a consequence, every maximizer in (21) must also be a maximizer in (22). Combining the fact that  $\psi$  is increasing with the definition  $A_Y = \psi \circ A_X$ , we can apply  $\psi$  to inequality (22) to obtain that

$$\psi(u_X^R(x, x')) \leq \bar{A}_Y(x_s, x_{s+1}). \quad (23)$$

However, inequalities (21) and (23) contradict each other, thus our strict inequality assumption preceding (21) cannot be true, showing linear scale preservation of  $\mathcal{H}^R$ .

A similar argument can be used to show linear scale preservation of  $\mathcal{H}^{\text{NR}}$ . ■

Proposition 2 notwithstanding, linear scale preservation is a condition independent of axioms (A1) and (A2). This can be seen by analyzing the behavior of the admissible method  $\mathcal{H}^{\text{R/NR}}(\beta)$  introduced in [35] and briefly explained next.

The grafting clustering method  $\mathcal{H}^{\text{R/NR}}(\beta)$  is constructed by pasting branches of the nonreciprocal dendrogram into corresponding branches of the reciprocal dendrogram. To define this precisely, for a given network  $N = (X, A_X)$ , one computes the reciprocal and nonreciprocal dendrograms and cut all branches of the reciprocal dendrogram at resolution  $\beta > 0$ . Then, replace the cut branches of the reciprocal tree by the corresponding branches – i.e., those with the same leaves – of the nonreciprocal tree. This hybrid dendrogram is the output of applying  $\mathcal{H}^{\text{R/NR}}(\beta)$  to the network  $N$ . In terms of ultrametrics, we can define this pasting formally as follows.

$$u_X^{\text{R/NR}}(x, x'; \beta) := \begin{cases} u_X^{\text{NR}}(x, x'), & \text{if } u_X^R(x, x') \leq \beta, \\ u_X^R(x, x'), & \text{if } u_X^R(x, x') > \beta. \end{cases} \quad (24)$$

The ultrametric defined in (24) is valid and  $\mathcal{H}^{\text{R/NR}}(\beta)$  satisfies axioms (A1) and (A2); see [31], [35].

The method  $\mathcal{H}^{\text{R/NR}}(\beta)$  is not linear scale preserving as can be seen from a simple counterexample. Consider the three-node network in Fig. 5 as well as its transformation after applying the linear function  $\psi(z) = 2z$ . The figure illustrates

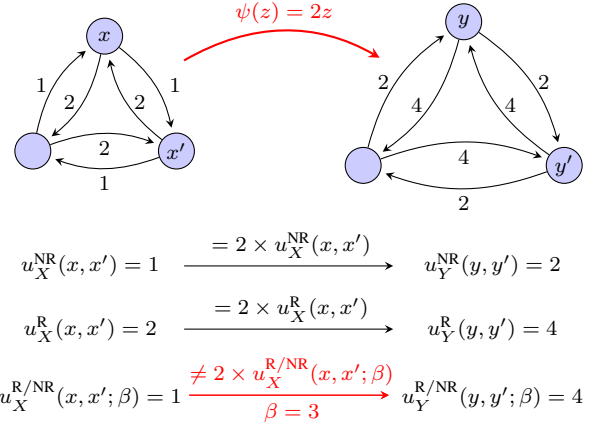

Fig. 5. Admissibility does not imply linear scale preservation. Reciprocal and nonreciprocal clustering are linear scale preserving while  $\mathcal{H}^{\text{R/NR}}(\beta)$  is not.

the fact that the reciprocal and nonreciprocal ultrametrics are transformed by  $\psi$ , as it should be given Proposition 2. However, we see that the ultrametric output by  $\mathcal{H}^{\text{R/NR}}(\beta)$  (for  $\beta = 3$ ) is multiplied by 4 instead of by 2, thus violating (P2).

Given that excisiveness and linear scale preservation are two important practical properties of hierarchical clustering methods, we want to characterize the family of admissible methods satisfying them. From Propositions 1 and 2 we know that reciprocal and nonreciprocal clustering belong to this family. Our objective is to find if other methods are contained within this family and to provide a comprehensive description of these. To this end, we introduce the concept of representability in Section IV.

## B. Idempotency

The outcome of applying a hierarchical clustering method  $\mathcal{H}$  to a network is a finite ultrametric space. Since finite ultrametric spaces  $(X, u_X)$  are particular cases of networks, i.e.,  $(X, u_X) \in \mathcal{U} \subset \mathcal{N}$ , we can study the result of repeated applications of a clustering method  $\mathcal{H}$ . We expect that clustering a network that has been already clustered should not alter the outcome. This is formally stated as the requirement that the map  $\mathcal{H} : \mathcal{N} \rightarrow \mathcal{U}$  be idempotent, i.e., that for every network  $N = (X, A_X) \in \mathcal{N}$  we have

$$\mathcal{H}(\mathcal{H}(X, A_X)) = \mathcal{H}(X, A_X). \quad (25)$$

Alternatively, (25) is true if whenever we restrict the map  $\mathcal{H}$  to the set of finite ultrametric spaces  $\mathcal{U}$ , the method is equivalent to an identity map,

$$\mathcal{H}(X, u_X) = (X, u_X), \text{ for all } (X, u_X) \in \mathcal{U}. \quad (26)$$

Idempotency is not a stringent requirement. In particular, any method that satisfies the axioms of value and transformation is idempotent as we show in the following proposition.

**Proposition 3** *Every admissible clustering method  $\mathcal{H}$  is idempotent in the sense of (25).*

**Proof:** We prove that any admissible method  $\mathcal{H}$  is idempotent by showing that it satisfies (26). Consider the application

of admissible methods  $\mathcal{H}$  to the ultrametric network  $U_X = (X, u_X)$ . Since  $U_X$  is symmetric, by Theorem 1 we have that  $u_X^{\text{NR}} = u_X^{\text{R}}$ . Thus, if we show that  $\mathcal{H}^{\text{R}}$  satisfies (26) we know that  $\mathcal{H}^{\text{NR}}$  also satisfies it. Moreover, from (8) it would follow that every admissible method must satisfy (26), thus showing their idempotency. Consequently, we need to show that  $\mathcal{H}^{\text{R}}$  satisfies (26).

Denoting by  $(X, u_X^{\text{R}}) = \mathcal{H}^{\text{R}}(X, u_X)$  the outcome of applying  $\mathcal{H}^{\text{R}}$  to  $U_X$ , we can write for all  $x, x' \in X$  [cf. (6)]

$$u_X^{\text{R}}(x, x') = \min_{C(x, x')} \max_{i|x_i \in C(x, x')} u_X(x_i, x_{i+1}), \quad (27)$$

where there is no need to take the maximum between  $u_X(x_i, x_{i+1})$  and  $u_X(x_{i+1}, x_i)$  since  $U_X$  is symmetric. Given a chain  $C(x, x')$  and using the fact that  $u_X$  is an ultrametric it follows from the strong triangle inequality in (2) that  $u_X(x, x') \leq \max_{i|x_i \in C(x, x')} u_X(x_i, x_{i+1})$ . Since the previous inequality is valid for *all* chains and the value of  $u_X^{\text{R}}(x, x')$  in (27) comes from the cost of some chain, we have that  $u_X^{\text{R}}(x, x') \geq u_X(x, x')$ , for all  $x, x' \in X$ . Also, by considering the particular chain  $C(x, x') = [x, x']$  with cost  $u_X(x, x')$ , it follows from (27) that  $u_X^{\text{R}}(x, x') \leq u_X(x, x')$ , for all  $x, x' \in X$ . Combining these inequalities, we have that  $u_X^{\text{R}}(x, x') = u_X(x, x')$  for all  $x, x' \in X$ , as wanted ■

Since, according to Proposition 3, idempotency is implied by (A1)-(A2) it cannot be used as an additional requirement to further winnow the set of methods of practical relevance. Thus, we limit ourselves to characterize excisive, linear scale preserving clustering methods.

#### IV. REPRESENTABILITY

We define a representable hierarchical clustering method as one where the clustering of arbitrary networks is specified through the clustering of particular examples that we call *representers*. Representers are possibly asymmetric networks  $\omega = (X_\omega, A_\omega)$  where the dissimilarity function  $A_\omega$  may not be defined for all pairs of nodes, i.e.,  $\text{dom}(A_\omega) \neq X_\omega \times X_\omega$ ; see Fig. 6.

Given an arbitrary network  $N = (X, A_X)$ , and a representer  $\omega = (X_\omega, A_\omega)$ , we define the *expansion constant* of a map  $\phi: X_\omega \rightarrow X$  from  $\omega$  to  $N$  as

$$L(\phi; \omega, N) := \max_{\substack{(z, z') \in \text{dom}(A_\omega) \\ z \neq z'}} \frac{A_X(\phi(z), \phi(z'))}{A_\omega(z, z')}. \quad (28)$$

Notice that  $L(\phi; \omega, N)$  is the minimum multiple of the network  $\omega$  such that the considered map  $\phi$  is dissimilarity reducing as defined in (A2) from  $L(\phi; \omega, N) * \omega$  to  $N$ . Notice as well that the maximum in (28) is computed for pairs  $(z, z')$  in the domain of  $A_\omega$ . Pairs not belonging to the domain can be mapped to any dissimilarity without modifying the value of the expansion constant. We define the optimal multiple  $\lambda_X^\omega(x, x')$  between  $x$  and  $x'$  with respect to  $\omega$  as

$$\lambda_X^\omega(x, x') := \min \{L(\phi; \omega, N) \mid \phi: X_\omega \rightarrow X, x, x' \in \text{Im}(\phi)\}. \quad (29)$$

Equivalently,  $\lambda_X^\omega(x, x')$  is the minimum expansion constant among those maps that have  $x$  and  $x'$  in their image. I.e.,

it is the minimum multiple needed for the existence of a dissimilarity reducing map from a multiple of  $\omega$  to  $N$  that has  $x$  and  $x'$  in its image.

We can now define the representable method  $\mathcal{H}^\omega$  associated with a given representer  $\omega$  by defining the cost of a chain  $C(x, x') = [x = x_0, \dots, x_l = x']$  linking  $x$  to  $x'$  as the maximum optimal multiple  $\lambda_X^\omega(x_i, x_{i+1})$  between consecutive nodes in the chain. The ultrametric  $u_X^\omega$  associated with output  $(X, u_X^\omega) = \mathcal{H}^\omega(X, A_X)$  is given by the minimum chain cost

$$u_X^\omega(x, x') := \min_{C(x, x')} \max_{i|x_i \in C(x, x')} \lambda_X^\omega(x_i, x_{i+1}), \quad (30)$$

for all  $x, x' \in X$ . Representable methods are generalized to cases in which we are given a nonempty set  $\Omega$  of representer networks  $\omega$ . In such case, we define the function  $\lambda_X^\Omega$  as

$$\lambda_X^\Omega(x, x') := \inf_{\omega \in \Omega} \lambda_X^\omega(x, x'), \quad (31)$$

for all  $x, x' \in X$ . The value  $\lambda_X^\Omega(x, x')$  is the infimum across all optimal multiples given by the different representers  $\omega \in \Omega$ . For a given network  $N = (X, A_X)$ , the representable clustering method  $\mathcal{H}^\Omega$  associated with the collection of representers  $\Omega$  is the one with outputs  $(X, u_X^\Omega) = \mathcal{H}^\Omega(X, A_X)$  such that the ultrametric  $u_X^\Omega$  is given by

$$u_X^\Omega(x, x') := \min_{C(x, x')} \max_{i|x_i \in C(x, x')} \lambda_X^\Omega(x_i, x_{i+1}), \quad (32)$$

for all  $x, x' \in X$ .

As we mentioned, not all dissimilarities are necessarily defined in representer networks. However, the issue of whether a representer network is connected or not plays a prominent role in the validity and admissibility of representable methods. We say that a representer network  $\omega = (X_\omega, A_\omega)$  is *weakly connected* if for every pair of nodes  $z, z' \in X_\omega$  we can find a chain  $C(z, z') = [z = z_0, \dots, z_l = z']$  such that either  $(z_i, z_{i+1}) \in \text{dom}(A_\omega)$  or  $(z_{i+1}, z_i) \in \text{dom}(A_\omega)$  or both for all  $i = 0, \dots, l-1$ . Moreover, we say that  $\Omega$  is *uniformly bounded* if and only if there exists a finite  $M > 0$  such that

$$\max_{(z, z') \in \text{dom}(A_\omega)} A_\omega(z, z') \leq M, \quad (33)$$

for all  $\omega = (X_\omega, A_\omega) \in \Omega$ . We can now formally define the notion of representability.

**(P3) Representability.** We say that a clustering method  $\mathcal{H}$  is *representable* if there exists a uniformly bounded collection  $\Omega$  of weakly connected representers each with a finite number of nodes such that  $\mathcal{H} \equiv \mathcal{H}^\Omega$  where  $\mathcal{H}^\Omega$  has output ultrametrics as in (32).

It can be shown that indeed under the conditions in (P3), (32) defines a valid ultrametric, as stated next.

**Proposition 4** *For every collection of representers  $\Omega$  satisfying the conditions in (P3), (32) defines a valid ultrametric.*

**Proof:** Given a collection  $\Omega$  of representers  $\omega = (X_\omega, A_\omega)$ , we want to see that for an arbitrary network  $N = (X, A_X)$  the output  $(X, u_X^\Omega) = \mathcal{H}^\Omega(X, A_X)$  satisfies the identity, symmetry, and strong triangle inequality properties of an

ultrametric. To show that the strong triangle inequality in (2) is satisfied let  $C^*(x, x')$  and  $C^*(x', x'')$  be minimizing chains for  $u_X^\Omega(x, x')$  and  $u_X^\Omega(x', x'')$ , respectively. Consider then the chain  $C(x, x'')$  obtained by concatenating  $C^*(x, x')$  and  $C^*(x', x'')$ , in that order. Notice that the maximum over  $i$  of the optimal multiples  $\lambda_X^\Omega(x_i, x_{i+1})$  in  $C(x, x'')$  does not exceed the maximum multiples in each individual chain. Thus, the maximum multiple in the concatenated chain  $C(x, x'')$  suffices to bound  $u_X^\Omega(x, x'') \leq \max(u_X^\Omega(x, x'), u_X^\Omega(x', x''))$  by (32) as in (2).

To show the symmetry property,  $u_X^\Omega(x, x') = u_X^\Omega(x', x)$  for all  $x, x' \in X$ , first notice that a direct implication of the definition of optimal multiples in (29) is that  $\lambda_X^\omega(x, x') = \lambda_X^\omega(x', x)$  for every representer  $\omega$ . From (31) we then obtain that  $\lambda_X^\Omega$  is symmetric, from where symmetry of  $u_X^\Omega$  immediately follows.

For the identity property, i.e.  $u_X^\Omega(x, x') = 0$  if and only if  $x = x'$ , we first show that if  $x = x'$  we must have  $u_X^\Omega(x, x') = 0$ . Pick any  $x \in X$ , let  $x' = x$  and pick the chain  $C(x, x) = [x, x]$  starting and ending at  $x$  with no intermediate nodes as a candidate minimizing chain in (32). While this particular chain need not be optimal in (32) it nonetheless holds that

$$0 \leq u_X^\Omega(x, x) \leq \lambda_X^\Omega(x, x), \quad (34)$$

where the first inequality holds because all costs  $\lambda_X^\Omega(x_i, x_{i+1})$  in (32) are non-negative since they correspond to the expansion constant of some map, which is non-negative by definition (28). Notice that for the cost  $\lambda_X^\omega(x, x)$  in (29), we minimize the expansion constant among maps  $\phi_{x,x}$  that are only required to have node  $x$  in its image. Thus, consider the map that takes all the nodes in any representer  $\omega \in \Omega$  into node  $x \in X$ . From (28), the expansion constant of this map is zero which implies by (29) that  $\lambda_X^\omega(x, x) = 0$  for all  $\omega \in \Omega$ . Combining this result with (31) we then get that  $\lambda_X^\Omega(x, x) = 0$  and from (34) we conclude that  $u_X^\Omega(x, x) = 0$ .

In order to show that the condition  $u_X^\Omega(x, x') = 0$  implies that  $x = x'$  we prove that if  $x \neq x'$  we must have  $u_X^\Omega(x, x') > \alpha > 0$  for some strictly positive constant  $\alpha$ . In the proof we make use of the following claim.

**Claim 1** *Given a network  $N = (X, A_X)$ , a weakly connected representer  $\omega = (X_\omega, A_\omega)$ , and a dissimilarity reducing map  $\phi : X_\omega \rightarrow X$  whose image satisfies  $|\text{Im}(\phi)| \geq 2$ , there exists a pair of points  $(z, z') \in \text{dom}(A_\omega)$  for which  $\phi(z) \neq \phi(z')$ .*

**Proof:** Suppose that  $\phi(z^1) = x^1$  and  $\phi(z^2) = x^2$ , with  $x^1 \neq x^2 \in X$ . These nodes can always be found since  $|\text{Im}(\phi)| \geq 2$ . By our hypothesis, the network is weakly connected. Hence, there must exist a chain  $C(z^1, z^2) = [z^1 = z_0, z_1, \dots, z_l = z^2]$  linking  $z^1$  and  $z^2$  for which either  $(z_i, z_{i+1}) \in \text{dom}(A_\omega)$  or  $(z_{i+1}, z_i) \in \text{dom}(A_\omega)$  for all  $i = 0, \dots, l-1$ . Focus on the image of this chain under the map  $\phi$ ,  $C(x^1, x^2) = [x^1 = \phi(z_0), \phi(z_1), \dots, \phi(z_l) = x^2]$ . Notice that not all the nodes are necessarily distinct, however, since the extreme nodes are different by construction, at least one pair of consecutive nodes must differ, say  $\phi(z_p) \neq \phi(z_{p+1})$ . Due to  $\omega$  being weakly connected, in the original chain we must have either  $(z_p, z_{p+1})$  or  $(z_{p+1}, z_p) \in \text{dom}(A_\omega)$ . Hence, either  $z = z_p$  and  $z' = z_{p+1}$  or vice versa must fulfill the statement of the claim. ■

Returning to the main argument, observe that since pairwise dissimilarities in all networks  $\omega \in \Omega$  are uniformly bounded, the maximum dissimilarity across all links of all representers

$$d_{\max} = \sup_{\omega \in \Omega} \max_{(z, z') \in \text{dom}(A_\omega)} A_\omega(z, z'), \quad (35)$$

is guaranteed to be finite. Define the separation of the network  $\text{sep}(X, A_X) := \min_{x \neq x'} A_X(x, x')$  as its minimum positive dissimilarity and pick any real  $\alpha$  such that  $0 < \alpha < \text{sep}(X, A_X)/d_{\max}$ . Then for all  $(z, z') \in \text{dom}(A_\omega)$  and all  $\omega \in \Omega$  we have

$$\alpha A_\omega(z, z') < \text{sep}(X, A_X). \quad (36)$$

Claim 1 implies that regardless of the map  $\phi$  chosen, this map transforms some defined dissimilarity in  $\omega$ , i.e.  $A_\omega(z, z')$  for some  $(z, z') \in \text{dom}(A_\omega)$ , into a dissimilarity in  $N$ . Moreover, every positive dissimilarity in  $N$  is greater than or equal to the network separation  $\text{sep}(X, A_X)$ . Hence, (36) implies that there cannot be any dissimilarity reducing map  $\phi$  with  $|\text{Im}(\phi)| \geq 2$  from  $\alpha * \omega$  to  $N$  for any  $\omega \in \Omega$ . From (29), this implies that for all  $x \neq x' \in X$  and for all  $\omega$  we have that  $\lambda_X^\omega(x, x') > \alpha > 0$ . Hence, from (31) we conclude that  $\lambda_X^\Omega(x, x') > \alpha > 0$ , which in turn implies that the ultrametric value between two different nodes  $u_X^\Omega(x, x')$  must be strictly positive. ■

Representability allows the definition of universal hierarchical clustering methods from given representative examples. Every representer  $\omega \in \Omega$  can be understood as defining a specific structure that can be considered as a cluster unit. The scaling of this cluster unit [cf. (29)] and its replication throughout the network [cf. (30)] signal the resolution at which nodes become part of the same cluster. For nodes  $x$  and  $x'$  to cluster together at resolution  $\delta$ , we need to construct a path from  $x$  to  $x'$  with overlapping versions of representer networks scaled by parameters not larger than  $\delta$ . When we have multiple representers, we can use any of them to build these chains [cf. (31) and (32)]. Our definition of representable hierarchical clustering method builds upon the notion of representability for non-hierarchical clustering of finite metric spaces introduced in [26].

Although seemingly unrelated, the property of representability (P3) is tightly related to the more practical requirements of excisiveness (P1) and linear scale preservation (P2), as we see in the next section.

#### A. A generative model for excisive methods

The following theorem establishes a relationship between representable and excisive methods.

**Theorem 2** *Given an admissible hierarchical clustering method  $\mathcal{H}$ , it is representable (P3) if and only if it is excisive (P1) and linear scale preserving (P2).*

**Proof:** We first prove that (P3) implies (P1) and (P2). Notice that the expansion constants of arbitrary maps (28) satisfy

$$L(\phi; \omega, \alpha * N) = \alpha L(\phi; \omega, N), \quad (37)$$

for any positive constant  $\alpha > 0$ . That (P3) implies (P1) follows by combining the linear relation in (37) with the definition of a representable method in (32).



To show that representability implies excisiveness, we must prove that (11) is true for a general representable clustering method  $\mathcal{H}^\Omega$ . Hence, consider a network  $N = (X, A_X)$ , a resolution  $\delta > 0$  and a subnetwork  $N_i^\delta = (B_i(\delta), A_X|_{B_i(\delta) \times B_i(\delta)})$  as defined in (9), and define the output ultrametrics  $(X, u_X^\Omega) = \mathcal{H}^\Omega(N)$  and  $(X, u_{N_i^\delta}^\Omega) = \mathcal{H}^\Omega(N_i^\delta)$ . Since the identity map from  $N_i^\delta$  to  $N$  is dissimilarity reducing, admissibility of  $\mathcal{H}^\Omega$  implies [cf. Axiom of Transformation (A2)]

$$u_{N_i^\delta}^\Omega(x, x') \geq u_X^\Omega(x, x'), \quad (38)$$

for all  $x, x' \in B_i(\delta)$ . In order to show the reverse inequality, pick arbitrary nodes  $x, x' \in B_i(\delta)$ . From the definition of subnetwork (10), it must be that

$$u_X^\Omega(x, x') \leq \delta, \quad u_X^\Omega(x, x'') > \delta, \quad (39)$$

for all  $x'' \notin B_i(\delta)$ . The leftmost inequality in (39) implies that there exists a minimizing chain  $C(x, x') = [x = x_0, x_1, \dots, x_l = x']$  in definition (32) and a series of maps  $\phi_{x_j, x_{j+1}}$  for all  $j$  determining the optimal multiples  $\lambda_X^\Omega(x_j, x_{j+1}) \leq \delta$ . Notice that the ultrametric value between any two nodes in the images of the maps  $\phi_{x_j, x_{j+1}}$  is smaller than or equal to  $\delta$ . Hence, from (39) we have that the minimizing chain  $C(x, x')$  and the image of every optimal dissimilarity reducing map is contained in  $B_i(\delta)$  so that the same chain can be used to compute  $u_{N_i^\delta}^\Omega(x, x')$ . This implies that

$$u_{N_i^\delta}^\Omega(x, x') \leq u_X^\Omega(x, x'), \quad (40)$$

for all  $x, x' \in B_i(\delta)$ . Combining (38) with (40) we obtain (11), completing this direction of the proof.

To prove the converse statement, consider an arbitrary admissible clustering method  $\mathcal{H}$  which is excisive and linear scale preserving. We will construct a representable method  $\mathcal{H}^\Omega$  such that  $\mathcal{H} \equiv \mathcal{H}^\Omega$ .

Denote by  $(X, u_X) = \mathcal{H}(X, A_X)$  an arbitrary output ultrametric and define the collection of representers  $\Omega$  as follows:

$$\Omega = \left\{ \omega \mid \omega = \frac{1}{\max_{x, x' \in B_i(\delta)} u_X(x, x')} * N_i^\delta, |B_i(\delta)| > 1, \delta > 0 \right\}, \quad (41)$$

for all resolutions  $\delta > 0$  and  $N_i^\delta := (B_i(\delta), A_X|_{B_i(\delta) \times B_i(\delta)})$  being a subnetwork of all possible networks  $N = (X, A_X)$  given the method  $\mathcal{H}$ . In other words, we pick as representers the set of all possible subnetworks generated by the method  $\mathcal{H}$ , each of them scaled by the inverse of the maximum ultrametric obtained in such subnetwork. Notice that from the definition of subnetwork (10) we have that

$$\max_{x, x' \in B_i(\delta)} u_X(x, x') \leq \delta, \quad (42)$$

which appears in the denominator of the definition (41) for every representer  $\omega \in \Omega$ .

We show equivalence of methods  $\mathcal{H}$  and  $\mathcal{H}^\Omega$  by showing that the ultrametric outputs coincide for every network. Pick an arbitrary network  $N = (X, A_X)$  and two different nodes  $x, x' \in X$  and define  $\alpha := u_X(x, x')$ . Since  $\Omega$  was built

considering all possible networks, including  $N$ , there is a representer  $\omega \in \Omega$  that corresponds to the subnetwork  $N_i^\alpha$  at resolution  $\alpha$  that contains  $x$  and  $x'$ . From (42), the inclusion map  $\phi$  from  $\alpha * \omega$  to  $N$  such that  $\phi(x) = x$  is dissimilarity reducing and  $x, x' \in \text{Im}(\phi)$ . From definition (29) this implies that  $\lambda_X^\omega(x, x') \leq \alpha$ . By substituting in (31) and further substitution in (32) we obtain that  $u_X^\omega(x, x') \leq \alpha$ . Recalling that  $\alpha = u_X(x, x')$  and that we chose the network  $N$  and the pair of nodes  $x, x'$  arbitrarily, we may conclude that  $u_X^\Omega \leq u_X$ , for every network  $N = (X, A_X)$ .

In order to show the other direction of the inequality, we must first observe that for every representer the ultrametric value given by  $\mathcal{H}$  between any pair of nodes in the representer is upper bounded by 1. To see this, given a representer  $\omega = (X_\omega, A_{X_\omega})$  associated with the subnetwork  $N_i^\delta$  in (41) we have that

$$\begin{aligned} u_{X_\omega}(\tilde{x}, \tilde{x}') &= \frac{1}{\max_{x, x' \in B_i(\delta)} u_X(x, x')} u_{B_i(\delta)}(\tilde{x}, \tilde{x}') \quad (43) \\ &= \frac{1}{\max_{x, x' \in B_i(\delta)} u_X(x, x')} u_X|_{B_i(\delta) \times B_i(\delta)}(\tilde{x}, \tilde{x}') \leq 1, \end{aligned}$$

for all  $\tilde{x}, \tilde{x}' \in X_\omega$ . The first equality in (43) is implied by the definition of  $\omega$  in (41) and linear scale preservation of  $\mathcal{H}$ . The second equality is derived from excisiveness of  $\mathcal{H}$ .

Pick an arbitrary network  $N = (X, A_X)$  and a pair of nodes  $x, x' \in X$  and define  $\beta := u_X^\Omega(x, x')$ . This means that there exists a minimizing chain  $C(x, x') = [x' = x_0, x_1, \dots, x_l = x']$  such that for every consecutive pair of nodes we can find a dissimilarity reducing map  $\phi_{x_j, x_{j+1}}$  from  $\beta * \omega_j$  to  $N$  for some representer  $\omega_j \in \Omega$  such that  $x_j, x_{j+1} \in \text{Im}(\phi_{x_j, x_{j+1}})$ . Focus on a particular pair of consecutive nodes  $x_j, x_{j+1}$  and denote by  $p_j, p_{j+1}$  two respective pre-images on  $\omega_j = (X_{\omega_j}, A_{X_{\omega_j}})$  under the map  $\phi_{x_j, x_{j+1}}$ . Without loss of generality, we can assume that  $x_j \neq x_{j+1}$  for all  $j$ . The pre-images need not be unique. Denote by  $\beta * \omega_j = (X_{\omega_j}^\beta, \beta A_{X_{\omega_j}})$  the  $\beta$  multiple of the representer  $\omega_j$ . Since  $\phi_{x_j, x_{j+1}}$  is a dissimilarity reducing map from  $\beta * \omega_j$  to  $N$ , the Axiom of Transformation (A2) implies that

$$u_{X_{\omega_j}^\beta}(p_j, p_{j+1}) \geq u_X(x_j, x_{j+1}). \quad (44)$$

Moreover, we can assert that

$$u_{X_{\omega_j}^\beta}(p_j, p_{j+1}) = \beta u_{X_{\omega_j}}(p_j, p_{j+1}) \leq \beta, \quad (45)$$

where the equality is due to linear scale preservation and the inequality is justified by (43). From the combination of (44) and (45) we obtain that  $u_X(x_j, x_{j+1}) \leq \beta$ . Since the previous expression is true for an arbitrary pair of consecutive nodes in  $C(x, x')$ , from the strong triangle inequality we have that

$$u_X(x, x') \leq \max_j u_X(x_j, x_{j+1}) \leq \beta. \quad (46)$$

Recalling that  $\beta = u_X^\Omega(x, x')$  and that the network  $N$  was arbitrary, we can conclude that  $u_X^\Omega \geq u_X$ , for every network  $N = (X, A_X)$ . Combining this with  $u_X^\Omega \leq u_X$ , we conclude that  $u_X^\Omega = u_X$ , completing the proof. ■

The relationship between representability and excisiveness stated in Theorem 2 originates from the fact that both concepts

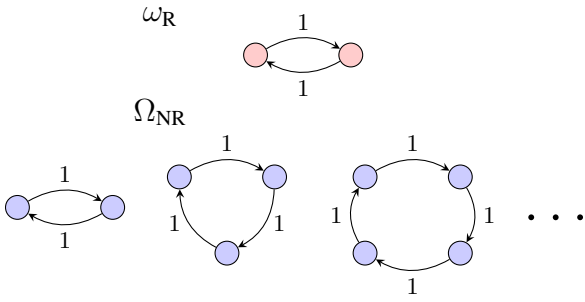

Fig. 6.  $\mathcal{H}^R$  can be represented by one representer network  $\omega_R$  while  $\mathcal{H}^{\text{NR}}$  requires a countably infinite collection  $\Omega_{\text{NR}}$  of representers.

address the locality of clustering methods. Representability implies that the method can be interpreted as an extension of particular cases or representers. Excisiveness requires the clustering of local subnetworks to be consistent with the clustering of the entire network.

The importance of Theorem 2 resides in relating implicit properties of a clustering method such as excisiveness and linear scale preservation with a generative model of clustering methods such as representability. Thus, when designing a clustering method for a particular application, if excisiveness and linear scale preservation are desirable properties then Theorem 2 asserts that representability must be considered as a generative model. Conversely, it is unclear how to establish directly if a given clustering method is representable. However, Theorem 2 provides an indirect way to prove representability via the analysis of excisiveness and linear scale preservation, which are easier to test.

In Section III we presented an admissible method (grafting) that is not linear scale preserving and another one (semi-reciprocal clustering) that is not excisive. Hence, Theorem 2 states that neither of these methods is representable. Conversely, by combining Theorem 2 with Propositions 1 and 2, we can assure that the reciprocal  $\mathcal{H}^R$  and nonreciprocal  $\mathcal{H}^{\text{NR}}$  methods are representable. Indeed, in Fig. 6 we exhibit the collections of representers associated to each of the two methods, i.e.  $\mathcal{H}^R \equiv \mathcal{H}^{\omega_R}$  and  $\mathcal{H}^{\text{NR}} \equiv \mathcal{H}^{\Omega_{\text{NR}}}$ .

To see why the equivalence is true for the case of reciprocal clustering, pick an arbitrary network  $N = (X, A_X)$  and notice that the expansion constant [cf. (28)] of any map  $\phi$  from  $\omega_R$  to  $N$  is equal to

$$L(\phi; \omega_R, N) = \max(A_X(\phi(z), \phi(z')), A_X(\phi(z'), \phi(z))), \quad (47)$$

where  $z$  and  $z'$  denote the two nodes of the representer  $\omega_R$ . Moreover, from the definition of optimal multiple between nodes  $x, x' \in X$ , we know that nodes  $x$  and  $x'$  must be the images of  $z$  and  $z'$  under  $\phi$  which implies that

$$\lambda_X^{\omega_R}(x, x') = \max(A_X(x, x'), A_X(x', x)). \quad (48)$$

By combining (48) and (30) and comparing this with the definition of reciprocal clustering (6), it follows that  $\mathcal{H}^R \equiv \mathcal{H}^{\omega_R}$ .

Similarly, to see why the equivalence  $\mathcal{H}^{\text{NR}} \equiv \mathcal{H}^{\Omega_{\text{NR}}}$  is true, notice that for a pair of arbitrary nodes  $x, x' \in X$ , we may concatenate two minimizing chains  $C(x, x')$  and  $C(x', x)$  that achieve the minimum directed costs  $\tilde{u}_X^*(x, x')$  and  $\tilde{u}_X^*(x', x)$

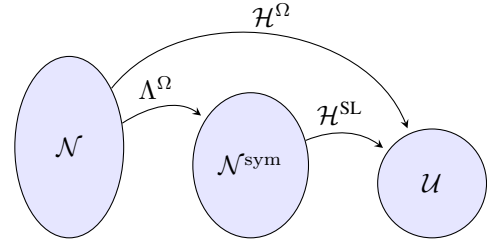

Fig. 7. Decomposition of representable methods. A representable method can be decomposed into a map from the set of asymmetric networks to the set of symmetric networks composed with the single linkage map into the set of ultrametrics.

respectively [cf. (1)] to obtain a loop. The maximum dissimilarity in this loop is equal to  $\max(\tilde{u}_X^*(x, x'), \tilde{u}_X^*(x', x))$  which is exactly  $u_X^{\text{NR}}(x, x')$  [cf. (7)]. Furthermore, if this loop is composed of  $k$  nodes, then we may pick the representer in  $\Omega_{\text{NR}}$  with exactly  $k$  nodes and map it injectively to the loop. Since by construction  $x$  and  $x'$  belong to the image of the map and its expansion constant is equal to the maximum dissimilarity in the loop  $u_X^{\text{NR}}(x, x')$ , we obtain that  $\lambda_X^{\Omega_{\text{NR}}}(x, x') = u_X^{\text{NR}}(x, x')$  from which the result follows.

### B. A factorization property

Every representable clustering method factors into the composition of two maps: a symmetrizing map that depends on  $\Omega$  followed by single linkage hierarchical clustering [9, Ch. 4]. This is formally stated next.

**Proposition 5** *Every representable clustering method  $\mathcal{H}^\Omega$  admits a decomposition of the form  $\mathcal{H}^\Omega \equiv \mathcal{H}^{\text{SL}} \circ \Lambda^\Omega$ , where  $\Lambda^\Omega : \mathcal{N} \rightarrow \mathcal{N}^{\text{sym}}$  is a map from the set of asymmetric networks  $\mathcal{N}$  to that of symmetric networks  $\mathcal{N}^{\text{sym}}$  and  $\mathcal{H}^{\text{SL}} : \mathcal{N}^{\text{sym}} \rightarrow \mathcal{U}$  is the single linkage clustering method for symmetric networks.*

**Proof:** The proof is just a matter of identifying elements in (32). Define the function  $\Lambda^\Omega$  as the one that maps the network  $N = (X, A_X)$  into  $\Lambda^\Omega(X, A_X) = (X, \lambda_X^\Omega)$ , where the dissimilarity function  $\lambda_X^\Omega$  has values given by (31). That  $(X, \lambda_X^\Omega)$  is a symmetric network – i.e., that  $\lambda_X^\Omega$  satisfies symmetry and identity – was shown in the proof of Proposition 4. Comparing the definitions of the output ultrametrics of the representable method  $\mathcal{H}^\Omega$  in (32) and of single linkage method in Section II, we conclude that

$$\mathcal{H}^\Omega(X, A_X) = \mathcal{H}^{\text{SL}}(X, \lambda_X^\Omega) = \mathcal{H}^{\text{SL}}(\Lambda^\Omega(X, A_X)), \quad (49)$$

as wanted. ■

As a particular case of Proposition 5 consider  $\Omega = \{\omega_R\}$  which we have already seen yields the reciprocal clustering method. Inspecting (6), it follows from the definition of single linkage clustering that the method  $\mathcal{H}^R$  can indeed be written as  $\mathcal{H}^{\text{SL}} \circ \Lambda^{\omega_R}$  by defining the map  $\Lambda^{\omega_R}$  to be  $\Lambda^{\omega_R}(X, A_X) = (X, \bar{A}_X)$  [cf. (6)].

Representable clustering methods, as all other hierarchical clustering methods, are maps from the set of asymmetric networks  $\mathcal{N}$  to the set of ultrametrics  $\mathcal{U}$ ; see Fig. 7. Proposition 5 allows the decomposition of these maps into two components

with definite separate roles. The first element of the composition is the function  $\Lambda^\Omega$  whose objective is to symmetrize the original, possibly asymmetric, dissimilarity function. This transformation is followed by an application of single linkage  $\mathcal{H}^{\text{SL}}$  with the goal of inducing an ultrametric structure on this symmetric, but not necessarily ultrametric, intermediate network. Proposition 5 attests that there may be many different ways of inducing a symmetric structure depending on the selection of the representer set  $\Omega$  but that there is a unique method to induce ultrametric structure. This unique method is single linkage hierarchical clustering.

From an algorithmic perspective, Proposition 5 implies that the computation of ultrametrics arising from representable methods requires a symmetrization operation that depends on the representer set  $\Omega$  followed by application of a single linkage algorithm, e.g. [36]. A related decomposition result is derived in [26] for non-hierarchical clustering in metric spaces. Proposition 5 is a significant extension of this result to hierarchical clustering which applies not only to finite metric spaces but to asymmetric networks in general.

## V. STABILITY

As a consequence of characterizing excisive and linear scale preserving methods as those methods which are representable, and as a corollary to the factorization result in Proposition 5, we obtain that most excisive and linear scale preserving methods are *quantitatively stable* in a precise sense. The notion of stability requires the rigorous definition of metric  $d_{\mathcal{N}}$  between networks. This metric is a generalization of the Gromov-Hausdorff distance [38, Chapter 7.3], originally conceived as a metric between compact metric spaces, to the more general set of networks  $\mathcal{N}$ .

Whenever two networks  $N_X$  and  $N_Y$  are related by a simple redefinition of the node labels, we say that they are isomorphic and we write  $N_X \cong N_Y$ . The set of networks where all isomorphic networks are represented by a single point is called the set of networks modulo isomorphism and denoted as  $\mathcal{N} \text{ mod } \cong$ . For node sets  $X$  and  $Y$  consider subsets  $R \subseteq X \times Y$  of the Cartesian product set  $X \times Y$  with elements  $(x, y) \in R$ . The set  $R$  is a *correspondence* between  $X$  and  $Y$  if for all  $x_0 \in X$  we have at least one element  $(x_0, y) \in R$  whose first component is  $x_0$ , and for all  $y_0 \in Y$  we have at least one element  $(x, y_0) \in R$  whose second component is  $y_0$ . The metric  $d_{\mathcal{N}}$  between networks  $N_X$  and  $N_Y$  takes the value

$$d_{\mathcal{N}}(N_X, N_Y) := \frac{1}{2} \min_R \max_{(x,y), (x',y') \in R} |A_X(x, x') - A_Y(y, y')|. \quad (50)$$

Definition (50) is a verbatim generalization of the Gromov-Hausdorff distance in [38, Theorem 7.3.25] except that the dissimilarity functions  $A_X$  and  $A_Y$  are not restricted to be metrics. For this more general case,  $d_{\mathcal{N}}$  is still a legitimate metric in the space  $\mathcal{N} \text{ mod } \cong$  of networks modulo isomorphism as shown in [31].

Before stating our main stability result, we recall the concept of separation of a network that was introduced in the proof of Proposition 4. For any representer network  $\omega = (X_\omega, A_\omega)$ , let  $\text{sep}(\omega) := \min_{(z,z') \in \text{dom}(A_\omega)} A_\omega(z, z')$ . For a family  $\Omega$

of representers we define  $\text{sep}(\Omega) := \inf_{\omega \in \Omega} \text{sep}(\omega)$ . As we proved in Theorem 2, any excisive and linear scale preserving method  $\mathcal{H}$  can actually be represented by a family  $\Omega$ . We say that such a method  $\mathcal{H}$  is *practical* if  $\text{sep}(\Omega) > 0$ . We can then formulate the following theorem.

**Theorem 3** *For any practical, excisive, and linear scale preserving admissible method  $\mathcal{H}$  there exists a finite constant  $L = L(\mathcal{H}) \geq 0$  with the property that for any two networks  $N_X$  and  $N_Y$  in  $\mathcal{N}$ , one has*

$$d_{\mathcal{N}}(\mathcal{H}(N_X), \mathcal{H}(N_Y)) \leq L \cdot d_{\mathcal{N}}(N_X, N_Y). \quad (51)$$

**Proof:** Given  $\mathcal{H}$  as in the theorem's statement, by Theorem 2 there exists a family  $\Omega$  of representers such that  $\mathcal{H} \equiv \mathcal{H}^\Omega$  and by Proposition 5 we then have that  $\mathcal{H} \equiv \mathcal{H}^{\text{SL}} \circ \Lambda^\Omega$ . In [25] it was shown that

$$d_{\mathcal{N}}(\mathcal{H}^{\text{SL}}(N_X), \mathcal{H}^{\text{SL}}(N_Y)) \leq d_{\mathcal{N}}(N_X, N_Y), \quad (52)$$

for any  $N_X$  and  $N_Y$  in  $\mathcal{N}$ . Thus, in order to establish our claim it is enough to prove that there exists a finite constant  $L = L(\Omega) \geq 0$  such that

$$d_{\mathcal{N}}(\Lambda^\Omega(N_X), \Lambda^\Omega(N_Y)) \leq L d_{\mathcal{N}}(N_X, N_Y), \quad (53)$$

for any  $N_X$  and  $N_Y$  in  $\mathcal{N}$ . We claim this to be true for  $L(\Omega) := (\text{sep}(\Omega))^{-1}$ .

In order to verify this, assume that  $\eta = d_{\mathcal{N}}(N_X, N_Y)$  and pick any correspondence  $R$  between  $X$  and  $Y$  such that  $|A_X(x, x') - A_Y(y, y')| \leq 2\eta$  for all  $(x, y)$  and  $(x', y')$  in  $R$  [cf. (50)]. Fix any two pairs  $(x, y)$  and  $(x', y')$  in  $R$ .

For any representer  $\omega \in \Omega$ , let  $\phi : \omega \rightarrow X$  be any map such that  $x, x' \in \text{Im}(\phi)$ . Moreover, consider any function  $\varphi : X \rightarrow Y$  such that  $\varphi(x) = y$  and  $\varphi(x') = y'$  and  $(x'', \varphi(x'')) \in R$  for all  $x'' \in X$ . Notice that the definition of correspondence ensures that at least one such function  $\varphi$  exists. Then, we have

$$\begin{aligned} L(\varphi \circ \phi; \omega, N_Y) &\leq \max_{\substack{(z,z') \in \text{dom}(A_\omega) \\ z \neq z'}} \frac{A_X(\phi(z), \phi(z'))}{A_\omega(z, z')} + 2\eta \text{sep}(\omega)^{-1} \\ &= L(\phi; \omega, N_X) + 2\eta \text{sep}(\omega)^{-1}. \end{aligned} \quad (54)$$

By construction,  $y, y' \in \text{Im}(\varphi \circ \phi)$ . Thus, LHS in (54) is an upper bound for the optimal multiple  $\lambda_Y^\omega(y, y')$  so that

$$\lambda_Y^\omega(y, y') \leq L(\phi; \omega, N_X) + 2\eta \text{sep}(\omega)^{-1}. \quad (55)$$

This inequality is valid for all functions  $\phi : \omega \rightarrow X$  s.t.  $x, x' \in \text{Im}(\phi)$ . Thus, for the particular map  $\phi$  minimizing  $L(\phi; \omega, N_X)$ , (55) becomes  $\lambda_Y^\omega(y, y') \leq \lambda_X^\omega(x, x') + 2\eta \text{sep}(\omega)^{-1}$ . By symmetry, we obtain

$$\left| \lambda_X^\omega(x, x') - \lambda_Y^\omega(y, y') \right| \leq 2\eta \text{sep}(\omega)^{-1}, \quad (56)$$

for all  $(x, y), (x', y') \in R$ . It then follows that

$$\left| \lambda_X^\Omega(x, x') - \lambda_Y^\Omega(y, y') \right| \leq 2\eta \text{sep}(\Omega)^{-1}, \quad (57)$$

as claimed, where the fact that we require  $\text{sep}(\Omega) > 0$  guarantees that (57) is well-defined. ■

This theorem guarantees that structural perturbations of size at most  $\varepsilon$  on a given network – as measured by  $d_{\mathcal{N}}$

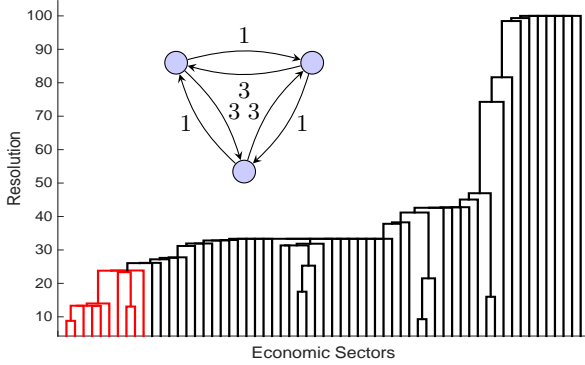

Fig. 8. Dendrogram obtained when clustering the economic network  $N_I$  using the representable clustering method  $\mathcal{H}^\omega$ , for the representer  $\omega$  shown.

– result in perturbations in the clustering results which are bounded by  $L\varepsilon$ . In other words, every excisive and linear scale preserving hierarchical clustering method  $\mathcal{H}$  is *Lipschitz* as a map from  $(\mathcal{N}, d_{\mathcal{N}})$  into itself. This stability property – which we discover thanks to the equivalence result in Section IV-A – further strengthens the interpretation that excisive and linear scale preserving methods exhibit features that make them suitable for practical applications.

## VI. NUMERICAL EXPERIMENTS

The U.S. Department of Commerce publishes a yearly table of input and outputs organized by economic sectors<sup>1</sup>. We focus on a specific section of this table, called *uses*, that corresponds to the inputs to production for year 2011. More precisely, we are given a set  $I$  of 61 industrial sectors as defined by the North American Industry Classification System and a similarity function  $U : I \times I \rightarrow \mathbb{R}_+$  where  $U(i, i')$  represents how much of the production of sector  $i$  (in dollars) is used as an input of sector  $i'$ . Based on this, we define the network  $N_I = (I, A_I)$  where the dissimilarity function  $A_I$  satisfies  $A_I(i, i) = 0$  for all  $i \in I$  and, for  $i \neq i' \in I$ , is given by

$$A_I(i, i') := \left( \frac{U(i, i')}{\sum_k U(k, i')} \right)^{-1}, \quad (58)$$

The normalization in (58) can be interpreted as the proportion of the input to productive sector  $i'$  that comes from sector  $i$ . Consequently, we focus on the relative combination of inputs of a sector rather than the size of the economic sector itself. Moreover, we compute the inverse of this normalized quantity to obtain a measure  $A_I$  that represents dissimilarities. I.e., if most of the productive input of  $i'$  comes from  $i$ , then the normalization would output a number close to 1 and the dissimilarity measure  $A_I(i, i')$  would be small.

We hierarchically cluster the network  $N_I$  of economic sectors using the representable method  $\mathcal{H}^\omega$  associated to the representer  $\omega$  in Fig. 8. From the structure of  $\omega$ , the method  $\mathcal{H}^\omega$  clusters two nodes if they can be joined via cycles of at most three nodes with strong connection in one direction – represented by the dissimilarities equal to 1 – while simultaneously having not too weak connections in the

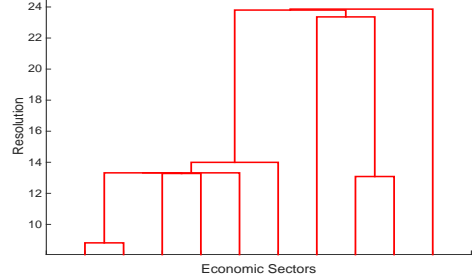

Fig. 9. Illustration of excisiveness. When clustering the subnetwork spanned by the economic sectors corresponding to the red branch in Fig. 8, the output dendrogram matches the branch.

opposite direction – represented by the dissimilarities equal to 3.

In Fig. 8, we present the output dendrogram when the method  $\mathcal{H}^\omega$  is applied to  $N_I$ . Implementation details of this particular clustering method can be found in Section VI-A. Theorem 2 guarantees that if we take a branch of the dendrogram in Fig. 8, e.g. the one highlighted in red, and focus on a subnetwork of the economic network spanned by the corresponding industrial sectors and cluster this subnetwork, we obtain a dendrogram equivalent to the red branch. Indeed, this is the case as can be seen in Fig. 9. Similarly, we can multiply the economic network by a scalar and cluster the resulting multiple network and we are guaranteed to obtain a multiple of the original dendrogram [cf. (P2)].

### A. Implementation of the representable method $\mathcal{H}^\omega$

First notice that for an arbitrary network  $N_X = (X, A_X)$ , the values  $A_X(x, x')$  can be grouped in a matrix which, as it does not lead to confusion, we also denote as  $A_X \in \mathbb{R}^{n \times n}$ . Define the matrix  $B_X$  where each component is computed as

$$[B_X]_{ij} = \min_k \max \left( [A_X]_{ij}, [A_X]_{jk}, [A_X]_{ki}, [A_X]_{ji}/3, [A_X]_{kj}/3, [A_X]_{ik}/3 \right). \quad (59)$$

By comparing (59) with (28), it follows that the element  $i, j$  of matrix  $B_X$  stores the minimum expansion constant of a map  $\phi$  from the representer  $\omega$  to the network  $N_X$  with nodes  $i$  and  $j$  in its image *and* mapping a unit dissimilarity in  $\omega$  to the directed dissimilarity from  $i$  to  $j$ . Optimizing the computation of  $B_X$  is out of the scope of the present paper.

From the previous interpretation of  $B_X$  it follows immediately that the symmetric matrix

$$\Lambda_X = \min(B_X, B_X^T), \quad (60)$$

contains as elements the optimal multiples, i.e.  $[\Lambda_X]_{i,j} = \lambda_X^\omega(i, j)$ . To see this, notice that the optimal map from  $\omega$  to  $N_X$  attaining the minimum expansion constant in (29) must contain nodes  $i$  and  $j$  in its image and must map a unit dissimilarity in  $\omega$  either to the directed dissimilarity from  $i$  to  $j$  or from  $j$  to  $i$ , thus  $\lambda_X^\omega(i, j) = \min([B_X]_{ij}, [B_X]_{ji})$ .

Finally, we compute the output ultrametric as in (30), which is equivalent to applying single linkage clustering [9] to the symmetric network  $(X, \Lambda_X)$ , thus any known single linkage algorithm [36] can be used for this last step.

<sup>1</sup>Available at [http://www.bea.gov/industry/io\\_annual.htm](http://www.bea.gov/industry/io_annual.htm)

## VII. CONCLUSION

We assessed the practicality of hierarchical clustering methods for networks via the fulfillment of two properties: excisiveness and linear scale preservation. The latter ensures that the clustering output is not modified by a change of units in the network. The former guarantees local consistency in the sense that the clustering output of a subnetwork does not depend on the information beyond the subnetwork. As a generative model for hierarchical clustering methods we introduced the concept of representability. The behavior of representable methods is determined by specifying their output on a set of networks called representers. Moreover, the set of representable methods was shown to coincide with the set of practical clustering methods as determined by excisiveness and linear scale preservation. Moreover, we showed that every representable method can be decomposed into two phases: a symmetrizing map  $\Lambda^\Omega$  followed by single linkage clustering. This decomposition result enables the decoupled implementation of hierarchical clustering methods of practical relevance. We also showed that the imposed requirements on practical methods entail stability defined in terms of a metric in the space of networks.

As future work, we intend to understand how the complexity of computing  $\Lambda^\Omega$  depends on the structure of the collection of associated representers  $\Omega$ . Moreover, we plan to expand the list of desirable practical properties in order to get a more stringent characterization of the methods that are relevant in practice. We can consider, e.g., the notion of scale preservation for general dissimilarity transformations *not* restricted to linear transformations as done in this paper. Our final aim is to identify conditions that need to be imposed on the representers so that the associated representable method complies with the stricter notion of practicality.

## REFERENCES

- [1] D. Walsh and L. Rybicki. Symptom clustering in advanced cancer. *Supp. Care in Cancer*, 14(8):831–836, 2006.
- [2] G. Punj and D. W. Stewart. Cluster analysis in marketing research: Review and suggestions for application. *J. Marketing Res.*, 20(2):134–148, 1983.
- [3] J. Shi and J. Malik. Normalized cuts and image segmentation. *IEEE Trans. Pattern Anal. Mach. Intell.*, 22(8):888–905, 2000.
- [4] M. Newman and M. Girvan. Community structure in social and biological networks. *Proc. Natl. Acad. Sci.*, 99(12):7821–7826, 2002.
- [5] M. Newman and M. Girvan. Finding and evaluating community structure in networks. *Phys. Rev. E*, 69, 026113, 2004.
- [6] U. Von Luxburg. A tutorial on spectral clustering. *Stat. Comp.*, 17(4):395–416, 12 2007.
- [7] A. Ng, M. Jordan, and Y. Weiss. On spectral clustering: Analysis and an algorithm. In *Neural Info. Process. Syst. (NIPS)*, pages 849–856, 2002.
- [8] G. N. Lance and W. T. Williams. A general theory of classificatory sorting strategies 1: Hierarchical systems. *Computer J*, 9(4):373–380, 1967.
- [9] A. K. Jain and R. C. Dubes. *Algorithms for Clustering Data*. Prentice Hall Advanced Reference Series. Prentice Hall Inc., 1988.
- [10] T. Saito and H. Yadohisa. *Data Analysis of Asymmetric Structures: Advanced Approaches in Computational Statistics*. CRC Press, 2004.
- [11] L. Hubert. Min and max hierarchical clustering using asymmetric similarity measures. *Psychometrika*, 38(1):63–72, 1973.
- [12] P. B. Slater. Hierarchical internal migration regions of France. *IEEE Trans. Syst. Man Cybern.*, 4:321–324, 1976.
- [13] J. P. Boyd. Asymmetric clusters of internal migration regions of France. *IEEE Trans. Syst. Man Cybern.*, 2:101–104, 1980.
- [14] R. E. Tarjan. An improved algorithm for hierarchical clustering using strong components. *Inf. Process. Lett.*, 17(1):37–41, 1983.
- [15] P. B. Slater. A partial hierarchical regionalization of 3140 US counties on the basis of 1965-1970 intercounty migration. *Env. Plan. A*, 16(4):545–550, 1984.
- [16] F. Murtagh. *Multidimensional Clustering Algorithms*. Compstat Lectures, Vienna: Physica Verlag, 1985.
- [17] W. Pentney and M. Meila. Spectral clustering of biological sequence data. In *Natl. Conf. Artificial Intel.*, pages 845–850, 2005.
- [18] M. Meila and W. Pentney. Clustering by weighted cuts in directed graphs. *SIAM Intl. Conf. Data Mining*, pages 135–144, 2007.
- [19] Y. Zhao and G. Karypis. Hierarchical clustering algorithms for document datasets. *Data Min. Knowl. Discov.*, 10:141–168, 2005.
- [20] U. Von Luxburg and S. Ben-David. Towards a statistical theory of clustering. In *PASCAL wksp. on Statistics and Optimization of Clustering*, 2005.
- [21] S. Ben-David, U. Von Luxburg, and D. Pál. A sober look at clustering stability. In *Conf. Learning Theory (COLT)*, pages 5–19, 2006.
- [22] I. Guyon, U. Von Luxburg, and R. C. Williamson. Clustering: Science or art. In *NIPS Wksp. on Clustering Theory*, 2009.
- [23] M. Ackerman and S. Ben-David. Measures of clustering quality: A working set of axioms for clustering. In *Neural Info. Process. Syst. (NIPS)*, pages 121–128, 2008.
- [24] R. B. Zadeh and S. Ben-David. A uniqueness theorem for clustering. In *Conf. Uncert. Artif. Intell. (UAI)*, pages 639–646, 2009.
- [25] G. Carlsson and F. Mémoli. Characterization, stability and convergence of hierarchical clustering methods. *J. Mach. Learn. Res.*, 11:1425–1470, 2010.
- [26] G. Carlsson and F. Mémoli. Classifying clustering schemes. *Found. Comp. Math.*, 13(2):221–252, 2013.
- [27] J. M. Kleinberg. An impossibility theorem for clustering. In *Neural Info. Process. Syst. (NIPS)*, pages 446–453, 2002.
- [28] T. Van Laarhoven and E. Marchiori. Axioms for graph clustering quality functions. *J. Mach. Learn. Res.*, 15(1):193–215, January 2014.
- [29] M. Meila. Comparing clusterings: an axiomatic view. In *Intl. Conf. Mach. Learn. (ICML)*, pages 577–584. ACM, 2005.
- [30] G. Carlsson, F. Mémoli, A. Ribeiro, and S. Segarra. Axiomatic construction of hierarchical clustering in asymmetric networks. In *IEEE Intl. Conf. Acoust., Speech and Signal Process. (ICASSP)*, pages 5219–5223, 2013.
- [31] G. Carlsson, F. Mémoli, A. Ribeiro, and S. Segarra. Axiomatic construction of hierarchical clustering in asymmetric networks. *arXiv:1301.7724v2*, 2014.
- [32] G. Carlsson, F. Mémoli, A. Ribeiro, and S. Segarra. Alternative axiomatic constructions for hierarchical clustering of asymmetric networks. In *IEEE Global Conf. Signal and Info. Process. (GlobalSIP)*, pages 791–794, Dec 2013.
- [33] G. Carlsson, F. Mémoli, A. Ribeiro, and S. Segarra. Hierarchical quasi-clustering methods for asymmetric networks. In *Intl. Conf. Mach. Learn. (ICML)*, pages 352–360, 2014.
- [34] N. Jardine and R. Sibson. *Mathematical Taxonomy*. John Wiley & Sons Ltd., London, 1971.
- [35] G. Carlsson, F. Mémoli, A. Ribeiro, and S. Segarra. Hierarchical clustering methods and algorithms for asymmetric networks. In *Asilomar Conf. Signals, Syst. and Comp.*, pages 1773–1777, Nov 2013.
- [36] H. Gabow, Z. Galil, T. Spencer, and R. Tarjan. Efficient algorithms for finding minimum spanning trees in undirected and directed graphs. *Combinatorica*, 6(2):109–122, 1986.
- [37] J. Hopcroft and R. Tarjan. Algorithm 447: Efficient algorithms for graph manipulation. *Commun. ACM*, 16(6):372–378, June 1973.
- [38] D. Burago, Y. Burago, and S. Ivanov. *A Course in Metric Geometry*. American Mathematical Society, 2001.