

THE ROTATING NORMAL FORM IS REGULAR

JEAN FROMENTIN

ABSTRACT. Defined on Birman–Ko–Lee monoids, the rotating normal form has strong connections with the Dehornoy’s braid ordering. It can be seen as a process for selecting between all the representative words of a Birman–Ko–Lee braid a particular one, called *rotating* word. In this paper we construct, for all $n \geq 2$, a finite state automaton which recognizes the rotating words on n strands. As a consequence the language of rotating words on n strands is proved to be regular for any $n \geq 2$.

1. INTRODUCTION

Originally, the group B_n of n -strand braids was defined as the group of isotopy classes of n -strand geometric braids. An algebraic presentation of B_n was given by E. Artin in [1]

$$\left\langle \sigma_1, \dots, \sigma_{n-1} \mid \begin{array}{ll} \sigma_i \sigma_j = \sigma_j \sigma_i & \text{for } |i - j| \geq 2 \\ \sigma_i \sigma_j \sigma_i = \sigma_j \sigma_i \sigma_j & \text{for } |i - j| = 1 \end{array} \right\rangle. \quad (1)$$

An n -strand braid is an equivalence class consisting of (infinitely many) words in the letters $\sigma_i^{\pm 1}$. The standard correspondence between elements of the presented group B_n and geometric braids consists in using σ_i as a code for the geometric braid where only the i th and the $(i + 1)$ st strands cross, with the strands originally at position $(i + 1)$ in front of the other.

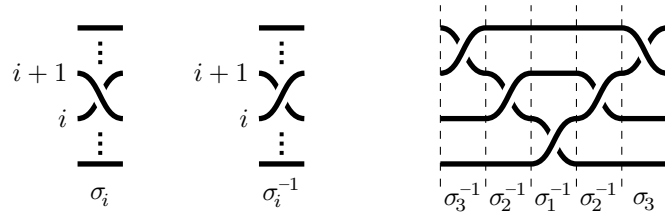

FIGURE 1. Interpretation of a word in the letters $\sigma_i^{\pm 1}$ as a geometric braid diagram.

2010 *Mathematics Subject Classification.* 20F36, 20M35, 20F10.

Key words and phrases. dual braid monoid, rotating normal form, regular language, automata.

In 1998, J.S. Birman, K.H. Ko, and S.J. Lee [3] introduced and investigated for each n a submonoid B_n^{+*} of B_n , which is known as the *Birman–Ko–Lee monoid*. The name “*dual braid monoid*” was subsequently proposed because several numerical parameters obtain symmetric values when they are evaluated on the positive braid monoid B_n^+ and on B_n^{+*} , a correspondence that was extended to the more general context of Artin–Tits groups by D. Bessis [2] in 2003. The dual braid monoid B_n^{+*} is the submonoid of B_n generated by the braids $a_{i,j}$ with $1 \leq i < j \leq n$, where $a_{i,j}$ is defined by $a_{i,j} = \sigma_i \dots \sigma_{j-1} \sigma_j \sigma_{j-1}^{-1} \dots \sigma_i^{-1}$. In geometrical terms, the braid $a_{i,j}$ corresponds to a crossing of the i th and j th strands, both passing behind the (possible) intermediate strands.

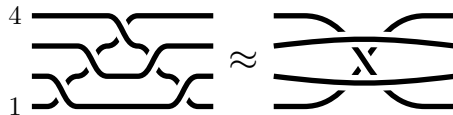

FIGURE 2. In the geometric braid $a_{1,4}$, the strands 1 and 4 cross under the strands 2 and 3.

By definition, σ_i equals $a_{i,i+1}$ and, therefore, the positive braid monoid B_n^+ is included in the monoid B_n^{+*} , a proper inclusion for $n \geq 3$ since the braid $a_{1,3}$ does not belong to the monoid B_3^+ .

We denote by A_n the set $\{a_{p,q} \mid 1 \leq p < q \leq n\}$. The following presentation of the monoid B_n^{+*} is given in [3].

Proposition 1.1. *The monoid B_n^{+*} is presented by generators A_n and relations*

$$a_{p,q}a_{r,s} = a_{r,s}a_{p,q} \quad \text{for } [p,q] \text{ and } [r,s] \text{ disjoint or nested,} \quad (2)$$

$$a_{p,q}a_{q,r} = a_{q,r}a_{p,r} = a_{p,r}a_{p,q} \quad \text{for } 1 \leq p < q < r \leq n. \quad (3)$$

The integral interval $[p,q]$ is said to be *nested* in $[r,s]$ if the relation $r < p < q < s$ holds.

Since [2] and [3] it is known that the dual braid monoid B_n^{+*} admits a Garside structure whose simple elements are in bijection with the non-crossing partitions of n . In particular, there exists a normal form associated with this Garside structure, the so-called greedy normal form.

The rotating normal form is another normal form on B_n^{+*} , it was introduced in [8, 9]. Roughly speaking, for every braid $\beta \in B_n^{+*}$ the rotating normal form picks up a unique representative word on the letters A_n among all of these representing β . It can be seen as a map r_n from the dual braid monoid B_n^{+*} to the set of words A_n^* . The language of all n -rotating words, denoted by R_n is then the image of B_n^{+*} under the map r_n .

The aim of this paper is to construct for all $n \geq 2$ an explicit finite state automaton which recognizes the language R_n . As a consequence we obtain that the language R_n of n -rotating words is regular.

The paper is divided as follow. In section 2 we recall briefly the construction of the rotating normal form and its useful already known properties. In third section we describe the left reversing process on dual braid monoids. In section 4 we give a syntactical characterization of n -rotating normal words. In fifth section we construct, for each $n \geq 2$, a finite state automaton which recognizes the language R_n of n -rotating normal words.

2. THE ROTATING NORMAL FORM

The main ingredient to define the rotating normal form is the Garside automorphism ϕ_n of B_n^{+*} defined by $\phi_n(\beta) = \delta_n \beta \delta_n^{-1}$ where $\delta_n = a_{1,2} a_{2,3} \dots a_{n-1,n}$ is the Garside braid of B_n^{+*} . In terms of Birman–Ko–Lee generators, the map ϕ_n can be defined by

$$\phi_n(a_{p,q}) = \begin{cases} a_{p+1,q+1} & \text{for } q \leq n-1, \\ a_{1,p+1} & \text{for } q = n. \end{cases} \quad (4)$$

Geometrically, ϕ_n should be viewed as a rotation, which makes sense provided braid diagrams are drawn on a cylinder rather than on a plane rectangle.

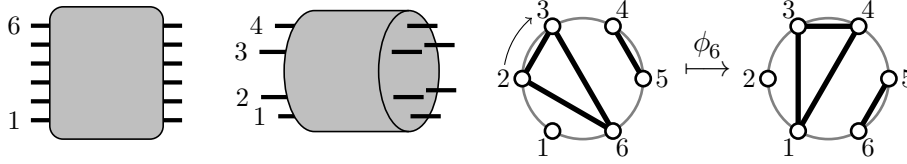

FIGURE 3. Rolling up the usual braid diagram helps us to visualize the symmetries of the braids $a_{p,q}$. On the resulting cylinder, $a_{p,q}$ naturally corresponds to the chord connecting vertices p and q . With this representation, ϕ_n acts as a clockwise rotation of the marked circles by $2\pi/n$.

For β and γ in B_n^{+*} , we say that γ is a *right-divisor* of β , if there exists a dual braid β' of B_n^{+*} satisfying $\beta = \beta' \gamma$.

Definition 2.1. For $n \geq 3$ and β a braid of B_n^{+*} , the maximal braid β_1 lying in B_{n-1}^{+*} that right divides the braid β is called the B_{n-1}^{+*} -tail of β .

Using basic Garside properties of the monoid B_n^{+*} we obtain the following result (Proposition 2.5 of [9]) which allow us to express each braid of B_n^{+*} as a unique finite sequence of braids lying in B_{n-1}^{+*} .

Proposition 2.2. Assume $n \geq 3$. For each nontrivial braid β of B_n^{+*} there exists a unique sequence $(\beta_b, \dots, \beta_1)$ of braids of B_{n-1}^{+*} satisfying $\beta_b \neq 1$ and

$$\beta = \phi_n^{b-1}(\beta_b) \cdot \dots \cdot \phi_n(\beta_2) \cdot \beta_1, \quad (5)$$

for each $k \geq 1$, the B_{n-1}^{+*} -tail of $\phi_n^{b-k}(\beta_b) \cdot \dots \cdot \phi_n(\beta_{k+1})$ is trivial. (6)

Under the above hypotheses, the sequence $(\beta_b, \dots, \beta_1)$ is called the ϕ_n -splitting of the braid β . It is shown in [9] that Condition (6) can be replaced by

$$\text{for each } k \leq 1, \beta_k \text{ is the } B_{n-1}^{+*}\text{-tail of } \phi_n^{b-k}(\beta_b) \cdot \dots \cdot \phi_n(\beta_{k-1}) \cdot \beta_k. \quad (7)$$

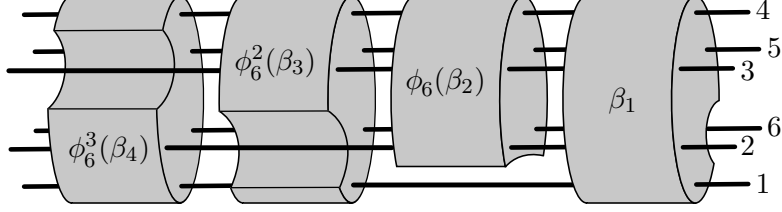

FIGURE 4. The ϕ_6 -splitting of a braid of B_6^{+*} . Starting from the right, we extract the maximal right-divisor that keeps the sixth strand unbraided, then extract the maximal right-divisor that keeps the first strand unbraided, etc.

Example 2.3. Consider the braid $\beta = a_{1,2}a_{2,3}a_{1,2}a_{2,3}$ of B_3^{+*} . Using relations (3) on the underlined factors we obtain

$$\beta = a_{1,2}a_{2,3}\underline{a_{1,2}a_{2,3}} = a_{1,2}\underline{a_{2,3}a_{1,3}}a_{1,2} = a_{1,2}a_{1,3}a_{1,2}a_{1,2}$$

We decompose β as $\phi_3(\gamma_1) \cdot \beta_1$ with $\gamma_1 = \phi_3^{-1}(a_{1,2}a_{1,3}) = a_{1,3}a_{2,3}$ and $\beta_1 = a_{1,2}a_{1,2}$. The braid $\phi_3(\gamma_1) = a_{1,2}a_{2,3}$ is exactly the one of (6) for $n = 3$ and $k = 1$. As the word $a_{1,3}a_{2,3}$ is alone in its equivalence class the braid $\phi_3(\gamma_1)$ is not right divisible by $a_{1,2}$ and so its B_2^{+*} -tail is trivial. Considering γ_1 instead of β we obtain $\gamma_1 = \phi_3(\gamma_2) \cdot \beta_2$ with $\gamma_2 = \phi_3^{-1}(a_{1,3}a_{2,3}) = a_{2,3}a_{1,2}$ and $\beta_2 = 1$. The braid $\phi_3(\gamma_2) = a_{1,3}a_{2,3}$ is the braid of (6) for $n = 3$ and $k = 2$ and it is always alone in its equivalence class, implying that its B_2^{+*} -tail is trivial. We express γ_2 as $\phi_3(\gamma_3) \cdot \beta_3$ with $\gamma_3 = \phi_3^{-1}(a_{2,3}) = a_{1,2}$ and $\beta_3 = a_{1,2}$. Since γ_3 equals $a_{1,2}$ we obtain $\gamma_4 = 1$ and $\beta_4 = a_{1,2}$. We conclude that the ϕ_3 -splitting of β is $(a_{1,2}, a_{1,2}, 1, a_{1,2}^2)$.

Before giving the definition of the rotating normal we fix some definitions about words.

Definition 2.4. A word on the alphabet A_n is an A_n -word. A word on the alphabet $A_n^\pm = A_n \sqcup A_n^{-1}$ is an A_n^\pm -word. The braid represented by the A_n^\pm -word w is denoted by \overline{w} . For w, w' two A_n^\pm -word, we say that w is equivalent to w' , denoted by $w \equiv w'$ if $\overline{w} = \overline{w'}$ holds. The empty word is denoted by ε .

The n -rotating normal form is an injective map r_n from B_n^{+*} to the set of A_n -words defined inductively using the ϕ_n -splitting.

Definition 2.5. For $\beta \in B_2^{+*}$, we define $r_2(\beta)$ to be the unique word $a_{1,2}^k$ representing β . The rotating normal form of a braid $\beta \in B_n^{+*}$ with $n \geq 3$ is

$$r_n(\beta) = \phi_n^{b-1}(r_{n-1}(\beta_b)) \cdot \dots \cdot \phi_n(r_{n-1}(\beta_2)) \cdot r_{n-1}(\beta_1),$$

where $(\beta_b, \dots, \beta_1)$ is the ϕ_n -splitting of β . A word w is said to be *n-rotating* if it is the *n-rotating normal form* of a braid of B_n^{+*} .

As the *n-rotating normal form* of a braid of B_{n-1}^{+*} is equal to its $(n-1)$ -rotating normal form we can talk without ambiguities of the *rotating normal form* about a dual braid.

Example 2.6. We reconsider the braid β of Example 2.3. We know that the ϕ_3 -splitting of β is $(a_{1,2}, a_{1,2}, 1, a_{1,2}^2)$. Since $r_2(1) = \varepsilon$, $r_2(a_{1,2}) = a_{1,2}$ and $r_2(a_{1,2}^2) = a_{1,2}^2$ we obtain

$$r_3(\beta) = \phi_3^3(a_{1,2}) \cdot \phi_3^2(a_{1,2}) \cdot \phi_3(\varepsilon) \cdot a_{1,2}^2 = a_{1,2}a_{1,3}a_{1,2}a_{1,2}.$$

Some properties of the rotating normal form have been established in [9]. Connections, established in [8] and [9], between the rotating normal form and the braid's ordering introduced by P. Dehornoy are based on these properties.

We finish this section with some already known or immediate properties about ϕ_n -splittings and *n-rotating words*.

Definition 2.7. For every nonempty word w , the last letter of w is denoted by $w^\#$. For each nontrivial braid β in B_n^{+*} , we define the *last letter* of β , denoted $\beta^\#$, to be the last letter in the rotating normal form of β .

Lemma 2.8 (Lemma 3.2 of [9]). *Assume $n \geq 3$ and let $(\beta_b, \dots, \beta_1)$ be a ϕ_n -splitting*

- (i) *For $k \geq 2$, the letter $\beta_k^\#$ is of type $a_{\dots, n-1}$ unless $\beta_k = 1$.*
- (ii) *For $k \geq 3$ and $k = b$, we have $\beta_k \neq 1$.*

The fact that β_b is not trivial is a direct consequence of the definition of ϕ_n -splitting. As, for $k \geq 2$, the braid $\beta' = \phi_n(\beta_{k+1}^\#)\beta_k$ is a right-divisor of $\phi_n^{b-k}(\beta_b) \cdot \dots \cdot \beta_k$, it must satisfy some properties. In particular, if $\beta_{k+1}^\# = a_{p-1, n-1}$ holds then the B_{n-1}^{+*} -tail of $\phi_n(a_{p, n}\beta_k)$ is trivial by (6).

Definition 2.9. We say that a letter $a_{r, s}$ is an *$a_{p, n}$ -barrier* if $1 \leq r < p < s \leq n-1$ holds.

There exist no $a_{p, n}$ -barrier with $n \leq 3$ and the only $a_{p, 4}$ -barrier is $a_{1, 3}$, which is an $a_{2, 4}$ -barrier. By definition, if the letter x is an $a_{p, n}$ -barrier, then in the presentation of B_n^{+*} there exists no relation of the form $a_{p, n} \cdot x = y \cdot a_{p, n}$ allowing one to push the letter $a_{p, n}$ to the right through the letter x : so, in some sense, x acts as a barrier.

Lemma 2.10 (Lemma 3.4 of [9]). *Assume that $n \geq 3$, β is a braid of B_{n-1}^{+*} and the B_{n-1}^{+*} -tail of $\phi_n(a_{p, n}\beta)$ is trivial for $2 \leq p \leq n-2$. Then the rotating normal form of β is not the empty word and it contains an $a_{p, n}$ -barrier.*

Lemma 2.11 (Lemma 3.5 of [9]). *Let $(\beta_b, \dots, \beta_1)$ be a ϕ_n -splitting of some braid of B_n^{+*} with $n \geq 3$. Then for each $k \in [2, b-1]$ such that $\beta_{k+1}^\#$ is not $a_{n-2, n-1}$ (if any), the rotating normal form of β_k contains an $\phi_n(\beta_{k+1}^\#)$ -barrier.*

3. LEFT REVERSING FOR DUAL BRAID MONOID

Left reversing process was introduced by P. Dehornoy in [5]. It is a powerful tool for the investigation of division properties in some monoids as stated by Proposition 3.6.

Definition 3.1. A monoid M defined by a presentation $\langle S | R \rangle^+$ is *left complemented* if there exists a map $f : S \times S \rightarrow S^*$ satisfying

$$R = \{f(x, y)x = f(y, x)y \mid (x, y) \in S^2\}$$

and if $f(x, x) = \varepsilon$ holds for all $x \in S$.

As the relation $x = x$ is always true for $x \in S$ we say that M is left complemented even if $x = x$ does not occur in R for $x \in S$.

The monoid B_3^{+*} with presentation of Proposition 1.1 is left complemented with respect to the map f given by

$$\begin{aligned} f(a_{1,2}, a_{2,3}) &= f(a_{1,2}, a_{1,3}) = a_{1,3} \\ f(a_{2,3}, a_{1,2}) &= f(a_{2,3}, a_{1,3}) = a_{1,2} \\ f(a_{1,3}, a_{1,2}) &= f(a_{1,3}, a_{2,3}) = a_{2,3} \end{aligned}$$

However the monoid B_4^{+*} with presentation of Proposition 1.1 is not left complemented. Indeed there is no relation of the form $\dots a_{1,3} = \dots a_{2,4}$. Hence the words $f(a_{1,3}, a_{2,4})$ and $f(a_{2,4}, a_{1,3})$ are not well defined.

In general for $1 \leq p < r < q < s \leq n$, the word $f(a_{p,q}, a_{r,s})$ and $f(a_{r,s}, a_{p,q})$ are not defined for the presentation of B_n^{+*} given in Proposition 1.1. In order to obtain a left complemented presentation of B_n^{+*} we must exhibit some extra relations from these given in Proposition 1.1.

By example, the relation $a_{2,3}a_{1,4}a_{1,3} \equiv a_{3,4}a_{1,2}a_{2,4}$ holds and so we can consider $f(a_{1,3}, a_{2,4})$ to be $a_{2,3}a_{1,4}$. However the relation $a_{1,4}a_{2,3}a_{1,3} \equiv a_{3,4}a_{1,2}a_{2,4}$ is also satisfied and so $f(a_{1,3}, a_{2,4}) = a_{2,3}a_{1,4}$ is an other valid choice.

Lemma 3.2. *For $n \geq 2$, the map $f_n : A_n \times A_n \rightarrow A_n^*$ defined by*

$$f_n(a_{p,q}, a_{r,s}) = \begin{cases} \varepsilon & \text{for } a_{p,q} = a_{r,s}, \\ a_{p,s} & \text{for } q = r, \\ a_{s,q} & \text{for } p = r \text{ and } q > s, \\ a_{r,p} & \text{for } q = s \text{ and } p > r, \\ a_{r,q}a_{p,s} & \text{for } p < r < q < s, \\ a_{s,q}a_{r,p} & \text{for } r < p < s < q, \\ a_{r,s} & \text{otherwise.} \end{cases}$$

provides a structure of left complemented monoid to B_n^{+*} .

Proof. Direct computations using Proposition 1.1 establish $f_n(x, y) \cdot x \equiv f_n(y, x) \cdot y$ for all $(x, y) \in A_n^2$. \square

Our choice for $f_n(a_{p,q}, a_{r,s})$ with $p < r < q < s$ is well suited for the sequel and some proof would be invalid if we made an other one.

Definition 3.3. For w and w' two A_n^\pm -words, we say that w *left reverses in one step* to w' , denoted $w \curvearrowright^1 w'$, if we can obtain w' from w substituting a factor xy^{-1} (with $x, y \in A_n$) by $f_n(x, y)^{-1}f_n(y, x)$. We say that w *left reverses* to w' , denoted by $w \curvearrowright w'$, if there exists a sequence $w = w_1, \dots, w_\ell = w'$ of A_n^\pm -words such that $w_k \curvearrowright^1 w_{k+1}$ for $k \in [1, \ell - 1]$.

Example 3.4. The word $u = a_{1,2}a_{2,3}a_{1,2}a_{1,3}^{-1}$ left reverses to $a_{2,3}a_{2,3}$ as the following left reversing sequence shows (left reversed factor are underlined)

$$a_{1,2}a_{2,3}\underline{a_{1,2}a_{1,3}^{-1}} \curvearrowright^1 a_{1,2}\underline{a_{2,3}a_{1,3}^{-1}}a_{2,3} \curvearrowright^1 \underline{a_{1,2}a_{1,2}^{-1}}a_{2,3}a_{2,3} \curvearrowright^1 a_{2,3}a_{2,3},$$

which is denoted by $a_{1,2}a_{2,3}a_{1,2}a_{1,3}^{-1} \curvearrowright a_{2,3}a_{1,2}$.

Definition 3.5. For w an A_n^\pm -word, we denote by $D(w)$ and $N(w)$ the unique A_n -word, if there exist, such that $w \curvearrowright D(w)^{-1}N(w)$. The word $N(w)$ is the *left numerator* of w while the word $D(w)$ is its *left denominator*.

Reconsidering Example 3.4, we obtain that the left denominator of u is $D(u) = \varepsilon$ and that is left numerator its $N(u) = a_{2,3}a_{2,3}$.

A consequence of Example 8 and Proposition 3.5 of [6] based on [5] and [3] is that $N(w)$ and $D(w)$ exists for any A_n^\pm -word w . We obtain also the following result:

Proposition 3.6. *Let w be an A_n -word and $a_{p,q}$ be in A_n . The braid \bar{w} is right divisible by $a_{p,q}$ if and only if $D(w \cdot a_{p,q}^{-1})$ is empty.*

Since the denominator of $a_{1,2}a_{2,3}a_{1,2}a_{1,3}^{-1}$ is empty, the braid $a_{1,3}$ right divides the braid $a_{1,2}a_{2,3}a_{1,2}$.

4. CHARACTERIZATION OF ROTATING NORMAL WORDS

The aim of this section is to give a syntactical characterization of n -rotating words among A_n -words.

Definition 4.1. We say that a braid β in B_n^{+*} contains an $a_{p,n}$ -barrier if its rotating normal form does.

Lemma 4.2. *Assume that $n \geq 3$, β belongs to B_{n-1}^{+*} and that the B_{n-1}^{+*} -tail of $\phi_n(\beta)$ is trivial. Then every A_{n-1} -word representing β ends with $\beta^\#$.*

Proof. Let u be an A_{n-1} -word representing β . As the B_{n-1}^{+*} -tail of $\phi_n(\beta)$ is trivial, the last letter $u^\#$ of u not belongs to A_{n-2} and so $u^\#$ is $a_{p,n-1}$ for some integer $p < n - 1$. Assume now v is an other A_{n-1} -word representing β . For the same reason as u , we have $v^\# = a_{q,n-1}$ for some $q < n - 1$. Since the two

braids $a_{p,n-1}$ and $a_{q,n-1}$ are right divisors of β , their left lcm is also a right divisor of β . Assume for a contradiction that p and q are different. The braid β is then right divisible by $a_{p,q}a_{q,n-1}$, which is the left lcm of $a_{p,n-1}$ and $a_{q,n-1}$. Since $a_{p,q}a_{q,n-1}$ is equivalent to $a_{p,n-1}a_{p,q}$, the braid $a_{p,q}$ is also a right divisor of β . In particular $a_{p+1,q+1}$, with $q+1 < n$, is a right divisor of $\phi_n(\beta)$, which is impossible since the B_{n-1}^{+*} -tail of $\phi_n(\beta)$ is supposed to be trivial. Therefore, every A_{n-1} -word representing β ends with the same letter, namely $\beta^\#$. \square

We conclude that, under some hypotheses, the last letter of a word is a braid invariant.

Definition 4.3. For $n \geq 3$ and $2 \leq p \leq n-1$, we say that an n -rotating word w is an $a_{p,n}$ -ladder if there exist a decomposition

$$w = v_0 x_1 v_1 \dots v_{h-1} x_h v_h,$$

a sequence $p = j(0) < j(1) < \dots < j(h) = n-1$ and a sequence i such that
 (i) for each $k \leq h$, the letter x_k is $a_{i(k),j(k)}$ with $i(k) < j(k-1) < j(k)$,
 (ii) for each $k < h$, the word v_k contains no $a_{j(k),n}$ -barrier,

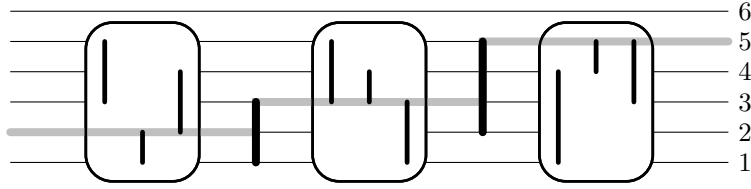

FIGURE 5. An $a_{2,6}$ -ladder. The gray line starts at position 1 and goes up to position 5 using the bar of the ladder. The empty spaces between bars in the ladder are represented by a framed box. In such boxes the vertical line representing the letter $a_{i,j}$ does not cross the gray line. The bar of the ladder are represented by black thick vertical lines.

Condition (ii) is equivalent to: for each $k \leq h$, the letter x_k is an $a_{j(k-1),n}$ -barrier of type $a_{\dots,j(k)}$.

An immediate adaptation of Proposition 3.9 of [9] is :

Lemma 4.4. Assume that $n \geq 3$, β belongs to B_{n-1}^{+*} , the B_{n-1}^{+*} -tail of $\phi_n(\beta)$ is trivial and β contains an $a_{p,n}$ -barrier for some $2 \leq p \leq n-2$. Then the normal form of β is an $a_{p,n}$ -ladder.

In order to obtain a syntactical characterization of n -rotating words we want a local version of condition (6) characterizing a ϕ_n -splitting. The following result is the first one in this way.

Proposition 4.5. For $\beta \in B_{n-1}^{+*}$ and p an integer satisfying $2 \leq p \leq n-2$ there is equivalence between

- (i) the B_{n-1}^{+*} -tail of $\phi_n(a_{p,n}\beta)$ is trivial,
- (ii) the B_{n-1}^{+*} -tail of $\phi_n(\beta)$ is trivial and β contains an $a_{p,n}$ -barrier,
- (iii) the only A_n -letter that right divides $a_{p,n}\beta$ is $\beta^\#$, which is of type $a_{\dots,n-1}$.

Our proof of Proposition 4.5 rests on the following Lemma.

Lemma 4.6. *For $n \geq 3$, u an A_{n-1} -word and $p \in [1, n-1]$, the left denominator $D(ua_{p,n}^{-1})$ is not empty. More precisely, $D(ua_{p,n}^{-1})^{-1}$ begins with $a_{q,n}^{-1}$ satisfying $q \leq p$.*

Proof. Assume that w_1, \dots, w_ℓ is a reversing sequence from the word $w_1 = ua_{p,n}^{-1}$ to the word $D(w_1)^{-1}N(w_1)$. For $k \in [1, \ell]$ we denote by y_k the leftmost negative letter in w_k . Each reversing step consists in replacing a factor xy^{-1} of w_k by $f_n(x, y)^{-1}f_n(y, x)$. If for $k \in [1, \ell]$ the reversed factor of w_k does not contain y_k^{-1} then y_{k+1} equals y_k . Assume now that the reversed factor is xy_k^{-1} with $y_k = a_{r,n}$. Lemma 3.2 implies

$$f_n(x, y_k) = f_n(a_{i,j}, a_{r,n}) = \begin{cases} a_{i,n} & \text{for } j = r, \\ a_{r,j}a_{i,n} & \text{for } i < r < j, \\ a_{r,n} & \text{otherwise,} \end{cases}$$

which gives in particular

$$xy_k^{-1} = a_{i,j}a_{r,n}^{-1} \curvearrowright \begin{cases} a_{i,n}^{-1}\dots & \text{for } i < r \leq j, \\ a_{r,n}^{-1}\dots & \text{otherwise.} \end{cases} \quad (8)$$

It follows that y_{k+1} is equal to $a_{s,n}$ for some $s \leq r$. Eventually we obtain that $ua_{p,n}^{-1}$ left reverses to $a_{q,n}^{-1}\dots$ with the relation $q \leq p$ and so the desired property on $D(ua_{p,n})$ holds. \square

Proof of Proposition 4.5. Assume (i). As the B_{n-1}^{+*} -tail of $\phi_n(\beta)$ is also a right divisor of $\phi_n(a_{p,n}\beta)$ the first statement of (ii) holds. The second statement is Lemma 2.10. Let us prove that (iii) implies (i). By hypothesis the last letter of β is $a_{q-1,n-1}$ for some q . As the only A_n -letter that right divides $\phi_n(a_{p,n}\beta)$ is $\phi_n(a_{q-1,n-1}) = a_{q,n}$, the B_{n-1}^{+*} -tail of $\phi_n(a_{p,n}\beta)$ must be trivial.

We now prove (ii) \Rightarrow (iii). Since the B_{n-1}^{+*} -tail of $\phi_n(\beta)$ is trivial, the letter $\beta^\#$ must be of type $a_{\dots,n-1}$. We denote by w the rotating normal form of β . Let $a_{r,s}$ be an A_n -letter different from $\beta^\#$. We will show that $a_{r,s}$ cannot be a right divisor of $a_{p,n}\beta$. Assume first $s \leq n-1$. By Lemma 4.2, $a_{r,s}$ is not a right divisor of β . Proposition 3.6 implies that the word $D(wa_{r,s}^{-1})$ must be non empty. As the reversing of an A_{n-1}^\pm -word is also an A_{n-1}^\pm -word, there exists a letter $a_{t,t'}$ with $t' < n$ such that

$$a_{p,n} w a_{r,s}^{-1} \curvearrowright a_{p,n} a_{t,t'}^{-1} \dots,$$

holds. Clearly, the braid $a_{t,t'}$ is not a right divisor of $a_{p,n}$ (since we have $t' < n$). Therefore, by Proposition 3.6, the left denominator of $a_{p,n} w a_{r,s}^{-1}$ is not empty, and we conclude that $a_{r,s}$ is not a right divisor of $a_{p,n}\beta$.

Assume now $s = n$. Hypotheses on β plus Lemma 4.4 imply that w is an $a_{p,n}$ -ladder. Following Definition 4.3, we write

$$w = v_0 x_1 v_1 \dots v_{h-1} x_h v_h.$$

By Lemma 4.6, there exist two maps η and μ from \mathbb{N} to itself such that

$$w a_{r,n}^{-1} = w_h a_{\eta(h),n}^{-1} \curvearrowright w'_h a_{\mu(h),n}^{-1} \cdots \curvearrowright \dots \curvearrowright w_0 a_{\eta(0),n}^{-1} \cdots \curvearrowright w'_0 a_{\mu(0),n}^{-1},$$

where for all $k \in [0, h]$,

$$w_k = v_0 x_1 v_1 \dots v_{k-1} x_k v_k,$$

$$w'_k = v_0 x_1 v_1 \dots v_{k-1} x_k.$$

By construction w_0 is v_0 while w'_0 is the empty word. Lemma 4.6 implies

$$\mu(0) \leq \eta(0) \leq \mu(1) \leq \dots \leq \mu(h) \leq \eta(h) = r. \quad (9)$$

Following Definition 4.3 we write $x_k = a_{i(k),j(k)}$. We will now prove by induction

$$\text{for all } k \in [0, h-1], \mu(k+1) \leq j(k+1) \Rightarrow \eta(k) < j(k) \quad (10)$$

Let $k \in [0, h-1]$ and assume $\mu(k+1) \leq j(k+1)$. Definition 4.3 (i) guarantees the relation $i(k+1) < j(k) < j(k+1)$. For $\mu(k+1) \leq i(k+1)$ we have

$$\eta(k) \leq \mu(k+1) \leq i(k+1) < j(k),$$

and we are done in this case. The remaining case is $\mu(k+1) > i(k+1)$. By relation (8), with $i = i(k+1)$, $j = j(k+1)$ and $r = \eta(k+1)$ we obtain

$$x_{k+1} a_{\mu(k+1),n}^{-1} = a_{i(k+1),j(k+1)} a_{\mu(k+1),n}^{-1} \curvearrowright a_{i(k+1),n}^{-1} v$$

with some A_n^\pm -word v . In particular, we have $\eta(k) = i(k+1) < j(k)$ and (10) is established. For $k = h-1$ the left hand member of (10) is satisfied since $j(h)$ is equal to $n-1$ and $r \leq n-1$ holds by definition of r . Properties (9) and (10) imply $\mu(k) < j(k)$ for all $k \in [0, h-2]$. In particular we have $\mu(0) < j(0) = p$ together with $w a_{r,n}^{-1} \curvearrowright a_{\mu(0),n}^{-1} \cdots$. As $a_{\mu(0),n}$ can not be a right divisor of $a_{p,n}$ it follows that the left denominator of $a_{p,n} w a_{r,n}^{-1}$ is also non empty and so that $a_{r,n}$ is not a right divisor of $a_{p,n} \beta$. \square

As the reader can see, the case $p = n-1$ is excluded from Proposition 4.5. It is the aim of the following result.

Proposition 4.7. *For β a non-trivial braid of B_{n-1}^{+*} there is equivalence between*

- (i) the B_{n-1}^{+*} -tail of $\phi_n(a_{n-1,n}\beta)$ is trivial,
- (ii) the only A_n -letter right dividing $a_{n-1,n}\beta$ is $\beta^\#$ which is of type $a_{\dots,n-1}$.

Proof. (ii) \Rightarrow (i) is similar as (iii) \Rightarrow (i) of Proposition 4.7. We now show that (i) implies (ii). Condition (i) implies in particular that the B_{n-1}^{+*} -tail of $\phi_n(\beta)$ is trivial. It follows that the last letter of β is of type $a_{\dots,n-1}$. Let w be the rotating normal form of β and $a_{r,s}$ be an A_n -letter different from $\beta^\#$. For $s \leq n-1$ we follow proof of Proposition 4.7 to obtain that

$a_{r,s}$ is not a right divisor or the braid $a_{n-1,n}$. Assume now $s = n$. By Lemma 4.6 there exists $q \leq r$ such that $wa_{r,n}^{-1} \curvearrowright a_{q,n}^{-1} \cdots$ holds and so we obtain $a_{n-1,n}wa_{r,n}^{-1} \curvearrowright a_{n-1,n}a_{q,n}^{-1} \cdots$. As, for $q \neq n-1$ the braid $a_{q,n-1}$ is not a right divisor of $a_{n-1,n}$ it is sufficient to show $q \neq n-1$ for concluding that $a_{r,n}$ not right divides $a_{n-1,n}\beta$. For $r \leq n-2$ it is obvious since $q \leq r$ holds. Assume finally $r = n-1$. We denote by $a_{p,n-1}$ the last letter of β . By (8) we have $a_{p,n-1}a_{n-1,n}^{-1} \curvearrowright a_{p,n}^{-1} \cdots$ and then Lemma 4.6 implies $q \leq p < n-1$, as expected. \square

Theorem 4.8. *A finite sequence $(\beta_b, \dots, \beta_1)$ of braids in B_{n-1}^{+*} is the ϕ_n -splitting of a braid of B_n^{+*} if and only if*

- (i) for $k \geq 3$ and $k = b$, the braid β_k is not trivial,
- (ii) for $k \geq 2$, the B_{n-1}^{+*} -tail of $\phi_n(\beta_k)$ is trivial,
- (iii) if, for $k \geq 3$, we have $\beta_k^\# \neq a_{n-2,n-1}$ then β_{k-1} contains an $\phi_n(\beta_k^\#)$ -barrier.

Proof. Let $(\beta_b, \dots, \beta_1)$ be the ϕ_n -splitting of some braid of B_{n-1}^{+*} . Condition (i) is a consequence of Lemma 2.8.(ii). Condition (6) implies that the B_{n-1}^{+*} -tail of

$$\phi_n^{b-k}(\beta_b) \cdots \phi_n(\beta_{k+1})$$

is trivial for $k \geq 1$. In particular the B_{n-1}^{+*} -tail of $\phi_n(\beta_{k+1})$ must be trivial for $k \geq 1$, which implies (ii). Condition (iii) is Lemma 2.11.

Conversely, let us prove that a sequence $(\beta_b, \dots, \beta_1)$ of braids of B_{n-1}^{+*} satisfying (i), (ii) and (iii) is the ϕ_n -splitting of some braid of B_n^{+*} . Condition (i) implies that β_b is not trivial. For $k \geq 2$ we denote by γ_k the braid $\phi_n^{b-k}(\beta_b) \cdots \phi_n(\beta_{k+1}) \cdot \beta_k$. For $k \geq 3$ and $k \geq 2$ whenever $\beta_2 \neq 1$, we first prove

$$\beta_k^\# \text{ is the only } A_n\text{-letter that right divides } \gamma_k. \quad (11)$$

We note that Condition (i) guarantees the existence of $\beta_k^\#$ for $k \geq 3$. For $k = b$, Condition (ii) implies that the B_{n-1}^{+*} -tail of $\phi_n(\beta_b)$ is trivial. Hence, by Lemma 4.2 the only A_{n-1} -letter that right divides β_b is $\beta_b^\#$. Since any right divisors of a braid of B_{n-1}^{+*} lie in B_{n-1}^{+*} , we have established (11) for $k = b$. Assume (11) holds for $k \geq 4$ or $k \geq 3$ whenever $\beta_2 \neq 1$ and let us prove it for $k-1$. By Condition (ii) there exists p such that $\beta_k^\#$ is $a_{p-1,n-1}$. We denote by $ua_{p-1,n-1}$ and v two A_n -words representing γ_k and β_{k-1} respectively. The braid γ_{k-1} is then represented by $\phi_n(u)a_{p,n}v$. Let y be an A_n -letter different from $\beta_{k-1}^\#$. Proposition 4.5 with Condition (iii) and Proposition 4.7 imply that y is not a right divisor of $a_{p,n}\beta_{k-1}$. Therefore, by Proposition 3.6 there exists an A_n -letter x different from $a_{p,n}$ such that $\phi_n(u)a_{p,n}vy^{-1} \curvearrowright \phi_n(u)a_{p,n}x^{-1} \cdots$. The word $\phi_n(u)a_{p,n}$ represents $\phi_n(\gamma_k)$. By induction hypothesis x is not a right divisor of $\phi_n(\gamma_k)$. Then Proposition 3.6 implies that $D(\phi_n(u)a_{p,n}x^{-1})$ is not empty. It follows $D(\phi_n(u)a_{p,n}vy^{-1}) \neq \varepsilon$ and so always by Proposition 3.6, the letter y is not a right divisor of γ_{k-1} . Eventually we have established (11) for $k \geq 3$.

A direct consequence of (11) and Condition (ii) is that the only A_n -letter right dividing $\phi_n(\gamma_k)$ is of type $a_{..,n}$ and so the B_{n-1}^{+*} -tail of the braid γ_k is trivial for $k \geq 3$ and for $k = 2$ whenever $\beta_k \neq 1$. It remains to establish that the B_{n-1}^{+*} tail of $\phi_n(\gamma_2)$ is also trivial whenever β_2 is trivial. Assume $\beta_2 = 1$. Condition (iii) implies $\beta_3^\# = a_{n-2,n-1}$. By (11), $a_{n-2,n-1}$ is the only A_n -letter that right divides the braid γ_3 . Since $\gamma_2 = \phi_n(\gamma_3)$, the letter $\phi_n^2(a_{n-2,n-1}) = a_{1,n}$ is the only letter right dividing $\phi_n(\gamma_2)$. In particular the B_{n-1}^{+*} -tail of $\phi_n(\gamma_2)$ is trivial. \square

Conditions (i), (ii) and (iii) are easy to check if the braids β_1, \dots, β_b are given by their rotating normal forms.

Corollary 4.9. *Let (w_b, \dots, w_1) be a finite sequence of A_{n-1} -words, then the word*

$$\phi_n^{b-1}(w_b) \cdot \dots \cdot \phi_n(w_2) \cdot w_1, \quad (12)$$

is n -rotating if the following conditions are satisfied

- (i) *for $k \geq 1$, the word w_k is $(n-1)$ -rotating,*
- (ii) *for $k \geq 3$, the word w_k ends by $a_{p-1,n-1}$ for some p ,*
- (iii) *the word w_2 is either empty (except for $b = 2$) or ends by $a_{p-1,n-1}$ for some p ,*
- (iv) *if, for $k \geq 3$, the word w_k ends by $a_{p-1,n-1}$ with $p \neq n-1$ then the word w_{k-1} contains an $a_{p,n}$ -barrier.*

Proof. Assume that (w_b, \dots, w_1) satisfies Conditions (i)-(iv) and let us prove that the word w defined at (12) is rotating.

We denote by β_i (resp. β) the braid represented by w_i (resp. w). By Condition (i) and Definition 2.5, the word w is rotating if and only if $(\beta_b, \dots, \beta_1)$ is a ϕ_n -splitting. Conditions (ii) and (iii) imply Condition (i) of Theorem 4.8. Theorem 4.8.(iii) is a consequence of (ii) and (iv). We remark that the B_{n-1}^{+*} -tail of a braid γ is represented by a suffix of the rotating word of γ . If the B_{n-1}^{+*} -tail of $\phi_n(\beta_k)$ is not trivial, then there exists $a_{p,q}$ with $1 \leq p < q < n$ that right divides $\phi_n(\beta_k)$. As β_k lies in B_{n-1}^{+*} , we have $p \neq 1$ and therefore β_k is right divisible by $a_{p-1,q-1}$ with $q-1 \leq n-2$. Assume the B_{n-1}^{+*} -tail of w_k is not trivial for $k \geq 2$. The previous remark implies that w_k must end with a letter $a_{i,j}$ satisfying $j \leq n-2$, which is in contradiction with Conditions (ii) and (iii). \square

It is not true that any decomposition of an n -rotating word as in (12) satisfies Conditions (i) – (iv) of Corollary 12. However we have the following result.

Proposition 4.10. *For every n -rotating word w with $n \geq 3$ there exists a unique sequence (w_b, \dots, w_1) of $(n-1)$ -rotating words such that w decompose as in (12) and Conditions (ii) – (iv) of 4.9 hold.*

Proof. By definition of a rotating normal word and by Lemma 2.8 such a sequence exists. Let us prove now the unicity. Assume w is a n -rotating normal word and that (w_b, \dots, w_1) and (w'_b, \dots, w'_1) are two different sequences of

$(n - 1)$ -rotating normal words satisfying Conditions (ii) and (iii) of Corollary 4.9. Let k be the minimal integer satisfying $w_k \neq w'_k$. Since the sum of the word lengths of the two sequences are the same, we have $k \leq \min\{b, c\}$. Without loss of generality, we may assume that w'_k is a proper suffix of w_k , i.e., $w_k = u \cdot w'_k$. By Conditions (ii) and (iii) of Corollary 4.9, the last letter x of u comes from the last letter of w'_{k+1} or w'_{k+2} . Hence the letter x is equal to $a_{p-1, n-1}$ for some p and w_k admits either $\phi_n(a_{p-1, n-1})w'_k = a_{p, n}w'_k$ or $\phi_n^2(a_{p-1, n-1})w'_k = a_{1, p+1}w'_k$ as suffix. The first case is impossible since w_k is an A_{n-1} -word. The second case may occur only for $k = 1$ and $w'_2 = \varepsilon$. As w'_2 is empty, the last letter of w'_3 , which is x , is equal to $a_{n-2, n-1}$. This implies that w_k admits $a_{1, n}u$ as suffix which is also impossible since it is an A_{n-1} -word. \square

A direct consequence of Corollary 4.9 and Proposition 4.10 is

Theorem 4.11. *An A_n -word w is rotating if and only if it can be expressed as in (12) subject to Conditions (i) – (iv) of Corollary 4.9.*

5. REGULARITY

In this section we will show that the language of n -rotating words, denoted by R_n is regular, i.e., there exists a finite state automaton recognizing the n -rotating words. As the rotating normal form is defined using right division it is more natural for an automaton to read word from the right. For $w = x_0 \dots x_k$ an A_n -word we will denote by $\Pi(w)$ the word $x_k \dots x_0$. By Theorem 1.2.8 of [7] the language R_n is regular if and only if the language $\Pi(R_n)$ is. In this section we will construct an automaton recognizing $\Pi(R_n)$.

For us a *finite state automaton* is a quintuplet $(S \cup \{\otimes\}, A, \mu, Y, i)$ where S is the finite set of *states*, A is a finite *alphabet*, $\mu : S \times A \rightarrow S$ is the *transition function*, $Y \subseteq S$ is *accepting states* and i is the *initial state*. In this paper each automaton is equipped with an undraw dead state \otimes and all states except the dead one is accepting, i.e., $Y = S$ always holds. Therefore an automaton will be briefly denoted by $\mathcal{A} = (S, A, \mu, i)$. To describe \mathcal{A} it is enough to describe μ on $(s, x) \in S \times A$ where $\mu(s, x) \neq \otimes$ and $s \neq \otimes$. By example an automaton recognizing the language R_2 is $\mathcal{A}_2 = (\{1\}, \{a_{1,2}\}, \mu_2, 1)$ with $\mu_2(1, a_{1,2}) = 1$. The corresponding automaton diagram is :

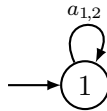

The horizontal arrow points to the initial state.

Proposition 5.1. An A_3 -word $x_b^{e_b} \cdot \dots \cdot a_{1,3}^{e_3} a_{2,3}^{e_2} a_{1,2}^{e_1}$ where

$$x_b = \begin{cases} a_{1,2} & \text{if } b \equiv 1 \pmod{3}, \\ a_{2,3} & \text{if } b \equiv 2 \pmod{3}, \\ a_{1,3} & \text{if } b \equiv 3 \pmod{3}. \end{cases}$$

is rotating if and only if $e_k \neq 0$ for all $k \geq 3$.

Proof. The 2-rotating words are powers of $a_{1,2}$. Let w be the word of the statement. Defining w_k to be $a_{1,2}^{e_k}$, we obtain

$$w = \phi_n^{b-1}(w_b) \cdot \dots \cdot \phi_n(w_2) \cdot w_1.$$

As there is no barrier in B_3^{+*} , the word w is rotating if and only if it satisfies Conditions (ii) and (iii) of Corollary 4.9, i.e., the exponent e_k is not 0 for $k \geq 3$. \square

As a consequence the following automaton recognizes the language $\Pi(R_3)$:

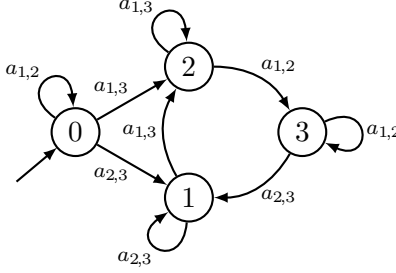

Unfortunately, for $n \geq 4$ there is no so simple characterization of n -rotating words. We will describe an inductive construction for an automaton recognizing language $\Pi(R_n)$. The process will be illustrated on $n = 4$. The first step is to focus on n -rotating words ending with a letter of type $a_{..n}$.

Definition 5.2. We denote by R_n^* the language of n -rotating words which are empty or ends with a letter of type $a_{p,n}$ for some p .

Before constructing an automaton \mathcal{A}_n recognizing the language $\Pi(R_n)$, we construct by induction on $n \geq 3$ an automaton \mathcal{A}_n^* for the language $\Pi(R_n^*)$.

Definition 5.3. A *partial automaton* is a quadruplet $P = (S, A, \mu, I)$ where S , A and μ are defined as for an automaton and $I : A \rightarrow S$ is a map. The closure of a partial automaton P is the automaton $\mathcal{A}(P) = (S \cup \{\circ\}, A, \mu^c, \circ)$ given by

$$\mu^c(s, x) = \begin{cases} I(x) & \text{if } s = \circ, \\ \mu(s, x) & \text{otherwise.} \end{cases}$$

A partial automaton is represented as an automaton excepted for the function I . For each $x \in A$ we draw an arrow attached to state $I(x)$ and

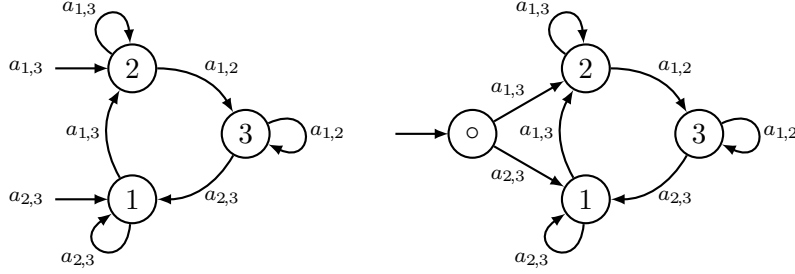

FIGURE 6. The partial automaton P_3 and the corresponding closure which recognizes the language $\Pi(R_3^*)$.

labelled x . We say that a partial automaton recognizes a given language if its closure does.

We will now show how to construct by induction a partial automaton P_n recognizing $\Pi(R_n^*)$ for $n \geq 3$. For $n = 3$ this is already done by Figure 6. For the sequel we assume $n \geq 4$ and that $P_{n-1} = (S_{n-1}, A_{n-1}, \mu_{n-1}, I_{n-1})$ is a given partial automaton which recognizes the language $\Pi(R_{n-1})$.

We define S_n^0 to be the set

$$S_n^0 = \{0\} \times (S_{n-1} \setminus \{\otimes\}) \times \mathcal{P}(\{a_{2,n}, \dots, a_{n-2,n}\}).$$

A state in S_n^0 is then written $(0, s, m)$. For $x = a_{i,j} \in A_{n-1}$ we denote by $\text{bar}(x)$ the set $\{a_{p,n} \mid i < p < j\}$.

Definition 5.4. We define $P_n^0 = (S_n^0 \cup \{\otimes\}, A_{n-1}, \mu_n^0, I_n^0)$ to be the partial automaton where for all $x \in A_{n-1}$,

$$I_n^0(x) = \begin{cases} (0, I_{n-1}(x), \text{bar}(x)) & \text{if } I_{n-1}(x) \neq \otimes, \\ \otimes & \text{if } I_{n-1}(x) = \otimes. \end{cases}$$

and for all $(0, s, m) \in S_n^0$ and for all $x \in A_{n-1}$,

$$\mu_n^0((0, s, m), x) = \begin{cases} (0, \mu_{n-1}(s, x), m \cup \text{bar}(x)) & \text{if } \mu_{n-1}(s, x) \neq \otimes, \\ \otimes & \text{if } \mu_{n-1}(s, x) = \otimes. \end{cases}$$

Proposition 5.5. *The partial automaton P_n^0 recognizes the language $\Pi(R_{n-1}^*)$. Moreover an accepted A_n -word $\Pi(w)$ contains an $a_{p,n}$ -barrier if and only if $P_{n,0}$ has state (s, m) with $a_{p,n} \in m$ after reading $\Pi(w)$.*

Proof. Let w be an A_n -word of length ℓ , \mathcal{A} and \mathcal{A}' be the closure of P_{n-1} and P_n^0 respectively. We denote by s_k (resp. (s'_k, m_k)) the state of automaton \mathcal{A} (resp. \mathcal{A}') after reading the k -th letter of $\Pi(w)$. If w does not contain an $a_{p,n}$ -barrier then (s'_k, m_k) is equal to (s_k, \emptyset) for all $k \in [1, \ell]$. Hence $\Pi(w)$ is accepted or not by the two automata and in particular m_ℓ is the empty set. Assume now w contains an $a_{p,n}$ -barrier. Let ℓ' be the first occurrence on such a barrier in $\Pi(w)$. By construction of μ_n we have (s'_k, m_k) with $a_{p,n} \in m_k$ for $k \geq \ell'$ except if $s_k = \otimes$. As \mathcal{A} (resp. \mathcal{A}') recognizes the word

$\Pi(w)$ if and only if s_ℓ (resp. s'_ℓ) is different from \otimes , the word w is recognized or not by both automata. Moreover, in this case m_ℓ contains $a_{p,n}$. \square

As the only $a_{p,4}$ -barrier in A_4 is $a_{1,3}$, the partial automaton P_4^0 is obtained from P_3 by connecting edges labelled $a_{1,3}$ to a copy of P_3 , as illustrated on figure 5

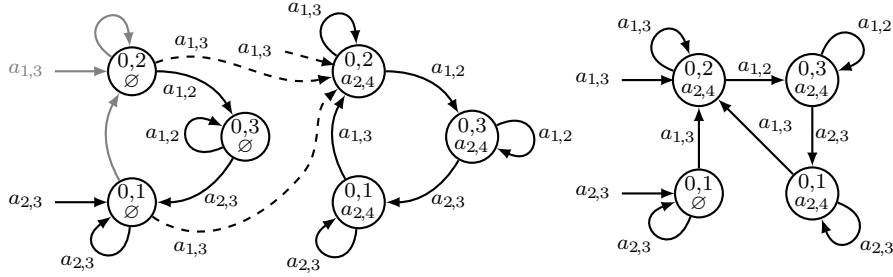

FIGURE 7. The partial automaton P_4^0 . Obsolete transitions from P_3 are in gray. New added transitions are dashed. The right partial automaton is P_4^0 without inaccessible states.

For $t = (0, s, m) \in S_n^0$ we define $\phi_n^k(t)$ to be (k, s, m) . We also define S_n^k to be $\phi_n^k(S_n^0)$ and

$$P_n^k = \left(S_n^k, \phi_n^k(A_{n-1}), \mu_n^k, I_n^k \right)$$

to be the partial automaton given by $I_n^k(\phi_n^k(x)) = \phi_n^k(I_n^0(x))$ and

$$\mu_n^k((k, s, m), \phi_n^k(x)) = \phi_n^k(\mu_n^0((0, s, m), x))$$

with the convention $\phi_n^k(\otimes) = \otimes$. In other words, P_n^k is obtained from P_n^0 by replacing the letter x by $\phi_n^k(x)$ and state $(0, s, m)$ by (k, s, m) . We obtain immediately that P_n^k recognizes the word $\phi_n^k(\Pi(w))$ if and only if P_n^0 recognizes $\Pi(w)$.

We can now construct the partial automaton P_n by plugging together n partial automaton P_n^k for $k \in [0, n-1]$ together.

Definition 5.6. We define $P_n = (S_n^* \cup \{\otimes\}, A_n, \mu_n^*, I_n)$, with $S_n^* = S_n^0 \sqcup \dots \sqcup S_n^{n-1}$ to be the partial automaton given by

$$I_n(x) = \begin{cases} I_n^1(a_{p-1, n-1}) & \text{if } x = a_{p,n} \text{ with } p \neq 1, \\ I_n^2(a_{n-2, n-1}) & \text{if } x = a_{1,n}, \\ \otimes & \text{otherwise.} \end{cases}$$

and with transition function

$$\mu_n^*((k, s, m), \phi_n^k(x)) = \begin{cases} \mu_n^k((k, s, m), \phi_n^k(x)) & \text{if } x \in A_{n-1}, \\ I_n^{k+1}(\phi_n^k(x)) & \text{if } x = a_{n-1,n} \\ I_n^{k+1}(\phi_n^k(x)) & \text{if } x = a_{p,n} \text{ with } 2 \leq p \leq n-2 \\ & \text{and } a_{p,n} \in m, \\ \otimes & \text{otherwise} \end{cases}$$

with the convention $I_n^n = I_n^0$.

We summarize the construction of the partial automaton P_n on the following diagram.

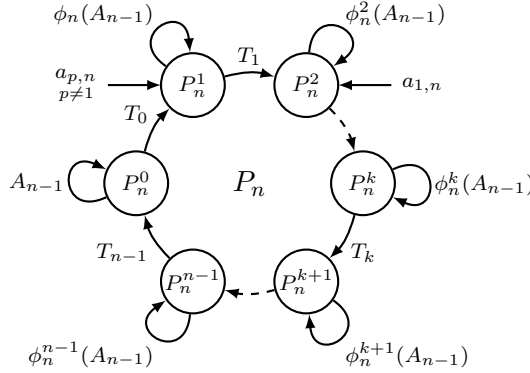

An arrow labelled T_k represents the set of transitions $\mu_n^*((k, s, m), \phi_n^k(a_{p,n}))$.

Lemma 5.7. *The partial automaton P_n recognizes the language $\Pi(R_n^*)$.*

Proof. Let \mathcal{A} be the closure of P_n and w be a non empty A_n -word. There exists a unique sequence (w_b, \dots, w_1) of A_{n-1} -words such that $w_b \neq \varepsilon$, w is equal to

$$\phi_n^{b-1}(w_k) \cdot \dots \cdot \phi_n(w_2) \cdot w_1$$

and for all i , the word $\phi_n^i(w_i)$ is the maximal suffix of $\phi_n^{k-1}(w_k) \cdot \dots \cdot \phi_n^i(w_i)$ belonging to $\phi_n^i(A_{n-1})$. By definition of I_n , the word $\Pi(w)$ is accepted by P_n only if w ends by a letter $a_{p,n}$ for some p . We assume now that w is such a word. Thus the first integer j such that w_j is non empty is 2 or 3. More precisely, we have $j = 2$ if $p > 1$ and $j = 3$ if $p = 1$ holds. In both cases, the reading of $\Pi(w)$ starts by a state coming from P_n^j . The automaton reaches a state different from one of P_n^j if it goes to the state \otimes or if it reads a letter outside of $\phi_n^{j-1}(A_n)$, i.e., a letter of $\phi_n^j(w_{j+1})$. This is a general principle : after reading a letter of $\phi_n^{i-1}(w_i)$ the automaton \mathcal{A} is in state (t, s, m) with $t = i \bmod n$. By construction of P_n^t , the word $\phi_n^{i-1}(w_i)$ provides an accepted state if and only if w_i is a word of $\Pi(R_{n-1})$. At this point we have shown that $\Pi(w)$ is accepted by \mathcal{A} only if w is empty or if w satisfies $w'^{\#} = a_{p,n}$ together with Conditions (i), (ii) and (iii) of Corollary 4.9. Let i be in $[j, k-1]$, and assume that \mathcal{A} is in an acceptable state (t, s, m) with $t = i \bmod n$ after

reading the word $\Pi(\phi_n^{i-1}(w_i) \cdots \phi_n(w_2) \cdot w_1)$. We denote by x the letter $w_{i+1}^\#$. By construction of w_{i+1} we have $x \notin \phi_n^{i-1}(A_{n-1})$ and so $x = \phi_n^i(a_{p,n})$ for some p . By definition of μ_n^* we have $\mu_n^*((t, s, m), \phi_n^i(a_{p,n})) \neq \otimes$ if and only if $p = n - 1$ or $p \in [2, n - 2]$ and $a_{p,n} \in m$. By construction of P_n^t , we have $a_{p,n} \in m$ if and only if w_i contains an $a_{p,n}$, which corresponds to Condition (iv) of Corollary 4.9. Eventually, by Corollary 4.9, the word $\Pi(w)$ is accepted by \mathcal{A} if and only if $w \in R_n^*$. \square

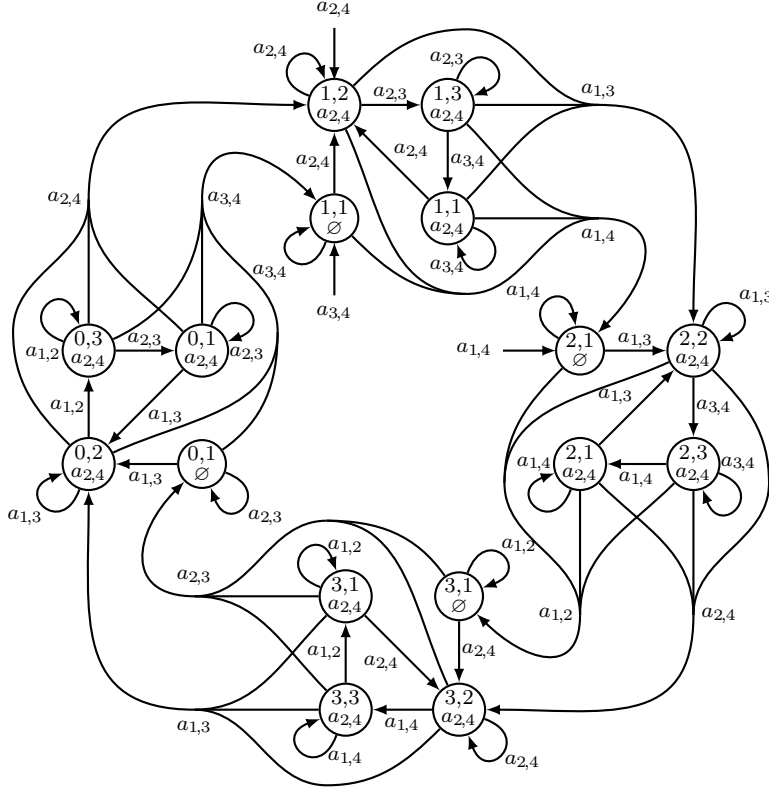

FIGURE 8. Partial automaton recognizing the language $\Pi(R_4^*)$.

Assume that an automaton $\mathcal{A}_{n-1} = (S_{n-1} \cup \{\otimes\}, A_{n-1}, \mu_{n-1}, i)$ recognizing the language $\Pi(R_{n-1})$ for $n \geq 4$ is given. Using the partial automaton $P_n = (S_n^* \cup \{\otimes\}, A_n, \mu_n^*, I_n)$ we construct the automaton $\mathcal{A}_n = (S_n \cup \{\otimes\}, A_n, \mu_n, i)$ defined by $S_n = S_{n-1} \sqcup S_n^*$ and

$$\mu_n(s, x) = \begin{cases} \mu_{n-1}(s, x) & \text{if } s \in S_{n-1} \text{ and } x \in A_{n-1}, \\ I_n(x) & \text{if } s \in S_{n-1} \text{ and } x \in A_n \setminus A_{n-1}, \\ \mu_n^*(s, x) & \text{if } s \in S_n^*. \end{cases}$$

Proposition 5.8. *If \mathcal{A}_{n-1} recognizes $\Pi(R_{n-1})$, the automaton \mathcal{A}_n recognizes the language $\Pi(R_n)$.*

Proof. Let w be an A_n -word, w_1 be the maximal suffix of w which is an A_{n-1} -word and w' be the corresponding prefix. By Corollary 4.9, the word w is rotating if and only if w_1 and w' are. By construction of \mathcal{A}_n , the automaton is in acceptable state after reading $\Pi(w_1)$ if and only if w_1 is an $(n-1)$ -rotating word. Hence w is accepted only if w_1 is rotating. Assume that it is the case. By Lemma 5.7 the automaton \mathcal{A}_n is always in an acceptable state after reading $\Pi(w')$ if and only if the word w' is rotating. Eventually the word $\Pi(w)$ is accepted by \mathcal{A} if and only if w_1 and w' are both rotating, which is equivalent to w is rotating. \square

By Proposition 5.8, the language $\Pi(R_n)$ is regular and so we obtain:

Theorem 5.9. *The language of n -rotating words R_n is regular.*

FURTHER WORK

Using syntactical characterization of rotating words we have proved that the language of n -rotating words is regular. For W a finite state automaton, we denote by $L(W)$ the language recognized by W . Following [4] and [7] we have the following definition:

Definition 5.10. Let M be a monoid. A *right automatic structure*, resp. *left automatic structure*, on M consists of a set A of generators of M , a finite state automaton W over A , and finite state automata M_x over (A, A) , for $x \in A \cup \{\varepsilon\}$, satisfying the following conditions:

- (i) the map $\pi : L(W) \rightarrow M$ is surjective.
- (ii) for $x \in A \cup \{\varepsilon\}$, we have $(u, v) \in L(M_x)$ if and only if $\overline{ux} = \overline{y}$, resp. $\overline{xu} = \overline{y}$, and both u and v are elements of $L(W)$.

Naturally we can ask if the rotating normal form provides an left or right automatic structure for the dual braid monoid B_n^{+*} . Such a result may needs to obtain some syntactical properties on the word xw or wx where w is an n -rotating word and x is an A_n -generator. At this time no result have been obtained in this direction.

REFERENCES

- [1] E. Artin, *Theorie der Zöpfe*, Abh. Math. Sem. Univ. Hanburg **4** (1925), 47–72.
- [2] D. Bessis, *The dual braid monoid*, Ann. Sci. École Norm. Sup. (4) **36** (2003), no. 5, 647–683.
- [3] J. S. Birman, K. H. Ko, and S. J. Lee, *A new approach to the word and conjugacy problems in the braid groups*, Adv. Math. **139** (1998), no. 2, 322–353.
- [4] C. M. Campbell, E. F. Robertson, N. Ruškuc, and R. M. Thomas, *Automatic semi-groups*, Theoretical Computer Science **250** (2001), no. 1-2, 365–391.
- [5] P. Dehornoy, *Groups with a complemented presentation*, J. Pure Appl. Algebra **116** (1997), 115–137, Special volume on the occasion of the 60th birthday of Professor Peter J. Freyd.
- [6] P. Dehornoy and L. Paris, *Gaussian groups and Garside groups, two generalisations of Artin groups*, Proc. London Math. Soc. (3) **79** (1999), no. 3, 569–604.

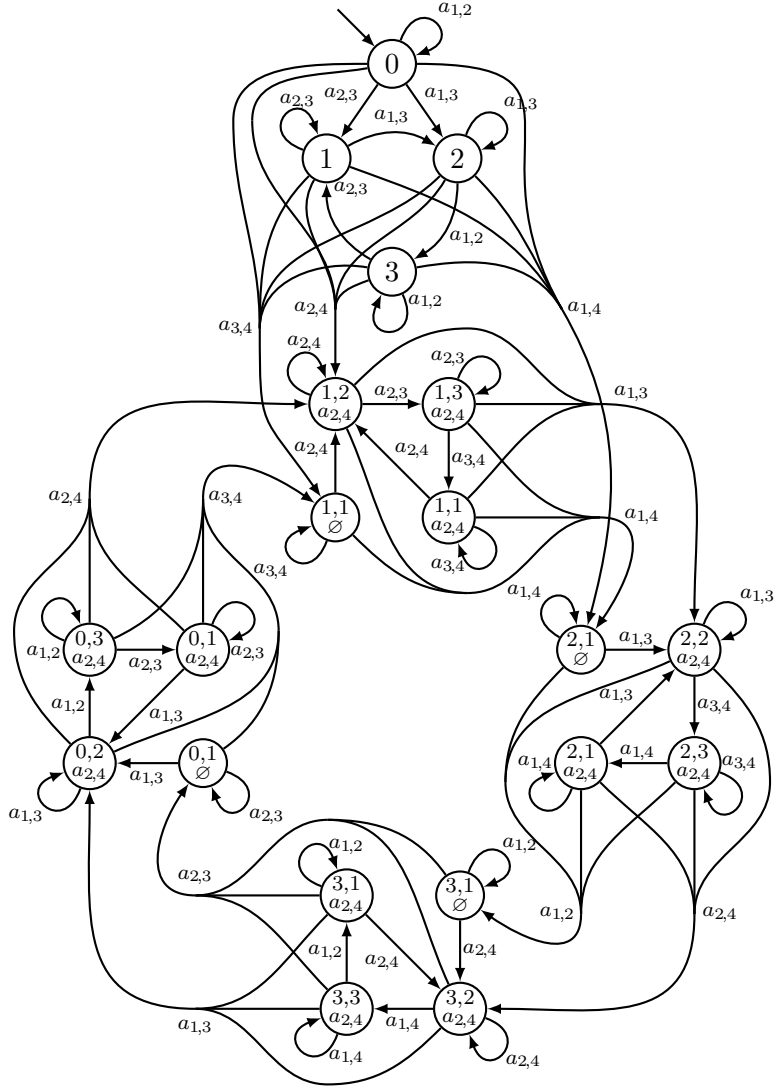
FIGURE 9. Automaton \mathcal{A}_4 for the language $\Pi(R_4)$.

- [7] D. B. A. Epstein, J. W. Cannon, D. F. Holt, S. V. F. Levy, M. S. Paterson, and W. P. Thurston, *Word processing in groups*, Jones and Bartlett Publishers, Boston, MA, 1992.
- [8] J. Fromentin, *A well-ordering of dual braid monoids*, C. R. Math. Acad. Sci. Paris **346** (2008), 729–734.
- [9] ———, *Every braid admits a short sigma-definite expression*, Journal of the European Mathematical Society (JEMS) **13** (2011), no. 6, 1591–1631.