

The
Projective Parabolic Geometry
of
Riemannian, Kähler *and*
Quaternion-Kähler Metrics

submitted by

George Edward Frost

for the degree of Doctor of Philosophy

of the

University of Bath

Department of Mathematical Sciences

January 2016

COPYRIGHT

Attention is drawn to the fact that copyright of this thesis rests with its author. This copy of the thesis has been supplied on the condition that anyone who consults it is understood to recognise that its copyright rests with its author and that no quotation from the thesis and no information derived from it may be published without the prior written consent of the author.

This thesis may be made available for consultation within the University Library and may be photocopied or lent to other libraries for the purposes of consultation.

Signature of Author

George Edward Frost

Summary

We present a uniform framework generalising and extending the classical theories of projective differential geometry, c-projective geometry, and almost quaternionic geometry. Such geometries, which we call *projective parabolic geometries*, are abelian parabolic geometries whose flat model is an R-space $G \cdot \mathfrak{p}$ in the infinitesimal isotropy representation \mathbb{W} of a larger self-dual symmetric R-space $H \cdot \mathfrak{q}$. We also give a classification of projective parabolic geometries with $H \cdot \mathfrak{q}$ irreducible which, in addition to the aforementioned classical geometries, includes a geometry modelled on the Cayley plane $\mathbb{O}\mathbb{P}^2$ and conformal geometries of various signatures.

The larger R-space $H \cdot \mathfrak{q}$ severely restricts the Lie-algebraic structure of a projective parabolic geometry. In particular, by exploiting a Jordan algebra structure on \mathbb{W} , we obtain a \mathbb{Z}^2 -grading on the Lie algebra of H in which we have tight control over Lie brackets between various summands. This allows us to generalise known results from the classical theories. For example, which riemannian metrics are compatible with the underlying geometry is controlled by the first BGG operator associated to \mathbb{W} .

In the final chapter, we describe projective parabolic geometries admitting a 2-dimensional family of compatible metrics. This is the usual setting for the classical projective structures; we find that many results which hold in these settings carry over with little to no changes in the general case.

Contents

| | | |
|----------|---|-----------|
| 1 | Introduction | 6 |
| 2 | Background from Lie theory | 13 |
| 2.1 | Parabolic subalgebras | 13 |
| 2.1.1 | Standard parabolics | 14 |
| 2.1.2 | Filtrations and gradings | 15 |
| 2.1.3 | Representations of a parabolic | 17 |
| 2.1.4 | R-spaces and projective embeddings | 20 |
| 2.2 | Lie algebra homology and cohomology | 22 |
| 2.2.1 | Basic definitions | 23 |
| 2.2.2 | Computation of homology components | 24 |
| 3 | Background from parabolic geometry | 28 |
| 3.1 | Cartan geometries and parabolic geometries | 28 |
| 3.1.1 | Cartan geometries | 28 |
| 3.1.2 | Parabolic geometries | 31 |
| 3.2 | Tractor calculus and the equivalence of categories | 32 |
| 3.2.1 | Tractor bundles and tractor connections | 32 |
| 3.2.2 | Weyl structures | 34 |
| 3.2.3 | The equivalence of categories | 36 |
| 3.3 | BGG operators and curvature decomposition | 38 |
| 3.3.1 | The curved BGG sequence | 38 |
| 3.3.2 | Curvature decomposition | 41 |
| 3.3.3 | Prolongation of BGG operators | 43 |
| 4 | Projective differential geometry | 46 |
| 4.1 | Classical definition and results | 46 |
| 4.2 | Description as a parabolic geometry | 49 |
| 4.2.1 | The flat model $\mathbb{R}\mathbb{P}^n$ | 50 |
| 4.2.2 | Recovering the Cartan connection | 51 |
| 4.2.3 | Representations of $\mathfrak{sl}(n+1, \mathbb{R})$ | 53 |

| | | |
|----------|---|------------|
| 4.2.4 | Harmonic curvature | 55 |
| 4.3 | Metrisability of projective structures | 57 |
| 5 | C-projective geometry | 62 |
| 5.1 | Background on almost complex geometry | 62 |
| 5.2 | Classical definition and results | 65 |
| 5.2.1 | Classical approach | 65 |
| 5.2.2 | Hamiltonian 2-forms | 67 |
| 5.3 | Description as a parabolic geometry | 68 |
| 5.3.1 | The flat model $\mathbb{C}\mathbb{P}^n$ | 69 |
| 5.3.2 | Representations of $\mathfrak{sl}(n+1, \mathbb{C})$ | 71 |
| 5.3.3 | Harmonic curvature | 73 |
| 5.4 | Associated BGG operators | 75 |
| 5.4.1 | Metrisability of c-projective structures | 75 |
| 5.4.2 | The c-projective hessian | 78 |
| 6 | Quaternionic geometry | 82 |
| 6.1 | Background on almost quaternionic geometry | 82 |
| 6.1.1 | Background on quaternions | 82 |
| 6.1.2 | Classical theory | 83 |
| 6.1.3 | Projective interpretation | 86 |
| 6.2 | Description as a parabolic geometry | 88 |
| 6.2.1 | The flat model $\mathbb{H}\mathbb{P}^n$ | 88 |
| 6.2.2 | Representations of $\mathfrak{sl}(n+1, \mathbb{H})$ | 92 |
| 6.2.3 | Harmonic curvature | 94 |
| 6.3 | Associated BGG operators | 96 |
| 6.3.1 | Metrisability of quaternionic structures | 97 |
| 6.3.2 | The quaternionic hessian | 100 |
| 7 | Projective parabolic geometries | 103 |
| 7.1 | Definition and self-duality | 103 |
| 7.1.1 | Key features of classical projective geometries | 104 |
| 7.1.2 | Duality for R-spaces | 105 |
| 7.1.3 | General definition | 108 |
| 7.2 | Algebraic structure | 109 |
| 7.2.1 | Relation to Jordan algebras | 110 |
| 7.2.2 | Structure of \mathfrak{g} and \mathbb{W} | 112 |
| 7.2.3 | The \mathbb{Z}^2 -grading | 121 |

| | | |
|----------|--|------------|
| 7.2.4 | Characterisation of L | 125 |
| 7.3 | Classification | 127 |
| 7.3.1 | Classification over \mathbb{C} | 127 |
| 7.3.2 | Real forms | 131 |
| 7.4 | Calculus and associated BGG operators | 134 |
| 7.4.1 | Projective parabolic calculus | 135 |
| 7.4.2 | Metrisability of projective parabolic geometries | 138 |
| 7.4.3 | Normalised Ricci curvature and Einstein metrics | 145 |
| 7.4.4 | The hessian equation | 153 |
| 8 | Projective parabolic geometries of mobility two | 158 |
| 8.1 | Metrisability pencils and integrability | 158 |
| 8.1.1 | The pfaffian of a linear metric | 159 |
| 8.1.2 | Adjugate tensors | 161 |
| 8.1.3 | Integrals of the geodesic flow | 164 |
| 8.1.4 | Killing 2-tensors | 166 |
| 8.2 | Canonical vector fields | 171 |
| 8.2.1 | Definition using BGG pairings | 172 |
| 8.2.2 | Commutativity | 175 |
| 8.3 | Relative eigenvalues and the order of a pencil | 181 |
| 8.3.1 | Review of Jordan normal forms | 182 |
| 8.3.2 | Stable and regular points | 183 |
| 8.3.3 | The order of a pencil | 187 |
| 8.3.4 | Special features of riemannian pencils | 194 |
| A | Some algebraic identities | 197 |
| B | Tables | 202 |
| | Bibliography | 207 |
| | Index of notation | 218 |

List of Figures

| | | |
|-----|---|-----|
| 2.1 | Recipes for performing simple root reflections | 25 |
| 2.2 | Hasse diagram and homology of a parabolic subalgebra of $\mathfrak{e}_6(\mathbb{C})$ | 27 |
| 3.1 | A commuting square in the curved BGG sequence | 44 |
| 4.1 | The Hasse diagram computing $H_\bullet(\mathfrak{p}^\perp; \mathfrak{sl}(n+1, \mathbb{R}))$ | 56 |
| 5.1 | The Hasse diagram computing $H_\bullet(\mathfrak{p}^\perp; \mathfrak{sl}(n+1, \mathbb{C}))$ | 74 |
| 6.1 | The Hasse diagram computing $H_\bullet(\mathfrak{p}^\perp; \mathfrak{sl}(n+1, \mathbb{H}))$ | 95 |
| 7.1 | The \mathbb{Z}^2 -grading on \mathfrak{h} | 123 |
| 7.2 | The Hasse diagram computing $H_\bullet(\mathfrak{p}^\perp; \mathfrak{e}_6(\mathbb{C}))$ | 137 |
| 7.3 | The Hasse diagram computing $H_\bullet(\mathfrak{p}^\perp; \mathfrak{so}(n+2, \mathbb{C}))$ | 137 |

List of Tables

| | | |
|-----|--|-----|
| 7.1 | Lie brackets between the \mathbb{Z}^2 -graded summands of \mathfrak{h} | 124 |
| 7.2 | Classification of complex projective parabolic geometries | 131 |
| 7.3 | Numerical data for the complex projective parabolic geometries | 131 |
| 7.4 | The flat models admitting a positive definite metric | 134 |
| B.1 | The symmetric R-spaces $H \cdot \mathfrak{q}$ and $G \cdot \mathfrak{p}$ | 202 |
| B.2 | Real forms of projective parabolic geometries | 203 |
| B.3 | \mathbb{W} and its graded components | 204 |
| B.4 | \mathbb{W}^* and its graded components | 205 |
| B.5 | \mathbb{U}^* and its graded components | 206 |

Introduction

Given a riemannian manifold (M, g) , it is natural to ask whether M admits any other metrics \hat{g} with the same geodesics as g , viewed as unparameterised curves. Such \hat{g} are said to be *projectively equivalent* to g , leading to the notion of a projective equivalence class of metrics. This is the classical formulation of projective differential geometry, as studied by authors such as Beltrami [23], Dini [71], Painlevé [154], Levi-Civita [127] and É. Cartan [64, 65], to name just a few.

More properly, geodesics are a feature of linear connections rather than metrics. Discarding the metrics g, \hat{g} then allows us to talk about a *projective equivalence class* $[\nabla]^r$ of linear connections ∇ on TM , leading to the notion of a *projective manifold* $(M, [\nabla]^r)$. By results of Cartan [63, 64, 65] and Thomas [173], there is an equivalence of categories between projective structures on M and *Cartan connections* on the frame bundle of M . Thus, in modern language, projective differential geometry is an example of an *abelian parabolic geometry* modelled on the projective space \mathbb{RP}^n , which is naturally a projective manifold when equipped with the projective equivalence class of its spherical metric. This gives leverage to the theory of parabolic subalgebras and their representation theory: for example, $[\nabla]^r$ is identified with the space of *Weyl connections*, which are induced by splitting the parabolic filtration of the Lie algebra $\mathfrak{sl}(n+1, \mathbb{R})$ of trace-free $(n+1) \times (n+1)$ real matrices.

There is now no guarantee that $[\nabla]^r$ contains the Levi-Civita connection of a metric. In the classical picture with a background metric g , Sinjukov [166] found that a second metric \hat{g} is projectively equivalent to g if and only if an endomorphism $A(g, \hat{g})$, constructed solely from g, \hat{g} , satisfies a certain first-order differential equation. The 2-dimensional version of this equation was essentially known to Liouville [129]; see also [136]. An invariant version of Sinjukov's equation was later discovered by Eastwood and Matveev [77], which controls whether the Levi-Civita connection of a given metric lies in $[\nabla]^r$. In parabolic language, this invariant equation coincides with the first BGG operator [49, 61] associated to the natural representation $\mathbb{W} := \mathbb{S}^2 \mathbb{R}^{n+1}$ of $\mathfrak{sl}(n+1, \mathbb{R})$. The important point is that metrisability of $[\nabla]^r$ is controlled by a projectively invariant first-order linear differential equation with a representation-theoretic origin.

Moving to the holomorphic category, Ōtsuki and Tashiro [153] found that Kähler metrics g, \hat{g} are projectively equivalent if and only if they are affinely equivalent, rendering projective equivalence uninteresting in this context. C-projective geometry arises as the natural adaptation of projective differential geometry to an almost complex manifold (M, J) : a curve γ is a *c-geodesic* of a connection ∇ if and only if $\nabla_X X$ lies in the linear span $\langle X, JX \rangle$ for all vectors X tangent to γ , leading to a notion of *c-projective equivalence*. An *(almost) c-projective structure* is then the choice of a c-projective equivalence class $[\nabla]^c$ of linear connections on TM . The classical theory proceeds in much the same way as for projective structures, and many results known for projective structures were adapted to the c-projective setting; see [73, 146, 172]. In particular, Domashev and Mikeš [73] found that two Kähler metrics have the same c-geodesics if and only if a particular endomorphism $A(g, \hat{g})$ satisfies a first-order linear differential equation similar to Sinjukov's equation. There is also an interpretation in terms of *hamiltonian 2-forms*, as described by Apostolov *et al.* [10, 11, 12, 13, 14].

Complex projective space $\mathbb{C}\mathbb{P}^n$ is naturally a c-projective manifold when equipped with the c-projective equivalence class of its Fubini–Study metric. Via the general theory of parabolic geometries [60], we obtain an equivalence of categories between almost c-projective structures on M and parabolic geometries modelled on $\mathbb{C}\mathbb{P}^n$ [51, 102]. This again opens the door to methods from parabolic geometries and the BGG machinery, and one finds that metrisability of $[\nabla]^c$ is controlled by the first BGG operator associated to the real representation $\mathbb{W} := (\mathbb{C}^{n+1} \boxtimes \overline{\mathbb{C}^{n+1}})_{\mathbb{R}}$ of $\mathfrak{sl}(n+1, \mathbb{C})$. Using this language, the recent survey [51] has obtained many results which mirror known results in projective differential geometry.

The classical theory of almost quaternionic manifolds can also be made to fit into this projective picture. An *almost quaternionic structure* on a manifold M is a rank three subbundle $\mathcal{Q} \leq \mathfrak{gl}(TM)$ which is pointwise isomorphic to the unit quaternions $\mathfrak{sp}(1)$; see [6, 161, 162]. A connection is *(almost) quaternionic* if it preserves \mathcal{Q} ; it turns out [9] that the quaternionic connections form an affine space modelled on T^*M , leading to a notion of *quaternionic equivalence*. On the other hand, a curve γ is called a *q-geodesic* of ∇ if $\nabla_X X$ lies in the quaternionic span of X . Fujimura [82] proved that connections have the same q-geodesics if and only if are quaternionically equivalent, thus fitting quaternionic geometry into the same framework as projective and c-projective geometries. We will see later that compatible metrics (*i.e.* quaternion-Kähler metrics) are controlled by a first-order linear differential equation resembling Sinjukov's equation.

Salamon [162] originally described quaternionic manifolds as manifolds modelled locally on the quaternionic projective space $\mathbb{H}\mathbb{P}^n$, which lends itself to a parabolic de-

scription. The general theory gives an equivalence of categories between almost quaternionic structures on M and parabolic geometries modelled on $\mathbb{H}\mathbb{P}^n$, with quaternionic connections corresponding to Weyl connections. Metrisability is controlled by a first BGG operator, now associated to the representation $\mathbb{W} := (\wedge_{\mathbb{C}}^2 \mathbb{C}^{2n+2})_{\mathbb{R}}$ of $\mathfrak{sl}(n+1, \mathbb{H})$.

These three classical theories evidently have similar descriptions: all are abelian parabolic geometries modelled on a projective space $\mathbb{F}\mathbb{P}^n$, with a well-defined metrisability problem controlled the first BGG operator associated to a representation \mathbb{W} . Moreover, many results in the three theories have proofs which differ only in places where the base field \mathbb{F} has influence. The objectives of this thesis are as follows:

- (1) Construct a general framework in which the classical projective structures may be described as special cases, using the language of abelian parabolic geometries;
- (2) Give a general interpretation for the representation \mathbb{W} to which the metrisability problem is associated, and develop algebraic tools for other key representations;
- (3) Interpret solutions of the first BGG operator associated to the representation \mathbb{W} as (pseudo-riemannian) metrics compatible with the underlying geometric structure;
- (4) Generalise results which have similar statements in the three classical cases and adapt them to the general framework;
- (5) Describe 2-dimensional families of compatible metrics, in order to make contact with the classical approaches to the projective structures.

The first key observation to achieve (1) is as follows. For projective differential geometry we have $\mathfrak{g} := \mathfrak{sl}(n+1, \mathbb{R})$ and $\mathbb{W} := S^2\mathbb{R}^{n+1}$, with \mathfrak{p} given by crossing the final node of the Satake diagram. We may identify $\mathbb{R}\mathbb{P}^n$ with a generalised flag manifold G/P , where P is the adjoint stabiliser of a lowest weight vector in \mathbb{V}^* for any irreducible \mathfrak{g} -representation \mathbb{V} whose highest weight is supported on the final node of the Satake diagram of \mathfrak{g} [60, Prop. 3.2.5]. We thus obtain a projective embedding $\mathbb{R}\mathbb{P}^n \hookrightarrow \mathbb{P}(\mathbb{V}^*)$ for any such representation; since these representations are of the form $\mathbb{V}_k := S^k\mathbb{R}^{n+1*}$ for $k > 0$, we recover the Veronese embeddings $\mathbb{R}\mathbb{P}^n \hookrightarrow \mathbb{P}(S^k\mathbb{R}^{n+1})$. The case $k = 2$ is our previous representation \mathbb{W} , thus giving an embedding into the projectivisation of the representation which sets up the metrisability problem.

Secondly, we notice that $\mathbb{R}^{n+1} \oplus \mathbb{R}^{n+1*}$ is naturally a symplectic vector space when equipped with the symplectic structure $\omega((u, \alpha), (v, \beta)) := \beta(u) - \alpha(v)$. The adjoint representation of $\mathfrak{h} := \mathfrak{sp}(\mathbb{R}^{n+1} \oplus \mathbb{R}^{n+1*}, \omega) \cong \mathfrak{sp}(2n+2, \mathbb{R})$ then decomposes as

$$\mathfrak{h} = S^2(\mathbb{R}^{n+1} \oplus \mathbb{R}^{n+1*}) \cong S^2\mathbb{R}^{n+1} \oplus \mathfrak{gl}(n+1, \mathbb{R}) \oplus S^2\mathbb{R}^{n+1*},$$

where $\mathfrak{gl}(n+1, \mathbb{R})$ is the reductive Lie algebra of endomorphisms of \mathfrak{h} which preserve

the block decomposition of \mathfrak{h} . Moreover $\mathfrak{gl}(n+1, \mathbb{R}) = \mathfrak{g} \oplus \mathbb{R}$, so we may recover our original algebra $\mathfrak{g} = \mathfrak{sl}(n+1, \mathbb{R})$ from \mathfrak{h} as the semisimple part of $\mathfrak{gl}(n+1, \mathbb{R})$. Thus \mathbb{W} may be regarded as the infinitesimal isotropy representation $\mathfrak{h}/\mathfrak{q}$ of the abelian parabolic subalgebra $\mathfrak{q} := (\mathfrak{g} \oplus \mathbb{R}) \oplus \mathbb{W}^*$. This supplies a larger symmetric R-space $H \cdot \mathfrak{q}$ (see Definition 2.20), isomorphic to the space of lagrangian subspaces of \mathbb{R}^{2n+2} , which contains $G \cdot \mathfrak{p} \cong \mathbb{RP}^n$.

These observations equally apply to the flat models \mathbb{CP}^n and \mathbb{HP}^n of c-projective and quaternionic geometry. For \mathbb{CP}^n we have $\mathfrak{g} = \mathfrak{sl}(n+1, \mathbb{C})$ and $\mathbb{W} = (\mathbb{C}^{n+1} \boxtimes \overline{\mathbb{C}^{n+1}})_{\mathbb{R}}$, and we find a projective embedding $\mathbb{CP}^n \hookrightarrow \mathbb{P}(\mathbb{W})$ as before. The \mathfrak{g} -representation $\mathfrak{h} := \mathbb{W} \oplus (\mathfrak{g} \oplus \mathbb{R}) \oplus \mathbb{W}^*$ also has a graded Lie algebra structure, now isomorphic to $\mathfrak{su}(n+1, n+1)$, yielding a larger symmetric R-space $H \cdot \mathfrak{q}$ of maximal isotropic subspaces of \mathbb{C}^{2n+2} of a hermitian inner product of signature $(n+1, n+1)$. For \mathbb{HP}^n we have $\mathfrak{g} = \mathfrak{sl}(n+1, \mathbb{H})$ and $\mathbb{W} = (\wedge_{\mathbb{C}}^2 \mathbb{C}^{2n+2})_{\mathbb{R}}$, with a Plücker-type embedding $\mathbb{HP}^n \hookrightarrow \mathbb{P}(\mathbb{W})$. There is again a graded Lie algebra structure on $\mathfrak{h} := \mathbb{W} \oplus (\mathfrak{g} \oplus \mathbb{R}) \oplus \mathbb{W}^*$, this time isomorphic to the real form $\mathfrak{so}^*(4n+4)$ of $\mathfrak{sl}(2n+2, \mathbb{C})$, yielding a larger symmetric R-space $H \cdot \mathfrak{q}$ of isotropic quaternionic subspaces of \mathbb{H}^{n+1} .

The final necessary observation is that all three R-spaces $H \cdot \mathfrak{q}$ are *self-dual* in the sense of [44]; for abelian parabolic subalgebras $\mathfrak{q}, \hat{\mathfrak{q}} \leq \mathfrak{h}$ which satisfy $\mathfrak{q} \oplus \hat{\mathfrak{q}}^\perp = \mathfrak{h}$, this amounts to asking that $\mathfrak{q}, \hat{\mathfrak{q}}$ are conjugate by an element of H . Self-duality provides the final ingredient in our general definition.

Definition. Let $H \cdot \mathfrak{q}$ be a self-dual symmetric R-space with infinitesimal isotropy representation $\mathbb{W} := \mathfrak{h}/\mathfrak{q}$. A *projective parabolic geometry* is a parabolic geometry modelled on the R-space $G \cdot \mathfrak{p}$ given by the stabiliser of a lowest weight orbit in \mathbb{W} .

We will describe how to recover $G \cdot \mathfrak{p}$ from $H \cdot \mathfrak{q}$ later. This “top-down” approach is beneficial because $H \cdot \mathfrak{q}$ contains the Lie-algebraic structure of both \mathfrak{g} and its representation \mathbb{W} . Note however that the R-space $G \cdot \mathfrak{p}$ is not *a priori* symmetric, as we find for the classical projective structures, and some work involving the root data of \mathfrak{h} and \mathfrak{g} is required to show this. The key step is relating self-duality of $H \cdot \mathfrak{q}$ to a Jordan algebra structure on \mathbb{W} , which is a commutative but non-associative algebra satisfying a power associativity relation. An idempotent decomposition of \mathbb{W} then gives detailed information about the graded components of both \mathfrak{g} and \mathbb{W} , in particular allowing us to construct a \mathbb{Z}^2 -grading on \mathfrak{h} with respect to algebraic Weyl structures \mathfrak{q} and \mathfrak{p} .

Theorem. *With notation as above, $G \cdot \mathfrak{p}$ is a symmetric R-space. Moreover \mathbb{W} admits the structure of a Jordan algebra and decomposes into three graded components as a \mathfrak{p} -representation. Thus $\mathfrak{h} \cong \mathbb{W} \oplus (\mathfrak{g} \oplus \mathbb{R}) \oplus \mathbb{W}^*$ admits a \mathbb{Z}^2 -grading, with Lie brackets between the various summands given by Table 7.1.*

It is not such a surprise that \mathbb{W} admits a Jordan algebra structure: the relation between self-dual symmetric R-spaces and Jordan algebras has been extensively studied by Tits [174], Koecher [116, 117], Meyberg [143] and Bertram [26, 27, 28]. In outline, any Jordan algebra (\mathbb{W}, \circ) can be embedded into the *Kantor–Koecher–Tits algebra* $\mathfrak{h} := \mathbb{W} \oplus \mathfrak{der}(\mathbb{W}) \oplus \mathbb{W}^*$, where $\mathfrak{der}(\mathbb{W})$ is the Lie algebra generated by the multiplication maps $L_{x \circ y} : z \mapsto (x \circ y) \circ z$. Then $\mathfrak{q} := \mathfrak{der}(\mathbb{W}) \oplus \mathbb{W}^*$ becomes an abelian parabolic subalgebra of \mathfrak{h} , and the corresponding R-space can be shown to be self-dual [143]. Thus we obtain a 1-to-1 correspondence between Jordan algebras and self-dual symmetric R-spaces; Loos [130] extends this to a 1-to-1 correspondence between so-called *Jordan triple systems* and symmetric R-spaces.

A Jordan algebra is called *formally real* if the trace form $\tau(x, y) := \text{tr}(L_{x \circ y})$ is positive definite. The classification of formally real Jordan algebras was obtained by Jordan, von Neumann and Wigner [107], who showed that they comprise four infinite families and a single exceptional algebra. The four families consist of the symmetric real matrices, the hermitian matrices, the quaternion-hermitian matrices, and the *spin factors*, which may be described as a Clifford algebra. The exceptional *Albert algebra* consists of 3×3 octonion-hermitian matrices and was described by Albert [2].

Of interest to us is the intimate relationship between formally real Jordan algebras and projective geometry [16, 26]: the space $\text{idem}(\mathbb{W})$ of primitive idempotents may be stratified by their trace, and the idempotents with trace one may be viewed as points in a projective space. The Jordan algebras of symmetric, hermitian and quaternion-hermitian matrices yield the classical projective spaces $\mathbb{R}P^n$, $\mathbb{C}P^n$ and $\mathbb{H}P^n$ [141], while the spin factors allow us to view the conformal sphere \mathbb{S}^n as “one dimensional projective geometry over \mathbb{R}^n ” [126, 123]. For the Albert algebra, one obtains Moufang’s octonionic projective plane $\mathbb{O}P^2$ [16, 148]. Moreover by work of Hirzebruch [99], the trace form induces a riemannian metric on $\text{idem}(\mathbb{W})$, which may then be a 2-point homogeneous riemannian symmetric space of rank one. Thus we recover Cartan’s classification [66, 67] of rank one riemannian symmetric spaces. There is also a complex analytic description in terms of bounded symmetric domains of tube type; see [80, 118, 130].

Returning to the case of a projective parabolic geometry, it turns out that the Jordan algebra structure of \mathbb{W} strictly confines the Lie brackets between the various summands of the \mathbb{Z}^2 -grading of \mathfrak{h} , allowing us to calculate many brackets independently of the projective parabolic geometry in question. This often means that, once one has reduced a result to the verification of an algebraic identity, the proof may be completed via a series of formal manipulations using the Killing form and Jacobi identity. Although the reader may express dissatisfaction at these (often long) algebraic manipulations, the author would argue that the strictness of the algebraic framework deftly

explains why many results in the classical theories have only subtly different proofs. In particular, our fourth goal above may be achieved by framing a desired result in purely algebraic terms, where it can be solved by algebraic manipulations.

Theorem. *Consider a projective parabolic geometry on M with flat model $G \cdot \mathfrak{p}$ and infinitesimal isotropy representation \mathbb{W} . Then solutions of the first BGG operator associated to \mathbb{W} induce metrics compatible with the underlying geometric structure. In particular, Einstein metrics correspond to so-called normal BGG solutions.*

Using the classification of self-dual symmetric spaces, it is straightforward to classify the projective parabolic geometries with $H \cdot \mathfrak{q}$ irreducible. This classification may be phrased in terms of a pair of integers (r, n) , which arise from the idempotent decomposition of the Jordan algebra \mathbb{W} and play an important role in the algebraic theory. In addition to the classical projective structures coming from the formally real Jordan algebras \mathbb{W} , the classification includes geometries modelled on the grassmannian of 2-planes, a symmetric R-space associated to the split real form of $\mathfrak{e}_6(\mathbb{C})$, and conformal geometries of various signatures.

Overview. The first two chapters provide relevant background material. Chapter 2 introduces parabolic subalgebras and R-spaces, focusing primarily on their structure theory and Lie algebra homology. Chapter 3 reviews the theory of parabolic geometries, including their tractor calculus and the curved BGG machinery.

Next we study the three classical projective structures. Chapter 4 gives a detailed introduction to projective differential geometry, both from the classical and parabolic perspectives. Chapters 5 and 6 describe c-projective geometry and almost quaternionic geometry in a similar way. Hopefully the reader will excuse some repetition: these chapters serve primarily as a literature review and as general motivation, although there are some (apparently) original results in the quaternionic case.

The general framework uniting these geometries is defined and studied in Chapter 7. In particular, we undertake a detailed investigation of the algebraic structure of a projective parabolic geometry. Afterwards we examine the metrisability problem, obtaining results similar to the classical cases.

In light of goal (5) above, Chapter 8 is devoted to the study of projective parabolic geometries admitting a 2-dimensional family of compatible metrics. Notably, we obtain results on the geodesic flow of a metric, and a family of commuting vector fields.

Finally, the two appendices contain supplementary material. Appendix A contains some algebraic identities, whose proofs are long and would have disrupted the flow of the text. Appendix B summaries some representation-theoretic data relating to projective parabolic geometries for the reader's convenience.

Notation. While notation should not pose a significant problem, a few points are worth mentioning. For valence one tensors α, β , our conventions for the wedge and symmetric product are $\alpha \wedge \beta := \alpha \otimes \beta - \beta \otimes \alpha$ and $\alpha \odot \beta := \frac{1}{2}(\alpha \otimes \beta + \beta \otimes \alpha)$. We denote the external tensor product by \boxtimes , and the Cartan product by \odot . Hamiltonian's quaternions and Cayley's octonions are denoted by \mathbb{H} and \mathbb{O} respectively. Finally, unless stated otherwise, all differential geometric objects are smooth. An index of notation is provided on page 218.

Acknowledgements. There are several people I must thank, without whom this project would not have been completed: my supervisor, Prof. David Calderbank, for his patience and constant suggestion of useful ideas; my wife, Loui, for her unwavering support and understanding of my strange working hours; and my parents, for their encouragement and reinforcing the importance of education.

I am also grateful for financial support from the EPSRC, and to my examiners for many helpful suggestions.

Background from Lie theory

We begin with a review of some necessary ingredients from Lie theory. We shall assume that the reader has a working knowledge of the structure theory and representation theory of semisimple Lie algebras; see [60, 84, 103] for a thorough introduction.

The structure theory and representation theory of parabolic subalgebras of semisimple Lie algebras shall feature heavily throughout this thesis, so we spend some time describing the pertinent results in Section 2.1. In particular, the theory of R-spaces and their projective embeddings shall be important.

As we shall see in Section 3.3, the invariant differential operators associated to a parabolic geometry are related to the Lie algebra homology of its flat model. We introduce Lie algebra homology and cohomology in Section 2.2, as well as describing the algorithm for its computation provided by Kostant's version of the Bott–Borel–Weil theorem. The standard reference for this material is [119], but readable accounts may also be found in [22, 60, 104].

2.1 Parabolic subalgebras

Let \mathfrak{g} be a complex semisimple Lie algebra. A maximal solvable subalgebra $\mathfrak{b} \leq \mathfrak{g}$ is called a *Borel subalgebra*, while a subalgebra $\mathfrak{p} \leq \mathfrak{g}$ is called *parabolic* if \mathfrak{p} contains a Borel subalgebra. However, the following equivalent definition is available; see [44, 50].

Definition 2.1. A subalgebra \mathfrak{p} of a semisimple Lie algebra \mathfrak{g} is *parabolic* if the Killing polar \mathfrak{p}^\perp is a nilpotent subalgebra of \mathfrak{g} . We say \mathfrak{p} is an *abelian parabolic* if $\mathfrak{p}^\perp \leq \mathfrak{g}$ is an abelian subalgebra.

Lemma 2.2. [38, Thm. 1] *Let $\mathfrak{p} \leq \mathfrak{g}$ be parabolic. Then \mathfrak{p}^\perp is a nilpotent ideal of \mathfrak{p} .*

Proof. By invariance of the Killing form, we have $\langle [\mathfrak{p}^\perp, \mathfrak{p}], \mathfrak{p} \rangle = \langle \mathfrak{p}^\perp, [\mathfrak{p}, \mathfrak{p}] \rangle \subseteq \langle \mathfrak{p}^\perp, \mathfrak{p} \rangle = 0$ and hence $[\mathfrak{p}, \mathfrak{p}^\perp] \subseteq \mathfrak{p}^\perp$. \square

In fact, one can show [72, Lem. 1.1] that \mathfrak{p}^\perp coincides with the nilpotent radical of \mathfrak{p} . Then the quotient $\mathfrak{p}^0 := \mathfrak{p}/\mathfrak{p}^\perp$ is a reductive Lie algebra, called the *reductive Levi factor* of \mathfrak{p} . It is always possible to choose a splitting of the projection $\mathfrak{p} \rightarrow \mathfrak{p}^0$, so we may identify \mathfrak{p}^0 with a subalgebra complementary to \mathfrak{p}^\perp in \mathfrak{p} such that $\mathfrak{p} \cong \mathfrak{p}^0 \ltimes \mathfrak{p}^\perp$ is a semi-direct sum [50].

The benefit of Definition 2.1 is that it works over any field of characteristic zero, whereas the definition via Borel subalgebras only works over \mathbb{C} . One may also use this idea to define parabolic subalgebras \mathfrak{p} of a reductive Lie algebra \mathfrak{g} [151], by asking that \mathfrak{p}^\perp is a nilpotent subalgebra of $\mathfrak{p} \cap [\mathfrak{g}, \mathfrak{g}]$. However, we shall restrict attention to semisimple Lie algebras \mathfrak{g} , where $\mathfrak{g} = [\mathfrak{g}, \mathfrak{g}]$.

In Subsection 2.1.1 we shall develop the basic structural theory of parabolic subalgebras from the root data of \mathfrak{g} . This suggests a filtration associated to any parabolic subalgebra, which we discuss in Subsection 2.1.2. The representation theory of a parabolic subalgebra is discussed in Subsection 2.1.3. Finally, we discuss conjugacy classes of parabolics in Subsection 2.1.4, which forms the basis of central definitions and results in this thesis.

2.1.1 Standard parabolics

Let \mathfrak{g} be a complex semisimple Lie algebra, which we fix henceforth. By appealing to the structure theory of \mathfrak{g} , we may identify a family of so-called *standard parabolics*. Choose a Cartan subalgebra $\mathfrak{t} \leq \mathfrak{g}$ with roots $\Delta \subset \mathfrak{t}^*$, and choose a positive subsystem $\Delta^+ \subset \Delta$ with simple roots Δ^0 . From the root space decomposition $\mathfrak{g} = \mathfrak{t} \oplus \bigoplus_{\alpha \in \Delta} \mathfrak{g}_\alpha$ of \mathfrak{g} , it is easy to see that $\mathfrak{b} := \mathfrak{t} \oplus \bigoplus_{\alpha \in \Delta^+} \mathfrak{g}_{-\alpha}$ is a Borel subalgebra of \mathfrak{g} , called the *standard Borel* with respect to \mathfrak{t} and Δ^+ .

Definition 2.3. A parabolic subalgebra $\mathfrak{p} \leq \mathfrak{g}$ is called a *standard parabolic* with respect to \mathfrak{t} and Δ^+ if it contains the standard Borel.¹

Thus a standard parabolic is the direct sum of \mathfrak{t} , all negative root spaces, and some positive root spaces. Since the Weyl group of \mathfrak{g} acts transitively on the set of positive subsystems of Δ , any Borel subalgebra of \mathfrak{g} is conjugate to the standard one via the adjoint action of G . Consequently any parabolic is conjugate to a (unique) standard parabolic, yielding the following [60, Thm. 3.2.1].

Lemma 2.4. *Let $\mathfrak{p} \leq \mathfrak{g}$ be a parabolic subalgebra. Then \mathfrak{t} and Δ^+ can be chosen such that \mathfrak{p} is a standard parabolic.* □

¹Many authors, notably [22, 60, 84], define the standard Borel to contain all positive root spaces. We choose the opposite convention to better facilitate the treatment of homology and subsequently BGG operators; see Section 2.2.

The set of standard parabolics with respect to \mathfrak{t} and Δ^+ may also be enumerated using the set $\Delta^0 \subset \Delta$ of simple roots [84, p. 384].

Proposition 2.5. *There is a bijection between standard parabolics $\mathfrak{p} \leq \mathfrak{g}$ and subsets $\Sigma \subseteq \Delta^0$, given by mapping $\mathfrak{p} \leq \mathfrak{g}$ to $\Sigma_{\mathfrak{p}} := \{\alpha \in \Delta^0 \mid \mathfrak{g}_{\alpha} \not\leq \mathfrak{p}\}$ and conversely by mapping a subset $\Sigma \subseteq \Delta^0$ to the standard parabolic with positive root spaces $\langle \Delta^0 \setminus \Sigma \rangle \cap \Delta^+$. \square*

Since elements of Δ^0 are the nodes of the Dynkin diagram of \mathfrak{g} , this suggests an obvious notation for standard parabolics $\mathfrak{p} \leq \mathfrak{g}$: we represent \mathfrak{p} by crossing the nodes corresponding to elements of the associated subset $\Sigma_{\mathfrak{p}} \subseteq \Delta^0$. Thus the Dynkin diagram with no nodes crossed is the non-proper parabolic \mathfrak{g} , while crossing all nodes yields the standard Borel; other examples may be found in [22, §2.2].

Lemma 2.6. *The subspace $\langle \alpha^{\vee} \mid \alpha \in \Delta^0 \setminus \Sigma \rangle \leq \mathfrak{t}$ forms a Cartan subalgebra for the semisimple part of \mathfrak{p}^0 , while $\mathfrak{z}(\mathfrak{p}^0) = \langle H \in \mathfrak{t} \mid \alpha(H) = 0 \ \forall \alpha \in \Delta^0 \setminus \Sigma \rangle$. \square*

These two subspaces of \mathfrak{t} are complementary and orthogonal with respect to the Killing form [60, Thm. 3.2.1]. In particular, the dimension of $\mathfrak{z}(\mathfrak{p}^0)$ is equal to the number of elements of the corresponding subset $\Sigma_{\mathfrak{p}}$, *i.e.* the number of crossed nodes.

Let us also mention briefly how to deal with parabolic subalgebras of a real semisimple Lie algebra. In this case $\mathfrak{p} \leq \mathfrak{g}$ is called a *standard parabolic* if its complexification is a standard parabolic in the sense of Definition 2.3, and any parabolic is conjugate to a standard parabolic by the adjoint action of a maximal compact subgroup $K \leq \text{Int}(\mathfrak{g})$. It turns out that there is a bijection between standard parabolics of \mathfrak{g} and subsets $\Sigma \subseteq \Delta^0$ which are disjoint from the set Δ_c^0 of compact simple roots and stable under the non-compact root involution, which are themselves in bijection with subsets of restricted simple roots. Therefore real standard parabolics are classified by crossing white nodes of the Satake diagram² of \mathfrak{g} , with the caveat that we must also cross all nodes connected by an arrow. Details and examples may be found in [60, §3.2.9].

2.1.2 Filtrations and gradings

Let V be a vector space over a field \mathbb{k} , which for us will be \mathbb{R} or \mathbb{C} .

Definition 2.7. A *filtration* of V is a family $\{V_i\}_{i \in \mathbb{Z}}$ of subspaces satisfying $V_{i+1} \supset V_i$ for all $i \in \mathbb{Z}$, and $\bigcup_{i \in \mathbb{Z}} V_i = V$ and $\bigcap_{i \in \mathbb{Z}} V_i = \{0\}$. A *grading* of V is a vector space decomposition $V = \bigoplus_{i \in \mathbb{Z}} V_{(i)}$.

Typically we are interested in filtrations for which $V_i \neq 0, V$ for only finitely many $i \in \mathbb{Z}$. Any filtration $\{V_i\}_{i \in \mathbb{Z}}$ of V gives rise to a graded vector space $\text{gr } V$ with

²Our convention is that black nodes of the Satake diagram represent compact simple roots, while white nodes represent non-compact simple roots.

components $V_{(i)} := V_i/V_{i-1}$ called the *associated graded* of V . Although there are no natural linear maps between V and $\text{gr } V$ in either direction, there is an isomorphism $V \cong \text{gr } V$ given by choosing a splitting of each projection $V_i \twoheadrightarrow V_{(i)}$, thus identifying $V_{(i)}$ with a complement to V_{i-1} in V_i . Given such splittings of filtered V, W , a linear map $f : V \rightarrow W$ has *homogeneity* k if $f(V_{(i)}) \subseteq W_{(i+k)}$ for all $i \in \mathbb{Z}$, giving a grading of $\text{Hom}(V, W)$ by homogeneous degree.

Now consider a Lie algebra \mathfrak{g} over \mathbb{k} . A *filtration* of \mathfrak{g} is a filtration $\{\mathfrak{g}_i\}_{i \in \mathbb{Z}}$ of the underlying vector space such that $[\mathfrak{g}_i, \mathfrak{g}_j] \subseteq \mathfrak{g}_{i+j}$ for all $i, j \in \mathbb{Z}$. Then \mathfrak{g}_i is a subalgebra of \mathfrak{g} for all $i \leq 0$ and an ideal for $i < 0$ [60, Cor. 3.2.1]. Given an unfiltered \mathfrak{g} with a representation on a filtered vector space V , we obtain a filtration of \mathfrak{g} by defining $\mathfrak{g}_i := \{X \in \mathfrak{g} \mid X \cdot v \in V_{i+j} \ \forall v \in V_j\}$.

Let \mathfrak{p} be a parabolic subalgebra of \mathfrak{g} . Then by definition \mathfrak{p}^\perp is nilpotent, so that the lower central series $(\mathfrak{p}^\perp)^1 \supset (\mathfrak{p}^\perp)^2 \supset \dots \supset 0$ terminates after a finite number of steps, where $(\mathfrak{p}^\perp)^1 := \mathfrak{p}^\perp$ and $(\mathfrak{p}^\perp)^{k+1} := [\mathfrak{p}^\perp, (\mathfrak{p}^\perp)^k]$. We shall say that \mathfrak{p} has *height* n if $(\mathfrak{p}^\perp)^k = 0$ for all $k > n$. It is straightforward to check that

$$\mathfrak{g}_0 := \mathfrak{p}, \quad \mathfrak{g}_{-1} := \mathfrak{p}^\perp \quad \text{and} \quad \mathfrak{g}_k := \begin{cases} [\mathfrak{p}^\perp, \mathfrak{g}_{-k+1}] & k < 0 \\ (\mathfrak{g}_{-1-k})^\perp & k > 0 \end{cases}$$

defines a filtration of \mathfrak{g} , which we refer to as the \mathfrak{p}^\perp -filtration of \mathfrak{g} . If \mathfrak{p} has height n then clearly $\mathfrak{g}_{-(n+1)} = 0$ and $\mathfrak{g}_n = \mathfrak{g}$, so that there are $2n$ proper filtration components.

The associated graded Lie algebra $\text{gr } \mathfrak{g}$ has components $\mathfrak{g}_{(i)} := \mathfrak{g}_i/\mathfrak{g}_{i-1}$ satisfying $[\mathfrak{g}_{(i)}, \mathfrak{g}_{(j)}] \subseteq \mathfrak{g}_{(i+j)}$ for all $i, j \in \mathbb{Z}$. Clearly if \mathfrak{p} has height n then $\mathfrak{g}_{(i)} = 0$ for $|i| > n$, so that there are $2n + 1$ non-zero graded components. Notice also that $\mathfrak{g}_{(0)} := \mathfrak{p}/\mathfrak{p}^\perp$ is precisely the reductive Levi factor \mathfrak{p}^0 of \mathfrak{p} .

Lemma 2.8. *There is a unique $\xi_0 \in \mathfrak{z}(\mathfrak{p}^0)$ such that $[\xi_0, X] = iX$ for all $X \in \mathfrak{p}_{(i)}$. \square*

The element $\xi_0 \in \mathfrak{z}(\mathfrak{p}^0)$ is called the *grading element* of \mathfrak{p} . From the definition of the filtration, a choice of splitting of the projection $\mathfrak{p} \twoheadrightarrow \mathfrak{p}^0 := \mathfrak{p}/\mathfrak{p}^\perp$ evidently induces splittings of all projections $\mathfrak{g}_i \twoheadrightarrow \mathfrak{g}_{(i)}$; such splittings always exist [50, Lem. 2.2].

Definition 2.9. An *algebraic Weyl structure* for \mathfrak{p} is a choice of lift of the grading element $\xi_0 \in \mathfrak{z}(\mathfrak{p}^0)$ to \mathfrak{p} with respect to the projection $\mathfrak{p} \twoheadrightarrow \mathfrak{p}^0$.

Thus an algebraic Weyl structure induces an isomorphism $\mathfrak{g} \cong \text{gr } \mathfrak{g}$; for abelian parabolics this amounts to an isomorphism $\mathfrak{g} \cong \mathfrak{g}/\mathfrak{p} \oplus \mathfrak{p}^0 \oplus \mathfrak{p}^\perp$. Since the space of such lifts is an affine space modelled on \mathfrak{p}^\perp , we obtain the following [50, Lem. 2.5].

Lemma 2.10. *The subgroup $\exp \mathfrak{p}^\perp \leq P$ acts simply transitively on the affine space of algebraic Weyl structures for \mathfrak{p} . \square*

It follows that the stabiliser of an algebraic Weyl structure $\xi \in \mathfrak{p}$ is a subgroup of P projecting isomorphically onto $P^0 := P/\exp \mathfrak{p}^\perp$, so that ξ also splits the quotient group homomorphism $P \twoheadrightarrow P^0$. This is the basis of Čap and Slovák's treatment of Weyl structures [59]; see [50, App. A] for a detailed comparison.

Definition 2.11. Parabolics $\mathfrak{p}, \hat{\mathfrak{p}} \leq \mathfrak{g}$ of the same height and with associated filtrations $\{\mathfrak{g}_i\}_{i \in \mathbb{Z}}, \{\hat{\mathfrak{g}}_i\}_{i \in \mathbb{Z}}$ are said to be *opposite* if $\mathfrak{g}_i \cap \hat{\mathfrak{g}}_i$ is complementary to \mathfrak{g}_{i-1} in \mathfrak{g}_i .

For abelian parabolics $\mathfrak{p}, \hat{\mathfrak{p}}$, this amounts to asking that $\mathfrak{p}^\perp \cap \hat{\mathfrak{p}} = 0$. Generally, the complement $\mathfrak{g}_i \cap \hat{\mathfrak{g}}_i$ to \mathfrak{g}_{i-1} splits the projection $\mathfrak{g}_i \rightarrow \mathfrak{g}_{(i)}$; thus the choice of an opposite parabolic is equivalent to the choice of an algebraic Weyl structure [50, Lem. 2.5].

Lemma 2.12. $\exp \mathfrak{p}^\perp$ acts simply transitively on the set of parabolics opposite to \mathfrak{p} . \square

Choose a Cartan subalgebra $\mathfrak{t} \leq \mathfrak{g}$ and a simple subsystem Δ^0 with respect to which \mathfrak{p} is a standard parabolic corresponding to a subset $\Sigma \subseteq \Delta^0 = \{\alpha_1, \dots, \alpha_k\}$. Each root $\alpha = \sum_{i=1}^k a_i \alpha_i$ has an associated Σ -height $\text{ht}_\Sigma(\alpha) := \sum_{i: \alpha_i \in \Sigma} a_i$, and Lemma 2.4 can be adapted to show that each graded component $\mathfrak{g}_{(i)}$ consists of those root spaces of Σ -height i . In particular $\mathfrak{g}_{(0)} = \mathfrak{p}^0$ consists of the root spaces of height zero, while \mathfrak{p}^\perp consists of root spaces with negative height. It also follows that all parabolics conjugate to \mathfrak{p} have the same height, being given by the Σ -height of the highest root of \mathfrak{g} . Moreover Lemma 2.12 implies that the data $(\mathfrak{t}, \Delta^+, \Sigma)$ may be chosen in such a way that $\hat{\mathfrak{p}}$ is the standard parabolic corresponding to the data $(\mathfrak{t}, -\Delta^+, -\Sigma)$.³

Lemma 2.13. Suppose that \mathfrak{g} is simple with abelian parabolic \mathfrak{p} . Then $[\mathfrak{p}^\perp, \mathfrak{g}] = \mathfrak{p}$.

Proof. Invariance of the Killing form gives $\langle [\mathfrak{p}^\perp, \mathfrak{g}], \mathfrak{p}^\perp \rangle = \langle \mathfrak{g}, [\mathfrak{p}^\perp, \mathfrak{p}^\perp] \rangle = 0$, so that $[\mathfrak{p}^\perp, \mathfrak{g}] \subseteq (\mathfrak{p}^\perp)^\perp = \mathfrak{p}$ by non-degeneracy. Conversely, choose an algebraic Weyl structure for \mathfrak{p} and hence an isomorphism $\mathfrak{g} \cong \mathfrak{g}/\mathfrak{p} \oplus \mathfrak{p}^0 \oplus \mathfrak{p}^\perp$. Since \mathfrak{g} is simple, $[\mathfrak{p}^\perp, \mathfrak{p}^0] = \mathfrak{p}^\perp$ and $[\mathfrak{p}^\perp, \mathfrak{g}/\mathfrak{p}] = \mathfrak{p}^0$ by [60, Prop. 3.1.2(4)]; thus $\mathfrak{p} \cong \mathfrak{p}^0 \oplus \mathfrak{p}^\perp = [\mathfrak{p}^\perp, \mathfrak{g}/\mathfrak{p} \oplus \mathfrak{p}^0] \subseteq [\mathfrak{p}^\perp, \mathfrak{g}]$. \square

2.1.3 Representations of a parabolic

Generally speaking the representation theory of a parabolic subalgebra $\mathfrak{p} \leq \mathfrak{g}$ is quite complicated, but there are significant simplifications for completely reducible representations. Let $\mathfrak{p}^0 := \mathfrak{p}/\mathfrak{p}^\perp$ be the reductive Levi factor of \mathfrak{p} .

Lemma 2.14. [60, Prop. 3.2.12(1)] *Every completely reducible \mathfrak{p} -representation V is the trivial lift of a completely reducible \mathfrak{p}^0 -representation. Moreover, the grading element $\xi_0 \in \mathfrak{z}(\mathfrak{p}^0)$ acts by a scalar on each \mathfrak{p}^0 -irreducible component of V .* \square

³That is, $\hat{\mathfrak{p}}$ is defined as in Proposition 2.5 but with the roles of positive and negative roots exchanged.

Indeed, in this case the corresponding linear map $\mathfrak{p} \rightarrow \mathfrak{gl}(V)$ factors through the projection $\mathfrak{p} \twoheadrightarrow \mathfrak{p}^0$, giving a representation of \mathfrak{p}^0 on V which pulls back to the given \mathfrak{p} -representation. Since \mathfrak{p}^0 is not semisimple, its representations are not automatically completely reducible. In fact, a \mathfrak{p}^0 -representation is completely reducible if and only if its centre $\mathfrak{z}(\mathfrak{p}^0)$ acts diagonalisably [60, §3.2.12].

The representation theory of \mathfrak{p} can also be described in terms of highest weights. For this, choose a Cartan subalgebra $\mathfrak{t} \leq \mathfrak{g}$ and a simple subsystem Δ^0 with respect to which \mathfrak{p} is the standard parabolic corresponding to a subset $\Sigma \subseteq \Delta^0$. Recall that (isomorphism classes of) irreducible \mathfrak{g} -representations are in bijection with dominant integral weights [84, Thm. 14.18], *i.e.* those which can be written as a non-negative integral linear combination of the fundamental weights. By Lemma 2.14, irreducible \mathfrak{p} -representations are given by a representation of the semisimple part $\mathfrak{p}_{\text{ss}}^0$ and a linear functional on the centre $\mathfrak{z}(\mathfrak{p}^0)$. We say that a weight $\lambda \in \mathfrak{t}^*$ is \mathfrak{p} -dominant (respectively, \mathfrak{p} -integral) if the Cartan number $\frac{2\langle \lambda, \alpha \rangle}{\langle \alpha, \alpha \rangle}$ is non-negative (respectively, integral) for all $\alpha \in \Delta^0 \setminus \Sigma$.

Proposition 2.15. [60, Cor. 3.2.12] *There is a bijection between isomorphism classes of irreducible \mathfrak{p} -representations and \mathfrak{p} -dominant and \mathfrak{p} -integral weights $\lambda \in \mathfrak{t}^*$. \square*

In Dynkin diagram notation, the \mathfrak{p} -dominant and \mathfrak{p} -integral weights are precisely those with non-negative integer coefficients over the uncrossed nodes. If we are only interested in \mathfrak{p} -representations there is no restriction on the coefficients over crossed nodes. However if we ask that a representation integrates to a representation of a parabolic subgroup P with Lie algebra \mathfrak{p} , it turns out that the coefficients over crossed nodes must be integers [60, §3.2.12].

In the sequel we shall restrict to the following subclass of \mathfrak{p} -representations.

Definition 2.16. A \mathfrak{p} -representation V is *filtered* if there is a finite \mathfrak{p} -invariant filtration

$$V = V_N \supset V_{N-1} \supset \cdots \supset V_0 \supset 0$$

such that each graded component $V_{(i)}$ is a completely reducible \mathfrak{p} -representation. We henceforth redefine a \mathfrak{p} -representation to mean a filtered \mathfrak{p} -representation.

Since each $V_{(i)}$ is completely reducible, the grading element $\xi_0 \in \mathfrak{z}(\mathfrak{p}^0)$ acts by a scalar on each irreducible component of the induced \mathfrak{p}^0 -representation, called its (*geometric*) *weight*. An algebraic Weyl structure ξ for \mathfrak{p} then splits the filtration on V into the eigenspaces of ξ .

The restriction to \mathfrak{p} of a \mathfrak{g} -representation \mathbb{V} is a filtered \mathfrak{p} -representation. To see this, note that since $\mathfrak{p}^\perp \leq \mathfrak{g}$ is a nilpotent subalgebra, it acts nilpotently on \mathbb{V} by

Engel's theorem. Consequently we obtain a finite filtration

$$\mathbb{V} = \mathbb{V}_N \supset \mathfrak{p}^\perp \cdot \mathbb{V} \supset \dots \supset (\mathfrak{p}^\perp)^N \cdot \mathbb{V} = \mathbb{V}_0 \supset 0 \quad (2.1)$$

of \mathbb{V} , which we call the \mathfrak{p}^\perp -filtration of \mathbb{V} . Clearly \mathfrak{p}^\perp acts trivially on each graded component $\mathbb{V}_{(i)}$, while the identity $[\mathfrak{p}, \mathfrak{p}^\perp] = \mathfrak{p}^\perp$ implies that (2.1) is \mathfrak{p} -invariant. Moreover Lemma 2.4 allows us to choose a Cartan subalgebra $\mathfrak{t} \leq \mathfrak{g}$ and a simple subsystem Δ^0 with respect to which \mathfrak{p} is a standard parabolic, implying that $\mathfrak{z}(\mathfrak{p}^0) \leq \mathfrak{t}$ acts diagonally on \mathbb{V} and hence that the $\mathbb{V}_{(i)}$ are completely reducible.

The lowest filtration component \mathbb{V}_0 in (2.1) is sometimes called the *socle* of \mathbb{V} , with N the *height* of \mathbb{V} . Dually, the first graded component $H_0(\mathfrak{p}^\perp; \mathbb{V}) := \mathbb{V}_{(N)} = \mathbb{V}/(\mathfrak{p}^\perp \cdot \mathbb{V})$ is called the *top* of \mathbb{V} . The homological notation will be explained in Section 2.2.

Let $H^0(\mathfrak{p}^\perp; \mathbb{V}) := \{v \in \mathbb{V} \mid \alpha \cdot v = 0 \ \forall \alpha \in \mathfrak{p}^\perp\}$ denote the kernel of the \mathfrak{p}^\perp -action on \mathbb{V} , which is a \mathfrak{p} -subrepresentation of \mathbb{V} since $[\mathfrak{p}, \mathfrak{p}^\perp] = \mathfrak{p}^\perp$. We have the following relation between \mathfrak{g} -subrepresentations of \mathbb{V} and \mathfrak{p} -subrepresentations of $H^0(\mathfrak{p}^\perp; \mathbb{V})$.

Proposition 2.17. [60, Prop. 3.2.13] *There is a bijection between irreducible \mathfrak{g} -subrepresentations of \mathbb{V} and irreducible \mathfrak{p} -subrepresentations of $H^0(\mathfrak{p}^\perp; \mathbb{V})$. In particular if \mathbb{V} is the irreducible \mathfrak{g} -representation with lowest weight λ , then $H^0(\mathfrak{p}^\perp; \mathbb{V})$ is the irreducible \mathfrak{p} -representation with the same lowest weight. \square*

Corollary 2.18. $H^0(\mathfrak{p}^\perp; \mathbb{V})$ coincides with the socle \mathbb{V}_0 of the \mathfrak{p}^\perp -filtration (2.1).

Proof. Since the action of \mathfrak{p}^\perp preserves the \mathfrak{g} -irreducible components of \mathbb{V} , it suffices to consider the case that \mathbb{V} is an irreducible \mathfrak{g} -representation. Then $H^0(\mathfrak{p}^\perp; \mathbb{V})$ is an irreducible \mathfrak{p} -representation by Proposition 2.17. However \mathbb{V}_0 is a \mathfrak{p} -subrepresentation of $H^0(\mathfrak{p}^\perp; \mathbb{V})$ by construction, giving equality as claimed. \square

Then since $f \in \mathbb{V}_0^* = H^0(\mathfrak{p}^\perp; \mathbb{V}^*)$ if and only if $(\alpha \cdot f)(v) = -f(\alpha \cdot v) = 0$ for all $\alpha \in \mathfrak{p}^\perp$ and $v \in \mathbb{V}$, the socle \mathbb{V}_0^* of \mathbb{V}^* equals the annihilator of $\mathfrak{p}^\perp \cdot \mathbb{V}$. Therefore $(\mathbb{V}_0^*)^* \cong \mathbb{V}/(\mathfrak{p}^\perp \cdot \mathbb{V}) = H_0(\mathfrak{p}^\perp; \mathbb{V})$. Then if \mathbb{V} has highest weight λ as a \mathfrak{g} -representation, Proposition 2.17 implies immediately that $H_0(\mathfrak{p}^\perp; \mathbb{V})$ has highest weight λ as a \mathfrak{p} -representation, so that $H_0(\mathfrak{p}^\perp; \mathbb{V})$ is obtained by “putting the crosses in” to the Dynkin diagram of \mathbb{V} ; we shall interpret this homologically in Section 2.2.

Proposition 2.17 also allows us to compute the weight of an irreducible \mathfrak{p} -representation V as follows. Choosing data so as to identify \mathfrak{p} with the standard parabolic associated to a subset Σ of simple roots, the weight of V is given by the Σ -height $\text{ht}_\Sigma(\lambda)$ of the highest weight λ of V . Writing λ in terms of the fundamental weights using the inverse Cartan matrix C^{-1} of \mathfrak{g} , it follows easily that V has weight $\rho_{\mathfrak{p}}^\top C^{-1} \lambda$, where $\rho_{\mathfrak{p}}$ is the \mathfrak{p} -dominant weight with a one over each crossed node. Tables of the inverse Cartan matrices for complex simple Lie algebras may be found in [60, Tbl. B.4].

Example 2.19. Consider the standard parabolic subalgebra \mathfrak{p} of $\mathfrak{e}_6(\mathbb{C})$ and its irreducible representation V defined by

$$\mathfrak{p} = \begin{array}{c} \circ - \circ - \circ - \circ - \times \\ | \\ \circ \end{array} \quad \text{acting on} \quad \begin{array}{c} 1 \quad 0 \quad 3 \quad 0 \quad -5 \\ \circ - \circ - \circ - \circ - \times \\ | \\ \circ \quad 1 \end{array} = V.$$

Numbering the nodes of the Dynkin diagram “clockwise” starting with the left-most node, the weight of V is

$$\rho_{\mathfrak{p}}^{\top} C^{-1} \lambda = \frac{1}{3} (0 \ 0 \ 0 \ 0 \ 1 \ 0) \begin{pmatrix} 4 & 5 & 6 & 4 & 2 & 3 \\ 5 & 10 & 12 & 8 & 4 & 6 \\ 6 & 12 & 18 & 12 & 6 & 9 \\ 4 & 8 & 12 & 10 & 5 & 6 \\ 2 & 4 & 6 & 5 & 4 & 3 \\ 3 & 6 & 9 & 6 & 3 & 6 \end{pmatrix} \begin{pmatrix} 1 \\ 0 \\ 3 \\ 0 \\ -5 \\ 1 \end{pmatrix} = 1.$$

2.1.4 R-spaces and projective embeddings

Let G be a semisimple Lie group with Lie algebra \mathfrak{g} and recall that the adjoint action of G takes parabolic subalgebras to parabolic subalgebras.

Definition 2.20. An *R-space* for G is an adjoint orbit of parabolic subalgebras. An R-space is *symmetric* if its parabolic subalgebras are abelian.

The R-space $G \cdot \mathfrak{p}$ is also known as the *generalised flag manifold* G/P , where $P \leq G$ is a parabolic subgroup with Lie algebra \mathfrak{p} ; see [22]. The link is formalised as follows [44, Lem. 1.6].

Proposition 2.21. *Given an R-space $G \cdot \mathfrak{p}$, the stabiliser $P' := \text{Stab}_G \mathfrak{p}' \leq G$ of a parabolic $\mathfrak{p}' \in G \cdot \mathfrak{p}$ is a parabolic subgroup such that G/P' is diffeomorphic to $G \cdot \mathfrak{p}$. \square*

In the complex setting, this result can be stretched considerably further: then G/P is a compact projective Kähler manifold with a holomorphic G -action [60, §3.2.6]. In particular, the complex symmetric R-spaces are precisely the hermitian symmetric spaces of compact type for the maximal compact subgroup [44].

Suppose now that G is complex and connected, choose a Cartan subalgebra $\mathfrak{t} \leq \mathfrak{g}$ and a positive subsystem Δ^+ , and let V be an irreducible \mathfrak{g} -representation with highest weight $\lambda \in \mathfrak{t}^*$. Then $-\lambda$ is the lowest weight of the dual representation V^* , and since the weight space $V_{-\lambda}^*$ is 1-dimensional we obtain a well-defined point in $\mathbb{P}(V^*)$.

Proposition 2.22. *Let V be the irreducible \mathfrak{g} -representation of highest weight $\lambda \in \mathfrak{t}^*$. Then the stabiliser \mathfrak{p} of the lowest weight space in V^* is the standard parabolic defined by $\Sigma := \{\alpha \in \Delta^0 \mid \langle \lambda, \alpha \rangle \neq 0\}$, hence giving a projective embedding $G \cdot \mathfrak{p} \hookrightarrow \mathbb{P}(V^*)$.*

Sketch proof. We outline the proof from [60, Prop. 3.2.5]. The dual representation V^* has lowest weight $-\lambda$, so let $v_0 \in V_{-\lambda}^*$ be a lowest weight vector and define \mathfrak{p} to be

the stabiliser $\{X \in \mathfrak{g} \mid X \cdot V_{-\lambda}^* \subseteq V_{-\lambda}^*\}$ of $V_{-\lambda}^*$. It follows easily that \mathfrak{p} is the standard parabolic with corresponding subset $\Sigma := \{\alpha \in \Delta^0 \mid \mathfrak{g}_\alpha \not\leq \mathfrak{p}\}$.

Choose a simple root $\alpha \in \Delta^0$, and an \mathfrak{sl}_2 -triple $e \in \mathfrak{g}_\alpha$, $f \in \mathfrak{g}_{-\alpha}$ and $h := [e, f] \in \mathfrak{t}$. By considering the root reflection through α , one then shows that $e \cdot v_0 = 0$ if and only if $\langle \alpha, \lambda \rangle = 0$; since $\mathfrak{g}_\alpha \leq \mathfrak{p}$ if and only if $\mathfrak{g}_\alpha \cdot v_0 = 0$, the claimed form of Σ follows.

To obtain the projective embedding note that the adjoint action of $P := \text{Stab}_G \mathfrak{p}$ preserves $V_{-\lambda}^*$; we easily conclude that $P \leq \text{Stab}_G[v_0]$, which is actually an equality by Proposition 2.21. Therefore the holomorphic submersion $G \rightarrow G \cdot [v_0]$ given by $g \mapsto g \cdot [v_0] = [g \cdot v_0]$ factors to a holomorphic bijection $G \cdot \mathfrak{p} \cong G/P \rightarrow G \cdot [v_0]$, which is a diffeomorphism and hence a biholomorphism by compactness of G/P . \square

It is straightforward to determine the Dynkin notation for \mathfrak{p} from the highest weight $\lambda \in \mathfrak{t}^*$ of V . Given a simple root $\alpha \in \Delta^0$, the coefficient of the corresponding fundamental weight is $\frac{2\langle \lambda, \alpha \rangle}{\langle \alpha, \alpha \rangle}$, which is the number we write over the node of the Dynkin diagram. Thus $\langle \lambda, \alpha \rangle \neq 0$ if and only if there is a non-zero coefficient over that node, meaning \mathfrak{p} is given by crossing nodes in the support of λ .

Corollary 2.23. *There is a projective embedding $G \cdot \mathfrak{p} \hookrightarrow \mathbb{P}(V^*)$ for any irreducible \mathfrak{g} -representation V whose highest weight is supported on the crossed nodes of \mathfrak{p} .* \square

Example 2.24. Consider the R-space $G \cdot \mathfrak{p} = \circ \cdots \circ \text{---} \times \text{---} \circ \cdots \circ$ of $\mathfrak{g} = \mathfrak{sl}(n+1, \mathbb{C})$, where we have crossed the k th node. The corresponding fundamental representation is the exterior power $\wedge_{\mathbb{C}}^k \mathbb{C}^{n+1}$ of the standard representation of \mathfrak{g} on \mathbb{C}^{n+1} . If $\{e_i\}_i$ and $\{\varepsilon^i\}_i$ are the standard dual bases of \mathbb{C}^{n+1} and \mathbb{C}^{n+1*} then $v^k := \varepsilon^1 \wedge \cdots \wedge \varepsilon^k \in \wedge_{\mathbb{C}}^k \mathbb{C}^{n+1*}$ is a lowest weight vector for \mathfrak{g} , and the stabiliser of the line through v^k coincides with the stabiliser of the k -dimensional subspace $\langle \varepsilon^1, \dots, \varepsilon^k \rangle \leq \mathbb{C}^{n+1*}$. Thus $G \cdot \mathfrak{p}$ is the complex grassmannian $\text{Gr}_k(\mathbb{C}^{n+1*}) \cong \text{Gr}_{n+1-k}(\mathbb{C}^{n+1})$. In particular $k = n$ gives the grassmannian of hyperplanes in \mathbb{C}^{n+1*} , which is just $\mathbb{C}\mathbb{P}^n$.

Notice that there is a minimal projective embedding $G \cdot \mathfrak{p} \hookrightarrow \mathbb{P}(V^*)$, defined by taking V to be the irreducible \mathfrak{g} -representation whose highest weight has a one over each crossed node of \mathfrak{p} . Generally speaking, choosing V to have a strictly larger weight results in $G \cdot \mathfrak{p}$ having larger codimension in $\mathbb{P}(V^*)$. Thanks to a result of Kostant, it is possible to describe the image of $G \cdot \mathfrak{p}$ inside $\mathbb{P}(V^*)$ as an intersection of quadrics.⁴

For this, recall that the Cartan square $\odot^2 V^*$ is the highest weight subrepresentation of $S^2 V^*$ and appears with multiplicity one. Viewing $S^2 V$ as the space of homogeneous quadratic polynomials on V^* , the projection $S^2 V^* \twoheadrightarrow U^* := S^2 V^* / \odot^2 V^*$ is dual to the inclusion $U \hookrightarrow S^2 V$, which identifies $U \leq S^2 V$ with the annihilator of $\odot^2 V^*$.

⁴Kostant never published this result, and it appears (with attribution) in [122, 128]; also see [158, p. 368]. The author is grateful to Fran Burstall for his patient explanation of Kostant's results.

Now if $v_0 \in V_{-\lambda}^*$ is a lowest weight vector for \mathfrak{g} and $[v] \in G \cdot [v_0]$, we have $v = g \cdot v_0$ for some $g \in G$ and hence $v \otimes v = (g \cdot v_0) \otimes (g \cdot v_0) = g \cdot (v_0 \otimes v_0)$. Since $v_0 \otimes v_0$ is a lowest weight vector for $\odot^2 V^*$, this gives an inclusion

$$G \cdot [v_0] \subseteq \{v \in V^* \mid f(v \otimes v) = 0 \ \forall f \in U\} \quad (2.2)$$

of $G \cdot \mathfrak{p} \cong G \cdot [v_0]$ into the intersection of quadrics cut out by U . By computing the action of Casimir elements it is possible to deduce that (2.2) is an equality, hence describing exactly which quadratic equations cut out $G \cdot \mathfrak{p}$ inside $\mathbb{P}(V^*)$.

Theorem 2.25 (Kostant). *Suppose that G is a complex semisimple Lie group with Lie algebra \mathfrak{g} , and let V be an irreducible \mathfrak{g} -representation of highest weight λ . Let $G \cdot [v_0]$ denote the lowest weight orbit in V^* and let $U \leq S^2 V$ be the annihilator of $\odot^2 V^*$. Then:*

- (1) $G \cdot [v_0]$ is the intersection of quadrics cut out by U , so that (2.2) is an equality.
- (2) The ideal of $G \cdot [v_0]$ is generated by U .
- (3) The homogeneous coordinate ring of $G \cdot [v_0]$ is $\odot^\bullet V := \bigoplus_{i=0}^{\infty} \odot^i V$. □

Example 2.26. Continuing notation from Example 2.24, consider the resulting embedding $G \cdot \mathfrak{p} \hookrightarrow \mathbb{P}(\wedge_{\mathbb{C}}^k \mathbb{C}^{n+1*})$ which identifies \mathfrak{p} with the stabiliser $\langle \varepsilon^1, \dots, \varepsilon^k \rangle \leq \mathbb{C}^{n+1*}$. In the case $k = n$ we have $G \cdot \mathfrak{p} = \mathbb{C}\mathbb{P}^n$, and the Cartan square of $\wedge_{\mathbb{C}}^n \mathbb{C}^{n+1*} \cong \mathbb{C}^{n+1}$ coincides with its symmetric square, representing the fact that $\mathbb{C}\mathbb{P}^n \hookrightarrow \mathbb{P}(\mathbb{C}^{n+1})$ is the minimal projective embedding. In the case $k = n - 1$ we have $G \cdot \mathfrak{p} = \text{Gr}_2(\mathbb{C}^{n+1})$, with

$$S^2 \wedge^{n-1} \mathbb{C}^{n+1} = S^2 \left(\begin{array}{ccccccc} 0 & 0 & & 0 & 1 & 0 \\ \circ - \circ & \dots & \circ - \circ & \circ - \circ & \circ - \circ & \circ - \circ & \circ - \circ \end{array} \right) = \begin{array}{ccccccc} 0 & 0 & & 0 & 2 & 0 \\ \circ - \circ & \dots & \circ - \circ & \circ - \circ & \circ - \circ & \circ - \circ & \circ - \circ \end{array} \oplus \begin{array}{ccccccc} 0 & 0 & & 0 & 1 & 0 & 0 & 0 \\ \circ - \circ & \dots & \circ - \circ & \circ - \circ & \circ - \circ & \circ - \circ & \circ - \circ & \circ - \circ \end{array} .$$

$\odot^2 \wedge^{n-1} \mathbb{C}^{n+1} \qquad U = \wedge^{n-3} \mathbb{C}^{n+1}$

Identifying $U \cong \wedge^4 \mathbb{C}^{n+1*}$, we see that $G \cdot [v_0]$ consists of those elements $[v] \in \mathbb{P}(\wedge^2 \mathbb{C}^{n+1})$ for which $v \wedge v = 0$, which is just the Plücker embedding $\text{Gr}_2(\mathbb{C}^{n+1}) \hookrightarrow \mathbb{P}(\wedge^2 \mathbb{C}^{n+1})$.

2.2 Lie algebra homology and cohomology

Lie algebra homology and cohomology were introduced by Kostant [119] to provide an algebraic backdrop for the Bott–Borel–Weil theorem, which computes the sheaf cohomology of generalised flag manifolds [22, 70]. Parabolic geometries are modelled on such manifolds, so we shall be interested in a “curved” analogue of Kostant’s results provided by [49, 61]. We introduce the necessary definitions and basic results in Subsection 2.2.1, before outlining the description of the Hasse diagram and Kostant’s version of the Bott–Borel–Weil theorem in Subsection 2.2.2.

2.2.1 Basic definitions

Let \mathfrak{g} be any Lie algebra and V a \mathfrak{g} -representation. We define the space $C_k(\mathfrak{g}; V) := \wedge^k \mathfrak{g} \otimes V$ of k -chains on \mathfrak{g} with values in V and a *boundary map*

$$\begin{aligned} \partial : C_k(\mathfrak{g}; V) &\rightarrow C_{k-1}(\mathfrak{g}; V) \\ \beta \otimes v &\mapsto \sum_i (\beta \lrcorner \varepsilon^i) \otimes (e_i \cdot v) + \sum_{i < j} [e_i, e_j] \wedge ((\beta \lrcorner \varepsilon^i) \lrcorner \varepsilon^j) \otimes v, \end{aligned}$$

where $\{e_i\}_i$ is a basis of \mathfrak{g} with dual basis $\{\varepsilon^i\}_i$. It can be checked directly [49, Lem. 3.2] that ∂ is independent of the choice of basis and satisfies $\partial^2 = 0$, so that $(C_\bullet(\mathfrak{g}; V), \partial)$ forms a chain complex.

Definition 2.27. The homology $H_\bullet(\mathfrak{g}; V)$ of $(C_\bullet(\mathfrak{g}; V), \partial)$ is called the *Lie algebra homology* of \mathfrak{g} with values in V .

In particular, the zeroth homology $H_0(\mathfrak{g}; V) = V/(\mathfrak{g} \cdot V)$ is the space of *co-invariants* of V . Evidently $C_k(\mathfrak{g}; V)$ carries a natural action of \mathfrak{g} given by extending the adjoint action of \mathfrak{g} on itself by the representation V . Moreover it is clear that ∂ is \mathfrak{g} -equivariant, so there is an induced representation on $H_k(\mathfrak{g}; V)$.

Now suppose that \mathfrak{g} is semisimple, $\mathfrak{p} \leq \mathfrak{g}$ is parabolic and V is a \mathfrak{g} -representation. Since $[\mathfrak{p}, \mathfrak{p}^\perp] = \mathfrak{p}^\perp$, the chain space $C_k(\mathfrak{p}^\perp; V)$ is naturally a \mathfrak{p} -representation.

Lemma 2.28. [49, Lem. 3.3] $\partial : C_k(\mathfrak{p}^\perp; V) \rightarrow C_{k-1}(\mathfrak{p}^\perp; V)$ is \mathfrak{p} -equivariant, so that there is a natural representation of \mathfrak{p} on $H_k(\mathfrak{p}^\perp; V)$. \square

For \mathfrak{g} simple and \mathfrak{p} abelian, Lemma 2.13 immediately yields the following.

Corollary 2.29. Let \mathfrak{g} be simple with abelian parabolic \mathfrak{p} . Then $H_0(\mathfrak{p}^\perp; \mathfrak{g}) = \mathfrak{g}/\mathfrak{p}$. \square

Lie algebra cohomology may be defined by a dual approach. For any Lie algebra \mathfrak{g} , the space $C^k(\mathfrak{g}; V) := \wedge^k \mathfrak{g}^* \otimes V$ of k -cochains on \mathfrak{g} with values in V may be identified with $C_k(\mathfrak{g}; V^*)^*$, with *differential*⁵

$$\begin{aligned} \partial^* : C^{k-1}(\mathfrak{g}; V) &\rightarrow C^k(\mathfrak{g}; V) \\ \beta \otimes v &\mapsto \sum_i \varepsilon^i \wedge \beta \otimes (e_i \cdot v) + \sum_{i < j} \varepsilon^i \wedge \varepsilon^j \wedge ([e_j, e_i] \lrcorner \beta) \otimes v \end{aligned}$$

given by (minus) the transpose of $\partial : C_k(\mathfrak{g}; V^*) \rightarrow C_{k-1}(\mathfrak{g}; V^*)$. Then $(\partial^*)^2 = 0$ again, so that $(C^k(\mathfrak{g}; V), \partial^*)$ is a cochain complex whose cohomology $H^\bullet(\mathfrak{g}; V)$ is called the *Lie algebra cohomology* of \mathfrak{g} with values in V . In particular, the zeroth cohomology $H^0(\mathfrak{g}; V)$ is the kernel of the \mathfrak{g} -action on V .

⁵Note that our use of ∂, ∂^* is reversed compared to some authors' conventions: one often sees $\partial : C^{k-1}(\mathfrak{g}; V) \rightarrow C^k(\mathfrak{g}; V)$ as the differential and $\partial^* : C_k(\mathfrak{g}; V) \rightarrow C_{k-1}(\mathfrak{g}; V)$ as the boundary map.

Returning to the case that \mathfrak{g} is semisimple and $\mathfrak{p} \leq \mathfrak{g}$ is parabolic, the duality $(\mathfrak{g}/\mathfrak{p})^* \cong \mathfrak{p}^\perp$ induced by the Killing form means that $C^k(\mathfrak{p}^\perp; V) \cong C_k(\mathfrak{g}/\mathfrak{p}; V)$. Choosing a parabolic $\hat{\mathfrak{p}}$ opposite to \mathfrak{p} , it follows that $\partial^* : C^{k-1}(\mathfrak{p}^\perp; V) \rightarrow C^k(\mathfrak{p}^\perp; V)$ is $\hat{\mathfrak{p}}$ -equivariant (but notably *not* \mathfrak{p} -equivariant). Therefore $H^k(\mathfrak{p}^\perp; V)$ is not naturally a \mathfrak{p} -representation, but only a \mathfrak{p}^0 -representation with respect to the chosen algebraic Weyl structure. For this reason, we prefer to work with homology over cohomology.

Continuing to work with an algebraic Weyl structure, it is possible to find positive definite inner products on \mathfrak{g} and V with respect to which $\partial : C_k(\mathfrak{p}^\perp; V) \rightarrow C_{k-1}(\mathfrak{p}^\perp; V)$ is (minus) the adjoint of $\partial^* : C_{k-1}(\mathfrak{p}^\perp; V) \rightarrow C_k(\mathfrak{p}^\perp; V)$, where here and below we use that $C_k(\mathfrak{p}^\perp; V) = C^k(\mathfrak{g}/\mathfrak{p}; V)$. This allows us to define a laplacian-like operator [119].

Definition 2.30. The \mathfrak{p}^0 -homomorphism $\square := \partial\partial^* + \partial^*\partial : C_k(\mathfrak{p}^\perp; V) \rightarrow C_k(\mathfrak{p}^\perp; V)$ is called the *algebraic laplacian*.

Kostant proves [119, Prop. 2.1] that \square also induces a Hodge decomposition

$$C_k(\mathfrak{p}^\perp; V) = \text{im } \partial \oplus \ker \square \oplus \text{im } \partial^*, \quad (2.3)$$

of chain spaces, where $\ker \partial = \text{im } \partial \oplus \ker \square$ and $\ker \partial^* = \ker \square \oplus \text{im } \partial^*$; also see [60, §3.3.1] Consequently $H_k(\mathfrak{p}^\perp; V) \cong \ker \square$, identifying homology classes with harmonic representatives in $\ker \square = \ker \partial \cap \ker \partial^*$. In particular we have isomorphisms

$$H_k(\mathfrak{p}^\perp; V) \cong H^k(\mathfrak{g}/\mathfrak{p}; V) \cong H_k(\mathfrak{g}/\mathfrak{p}; V^*)^* \cong H^k(\mathfrak{p}^\perp; V^*)^* \quad (2.4)$$

of \mathfrak{p}^0 -representations for all $k \in \mathbb{Z}$; see [49, p. 12].

2.2.2 Computation of homology components

Given a \mathfrak{g} -representation V , it will often be useful to compute the \mathfrak{p}^0 -irreducible components of $H_k(\mathfrak{p}^\perp; V)$ explicitly. We saw how to do this for $H_0(\mathfrak{p}^\perp; V)$ in Subsection 2.1.3: it is the top of the \mathfrak{p}^\perp -filtration of V , so is the \mathfrak{p} -representation with highest weight given by “putting the crosses in”. For arbitrary degree, the Hodge decomposition (2.3) implies that the \mathfrak{p}^0 -irreducible components of $H_k(\mathfrak{p}^\perp; V)$ may be identified with the \mathfrak{p}^0 -irreducible components of $C_k(\mathfrak{p}^\perp; V)$ which lie in the kernel of \square .

If V has highest weight $\lambda \in \mathfrak{t}^*$ for \mathfrak{g} , we may restrict V to a \mathfrak{p}^0 -representation and decompose into irreducible \mathfrak{p}^0 -subrepresentations. The subspace V^μ generated by all highest weight vectors of weight $\mu \in \mathfrak{t}^*$ for \mathfrak{p}^0 is called the *μ -isotypical component*; evidently only finitely many isotypical components are non-zero. One can show that V is the direct sum of its isotypical components, with V^μ isomorphic to a direct sum of a number of copies of the irreducible representation with highest weight μ [60, §2.2.14]. The action of \square on V^μ is given by Kostant’s spectral theorem [119]; see also [62].

Theorem 2.31. *Let V be an irreducible \mathfrak{g} -representation of highest weight λ . Then $\square : C_k(\mathfrak{p}^\perp; V) \rightarrow C_k(\mathfrak{p}^\perp; V)$ acts on the μ -isotypical component of $C_k(\mathfrak{p}^\perp; V)$ by multiplication by $-\frac{1}{2}(\|\lambda + \rho_{\mathfrak{g}}\|^2 - \|\mu + \rho_{\mathfrak{g}}\|^2)$, where $\rho_{\mathfrak{g}}$ is the lowest form of \mathfrak{g} .⁶ \square*

To analyse the resulting weight condition $\|\lambda + \rho_{\mathfrak{g}}\| = \|\mu + \rho_{\mathfrak{g}}\|$, it is necessary to introduce some machinery called the *Hasse diagram* of \mathfrak{p} . We shall not need the details, so only give a synopsis; see [22, 60] for details.

First observe that the Weyl group $\mathcal{W}_{\mathfrak{g}}$ of \mathfrak{g} may be given the structure of a directed graph, with vertices the elements of $\mathcal{W}_{\mathfrak{g}}$ and an edge $w \xrightarrow{\alpha} w'$ if and only if $\ell(w') = \ell(w) + 1$ and $w' = \sigma_{\alpha}w$ for some $\alpha \in \Delta^+$. Moreover since $\mathcal{W}_{\mathfrak{g}}$ acts transitively on the set of Weyl chambers, the vertex set of $\mathcal{W}_{\mathfrak{g}}$ is in bijection with the Weyl orbit of $\rho_{\mathfrak{g}} \in \mathfrak{t}^*$. Thus, considering the form of the Cartan matrix, all elements of $\mathcal{W}_{\mathfrak{g}}$ are obtained by repeatedly applying the simple root reflection rules from Figure 2.1 to $\rho_{\mathfrak{g}}$; see [22, §4.1].

Now suppose that $\mathfrak{p} \leq \mathfrak{g}$ is a standard parabolic corresponding to a subset $\Sigma \subseteq \Delta^0$ and let $\mathcal{W}_{\mathfrak{p}}$ be the Weyl group of the semisimple part of \mathfrak{p}^0 , which may be naturally viewed as a subgraph of $\mathcal{W}_{\mathfrak{g}}$. The *Hasse diagram* $\mathcal{W}^{\mathfrak{p}}$ of \mathfrak{p} is the subgraph of $\mathcal{W}_{\mathfrak{g}}$ with vertices the elements whose action sends any \mathfrak{g} -dominant weight to a \mathfrak{p} -dominant weight. By [119, Prop. 5.13], every $w \in \mathcal{W}_{\mathfrak{g}}$ may be written as $w = w_{\mathfrak{p}}w^{\mathfrak{p}}$ for elements $w_{\mathfrak{p}} \in \mathcal{W}_{\mathfrak{p}}$ and $w^{\mathfrak{p}} \in \mathcal{W}^{\mathfrak{p}}$ of minimal length. Moreover the stabiliser of the lowest form $\rho_{\mathfrak{p}}$ of \mathfrak{p} in $\mathcal{W}_{\mathfrak{g}}$ is precisely $\mathcal{W}_{\mathfrak{p}}$, so that the Weyl orbit of $\rho_{\mathfrak{p}}$ is in bijection with the vertex set of $\mathcal{W}^{\mathfrak{p}}$. Thus the vertices of the Hasse diagram may be computed by repeatedly applying simple reflections to $\rho_{\mathfrak{p}}$.

$$\begin{aligned} \sigma_{\alpha_i} \left(\cdots \overset{a}{\circ} \overset{b}{\circ} \overset{c}{\circ} \cdots \right) &= \cdots \overset{a+b}{\circ} \overset{-b}{\circ} \overset{b+c}{\circ} \cdots \\ \sigma_{\alpha_i} \left(\cdots \overset{a}{\circ} \overset{b}{\circ} \overset{c}{\circ} \cdots \right) &= \cdots \overset{a+b}{\circ} \overset{-b}{\circ} \overset{2b+c}{\circ} \cdots \\ \sigma_{\alpha_i} \left(\cdots \overset{a}{\circ} \overset{b}{\circ} \overset{c}{\circ} \cdots \right) &= \cdots \overset{a+b}{\circ} \overset{-b}{\circ} \overset{b+c}{\circ} \cdots \end{aligned}$$

Figure 2.1: Recipes for performing a simple root reflection at the central node. If b is the coefficient that node, we add b to adjacent nodes, with multiplicity if there are multiple edges, and then replace b by $-b$.

Example 2.32. The first few columns of the Hasse diagram of the parabolic $\mathfrak{p} \leq \mathfrak{g} = \mathfrak{e}_6(\mathbb{C})$ from Example 2.19 are given in the first diagram of Figure 2.2, where the edges are labelled by the node number corresponding to the simple reflection.

⁶The *lowest form* $\rho_{\mathfrak{g}}$ of \mathfrak{g} is the sum of the fundamental weights of \mathfrak{g} , so is represented by a one over each node of the Dynkin diagram.

A careful analysis of the weight condition $\|\lambda + \rho_{\mathfrak{g}}\| = \|\mu + \rho_{\mathfrak{g}}\|$ now leads to Kostant's version of the Bott–Borel–Weil theorem [119, Thm. 5.14], which calculates the irreducible components of $H_{\bullet}(\mathfrak{p}^{\perp}; V)$ using the Hasse diagram of \mathfrak{p} . For notational convenience, we define the *affine action* of $\mathcal{W}_{\mathfrak{g}}$ on weights by $w \cdot \mu := w(\mu + \rho_{\mathfrak{g}}) - \rho_{\mathfrak{g}}$.

Theorem 2.33. *Let V a complex irreducible \mathfrak{g} -representation with highest weight λ and consider the μ -isotypical component $H_{\bullet}(\mathfrak{p}^{\perp}; V)^{\mu}$ of $H_{\bullet}(\mathfrak{p}^{\perp}; V)$. Then:*

- (1) $H_{\bullet}(\mathfrak{p}^{\perp}; V)^{\mu} \neq 0$ if and only if $\mu = w \cdot \lambda$ for some $w \in \mathcal{W}^{\mathfrak{p}}$.
- (2) Each isotypical component $H_{\bullet}(\mathfrak{p}^{\perp}; V)^{w \cdot \lambda}$ is irreducible, and the multiplicity of $w \cdot \lambda$ as a weight of $C_{\bullet}(\mathfrak{p}^{\perp}; V)$ is one.
- (3) The component $H_{\bullet}(\mathfrak{p}^{\perp}; V)^{w \cdot \lambda}$ is contained in $H_{\ell(w)}(\mathfrak{p}^{\perp}; V)$. □

Therefore the set of \mathfrak{p}^0 -irreducible components of $H_{\bullet}(\mathfrak{p}^{\perp}; V)$ is in bijection with the vertex set of $\mathcal{W}^{\mathfrak{p}}$. The calculation of the \mathfrak{p}^0 -irreducible components of $H_k(\mathfrak{p}^{\perp}; V)$ is now completely algorithmic: first, determine the Hasse diagram of \mathfrak{p} up to the $(k + 1)$ st column; for each weight in this column, take a sequence leading back to $\rho_{\mathfrak{p}}$ labelled from left-to-right by simple roots $\alpha_{i_1}, \dots, \alpha_{i_k}$; then the corresponding component of $H_k(\mathfrak{p}^{\perp}; V)$ has highest weight given by the affine action $\alpha_{i_1} \cdot (\dots \alpha_{i_k} \cdot \lambda) = (\alpha_{i_1} \dots \alpha_{i_k}) \cdot \lambda$ applied to the \mathfrak{p} -dominant weight induced by λ .

Example 2.34. Continuing notation from Example 2.32, we can compute the homology $H_{\bullet}(\mathfrak{p}^{\perp}; \mathfrak{g})$ valued in the adjoint representation of \mathfrak{g} . The components of $H_{\bullet}(\mathfrak{p}^{\perp}; \mathfrak{g})$ up to degree five are given in the corresponding column of the second diagram of Figure 2.2, where we have retained the arrow labelling from Example 2.32 purely for clarity.

Finally, it is straightforward to extend Theorem 2.33 to other cases of interest; we summarise the results from [60, Prop. 3.3.6]. Firstly for a family $\{V_i\}_{i \in I}$ of complex irreducible \mathfrak{g} -representations, there is a natural \mathfrak{p} -representation isomorphism $H_k(\mathfrak{p}^{\perp}; \bigoplus_{i \in I} V_i) \cong \bigoplus_{i \in I} H_k(\mathfrak{p}^{\perp}; V_i)$ for each degree k . If on the other hand $\mathfrak{g}_1, \mathfrak{g}_2$ are complex semisimple Lie algebras with parabolic subalgebras $\mathfrak{p}_i \leq \mathfrak{g}_i$ and irreducible representations V_i , the external tensor product $V_1 \boxtimes V_2$ is an irreducible representation of $\mathfrak{g}_1 \oplus \mathfrak{g}_2$ for which

$$H_k(\mathfrak{p}_1^{\perp} \oplus \mathfrak{p}_2^{\perp}; V_1 \boxtimes V_2) \cong \bigoplus_{i+j=k} (H_i(\mathfrak{p}_1^{\perp}; V_1) \boxtimes H_j(\mathfrak{p}_2^{\perp}; V_2))$$

as a representation of $\mathfrak{p}_1 \oplus \mathfrak{p}_2$.

If now \mathfrak{g} is a real semisimple Lie algebra and V a complex \mathfrak{g} -representation, it is easy to see that the complexification of the real homology $H_k(\mathfrak{p}^{\perp}; V)$ is naturally isomorphic to the complex homology $H_k(\mathfrak{p}_{\mathbb{C}}^{\perp}; V)$ as a representation of $\mathfrak{p} \leq \mathfrak{p}_{\mathbb{C}}$. If on the other hand

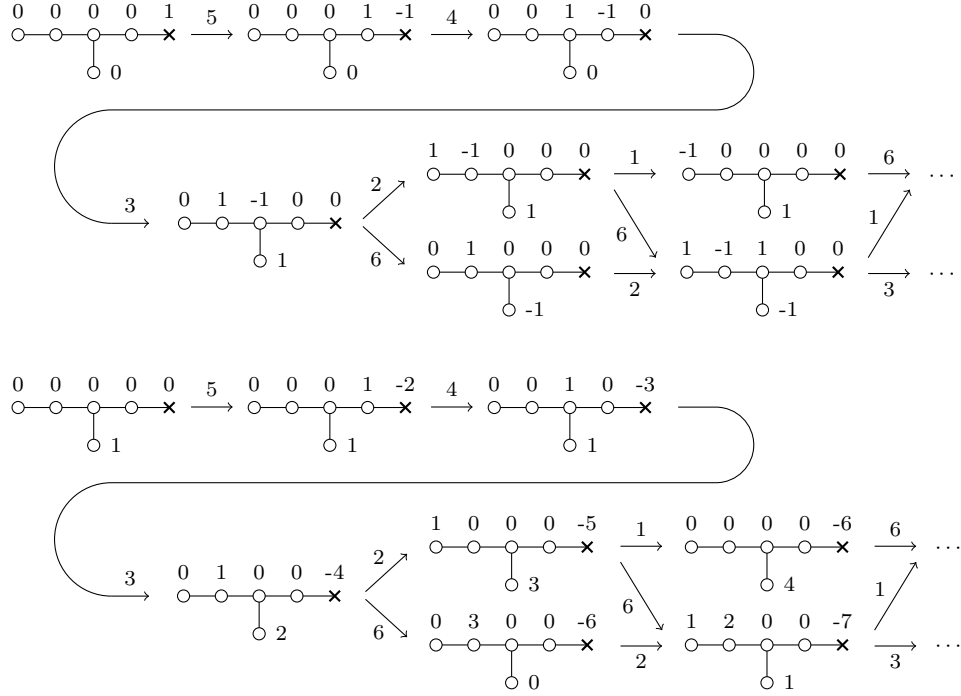

Figure 2.2: TOP: the Hasse diagram of the parabolic subalgebra of $\mathfrak{e}_6(\mathbb{C})$ from Example 2.32. BOTTOM: The components of the homology of the adjoint representation of $\mathfrak{e}_6(\mathbb{C})$ from Example 2.34, up to degree five.

V is a real representation, there is a natural isomorphism $H_k(\mathfrak{p}^\perp; V)_{\mathbb{C}} \cong H_k(\mathfrak{p}_{\mathbb{C}}^\perp; V_{\mathbb{C}})$ of $\mathfrak{p}_{\mathbb{C}}$ -representations and one of two cases may occur. Indeed, for simplicity assume that V is irreducible and admits no \mathfrak{g} -invariant complex structure, and let $W \leq H_k(\mathfrak{p}_{\mathbb{C}}^\perp; V_{\mathbb{C}})$ be a $\mathfrak{p}_{\mathbb{C}}$ -irreducible subrepresentation. Then either:

- $W = \overline{W}$ is the complexification of a real irreducible component of $H_k(\mathfrak{p}^\perp; V)$; or
- \overline{W} is an irreducible subrepresentation of $H_k(\mathfrak{p}_{\mathbb{C}}^\perp; V_{\mathbb{C}})$, with $W \oplus \overline{W}$ the complexification of a single complex irreducible component in $H_k(\mathfrak{p}^\perp; V)$.

In either case, no irreducible component of the real homology $H_k(\mathfrak{p}^\perp; V)$ admits a quaternionic structure. We shall see applications of these results in later chapters.

Background from parabolic geometry

Having described the structure theory of parabolic subalgebras, we turn now to Cartan geometries and parabolic geometries. We shall assume that the reader is familiar with the basic concepts of differential geometry, such as vector bundles, principal bundles and principal connections; see [29, 79, 113, 114, 124, 125, 165] for comprehensive accounts. Unless stated otherwise, all objects will be assumed to be smooth and all principal bundles carry right actions. Given a manifold M and a vector bundle $E \rightarrow M$, the space of sections of $\wedge^k T^*M \otimes E$ will be denoted by $\Omega^k(M; E)$.

Intuitively, a Cartan geometry is a curved analogue of a homogeneous space, while a parabolic geometry is a Cartan geometry modelled on a generalised flag manifold. Then the theory of parabolic subalgebras developed in Chapter 2 imbues a parabolic geometry with a rich algebraic structure, which (in most circumstances) can be exploited to obtain an equivalence of categories between parabolic geometries of a certain type and simpler underlying geometric structures; we describe this in Section 3.1. There is also a well-developed theory of invariant differential operators on parabolic geometries, which will be important for us in later chapters; we describe this theory in Section 3.3.

3.1 Cartan geometries and parabolic geometries

We begin by reviewing the basic theory of Cartan geometries and parabolic geometries in Subsections 3.1.1 and 3.1.2, from the modern perspective of principal bundles and principal connections. This differs from Cartan's original approach [63, 64, 65] which was phrased in terms of gauge transformations [165, §5.1].

3.1.1 Cartan geometries

Let G be a (real) Lie group with Lie subgroup $P \leq G$, and let $\mathfrak{p} \leq \mathfrak{g}$ be their Lie algebras. The left-invariant vector fields on G induce a naturally defined trivialisation

$TG \cong G \times \mathfrak{g}$, whose inverse can be conveniently encoded in a canonical \mathfrak{g} -valued 1-form $\omega^G \in \Omega^1(G; \mathfrak{g})$ called the *Maurer–Cartan form* of G , defined by $\omega_g^G(\xi) := L_{g^{-1}*}(\xi)$ for all $g \in G$ and $\xi \in T_g G$. Clearly ω^G reproduces the generators of left-invariant vector fields and defines an isomorphism $T_g G \cong \mathfrak{g}$ for each $g \in G$, and moreover we have the *Maurer–Cartan equation* $d\omega^G + \frac{1}{2}[\omega^G \wedge \omega^G] = 0$. Viewing this as a “zero curvature” condition on the canonical principal P -bundle $G \rightarrow G/P$,¹ a Cartan geometry is a curved geometry modelled locally on the homogeneous space G/P .

Definition 3.1. A *Cartan geometry* $(F^P \rightarrow M, \omega)$ of type G/P on a manifold M of dimension $\dim M = \dim(G/P)$ is a principal P -bundle $p : F^P \rightarrow M$, called the *Cartan bundle*, equipped with a \mathfrak{g} -valued 1-form $\omega \in \Omega^1(F^P; \mathfrak{g})$, called the *Cartan connection*, such that:

- (1) ω is P -invariant, *i.e.* $R_g^* \omega = \text{Ad}(g^{-1})\omega$ for all $g \in P$;
- (2) $\omega(X^\xi) = \xi$ for all fundamental vector fields $X^\xi \in \Omega^0(F^P; TF^P)$ with $\xi \in \mathfrak{p}$; and
- (3) ω_u defines a linear isomorphism $T_u F^P \rightarrow \mathfrak{g}$ at each $u \in F^P$.

The homogeneous space G/P with its Maurer–Cartan form $\omega^G \in \Omega^1(G; \mathfrak{g})$ is called the *flat model* of the Cartan geometry. We refer to item (3) as the *Cartan condition*.

A principal P -bundle $F^P \rightarrow M$ does not determine a unique Cartan condition. Indeed, the possible Cartan connections on F^P form an open subset of an affine space modelled on the P -invariant horizontal subspace of $\Omega^1(F^P; \mathfrak{g})$; see [60, §1.5.2].

Example 3.2. (1) Let G be the euclidean group $O(n) \times \mathbb{R}^n$, and let $P = O(n)$. Since a P -structure is a riemannian metric g , a Cartan geometry of type G/P is equivalent [165, §6.3] to a principal P -connection on the orthonormal frame bundle of g , and hence a metric connection on TM . If torsion-free, this connection coincides with the Levi-Civita connection of g .

(2) Let $G = \text{SO}(n+1, 1)$ be the Lorentz group. Inside $\mathbb{R}^{n+1, 1}$ is the light-cone of non-zero null vectors, whose projectivisation is the conformal n -sphere \mathbb{S}^n . The action of G on $\mathbb{R}^{n+1, 1}$ preserves the light-cone, so descends to an action on \mathbb{S}^n which identifies G with the Möbius group of conformal transformations of \mathbb{S}^n . The pointwise stabiliser of this action is a subgroup P isomorphic to $\text{CO}(n) \times \mathbb{R}^{n*}$, which identifies \mathbb{S}^n with the homogeneous space G/P . Using the lorentzian metric on $\mathbb{R}^{n+1, 1}$, a Cartan geometry of type G/P induces a conformal connection on TM . A careful treatment of conformal geometry as a Cartan geometry may be found in [43, 60, 165].

Suppose that $F \rightarrow M$ is any principal P -bundle. The following definition is standard but of vital importance to later developments.

¹But note that ω^G is not a principal P -connection, since it is \mathfrak{g} -valued rather than \mathfrak{p} -valued.

Definition 3.3. Let V be a P -representation. The *associated bundle* $V_M := F \times_P V$ is the quotient of $F \times V$ by the right P -action defined by $(u, v) \cdot g := (u \cdot g, g^{-1} \cdot v)$.

Then V_M is a vector bundle over M with standard fibre V . Moreover the map $\Omega^0(F; V)^P \rightarrow \Omega^0(M; V_M)$ given by mapping a P -equivariant function $f : F \rightarrow V$ to the section s of V_M defined by $s(p(u)) := [u, f(u)]$, the class of $(u, f(u))$ in V_M , is an isomorphism. We may then think of sections of V_M as P -equivariant functions $F \rightarrow V$.

For a Cartan geometry $(F^P \rightrightarrows M, \omega)$, the Cartan condition allows us to identify many geometric bundles with bundles associated to F^P , hence linking the geometry of F^P with the geometry of M . As a fundamental example, item (3) above determines a trivialisation $TF^P \cong F^P \times \mathfrak{p}$, while (2) implies that the vertical bundle of $F^P \rightrightarrows M$ may be identified with $\mathfrak{p}_M = F^P \times_P \mathfrak{g}$. In this picture the fundamental vector fields generating the P -action are $X^\xi = \omega^{-1}(\xi)$ for $\xi \in \mathfrak{p}$, so the natural trivialisation of the vertical bundle is provided by the *constant vector fields* $\omega^{-1}(\xi)$ for $\xi \in \mathfrak{p}$; on the flat model these fields are just the left-invariant vector fields on $F^P = G$. Moreover, differential forms on F^P are determined uniquely by their values on the $\omega^{-1}(\xi)$.

Items (1) and (3) of Definition 3.1 also imply that $\omega_u : T_u F^P \rightarrow \mathfrak{g}$ descends to an isomorphism $\omega_u \bmod \mathfrak{p} : T_{p(u)} M \rightarrow \mathfrak{g}/\mathfrak{p}$ for each $u \in F^P$, thus identifying TM with the associated bundle $(\mathfrak{g}/\mathfrak{p})_M = F^P \times_P \mathfrak{g}/\mathfrak{p}$. This means that M inherits the “first order” geometry of G/P . By functoriality of the associated bundle construction, this also identifies all tensor bundles with associated bundles.

Definition 3.4. The *curvature* of a Cartan geometry $(F^P \rightrightarrows M, \omega)$ on M is the \mathfrak{g} -valued 2-form

$$K := d\omega + \frac{1}{2}[\omega \wedge \omega] \in \Omega^2(F^P; \mathfrak{g}).$$

A Cartan geometry is *flat* if its curvature vanishes identically.

Via the isomorphism between sections of associated bundles and P -equivariant functions, K induces a *curvature function* $\kappa : F^P \rightarrow \wedge^2 \mathfrak{g}^* \otimes \mathfrak{g}$ defined by

$$\begin{aligned} \kappa_u(\xi, \eta) &= K(\omega_u^{-1}(\xi), \omega_u^{-1}(\eta)) \\ &= [\xi, \eta] - \omega_u([\omega_u^{-1}(\xi), \omega_u^{-1}(\eta)]). \end{aligned}$$

Thus the curvature K is the obstruction to ω_u defining a Lie algebra homomorphism $T_u F^P \rightarrow \mathfrak{g}$. The P -invariance of ω implies that $\xi \mapsto \omega^{-1}(\xi)$ is P -equivariant, so that differentiating gives $[\omega^{-1}(\xi), \omega^{-1}(\eta)] = \omega^{-1}([\xi, \eta])$. It follows that K is P -invariant and horizontal (that is, $X \lrcorner K = 0$ for any vertical vector field on F^P), so may be viewed as a 2-form $K_M \in \Omega^2(M; \mathfrak{g}_M)$ on M ; equivalently κ takes values in $\wedge^2(\mathfrak{g}/\mathfrak{p})^* \otimes \mathfrak{g}$. In the case of Example 3.2(1), K_M coincides with the curvature of the metric connection.

Proposition 3.5. [165, Thm. 5.5.1] *A Cartan geometry $(F^P \rightarrow M, \omega)$ is flat if and only if it is locally isomorphic² to its flat model $(G \rightarrow G/P, \omega^G)$. \square*

Clearly the restriction $(F^P|_U \rightarrow U, \omega|_U)$ to an open set $U \subseteq M$ is also a Cartan geometry of type G/P . Then Proposition 3.5 means that every point in M has a neighbourhood U such that $(F^P|_U \rightarrow U, \omega|_U)$ is isomorphic to the restriction of $(G \rightarrow G/P, \omega^G)$ to a neighbourhood of $0 \in G/P$.

Definition 3.6. The *torsion* of ω is the $\mathfrak{g}/\mathfrak{p}$ -valued 2-form $T \in \Omega^2(F^P; \mathfrak{g}/\mathfrak{p})$ defined by projecting values of K to $\mathfrak{g}/\mathfrak{p}$. A Cartan geometry is *torsion-free* if its torsion vanishes.

Since K is P -invariant and horizontal, the torsion descends to a 2-form $T_M \in \Omega^2(M; TM)$. In Example 3.2, torsion-freeness amounts to torsion-freeness of the metric connection or conformal connection induced on TM .

3.1.2 Parabolic geometries

Due to the algebraic properties of parabolic subalgebras discussed in Section 2.1, Cartan geometries modelled on generalised flag manifolds have a rich algebraic structure.

Definition 3.7. A *parabolic geometry* is a Cartan geometry modelled on a generalised flag manifold G/P , with G a semisimple Lie group and $P \leq G$ a parabolic subgroup.

We retain any adjectives applied to either the Cartan geometry or the parabolic subalgebra \mathfrak{p} of P . In particular, a parabolic geometry is *abelian* if \mathfrak{p} is an abelian parabolic; for example, conformal geometry from Example 3.2(2) is abelian.

A natural question for Cartan geometries is whether they are equivalent to simpler underlying first-order structures. For conformal geometry, the *conformal equivalence problem* states that a conformal manifold is equivalent to a certain kind of conformal Cartan geometry [165, §7.3]. We shall discuss this further in Subsection 3.2.3, but as a first step we can obtain the underlying geometric structure.

Let $(F^P \rightarrow M, \omega)$ be a parabolic geometry of type G/P on M , and suppose that \mathfrak{p} has height n . Via the trivialisation $TF^P \cong F^P \times \mathfrak{g}$ induced by ω , the \mathfrak{p}^\perp -filtration of \mathfrak{g} induces a filtration

$$TF^P = TF_n^P \supset \cdots \supset TF_{-n}^P \supset 0 \quad (3.1)$$

by smooth subbundles, where $TF_i^P := \omega^{-1}(\mathfrak{g}_i)$ has rank equal to $\dim(\mathfrak{g}_i)$. Since $\exp \mathfrak{p}^\perp \leq P$ acts freely on F^P , the orbit space $F^0 := F^P / \exp \mathfrak{p}^\perp$ is a principal P^0 -bundle. Moreover \mathfrak{p} preserves the filtration (3.1), hence inducing filtrations $TF^0 = TF_n^0 \supset \cdots \supset TF_0^0 \supset 0$ and $TM = TM_n \supset \cdots \supset TM_1 \supset 0$ of TF^0 and TM by smooth

²That is, there is a principal P -bundle isomorphism $\Psi : G/P \rightarrow F^P$ such that $\Psi^*\omega = \omega^G$.

subbundles. For convenience we choose an algebraic Weyl structure for \mathfrak{p} , thus identifying $\mathfrak{g} \cong \text{gr } \mathfrak{g}$ and splitting the natural projection $P \rightarrow P^0$. For each $u_0 \in F^0$ and $\xi \in T_{u_0} F_i^0$, choose lifts $u \in F^P$ of u_0 and $\tilde{\xi} \in T_u F^P$ of ξ . It turns out [60, Prop. 3.1.5] that

$$\omega_{(i)}^0(\xi) := \omega(\tilde{\xi}) \bmod \mathfrak{g}_{i-1}$$

is a well-defined smooth section of $\text{Hom}(TF_i^0, \mathfrak{g}_{(i)})$, which is P^0 -equivariant and has kernel TF_{i-1}^0 . The graded vector bundle $\text{gr}(TM)$ is associated to $\mathfrak{g}/\mathfrak{p} \cong \mathfrak{g}_{(1)} \oplus \cdots \oplus \mathfrak{g}_{(n)}$ and the adjoint action of P^0 on $\mathfrak{g}/\mathfrak{p}$ preserves this grading, giving a homomorphism $\text{Ad} : P^0 \rightarrow \text{GL}(\mathfrak{g}/\mathfrak{p})_{\text{gr}}$ into the group of grading-preserving automorphisms of $\mathfrak{g}/\mathfrak{p}$. This allows us to talk about reductions of $\text{gr}(TM)$ to structure group P^0 .

The data $(TM_i, \omega_{(i)}^0)$ constitutes an *infinitesimal flag structure* of type G/P on M . In fact, these data are equivalent to a filtration $TM = TM_n \supset \cdots \supset TM_1 \supset 0$ in which the rank of TM_i equals $\dim(\mathfrak{g}_i/\mathfrak{p})$, together with a reduction of $\text{gr}(TM)$ to structure group P^0 with respect to $\text{Ad} : P^0 \rightarrow \text{GL}(\mathfrak{g}/\mathfrak{p})_{\text{gr}}$; see [60, Prop. 3.1.6]. For abelian parabolic geometries this amounts to a reduction of TM to structure group P^0 .

Example 3.8. In the case of conformal geometry, $G = \text{SO}(n+1, 1)$ and P is the stabiliser of a given isotropic line. The choice of an algebraic Weyl structure and the adjoint action induces an isomorphism $P^0 \cong \text{CO}(n)$, so that an infinitesimal flag structure of type G/P is a first-order $\text{CO}(n)$ -structure, *i.e.* a conformal structure.

3.2 Tractor calculus and the equivalence of categories

It is often beneficial to “linearise” the Cartan connection, by inducing linear connections on associated *tractor bundles*; we discuss this in Subsection 3.2.1. Geometric analogues of algebraic Weyl structures are introduced in Subsection 3.2.2, after which we conclude the discussion of the parabolic equivalence problem in Subsection 3.2.3.

3.2.1 Tractor bundles and tractor connections

Let $F \rightarrow M$ be a principal P -bundle with principal P -connection $\theta \in \Omega^1(F; \mathfrak{p})$, and let V be a P -representation. If $\mathcal{H} \leq TF$ is the horizontal distribution of θ , then $\mathcal{H} \times \{0\} \leq TF \times V$ is P -invariant and therefore descends to a horizontal distribution on the associated bundle $V_M := F \times_P V$, so that θ induces a linear connection on each associated bundle. In the case of a Cartan geometry $(F^P \rightarrow M, \omega)$, the Cartan connection ω is not a principal P -connection so cannot be used to induce connections on associated bundles. We can remedy this by forming the *extended Cartan bundle* $F^G := F^P \times_P G$ associated to the restriction of the adjoint action of G on itself.

Proposition 3.9. [60, Thm. 1.5.6] *The extended Cartan bundle F^G is a principal G -bundle, with a unique principal G -connection induced by the Cartan connection ω . \square*

We shall also denote this principal G -connection by $\omega \in \Omega^1(F^G; \mathfrak{g})$. Then for any G -representation \mathbb{V} , the associated vector bundle $\mathcal{V} := F^G \times_G \mathbb{V}$ inherits a linear connection from ω . Clearly restriction to P give an isomorphism $\mathcal{V} \cong F^P \times_P \mathbb{V}$, so that \mathcal{V} may be viewed as a bundle associated to F^P .

Definition 3.10. Let \mathbb{V} be the restriction to P of a G -representation. Then $\mathcal{V} := F^P \times_P \mathbb{V}$ is the *tractor bundle* associated to \mathbb{V} , while the linear connection $\nabla^{\mathbb{V}}$ induced by ω is the *tractor connection*.

In order to obtain a formula for the tractor connection on each tractor bundle, we define the *invariant derivative* by

$$\begin{aligned} \nabla^\omega : \Omega^0(F^P; \mathbb{V}) &\rightarrow \Omega^0(F^P; \mathfrak{g}^* \otimes \mathbb{V}) \\ \nabla_\xi^\omega s &= ds(\omega^{-1}(\xi)) \end{aligned} \tag{3.2}$$

for all $\xi \in \mathfrak{g}$, which evidently depends only on the Cartan connection ω and the representation \mathbb{V} . It is straightforward to see that if f is P -equivariant then so is $\nabla^\omega f$, so that we may view $\nabla^\omega : \Omega^0(M; \mathcal{V}) \rightarrow \Omega^0(M; \mathfrak{g}_M^* \otimes \mathcal{V})$ as a map of sections. Given $\xi, \eta \in \mathfrak{g}$, one can verify by direct calculation that ∇^ω satisfies a Leibniz rule

$$\nabla_\xi^\omega (s_1 \otimes s_2) = \nabla_\xi^\omega s_1 \otimes s_2 + s_1 \otimes \nabla_\xi^\omega s_2$$

on tensor products $\mathbb{V}_1 \otimes \mathbb{V}_2$, and a Ricci identity

$$\nabla_\xi^\omega (\nabla_\eta^\omega s) - \nabla_\eta^\omega (\nabla_\xi^\omega s) = \nabla_{[\xi, \eta]}^\omega s - \nabla_{\kappa(\xi, \eta)}^\omega s, \tag{3.3}$$

where $\kappa : F^P \rightarrow \wedge^2 \mathfrak{g}_M^* \otimes \mathfrak{g}_M$ is the curvature function of ω . The final term in (3.3) is first order in general due to torsion, and if ω is torsion-free then $\nabla_{[X, Y]}^\omega s = -\kappa(X, Y) \cdot s$. Moreover the map $\Omega^0(M; \mathcal{V}) \ni s \mapsto (s, \nabla^\omega s) \in \Omega^0(M; \mathcal{V} \oplus (\mathfrak{g}_M^* \otimes \mathcal{V}))$ identifies the first jet bundle $\mathcal{J}^1(\mathcal{V})$ of \mathcal{V} with an associated bundle [49, Prop. 1.3].

Lemma 3.11. ∇^ω is vertically trivial in the sense that $\nabla_\xi^\omega f + \xi \cdot f = 0$ for all P -equivariant functions $f : F^P \rightarrow \mathbb{V}$ and all $\xi \in \mathfrak{p}$. \square

The modified map $(s, \xi) \mapsto \nabla_\xi^\omega s + \xi \cdot s$ then vanishes for $\xi \in \mathfrak{p}$, so takes values in $(\mathfrak{g}/\mathfrak{p})^* \otimes \mathbb{V}$ and therefore defines a linear connection on \mathbb{V} by the Cartan condition.

Proposition 3.12. *The linear connection induced by $(s, \xi) \mapsto \nabla_\xi^\omega s + \xi \cdot s$ coincides with the tractor connection $\nabla^{\mathbb{V}}$ on \mathcal{V} . \square*

Direct calculation using Proposition 3.12 and equation (3.2) yields the following.

Corollary 3.13. *The curvature of $\nabla^\mathbb{V}$ is given by $R_{X,Y}^\mathbb{V} \cdot s = K_M(X,Y) \cdot s$ for all $X, Y \in \Omega^0(M; TM)$ and $s \in \Omega^0(M; \mathcal{V})$. \square*

An important example of a tractor bundle is the *adjoint tractor bundle* $\mathfrak{g}_M := F^P \times_P \mathfrak{g}$ given by the restriction of the adjoint action of G on \mathfrak{g} . The projection $\mathfrak{g} \rightarrow \mathfrak{g}/\mathfrak{p}$ exhibits TM as a natural quotient of \mathfrak{g}_M , while dually the inclusion $(\mathfrak{g}/\mathfrak{p})^* \hookrightarrow \mathfrak{g}^*$ exhibits T^*M as a natural subbundle of \mathfrak{g}_M^* . For parabolic geometries, TM and T^*M are bundles of nilpotent Lie algebras modelled on $\mathfrak{g}/\mathfrak{p}$ and \mathfrak{p}^\perp respectively.

Viewed as a P -equivariant bilinear map $[\cdot, \cdot] : \mathfrak{g} \times \mathfrak{g} \rightarrow \mathfrak{g}$, the Lie bracket on \mathfrak{g} induces a bilinear map $\llbracket \cdot, \cdot \rrbracket : \Omega^0(M; \mathfrak{g}_M) \times \Omega^0(M; \mathfrak{g}_M) \rightarrow \Omega^0(M; \mathfrak{g}_M)$ of sections.

Definition 3.14. The map $\llbracket \cdot, \cdot \rrbracket : \Omega^0(M; \mathfrak{g}_M) \times \Omega^0(M; \mathfrak{g}_M) \rightarrow \Omega^0(M; \mathfrak{g}_M)$ of sections of \mathfrak{g}_M is called the *algebraic bracket*.

Note also that the pointwise action of \mathfrak{g} on \mathbb{V} extends to a map $\cdot : \Omega^0(M; \mathfrak{g}_M) \times \Omega^0(M; \mathcal{V}) \rightarrow \Omega^0(M; \mathcal{V})$ of sections of the associated bundles, called the *algebraic action*; this identifies \mathcal{V} with a bundle of representations for the Lie algebra bundle \mathfrak{g}_M .

Proposition 3.15. *Let \mathbb{V} be a \mathfrak{g} -representation with tractor bundle \mathcal{V} . Then:*

- (1) $\llbracket s_1, s_2 \rrbracket \cdot t = s_1 \cdot (s_2 \cdot t) - s_2 \cdot (s_1 \cdot t)$; and
- (2) *The algebraic bracket and algebraic action are tractor-parallel, i.e.*

$$\begin{aligned} \nabla_X^\mathfrak{g} \llbracket s_1, s_2 \rrbracket &= \llbracket \nabla_X^\mathfrak{g} s_1, s_2 \rrbracket + \llbracket s_1, \nabla_X^\mathfrak{g} s_2 \rrbracket \\ \text{and } \nabla_X^\mathbb{V} (s \cdot t) &= (\nabla_X^\mathfrak{g} s) \cdot t + s \cdot (\nabla_X^\mathbb{V} t) \end{aligned}$$

for all $s, s_1, s_2 \in \Omega^0(M; \mathfrak{g}_M)$ and $t \in \Omega^0(M; \mathcal{V})$. \square

3.2.2 Weyl structures

Recall that an algebraic Weyl structure is a choice of lift of the unique grading element $\xi^0 \in \mathfrak{z}(\mathfrak{p}^0)$ to \mathfrak{p} , and this choice splits the \mathfrak{p}^\perp -filtration of \mathfrak{g} . Since ξ^0 is unique and P -invariant, we obtain a unique *grading section* ξ_M^0 , which is a section of $\mathfrak{p}_M^0 := F^P \times_P \mathfrak{p}^0$.

Definition 3.16. A *Weyl structure* is a smooth lift of the grading section $\xi_M^0 \in \Omega^0(M; \mathfrak{p}^0)$ to a section of $\mathfrak{p}_M := F^P \times_P \mathfrak{p}$.

Equivalently, a Weyl structure is a smooth choice of an algebraic Weyl structure at each point of M . By Lemma 2.10, the space of Weyl structures is an affine bundle modelled on $\mathfrak{p}_M^\perp \cong T^*M$.

Applying the results of Subsection 2.1.3 pointwise, a Weyl structure induces isomorphisms $\xi_{\mathcal{V}} : \text{gr } \mathcal{V} \rightarrow \mathcal{V}$ of each associated bundle with its associated graded bundle; in particular we obtain an isomorphism $\xi_{\mathfrak{g}} : TM \oplus \mathfrak{p}_M^0 \oplus T^*M \rightarrow \mathfrak{g}_M$. This allows us to use the invariant derivative (3.2) to induce linear connections on tractor bundles.

Definition 3.17. Let \mathbb{V} be a \mathfrak{g} -representation with associated bundle $\mathcal{V} := F^P \times_P \mathbb{V}$.

- (1) The *Ricci-corrected Weyl connection* is the linear connection $\nabla^{(1)}$ on \mathcal{V} defined by restricting the invariant derivative ∇^ω to TM using $\xi_{\mathfrak{g}}$, i.e. $\nabla_X^{(1)} s := \nabla_{\xi_{\mathfrak{g}} X}^\omega s$.
- (2) The *Weyl connection* is the linear connection ∇ on \mathcal{V} induced by $\nabla^{(1)}$ on $\text{gr } \mathcal{V}$, i.e. $\nabla s := (\xi_{\mathcal{V}}^{-1} \circ \nabla^{(1)} \circ \xi_{\mathcal{V}})s$ for all $s \in \Omega^0(M; \mathcal{V})$.

If \mathbb{V} is a completely reducible P -representation then \exp^{\perp} acts trivially, so that $\mathcal{V} \cong \text{gr } \mathcal{V}$ canonically. In this case the connections $\nabla^{(1)}$ and ∇ agree.

We may equivalently view ξ_M as an isomorphism $F^P \times (\mathfrak{g}/\mathfrak{p} \oplus \mathfrak{p}^0 \oplus \mathfrak{p}^{\perp}) \rightarrow F^P \times \mathfrak{g}$, also denoted by ξ_M . Using this we may decompose the Cartan connection ω as

$$\omega = \xi_M \omega_{\mathfrak{g}/\mathfrak{p}} \oplus \omega_{\mathfrak{p}}, \quad \text{where } \omega_{\mathfrak{p}} = \xi_M \omega_{\mathfrak{p}^0} \oplus \omega_{\mathfrak{p}^{\perp}}, \quad (3.4)$$

$\omega_{\mathfrak{g}/\mathfrak{p}} := \omega \bmod \mathfrak{p} \in \Omega^1(M; \mathfrak{g}/\mathfrak{p})$ is the *solder form*, and $\omega_{\mathfrak{p}^0} := \omega_{\mathfrak{p}} \bmod \mathfrak{p}^{\perp} \in \Omega^1(M; \mathfrak{p}^0)$. Since the space \mathfrak{w} of algebraic Weyl structures is a homogeneous space for \exp^{\perp} , the fundamental vector fields generated by elements of \mathfrak{p}^{\perp} induce a Maurer–Cartan form $\eta : T\mathfrak{w} \rightarrow \mathfrak{p}^{\perp}$, trivialising $T\mathfrak{w} \cong \mathfrak{w} \times \mathfrak{p}^{\perp}$ via the affine structure. We may then view ξ_M as a P -equivariant function $\xi_{\mathfrak{w}} : F^P \rightarrow \mathfrak{w}$. It turns out to be fruitful to write

$$\omega_{\mathfrak{p}} = (\xi_M \omega_{\mathfrak{p}^0} - \xi_{\mathfrak{w}}^* \eta) + (\omega_{\mathfrak{p}^{\perp}} + \xi_{\mathfrak{w}}^* \eta) \quad (3.5)$$

for the following reasons [50, Prop. 4.2].

Proposition 3.18. *Let ξ_M be a Weyl structure. Then:*

- (1) $\omega_{\mathfrak{p}}$ is a principal P -connection on F^P , inducing $\nabla^{(1)}$ on associated bundles.
- (2) $\xi_M \omega_{\mathfrak{p}^0} - \xi_{\mathfrak{w}}^* \eta$ is a principal P -connection on F^P , inducing ∇ on associated bundles.
- (3) $\omega_{\mathfrak{p}^{\perp}} + \xi_{\mathfrak{w}}^* \eta$ is a horizontal P -invariant \mathfrak{p}^{\perp} -valued 1-form on F^P ; if r^{∇} is the T^*M -valued 1-form induced on M then $\nabla_X^{(1)} s = \nabla_X s + r_X^{\nabla} \cdot s$. \square

Definition 3.19. The T^*M -valued 1-form $r^{\nabla} \in \Omega^1(M; T^*M)$ induced by $\omega_{\mathfrak{p}^{\perp}} + \xi_{\mathfrak{w}}^* \eta$ on M is called the *normalised Ricci tensor* of the Weyl structure ξ_M .

Since $\nabla^{(1)}$ is induced by the invariant derivative on \mathcal{V} , Lemma 3.11 and Proposition 3.18(3) allow us to write the tractor connection on \mathcal{V} as

$$\nabla_X^{\mathbb{V}} s = X \cdot s + \nabla_X s + r_X^{\nabla} \cdot s. \quad (3.6)$$

Using the Weyl structure, the Lie algebra differential $\partial^* : \wedge^k \mathfrak{p}^\perp \otimes \mathbb{V} \rightarrow \wedge^{k+1} \mathfrak{p}^\perp \otimes \mathbb{V}$ induces a bundle map $\partial^* : \wedge^k T^* M \otimes \mathcal{V} \rightarrow \wedge^{k+1} T^* M \otimes \mathcal{V}$. Equation (3.6) then becomes $\nabla^\mathbb{V} s = \partial^* s + \nabla s + r^\nabla \cdot s$, as in [55, 95].

Remark 3.20. If we choose a point $x \in M$ and hence an algebraic Weyl structure, a Weyl structure is equivalent to a P^0 -equivariant section of the projection $F^P \rightarrow F^0 := F^P / \exp(\mathfrak{p}^\perp)$; see [50, App. A]. This is the original approach of Čap and Slovák [59].

It is natural to ask how the Weyl connection ∇ and normalised Ricci tensor r^∇ change when we change the Weyl structure ξ_M . Viewing ξ_M as the P -equivariant function $\xi_{\mathfrak{w}} : F^P \rightarrow \mathfrak{w}$ from above, any other Weyl structure may be written $\xi'_M = (\text{Ad } q)\xi_M$ for some P -equivariant function $q : F^P \rightarrow \exp \mathfrak{p}^\perp$. Let $q(t) : F^P \rightarrow \exp \mathfrak{p}^\perp$ be a P -equivariant curve with $q(0) = \text{id}$ and $q'(0) = \gamma \in \Omega^1(M)$. Then for any object $F(\xi_M)$ depending on the Weyl structure, we define the *first-order variation of F* by

$$(\delta_\gamma F)(\xi_M) := \left. \frac{d}{dt} F((\text{Ad}(q(t)^{-1}))\xi_M) \right|_{t=0}.$$

By the fundamental theorem of calculus, F is independent of ξ_M if and only if $\delta_\gamma F = 0$ for all $\gamma \in \Omega^1(M)$. Moreover for any $\gamma \in \Omega^1(M)$, Taylor's theorem allows us to write

$$F((\text{Ad } \gamma)\xi_M) = F(\xi_M) + (\delta_\gamma F)(\xi_M) + \frac{1}{2}(\delta_\gamma \delta_\gamma F)(\xi_M) + \dots, \quad (3.7)$$

where we view γ as a P -equivariant function $F^P \rightarrow \mathfrak{p}^\perp$.

Proposition 3.21. [50, App. B] *Let ξ_M be a Weyl structure and let $\gamma \in \Omega^1(M)$. Then:*

- (1) $\delta_\gamma \nabla_X = \llbracket X, \gamma \rrbracket_{\mathfrak{p}^0} + \nabla_X \gamma$; and
- (2) $\delta_\gamma r_X^\nabla = -\nabla_X \gamma + \llbracket X, \gamma \rrbracket_{\mathfrak{p}^\perp}$,

where $\llbracket X, \gamma \rrbracket_{\mathfrak{p}^0}$ and $\llbracket X, \gamma \rrbracket_{\mathfrak{p}^\perp}$ are the projections of the algebraic bracket $\llbracket X, \gamma \rrbracket$ to the appropriate summands using ξ_M . \square

For completely reducible P -representations, $\exp \mathfrak{p}^\perp$ acts trivially and we do not see the $\nabla_X \gamma$ terms. By projecting to F^0 and writing $\gamma = (\gamma_{-k}, \dots, \gamma_{-1})$ etc., we can also recover the componentwise formulae given by Čap and Slovák [59]; see also [60, §5.1].

3.2.3 The equivalence of categories

A *morphism* between two Cartan geometries $(F_1^P \rightarrow M, \omega_1)$ and $(F_2^P \rightarrow M, \omega_2)$ of type G/P over M is a principal P -bundle morphism $\Psi : F_1^P \rightarrow F_2^P$ for which $\Psi^* \omega_2 = \omega_1$. This makes Cartan geometries of type G/P over M into a category, and the conformal equivalence problem may be restated as an equivalence of categories between conformal

manifolds and “normal” conformal Cartan geometries. Modulo a minor restriction, a similar statement holds for all parabolic geometries, where the conformal structure is replaced with the underlying infinitesimal flag structure from Subsection 3.1.2.

Definition 3.22. A parabolic geometry $(F^P \rightarrow M, \omega)$ with curvature form $K_M \in \Omega^2(M; \mathfrak{g}_M)$ is *regular* if $K_M(TM_i, TM_j) \subseteq (\mathfrak{g}_M)_{i+j-1}$ for all $i, j > 0$.

In particular, abelian parabolic geometries are automatically regular. More generally, a Weyl structure yields an isomorphism $TM \cong \text{gr}(TM)$. The algebraic bracket satisfies $\llbracket TM_{(i)}, TM_{(j)} \rrbracket \subseteq TM_{(i+j-1)}$ for all $i > 0$, making $(\text{gr}(TM), \llbracket \cdot, \cdot \rrbracket)$ into a bundle of nilpotent Lie algebras modelled on $\mathfrak{g}/\mathfrak{p}$. Regularity is equivalent to local triviality of $(\text{gr}(TM), \llbracket \cdot, \cdot \rrbracket)$, together with a reduction of the frame bundle of $\text{gr}(TM)$ with respect to $\text{Ad} : P^0 \rightarrow \text{Aut}(\mathfrak{g}/\mathfrak{p})_{\text{gr}}$; see [60, p. 252]. Thus regularity ensures a close relationship between the filtration of TM and the reduction of $\text{gr}(TM)$.

The next natural question to ask is which Cartan connections induce the same underlying infinitesimal flag structure. The difference $\Phi := \hat{\omega} - \omega$ of Cartan connections is a horizontal \mathfrak{g} -valued 1-form on F^P , so may be viewed as a section of $T^*M \otimes \mathfrak{g}_M$.

Lemma 3.23. [60, Prop. 3.1.10] *Cartan connections ω and $\hat{\omega}$ on $F^P \rightarrow M$ induce the same infinitesimal flag structure if and only if $\Phi(TM_i) \subseteq (\mathfrak{g}_M)_{i-\ell}$ for some $\ell \geq 1$. \square*

In this case the difference $\hat{K} - K$ of curvatures maps $TM_i \times TM_j$ to $(\mathfrak{g}_M)_{i+j-\ell}$, thus yielding a map $\text{gr}(\hat{K} - K) : \text{gr}(TM) \times \text{gr}(TM) \rightarrow \text{gr}(\mathfrak{g}_M)$. On the other hand, regularity implies that $\Phi := \hat{\omega} - \omega$ descends to a map $\text{gr} \Phi : \text{gr}(TM) \rightarrow \text{gr}(\mathfrak{g}_M)$. If $\partial^* : \text{gr}(T^*M \otimes \mathfrak{g}_M) \rightarrow \text{gr}(\wedge^2 T^*M \otimes \mathfrak{g}_M)$ is the graded bundle map induced by the Lie algebra differential, it is straightforward to check that $\text{gr}_{(\ell)}(\hat{K} - K) = \partial^*(\text{gr}_{(\ell)} \Phi)$, where $\text{gr}_{(\ell)}$ denotes the ℓ th graded component. This suggests a normalisation condition where $\text{gr}(K)$ takes values in a natural subbundle complementary to $\text{im} \partial^*$. By Kostant’s Hodge decomposition (2.3), such a subbundle is provided by $\ker \partial$.

Definition 3.24. A Cartan connection ω is *normal* if its curvature K satisfies $\partial K = 0$. In this case, the *harmonic curvature* K_\circ is the image of K in $H_2(\mathfrak{p}^\perp; \mathfrak{g}_M)$.

Normality is particularly simple for abelian parabolic geometries; we will give a characterisation in terms of torsion before Theorem 3.36.

Theorem 3.25. *If $K(TM_i, TM_j) \subseteq (\mathfrak{g}_M)_{i+j-\ell}$ for some $\ell \geq 1$ then $\partial^*(\text{gr}_{(\ell)} K) = 0$. Moreover if ω is normal then $\text{gr}_{(\ell)} K$ is a section of $\ker \partial$. \square*

Choosing an algebraic Weyl structure, it follows that $\text{gr}_{(\ell)} K$ coincides with the graded component of harmonic curvature K_\circ of degree ℓ .

Corollary 3.26. *For regular normal parabolic geometries, $K = 0$ if and only if $K_\circ = 0$; thus the harmonic curvature is a complete obstruction to local flatness. \square*

A regular Cartan connection can always be modified to produce a normal Cartan connection inducing the same underlying infinitesimal flag structure [60, Thm. 3.1.13]. To obtain a uniqueness result, note that $\wedge^k \mathfrak{p}^\perp \otimes \mathfrak{g} \cong \text{Hom}(\wedge^k(\mathfrak{g}/\mathfrak{p}), \mathfrak{g})$ inherits a natural filtration by “homogeneous degree” from the filtrations of $\wedge^k(\mathfrak{g}/\mathfrak{p})$ and \mathfrak{g} . Since ∂ is filtration preserving, this descends to a filtration of $H_k(\mathfrak{p}^\perp; \mathfrak{g})$.

Theorem 3.27. [58, Thm. 3.22] *Suppose that $H_1(\mathfrak{p}^\perp; \mathfrak{g})_1 = 0$. Then associating the underlying infinitesimal flag structure to any parabolic geometry induces an equivalence of categories between regular normal parabolic geometries of type G/P over M and regular infinitesimal flag structures of type G/P over M . \square*

For abelian parabolic geometries with $H_1(\mathfrak{p}^\perp; \mathfrak{g})_1 = 0$, Theorem 3.27 yields an equivalence of categories between normal parabolic geometries and first-order P^0 -structures.

Remark 3.28. The condition $H_1(\mathfrak{p}^\perp; \mathfrak{g})_1 = 0$ ensures that the reduction of the frame bundle of $\text{gr}(TM)$ to structure group P^0 contains geometric information, other than an orientation. It turns out that $H_1(\mathfrak{p}^\perp; \mathfrak{g})_k = 0$ for all $k > 0$ unless \mathfrak{p} or its complexification contain a simple ideal isomorphic to either

$$\times \text{---} \circ \cdots \text{---} \circ \text{---} \circ \quad \text{or} \quad \times \text{---} \circ \cdots \text{---} \circ \text{---} \circ \text{---} \circ \leftarrow \circ; \tag{3.8}$$

see [184, Prop. 5.1]. It is possible [60, §3.1.16] to obtain a similar equivalence of categories in the case that $H_1(\mathfrak{p}^\perp; \mathfrak{g})_1 \neq 0$, by associating to each parabolic geometry a stronger underlying structure called a *P-frame bundle of degree one*. Only the first case of (3.8) is problematic for us, so we postpone this discussion until Subsection 4.2.2.

3.3 BGG operators and curvature decomposition

Parabolic geometries also have a well-developed theory of invariant differential operators thanks to the *curved Bernstein–Gelfand–Gelfand (BGG) sequence*, which we introduce in Subsection 3.3.1. This allows us to describe the decomposition of the Cartan curvature with respect to a Weyl structure in Subsection 3.3.2. Finally, it turns out that the solution space of the first BGG operator can be prolonged to a closed system of PDEs on an auxiliary tractor bundle; we discuss this in Subsection 3.3.3.

3.3.1 The curved BGG sequence

The invariant differential operators between tractor bundles over the flat model G/P have a complete description in terms of *generalised Verma modules*, which are \mathfrak{g} -

representations $M_{\mathfrak{p}}(\lambda) := \mathcal{U}(\mathfrak{g}) \otimes_{\mathcal{U}(\mathfrak{p})} \mathbb{V}_{\lambda}$ classified by the \mathfrak{p} -highest weights modules \mathbb{V}_{λ} . As in Subsection 2.2.2, the affine action of the Hasse diagram of \mathfrak{p} determines a graph of weights of \mathfrak{p} , and it turns out there is a non-trivial homomorphism $M_{\mathfrak{p}}(\lambda) \rightarrow M_{\mathfrak{p}}(\mu)$ whenever λ, μ are joined by a single arrow in this diagram. Thus the Hasse diagram determines a sequence of generalised Verma module homomorphisms for each \mathbb{V} , which may be viewed as homomorphisms between irreducible components of $H_{\bullet}(\mathfrak{p}^{\perp}; \mathbb{V})$ via Theorem 2.33. Taken together, these yield a resolution

$$0 \longleftarrow H_{\dim \mathfrak{p}^{\perp}}(\mathfrak{p}^{\perp}; \mathbb{V}) \longleftarrow \cdots \longleftarrow H_1(\mathfrak{p}^{\perp}; \mathbb{V}) \longleftarrow H_0(\mathfrak{p}^{\perp}; \mathbb{V}) \longleftarrow \mathbb{V} \longleftarrow 0$$

of \mathbb{V} called the *Bernstein–Gelfand–Gelfand complex*. On the other hand, a differential operator between two tractor bundles over G/P is invariant if and only if it is dual to a homomorphism of generalised Verma modules. In this picture the Hasse diagram of \mathfrak{p} determines a complex of invariant differential operators between irreducible components of homology modules, which can be computed algorithmically using Kostant’s version of the Bott–Borel–Weil theorem; see Theorem 2.33.

Now let $(F^P \rightarrow M, \omega)$ be a parabolic geometry. Following work of Baston in conformal geometry [19, 20, 21], a *curved Bernstein–Gelfand–Gelfand sequence* for general parabolic geometries was constructed by Čap, Slovák and Souček [61]. The construction was later simplified by Calderbank and Diemer [49]; we follow this account here.

Fix a \mathfrak{g} -representation \mathbb{V} with tractor bundle $\mathcal{V} := F^P \times_P \mathbb{V}$. By Lemma 2.28, the Lie algebra boundary map $\partial : \wedge^k \mathfrak{p}^{\perp} \otimes \mathbb{V} \rightarrow \wedge^{k-1} \mathfrak{p}^{\perp} \otimes \mathbb{V}$ induces a complex of bundle maps $\partial : \wedge^k T^*M \otimes \mathcal{V} \rightarrow \wedge^{k-1} T^*M \otimes \mathcal{V}$, with homology $H_k(\mathfrak{p}^{\perp}; \mathcal{V}) := F^P \times_P H_k(\mathfrak{p}^{\perp}; \mathbb{V})$.

Theorem 3.29. [49, Thm. 3.6] *There is a natural sequence*

$$\Omega^0(M; H_0(\mathfrak{p}^{\perp}; \mathcal{V})) \xrightarrow{\mathcal{D}^{\mathbb{V},0}} \Omega^0(M; H_1(\mathfrak{p}^{\perp}; \mathcal{V})) \xrightarrow{\mathcal{D}^{\mathbb{V},1}} \Omega^0(M; H_2(\mathfrak{p}^{\perp}; \mathcal{V})) \xrightarrow{\mathcal{D}^{\mathbb{V},2}} \cdots \quad (3.9)$$

of linear differential operators whose symbols depend on $(G/P, \mathbb{V})$ but not on (M, ω) . Moreover if ω is flat then (3.9) is locally exact. \square

The BGG operators $\mathcal{D}^{\mathbb{V},k}$ are defined by constructing linear differential operators $\wedge^k T^*M \otimes \mathcal{V} \rightarrow \wedge^{k+1} T^*M \otimes \mathcal{V}$ which vanish on $\text{im } \partial$ and take values in $\ker \partial$, thus yielding differential operators $H_k(\mathfrak{p}^{\perp}; \mathcal{V}) \rightarrow H_{k+1}(\mathfrak{p}^{\perp}; \mathcal{V})$ on homology. On the level of \mathfrak{p} -representations, the Lie algebra differential $\partial^* : \wedge^k \mathfrak{p}^{\perp} \otimes \mathbb{V} \rightarrow \wedge^{k+1} \mathfrak{p}^{\perp} \otimes \mathbb{V}$ is a likely candidate, but unfortunately does not determine a map of associated bundles due to its lack of P -invariance.³ Ignoring this for now, by choosing an algebraic Weyl structure for \mathfrak{p} we can identify $H_k(\mathfrak{p}^{\perp}; \mathbb{V}) \cong \ker \square$ using Kostant’s Hodge decomposition (2.3).

³At least, not without choosing a Weyl structure.

Since \square is invertible on its image and commutes with ∂^* , the projection onto $\ker \square$ is

$$\text{id} - \square^{-1}\square = \text{id} - \square^{-1}\partial \circ \partial^* - \partial^* \circ \square^{-1}\partial. \quad (3.10)$$

The lack of P -equivariance can be remedied by replacing ∂^* with the exterior covariant derivative $d^\nabla : \Omega^k(M; \mathcal{V}) \rightarrow \Omega^{k+1}(M; \mathcal{V})$ induced by the tractor connection ∇^∇ , where

$$\begin{aligned} (d^\nabla s)(X_0, \dots, X_k) &= \sum_{i=0}^k (-1)^i \nabla_{X_i}^\nabla s(X_0, \dots, \hat{X}_i, \dots, X_k) \\ &\quad + \sum_{i < j} (-1)^{i+j} s([X_i, X_j], X_0, \dots, \hat{X}_i, \dots, \hat{X}_j, \dots, X_k) \end{aligned}$$

and hat denotes omission. Extending d^∇ to $\Omega^0(M; \wedge^k \mathfrak{g}_M^* \otimes \mathcal{V})$ in the obvious way, one can show that d^∇ is a first-order P -invariant modification of the bundle map $\wedge^k \mathfrak{g}_M^* \otimes \mathcal{V} \rightarrow \wedge^{k+1} \mathfrak{g}_M^* \otimes \mathcal{V}$ induced by the Lie algebra differential $\partial^* : \wedge^k \mathfrak{g}^* \otimes \mathbb{V} \rightarrow \wedge^{k+1} \mathfrak{g}^* \otimes \mathbb{V}$, prompting the definition of the following first-order operator [49, Eqn. (4.1)].

Definition 3.30. The operator $\square_M := d^\nabla \circ \partial + \partial \circ d^\nabla : \Omega^k(M; \mathcal{V}) \rightarrow \Omega^k(M; \mathcal{V})$ is called the *first-order laplacian*.

By choosing a Weyl structure, the algebraic laplacian on $\wedge^k \mathfrak{p}^\perp \otimes \mathbb{V}$ induces a bundle map $\square : \wedge^k T^*M \otimes \mathcal{V} \rightarrow \wedge^k T^*M \otimes \mathcal{V}$. One can show that

$$(\square_M - \square)s = \sum_i \varepsilon^i \cdot (\nabla_{e_i} s + r_{e_i}^\nabla \cdot s) \quad (3.11)$$

for any local frame $\{e_i\}_i$ of M with dual coframe $\{\varepsilon^i\}_i$. Thus $(\square_M - \square)s$ has strictly lower weight than s ; in particular the restriction of \square_M to each graded component of $\mathcal{V} \cong \text{gr } \mathcal{V}$ coincides with \square , since there $\mathfrak{p}_M^\perp \cong T^*M$ acts trivially. By writing

$$\square_M = \square(\text{id} - \mathcal{N}) \quad \text{where } \mathcal{N} := -\square^{-1}(\square_M - \square), \quad (3.12)$$

we arrive at the following.

Proposition 3.31. \square_M is invertible on $\text{im } \partial$, with finite-order differential inverse given by the Neumann series $\square_M^{-1} = \left(\sum_{k \geq 0} \mathcal{N}^k \right) \square^{-1}$. \square

Proposition 3.31 suggests that we consider the differential operator⁴

$$\Pi^{\nabla, k} := \text{id} - \square_M^{-1} \partial \circ d^\nabla - d^\nabla \circ \square_M^{-1} \partial$$

as an analogue of (3.10). From the definition and algebraic properties of ∂ , it straightforward to see that $\Pi^{\nabla, k}$ maps $\wedge^k T^*M \otimes \mathcal{V}$ to itself; vanishes on $\text{im } \partial$; takes values in

⁴We will often suppress mention of ∇ in this and later formulae.

$\ker \partial$; and induces the identity map on homology. Therefore we have natural differential projections to and representations of homology classes given by

$$\begin{aligned}\pi^{\mathbb{V},k} &:= \text{proj} \circ \Pi^{\mathbb{V},k} : \Omega^k(M; \mathcal{V}) \rightarrow \Omega^0(M; H_k(\mathfrak{p}^\perp; \mathcal{V})) \\ L^{\mathbb{V},k} &:= \Pi^{\mathbb{V},k} \circ \text{repr} : \Omega^0(M; H_k(\mathfrak{p}^\perp; \mathcal{V})) \rightarrow \Omega^k(M; \mathcal{V}),\end{aligned}\tag{3.13}$$

where proj is the projection to homology and repr is the choice of a representative. Moreover $\pi^k \circ \square_M = 0$, while L^k provides the unique representative in $\ker \square_M$.

Definition 3.32. The BGG operator is $\mathcal{D}^{\mathbb{V},k} := \pi^{\mathbb{V},k+1} \circ d^{\mathbb{V}} \circ L^{\mathbb{V},k}$.

Since π^{k+1} and L^k may be differential operators themselves, the BGG operators are generally higher than first order. The first BGG operator \mathcal{D}^0 is always finite order, with the order of \mathcal{D}^0 equal to the difference in (geometric) weights of the \mathfrak{p} -representations $H_0(\mathfrak{p}^\perp; \mathbb{V})$ and $H_1(\mathfrak{p}^\perp; \mathbb{V})$; see [149, §3].

In general the composition $\mathcal{D}^{k+1} \circ \mathcal{D}^k$ does not vanish due to the curvature of ω ; it is straightforward to compute that $\mathcal{D}^{k+1} \circ \mathcal{D}^k = \pi^{k+2} \circ R^{\mathbb{V}} \circ L^k$, so that we recover the BGG complex on the flat model G/P .

There is also a bilinear pairing $H_k(\mathfrak{p}^\perp; \mathcal{V}_1) \times H_\ell(\mathfrak{p}^\perp; \mathcal{V}_2) \rightarrow H_{k+\ell}(\mathfrak{p}^\perp; \mathcal{V}_3)$ associated to any triple of \mathfrak{g} -representations $\mathbb{V}_1, \mathbb{V}_2, \mathbb{V}_3$ with a bilinear pairing $\mathbb{V}_1 \times \mathbb{V}_2 \rightarrow \mathbb{V}_3$. Indeed, the associated wedge product $\wedge : \mathbb{V}_1 \times \mathbb{V}_2 \rightarrow \mathbb{V}_3$ induces

$$\sqcup := \pi^{\mathbb{V}_3, k+\ell} \circ \wedge \circ (L^{\mathbb{V}_1, k}, L^{\mathbb{V}_2, \ell}),\tag{3.14}$$

a bilinear differential pairing on homology. Up to curvature corrections, the BGG operators $\mathcal{D}^{\mathbb{V},k}$ satisfy a Leibniz rule over \sqcup , with \sqcup a cup product on homology [49, Prop. 5.7]. One can also show that the symbol of \sqcup depends only on $(G/P, \mathbb{V}_1, \mathbb{V}_2, \mathbb{V}_3)$ but not on (M, ω) . We will see an explicit example (for $k = \ell = 0$) in Chapter 8.

Remark 3.33. One can define other multilinear differential pairings associated to the BGG complex, and these pairings have a rich algebraic structure which is encapsulated in a *curved A_∞ -algebra*; see [49, §6] and [110].

3.3.2 Curvature decomposition

The P -invariant decomposition of the Cartan connection ω with respect to a Weyl structure ξ_M provided by (3.4) and (3.5) also induces a P -invariant decomposition of the Cartan curvature $K := d\omega + \frac{1}{2}[\omega \wedge \omega] \in \Omega^2(F^P; \mathfrak{g})$. Indeed, writing

$$\omega = \xi_M \omega_{\mathfrak{g}/\mathfrak{p}} + \underbrace{(\xi_M \omega_{\mathfrak{p}^0} - \xi_{\mathfrak{v}^0}^* \eta)}_{=: \omega_{\mathfrak{v}^0}} + \underbrace{(\omega_{\mathfrak{p}^\perp} + \xi_{\mathfrak{v}^0}^* \eta)}_{=: \rho}$$

yields a P -invariant decomposition $K = \xi_M K_{\mathfrak{g}/\mathfrak{p}} + \xi_M K_{\mathfrak{p}^0} + K_{\mathfrak{p}^\perp}$, where

$$\begin{aligned}
K_{\mathfrak{g}/\mathfrak{p}} &:= \xi_M(d\omega_{\mathfrak{g}/\mathfrak{p}} + \frac{1}{2}[\omega_{\mathfrak{g}/\mathfrak{p}} \wedge \omega_{\mathfrak{g}/\mathfrak{p}}]) \\
&\quad + \llbracket \xi_M \omega_{\mathfrak{g}/\mathfrak{p}} \wedge \omega_{\mathfrak{w}} \rrbracket + \llbracket \xi_M \omega_{\mathfrak{g}/\mathfrak{p}} \wedge \rho \rrbracket_{\mathfrak{g}/\mathfrak{p}} \\
K_{\mathfrak{p}^0} &:= (d\omega_{\mathfrak{w}} + \frac{1}{2}[\omega_{\mathfrak{w}} \wedge \omega_{\mathfrak{w}}]) \\
&\quad + \llbracket \xi_M \omega_{\mathfrak{g}/\mathfrak{p}} \wedge \rho \rrbracket_{\mathfrak{p}^0} \\
\text{and } K_{\mathfrak{p}^\perp} &:= (d\rho + \frac{1}{2}[\rho \wedge \rho]) + \llbracket \omega_{\mathfrak{w}} \wedge \rho \rrbracket \\
&\quad + \llbracket \xi_M \omega_{\mathfrak{g}/\mathfrak{p}} \wedge \rho \rrbracket_{\mathfrak{p}^\perp}.
\end{aligned} \tag{3.15}$$

Moreover since K is horizontal, (3.15) descends to a decomposition $K_M = T^\nabla + W^\nabla + C^\nabla$ of the curvature form $K_M \in \Omega^2(M; \mathfrak{g}_M)$ of ω .

Definition 3.34. The components $T^\nabla \in \Omega^2(M; TM)$, $W^\nabla \in \Omega^2(M; \mathfrak{p}_M^0)$ and $C^\nabla \in \Omega^2(M; T^*M)$ are known respectively as the *torsion*, the *Weyl curvature* and the *Cotton–York tensor* of the Weyl structure ξ_M .

It follows immediately from Corollary 3.13 that the curvature R^∇ of the tractor connection ∇^∇ on $\mathcal{V} := F^P \times_P \mathbb{V}$ acts via

$$R_{X,Y}^\nabla \cdot s = (T_{X,Y}^\nabla + W_{X,Y}^\nabla + C_{X,Y}^\nabla) \cdot s$$

for all $s \in \Omega^0(M; \mathcal{V})$. If the Cartan connection ω is normal then $\partial K = 0$ by definition, and since ∂ preserves the \mathfrak{p}^\perp -filtration of \mathfrak{g} we must also have $\partial T^\nabla = 0$, $\partial W^\nabla = 0$ and $\partial C^\nabla = 0$ as elements of $\Omega^1(M; TM)$, $\Omega^1(M; \mathfrak{p}_M^0)$ and $\Omega^1(M; T^*M)$ respectively.

In general it is quite difficult to describe the components $K_{\mathfrak{g}/\mathfrak{p}}$, $K_{\mathfrak{p}^0}$ and $K_{\mathfrak{p}^\perp}$ explicitly. As a first step, Proposition 3.18(2) implies the expressions on the first lines of these components in (3.15) descend to the Cartan torsion T_M , the curvature R^∇ of the Weyl connection ∇ , and the exterior covariant derivative $d^\nabla r^\nabla$ of the normalised Ricci tensor. The remaining terms are described as follows. [60, Thm. 5.2.9].

Theorem 3.35. *Choose a Weyl structure and let $\partial^* : T^*M \otimes \mathfrak{g}_M \rightarrow \wedge^2 T^*M \otimes \mathfrak{g}_M$ be the resulting bundle map induced by the Lie algebra differential ∂^* . Then*

$$K_M = (T^\nabla, R^\nabla, C^\nabla) + \partial^* r^\nabla$$

as an element of $\Omega^2(M; TM \oplus \mathfrak{p}_M^0 \oplus T^*M)$. In particular, the harmonic curvature K_\circ of ω coincides with the components of K_M lying in $\ker \square_M$. \square

In the sequel we shall be exclusively interested in abelian parabolic geometries, for which the curvature decomposition is straightforward to describe. Then since $\mathfrak{g}/\mathfrak{p}$ and

\mathfrak{p}^\perp are irreducible \mathfrak{p} -representations, (3.15) becomes

$$\begin{aligned} K_{\mathfrak{g}/\mathfrak{p}} &= \xi_M d\omega_{\mathfrak{g}/\mathfrak{p}} + \llbracket \xi_M \omega_{\mathfrak{g}/\mathfrak{p}} \wedge \omega_{\mathfrak{w}} \rrbracket \\ K_{\mathfrak{p}^0} &= (d\omega_{\mathfrak{w}} + \tfrac{1}{2} \llbracket \omega_{\mathfrak{w}} \wedge \omega_{\mathfrak{w}} \rrbracket) + \llbracket \xi_M \omega_{\mathfrak{g}/\mathfrak{p}} \wedge \rho \rrbracket \\ \text{and } K_{\mathfrak{p}^\perp} &= d\rho + \llbracket \omega_{\mathfrak{w}} \wedge \rho \rrbracket. \end{aligned}$$

The solder form $\omega_{\mathfrak{g}/\mathfrak{p}}$ defines an isomorphism $TM \cong \text{gr}(TM)$, so that the section of $T^*M \otimes TM$ induced by $\xi_M \omega_{\mathfrak{g}/\mathfrak{p}}$ is just the identity map. We conclude that

$$T^\nabla = T_M, \quad W^\nabla = R^\nabla + \llbracket \text{id} \wedge r^\nabla \rrbracket \quad \text{and} \quad C^\nabla = d^\nabla r^\nabla, \quad (3.16)$$

where $\llbracket \text{id} \wedge r^\nabla \rrbracket_{X,Y} := \llbracket X, r_Y^\nabla \rrbracket - \llbracket Y, r_X^\nabla \rrbracket$. In particular $T := T^\nabla$ is just the torsion of ∇ , which is independent of ∇ by Proposition 3.21 and the fact that $\llbracket \llbracket X, \gamma \rrbracket, Y \rrbracket = \llbracket \llbracket Y, \gamma \rrbracket, X \rrbracket$ for all $X, Y \in \Omega^0(M; TM)$ and $\gamma \in \Omega^1(M)$.

Normality of the Cartan connection is equivalent to having $\partial T = 0$; in this case, since $\partial W^\nabla = 0$ also, r^∇ is the unique solution of $\partial R^\nabla + \partial \llbracket \text{id} \wedge r^\nabla \rrbracket = 0$. Using that $\partial r^\nabla = 0$ automatically, $\llbracket \text{id} \wedge r^\nabla \rrbracket = \partial^* r^\nabla$ and that \square_M agrees with the algebraic laplacian $\square = \partial \partial^* + \partial^* \partial$ on T^*M , it follows that $r^\nabla = -\square_M^{-1} \partial R^\nabla$.

Theorem 3.36. *Let $(F^P \rightrightarrows M, \omega)$ be a normal abelian parabolic geometry of type G/P , and let ξ_M be a Weyl structure. Then:*

- (1) *The Weyl connections are precisely those with ∂ -closed torsion, which is invariant and coincides with the degree one component of the harmonic curvature.*
- (2) *$r^\nabla = -\square_M^{-1} \partial R^\nabla$, and the remaining components of the harmonic curvature are given by the components of $W^\nabla := R^\nabla + \llbracket \text{id} \wedge r^\nabla \rrbracket$ and $C^\nabla := d^\nabla r^\nabla$ in $\ker \square_M$.*
- (3) *Under infinitesimal change of Weyl structure, we have $\delta_\gamma T = 0$, $\delta_\gamma W^\nabla = \llbracket T, \gamma \rrbracket$, $\delta_\gamma r^\nabla = \nabla \gamma$, $\delta_\gamma R^\nabla = -\llbracket \text{id} \wedge \nabla \gamma \rrbracket + \llbracket T, \gamma \rrbracket$ and $\delta_\gamma C^\nabla = W^\nabla \cdot \gamma$. \square*

For proof of parts (1) and (2) of Theorem 3.36, see [59, §4.7] and [60, §5.2.3]. Part (3) follows easily from Proposition 3.21 and the relations (3.16).

3.3.3 Prolongation of BGG operators

The first BGG operator \mathcal{D}^∇ on a tractor bundle $\mathcal{V} := F^P \times_P \mathbb{V}$ is of finite type [49, 61], so that its kernel is finite dimensional. Such differential operators are typically studied by *prolongation* (i.e., by further differentiation) to obtain a closed system of PDEs describing the solutions. Branson *et al.* described a (non-invariant) method of prolongation for abelian parabolic geometries [39] which generalised examples from conformal geometry [93] and projective differential geometry [77, 78]. An invariant prolongation of the whole BGG sequence was later obtained by Hammerl *et al.* [95, 96].

Theorem 3.37. [95, Thm. 4.2] *There is a unique $(\text{im } \partial)$ -valued differential operator $\Phi : \Omega^k(M; \mathcal{V}) \rightarrow \Omega^{k+1}(M; \mathcal{V})$ such that the splitting operator $L^\mathbb{V} : H_k(\mathfrak{p}^\perp; \mathcal{V}) \rightarrow \wedge^k T^*M \otimes \mathcal{V}$ induces an isomorphism between $\ker \mathcal{D}^k$ and $\ker(d^\mathbb{V} + \Phi) \cap (\ker \partial)$.*

To describe this prolongation, note that the operators $d^\mathbb{V}$, L^k and \mathcal{D}^k from the BGG sequence may be arranged as in Figure 3.1. The key result is as follows [95, Thm. 3.2].

Proposition 3.38. *Figure 3.1 commutes if and only if $\partial \circ d^\mathbb{V} \circ d^\mathbb{V}$ vanishes on $\text{im } L^k$. In this case, L^k restricts to an isomorphism between $\ker \mathcal{D}^k$ and $(\ker d^\mathbb{V}) \cap (\ker \partial)$. \square*

It will not generally be the case that $\partial \circ d^\mathbb{V} \circ d^\mathbb{V} = 0$. To arrange this we will modify each $d^\mathbb{V}$ by a finite-order differential operator Φ so as not to change the resulting BGG operator \mathcal{D}^k , and such that $d^\mathbb{V} := d^\mathbb{V} + \Phi$ satisfies $\partial \circ d^\mathbb{V} \circ d^\mathbb{V} = 0$. We thus obtain a bijection between $\ker \mathcal{D}^k$ and $(\ker d^\mathbb{V}) \cap (\ker \partial)$ as above.

$$\begin{array}{ccc} \wedge^k T^*M \otimes \mathcal{V} & \xrightarrow{d^\mathbb{V}} & \wedge^{k+1} T^*M \otimes \mathcal{V} \\ L^k \uparrow & & \uparrow L^{k+1} \\ H_k(\mathfrak{p}^\perp; \mathcal{V}) & \xrightarrow{\mathcal{D}^k} & H_{k+1}(\mathfrak{p}^\perp; \mathcal{V}). \end{array}$$

Figure 3.1: The k th square of the curved BGG sequence on \mathcal{V} .

To construct Φ , note that the \mathfrak{p}^\perp -filtration $\mathbb{V} = \mathbb{V}_N \supset \dots \supset \mathbb{V}_0 \supset 0$ of \mathbb{V} induces a P -invariant filtration of the Lie algebra chain space $C_k(\mathfrak{p}^\perp; \mathbb{V}) := \wedge^k \mathfrak{p}^\perp \otimes \mathbb{V}$ in the obvious way. This in turn induces a filtration⁵ $A = A_k \supset \dots \supset A_0 \supset 0$ of

$$A := \text{Hom}(\wedge^k \mathfrak{p}^\perp \otimes \mathbb{V}, \wedge^{k+1} \mathfrak{p}^\perp \otimes \mathbb{V}),$$

where $\Phi \in A_i$ if and only if $\Phi(\wedge^k \mathfrak{p}^\perp) \otimes \mathbb{V}_j \subseteq \wedge^{k+1} \mathfrak{p}^\perp \otimes \mathbb{V}_{i+j}$ for all j . This is clearly P -invariant, so induces a filtration of $\mathcal{A} := F^P \times_P A$ by smooth subbundles \mathcal{A}_i .

Lemma 3.39. *Let $\Phi \in \Omega^0(M; \mathcal{A}_1)$ with $\text{im } \Phi \subseteq \text{im } \partial$. Then the BGG operators \mathcal{D}^k and L^k are unchanged by the replacement of $d^\mathbb{V}$ with $d^\mathbb{V} + \Phi$. \square*

Such a replacement clearly does not affect the conclusion of Proposition 3.38, so it remains to construct a suitable Φ . Recalling that $d^\mathbb{V} \circ d^\mathbb{V} = R^{d^\mathbb{V}}$ is just the curvature of $d^\mathbb{V}$, we define

$$\Phi(s) := -\square_M^{-1} \partial(R^{d^\mathbb{V}} \cdot s)$$

for each $s \in \Omega^k(M; \mathcal{V})$, which is well-defined by Proposition 3.31. Then Φ takes values in $\text{im } \partial$, since \square_M (and hence \square_M^{-1}) commutes with ∂ , and moreover $\Phi \in \Omega^0(M; \mathcal{A}_1)$ by

⁵This is the ‘‘diagonal’’ filtration from [95, p. 12].

properties of ∂ and $d^\mathbb{V}$. Therefore by Lemma 3.39 we may replace $d^\mathbb{V}$ with $d^\mathcal{V} := d^\mathbb{V} + \Phi$ at each stage without affecting the BGG operators, for which

$$\begin{aligned}\partial(R^{d^\mathcal{V}} \cdot s) &= \partial(R^{d^\mathbb{V}} \cdot s) - \partial d^\mathbb{V} \square_M^{-1} \partial(R^{d^\mathbb{V}} \cdot s) \\ &= \partial(R^{d^\mathbb{V}} \cdot s) - \square_M \square_M^{-1} \partial(R^{d^\mathbb{V}} \cdot s) = 0\end{aligned}$$

since $\square_M = \partial \circ d^\mathbb{V}$ on $\text{im } \partial \subseteq \ker \partial$. By Proposition 3.38, the splitting operator constructed from $d^\mathcal{V}$ then provides the prolongation of the BGG operator \mathcal{D}^k . It is easy to see that Φ is the unique differential correction with the desired properties.

Definition 3.40. $d^\mathcal{V} := d^\mathbb{V} - \square_M^{-1} \partial(R^{d^\mathbb{V}})$ is the *prolongation operator* of \mathcal{D}^k .

Note that $\Phi := -\square_M^{-1} \partial(R^{d^\mathbb{V}})$ is not algebraic in general. Indeed, each term $\square_M - \square$ appearing in the Neumann series (3.12) for \square_M^{-1} is typically first-order, so that Φ has order bounded above by the height N of the \mathfrak{p}^\perp -filtration of \mathbb{V} .

When the representation \mathbb{V} is given, the correction Φ can be computed using a Weyl structure; independence from the choice of Weyl structure is ensured by the uniqueness of Φ . Then the Lie algebra differential and the algebraic laplacian induce commuting bundle maps ∂^* and $\square = \partial \partial^* + \partial^* \partial$. By Theorem 2.31, \square acts by a scalar on each irreducible graded component of \mathcal{V} , while (3.11) and the Neumann series of Proposition 3.31 allow us to compute the action of \square_M^{-1} on graded components.

For first BGG operators, where $R^{d^\mathcal{V}} = d^\mathbb{V} \circ d^\mathbb{V}$ is just the tractor curvature $R^\mathbb{V}$, we obtain a modification $\Phi := -\square_M^{-1} \partial(R^\mathbb{V})$. In general Φ is not algebraic, so that $d^\mathcal{V}$ is not necessarily a connection on \mathcal{V} . In cases where Φ is algebraic, we refer to $\nabla^\mathcal{V} := d^\mathcal{V}$ as the *prolongation connection* on \mathcal{V} . Due to a differential Bianchi identity, it will turn out that Φ is indeed algebraic in all cases that we are interested in; see Section 7.4.

Remark 3.41. Hammerl *et al.* [96, §1.4] also provide an iterative method for constructing a prolongation *connection* $\nabla^\mathcal{V}$ on \mathcal{V} . The process starts with $\nabla^0 := \nabla^\mathbb{V}$. Then if ϕ_i is the non-zero graded component of $\partial(R^{\nabla^i})$ of highest weight, one defines $\nabla^{i+1} := \nabla^i - \square^{-1} \phi_i$, eventually reaching an invariant prolongation connection $\nabla^\mathcal{V}$ whose curvature satisfies $\partial(R^{\nabla^\mathcal{V}}) = 0$. However, in the sequel we shall calculate using \square_M^{-1} due to the aforementioned differential Bianchi identity.

Projective differential geometry

Projective differential geometry is a classical subject which studies the behaviour of unparametrised geodesics. This leads to an equivalence relation among riemannian metrics, where two metrics are *projectively equivalent* if they have the same geodesics (as unparametrised curves). We begin in Section 4.1 with a review of the classical approach to the theory, including the so-called *main equation* describing the set of projectively equivalent metrics. We describe projective differential geometry as an abelian parabolic geometry in Section 4.2, where the pertinent Lie algebras are $\mathfrak{g} = \mathfrak{sl}(n+1, \mathbb{R})$ with parabolic \mathfrak{p} given by crossing the last node. The flat model is then $G \cdot \mathfrak{p} \cong \mathbb{RP}^n$ which, as we saw in Remark 3.28, is problematic for the general equivalence of categories. We indicate how to obtain an equivalence using P -frame bundles in Subsection 4.2.2.

In the parabolic picture, the main equation may be interpreted as the first BGG operator associated to the representation $\mathbb{W} = S^2\mathbb{R}^{n+1}$ of \mathfrak{g} . We describe the resulting differential equation in Section 4.3, as well as obtaining the prolongation given by Eastwood and Matveev [77] in index-free notation. Finally, we make an observation regarding the representation \mathbb{W} which is crucial for later generalisations: the direct sum $\mathfrak{h} := \mathbb{W} \oplus (\mathfrak{g} \oplus \mathbb{R}) \oplus \mathbb{W}^*$ is a graded Lie algebra isomorphic to $\mathfrak{sp}(2n+2, \mathbb{R})$.

4.1 Classical definition and results

We begin by reviewing the classical formulation of projective differential geometry. For greater generality we allow non-degenerate metrics of arbitrary signature, reserving the adjective *riemannian* for positive definite metrics. In what follows, suppose that (M, g) is an n -dimensional (pseudo-)riemannian manifold with Levi-Civita connection ∇ .

Definition 4.1. A smooth curve $\gamma \subset M$ is a *geodesic* of g if $\nabla_X X \in \langle X \rangle$ for every vector field X tangent to γ . Two metrics g, \hat{g} are called *projectively equivalent* if they have the same geodesics (as unparameterised curves).

Note that we do not require geodesics to be affinely parameterised. The term *geodesically equivalent* is also used in the literature; however, we will use the former

to emphasise the underlying projective geometry. The following characterisation of projectively equivalent metrics is well-known [34, 77, 178].

Lemma 4.2. *Metrics g, \hat{g} are projectively equivalent if and only if their Levi-Civita connections $\nabla, \hat{\nabla}$ are related by*

$$\begin{aligned} \hat{\nabla}_X Y &= \nabla_X Y + \llbracket X, \alpha \rrbracket^r \cdot Y \\ \text{where } \llbracket X, \alpha \rrbracket^r \cdot Y &:= \frac{1}{2} (\alpha(X)Y + \alpha(Y)X) \end{aligned} \quad (4.1)$$

for some $\alpha \in \Omega^1(M)$ and all $X, Y \in \Omega^0(M; TM)$.

Proof. Since $\nabla, \hat{\nabla}$ have the same unparametrised geodesics, it follows from Definition 4.1 that $\hat{\nabla}_X X - \nabla_X X = \alpha(X)X$ for some smooth function $\alpha : TM \rightarrow \mathbb{R}$. By basic properties of linear connections we see that in fact $\alpha \in \Omega^1(M)$, so that $X \mapsto \alpha(X)X$ defines a quadratic form $\Omega^0(M; TM) \times \Omega^0(M; TM) \rightarrow \Omega^0(M; TM)$. Polarisation yields

$$(\hat{\nabla}_X Y - \nabla_X Y) + (\hat{\nabla}_Y X - \nabla_Y X) = \alpha(X)Y + \alpha(Y)X \quad (4.2)$$

which, upon noting that the left-hand side in (4.2) equals $2(\hat{\nabla}_X Y - \nabla_X Y)$ since both $\nabla, \hat{\nabla}$ are torsion-free, gives (4.1). \square

Remark 4.3. We call the endomorphism $\llbracket X, \alpha \rrbracket^r \in \mathfrak{gl}(TM)$ the *algebraic bracket* of X and α . It is clear that $\llbracket X, \alpha \rrbracket^r \cdot Y$ is symmetric in X, Y , and we may write $\llbracket \cdot, \alpha \rrbracket^r = \text{id} \odot \alpha \in \Omega^1(M; \mathfrak{gl}(TM))$. Note that the factor $\frac{1}{2}$ in the definition (4.1) is a non-standard normalisation convention; the reason for this choice will become apparent later.

Fix a local frame $\{e_i\}_i$ of TM with dual coframe $\{\varepsilon^i\}_i$. Using the standard formula $\text{div}_g X = \frac{1}{2} \partial_{e_i} (\log(\det g) \varepsilon^i(X))$ for the divergence of X with respect to g (see for example [125, p. 436]), taking a trace in (4.1) yields

$$\alpha = \frac{1}{n+1} \text{d} \left(\log \frac{\det \hat{g}}{\det g} \right). \quad (4.3)$$

In particular, α is an exact 1-form which depends only on g and \hat{g} .

A naïve first approach to studying projectively equivalent pairs g, \hat{g} might be via the endomorphism G satisfying $\hat{g} = g(G \cdot, \cdot)$; equivalently $G = \sharp \circ \hat{\flat}$, where $\flat = \sharp^{-1}$ and $\hat{\flat} = \hat{\sharp}^{-1}$ are the usual musical isomorphisms of g and \hat{g} respectively. However, it turns out to be more fruitful to instead study the endomorphism

$$A(g, \hat{g}) := \left(\frac{\det \hat{g}}{\det g} \right)^{1/(n+1)} \hat{\sharp} \circ \flat. \quad (4.4)$$

Clearly $A(g, \hat{g})$ is invertible with inverse $A(\hat{g}, g)$, and is self-adjoint with respect to both g, \hat{g} . The endomorphisms G and $A := A(g, \hat{g})$ are related by $A = (\det G)^{1/(n+1)} G^{-1}$, or

equivalently $G = (\det A)^{-1}A^{-1}$. Moreover \hat{g} can be recovered from the pair (g, A) as

$$\hat{g} = (\det A)^{-1}g(A^{-1} \cdot, \cdot). \quad (4.5)$$

The following result explains the key benefit of using A over G : it satisfies a first-order linear differential equation. We reproduce the proof from [34, Thm. 2] here for completeness, which the authors attribute to [79] (although see Remark 4.5 below).

Proposition 4.4. *Let g, \hat{g} be metrics with Levi-Civita connections $\nabla, \hat{\nabla}$ respectively. Then g, \hat{g} are projectively equivalent if and only if $A = A(g, \hat{g})$ defined by (4.4) satisfies the first-order linear differential equation*

$$g((\nabla_X A) \cdot, \cdot) = X^\flat \odot \mu \quad (4.6)$$

for some $\mu \in \Omega^1(M)$ and all $X \in \Omega^0(M; TM)$. In this case $\hat{\nabla} = \nabla + \llbracket \cdot, \alpha \rrbracket^r$, where $\alpha \in \Omega^1(M)$ satisfies $\mu = -\alpha(A \cdot) = d(\text{tr } A)$.

Proof. By Lemma 4.2, g, \hat{g} are projectively equivalent if and only if $\hat{\nabla} = \nabla + \llbracket \cdot, \alpha \rrbracket^r$ for some $\alpha \in \Omega^1(M)$. In this case, differentiation gives

$$\begin{aligned} (\nabla_X \hat{g})(Y, Z) &= (\hat{\nabla}_X \hat{g})(Y, Z) - (\llbracket X, \alpha \rrbracket^r \cdot \hat{g})(Y, Z) \\ &= \hat{g}(\llbracket X, \alpha \rrbracket^r \cdot Y, Z) + \hat{g}(Y, \llbracket X, \alpha \rrbracket^r \cdot Z) \\ &= \alpha(X)\hat{g}(Y, Z) + \frac{1}{2}\alpha(Y)\hat{g}(X, Z) + \frac{1}{2}\alpha(Z)\hat{g}(X, Y) \\ &= (\det A)^{-1} [\alpha(X)g(A^{-1}Y, Z) + \frac{1}{2}\alpha(Y)g(A^{-1}X, Z) + \frac{1}{2}\alpha(Z)g(A^{-1}X, Y)]. \end{aligned}$$

On the other hand, (4.5) and the identity $\nabla_X A^{-1} = -A^{-1} \circ \nabla_X A \circ A^{-1}$ give

$$\begin{aligned} \nabla_X \hat{g} &= \nabla_X ((\det A)^{-1}g(A^{-1} \cdot, \cdot)) \\ &= -(\det A)^{-2}d(\det A)(X)g(A^{-1} \cdot, \cdot) - (\det A)^{-1}g(\nabla_X A \circ A^{-1} \cdot, A^{-1} \cdot) \\ &= (\det A)^{-1} [-d(\log \det A)(X)g(A^{-1} \cdot, \cdot) - g(\nabla_X A \circ A^{-1} \cdot, A^{-1} \cdot)] \\ &= (\det A)^{-1} [\alpha(X)g(A^{-1} \cdot, \cdot) - g(\nabla_X A \circ A^{-1} \cdot, A^{-1} \cdot)], \end{aligned}$$

where the last line follows by (4.3). Comparing these two expressions and precomposing with A^{-1} in both slots yields (4.6), with $\mu := -\alpha(A \cdot)$. Raising an index using g yields $(\nabla_X A)Y = \frac{1}{2}(g(X, Y)\mu^\sharp + \mu(Y)X)$, so that taking a trace over Y in the last display equation gives $\mu = d(\text{tr } A)$ as required. \square

Remark 4.5. Equation (4.6) was known to Sinjukov [166], and is referred to as the *Sinjukov equation* in a sizeable amount of the literature (see for example [30, 34, 111]). Equivalent equations may also be found in [98]. To avoid any historical misattribution, we shall call it the *main equation* of projective differential geometry.

Mikeš later prolonged the main equation to obtain a closed differential system controlling the metrics projectively equivalent to g [145]. We shall study the invariant version of this prolongation, described by Eastwood and Matveev [77], in Section 4.3.

It is clear from (4.6) that projectively equivalent metrics g, \hat{g} are affinely equivalent if and only if $A(g, \hat{g})$ is a multiple of the identity, if and only if $\mu = d(\text{tr } A)$ vanishes.

Proposition 4.4 states that a solution (g, A) of the main equation is equivalent to a projectively equivalent pair of metrics $g, \hat{g} := (\det A)^{-1}g(A^{-1} \cdot, \cdot)$. Linearity of (4.6) also implies that $(g, A_t := A - t\text{id})$ is a solution for all $t \in \mathbb{R}$ with $\det A_t \neq 0$. We then have a 1-parameter family of metrics $g_t := (\det A_t)^{-1}g(A_t^{-1} \cdot, \cdot)$ projectively equivalent to g ; we will study this *metrisability pencil* in more detail in Chapter 8.

Finally, let us indicate the link between the classical theory above and the description as a parabolic geometry outlined in the following section. Since geodesics are really a feature of connections rather than metrics, call two linear connections $\nabla, \hat{\nabla}$ *projectively equivalent* if $\hat{\nabla}_X = \nabla_X + \llbracket X, \alpha \rrbracket^r$ for some $\alpha \in \Omega^1(M)$, with $\llbracket X, \alpha \rrbracket^r$ the algebraic bracket from (4.1). A *projective structure* on M is an equivalence class $[\nabla]^r$ of projectively equivalent connections; $\llbracket \cdot, \alpha \rrbracket^r$ defines an embedding $\Omega^1(M) \hookrightarrow \Omega^1(M; \mathfrak{gl}(TM))$, exhibiting the projective class $[\nabla]^r$ as an affine space modelled on $\Omega^1(M)$.

Lemma 4.6. *There is a bijection between connections $\nabla \in [\nabla]^r$ and connections on the line bundle $\mathcal{L} := (\wedge^n TM)^{2/(n+1)}$, where $\nabla, \hat{\nabla} \in [\nabla]^r$ are related by $\alpha \in \Omega^1(M)$ if and only if α is the change of induced connection on \mathcal{L} .*

Proof. Firstly, note that since $\wedge^n TM$ is an oriented line bundle it admits oriented roots; thus \mathcal{L} is well-defined. Now recall that an element of $\mathfrak{gl}(TM)$ acts on $\wedge^n TM$ by its trace. Using (4.1), this means that $\llbracket X, \alpha \rrbracket^r$ acts on $\wedge^n TM$ by multiplication by $\frac{1}{2}(n+1)\alpha(X)$, and hence on \mathcal{L} by multiplication by $\alpha(X)$. It follows that the difference of the connections induced on \mathcal{L} by $\nabla, \hat{\nabla}$ is precisely α . \square

We may also consider projective structures $[\nabla]^r$ whose connections have torsion. The symmetry of $\llbracket X, \alpha \rrbracket^r \cdot Y$ in X, Y implies that all connections in $[\nabla]^r$ have the same torsion T , which is then an invariant of the projective structure.

4.2 Description as a parabolic geometry

Real projective space \mathbb{RP}^n may be described equivalently as either the set of lines through the origin in \mathbb{R}^{n+1} , or as the quotient of the n -sphere \mathbb{S}^n by the \mathbb{Z}_2 -action induced by its antipodal map. The sphere has a canonical *round metric* for each signature (p, q) , given by pulling back the euclidean metric of signature $(p+1, q)$ on \mathbb{R}^{n+1} to \mathbb{S}^n , with respect to which the antipodal map is a local isometry. Thus \mathbb{RP}^n inherits a

canonical metric g_{FS} of constant curvature and signature (p, q) which we call the *Fubini–Study metric*. Let ∇^{FS} be the Levi-Civita connection of g_{FS} . It is straightforward to describe the geodesics of the projective structure $[\nabla^{\text{FS}}]$: the embedded projective lines $\mathbb{RP}^1 \hookrightarrow \mathbb{RP}^n$ are totally geodesic, so the geodesics of $[\nabla^{\text{FS}}]$ are the smooth curves contained in such a line. In an affine chart these curves lie within a line in \mathbb{R}^n so that, from the point of view of geodesics, \mathbb{RP}^n is the natural compactification of \mathbb{R}^n . For this reason, \mathbb{RP}^n is a good candidate for the flat model of projective differential geometry.

Of course, projective differential geometry was first described as a Cartan geometry by Cartan [63, 64], and the projective equivalence problem was solved by Thomas [173] shortly afterwards. A modern version of Cartan and Thomas’ work may be found in [165, §8] and [18] respectively. Readable accounts of projective differential geometry from the point of view of parabolic geometry may be found in [60, §4.1.5] and [42, 75, 77].

4.2.1 The flat model \mathbb{RP}^n

As a generalised flag manifold, \mathbb{RP}^n may be identified with G/P for

$$G := \text{PGL}(n+1, \mathbb{R}) := \text{GL}(n+1, \mathbb{R})/\langle \text{id} \rangle$$

and $P \leq G$ the (projection to G of) the $\text{GL}(n+1, \mathbb{R})$ -stabiliser of a chosen line $\langle v_0 \rangle$ in \mathbb{R}^{n+1} . The Lie algebra of G is the split real form $\mathfrak{g} := \mathfrak{sl}(n+1, \mathbb{R})$ of $\mathfrak{sl}(n+1, \mathbb{C})$, while the parabolic subalgebra \mathfrak{p} corresponds to crossing the last node:

$$\mathfrak{p} := \circ - \circ \cdots - \circ - \mathbf{x} \leq \circ - \circ \cdots - \circ - \circ = \mathfrak{g}. \quad (4.7)$$

Thus projective differential geometry is an abelian parabolic geometry, with Killing polar $\mathfrak{p}^\perp \cong \mathbb{R}^{n*}$ and reductive Levi factor $\mathfrak{p}^0 := \mathfrak{p}/\mathfrak{p}^\perp$. A choice of algebraic Weyl structure splits the \mathfrak{p}^\perp -filtration $\mathfrak{g} \supset \mathfrak{p} \supset \mathfrak{p}^\perp \supset 0$ of \mathfrak{g} , determining an isomorphism $\mathfrak{g} \cong \mathfrak{g}/\mathfrak{p} \oplus \mathfrak{p}^0 \oplus \mathfrak{p}^\perp$. Evidently such a choice is equivalent to a choice of a subspace of \mathbb{R}^{n+1} complementary to $\langle v_0 \rangle$, thus yielding a decomposition

$$\mathfrak{sl}(n+1, \mathbb{R}) = \left\{ \left(\begin{array}{cc} -\text{tr } A & \alpha \\ X & A \end{array} \right) \middle| X \in \mathbb{R}^n, \alpha \in \mathbb{R}^{n*}, A \in \mathfrak{gl}(n, \mathbb{R}) \right\} \quad (4.8)$$

of \mathfrak{g} . There is a corresponding decomposition of $\text{PGL}(n+1, \mathbb{R})$ in which the Levi subgroup $P^0 := P/\exp \mathfrak{p}^\perp$ consists of (equivalence classes of) block-diagonal matrices in G ; clearly the adjoint action of P^0 on $\mathfrak{g}/\mathfrak{p} \cong \mathbb{R}^n$ induces an isomorphism $\mathfrak{p}^0 \cong \mathfrak{gl}(n, \mathbb{R})$. Then $\mathfrak{p}^\perp \cong \mathbb{R}^{n*}$ consists of matrices with only the α -block, $\mathfrak{p}^0 \cong \mathfrak{gl}(n, \mathbb{R})$ of block-diagonal matrices, and $\mathfrak{p} \cong \mathfrak{gl}(n, \mathbb{R}) \ltimes \mathbb{R}^{n*}$ of block upper-triangular matrices.

Suppose we have chosen an algebraic Weyl structure, so that $\mathfrak{g} \cong \mathbb{R}^n \oplus \mathfrak{gl}(n, \mathbb{R}) \oplus \mathbb{R}^{n*}$. Using the description (4.8) we can write down the Lie bracket between elements of the three summands: if $X, Y \in \mathbb{R}^n$, $A, B \in \mathfrak{gl}(n, \mathbb{R})$ and $\alpha, \beta \in \mathbb{R}^{n*}$ then

$$[X, Y] = 0 = [\alpha, \beta], \quad [A, B] = AB - BA, \quad [A, X] = AX \quad \text{and} \quad [A, \alpha] = -\alpha \circ A,$$

so that $\mathbb{R}^n, \mathbb{R}^{n*}$ form abelian subalgebras on which $\mathfrak{gl}(n, \mathbb{R})$ acts in the natural way; meanwhile \mathbb{R}^n and \mathbb{R}^{n*} bracket into $\mathfrak{p}^0 \cong \mathfrak{gl}(n, \mathbb{R})$ according to

$$[[X, \alpha], Y] = \alpha(X)Y + \alpha(Y)X. \tag{4.9}$$

After appropriately normalising the inclusion $[\mathbb{R}^n, \mathbb{R}^{n*}] \hookrightarrow \mathfrak{gl}(n, \mathbb{R})$, Proposition 3.21 implies that a change of Weyl structure is precisely a change of connection within the projective class according to (4.1). We will justify this normalisation in Chapter 7.

Finally, the Satake diagram (4.7) and Proposition 2.22 tells us that there is a projective embedding $G \cdot \mathfrak{p} \hookrightarrow \mathbb{P}(\mathbb{V}^*)$ for any irreducible \mathfrak{g} -representation \mathbb{V} whose highest weight is supported on the right-most node. These representations are precisely the symmetric powers $\mathbb{V}_k := S^k \mathbb{R}^{n+1*}$ of the co-standard representation, so that the embedding $\mathbb{R}\mathbb{P}^n \hookrightarrow \mathbb{P}(S^k \mathbb{R}^{n+1})$ is the (degree k) Veronese embeddings defined by $[v] \mapsto [v \otimes \cdots \otimes v]$; see [97]. Of course, the Veronese embeddings are not minimal for $k > 1$, and Kostant's Theorem 2.25 identifies $\mathbb{R}\mathbb{P}^n$ with the intersection of quadrics given by projection away from the Cartan square in $S^2 \mathbb{V}_k$. For later developments we are mostly interested in the case $k = 2$, corresponding to the representation $\mathbb{W}^* := \mathbb{V}_2 = S^2 \mathbb{R}^{n+1*}$. By the description of the Cartan product in $\mathfrak{g} = \mathfrak{sl}(n+1, \mathbb{R})$ from [74], the \mathfrak{g} -representation $S^2 \mathbb{W}^*$ decomposes into irreducible pieces as

$$S^2 \mathbb{W} = S^2 \left(\begin{array}{cccc} 2 & 0 & & 0 & 0 \\ \circ - \circ & \cdots & \circ - \circ & & \\ \circ - \circ & & & & \end{array} \right) = \begin{array}{c} 4 \quad 0 \quad \cdots \quad 0 \quad 0 \\ \circ - \circ \quad \cdots \quad \circ - \circ \\ S^4 \mathbb{R}^{n+1} \end{array} \oplus \begin{array}{c} 0 \quad 2 \quad 0 \quad \cdots \quad 0 \quad 0 \\ \circ - \circ - \circ \quad \cdots \quad \circ - \circ \\ \odot^2 \wedge^2 \mathbb{R}^{n+1} \end{array},$$

where the first summand is the Cartan square. Thus

$$\mathbb{U}^* := \begin{array}{c} 0 \quad 0 \quad \cdots \quad 0 \quad 2 \quad 0 \\ \circ - \circ \quad \cdots \quad \circ - \circ - \circ \\ \odot^2 \wedge^2 \mathbb{R}^{n+1*} \end{array}$$

is the space of homogeneous quadratic equations which cut out $\mathbb{R}\mathbb{P}^n$ as an intersection of quadrics. In particular, \mathbb{U}^* is an irreducible \mathfrak{g} -representation.

4.2.2 Recovering the Cartan connection

Recall from Subsection 3.2.3 that the general equivalence of categories result for a parabolic geometry requires that the first homology $H_1(\mathfrak{p}^\perp; \mathfrak{g})$ has no component in

homogeneity one. We shall see why this condition is problematic for $\mathfrak{g} = \mathfrak{sl}(n+1, \mathbb{R})$ shortly, but it is already possible to see that the underlying infinitesimal flag structure carries no information. Indeed, the choice of an algebraic Weyl structure determines an isomorphism of the Levi subgroup $P^0 := P/\exp \mathfrak{p}^\perp$ with $GL(n, \mathbb{R})$. Then the principal P^0 -bundle $F^0 := F^P/\exp \mathfrak{p}^\perp$, from which one obtains the Cartan bundle F^P by prolongation, is simply the full $GL(n, \mathbb{R})$ -frame bundle of M . Of course, a principal $GL(n, \mathbb{R})$ -bundle with its solder form contains no geometric information.

To see why the homogeneity condition is problematic for $\mathfrak{sl}(n+1, \mathbb{R})$, suppose that \mathfrak{g} is a simple Lie algebra. Choose a Cartan subalgebra \mathfrak{t} and a positive subsystem Δ^+ with respect to which $\beta \in \mathfrak{t}^*$ is the highest root of \mathfrak{g} , and suppose that $\mathfrak{p} \leq \mathfrak{g}$ is a standard parabolic corresponding to a subset $\Sigma \subseteq \Delta^0$ of simple roots. It is proved in [60, Prop. 3.3.7] that $H_1(\mathfrak{p}^\perp; \mathfrak{g})$ can have no irreducible components in homogeneity one unless $\Sigma = \{\alpha\}$ consists of a single simple root; in this case the irreducible components are in bijection with the simple roots α_i for which the Cartan integers $\frac{2\langle \beta, \alpha_i \rangle}{\langle \alpha_i, \alpha_i \rangle}$ and $\frac{2\langle \beta, \alpha \rangle}{\langle \alpha, \alpha \rangle}$ are equal and non-zero. The highest root of $\mathfrak{g} = \mathfrak{sl}(n+1, \mathbb{R})$ is

$$\mathfrak{g} = \begin{array}{cccc} 1 & 0 & \dots & 0 & 1 \\ \circ & \text{---} & \circ & \dots & \text{---} & \circ & \text{---} & \circ & \text{---} & \circ \end{array}, \quad (4.10)$$

so that only the parabolics

$$\times \text{---} \circ \text{---} \dots \text{---} \circ \text{---} \circ \quad \text{and} \quad \circ \text{---} \circ \text{---} \dots \text{---} \circ \text{---} \times$$

have a non-trivial component of $H_1(\mathfrak{p}^\perp; \mathfrak{g})$ of homogeneity one. Of course, the resulting R-spaces are dual projective spaces and correspond to our choice from (4.7).

Given the problems above, we must work a little harder to achieve an equivalence of categories between projective structures on M and normal Cartan connections. This entails constructing a so-called *P-frame bundle of degree one* over M , which is a principal P -bundle F^P over M together with a $(\mathfrak{g}/\mathfrak{p}^\perp)$ -valued 1-form θ such that:

- θ is invariant under the P -action induced on $\mathfrak{g}/\mathfrak{p}^\perp$ by the adjoint action;
- $\ker \theta$ is the space of vector fields generated by the action of $\mathfrak{p}^\perp \subset \mathfrak{p}$; and
- θ maps the vertical bundle of F^P to $\mathfrak{p}/\mathfrak{p}^\perp$, via $\eta(X^\xi) = \xi + \mathfrak{p}^\perp$ for all $\xi \in \mathfrak{p}$.

It turns out that a P -frame bundle of degree one contains just enough geometric information to obtain an equivalence of categories for projective differential geometry. We outline the proof of this equivalence, whose full proof may be found in [60, Prop. 4.1.5].

Theorem 4.7. *There is an equivalence of categories between projective structures on M and P -frame bundles of degree one of type G/P . A projective structure is torsion-free if and only if the corresponding P -frame bundle is normal.*

Sketch proof. Fix an algebraic Weyl structure for \mathfrak{g} , so that $\mathfrak{g}/\mathfrak{p} \cong \mathbb{R}^n$, $\mathfrak{p}^0 \cong \mathfrak{gl}(n, \mathbb{R})$ and $\mathfrak{p}^\perp \cong \mathbb{R}^{n*}$. Suppose first that $[\nabla]^r$ is a projective structure on M and consider the frame bundle $F^0 := \text{GL}(TM)$ of M with its canonical solder form $\eta \in \Omega^1(F^0; \mathfrak{g}/\mathfrak{p})$. Then each $\nabla \in [\nabla]^r$ induces a principal \mathfrak{p}^0 -connection 1-form γ^∇ on the full frame bundle F^0 of M . We construct a principal P -bundle F^P over M with fibre $F_u^P := \{\gamma_u^\nabla \mid \nabla \in [\nabla]^r\}$ over F^0 , with action of $g = g_0 \exp \alpha \in P \cong P^0 \ltimes \exp \mathfrak{p}^\perp$ given by

$$(\gamma_u^\nabla \cdot g)(X) = \gamma_{u \cdot g_0}^\nabla(X) + [\alpha, \eta(X)]. \quad (4.11)$$

One then checks that F^P is indeed a principal P -bundle over M , and for each $\gamma_u^\nabla \in F_u^P$ the 1-form $\eta + \gamma_u^\nabla$ pulls back to a P -frame form θ on F^P . Moreover, as we vary $\alpha \in \mathfrak{p}^\perp$ in (4.11) the $\gamma^\nabla \cdot g$ run over all connections in the projective class.

Conversely, suppose that (F^P, θ) is a P -frame bundle of degree one. The quotient bundle $F^0 := F^P / \exp \mathfrak{p}^\perp$ is the frame bundle of M , and projecting the values of θ onto $\mathfrak{g}/\mathfrak{p}$ yields the solder form η on F^0 . Choosing a local section $\sigma : U \rightarrow F^P$, it turns out that σ pulls back the \mathfrak{p}^0 -component of θ to a principal \mathfrak{p}^0 -connection γ^σ on $F^0|_U$. Replacing the local section σ by $\hat{\sigma} = \sigma \cdot g_0 \exp \alpha$ for local functions $g_0 : U \rightarrow P^0$ and $\alpha : U \rightarrow \mathfrak{p}^\perp$, the principal connections on F^0 change according to $\gamma^{\hat{\sigma}} = \gamma^\sigma + [\cdot, \alpha]$. Equation (4.9) then implies that the space of linear connections determined by all such σ constitute a projective structure $[\nabla]^r$ over $U \subset M$. Patching these local projective structures together yields a projective structure on M .

If γ^∇ is the principal connection 1-form corresponding to $\nabla \in [\nabla]^r$, viewed as the \mathfrak{p}^0 -component of the P -frame form θ , its torsion coincides with the torsion of the P -frame bundle. A P -frame bundle is normal if and only if its torsion lies in the kernel of the principal bundle map induced by the Lie algebra homology map $\partial : \wedge^2 \mathfrak{p}^\perp \otimes \mathfrak{g} \rightarrow \mathfrak{p}^\perp \otimes \mathfrak{g}$, which turns out to be injective for this choice of \mathfrak{g} . Thus the P -frame bundle is normal if and only if the torsion of the projective structure vanishes. \square

4.2.3 Representations of $\mathfrak{sl}(n+1, \mathbb{R})$

For later use let us describe some important \mathfrak{g} - and \mathfrak{p} -representations, as well as their associated bundles. The adjoint representation of \mathfrak{g} has highest weight given by (4.10), so that the isotropy representation $\mathfrak{g}/\mathfrak{p}$ and its dual $(\mathfrak{g}/\mathfrak{p})^* \cong \mathfrak{p}^\perp$ have highest weights

$$\mathfrak{g}/\mathfrak{p} = \begin{array}{cccc} 1 & 0 & 0 & 1 \\ \circ & \circ & \cdots & \circ \rightarrow \mathbf{x} \end{array} \quad \text{and} \quad \mathfrak{p}^\perp = \begin{array}{cccc} 0 & 0 & 0 & 1 \ -2 \\ \circ & \circ & \cdots & \circ \rightarrow \mathbf{x} \end{array}$$

respectively as \mathfrak{p} -representations. By the Cartan condition, the corresponding associated bundles are TM and T^*M , and a Weyl structure gives an isomorphism $\mathfrak{g}_M \cong TM \oplus \mathfrak{gl}(TM) \oplus T^*M$. The top exterior power of $\mathfrak{g}/\mathfrak{p}$ is the derivative of

the group character $\det : \mathrm{GL}(n, \mathbb{R}) \rightarrow \mathbb{R}$, so its highest weight has coefficient $n + 1$ over the crossed node; it follows that the line bundle $\mathcal{L} := (\wedge^n TM)^{2/(n+1)}$ of Lemma 4.6 is associated to the 1-dimensional representation

$$L = \begin{array}{cccc} 0 & 0 & \cdots & 0 & 2 \\ \circ & \text{---} & \circ & \cdots & \text{---} & \circ & \text{---} & \times \end{array} . \quad (4.12)$$

Note that L is the zeroth homology $H_0(\mathfrak{p}^\perp; \mathbb{W}^*)$, where $\mathbb{W} := \mathbb{S}^2 \mathbb{R}^{n+1}$ is the \mathfrak{g} -representation from Subsection 4.2.1. Since the other fundamental representations of \mathfrak{g} are exterior powers of the standard representation, every tensor bundle on M can be associated to a particular \mathfrak{p} -representation.

We are yet to describe another obvious representation of \mathfrak{g} : the standard representation on $\mathbb{T} := \mathbb{R}^{n+1}$, which has highest weight

$$\mathbb{T} = \begin{array}{cccc} 1 & 0 & \cdots & 0 & 0 \\ \circ & \text{---} & \circ & \cdots & \text{---} & \circ & \text{---} & \circ \end{array} . \quad (4.13)$$

The reason for this omission is that due to our choice of group $G = \mathrm{PGL}(n + 1, \mathbb{R})$ with Lie algebra $\mathfrak{g} = \mathfrak{sl}(n + 1, \mathbb{R})$, not all \mathfrak{g} -representation integrate to globally defined representations of G . Indeed, if $n + 1$ is even then the connected component of the identity in $\tilde{G} := \mathrm{SL}(n + 1, \mathbb{R})$ is a double cover [165] of $G = \mathrm{PGL}(n + 1, \mathbb{R})$, and a \mathfrak{g} -representation integrates to G if and only if it integrates to \tilde{G} with the element $-\mathrm{id} \in \tilde{G}$ acting trivially. If the representation in question has highest weight $\lambda = \sum_i \lambda_i \omega_i$, written here in terms of the fundamental weights, $-\mathrm{id}$ acts trivially if and only if $\sum_i \lambda_i$ is even [84], thus giving a simple integrability criterion which of course fails for \mathbb{T} . Note that there is no problem when $n + 1$ is odd, since then $G = \tilde{G}$.

We can still form bundles associated to \mathfrak{g} -representations which do not integrate to G by locally extending the Cartan bundle to \tilde{G} . More precisely, we let $\tilde{P} \leq \tilde{G}$ denote the stabiliser of a chosen line in \mathbb{R}^{n+1} (previously denoted v_0), which corresponds to crossing the last node of the Satake diagram. We then form the extended Cartan bundle $F^{\tilde{P}} = F^P \times_{\tilde{P}} \tilde{P}$ with structure group \tilde{P} , and there is a canonical extension of the unique normal Cartan connection on F^P to a normal Cartan connection on $F^{\tilde{P}}$. We can then integrate all \mathfrak{g} -representations to \tilde{G} , form the associated bundles, and quotient by the \mathbb{Z}_2 -action coming from the double cover $F^{\tilde{P}} \rightarrow F^P$ if necessary. Note that $\tilde{G}/\tilde{P} \cong \mathbb{S}^n$ and, by modifying the proof of Theorem 4.7 slightly [60, Prop. 4.1.5], we obtain an equivalence of categories between *oriented* projective structures on M and \tilde{P} -frame bundles of degree one of type \tilde{G}/\tilde{P} .

For the standard representation (4.13), the associated bundle $\mathcal{T} := F^{\tilde{P}} \times_{\tilde{P}} \mathbb{T}$ is a rank $n + 1$ vector bundle called the *standard tractor bundle*. Since an element $\begin{bmatrix} (\det C)^{-1} & \alpha \\ 0 & C \end{bmatrix} \in$

\tilde{P} acts on the line $\mathbb{T}_0 := \langle v_0 \rangle$ in \mathbb{T} stabilised by \tilde{P} by multiplication by $(\det C)^{-1}$,

$$F^{\tilde{P}} \times_{\tilde{P}} \mathbb{T}_0 \cong \begin{array}{cccc} 0 & 0 & \dots & 0 & -1 \\ \circ & \circ & \dots & \circ & \times \end{array} = \mathcal{L}^{-1/2}$$

is a square root of the line bundle \mathcal{L}^* from Lemma 4.6. The relations $\mathbb{T}_0 = \mathfrak{p}^\perp \cdot \mathbb{T}$ and $\mathfrak{p}^\perp \cdot \mathbb{T}_0 = 0$ exhibit \mathbb{T}_0 as the socle of the height one \mathfrak{p}^\perp -filtration $\mathbb{T} \supset \mathbb{T}_0 \supset 0$ of \mathbb{T} ; the decomposition (4.8) of \mathfrak{g} implies that the top $\mathbb{T}/\mathbb{T}_0 = H_0(\mathfrak{p}^\perp; \mathbb{T})$ has associated bundle

$$F^{\tilde{P}} \times_{\tilde{P}} (\mathbb{T}/\mathbb{T}_0) \cong \begin{array}{cccc} 1 & 0 & \dots & 0 & 0 \\ \circ & \circ & \dots & \circ & \times \end{array} = \mathcal{L}^{-1/2} \otimes TM.$$

In particular, a Weyl structure yields a decomposition $\mathcal{T} \cong (\mathcal{L}^{-1/2} \otimes TM) \oplus \mathcal{L}^{-1/2}$.

Remark 4.8. In fact, the extension of the Cartan bundle from F^P to $F^{\tilde{P}}$ is equivalent to a choice of square root of \mathcal{L}^* [18, 56]. Indeed, the 1-jet bundle $\mathcal{J}^1(\mathcal{L}^{-1/2})$ of $\mathcal{L}^{-1/2}$ fits into the canonical short exact sequence

$$0 \longrightarrow \mathcal{L}^{-1/2} \otimes T^*M \hookrightarrow \mathcal{J}^1(\mathcal{L}^{-1/2}) \twoheadrightarrow \mathcal{L}^{-1/2} \longrightarrow 0,$$

a splitting of which is equivalent to a linear connection on $\mathcal{L}^{-1/2}$. Choosing such a splitting yields an isomorphism $\mathcal{J}^1(\mathcal{L}^{-1/2}) \cong (\mathcal{L}^{-1/2} \otimes T^*M) \oplus \mathcal{L}^{-1/2}$, so that we recover the standard tractor bundle by defining $\mathcal{T} := \mathcal{J}^1(\mathcal{L}^{-1/2})$. It remains to recover the normal Cartan connection from the tractor connection on \mathcal{T} , which is the subject of Thomas' work [173].

4.2.4 Harmonic curvature

Having identified the tensor bundles, we may analyse the harmonic curvature of the canonical Cartan connection, which lies in the Lie algebra homology $H_2(\mathfrak{p}^\perp; \mathfrak{g})$. The Hasse diagram computing this homology is given in Figure 4.1, so that the harmonic curvature has a single irreducible component lying in

$$\begin{array}{cccc} 1 & 0 & \dots & 0 & 1 & 1 & -4 \\ \circ & \circ & \dots & \circ & \circ & \circ & \times \end{array} = \wedge^2 T^*M \odot \mathfrak{sl}(TM),$$

where \odot is the Cartan product and $\mathfrak{sl}(TM) = T^*M \odot TM$. This single piece may be identified with the Weyl curvature W , which is a totally trace-free and projectively invariant $\mathfrak{sl}(TM)$ -valued 2-form. This is as we expect: normality of the Cartan connection implies that the Weyl connections are torsion-free, so there is no torsion component of the harmonic curvature.

Since projective differential geometry is abelian, Theorem 3.35 states that the curvature any Weyl connection ∇ decomposes as $R^\nabla = W - \llbracket \text{id} \wedge r^\nabla \rrbracket^r$, where r^∇ is the

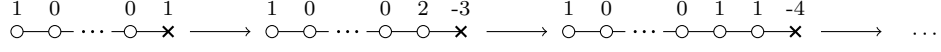

Figure 4.1: The Hasse diagram of the adjoint representation of $\mathfrak{g} = \mathfrak{sl}(n+1, \mathbb{R})$, which computes the homology $H_\bullet(\mathfrak{p}^\perp; \mathfrak{g})$.

normalised Ricci tensor defined by $r^\nabla := -\square_M^{-1} \partial R^\nabla$. Recalling that the Cartan curvature vanishes if and only if the harmonic curvature vanishes, we recover the well-known classical result which states that a projective manifold is locally diffeomorphic to \mathbb{RP}^n (*i.e.* is projectively flat) if and only if its Weyl curvature vanishes [42, 181]. Of course, $(\partial R^\nabla)_X(Y) = \varepsilon^i (R_{e_i, X}^\nabla \cdot Y)$ is simply the Ricci curvature Ric^∇ of ∇ . The following result is well-known (see for example [75]) and included for completeness.

Proposition 4.9. *The normalised Ricci tensor r^∇ of $\nabla \in [\nabla]^r$ is given by*

$$r^\nabla = -\frac{2}{n-1} \text{sym}(\partial R^\nabla) - \frac{2}{n+1} \text{alt}(\partial R^\nabla). \quad (4.14)$$

In particular if ∇ has a nowhere-vanishing parallel section of \mathcal{L} , then $r^\nabla = -\frac{2}{n-1} \partial R^\nabla$.

Proof. Applying the Lie algebra boundary map to $R^\nabla = W - \llbracket \text{id} \wedge r^\nabla \rrbracket^r$ yields

$$\partial R^\nabla = -\frac{n-1}{2} \text{sym} r^\nabla - \frac{n+1}{2} \text{alt} r^\nabla,$$

so that $\text{sym} r^\nabla = -\frac{2}{n-1} \text{sym}(\partial R^\nabla)$ and $\text{alt} r^\nabla = -\frac{2}{n+1} \text{alt}(\partial R^\nabla)$. Then (4.14) follows by writing $r^\nabla = \text{sym} r^\nabla + \text{alt} r^\nabla$. If $\ell \in \Omega^0(M; \mathcal{L})$ is nowhere-vanishing and ∇ -parallel, we have $R^\nabla \cdot \ell = 0$ and, since W is totally trace-free, $R_{X,Y}^\nabla \cdot \ell = 0 = \llbracket \text{id} \wedge r^\nabla \rrbracket_{X,Y}^r \cdot \ell = r_Y^\nabla(X)\ell - r_X^\nabla(Y)\ell$. Since ℓ is nowhere-vanishing we conclude that r^∇ is symmetric; the last claim now follows easily. \square

Recall the Cotton–York tensor $C^\nabla := d^\nabla r^\nabla$ of ∇ , which is a T^*M -valued 1-form. The following identities involving W and C^∇ are well-known in projective differential geometry (see for example [77]) and will be useful in Section 4.3.

Proposition 4.10. *Let $\nabla \in [\nabla]^r$ be a Weyl connection. Then:*

- (1) *There are Bianchi identities*

$$\begin{aligned} W_{X,Y} \cdot Z + W_{Y,Z} \cdot X + W_{Z,X} \cdot Y &= 0 \\ \text{and } C_{X,Y}^\nabla(Z) + C_{Y,Z}^\nabla(X) + C_{Z,X}^\nabla(Y) &= 0 \end{aligned}$$

- (2) $\varepsilon^i(\nabla_{e_i} W_{X,Y}) = -\frac{1}{2}(n-2)C_{X,Y}^\nabla$ *with respect to any local frame $\{e_i\}_i$ of TM with dual coframe $\{\varepsilon^i\}_i$.*

Proof. (1) Since $\llbracket X, \alpha \rrbracket^r \cdot Y$ is symmetric in X, Y , the algebraic Bianchi identity for R^∇ gives the desired Bianchi identity for W . The differential Bianchi identity $d^\nabla R^\nabla = 0$ yields $d^\nabla W + \llbracket \text{id} \wedge C^\nabla \rrbracket^r = 0$ and hence

$$\begin{aligned} (\nabla_X W)_{Y,Z} + (\nabla_Y W)_{Z,X} + (\nabla_Z W)_{X,Y} \\ = -\llbracket X, C_{Y,Z}^\nabla \rrbracket^r - \llbracket Y, C_{Z,X}^\nabla \rrbracket^r - \llbracket Z, C_{X,Y}^\nabla \rrbracket^r \end{aligned} \quad (4.15)$$

for all $X, Y, Z \in \Omega^0(M; TM)$. Taking the trace of both sides, terms of the form $\varepsilon^i ((\nabla_X W)_{Y,Z} \cdot e_i)$ vanish since W is totally trace-free. Since $\varepsilon^i (\llbracket X, C_{Y,Z}^\nabla \rrbracket^r \cdot e_i) = \frac{1}{2}(n+1)C_{Y,Z}^\nabla(X)$, the Bianchi identity for C^∇ follows.

(2) Taking a trace over X in (4.15) and using that $\partial W = 0$, we obtain

$$\varepsilon^i (\nabla_{e_i} W_{X,Y}) = -\varepsilon^i \circ (\llbracket e_i, C_{X,Y}^\nabla \rrbracket^r + \llbracket X, C_{Y,e_i}^\nabla \rrbracket^r + \llbracket Y, C_{e_i,X}^\nabla \rrbracket^r).$$

Evaluating on a vector field Z and expanding the algebraic brackets, this simplifies to

$$\varepsilon^i (\nabla_{e_i} W_{X,Y}) \cdot Z = -\frac{1}{2} ((n-1)C_{X,Y}^\nabla(Z) + C_{Y,Z}^\nabla(X) + C_{Z,X}^\nabla(Y)),$$

which yields the desired result by the Bianchi identity for C^∇ . \square

4.3 Metrisability of projective structures

We say that the projective class $[\nabla]^r$ is *metrisable* if it contains a metric connection, in which case its geodesics are those of a (pseudo-riemannian) metric.

Suppose that $g \in \Omega^0(M; S^2 T^* M)$ is a metric. We would like to reduce the question of whether the Levi-Civita connection of g lies in the projective class $[\nabla]^r$ to a differential equation on ∇ , as we did for the endomorphism A defined by (4.4) in the classical description. For this, observe that there is a natural decomposition

$$T^* M \otimes S^2 TM = (\text{id} \circ TM) \oplus (T^* M \otimes_\circ S^2 TM) \quad (4.16)$$

into the image and kernel of the natural trace $T^* M \otimes S^2 TM \rightarrow TM$. This suggests that a differential system involving successive differentials and traces of the inverse metric $g^{-1} \in \Omega^0(M; S^2 TM)$ may close. This is indeed the case [77], and it is a matter of tensoring with an appropriate weight to achieve projective invariance.

Proposition 4.11. *The first-order linear differential equation $(\nabla h)_\circ = 0$ is projectively invariant on sections of $\mathcal{L}^* \otimes S^2 TM$, where the subscript “ \circ ” denotes the trace-free part.*

Proof. We calculate the variation $\delta_\gamma \nabla h = \llbracket \cdot, \gamma \rrbracket^r \cdot h$ with respect to $\gamma \in \Omega^1(M)$.

Viewing h as a bundle map $T^*M \rightarrow \mathcal{L}^* \otimes TM$, the Leibniz rule gives

$$\begin{aligned} ([X, \alpha]^r \cdot h)(\beta) &= [[X, \alpha]^r \cdot h(\beta, \cdot) - h([X, \alpha]^r \cdot \beta, \cdot)] \\ &= -\alpha(X)h(\beta, \cdot) + \frac{1}{2}(\alpha(X)h(\beta, \cdot) + \alpha(h(\beta, \cdot))X) \\ &\quad + \frac{1}{2}h(\alpha(X)\beta + \beta(X)\alpha, \cdot) \\ &= (X \odot h(\alpha, \cdot))(\beta). \end{aligned}$$

Thus $\delta_\gamma \nabla h$ lies in the summand $\text{id} \odot TM$ of (4.16), giving projective invariance. \square

The equation $(\nabla h)_\circ = 0$ will be called the *linear metric equation*, which may equivalently be written as

$$\nabla h = \text{id} \odot Z^\nabla \tag{4.17}$$

for some section Z^∇ of $\mathcal{L}^* \otimes TM$ depending on ∇ . Taking a trace in (4.17) easily yields $Z^\nabla = \frac{2}{n+1} \partial(\nabla h)$. Moreover, the proof of Proposition 4.11 implies that $\delta_\gamma Z^\nabla = h(\gamma, \cdot)$, i.e. $Z^\nabla \mapsto Z^\nabla + h(\gamma, \cdot)$ under change of Weyl connection $\nabla \mapsto \nabla + [[\cdot, \gamma]]^r$. Proposition 4.11 should be compared with Proposition 4.4; this comparison will be made more precise in Remark 4.13 below.

Since $\wedge^n TM \cong \mathcal{L}^{(n+1)/2}$, a metric g induces a section of $\mathcal{L}^* \otimes S^2 TM$ defined by

$$h := (\det g)^{1/(n+1)} g^{-1},$$

which we call the *linear metric* associated to g . Then $\det h = (\det g)^{-1/(n+1)} \in \Omega^0(M; \mathcal{L}^*)$, so that we may recover $g = (\det h)^{-1} h^{-1}$ from h ; cf. equation (4.5).

Corollary 4.12. *There is a bijection between non-degenerate solutions of the linear metric equation and metric connections in $[\nabla]^r$.*

Proof. If h is a non-degenerate solution of the linear metric equation (4.17) with $\nabla h = \text{id} \odot Z^\nabla$, then $h^{-1}(Z^\nabla, \cdot) \in \Omega^1(M)$ and hence $\nabla^g := \nabla - [[\cdot, h^{-1}(Z^\nabla, \cdot)]]^r \in [\nabla]^r$ is independent of ∇ and satisfies $\nabla^g h = 0$. It follows that ∇^g is the Levi-Civita connection of $g := (\det h)^{-1} h^{-1}$. Conversely if $\nabla^g \in [\nabla]^r$ is the Levi-Civita connection of some metric g , we have $\nabla^g h = 0$ for its linear metric $h := (\det g)^{1/(n+1)} g^{-1}$. Since the linear metric equation is projectively invariant, this h is a solution for any $\nabla \in [\nabla]^r$. \square

Corollary 4.12 reduces the metrisability problem for a projective structure to the study of a projectively invariant first-order linear differential equation. We shall henceforth refer to all solutions of the linear metric equation as linear metrics.

Remark 4.13. Given a “background” metric g and a projectively equivalent metric \hat{g} , the associated linear metrics h, \hat{h} define an endomorphism A of T^*M by $\hat{h} = h(A \cdot, \cdot)$.

Evidently (the transpose of) A is precisely the endomorphism (4.4) featured in the main equation (4.6), clarifying the relation between the main equation and the linear metric equation. We shall return to this topic in Chapter 8.

The linear metric equation is over-determined, so its solution space may be prolonged to a closed differential system on an auxiliary bundle. In the presence of a background metric, a (non-invariant) prolongation was obtained by Mikeš [145] (see also [98, p. 151]). An invariant prolongation was found by Eastwood and Matveev [77], which we translate into index-free notation below.

Theorem 4.14. *There is a linear isomorphism between the space of solutions of the metric equation and the parallel sections of the projectively invariant connection*

$$\nabla_X^{\mathcal{W}} \begin{bmatrix} h \\ Z \\ \lambda \end{bmatrix} = \begin{bmatrix} \nabla_X h - X \odot Z \\ \nabla_X Z - h(r_X^\nabla, \cdot) - \lambda X \\ \nabla_X \lambda - r_X^\nabla(Z) \end{bmatrix} - \frac{2}{n} \begin{bmatrix} 0 \\ -W_{e_i, X} \cdot h(\varepsilon^i, \cdot) \\ h(C_{e_i, X}^\nabla, \varepsilon^i) \end{bmatrix} \quad (4.18)$$

on sections (h, Z, λ) of $\mathcal{W} := (\mathcal{L}^* \otimes S^2 TM) \oplus (\mathcal{L}^* \otimes TM) \oplus \mathcal{L}^*$.

Proof. Suppose that $h \in \Omega^0(M; \mathcal{L}^* \otimes S^2 TM)$ is a solution of the linear metric equation (4.17), so that $\nabla h = \text{id} \odot Z^\nabla$ for some $Z^\nabla \in \Omega^0(M; \mathcal{L}^* \otimes TM)$. Recalling that normality implies zero torsion, differentiating again and using the Ricci identity gives

$$W_{X, Y} \cdot h = R_{X, Y}^\nabla \cdot h + [\text{id} \wedge r^\nabla]_{X, Y}^r \cdot h = -X \odot Q_Y^\nabla + Y \odot Q_X^\nabla, \quad (4.19)$$

where $Q_X^\nabla := \nabla_X Z^\nabla - h(r_X^\nabla, \cdot)$. Taking a trace over X in (4.19) with respect to a local frame $\{e_i\}_i$ with dual frame $\{\varepsilon^i\}_i$ gives

$$W_{e_i, Y} \cdot h(\varepsilon^i, \cdot) = \frac{1}{2} (-nQ_Y^\nabla - Q_Y^\nabla + Q_Y^\nabla + (\text{tr } Q^\nabla)Y) = \frac{n}{2} (-Q_Y^\nabla + \lambda^\nabla Y),$$

where $\lambda^\nabla := \frac{1}{n}(\text{tr } Q^\nabla) \in \Omega^0(M; \mathcal{L}^*)$. Rearranging and substituting for Q^∇ then gives the second slot of $\nabla^{\mathcal{W}}$. Differentiating again and skew-symmetrising, we obtain

$$\begin{aligned} & W_{X, Y} \cdot Z^\nabla - [\text{id} \wedge r^\nabla]_{X, Y}^r Z^\nabla - h(C_{X, Y}^\nabla, \cdot) \\ &= (X \odot Z^\nabla)(r_Y^\nabla, \cdot) - (Y \odot Z^\nabla)(r_X^\nabla, \cdot) + (\nabla_X \lambda^\nabla)Y - (\nabla_Y \lambda^\nabla)X \\ &\quad - \frac{2}{n} ((\nabla_X W_{e_i, Y}) \cdot h(\varepsilon^i, \cdot) + W_{e_i, Y} \cdot \nabla_X h(\varepsilon^i, \cdot)) \\ &\quad + \frac{2}{n} ((\nabla_Y W_{e_i, X}) \cdot h(\varepsilon^i, \cdot) + W_{e_i, X} \cdot \nabla_Y h(\varepsilon^i, \cdot)) \end{aligned}$$

Expanding the algebraic bracket on the left-hand side and tracing over X yields

$$\begin{aligned} & (n-1) (\nabla_Y \lambda^\nabla - r_Y^\nabla(Z^\nabla)) - h(C_{e_i, Y}^\nabla, \varepsilon^i) \\ &= -\frac{2}{n} \varepsilon^j ((\nabla_{e_j} W_{e_i, Y}) \cdot h(\varepsilon^i, \cdot) - (\nabla_Y W_{e_i, e_j}) \cdot h(\varepsilon^i, \cdot)) \\ &\quad + W_{e_i, Y} \cdot \nabla_{e_j} h(\varepsilon^i, \cdot) - W_{e_i, e_j} \cdot \nabla_Y h(\varepsilon^i, \cdot). \end{aligned} \quad (4.20)$$

This is precisely the adjoint representation of the Lie algebra $\mathfrak{sp}(\mathbb{R}^{n+1} \oplus \mathbb{R}^{n+1*}, \omega)$, where $\omega \in \wedge^2(\mathbb{R}^{n+1} \oplus \mathbb{R}^{n+1*})$ is the canonical symplectic form defined by $\omega(u + \alpha, v + \beta) := \alpha(v) - \beta(u)$, thus giving an isomorphism of \mathfrak{h} with the graded vector space underlying $\mathfrak{sp}(2n + 2, \mathbb{R})$. The graded Lie algebra structure on $\mathfrak{sp}(2n + 2, \mathbb{R})$ induces a graded Lie algebra structure on \mathfrak{h} in which the summands \mathbb{W} and \mathbb{W}^* are abelian subalgebras, while the grading implies that $\mathfrak{q} := (\mathfrak{g} \oplus \mathbb{R}) \ltimes \mathbb{W}^*$ and $\hat{\mathfrak{q}} := \mathbb{W} \rtimes (\mathfrak{g} \oplus \mathbb{R})$ are opposite abelian parabolics. The corresponding Satake diagrams are

$$\mathfrak{q} = \circ - \circ - \dots - \circ - \circ \leftarrow \mathbf{x} \leq \circ - \circ - \dots - \circ - \circ \leftarrow \circ = \mathfrak{sp}(2n + 2, \mathbb{R}),$$

so that $H \cdot \mathfrak{q}$ is the grassmannian of lagrangian subspaces of \mathbb{R}^{2n+2} .

Conversely, choose an algebraic Weyl structure for \mathfrak{h} . The infinitesimal isotropy representation $\mathfrak{h}/\mathfrak{q}$ of \mathfrak{h} descends to a representation \mathbb{W} of the semisimple part $\mathfrak{g} := [\mathfrak{q}^0, \mathfrak{q}^0] \cong \mathfrak{sl}(n + 1, \mathbb{R})$ of the Levi factor $\mathfrak{q}^0 := \mathfrak{q}/\mathfrak{q}^\perp \cong \mathfrak{gl}(n + 1, \mathbb{R})$ of \mathfrak{q} . Since \mathbb{W} is induced by the adjoint representation of $\mathfrak{h} = \mathfrak{sp}(2n + 2, \mathbb{R})$, it has highest weight

$$\mathbb{W} = \begin{array}{cccc} 2 & 0 & & 0 & 0 \\ \circ - \circ - \dots - \circ - \circ & & & & \end{array}$$

as a \mathfrak{g} -representation. The dual representation \mathbb{W}^* has highest weight supported on the final node, so determines a symmetric R-space $G \cdot \mathfrak{p}$ by crossing this node. Of course, $G \cdot \mathfrak{p}$ is just $\mathbb{R}\mathbb{P}^n$. We shall see later that similar isomorphisms exist in c-projective and quaternionic geometries, and are key for generalising the classical projective structures.

C-projective geometry

Ōtsuki and Tashiro [153] observed that two Kähler metrics are projectively equivalent if and only if they are affinely equivalent, implying that the naïve application of projective differential geometry to complex manifolds is essentially uninteresting. C-projective geometry arises as a natural generalisation, where we replace geodesics with a complex analogue. We begin by reviewing the rudiments of almost complex geometry in Section 5.1, before describing the classical theory of c-projective geometry in Section 5.2. This develops in two parallel threads: a similar formulation to the theory of Section 4.1 using Kähler metrics, or via so-called *hamiltonian 2-forms*.

We describe c-projective geometry as an abelian parabolic geometry in Section 5.3, with \mathfrak{g} the real Lie algebra underlying $\mathfrak{sl}(n+1, \mathbb{C})$ and \mathfrak{p} the stabiliser of a given complex line. Thus $G \cdot \mathfrak{p} \cong \mathbb{C}\mathbb{P}^n$, and the general theory gives an equivalence of categories between (almost) c-projective structures and normal Cartan geometries of type $\mathbb{C}\mathbb{P}^n$.

The metrisability of a c-projective structure proceeds in much the same way as in Section 4.3, with compatible Kähler metrics given by solutions of the first BGG operator associated to $\mathbb{W} := (\mathbb{C}^{n+1} \boxtimes \overline{\mathbb{C}^{n+1}})_{\mathbb{R}}$. The first BGG operator associated to \mathbb{W}^* , called the *c-projective hessian*, is also important to the theory; we discuss these two BGG operators in Section 5.4.

5.1 Background on almost complex geometry

We begin by reviewing the basic theory of almost complex manifolds, primarily to fix conventions and notation; comprehensive introductions may be found in [69, 109, 114, 179]. An *almost complex structure* on a manifold M is an endomorphism $J \in \Omega^0(M; \mathfrak{gl}(TM))$ satisfying $J^2 = -\text{id}$. For each $x \in M$, the choice of such a J equips the tangent space $T_x M$ with the structure of a complex vector space in which we identify multiplication by $\mathbf{i} := \sqrt{-1} \in \mathbb{C}$ with the application of $J|_x \in \mathfrak{gl}(T_x M)$. In particular, it follows that $\dim M = 2n$ is even. The pair (M, J) is called an *almost complex manifold*; equivalently, an almost complex structure is a reduction of the frame bundle of M to structure group $\text{GL}(n, \mathbb{C}) \leq \text{GL}(2n, \mathbb{R})$.

By the Newlander–Nirenberg theorem [150], an almost complex manifold admits holomorphic coordinates if and only if the *Nijenhuis torsion*

$$\begin{aligned} N_{X,Y}^J &:= (J\mathcal{L}_X J - \mathcal{L}_{JX} J)Y \\ &= [X, Y] + J[JX, Y] + J[X, JY] - [JX, JY] \end{aligned} \quad (5.1)$$

of J vanishes. In this case, we drop the prefix “almost” in “almost complex structure” and “almost complex manifold”, and say that J is *integrable*. Equivalently, a complex structure is a torsion-free $\mathrm{GL}(n, \mathbb{C})$ -structure.

Since $J^2 = -\mathrm{id}$, it has eigenvalues $\pm \mathbf{i}$ on each tangent space. Thus J is diagonalisable on the complexification $\mathbb{C}TM := TM \otimes_{\mathbb{R}} \mathbb{C}$ of the tangent bundle; if $T^{1,0}M$ and $T^{0,1}M$ are respectively the $(\pm \mathbf{i})$ -eigensubbundles of J , we have

$$\mathbb{C}TM = T^{1,0}M \oplus T^{0,1}M = \{X \mid JX = \mathbf{i}X\} \oplus \{X \mid JX = -\mathbf{i}X\}$$

and clearly $\overline{T^{1,0}M} = T^{0,1}M$. There is a corresponding decomposition of the complexified cotangent bundle: we define $\wedge^{1,0}M := (T^{1,0}M)^*$, which identifies $\wedge^{1,0}M$ with the annihilator of $T^{0,1}M$ in $\mathbb{C}TM$, and similarly for $\wedge^{0,1}M$. It follows that

$$\mathbb{C}T^*M = \wedge^{1,0}M \oplus \wedge^{0,1}M = \{\omega \mid J\omega = -\mathbf{i}\omega\} \oplus \{\omega \mid J\omega = \mathbf{i}\omega\}, \quad (5.2)$$

where $J\omega := -\omega \circ J$. Note that some authors (for example [109]) define $\wedge^{1,0}M$ to be the $(+\mathbf{i})$ -eigensubbundle of J , in which case $\wedge^{1,0}M = (T^{0,1}M)^*$ instead. Given arbitrary $X \in \Omega^0(M; \mathbb{C}TM)$ and $\omega \in \Omega^0(M; \mathbb{C}T^*M)$, the $(1, 0)$ - and $(0, 1)$ -parts are given by

$$\begin{aligned} X^{1,0} &:= \frac{1}{2}(X - \mathbf{i}JX), & X^{0,1} &:= \frac{1}{2}(X + \mathbf{i}JX), \\ \text{and } \omega^{1,0} &:= \frac{1}{2}(\omega + \mathbf{i}J\omega), & \omega^{0,1} &:= \frac{1}{2}(\omega - \mathbf{i}J\omega). \end{aligned}$$

If $X \in \Omega^0(M; T^{1,0}M)$ then taking $X_{\mathbb{R}} := \frac{1}{2}(X + \bar{X})$ gives $X = \frac{1}{2}(X_{\mathbb{R}} - \mathbf{i}JX_{\mathbb{R}})$. It follows that the map $TM \rightarrow T^{1,0}M$ given by $X \mapsto \frac{1}{2}(X - \mathbf{i}JX)$ is a vector bundle isomorphism; similar statements hold for $(0, 1)$ -vectors and complex forms.

The decomposition (5.2) induces a decomposition

$$\wedge^k \mathbb{C}T^*M = \wedge^k (\wedge^{1,0}M \oplus \wedge^{0,1}M) = \bigoplus_{p+q=k} (\wedge^p \wedge^{1,0}M \otimes \wedge^q \wedge^{0,1}M) \quad (5.3)$$

of $\wedge^k \mathbb{C}TM$ for each $k \in \mathbb{N}$, where the (p, q) th summand $\wedge^{p,q}M := \wedge^p \wedge^{1,0}M \otimes \wedge^q \wedge^{0,1}M$ in (5.3) is called the space of (p, q) -forms on M ; clearly $\omega \in \Omega^0(M; \wedge^{p,q}M)$ has $p + q$ covariant indices, p of type $(1, 0)$ and q of type $(0, 1)$. The decomposition (5.3) may be described in representation-theoretic terms: if F^0 is the reduction of the frame bundle

of M to structure group $P^0 := \mathrm{GL}(n, \mathbb{C})$, then $\wedge_{\mathbb{C}}^k \mathbb{C}T^*M$ is the bundle associated to F^0 and $\wedge^k \mathbb{R}^{2n^*} \otimes \mathbb{C}$. The $\mathrm{GL}(n, \mathbb{C})$ -representation $\wedge^k \mathbb{R}^{2n^*} \otimes \mathbb{C}$ decomposes as

$$\wedge^k \mathbb{R}^{2n^*} \otimes \mathbb{C} = \bigoplus_{p+q=k} (\wedge_{\mathbb{C}}^p \mathbb{C}^{n^*} \otimes_{\mathbb{C}} \wedge_{\mathbb{C}}^q \overline{\mathbb{C}^{n^*}}),$$

where overline denotes the complex conjugate representation. Of course, $\wedge^{p,q} M$ is the bundle associated to $\wedge_{\mathbb{C}}^p \mathbb{C}^{n^*} \otimes \wedge_{\mathbb{C}}^q \overline{\mathbb{C}^{n^*}}$. We shall often need the decomposition

$$\wedge_{\mathbb{C}}^2 \mathbb{C}T^*M = (\wedge^{2,0} M \oplus \wedge^{0,2} M) \oplus \wedge^{1,1} M \quad (5.4)$$

of complex 2-forms, where the two summands are respectively the complexifications of the bundles $\wedge_-^2 T^*M$ and $\wedge_+^2 T^*M$ of J -anti-invariant and J -invariant 2-forms. Decompositions analogous to (5.3) and (5.4) exist for k -vectors and symmetric k -tensors, for which we write $\wedge_{\mathbb{C}}^k \mathbb{C}TM = \bigoplus_{p+q=k} T^{p,q}M$ and $S_{\mathbb{C}}^k \mathbb{C}T^*M = \bigoplus_{p+q=k} S^{p,q}T^*M$.

The natural connections on an almost complex manifold (M, J) are those which preserve J , *i.e.* $\nabla J = 0$. The space of such connections is affine, modelled on 1-forms with values in the complex-linear endomorphisms $\mathfrak{gl}(TM, J)$ of TM . The (complexification of the) torsion $T^{\nabla} \in \Omega^2(M; TM)$ of ∇ splits into (2, 0)-, (1, 1)- and (0, 2)-parts as in (5.4), and it is easy to show that the (0, 2)-part is proportional to the Nijenhuis torsion (5.1) of J . Moreover ∇ may be deformed in such a way as to remove the (2, 0)- and (1, 1)-parts [51], so that (M, J) admits a torsion-free complex connection if and only if J is integrable, if and only if its Nijenhuis torsion (5.1) vanishes.

Finally, the class of (pseudo-)riemannian metrics g of interest are the *hermitian* metrics, *i.e.* those satisfying $g(JX, JY) = g(X, Y)$. If \hat{g} is an arbitrary metric, $g(X, Y) := \frac{1}{2}(\hat{g}(X, Y) + \hat{g}(JX, JY))$ is hermitian, so that almost complex manifolds always admit hermitian metrics. The complexification of a hermitian metric g defines a hermitian inner product on each $\mathbb{C}T_x M$, thus giving a section of $S^{1,1} \mathbb{C}T^*M$; equivalently g is a section of the J -invariant subbundle $S_+^2 T^*M$. It follows that $\omega := g(J \cdot, \cdot)$ is a J -invariant 2-form, called the *hermitian form* of g . Evidently g and ω may be viewed respectively as the real and imaginary parts of a hermitian metric on $\mathbb{C}T^*M$. If ω is closed, we call g a (*pseudo-*)*Kähler metric* and ω its *Kähler form*.

Suppose that J is integrable, and that ∇ is the Levi-Civita connection of a hermitian metric g . Then it is straightforward to check that $d\omega = 0$ if and only if $\nabla\omega = 0$. Since $\omega = g(J \cdot, \cdot)$, it follows that g is Kähler if and only if $\nabla J = 0$, *i.e.* if and only if ∇ is a complex connection.¹ The condition $\nabla J = 0$ and the exchange identity imply that the riemannian curvature tensor R^{∇} is a J -invariant $\mathfrak{gl}(TM, J)$ -valued 2-form, which also implies that the Ricci curvature Ric^g of g is symmetric and J -invariant. Moreover since

¹Evidently any two of the conditions $\nabla g = 0$, $\nabla J = 0$ and $\nabla\omega = 0$ imply the third.

∇ preserves more than just a riemannian metric, R^∇ admits a finer decomposition than a generic riemannian curvature tensor; we shall not need this decomposition and refer the interested reader to [29, §2D] and [11, Eqn. (3)].

5.2 Classical definition and results

C-projective geometry² was introduced by Ōtsuki and Tashiro in [153] as a generalisation of projective differential geometry to the holomorphic category. They observed that two Kähler metrics on a complex manifold (M, J) that are projectively equivalent in the sense of Definition 4.1 are affinely equivalent, meaning that projective equivalence is uninteresting for Kähler manifolds. Many results analogous to those in projective differential geometry have natural generalisations [146], as well as generalisations to almost complex structures [172]. We study this formulation in Subsection 5.2.1.

Later, c-projective differential geometry was unknowingly rediscovered under the guise of *hamiltonian 2-forms* by Apostolov *et al.* while studying Kähler metrics with special curvature properties [10, 11, 12, 13, 14]. The authors observed that the existence of a hamiltonian 2-form imbued the Kähler metric with an isometric torus action, which allowed them to give both local and global classifications of Kähler metrics admitting hamiltonian 2-forms. An overview of hamiltonian 2-forms is given in Subsection 5.2.2.

For greater generality we allow non-degenerate metrics of arbitrary signature, reserving the term *riemannian Kähler* for positive definite Kähler metrics.

5.2.1 Classical approach

Let (M, g, J) be a $2n$ -dimensional Kähler manifold with Levi-Civita connection ∇ .

Definition 5.1. A smooth curve $\gamma \subset M$ is a *c-geodesic* of g if $\nabla_X X \in \langle X, JX \rangle$ for every vector field X tangent to γ . If \hat{g} is a second Kähler metric, g and \hat{g} are called *c-projectively equivalent* if they have the same c-geodesics (as unparameterised curves).

Evidently any two metrics on a Riemann surface (*i.e.* $n = 1$) are c-projectively equivalent, so that a different approach is required to avoid triviality. We shall discuss this further in Subsection 5.4.2; for now we assume that $n > 1$. The following characterisation of c-projectively equivalent Kähler metrics was obtained by Ōtsuki and Tashiro [153] and Ishihara and Tachibana [105]; its proof follows a similar argument to that of Lemma 4.2.

²The classical literature uses the term “H-projective” rather than “c-projective”. The latter was recently adopted to reflect the fact that a generic c-projective class does *not* contain a holomorphic connection; see [139, Rmk. 1].

Lemma 5.2. *Kähler metrics g, \hat{g} are c-projectively equivalent if and only if their Levi-Civita connections $\nabla, \hat{\nabla}$ are related by*

$$\begin{aligned} \hat{\nabla}_X Y &= \nabla_X Y + \llbracket X, \alpha \rrbracket^c \cdot Y \\ \text{where } \llbracket X, \alpha \rrbracket^c \cdot Y &:= \frac{1}{2}(\alpha(X)Y + \alpha(Y)X - \alpha(JX)JY - \alpha(JY)JX) \end{aligned} \quad (5.5)$$

for some $\alpha \in \Omega^1(M)$ and all $X, Y \in \Omega^0(M; TM)$. \square

Remark 5.3. The endomorphism $\llbracket X, \alpha \rrbracket^c$ will be called the *algebraic bracket* of X and α , which is easily seen to be complex-linear and symmetric in X, Y .

As in projective differential geometry, taking a trace in (5.5) yields

$$\alpha = \frac{1}{2n+2} d \left(\log \frac{\det \hat{g}}{\det g} \right), \quad (5.6)$$

so that α is an exact 1-form; cf. equation (4.3). Given c-projectively equivalent Kähler metrics g, \hat{g} , we follow the lead of (4.4) by considering the endomorphism

$$A(g, \hat{g}) := \left(\frac{\det \hat{g}}{\det g} \right)^{1/(2n+2)} \hat{\sharp} \circ \flat. \quad (5.7)$$

It is straightforward to see that $A(g, \hat{g})$ is invertible with inverse $A(\hat{g}, g)$ and is self-adjoint with respect to both g and \hat{g} ; moreover since g, \hat{g} are hermitian, $A := A(g, \hat{g})$ is complex-linear. The second Kähler metric \hat{g} may be recovered from the pair (g, A) as

$$\hat{g} = (\det A)^{-1/2} g(A^{-1} \cdot, \cdot); \quad (5.8)$$

cf. equation (4.5). Calculating as in Proposition 4.4, Domashev and Mikeš [73] found that A satisfies a first-order linear differential equation.

Proposition 5.4. *Let g, \hat{g} be Kähler metrics with Levi-Civita connections $\nabla, \hat{\nabla}$ respectively. Then g, \hat{g} are c-projectively equivalent if and only if $A := A(g, \hat{g})$ defined by (5.7) satisfies the first-order linear differential equation*

$$g((\nabla_X A) \cdot, \cdot) = X^\flat \odot \mu + JX^\flat \odot J\mu \quad (5.9)$$

for some $\mu \in \Omega^1(M)$ and all $X \in \Omega^0(M; TM)$. In this case $\hat{\nabla} = \nabla + \llbracket \cdot, \alpha \rrbracket^c$, where $\alpha \in \Omega^1(M)$ satisfies $\mu = -\alpha(A \cdot) = \frac{1}{2}d(\text{tr } A)$. \square

Remark 5.5. Although the lineage of (5.9) is less contentious than that of (4.6), we refer to it as the *main equation* of c-projective geometry to develop the analogy between the

two theories. Domashev and Mikeš obtained a prolongation of the main equation [73, Thm. 2]; also see the survey [146].

Thus a solution (g, A) of (5.9) is equivalent to a pair of c -projectively equivalent Kähler metrics $g, \hat{g} := (\det A)^{-1/2}g(A^{-1} \cdot, \cdot)$. Linearity then yields a *metrisability pencil* of c -projectively equivalent Kähler metrics induced by $A_t := A - tid$ and (5.8).

Finally, let us indicate the link between the classical theory above and the description as a parabolic geometry outlined in Section 5.3. Lemma 5.2 shows that c -geodesics are really a feature of linear connections, so let us call $\nabla, \hat{\nabla}$ c -projectively equivalent if $\hat{\nabla}_X = \nabla_X + \llbracket X, \alpha \rrbracket^c$ for some $\alpha \in \Omega^1(M)$, where $\llbracket X, \alpha \rrbracket^c$ is the algebraic bracket from (5.5). Here we make no assumption on the torsions of $\nabla, \hat{\nabla}$. A c -projective structure on M is then an equivalence class $[\nabla]^c$ of c -projectively equivalent connections, with $\alpha \mapsto \llbracket \cdot, \alpha \rrbracket^c$ defining an embedding of $\Omega^1(M) \hookrightarrow \Omega^1(M; \mathfrak{gl}(TM, J))$. Thus $[\nabla]^c$ is an affine space modelled on $\Omega^1(M)$, leading to the following analogue of Lemma 4.6.

Lemma 5.6. *There is a bijection between connections $\nabla \in [\nabla]^c$ and connections on the line bundle $\mathcal{L} := (\wedge^{2n} TM)^{1/(n+1)}$, where $\nabla, \hat{\nabla}$ are related by $\alpha \in \Omega^1(M)$ if and only if α is the change of induced connection on \mathcal{L} . \square*

A quantity is *c-projectively invariant* if it is independent of $\nabla \in [\nabla]^c$. By the symmetry of $\llbracket X, \alpha \rrbracket^c \cdot Y$ in X, Y , the relation $\hat{\nabla}_X Y = \nabla_X Y + \llbracket X, \alpha \rrbracket^c \cdot Y$ implies that $\nabla, \hat{\nabla}$ have the same torsion, which is then a c -projective invariant of $[\nabla]^c$.

5.2.2 Hamiltonian 2-forms

An equivalent approach to c -projective geometry was developed independently by Apostolov *et al.* [10, 11] while studying Kähler metrics with special curvature properties.

Definition 5.7. Let (M, g, J) be a $2n$ -dimensional Kähler manifold. A *hamiltonian 2-form* on M is a J -invariant 2-form ϕ satisfying

$$\nabla_X \phi = \frac{1}{2}(d\sigma \wedge JX^\flat - Jd\sigma \wedge X^\flat) \quad (5.10)$$

for some smooth function $\sigma \in \Omega^0(M)$ and all $X \in \Omega^0(M; TM)$.³

It is straightforward to see that the main equation (5.9) and the hamiltonian 2-form equation (5.10) are equivalent. Indeed, an endomorphism A satisfies the main equation if and only if $\phi := g(JA \cdot, \cdot)$ is a hamiltonian 2-form. Taking a trace in (5.10) with respect to the Kähler form ω yields $\sigma = \text{tr}_\omega \phi$, so that $d\sigma$ coincides with $\mu = \frac{1}{2}d(\text{tr } A)$

³Equation (5.10) is trivial when $n = 1$, so we additionally assume that σ is a Killing potential, *i.e.* that $J \text{grad}_g \sigma$ is a Killing vector field.

from Proposition 5.4. The c-projectively equivalent metric determined by ϕ is given by (5.8). A more detailed account of the relationship between may be found in [52].

Since the hamiltonian 2-form equation is over-determined, it may be prolonged to a closed system. For this the authors of [11] inverted (5.10) using the metric g , thus obtaining a closed differential system on $\wedge^2_+ TM \oplus TM \oplus (M \times \mathbb{R})$. This system is equivalent to the prolongation given by Domashev and Mikeš discussed in Remark 5.5.

Apostolov *et al.* were able to obtain a local classification of hamiltonian 2-forms [11, Thm. 1] by utilising an intrinsic torus action afforded by a pair of c-projectively equivalent metrics. Firstly, if ϕ is a hamiltonian 2-form then so is $\phi_t := \phi - t\omega$ for all $t \in \mathbb{R}$; cf. the paragraph following Remark 5.5. The *pfaffian* $\text{pf } \phi_t := *(\frac{1}{n!}\phi_t^{\wedge n}) \in \Omega^0(M)$ of ϕ_t , induced by the Hodge star $*$ of g , equips M with a 1-parameter family of vector fields $K_t := J \text{grad}_g(\text{pf } \phi_t)$. It turns out that the K_t are commuting hamiltonian Killing vector fields [11, Prop. 3], and the rank of the family $t \mapsto K_t$ is constant on a dense open subset of M . The K_t therefore generate an isometric torus action, from which a local classification may be obtained by specialising Pedersen and Poon's description [156] of Kähler manifolds admitting such a torus action. This classification may be viewed as a complex version of Levi-Civita's classification of riemannian metrics admitting a projective equivalent metric [127]. A global classification was obtained for compact manifolds in [12], by appealing to Guillemin's construction [48, 91, 92] of toric Kähler manifolds via the Delzant polytope [83] of the acting torus. Applications of hamiltonian 2-forms in Kähler geometry were developed in [13, 14]. A local classification of pseudo-Kähler metrics admitting a c-projectively equivalent metric was recently obtained by Bolsinov *et al.* [36] by a combination of the aforementioned toric methods and appealing to the local classification of projectively equivalent metrics [30, 31, 35].

5.3 Description as a parabolic geometry

Complex projective space $\mathbb{C}\mathbb{P}^n$ may be defined as either the set of complex lines through the origin in \mathbb{C}^{n+1} , or as the quotient of the $(2n+1)$ -sphere \mathbb{S}^{2n+1} by its \mathbb{S}^1 -action; the latter is the famous Hopf fibration $\mathbb{S}^{2n+1} \rightarrow \mathbb{C}\mathbb{P}^n$ [29]. The standard metric on \mathbb{C}^{n+1} of a given signature induces a Kähler metric g_{FS} of constant holomorphic sectional curvature on $\mathbb{C}\mathbb{P}^n$, called the *Fubini–Study metric* of that signature [114]. Much like in the case of $\mathbb{R}\mathbb{P}^n$, the embedded complex projective lines $\mathbb{C}\mathbb{P}^1 \hookrightarrow \mathbb{C}\mathbb{P}^n$ are totally geodesic with respect to the Levi-Civita connection ∇^{FS} of g_{FS} . It follows that the c-geodesics of $[\nabla^{g_{\text{FS}}}]$ are the smooth curves contained within such a complex line, so that with respect to an affine chart $\mathbb{C}^n \hookrightarrow \mathbb{C}\mathbb{P}^n$ the c-geodesics lie within a complex line in \mathbb{C}^n . Thus, from the point of view of c-geodesics, $\mathbb{C}\mathbb{P}^n$ is the natural compactification of \mathbb{C}^n and therefore is suitable as the flat model of c-projective geometry.

We shall assume henceforth that $n > 1$, so that we consider almost complex manifolds (M, J) of dimension $2n \geq 4$. Evidently any two connections on a riemann surface are c-projectively equivalent, so that the case $n = 1$ requires a different approach to be non-trivial; we shall discuss this in Remark 5.16.

5.3.1 The flat model $\mathbb{C}\mathbb{P}^n$

As a generalised flag manifold $\mathbb{C}\mathbb{P}^n$ is isomorphic to G/P for the real Lie groups

$$G := \mathrm{PGL}(n+1, \mathbb{C}) := \mathrm{GL}(n+1, \mathbb{C}) / \langle \mathrm{id} \rangle_{\mathbb{C}}$$

and $P \leq G$ the (projection to G of) the $\mathrm{GL}(n+1, \mathbb{C})$ -stabiliser of a chosen complex line $\langle v_0 \rangle_{\mathbb{C}}$ in \mathbb{C}^{n+1} . It is important to note that we view both G and P as *real* Lie groups. The Lie algebra of G is the underlying real Lie algebra $\mathfrak{g} := \mathfrak{sl}(n+1, \mathbb{C})$, with complexification $\mathfrak{g}_{\mathbb{C}} := \mathfrak{sl}(n+1, \mathbb{C}) \oplus \mathfrak{sl}(n+1, \mathbb{C})$, while the parabolic subalgebra \mathfrak{p} corresponds to crossing the last node of each factor:

$$\mathfrak{p} = \begin{array}{ccccccc} \circ & \circ & \cdots & \circ & \times & & \\ \updownarrow & \updownarrow & & \updownarrow & \updownarrow & & \\ \circ & \circ & \cdots & \circ & \times & & \end{array} \leq \begin{array}{ccccccc} \circ & \circ & \cdots & \circ & \circ & & \\ \updownarrow & \updownarrow & & \updownarrow & \updownarrow & & \\ \circ & \circ & \cdots & \circ & \circ & & \end{array} = \mathfrak{g}. \quad (5.11)$$

Therefore c-projective geometry is an abelian parabolic geometry, with Killing polar $\mathfrak{p}^{\perp} \cong \mathbb{C}^{n*} := \mathrm{Hom}_{\mathbb{R}}(\mathbb{C}^n, \mathbb{R})$ and reductive Levi factor $\mathfrak{p}^0 := \mathfrak{p}/\mathfrak{p}^{\perp}$. An algebraic Weyl structure splits the \mathfrak{p}^{\perp} -filtration $\mathfrak{g} \supset \mathfrak{p} \supset \mathfrak{p}^{\perp} \supset 0$ of \mathfrak{g} , determining an isomorphism $\mathfrak{g} \cong \mathfrak{g}/\mathfrak{p} \oplus \mathfrak{p}^0 \oplus \mathfrak{p}^{\perp}$. Such an isomorphism is equivalent to a complex subspace of \mathbb{C}^{n+1} complementary to $\langle v_0 \rangle_{\mathbb{C}}$, thus yielding a decomposition

$$\mathfrak{sl}(n+1, \mathbb{C}) = \left\{ \begin{pmatrix} -\mathrm{tr} A & \alpha \\ X & A \end{pmatrix} \middle| X \in \mathbb{C}^n, \alpha \in \mathbb{C}^{n*}, A \in \mathfrak{gl}(n, \mathbb{C}) \right\} \quad (5.12)$$

akin to (4.8). In the corresponding decomposition of $\mathrm{PGL}(n+1, \mathbb{C})$, the Levi subgroup $P^0 := P/\exp \mathfrak{p}^{\perp}$ consists of (equivalence classes of) block-diagonal matrices in G ; clearly the adjoint action of P^0 on $\mathfrak{g}/\mathfrak{p} \cong \mathbb{C}^n$ induces an isomorphism $\mathfrak{p}^0 \cong \mathfrak{gl}(n, \mathbb{C})$. Then $\mathfrak{p}^{\perp} \cong \mathbb{C}^{n*}$ consists of matrices with only the α -block, $\mathfrak{p}^0 \cong \mathfrak{gl}(n, \mathbb{C})$ of block-diagonal matrices, and $\mathfrak{p} \cong \mathfrak{gl}(n, \mathbb{C}) \ltimes \mathbb{C}^{n*}$ of block upper-triangular matrices.

Choose an algebraic Weyl structure, so that $\mathfrak{g} \cong \mathbb{C}^n \oplus \mathfrak{gl}(n, \mathbb{C}) \oplus \mathbb{C}^{n*}$. Using the decomposition (5.12), we can write down the Lie brackets between the three summands: if $X, Y \in \mathbb{C}^n$, $A, B \in \mathfrak{gl}(n, \mathbb{C})$ and $\alpha, \beta \in \mathbb{C}^{n*}$ then

$$[X, Y] = 0 = [\alpha, \beta], \quad [A, B] = AB - BA, \quad [A, X] = AX, \quad [A, \alpha] = -\alpha \circ A,$$

so that $\mathbb{C}^n, \mathbb{C}^{n*}$ form abelian subalgebras on which $\mathfrak{gl}(n, \mathbb{C})$ acts naturally. The bracket

$\mathbb{C}^n \times \mathbb{C}^{n*} \rightarrow \mathfrak{gl}(n, \mathbb{C})$ requires a little more work to compute: if J is the complex structure used to identify $\mathbb{C}^n \cong \mathbb{R}^{2n}$, Hrdina [102] calculates that

$$[[X, \alpha], Y] = \alpha(X)Y + \alpha(Y)X - \alpha(JX)JY - \alpha(JY)JX.$$

Up to normalisation conventions, we see in particular that change of algebraic Weyl structure corresponds to change of connection in the c-projective class via (5.5).

Observe that $\mathbb{C}\mathbb{P}^n$ has a projective embedding defined as follows. The complex representation \mathbb{C}^{n+1} of $\mathfrak{g}_{\mathbb{C}} = \mathfrak{sl}(n+1, \mathbb{C}) \oplus \mathfrak{sl}(n+1, \mathbb{C})$ has a complex structure given by multiplication by \mathbf{i} , which we view as a linear map on the underlying real vector space. There is a conjugate-linear isomorphism $\sigma : \mathbb{C}^{n+1} \rightarrow \overline{\mathbb{C}^{n+1}}$ given by complex conjugation, so that $\sigma^2 = \text{id}$ and $\sigma\mathbf{i}\sigma^{-1}$ is the complex structure on $\overline{\mathbb{C}^{n+1}}$. Noting that representations of $\mathfrak{g}_{\mathbb{C}}$ are external tensor products of representations of each factor,⁴ it is clear that $\mathbf{i} \boxtimes \sigma\mathbf{i}$ is a real structure on $\mathbb{C}^{n+1} \boxtimes \overline{\mathbb{C}^{n+1}}$; the fixed-point set of $\sigma \boxtimes \sigma$ is the underlying real representation $\mathbb{W} := (\mathbb{C}^{n+1} \boxtimes \overline{\mathbb{C}^{n+1}})_{\mathbb{R}}$ of $\mathfrak{g} = \mathfrak{sl}(n+1, \mathbb{C})$. Identifying $[v] \in \mathbb{C}\mathbb{P}^n$ with the real 2-plane $\langle v, \mathbf{i}v \rangle_{\mathbb{C}}$ and $\overline{\mathbb{C}^{n+1}}$ with $\sigma(\mathbb{C}^{n+1})$, the map $[v] \mapsto [v \boxtimes \sigma v]$ defines an embedding $\mathbb{C}\mathbb{P}^n \hookrightarrow \mathbb{P}(\mathbb{C}^{n+1} \boxtimes \overline{\mathbb{C}^{n+1}}) = \mathbb{P}(\mathbb{W}_{\mathbb{C}})$. Since $(\sigma \boxtimes \sigma)(v \boxtimes \sigma v) = \sigma v \boxtimes \sigma^2 v = v \boxtimes \sigma v$, this map takes values in the underlying real representation \mathbb{W} , thus yielding a projective embedding $\mathbb{C}\mathbb{P}^n \hookrightarrow \mathbb{P}(\mathbb{W})$.

Evidently this embedding is not minimal, so that Kostant's Theorem 2.25 tells us that $\mathbb{C}\mathbb{P}^n$ is the intersection of quadrics in $\mathbb{P}(\mathbb{W})$ given by projection away from the Cartan square in $S^2\mathbb{W}^*$. In notation explained properly in the next subsection,

$$S^2\mathbb{W}^* = S^2 \left[\begin{array}{cccc} 0 & 0 & 0 & 1 \\ \circ & \circ & \cdots & \circ & \circ \\ \downarrow & \downarrow & & \downarrow & \downarrow \\ \circ & \circ & \cdots & \circ & \circ \\ 0 & 0 & & 0 & 1 \end{array} \right] = \begin{array}{cccc} 0 & 0 & 0 & 2 \\ \circ & \circ & \cdots & \circ & \circ \\ \downarrow & \downarrow & & \downarrow & \downarrow \\ \circ & \circ & \cdots & \circ & \circ \\ 0 & 0 & & 0 & 2 \end{array} \oplus \begin{array}{cccc} 0 & 0 & 0 & 1 & 0 \\ \circ & \circ & \cdots & \circ & \circ \\ \downarrow & \downarrow & & \downarrow & \downarrow \\ \circ & \circ & \cdots & \circ & \circ \\ 0 & 0 & & 0 & 1 & 0 \end{array},$$

where the first summand is the Cartan square $\odot^2\mathbb{W}^* = (S_{\mathbb{C}}^2\mathbb{C}^{n+1*} \boxtimes S_{\mathbb{C}}^2\overline{\mathbb{C}^{n+1*}})_{\mathbb{R}}$ and

$$\mathbb{U}^* := \begin{array}{cccc} 0 & 0 & 0 & 1 & 0 \\ \circ & \circ & \cdots & \circ & \circ \\ \downarrow & \downarrow & & \downarrow & \downarrow \\ \circ & \circ & \cdots & \circ & \circ \\ 0 & 0 & & 0 & 1 & 0 \end{array} = (\wedge_{\mathbb{C}}^2\mathbb{C}^{n+1} \boxtimes \wedge_{\mathbb{C}}^2\overline{\mathbb{C}^{n+1}})_{\mathbb{R}}$$

is the space of homogeneous quadratic polynomials which cuts out $\mathbb{C}\mathbb{P}^n$ as an intersection of quadrics. As in Subsection 4.2.1, \mathbb{U} is an irreducible \mathfrak{g} -representation.

Finally, since $\mathfrak{g} = \mathfrak{sl}(n+1, \mathbb{C})$ is again one of the problematic Lie algebras for the equivalence of categories guaranteed by Theorem 3.27. A prolongation can be constructed by methods similar to Theorem 4.7; see [51, Thm. 2.8].

⁴We will relate \mathfrak{g} - and $\mathfrak{g}_{\mathbb{C}}$ -representations more carefully in the next subsection.

Theorem 5.8. *On any almost complex manifold (M, J) of dimension $2n \geq 4$, there is an equivalence of categories between almost c -projective structures and regular normal parabolic geometries of type $\mathbb{C}\mathbb{P}^n$. The flat model is $\mathbb{C}\mathbb{P}^n$ with its canonical complex structure and c -projective structure determined by the Fubini–Study metric g_{FS} . \square*

Normality implies that the Weyl connections have torsion of type $(0, 2)$ only [51]. The discussion following Lemma 5.6 then implies that this torsion T is a c -projectively invariant TM -valued $(0, 2)$ -form, being proportional to the Nijenhuis torsion N^J of J .

5.3.2 Representations of $\mathfrak{sl}(n+1, \mathbb{C})$

The description of \mathfrak{g} - and \mathfrak{p} -representations proceeds more smoothly if we consider the complexification $\mathfrak{g}_{\mathbb{C}} := \mathfrak{sl}(n+1, \mathbb{C}) \oplus \mathfrak{sl}(n+1, \mathbb{C})$ of \mathfrak{g} . Representations of $\mathfrak{g}_{\mathbb{C}}$ are external tensor products of representations of the two factors, with one factor notated on each line of the Satake diagram (5.11). However, some care must be taken. Firstly, a representation of $\mathfrak{g}_{\mathbb{C}}$ is the complexification of a representation of \mathfrak{g} if and only if it is self-conjugate. Secondly, a complex representation of $\mathfrak{g}_{\mathbb{C}}$ may be reducible over \mathbb{C} but irreducible over \mathbb{R} : for example, consider the $\mathfrak{g}_{\mathbb{C}}$ -representations⁵

$$\begin{array}{ccc} \begin{array}{c} a \quad b \quad \dots \quad c \quad d \\ \circ - \circ - \dots - \circ - \circ \\ \\ \circ - \circ - \dots - \circ - \circ \\ a \quad b \quad \dots \quad c \quad d \end{array} & \text{and} & \begin{array}{c} a \quad b \quad \dots \quad c \quad d \quad 0 \quad 0 \quad \dots \quad 0 \quad 0 \\ \circ - \circ - \dots - \circ - \circ \quad \circ - \circ - \dots - \circ - \circ \\ \\ \circ - \circ - \dots - \circ - \circ \quad \oplus \quad \circ - \circ - \dots - \circ - \circ \\ 0 \quad 0 \quad \dots \quad 0 \quad 0 \quad a \quad b \quad \dots \quad c \quad d \end{array} \end{array}$$

The first is irreducible over both \mathbb{R} and \mathbb{C} , being the complexification of an irreducible \mathfrak{g} -representation⁶; while the second is reducible over \mathbb{C} but irreducible over \mathbb{R} , since the second summand is the complex conjugate of the first.

With these technicalities in mind let us describe some important representations of \mathfrak{g} and \mathfrak{p} , as well as their associated bundles. By the Cartan condition, the complexified isotropy representation $(\mathfrak{g}/\mathfrak{p})_{\mathbb{C}}$ and its dual $(\mathfrak{g}/\mathfrak{p})_{\mathbb{C}}^* \cong \mathfrak{p}_{\mathbb{C}}^{\perp}$ have associated bundles

$$\mathbb{C}TM = \begin{array}{c} \begin{array}{c} 1 \quad 0 \quad \dots \quad 0 \quad 0 \quad 1 \\ \circ - \circ - \dots - \circ - \circ - \times \\ \\ \circ - \circ - \dots - \circ - \circ - \times \\ 0 \quad 0 \quad \dots \quad 0 \quad 0 \quad 0 \end{array} \oplus \begin{array}{c} \begin{array}{c} 0 \quad 0 \quad \dots \quad 0 \quad 0 \quad 0 \\ \circ - \circ - \dots - \circ - \circ - \times \\ \\ \circ - \circ - \dots - \circ - \circ - \times \\ 1 \quad 0 \quad \dots \quad 0 \quad 0 \quad 1 \end{array} \end{array} = T^{1,0}M \oplus T^{0,1}M \quad (5.13)$$

$$\text{and } \mathbb{C}T^*M = \begin{array}{c} \begin{array}{c} 0 \quad 0 \quad \dots \quad 0 \quad 1 \quad -2 \\ \circ - \circ - \dots - \circ - \circ - \times \\ \\ \circ - \circ - \dots - \circ - \circ - \times \\ 0 \quad 0 \quad \dots \quad 0 \quad 0 \quad 0 \end{array} \oplus \begin{array}{c} \begin{array}{c} 0 \quad 0 \quad \dots \quad 0 \quad 0 \quad 0 \\ \circ - \circ - \dots - \circ - \circ - \times \\ \\ \circ - \circ - \dots - \circ - \circ - \times \\ 0 \quad 0 \quad \dots \quad 0 \quad 1 \quad -2 \end{array} \end{array} = \wedge^{1,0}M \oplus \wedge^{0,1}M. \quad (5.14)$$

⁵Note that we denote representations of the complexifications $\mathfrak{g}_{\mathbb{C}}, \mathfrak{p}_{\mathbb{C}}$ on their respective Dynkin diagrams, rather than on the Satake diagrams (5.11) of $\mathfrak{g}, \mathfrak{p}$.

⁶With highest weight given by “putting the arrows in”.

The decomposition (5.3) of $\wedge_{\mathbb{C}}^k \mathbb{C}T^*M$ into (p, q) -forms complex irreducible subrepresentations is given by taking exterior powers of (5.14); similar statements hold for the decompositions of $\wedge_{\mathbb{C}}^k \mathbb{C}TM$, $S_{\mathbb{C}}^k \mathbb{C}T^*M$ and $S_{\mathbb{C}}^k \mathbb{C}TM$, with $\wedge^{p,p}M$ and $\wedge^{p,q}M \oplus \wedge^{q,p}M$ complexifications of real representations for all $p + q \in \{1, \dots, 2n\}$.

The line bundle $\mathcal{L} := (\wedge^{2n} TM)^{1/(n+1)}$ from Lemma 5.6 is associated to the $(n+1)$ st root L of $\wedge^{2n}(\mathfrak{g}/\mathfrak{p})$. Since the top exterior power of $\mathfrak{g}/\mathfrak{p}$ is the derivative of the real character $\det : \mathrm{GL}(n, \mathbb{C}) \rightarrow \mathbb{R}$, equation (5.13) implies that L has highest weight

$$L := \begin{array}{cccc} 0 & 0 & \cdots & 0 & 1 \\ \circ & \circ & \cdots & \circ & \times \\ \downarrow & \downarrow & & \downarrow & \downarrow \\ \circ & \circ & \cdots & \circ & \times \\ 0 & 0 & & 0 & 1 \end{array} . \quad (5.15)$$

Note that $L = H_0(\mathfrak{p}^\perp; \mathbb{W}^*)$, where $\mathbb{W} = (\mathbb{C}^{n+1} \boxtimes \overline{\mathbb{C}^{n+1}})_{\mathbb{R}}$ is the \mathfrak{g} -representation from Subsection 5.3.1 admitting a projective embedding $\mathbb{C}\mathbb{P}^n \hookrightarrow \mathbb{P}(\mathbb{W})$.

As Subsection 4.2.3, our choice of group $G = \mathrm{PGL}(n+1, \mathbb{C})$ with Lie algebra $\mathfrak{g} = \mathfrak{sl}(n+1, \mathbb{C})$ means that not all \mathfrak{g} -representations integrate to global representations of G . Indeed, a representation integrates if and only if the central circle in $\tilde{G} = \mathrm{SL}(n+1, \mathbb{C})$ acts trivially. As before we can locally avoid this problem by forming the extended Cartan bundle $F^{\tilde{P}} := F^P \times_P \tilde{P}$, where $\tilde{P} \leq \tilde{G}$ is the parabolic stabiliser of a given complex line in \mathbb{C}^{n+1} (previously denoted $\langle v_0 \rangle_{\mathbb{C}}$). Then all \mathfrak{g} -representations integrate to \tilde{G} -representations with respect to which we may form associated bundles, before taking the (local) quotient to F^P . We obtain a G -integrability criterion by complexifying: since $G_{\mathbb{C}} \cong \mathrm{PGL}(n+1, \mathbb{C}) \times \mathrm{PGL}(n+1, \mathbb{C})$, a $\mathfrak{g}_{\mathbb{C}}$ -representation integrates to $G_{\mathbb{C}}$ if and only if the sum of the weight coefficients on each branch is even [84].

The standard representation of $\mathfrak{g} = \mathfrak{sl}(n+1, \mathbb{C})$ on $\mathbb{T} := \mathbb{C}^{n+1}$ has highest weight

$$\mathbb{T} := \begin{array}{cccc} 1 & 0 & \cdots & 0 & 0 \\ \circ & \circ & \cdots & \circ & \circ \\ \circ & \circ & \cdots & \circ & \circ \\ 0 & 0 & & 0 & 0 \end{array}$$

and therefore does not integrate to G . The associated bundle $\mathcal{T} := F^{\tilde{P}} \times_{\tilde{P}} \mathbb{T}$ is called the *standard tractor bundle* of c-projective geometry, a complex bundle of (real) rank $2n+2$ over M . The decomposition (5.12) implies that an element $\begin{bmatrix} (\det_{\mathbb{C}} C)^{-1} & \alpha \\ 0 & C \end{bmatrix} \in \tilde{P}$ acts on $\mathbb{T}_0 := \langle v_0 \rangle_{\mathbb{C}} \leq \mathbb{T}$ by multiplication by $(\det_{\mathbb{C}} C)^{-1}$, so that

$$\mathbb{T}_0 = \begin{array}{cccc} 0 & 0 & \cdots & 0 & -1 \\ \circ & \circ & \cdots & \circ & \times \\ \circ & \circ & \cdots & \circ & \times \\ 0 & 0 & & 0 & 0 \end{array} \quad \text{and} \quad \mathbb{T}/\mathbb{T}_0 = \begin{array}{cccc} 1 & 0 & \cdots & 0 & 0 \\ \circ & \circ & \cdots & \circ & \times \\ \circ & \circ & \cdots & \circ & \times \\ 0 & 0 & & 0 & 0 \end{array} \quad (5.16)$$

are the socle and top of the \mathfrak{p}^\perp -filtration $\mathbb{T} \supset \mathbb{T}_0 \supset 0$ of \mathbb{T} . In particular, $L^{-1,0} := \mathbb{T}_0$ is an $(n+1)$ st root of the bundle $\wedge^{n,0}M$ of holomorphic n -forms. Writing $L^{0,-1} := \overline{L^{-1,0}}$ and $L^{1,0} := (L^{-1,0})^*$, the representation $L^{p,q} := (L^{1,0})^{\otimes p} \boxtimes (L^{0,1})^{\otimes q}$ has highest weight

$$L^{p,q} := \begin{array}{cccc} 0 & 0 & \cdots & 0 & p \\ \circ & \circ & \cdots & \circ & \times \\ \circ & \circ & \cdots & \circ & \times \\ 0 & 0 & \cdots & 0 & q \end{array}$$

for all $(p, q) \in \mathbb{Z}^2$; thus $L^{1,1} \cong L_{\mathbb{C}}$, the complexification of (5.15). A choice of Weyl structure then gives a grading $\mathcal{T} \cong (\mathcal{L}^{-1,0} \otimes T^{1,0}M) \oplus \mathcal{L}^{-1,0}$, where $\mathcal{L}^{p,q}$ is the bundle associated to $L^{p,q}$. As in Remark 4.8, the choice of a representation $L^{-1,0}$ with $L^{-1,0} \boxtimes \overline{L^{-1,0}} \cong L_{\mathbb{C}}^*$ is equivalent to the extension of the Cartan bundle to structure group \tilde{P} ; see [51, §3.1].

5.3.3 Harmonic curvature

We next compute the harmonic curvature of the canonical Cartan connection, which lies in the Lie algebra homology $H_2(\mathfrak{p}^\perp; \mathfrak{g})$. The adjoint representation of \mathfrak{g} is given by

$$\mathfrak{sl}(n+1, \mathbb{C}) = \left(\begin{array}{cccc} 1 & 0 & \cdots & 0 & 1 & 0 & 0 & \cdots & 0 & 0 \\ \circ & \circ & \cdots & \circ & \circ & \circ & \circ & \cdots & \circ & \circ \\ \circ & \circ & \cdots & \circ & \circ & \circ & \circ & \cdots & \circ & \circ \\ 0 & 0 & \cdots & 0 & 0 & 1 & 0 & \cdots & 0 & 1 \end{array} \right)_{\mathbb{R}},$$

so that the beginning of the Hasse diagram computing this homology is given by taking the real \mathfrak{p} -representation underlying the direct sum of each complex $\mathfrak{p}_{\mathbb{C}}$ -representation in Figure 5.1 and its complex conjugate. Each complex representation in the third column of Figure 5.1 contributes a component to the harmonic curvature, which is a section of the real bundle associated to the direct sum of that representation and its complex conjugate. From top to bottom these bundles are

$$\begin{aligned} & (\wedge^{2,0}M \otimes_{\mathbb{C}} \mathfrak{sl}(T^{1,0}M) \oplus \wedge^{0,2}M \otimes_{\mathbb{C}} \mathfrak{sl}(T^{0,1}M))_{\mathbb{R}}, \\ & (\wedge^{1,1}M \otimes_{\mathbb{C}} \mathfrak{sl}(T^{1,0}M) \oplus \wedge^{1,1}M \otimes_{\mathbb{C}} \mathfrak{sl}(T^{0,1}M))_{\mathbb{R}} \\ \text{and } & (\wedge^{0,2}M \otimes_{\mathbb{C}} T^{1,0}M \oplus \wedge^{2,0}M \otimes_{\mathbb{C}} T^{0,1}M)_{\mathbb{R}}, \end{aligned}$$

which may be identified with subbundles of $\wedge_-^2 T^*M \otimes \mathfrak{sl}(TM, J)$, $\wedge_+^2 T^*M \otimes \mathfrak{sl}(TM, J)$ and $\wedge_-^2 T^*M \otimes TM$ respectively. The components of the harmonic curvature lying in $\wedge_+^2 T^*M \otimes \mathfrak{sl}(TM, J)$ and $\wedge_-^2 T^*M \otimes \mathfrak{sl}(TM, J)$ are called the $(1, 1)$ - and $(2, 0)$ -parts $W^{\nabla+}$ and $W^{\nabla-}$ of the Weyl curvature W^{∇} of ∇ . The Weyl curvature is totally trace-free, complex-linear and satisfies the algebraic symmetries of a curvature tensor.

However, unlike in projective differential geometry, W^∇ is not c -projectively invariant in general; this is discussed further below. The $(2, 0)$ -part $W^{\nabla-}$ vanishes if and only if the c -projective class contains a holomorphic connection [51].

The component in $\wedge^2 T^*M \otimes TM$ may be identified with the torsion T of a connection in $[\nabla]^c$, which we identify with the Nijenhuis torsion N^J of J . This component vanishes if and only if J is integrable. As usual, the harmonic curvature vanishes entirely if and only if $(M, J, [\nabla]^c)$ is locally isomorphic to the flat model $\mathbb{C}\mathbb{P}^n$.

By Theorem 3.36, the curvature tensor R^∇ of a Weyl connection $\nabla \in [\nabla]^c$ decomposes as $R^\nabla = W^\nabla - \llbracket \text{id} \wedge r^\nabla \rrbracket^c$, where $r^\nabla := -\square_M^{-1} \partial R^\nabla$ is the normalised Ricci tensor of ∇ . Since $\delta_\gamma W^\nabla = \llbracket T, \cdot \rrbracket^c$ by Theorem 3.36(3) and T has type $(0, 2)$, we conclude that $W^+ := W^{\nabla+}$ is c -projectively invariant and $\delta_\gamma W^{\nabla-} = \llbracket T_{X,Y}, \gamma \rrbracket^c$; in particular, $W^{\nabla-}$ is c -projectively invariant if and only if J is integrable.

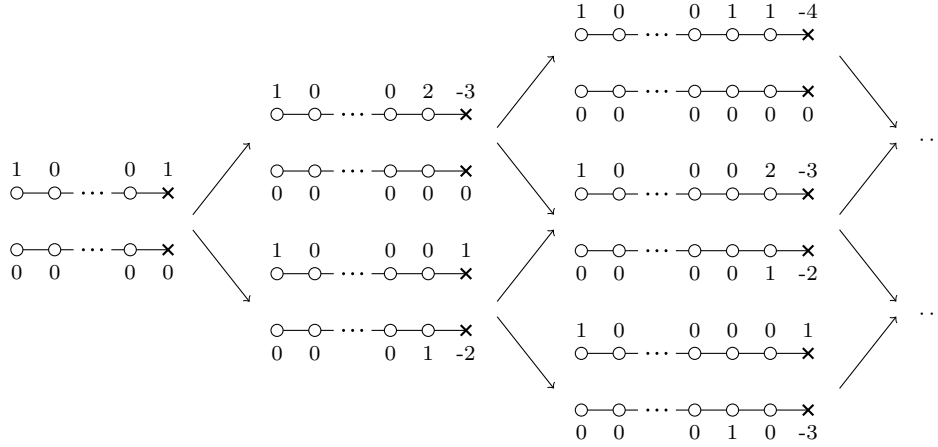

Figure 5.1: The Hasse diagram of $\mathfrak{sl}(n+1, \mathbb{C}) \boxtimes \mathbb{C}$ (drawn here for $n \geq 5$) which, together with its complex-conjugate, computes the homology $H_\bullet(\mathfrak{p}^\pm; \mathfrak{g})_c$.

The Cotton–York tensor $C^\nabla := d^\nabla r^\nabla$ of ∇ splits into components $C^{\nabla\pm}$ according to the decomposition (5.4) of $\wedge^2 T^*M$. For later use we collect together some curvature identities, the proof of which are similar, modulo handling torsion, to the corresponding results of Propositions 4.9 and 4.10. Detailed proofs may be found in [51].

Proposition 5.9. *Let $\nabla \in [\nabla]^c$ be a Weyl connection. Then:*

- (1) W^+ is c -projectively invariant and valued in $\mathfrak{sl}(TM, J)$, while $W^{\nabla-}$ is c -projectively invariant if and only if J is integrable. Both $W^{\nabla\pm}$ satisfy $\partial W^{\nabla\pm} = 0$, with W^+ totally trace-free; if J is integrable then $W^{\nabla-}$ is also totally trace-free.

(2) W^+ and $W^{\nabla-}$ satisfy the Bianchi identities

$$\begin{aligned} W_{X,Y}^+ \cdot Z + W_{Y,Z}^+ \cdot X + W_{Z,X}^+ \cdot Y &= 0 \\ \text{and } W_{X,Y}^{\nabla-} \cdot Z + W_{Y,Z}^{\nabla-} \cdot X + W_{Z,X}^{\nabla-} \cdot Y &= (d^\nabla T)_{X,Y,Z}. \end{aligned} \quad (5.17)$$

(3) C^∇ and $C^\nabla \circ J$ also satisfy Bianchi identities

$$\begin{aligned} C_{X,Y}^\nabla(Z) + C_{Y,Z}^\nabla(X) + C_{Z,X}^\nabla(Y) &= 0 \\ \text{and } C_{X,Y}^\nabla(JZ) + C_{Y,Z}^\nabla(JX) + C_{Z,X}^\nabla(JY) &= 0. \end{aligned} \quad (5.18)$$

(4) We have $\varepsilon^i(\nabla_{e_i} W_{X,Y}^+) = (n-1)C_{X,Y}^{\nabla+}$ and $\varepsilon^i(\nabla_{e_i} W_{X,Y}^{\nabla-}) = (n-2)C_{X,Y}^{\nabla-}$ with respect to any local frame $\{e_i\}_i$ with dual coframe $\{\varepsilon^i\}_i$.

(5) r^∇ is related to the Ricci curvature ∂R^∇ of ∇ by

$$r^\nabla = -\frac{1}{n-1}(\text{sym } \partial R^\nabla) - \frac{1}{n+1}(\text{alt } \partial R^\nabla) + \frac{2}{n^2-1}(\text{sym } \partial R^\nabla)^+$$

In particular, if r^∇ is symmetric and J -invariant then $r^\nabla = -\frac{1}{n+1}\partial R^\nabla$. \square

5.4 Associated BGG operators

Metrisability of a c -projective structure may be handled in a similar way to metrisability of real projective structures. As in the real projective case, the flat model $\mathbb{C}\mathbb{P}^n$ embeds into the projectivisation of an irreducible \mathfrak{g} -representation \mathbb{W} , and the first BGG operator associated to \mathbb{W} has kernel isomorphic to the space of compatible Kähler metrics. We will make this correspondence explicit in Subsection 5.4.1 below.

The dual representation \mathbb{W}^* also has an associated first BGG operator, which, for reasons discussed in Subsection 5.4.2, we did not consider for projective differential geometry. In c -projective geometry this operator, called the *c-projective hessian*, controls which Weyl connections have symmetric J -invariant normalised Ricci tensor.

For the remainder of this chapter we assume that J is integrable, so that $W^- := W^{\nabla-}$ and hence $W := W^\nabla$ are c -projectively invariant.

5.4.1 Metrisability of c -projective structures

Let $(M, J, [\nabla]^c)$ be a c -projective manifold of dimension $2n$. Describing the metrisability of $[\nabla]^c$ proceeds in much the same way as in the real projective case, except that now we are concerned with (pseudo-)Kähler metrics. Such metrics are smooth sections of $S_+^2 T^*M$, suggesting we consider the natural decomposition

$$T^*M \otimes S_+^2 TM = (\text{id} \odot TM)_+ \oplus (T^*M \otimes_\circ S_+^2 TM) \quad (5.19)$$

in place of (4.16), where the first summand is the image of $Z \mapsto \text{id} \odot Z + J \odot JZ$ and the second summand is the kernel of the natural trace $T^*M \otimes S_+^2 TM \rightarrow TM$. Projection onto $T^*M \otimes S_+^2 TM$ in (5.19) shall be denoted by the subscript “ \circ ”. The proof of the following proposition is analogous to the proof of Proposition 4.11.

Proposition 5.10. *The first-order linear differential equation $(\nabla h)_\circ = 0$ is c-projectively invariant on sections of $\mathcal{L}^* \otimes S_+^2 TM$. \square*

We refer to the equation $(\nabla h)_\circ = 0$ as the *linear metric equation* of c-projective geometry, and its solutions as *linear metrics*. We may equivalently write

$$\nabla_X h = X \odot Z^\nabla + JX \odot JZ^\nabla \quad (5.20)$$

for some $Z^\nabla \in \Omega^0(M; \mathcal{L}^* \otimes TM)$ and all $X \in \Omega^0(M; TM)$, which should be compared with (4.17) and (5.9). Taking a trace in (5.20) easily yields $Z^\nabla = \frac{2}{n} \partial(\nabla h)$.

Identifying $\wedge^{2n} TM \cong \mathcal{L}^{n+1}$, a non-degenerate Kähler metric g induces a section of $\mathcal{L}^* \otimes S_+^2 TM$ defined by

$$h := (\det g)^{1/(2n+2)} g^{-1},$$

which we call the *linear metric* associated to g . Then $\det h = (\det g)^{-1/(n+1)}$ is a section of \mathcal{L}^2 , so that we may recover $g = (\det h)^{-1/2} h^{-1}$ from h ; cf. equation (5.8) and the discussion prior to Corollary 4.12.

Corollary 5.11. *There is a linear isomorphism between solutions of the linear metric equation and almost complex metric connections in $[\nabla]^c$. \square*

Thus we have reduced the metrisability problem for c-projective structures to the study of a c-projectively invariant first-order linear differential equation. Since the linear metric equation is over-determined, we next seek its prolongation.

Theorem 5.12. *There is a linear isomorphism between the space of solutions of the linear metric equation and parallel sections of the c-projective invariant connection*

$$\nabla_X^{\mathcal{W}} \begin{bmatrix} h \\ Z \\ \lambda \end{bmatrix} = \begin{bmatrix} \nabla_X h - X \odot Z - JX \odot JZ \\ \nabla_X Z - h(r^\nabla, \cdot) - \lambda X \\ \nabla_X \lambda - r_X^\nabla(Z) \end{bmatrix} - \frac{1}{n} \begin{bmatrix} 0 \\ -W_{e_i, X}^+ \cdot h(\varepsilon^i, \cdot) \\ h(C_{e_i, X}^{\nabla+}, \varepsilon^i) \end{bmatrix} \quad (5.21)$$

on sections (h, Z, λ) of $\mathcal{W} := (\mathcal{L}^* \otimes S_+^2 TM) \oplus (\mathcal{L}^* \otimes TM) \oplus \mathcal{L}^*$.

Proof. The only necessary modification of the proof of Theorem 4.14 is the following observation. Since every Weyl connection $\nabla \in [\nabla]^c$ is complex, we may assume that every local frame $\{e_i\}_i$ satisfies $e_{i+n} = J e_i$. Then since $W_{X, JY}^- = J \circ W_{X, Y}^-$ by Proposition 5.9, we have $W_{e_i, X}^- \cdot h(\varepsilon^i, \cdot) = W_{J e_i, X}^- \cdot h(J \varepsilon^i, \cdot) = -W_{e_i, X}^- \cdot h(\varepsilon^i, \cdot)$ so only the

J -invariant piece W^+ of the Weyl curvature contributes to the curvature correction. A similar observation applies to the Cotton–York tensor C^∇ . \square

In the presence of a background Kähler metric, writing the prolongation connection (5.21) with respect to its Levi-Civita connection yields the prolongation obtained by Domashev and Mikeš. The invariant version was obtained by Calderbank in the context of hamiltonian 2-forms [47], and in the language of Theorem 5.12 in [51].

Unsurprisingly, the linear metric may be interpreted as a first BGG operator. As described in Subsection 5.3.1, the flat model $\mathbb{C}\mathbb{P}^n$ admits a projective embedding $\mathbb{C}\mathbb{P}^n \hookrightarrow \mathbb{P}(\mathbb{W})$ for $\mathbb{W} := (\mathbb{C}^{n+1} \boxtimes \overline{\mathbb{C}^{n+1}})_{\mathbb{R}}$. Identifying \mathbb{C}^{n+1} with the standard representation $\mathbb{T} := \mathbb{C}^{n+1}$ and using (5.16), an algebraic Weyl structure yields

$$\begin{aligned} \mathbb{W}_{\mathbb{C}} &= ((L^{-1,0} \otimes T^{1,0}M) \oplus L^{-1,0}) \boxtimes ((L^{0,-1} \otimes T^{0,1}M) \oplus L^{0,-1}) \\ &\cong (L^{-1,-1} \otimes S^{1,1}(\mathfrak{g}/\mathfrak{p})_{\mathbb{C}}) \oplus (L^{-1,-1} \otimes (\mathfrak{g}/\mathfrak{p})_{\mathbb{C}}) \oplus L^{-1,-1}, \end{aligned} \quad (5.22)$$

so that the algebraic Weyl structure gives an isomorphism of the real bundle associated to \mathbb{W} and the bundle $\mathcal{W} = (\mathcal{L}^* \otimes S_+^2 TM) \oplus (\mathcal{L}^* \otimes TM) \oplus \mathcal{L}^*$ from Theorem 5.12. The first BGG operator associated to \mathbb{W} is a differential operator

$$\mathcal{D}^{\mathbb{W}} : \begin{array}{c} \begin{array}{ccccccc} \circ & \circ & \cdots & \circ & \circ & \times & \\ \uparrow & \uparrow & & \uparrow & \uparrow & & \\ \circ & \circ & \cdots & \circ & \circ & \times & \\ \downarrow & \downarrow & & \downarrow & \downarrow & & \\ \circ & \circ & \cdots & \circ & \circ & \times & \\ 1 & 0 & & 0 & 0 & & \end{array} \\ \mathcal{L}^* \otimes S_+^2 TM \end{array} \rightarrow \left(\begin{array}{c} \begin{array}{ccccccc} 1 & 0 & \cdots & 0 & 1 & -2 & \\ \circ & \circ & \cdots & \circ & \circ & \times & \\ \downarrow & \downarrow & & \downarrow & \downarrow & & \\ \circ & \circ & \cdots & \circ & \circ & \times & \\ 1 & 0 & & 0 & 0 & & \end{array} \oplus \begin{array}{ccccccc} 1 & 0 & \cdots & 0 & 0 & 0 & \\ \circ & \circ & \cdots & \circ & \circ & \times & \\ \downarrow & \downarrow & & \downarrow & \downarrow & & \\ \circ & \circ & \cdots & \circ & \circ & \times & \\ 1 & 0 & & 0 & 1 & -2 & \end{array} \right)_{\mathbb{R}}, \\ (\mathcal{L}^* \otimes S_+^2 TM) \otimes T^*M \end{array}$$

which is easily seen to be first order. The prolongation connection $\nabla^{\mathcal{W}}$ calculated in Theorem 5.12 is then precisely the prolongation connection of this BGG operator. The dimension of the space of parallel sections of $\nabla^{\mathcal{W}}$ is called the *mobility* of the c -projective structure, which is bounded above by $\dim \mathbb{W} = (n+1)^2$.

Remark 5.13. We could equally identify the summand $L^{-1,-1} \otimes (T^{1,0}M \boxtimes T^{0,1}M)$ in (5.22) with $L^{-1,-1} \otimes \wedge^{1,1} CTM$; indeed the \mathfrak{p} -representations $S_+^2(\mathfrak{g}/\mathfrak{p})$ and $\wedge_+^2(\mathfrak{g}/\mathfrak{p})$ are isomorphic via J . This explains the existence of the theory of hamiltonian 2-forms.

Recall from Section 4.3 that in projective differential geometry, the $\mathfrak{sl}(n+1, \mathbb{R})$ -representation $S^2 \mathbb{R}^{n+1} \oplus \mathfrak{gl}(n+1, \mathbb{R}) \oplus S^2 \mathbb{R}^{n+1*}$ has a graded Lie algebra structure isomorphic to $\mathfrak{sp}(2n+2, \mathbb{R})$. It turns out that a similar phenomenon occurs in c -projective geometry: since $\mathfrak{g}_{\mathbb{C}} = \mathfrak{sl}(n+1, \mathbb{C}) \oplus \mathfrak{sl}(n+1, \mathbb{C})$, we have

$$\mathfrak{g}_{\mathbb{C}} \oplus \mathbb{C} = \mathfrak{s}(\mathfrak{gl}(n+1, \mathbb{C}) \oplus \mathfrak{gl}(n+1, \mathbb{C}))$$

and the complexification of $\mathfrak{h} := \mathbb{W} \oplus (\mathfrak{g} \oplus \mathbb{R}) \oplus \mathbb{W}^*$ may be written as

$$\begin{aligned} \mathfrak{h}_{\mathbb{C}} &\cong (\mathbb{C}^{n+1} \boxtimes \overline{\mathbb{C}^{n+1*}}) \oplus ((\mathbb{C}^{n+1} \odot \mathbb{C}^{n+1*}) \oplus (\overline{\mathbb{C}^{n+1}} \odot \overline{\mathbb{C}^{n+1*}})) \\ &\quad \oplus (\mathbb{C}^{n+1*} \boxtimes \overline{\mathbb{C}^{n+1*}}) \\ &\cong (\mathbb{C}^{n+1} \oplus \overline{\mathbb{C}^{n+1}}) \odot (\mathbb{C}^{n+1*} \oplus \overline{\mathbb{C}^{n+1*}}), \end{aligned} \tag{5.23}$$

where we have used that the Cartan product $\mathbb{C}^{n+1} \odot \mathbb{C}^{n+1*}$ is the space of trace-free complex-linear maps of \mathbb{C}^{n+1} and that $\mathbb{C}^{n+1} \odot \overline{\mathbb{C}^{n+1}} = \mathbb{C}^{n+1} \boxtimes \overline{\mathbb{C}^{n+1}}$. This is precisely the adjoint representation of the complex Lie algebra $\mathfrak{sl}(\mathbb{C}^{n+1} \oplus \overline{\mathbb{C}^{n+1*}})$, so that $\mathfrak{h}_{\mathbb{C}}$ has a graded Lie algebra structure isomorphic to $\mathfrak{sl}(2n+2, \mathbb{C})$. The grading implies that $\mathbb{W}_{\mathbb{C}}, \mathbb{W}_{\mathbb{C}}^*$ are abelian subalgebras of $\mathfrak{h}_{\mathbb{C}}$, while $\mathfrak{q}_{\mathbb{C}} := (\mathfrak{g}_{\mathbb{C}} \oplus \mathbb{C}) \ltimes \mathbb{W}^*$ and $\hat{\mathfrak{q}}_{\mathbb{C}} := \mathbb{W} \ltimes (\mathfrak{g}_{\mathbb{C}} \oplus \mathbb{C})$ are opposite abelian parabolics. Given the evident real structure present in (5.23), we see that \mathfrak{h} is isomorphic to the real form

$$\mathfrak{q} = \begin{array}{c} \circ \text{---} \circ \text{---} \cdots \text{---} \circ \text{---} \circ \\ \updownarrow \quad \updownarrow \quad \quad \quad \updownarrow \quad \updownarrow \\ \circ \text{---} \circ \text{---} \cdots \text{---} \circ \text{---} \circ \end{array} \times \leq \begin{array}{c} \circ \text{---} \circ \text{---} \cdots \text{---} \circ \text{---} \circ \\ \updownarrow \quad \updownarrow \quad \quad \quad \updownarrow \quad \updownarrow \\ \circ \text{---} \circ \text{---} \cdots \text{---} \circ \text{---} \circ \end{array} = \mathfrak{su}(n+1, n+1) \cong \mathfrak{h}$$

of $\mathfrak{sl}(2n+2, \mathbb{C})$, so that $H \cdot \mathfrak{q}$ is grassmannian of maximal isotropic subspaces of \mathbb{C}^{2n+2} for a hermitian inner product of signature $(n+1, n+1)$; see [44, Ex. 2.2.2] and [60, Ex. 2.3.4(3)] for details regarding $\mathfrak{su}(n+1, n+1)$.

5.4.2 The c-projective hessian

In the previous subsection, we showed that the metrisability of a c-projective structure is controlled by the first BGG operator associated to the \mathfrak{g} -representation $\mathbb{W} := (\mathbb{C}^{n+1} \boxtimes \overline{\mathbb{C}^{n+1}})_{\mathbb{R}}$. There is also a first BGG operator associated to \mathbb{W}^* , which we did not consider in the real projective case. By way of justification for this omission recall that in projective differential geometry $\mathbb{W} := S^2\mathbb{R}^{n+1}$, so that the first BGG operator associated to \mathbb{W}^* is a linear differential operator

$$\mathcal{D}^{\mathbb{W}^*} : \begin{array}{c} 0 \quad 0 \quad \quad 0 \quad 0 \quad 2 \\ \circ \text{---} \circ \text{---} \cdots \text{---} \circ \text{---} \circ \text{---} \times \end{array} \rightarrow \begin{array}{c} 0 \quad 0 \quad \quad 0 \quad 3 \quad -4 \\ \circ \text{---} \circ \text{---} \cdots \text{---} \circ \text{---} \circ \text{---} \times \end{array} .$$

Using the inverse Cartan matrix of $\mathfrak{sl}(n+1, \mathbb{R})$, we easily see that $\mathcal{D}^{\mathbb{W}^*}$ is third-order. Choosing an algebraic Weyl structure for \mathbb{W} we see that $\mathcal{W}^* \cong \mathcal{L} \oplus (\mathcal{L} \otimes T^*M) \oplus (\mathcal{L} \otimes S^2T^*M)$ is the full 2-jet bundle $\mathcal{J}^2(\mathcal{L})$ of \mathcal{L} , so that the first BGG operator associated to \mathbb{W}^* is simply the third-order Ricci-corrected derivative $\mathcal{D}^{\mathbb{W}^*}(\ell) = \nabla^3\ell + 2(\nabla r^\nabla)\ell + 4\nabla\ell r^\nabla$; see [50, p. 169]. For $\ell \in \Omega^0(M; \mathcal{L})$ non-vanishing, writing this equation with respect to the special connection $\nabla^\ell \in [\nabla]^c$ defined by $\nabla^\ell\ell = 0$ yields $\mathcal{D}^{\mathbb{W}^*}(\ell) = 2(\nabla r^\nabla)\ell$, so that the kernel of $\mathcal{D}^{\mathbb{W}^*}$ may be interpreted as a space of ‘‘Einstein scales’’ [54, 86]; there is also a relation to Tanno equations [171].

The c-projective hessian has a significantly different character, which is arguably more important to the underlying c-projective geometry. Here $\mathbb{W}^* = (\mathbb{C}^{n+1*} \boxtimes \overline{\mathbb{C}^{n+1*}})_{\mathbb{R}}$ so that the associated first BGG operator is a linear differential operator

$$\mathcal{D}^{\mathbb{W}^*} : \begin{array}{cccccc} 0 & 0 & \cdots & 0 & 0 & 1 \\ \circ & \circ & \cdots & \circ & \circ & \times \\ \downarrow & \downarrow & \cdots & \downarrow & \downarrow & \downarrow \\ \circ & \circ & \cdots & \circ & \circ & \times \\ 0 & 0 & \cdots & 0 & 0 & 1 \end{array} \longrightarrow \left(\begin{array}{cccccc} 0 & 0 & \cdots & 0 & 1 & -3 \\ \circ & \circ & \cdots & \circ & \circ & \times \\ \oplus & & & & & \\ 0 & 0 & \cdots & 0 & 0 & 1 \\ \circ & \circ & \cdots & \circ & \circ & \times \\ 0 & 0 & \cdots & 0 & 1 & -3 \end{array} \right)_{\mathbb{R}}$$

$\mathcal{L} \qquad \qquad \qquad \mathcal{L} \otimes \mathbb{S}^2 T^*M$

called the *c-projective hessian*. Using the inverse Cartan matrix of $\mathfrak{g}_{\mathbb{C}}$, it is straightforward to check that $\mathcal{D}^{\mathbb{W}^*}$ must be second order; it follows that $\mathcal{D}^{\mathbb{W}^*}$ is projection onto $\mathcal{L} \otimes \mathbb{S}^2 T^*M$ of the Ricci-corrected second derivative [50], *i.e.*

$$\mathcal{D}_{X,Y}^{\mathbb{W}^*}(\ell) = (\nabla_{X,Y}^2 \ell + \ell r_X^{\nabla}(Y))_{-}. \quad (5.24)$$

It is straightforward to check that $\mathcal{D}^{\mathbb{W}^*}$ is c-projectively invariant. By Lemma 5.6, a section $\ell \in \Omega^0(M; \mathcal{L})$ uniquely determines a connection ∇^{ℓ} in the c-projective class by $\nabla^{\ell} \ell = 0$. The kernel of $\mathcal{D}^{\mathbb{W}^*}$ has the following geometric interpretation [51, Prop. 4.9].

Proposition 5.14. *A nowhere-vanishing section $\ell \in \Omega^0(M; \mathcal{L})$ satisfies $\mathcal{D}^{\mathbb{W}^*}(\ell) = 0$ if and only if the normalised Ricci tensor $r^{\nabla^{\ell}}$ of ∇^{ℓ} is symmetric and J -invariant.*

Proof. Since ℓ is nowhere-vanishing, $R^{\nabla^{\ell}} \cdot \ell = 0$ if and only if $r^{\nabla^{\ell}}$ is symmetric. Calculating with respect to ∇^{ℓ} , (5.24) gives $\mathcal{D}^{\mathbb{W}^*}(\ell) = 0$ if and only if $r^{\nabla^{\ell}}$ has vanishing J -anti-invariant part. \square

Corollary 5.15. *Let $h \in \Omega^0(M; \mathcal{L}^* \otimes \mathcal{B})$ be a linear metric. Then $(\det h)^{1/2}$ lies in the kernel of the c-projective hessian.*

Proof. By Corollary 5.11, the Levi-Civita connection ∇^g of the Kähler metric $g := (\det h)^{-1/2} h^{-1/2}$ lies within the c-projective class and satisfies $\nabla^g(\det h)^{-1/2} = 0$. Since the normalised Ricci tensor r^g of g is symmetric and J -invariant, the result follows by Proposition 5.14. \square

Remark 5.16. As remarked in the introduction to Section 5.3, all connections on a Riemann surface are c-projective and hence the case $n = 1$ must be dealt with differently. Indeed there is an isomorphism $\mathbb{C}\mathbb{P}^1 \cong \mathbb{S}^2$, so that 1-dimensional c-projective geometry coincides with 2-dimensional conformal geometry until we specify an additional piece of structure. This structure is called a *Möbius structure*, and is essentially the choice of a c-projective hessian; see [43, §6.3] and [46] for details.

Since $\mathcal{D}^{\mathbb{W}^*}$ is a first BGG operator, its solution space is isomorphic to the space of parallel sections of a connection $\nabla^{\mathbb{W}^*}$ on $\mathcal{W}^* \cong \mathcal{L} \oplus (\mathcal{L} \otimes T^*M) \oplus (\mathcal{L} \otimes \mathbb{S}_+^2 T^*M)$.

Theorem 5.17. *There is a linear isomorphism between the space of solutions of the c -projective hessian $\mathcal{D}^{\mathbb{W}^*}$ and parallel sections of the c -projectively invariant connection*

$$\nabla_X^{\mathbb{W}^*} \begin{bmatrix} \ell \\ \eta \\ \theta \end{bmatrix} = \begin{bmatrix} \nabla_X \ell - \eta(X) \\ \nabla_X \eta + \ell r_X^\nabla - \theta(X, \cdot) \\ \nabla_X \theta + r_X^\nabla \odot \eta + Jr_X^\nabla \odot J\eta \end{bmatrix} + \begin{bmatrix} 0 \\ 0 \\ (W_{\cdot, J}^+ \cdot \eta)(JX) + \ell C_{\cdot, J}^{\nabla+}(JX) \end{bmatrix} \quad (5.25)$$

on sections (ℓ, η, θ) of $\mathcal{W}^* \cong \mathcal{L} \oplus (\mathcal{L} \otimes T^*M) \oplus (\mathcal{L} \otimes \mathbb{S}_+^2 T^*M)$.

Proof. Define $\eta^\nabla := \nabla \ell$ and $\theta^\nabla := (\nabla^2 \ell + \ell r^\nabla)_+$, so that $\theta^\nabla = \nabla \eta^\nabla + \ell r^\nabla$ if and only if ℓ is in the kernel of $\mathcal{D}^{\mathbb{W}^*}$. It remains to establish the third slot of $\nabla^{\mathbb{W}^*}$.

Note first that $\nabla_X \theta^\nabla = \nabla_X(\nabla \eta^\nabla) + \ell(\nabla_X r^\nabla) + \eta^\nabla(X)r^\nabla$, which contracting with $Y \in \Omega^0(M; TM)$ and alternating in X, Y yields

$$\begin{aligned} (d^\nabla \theta^\nabla)_{X, Y} &= W_{X, Y} \cdot \eta^\nabla + \ell C_{X, Y}^\nabla + \llbracket \text{id} \wedge r^\nabla \rrbracket_{X, Y}^c \cdot \eta^\nabla \\ &\quad + \eta^\nabla(X)r_Y^\nabla - \eta^\nabla(Y)r_X^\nabla. \end{aligned} \quad (5.26)$$

Expanding the algebraic bracket and simplifying, the last three terms on the right-hand side above evaluate to

$$\begin{aligned} &\llbracket \text{id} \wedge r^\nabla \rrbracket_{X, Y}^c \cdot \eta^\nabla + \eta^\nabla(X)r_Y^\nabla - \eta^\nabla(Y)r_X^\nabla \\ &= (r_Y^\nabla \odot \eta^\nabla + Jr_Y^\nabla \odot J\eta^\nabla)(X, Z) - (r_X^\nabla \odot \eta^\nabla + Jr_X^\nabla \odot J\eta^\nabla)(Y, Z). \end{aligned}$$

Since θ^∇ is symmetric and J -invariant, $(\nabla_X \theta^\nabla)(JY, Z)$ is skew in Y, Z and hence

$$\begin{aligned} 2(\nabla_X \theta^\nabla)(Y, Z) &= (\nabla_X \theta^\nabla)(Y, Z) + (\nabla_X \theta^\nabla)(JZ, JY) \\ &= (d^\nabla \theta^\nabla)_{X, Y}(Z) + (\nabla_Y \theta^\nabla)(X, Z) \\ &\quad + (d^\nabla \theta^\nabla)_{X, JZ}(JY) + (\nabla_{JZ} \theta^\nabla)(X, JY) \\ &= (d^\nabla \theta^\nabla)_{X, Y}(Z) + (d^\nabla \theta^\nabla)_{X, JY}(JZ) + (d^\nabla \theta^\nabla)_{Y, JZ}(JX). \end{aligned}$$

Substituting (5.26) in the last display, we find that

$$\begin{aligned} 2(\nabla_X \theta^\nabla)(Y, Z) &= (W_{X, Y}^+ \cdot \eta^\nabla)(Z) + (W_{X, JZ}^+ \cdot \eta^\nabla)(JY) + (W_{Y, JZ}^+ \cdot \eta^\nabla)(JX) \\ &\quad + \ell C_{X, Y}^{\nabla+}(Z) + \ell C_{X, JZ}^{\nabla+}(JY) + \ell C_{Y, JZ}^{\nabla+}(JX) \\ &\quad - 2(r_X^\nabla \odot \eta^\nabla + Jr_X^\nabla \odot J\eta^\nabla)(Y, Z). \end{aligned} \quad (5.27)$$

where the J -anti-invariant parts W^- and $C^{\nabla-}$ vanishes automatically because the left-

hand side is J -invariant. Using the Bianchi identity (5.17) for W^+ , the first line on the right-hand side of (5.27) simplifies to

$$\begin{aligned}
& (W_{X,Y}^+ \cdot \eta^\nabla)(Z) + (W_{X,JZ}^+ \cdot \eta^\nabla)(JY) + (W_{Y,JZ}^+ \cdot \eta^\nabla)(JX) \\
&= -\eta^\nabla(-W_{Y,Z}^+ \cdot X - W_{Z,X}^+ \cdot Y - W_{JZ,JY}^+ \cdot X \\
&\quad - W_{JY,X}^+ \cdot JZ + W_{Y,JZ}^+ \cdot JX) \\
&= 2(W_{Y,Z}^+ \cdot \eta^\nabla)(X)
\end{aligned} \tag{5.28}$$

while the second line simplifies to

$$\begin{aligned}
& \ell C_{X,Y}^{\nabla+}(Z) + \ell C_{X,JZ}^{\nabla+}(JY) + \ell C_{Y,JZ}^{\nabla+}(JX) \\
&= -\ell C_{Y,Z}^{\nabla+}(X) - \ell C_{Z,X}^{\nabla+}(Y) - \ell C_{JZ,JY}^{\nabla+}(X) \\
&\quad - \ell C_{JY,X}^{\nabla+}(JZ) + \ell C_{Y,JZ}^{\nabla+}(JX) \\
&= 2\ell C_{Y,Z}^{\nabla+}(X)
\end{aligned} \tag{5.29}$$

by (5.18). Substituting (5.28) and (5.29) into (5.27), we arrive at the third slot of (5.25). C-projective invariance may be checked directly, as in the proof of Theorem 4.14, or by observing that $\nabla^{\mathcal{W}^*}$ is the prolongation connection of a first BGG operator. \square

It is straightforward to check that the tractor parts of $\nabla^{\mathcal{W}^*}$ and $\nabla^{\mathcal{W}}$ are dual, as expected. In particular, the prolongation connections $\nabla^{\mathcal{W}}$ and $\nabla^{\mathcal{W}^*}$ are dual on the flat model.

Quaternionic geometry

Following Berger’s classification of riemannian holonomy groups [24] and developments in almost complex geometry, it was natural to consider manifolds with a “quaternionic” structure. According to definitions given by Salamon [162] and Alekseevsky and Marchiafava [4, 5], an almost quaternionic manifold is a first order G -structure with structure group $GL(n, \mathbb{H}) \cdot Sp(1)$. We review the classical theory of almost quaternionic manifolds in Section 6.1, as well as describing a projective interpretation which develops in parallel with Sections 4.1 and 5.2.

In Section 6.2 we describe almost quaternionic geometry as an abelian parabolic geometry modelled on $G \cdot \mathfrak{p} = \mathbb{H}P^n$, so that $\mathfrak{g} = \mathfrak{sl}(n+1, \mathbb{H})$ and \mathfrak{p} is given by crossing the penultimate node. The flat model has a projective embedding $\mathbb{H}P^n \hookrightarrow \mathbb{P}(\mathbb{W})$ for $\mathbb{W} := (\wedge_{\mathbb{C}}^2 \mathbb{C}^{2n+2})_{\mathbb{R}}$, and, as for projective and c-projective geometries, the first BGG operator associated to \mathbb{W} controls metrisability of the quaternionic structure. The first BGG operator associated to \mathbb{W}^* is again a second-order hessian equation; we investigate both of these operators in Section 6.3.

6.1 Background on almost quaternionic geometry

After briefly reviewing the quaternion algebra in Subsection 6.1.1, we study the basic theory of almost quaternionic manifolds in Subsection 6.1.2. This theory is ostensibly better suited to description as a parabolic geometry than the classical theories of projective differential geometry or c-projective geometry, and we develop this parabolic viewpoint in Section 6.2. Before that however we give a “projective” interpretation of almost quaternionic geometry, in the style of Sections 4.1 and 5.2.

6.1.1 Background on quaternions

The *quaternions* are the elements of the (unique up to isomorphism) normed associative division algebra \mathbb{H} of dimension four over \mathbb{R} .¹ As a real algebra, \mathbb{H} is spanned by the real

¹Hopefully the reader will allow us to forgo the obligatory anecdote about Hamilton and the bridge—but see [182, §1.1.1] for a nice historical review.

unit $\mathbf{1}$ and three imaginary units $\{\mathbf{i}_a\}_{a=1}^3$ satisfying Hamilton's quaternionic relations

$$\mathbf{i}_a^2 = -\text{id}, \quad \mathbf{i}_a \mathbf{i}_b = \mathbf{i}_c = -\mathbf{i}_b \mathbf{i}_a \quad (6.1)$$

for all cyclic permutations (a, b, c) of $(1, 2, 3)$. In particular, the quaternions are non-commutative. A generic quaternion is of the form $q = q_0 \mathbf{1} + \sum_{a=1}^3 q_a \mathbf{i}_a$ for real numbers q_0, q_a . Then the euclidean norm gives a notion of a norm in \mathbb{H} , while reversing the signs of imaginary components gives a notion of conjugation. A quaternion is *imaginary* if $\bar{q} = -q$, and the imaginary quaternions form a 3-dimensional subspace $\mathfrak{sp}(1) \leq \mathbb{H}$. In particular if $q \in \mathfrak{sp}(1)$ then $q^2 = -\|q\|^2 \mathbf{1}$, so that the square roots of -1 form a 2-sphere in \mathbb{H} . Thus the choice of $\{\mathbf{i}_a\}_{a=1}^3$ satisfying (6.1) is not canonical, being equivalent to an oriented orthonormal basis of $\mathfrak{sp}(1)$; such a basis determines the isomorphism $\mathbb{H} \cong \mathbb{R}^4$.

Due to non-commutativity, the automorphism group of \mathbb{H} is quite large. Firstly $q \mapsto \bar{q}$ defines an automorphism of \mathbb{H} to its opposite algebra; moreover each $q \in \text{Sp}(1) := \{q \in \mathbb{H} \mid \|q\| = 1\}$ determines an automorphism $p \mapsto qp\bar{q}$ by conjugation. The latter yields a homomorphism $\text{Sp}(1) \rightarrow \text{Aut}(\mathbb{H})$ with kernel $\pm \mathbf{1}$ which is orthogonal with respect to the euclidean norm on \mathbb{H} . Restricting to $\mathfrak{sp}(1)$ gives a surjective homomorphism $\text{Sp}(1) \twoheadrightarrow \text{SO}(\mathfrak{sp}(1))$ which realises the exceptional isomorphism $\text{Sp}(1) \cong \text{Spin}(3)$. On the other hand if $\phi \in \text{Aut}(\mathbb{H})$ then ϕ preserves the 2-sphere of imaginary units, so is an orthogonal map. For orthogonal $p, q \in \mathfrak{sp}(1)$ we have $0 \neq pq \in \mathfrak{sp}(1)$, so that $\{p, q, pq\}$ is an oriented orthogonal basis of $\mathfrak{sp}(1)$; in fact all such bases arise in this way. Due to the large automorphism group, it is interesting to consider a larger class of maps than just the quaternion-linear ones. Namely, we consider all real linear maps $f : V \rightarrow W$ such that $f(vq) = f(v)\phi(q)$ for some $\phi \in \text{Aut}(\mathbb{H})$ and all $v \in V$ and $q \in \mathbb{H}$. Here \mathbb{H} acts on V, W on the right to ensure the usual matrix multiplication conventions.

Finally, a *quaternionic structure* on a real vector space V is a 3-dimensional subspace $Q \leq \mathfrak{gl}(V)$ admitting a basis $\{J_a\}_{a=1}^3$ satisfying analogues of the quaternionic relations (6.1). In particular, the choice of basis $\{J_a\}_{a=1}^3$ for Q is an additional choice. Evidently a quaternionic vector space is a right \mathbb{H} -module, so is isomorphic to \mathbb{H}^n for some n ; in particular, $\dim V = 4n$ is divisible by four. Choosing a particular J_a allows us to form the complex vector space $V_{\mathbb{C}}$ in which $\mathbf{i} := \sqrt{-1} \in \mathbb{C}$ acts via J_a . Then (V, Q) may be identified with $V_{\mathbb{C}}$ together with the conjugate-linear map \mathbf{j} determined by the action of J_b ; this alternative viewpoint will frequently be useful.

6.1.2 Classical theory

We now review the basic theory of almost quaternionic manifolds as described by Alekseevsky and Marchiafava [4, 5, 9]. Let M be a smooth manifold of dimension $m > 4$. An *almost quaternionic structure* on M is a rank three subbundle $\mathcal{Q} \leq \mathfrak{gl}(TM)$

with fibres isomorphic to $\mathfrak{sp}(1)$. A linear connection ∇ on TM is then called *almost quaternionic* if ∇ preserves \mathcal{Q} , i.e. $\nabla_X \mathcal{Q} \subseteq \mathcal{Q}$ for all $X \in \Omega^0(M; TM)$. We define an *almost quaternionic manifold* to be such a pair (M, \mathcal{Q}) which admits an almost quaternionic connection. Equivalently an almost quaternionic structure is a reduction of the frame bundle of M to structure group $P^0 := \mathrm{GL}(n, \mathbb{H}) \cdot \mathrm{Sp}(1)$, the quotient of $\mathrm{GL}(n, \mathbb{H}) \times \mathrm{Sp}(1)$ by its natural \mathbb{Z}_2 -action, which admits a principal P^0 -connection satisfying a certain torsion condition; see [4, §4].

Remark 6.1. In dimension four the structure group $\mathrm{GL}(1, \mathbb{H}) \cdot \mathrm{Sp}(1)$ is isomorphic to the conformal group $\mathrm{CO}(4, \mathbb{R})$, so that a 4-dimensional quaternionic manifold is just a 4-dimensional conformal manifold [90]. To retain the features of almost quaternionic geometry one must stipulate that the anti-self-dual part of the conformally invariant Weyl curvature vanishes, so that we define a 4-dimensional almost quaternionic manifold as a self-dual conformal 4-manifold; see [29] and [60, §4.1.9], as well as the extensive literature on self-dual conformal manifolds.

Let (M, \mathcal{Q}) be an almost quaternionic manifold. Since the fibres of \mathcal{Q} are isomorphic to $\mathfrak{sp}(1)$, in a neighbourhood of any point in M there is a *local quaternionic frame* $\{J_a\}_{a=1}^3$ of \mathcal{Q} satisfying the usual multiplicative properties (6.1) of the quaternions:

$$J_a J_b = -\delta_{ab} \mathrm{id} + \sum_{c=1}^3 \epsilon_{abc} J_c \quad (6.2)$$

for all $a, b, c \in \{1, 2, 3\}$, where ϵ_{abc} is Levi-Civita's alternating symbol. Then the tangent space $T_x M$ is a quaternionic vector space in which application of $J_a|_x$ corresponds to multiplication by \mathbf{i}_a , so that $\dim M = 4n$ is divisible by four. Note that the J_a need not extend to global almost complex structures on M : it is well known that quaternionic projective space $\mathbb{H}\mathbb{P}^n$ is an almost quaternionic manifold, but admits no almost complex structures [133].

Identifying $\mathfrak{sp}(1) \cong \mathfrak{so}(3)$, the natural action of $\mathrm{SO}(3)$ on $\mathfrak{gl}(TM)$ preserves \mathcal{Q} . We therefore have an $\mathrm{SO}(3)$ -freedom in choosing a local quaternionic frame $\{J_a\}_{a=1}^3$; let us fix such a frame once and for all, noting that we must take care to ensure that any expression involving the J_a is invariant under this $\mathrm{SO}(3)$ action. For notational convenience we will assume from now on that (a, b, c) is a cyclic permutation of $(1, 2, 3)$, and occasionally employ the summation convention for quaternionic indices.

It is easy to show that a linear connection ∇ on TM is almost quaternionic if and only if there are 1-forms $\{\alpha_a\}_{a=1}^3$ such that

$$\nabla J_a = \alpha_b \otimes J_c - \alpha_c \otimes J_b. \quad (6.3)$$

Then ∇ is almost quaternionic if and only if the *fundamental form* $\Omega^{\mathcal{Q}} := \sum_{a=1}^3 J_a \otimes J_a$

is ∇ -parallel. This form was discovered by Kraines [120] and is often written as a 4-form using a compatible metric. Note in particular that $\Omega^{\mathcal{Q}}$ is invariant under the natural action of $\mathrm{SO}(3)$ on \mathcal{Q} , so that the class $[\nabla]^q$ of almost quaternionic connections is determined by \mathcal{Q} . Since an almost quaternionic structure has structure group $P^0 := \mathrm{GL}(n, \mathbb{H}) \cdot \mathrm{Sp}(1)$, the difference of two almost quaternionic connections $\nabla, \hat{\nabla}$ compatible with \mathcal{Q} is a \mathfrak{p}^0 -valued 1-form, where $\mathfrak{p}^0 := \mathfrak{gl}(n, \mathbb{H}) \oplus \mathfrak{sp}(1)$. Fujimura gives the following characterisation of quaternionically equivalent connections [82], which is a quaternionic analogue of Lemmas 4.2 and 5.2; also see [7, 8, 9].

Lemma 6.2. *Let ∇ be an almost quaternionic connection on (M, \mathcal{Q}) and suppose that $\hat{\nabla}$ is some other linear connection. Then $\hat{\nabla}$ is almost quaternionic if and only if*

$$\begin{aligned} \hat{\nabla}_X Y &= \nabla_X Y + \llbracket X, \alpha \rrbracket^q \cdot Y, \quad \text{where} \\ \llbracket X, \alpha \rrbracket^q \cdot Y &:= \frac{1}{2}(\alpha(X)Y + \alpha(Y)X - \sum_{a=1}^3 [\alpha(J_a X)J_a Y + \alpha(J_a Y)J_a X]) \end{aligned} \quad (6.4)$$

for some $\alpha \in \Omega^1(M)$ and all $X, Y \in \Omega^0(M; TM)$. □

Using (6.4) and the quaternionic relations (6.2), it is easy to see that $\llbracket \llbracket X, \alpha \rrbracket^q, J_a \rrbracket = \alpha(J_b X)J_c - \alpha(J_c X)J_b$, so that $\llbracket X, \alpha \rrbracket^q$ takes values in the normaliser of \mathcal{Q} .

Remark 6.3. In keeping with Lemmas 4.2 and 5.2, we shall call the endomorphism $\llbracket X, \alpha \rrbracket^q$ the *algebraic bracket* of X and α . Clearly $\llbracket X, \alpha \rrbracket^q$ is symmetric in X, Y . Note also that since we may write $\llbracket \cdot, \alpha \rrbracket^q = \mathrm{id} \odot \alpha + \sum_{a=1}^3 J_a \odot J_a \alpha$, the algebraic bracket is independent of the choice of local quaternionic frame $\{J_a\}_{a=1}^3$.

Lemma 6.2 exhibits $[\nabla]^q$ as an affine space modelled on 1-forms, with an embedding $\Omega^1(M) \hookrightarrow \Omega^1(M; \mathfrak{p}^0)$ given by the algebraic bracket. This may be understood as follows. Since an almost quaternionic structure is a P^0 -structure, the difference of two P^0 -connections is a 1-form valued in the first prolongation $(\mathfrak{p}^0 \otimes \mathbb{H}^{n+1*}) \cap (\mathbb{H}^{n+1} \otimes \mathbb{S}^2 \mathbb{H}^{n+1*})$ of \mathfrak{p}^0 . In our case, the first prolongation is isomorphic to \mathbb{H}^{n*} , with isomorphism given explicitly by $\alpha \mapsto \llbracket \cdot, \alpha \rrbracket^q$. Alekseevsky and Marchiafava [9] give an algebraic proof of this fact, while Salamon gives a representation-theoretic proof [162].

As in projective differential geometry and c-projective geometry, the following characterisation of almost quaternionic connections is available; *cf.* Lemmas 4.6 and 5.6.

Lemma 6.4. *There is a bijection between linear connections on the line bundle $\mathcal{L} := (\wedge^{4n} TM)^{1/(2n+2)}$ and connections in $[\nabla]^q$.* □

The 1-forms $\{\alpha_a\}_{a=1}^3$ from (6.3) vanish identically if and only if the induced connection on \mathcal{Q} is flat, in which case its holonomy reduces to $\mathrm{GL}(n, \mathbb{H}) \leq \mathrm{GL}(n, \mathbb{H}) \cdot \mathrm{Sp}(1)$. Such manifolds are called *hypercomplex*, since (M, J) is an almost complex manifold with respect to each unit norm $J \in \Omega^0(M; \mathcal{Q})$; see [108, 155].

A quantity on (M, \mathcal{Q}) is *quaternionically invariant* if it is independent of the choice of connection in $[\nabla]^q$. Since $[[X, \alpha]^q \cdot Y$ is symmetric in X, Y , two almost quaternionic connections $\nabla, \hat{\nabla}$ have the same torsion; thus the torsion is a quaternionic invariant. In terms of first-order P^0 -structures, the torsion coincides with the *intrinsic torsion* of a P^0 -structure, as determined by the Spencer complex. We drop the prefix “almost” in “almost quaternionic” if (M, \mathcal{Q}) admits a torsion-free almost quaternionic connection, in which case ∇ is simply called a *quaternionic connection*. In this case the quaternionic structure constitutes a “1-integrable” first-order P^0 -structure. Note that, unlike in almost complex geometry, the vanishing of the intrinsic torsion does not guarantee that any member of a quaternionic local frame is integrable, nor that we may choose quaternionic coordinates. Indeed, Kulkarni [121] proves that a simply connected almost quaternionic manifold admits quaternionic coordinates if and only if it is diffeomorphic to $\mathbb{H}\mathbb{P}^n$ with its canonical quaternionic structure.

Finally, the natural class of (pseudo-)riemannian metrics on an almost quaternionic manifold are those g with $g(JX, JY) = g(X, Y)$ for all unit norm $J \in \Omega^0(M; \mathcal{Q})$. Such metrics are called *Q-hermitian*; evidently it suffices that $g(J_a X, J_a Y) = g(X, Y)$ for all $a = 1, 2, 3$ and $X, Y \in \Omega^0(M; TM)$. A Q-hermitian metric g is *(pseudo-)quaternion-Kähler* if its Levi-Civita connection ∇ is almost quaternionic; since a Levi-Civita connection is torsion-free, it is immediate that such an almost quaternionic structure is quaternionic. Equivalently, ∇ preserves the subbundle \mathcal{Q} , or the fundamental form $\Omega^{\mathcal{Q}}$ is ∇ -parallel. The following is well-known; see [29, Thm. 14.39] for two different proofs.

Proposition 6.5. *Every quaternion-Kähler metric is Einstein.* □

In particular a quaternion-Kähler manifold of dimension $4n \geq 8$ has constant scalar curvature, and quaternion-Kähler manifolds are often called *positive* or *negative* depending on the sign of their scalar curvature. A quaternion-Kähler metric is equivalent to a reduction of structure group to the maximal compact subgroup $\mathrm{Sp}(n) \cdot \mathrm{Sp}(1)$ of P^0 , which is one of the groups on Berger’s holonomy list [24]. Surveys of the state of quaternion-Kähler geometry may be found in [6, 161, 164] and [29, Chpt. 14].

If the quaternionic structure underlying a quaternion-Kähler manifold (M, g, \mathcal{Q}) is hypercomplex, (M, g, \mathcal{Q}) is called *(pseudo-)hyperkähler* [100, 101]; in this case g has vanishing Ricci tensor [25], with riemannian holonomy contained in $\mathrm{Sp}(n)$. Note that some authors require quaternion-Kähler manifolds to have non-zero scalar curvature.

6.1.3 Projective interpretation

We can give a projective interpretation of quaternion-Kähler metrics whose Levi-Civita connections lie in the same quaternionic class by emulating the theory of Section 4.1

and Subsection 5.2.1. Let (M, g, \mathcal{Q}) be a $4n$ -dimensional (pseudo-)quaternion-Kähler manifold with Levi-Civita connection ∇ .

Definition 6.6. A smooth curve $\gamma \subset M$ is called a q -geodesic of ∇ if $\nabla_X X \in \langle X, J_a X \mid a = 1, 2, 3 \rangle$ for every vector field X tangent to γ . Quaternion-Kähler metrics g, \hat{g} are q -projectively equivalent if they have the same (unparameterised) q -geodesics.

If $n = 1$ this definition is vacuous, so we shall assume that $n > 1$. Following Fujimura [82], the following characterisation of q -projectivity is available.

Lemma 6.7. *Two quaternion-Kähler metrics are q -projectively equivalent if and only if their Levi-Civita connections are quaternionically equivalent.* \square

Thus q -projective equivalence is determined by the underlying quaternionic geometry. Denote the Levi-Civita connections of q -projectively equivalent quaternion-Kähler metrics g, \hat{g} by $\nabla, \hat{\nabla}$. Then $\hat{\nabla} = \nabla + \llbracket \cdot, \alpha \rrbracket^q$ for some $\alpha \in \Omega^1(M)$, and taking a trace in (6.4) yields

$$\alpha = \frac{1}{4n+4} d \left(\log \frac{\det \hat{g}}{\det g} \right),$$

so that α is an exact 1-form as in (4.3) and (5.6). We consider the endomorphism

$$A(g, \hat{g}) := \left(\frac{\det \hat{g}}{\det g} \right)^{1/(4n+4)} \hat{\sharp} \circ \flat \tag{6.5}$$

analogous to (4.4) and (5.7). When g, \hat{g} are clear from the context, we will write $A := A(g, \hat{g})$. Evidently $A(g, \hat{g})$ is invertible with inverse $A(\hat{g}, g)$, and is self-adjoint with respect to both g and \hat{g} ; moreover since g, \hat{g} are \mathbb{Q} -hermitian, A is quaternion-linear. The second quaternion-Kähler metric \hat{g} may be recovered from (g, A) as

$$\hat{g} = (\det A)^{1/4} g(A^{-1} \cdot, \cdot). \tag{6.6}$$

Calculating as in Propositions 4.4 and 5.4, we find that A satisfies the anticipated first-order linear differential equation.

Proposition 6.8. *Let g, \hat{g} be quaternion-Kähler metrics with Levi-Civita connections $\nabla, \hat{\nabla}$ respectively. Then g, \hat{g} are q -projectively equivalent if and only if $A := A(g, \hat{g})$ defined by (6.5) satisfies the first-order linear differential equation*

$$g((\nabla_X A) \cdot, \cdot) = X^\flat \odot \mu + \sum_{a=1}^3 J_a X^\flat \odot J_a \mu \tag{6.7}$$

for some $\mu \in \Omega^1(M)$ and all $X \in \Omega^0(M; TM)$. In this case $\hat{\nabla} = \nabla + \llbracket \cdot, \alpha \rrbracket^q$, where $\alpha \in \Omega^1(M)$ satisfies $\mu = -\alpha(A \cdot) = \frac{1}{4} d(\text{tr } A)$. \square

6.2 Description as a parabolic geometry

Quaternionic projective space $\mathbb{H}\mathbb{P}^n$ is defined as the set of quaternionic lines through the origin in \mathbb{H}^{n+1} , or equivalently as the base of the quaternionic Hopf fibration of the $(4n+3)$ -sphere \mathbb{S}^{4n+3} by its natural \mathbb{S}^3 -action [152]; other characterisations are provided in [7, 131]. The standard Q-hermitian metric on \mathbb{H}^{n+1} descends to a quaternion-Kähler metric g_{FS} on $\mathbb{H}\mathbb{P}^n$, called the *Fubini–Study* metric. The embedded quaternionic projective lines $\mathbb{H}\mathbb{P}^1 \hookrightarrow \mathbb{H}\mathbb{P}^n$ are the q-geodesics with respect to the class of quaternionic connections determined by the Levi-Civita ∇^{FS} of g_{FS} , so are totally geodesic by a result of Gray [89, 90]. With respect to an affine chart $\mathbb{H}^n \hookrightarrow \mathbb{H}\mathbb{P}^n$ these q-geodesics lie within a quaternionic line in \mathbb{H}^n , so that from the point of view of q-geodesics $\mathbb{H}\mathbb{P}^n$ appears as the natural compactification of $\mathbb{H}\mathbb{P}^n$. Therefore $\mathbb{H}\mathbb{P}^n$ is a good candidate for the flat model of almost quaternionic geometry; indeed, Salamon defines [162] an almost quaternionic manifold as one locally modelled on $\mathbb{H}\mathbb{P}^n$.

As we shall explain in Subsection 6.2.1, the complexification of the flat model $\mathbb{H}\mathbb{P}^n$ may be viewed as the grassmannian of complex 2-planes. A careful treatment of parabolic geometries modelled on grassmannians may be found in [17, 88]; see also [96]. The first of these references is particularly amenable to our discussion of representations in Subsection 6.2.2. Throughout this section we shall assume that $n > 1$, so that we consider almost quaternionic manifolds (M, \mathcal{Q}) of dimension $4n \geq 8$.

6.2.1 The flat model $\mathbb{H}\mathbb{P}^n$

Recalling Salamon’s description [162], quaternionic projective space is a good candidate for the flat model of almost quaternionic geometry. As a generalised flag manifold $\mathbb{H}\mathbb{P}^n$ may be identified with G/P for the real Lie groups²

$$G := \text{PGL}(n+1, \mathbb{H}) := \text{GL}(n+1, \mathbb{H})/\langle \text{id} \rangle,$$

and $P \leq G$ the (projection to G of) the $\text{GL}(n+1, \mathbb{H})$ -stabiliser of a given quaternionic line $\langle v_0 \rangle_{\mathbb{H}}$ in \mathbb{H}^{n+1} .

The Lie algebra of G is the real form $\mathfrak{g} := \mathfrak{sl}(n+1, \mathbb{H})$ of $\mathfrak{sl}(2n+2, \mathbb{C})$, which consists of all $(n+1) \times (n+1)$ quaternionic matrices with vanishing real trace. To understand the parabolic subalgebra $\mathfrak{p} \leq \mathfrak{g}$, we identify \mathbb{H}^{n+1} with \mathbb{C}^{2n+2} together with a conjugate-linear map $\mathbf{j} : \mathbb{C}^{2n+2} \rightarrow \mathbb{C}^{2n+2}$ which satisfies $\mathbf{j}^2 = -\text{id}$ and anti-commutes with multiplication by $\mathbf{i} \in \mathbb{C}$. In this picture the quaternionic line $\langle v \rangle_{\mathbb{H}} \leq \mathbb{H}^{n+1}$ is identified with the complex 2-plane $\langle v, \mathbf{j}v \rangle_{\mathbb{C}}$, which may in turn be identified with the

²Non-commutativity of \mathbb{H} means that the centre of $\text{GL}(n+1, \mathbb{H})$ consists of all *real* multiples of the identity matrix.

span of the 2-vector $v \wedge \mathbf{j}v \in \wedge_{\mathbb{C}}^2 \mathbb{C}^{2n+2}$. It follows that the Satake diagram of \mathfrak{p} is given by crossing the penultimate node:

$$\mathfrak{p} = \bullet \text{---} \circ \text{---} \cdots \text{---} \bullet \times \bullet \leq \bullet \text{---} \circ \text{---} \cdots \text{---} \bullet \text{---} \circ \text{---} \bullet = \mathfrak{g}. \quad (6.8)$$

Therefore almost quaternionic geometry is an abelian parabolic geometry, with Killing polar $\mathfrak{p}^\perp \cong \mathbb{H}^{n*} := \text{Hom}_{\mathbb{R}}(\mathbb{H}^n, \mathbb{R})$ and reductive Levi factor $\mathfrak{p}^0 := \mathfrak{p}/\mathfrak{p}^\perp$. An algebraic Weyl structure for the \mathfrak{p}^\perp -filtration $\mathfrak{g} \supset \mathfrak{p} \supset \mathfrak{p}^\perp \supset 0$ of \mathfrak{g} is evidently equivalent to a choice of quaternionic subspace of \mathbb{H}^{n+1} complementary to $\langle v_0 \rangle_{\mathbb{H}}$, thus yielding a decomposition

$$\mathfrak{sl}(n+1, \mathbb{H}) = \left\{ \begin{pmatrix} q & \alpha \\ X & A \end{pmatrix} \left| \begin{array}{l} X \in \mathbb{H}^n, \alpha \in \mathbb{H}^{n*}, A \in \mathfrak{gl}(n, \mathbb{H}), \\ q \in \mathbb{H} \text{ s.t. } \text{Re}[q] = -\text{tr } A \end{array} \right. \right\}. \quad (6.9)$$

In the induced decomposition of $\text{PGL}(n+1, \mathbb{H})$, the Levi subgroup $P^0 := P/\exp \mathfrak{p}^\perp$ consists of (equivalence classes of) block-diagonal matrices in G ; clearly the adjoint action of P^0 on $\mathfrak{g}/\mathfrak{p} \cong \mathbb{H}^n$ induces an isomorphism $\mathfrak{p}^0 \cong \mathfrak{gl}(n, \mathbb{H}) \oplus \mathfrak{sp}(1)$. Then $\mathfrak{p}^\perp \cong \mathbb{H}^{n*}$ consists of matrices with only the α -block, \mathfrak{p}^0 of block-diagonal matrices, and $\mathfrak{p} \cong (\mathfrak{gl}(n, \mathbb{H}) \oplus \mathfrak{sp}(1)) \ltimes \mathbb{H}^{n*}$ of block upper-triangular matrices. There is a corresponding decomposition on the group level.

Choose an algebraic Weyl structure, so that $\mathfrak{g} \cong \mathbb{H}^n \oplus (\mathfrak{gl}(n, \mathbb{H}) \oplus \mathfrak{sp}(1)) \oplus \mathbb{H}^{n*}$. The decomposition (6.9) allows us to calculate the Lie bracket between elements in the three summands: if $X, Y \in \mathbb{H}^n$, $A, B \in \mathfrak{gl}(n, \mathbb{H}) \oplus \mathfrak{sp}(1)$ and $\alpha, \beta \in \mathbb{H}^{n*}$ then

$$\begin{aligned} [X, Y] &= 0 = [\alpha, \beta], & [A, B] &= AB - BA, \\ [A, X] &= AX & \text{and} & [A, \alpha] = -\alpha \circ A, \end{aligned}$$

so that $\mathbb{H}^n, \mathbb{H}^{n*}$ form abelian subalgebras on which \mathfrak{p}^0 acts naturally. The bracket $\mathbb{H}^n \times \mathbb{H}^{n*} \rightarrow \mathfrak{p}^0$ may be computed by adapting Hrinda's calculation in c-projective geometry [102]; this calculation is surely known in the literature, but the author could not find a reference.

Lemma 6.9. *The Lie bracket $[[X, \alpha], Y]$ between $X, Y \in \mathbb{H}^n$ and $\alpha \in \mathbb{H}^{n*}$ satisfies*

$$[[X, \alpha], Y] = \alpha(X)Y + \alpha(Y)X - \sum_{a=1}^3 [\alpha(J_a X)J_a Y + \alpha(J_a Y)J_a X],$$

where $\{J_a\}_{a=1}^3$ is a quaternionic structure on \mathbb{H}^n .

Proof. We must first identify $\mathfrak{g} = \mathfrak{sl}(n+1, \mathbb{H})$ with a subalgebra of $\mathfrak{gl}(4n+4, \mathbb{R})$ as follows. Given $A = (a_{ij}) \in \mathfrak{g}$, write $\mathbb{H} \ni a_{ij} = a_{ij}^0 \mathbf{1} + a_{ij}^1 \mathbf{i}_1 + a_{ij}^2 \mathbf{i}_2 + a_{ij}^3 \mathbf{i}_3$ for $a_{ij}^k \in \mathbb{R}$. Then A may be identified with the $(4n \times 4n)$ -matrix given by replacing each entry $a_{ij} \in \mathbb{H}$

with the (4×4) block

$$\begin{pmatrix} a_{ij}^0 & a_{ij}^1 & a_{ij}^2 & a_{ij}^3 \\ -a_{ij}^1 & a_{ij}^0 & -a_{ij}^3 & a_{ij}^2 \\ -a_{ij}^2 & a_{ij}^3 & a_{ij}^0 & -a_{ij}^1 \\ -a_{ij}^3 & -a_{ij}^2 & a_{ij}^1 & a_{ij}^0 \end{pmatrix}.$$

In particular, the action of the real unit $\mathbf{1}$ is given by the $(4n \times 4n)$ identity matrix I , while the quaternionic units $\{\mathbf{i}_a\}_{a=1}^3$ act via the real endomorphisms $\{J_a\}_{a=1}^3$ given by a direct sum of n copies of the (4×4) blocks

$$J_1 = \begin{pmatrix} 0 & 1 & 0 & 0 \\ -1 & 0 & 0 & 0 \\ 0 & 0 & 0 & -1 \\ 0 & 0 & 1 & 0 \end{pmatrix}, \quad J_2 = \begin{pmatrix} 0 & 0 & 1 & 0 \\ 0 & 0 & 0 & 1 \\ -1 & 0 & 0 & 0 \\ 0 & -1 & 0 & 0 \end{pmatrix} \quad \text{and} \quad J_3 = \begin{pmatrix} 0 & 0 & 0 & 1 \\ 0 & 0 & -1 & 0 \\ 0 & 1 & 0 & 0 \\ -1 & 0 & 0 & 0 \end{pmatrix}. \quad (6.10)$$

Choose $X, Y \in \mathbb{H}^n$ and $\alpha \in \mathbb{H}^{n*}$, and write $X_i, Y_i \in \mathbb{H}$ and $\alpha_i \in \mathbb{H}^*$ for their components. Using the decomposition (6.9), the bracket $[[X, \alpha], Y]$ is given by

$$\begin{aligned} [[X, \alpha], Y] &= \left[\left[\begin{pmatrix} 0 & 0 & \cdots & 0 \\ X_1 & 0 & \cdots & 0 \\ \vdots & \vdots & \ddots & \vdots \\ X_n & 0 & \cdots & 0 \end{pmatrix}, \begin{pmatrix} 0 & \alpha_1 & \cdots & \alpha_n \\ 0 & 0 & \cdots & 0 \\ \vdots & \vdots & \ddots & \vdots \\ 0 & 0 & \cdots & 0 \end{pmatrix} \right], \begin{pmatrix} 0 & 0 & \cdots & 0 \\ Y_1 & 0 & \cdots & 0 \\ \vdots & \vdots & \ddots & \vdots \\ Y_n & 0 & \cdots & 0 \end{pmatrix} \right] \\ &= \begin{pmatrix} 0 & \cdots & 0 \\ \alpha_1 X_1 + \cdots + \alpha_n X_n Y_1 & 0 & \cdots & 0 \\ \vdots & \vdots & \ddots & \vdots \\ \alpha_1 X_1 + \cdots + \alpha_n X_n Y_n & \alpha_1 Y_1 + \cdots + \alpha_n Y_n X_n & 0 & \cdots & 0 \end{pmatrix}. \end{aligned} \quad (6.11)$$

Identifying $\alpha \in \mathbb{H}^*$ and $X_i \in \mathbb{H}$ with the (4×4) -matrices

$$\alpha_i = \begin{pmatrix} \alpha_i^0 & \alpha_i^1 & \alpha_i^2 & \alpha_i^3 \\ -\alpha_i^1 & \alpha_i^0 & -\alpha_i^3 & \alpha_i^2 \\ -\alpha_i^2 & \alpha_i^3 & \alpha_i^0 & -\alpha_i^1 \\ -\alpha_i^3 & -\alpha_i^2 & \alpha_i^1 & \alpha_i^0 \end{pmatrix} \quad \text{and} \quad X_i = \begin{pmatrix} X_i^0 & X_i^1 & X_i^2 & X_i^3 \\ -X_i^1 & X_i^0 & -X_i^3 & X_i^2 \\ -X_i^2 & X_i^3 & X_i^0 & -X_i^1 \\ -X_i^3 & -X_i^2 & X_i^1 & X_i^0 \end{pmatrix}$$

as above, multiplying out the matrices in one of the constant factors $\alpha_i X_i \in \mathbb{H}$ shows that the factor $(\alpha_1 X_1 + \cdots + \alpha_n X_n)$ is given by summing over terms of the form

$$\begin{aligned} \alpha_i X_i &= (\alpha_i^0 X_i^0 - \alpha_i^1 X_i^1 - \alpha_i^2 X_i^2 - \alpha_i^3 X_i^3)I \\ &\quad + (\alpha_i^0 X_i^1 + \alpha_i^1 X_i^0 + \alpha_i^2 X_i^3 - \alpha_i^3 X_i^2)J_1 \\ &\quad + (\alpha_i^0 X_i^2 - \alpha_i^1 X_i^3 + \alpha_i^2 X_i^0 + \alpha_i^3 X_i^1)J_2 \\ &\quad + (\alpha_i^0 X_i^3 + \alpha_i^1 X_i^2 - \alpha_i^2 X_i^1 + \alpha_i^3 X_i^0)J_3, \end{aligned} \quad (6.12)$$

where we identify I with the (4×4) identity matrix and $\{J_a\}_{a=1}^3$ with the matrices from (6.10). Equating the entries on the leading diagonal with the real part, we note that

$$\begin{aligned} &\alpha_i^0 X_i^1 + \alpha_i^1 X_i^0 + \alpha_i^2 X_i^3 - \alpha_i^3 X_i^2 \\ &= -\text{Re} \left[\begin{pmatrix} \alpha_i^0 & \alpha_i^1 & \alpha_i^2 & \alpha_i^3 \\ -\alpha_i^1 & \alpha_i^0 & -\alpha_i^3 & \alpha_i^2 \\ -\alpha_i^2 & \alpha_i^3 & \alpha_i^0 & -\alpha_i^1 \\ -\alpha_i^3 & -\alpha_i^2 & \alpha_i^1 & \alpha_i^0 \end{pmatrix} \begin{pmatrix} 0 & 1 & 0 & 0 \\ -1 & 0 & 0 & 0 \\ 0 & 0 & 0 & -1 \\ 0 & 0 & 1 & 0 \end{pmatrix} \begin{pmatrix} X_i^0 & X_i^1 & X_i^2 & X_i^3 \\ -X_i^1 & X_i^0 & -X_i^3 & X_i^2 \\ -X_i^2 & X_i^3 & X_i^0 & -X_i^1 \\ -X_i^3 & -X_i^2 & X_i^1 & X_i^0 \end{pmatrix} \right] \\ &= -\text{Re}[\alpha_i J_1 X_i] \end{aligned}$$

and similarly for the other terms in (6.12). Therefore

$$\alpha_i X_i = \operatorname{Re}[(\alpha_i X_i)I - (\alpha_i J_1 X_i)J_1 - (\alpha_i J_2 X_i)J_2 - (\alpha_i J_3 X_i)J_3];$$

upon recalling that $\alpha(X) \in \mathbb{R}$ by the definition $\mathbb{H}^{n*} := \operatorname{Hom}(\mathbb{H}^n, \mathbb{R})$, this yields

$$(\alpha_1 X_1 + \cdots + \alpha_n X_n)Y_i = \alpha(X)Y_i - \alpha(J_1 X)J_1 Y_i - \alpha(J_2 X)J_2 Y_i - \alpha(J_3 X)J_3 Y_i$$

for all $i = 1, \dots, n$. The desired formula now follows from (6.11). \square

In particular Lemma 6.9 implies that, up to normalisation conventions, change of Weyl structure corresponds precisely to change of connection in the quaternionic class.

Note that $\mathbb{H}\mathbb{P}^n$ has a projective embedding defined as follows. As above we view \mathbb{H}^{n+1} as \mathbb{C}^{2n+2} with a conjugate-linear map \mathbf{j} , so that $\mathbb{H}\mathbb{P}^n$ is identified with the set of \mathbf{j} -invariant 2-planes in \mathbb{C}^{2n+2} , *i.e.* with the subspace

$$\mathbb{H}\mathbb{P}^n = \{ W \in \operatorname{Gr}_2(\mathbb{C}^{2n+2}) \mid \mathbf{j}W = W \}$$

of the grassmannian $\operatorname{Gr}_2(\mathbb{C}^{2n+2})$. Note that since $\mathbf{j}^2 = -\operatorname{id}$, the even wedge powers $\wedge_{\mathbb{C}}^{2k} \mathbb{C}^{2n+2}$ admit real structures given by $\wedge^{2k} \mathbf{j} : \wedge_{\mathbb{C}}^{2k} \mathbb{C}^{2n+2} \rightarrow \wedge_{\mathbb{C}}^{2k} \mathbb{C}^{2n+2}$, so we may form the underlying real representations $(\wedge_{\mathbb{C}}^{2k} \mathbb{C}^{2n+2})_{\mathbb{R}}$. Identifying $[v] \in \mathbb{H}\mathbb{P}^n$ with the 2-plane $\langle v, \mathbf{j}v \rangle_{\mathbb{C}}$, the map $[v] \mapsto [v \wedge \mathbf{j}v]$ defines a projective embedding $\mathbb{H}\mathbb{P}^n \hookrightarrow \mathbb{P}(\wedge_{\mathbb{C}}^2 \mathbb{C}^{2n+2})$. Since $(\wedge^2 \mathbf{j})(v \wedge \mathbf{j}v) = -\mathbf{j}v \wedge v = v \wedge \mathbf{j}v$, this embedding takes values in the underlying real representation $\mathbb{W} := (\wedge_{\mathbb{C}}^2 \mathbb{C}^{2n+2})_{\mathbb{R}}$, thus yielding an embedding $\mathbb{H}\mathbb{P}^n \hookrightarrow \mathbb{P}(\mathbb{W})$ which generalises the Plücker embedding.

A dimension count shows that $\mathbb{H}\mathbb{P}^n$ has non-zero codimension in $\mathbb{P}(\mathbb{W})$. Indeed, Kostant's Theorem 2.25 tells us that $\mathbb{H}\mathbb{P}^n$ is the intersection of quadrics in $\mathbb{P}(\mathbb{W})$ with defining equations given by projecting away from the Cartan square in $\mathbb{S}^2 \mathbb{W}$. Explicitly,

$$\mathbb{S}^2 \mathbb{W}^* = \mathbb{S}^2 \left(\begin{array}{ccccccc} 0 & 0 & \cdots & 0 & 1 & 0 \\ \bullet & \circ & \cdots & \bullet & \circ & \bullet \end{array} \right) \cong \begin{array}{ccccccc} 0 & 0 & \cdots & 0 & 2 & 0 \\ \bullet & \circ & \cdots & \bullet & \circ & \bullet \end{array} \oplus \begin{array}{ccccccc} 0 & 0 & \cdots & 0 & 1 & 0 & 0 & 0 \\ \bullet & \circ & \cdots & \bullet & \circ & \bullet & \circ & \bullet \end{array},$$

$\otimes^2 \mathbb{W}^* \qquad \qquad \qquad (\wedge_{\mathbb{C}}^4 \mathbb{C}^{2n+2*})_{\mathbb{R}}$

so that $\mathbb{U}^* := (\wedge_{\mathbb{C}}^4 \mathbb{C}^{2n+2*})_{\mathbb{R}}$ is the space of homogeneous quadratic polynomials which cuts out $\mathbb{H}\mathbb{P}^n$ as an intersection of quadrics. As in the real and complex cases, \mathbb{U}^* is an irreducible \mathfrak{g} -representation.

Finally, since $\mathfrak{g} = \mathfrak{sl}(n+1, \mathbb{H})$ is not one of the problematic Lie algebras for the equivalence of categories provided by Theorem 3.27, the following is immediate.

Theorem 6.10. *On any manifold M of dimension $4n \geq 8$, there is an equivalence of categories between almost quaternionic structures and regular normal parabolic geometries of type $\mathbb{H}\mathbb{P}^n$. The flat model is $\mathbb{H}\mathbb{P}^n$ with its canonical quaternionic structure determined by the Fubini–Study metric g_{FS} . \square*

Normality implies that T is the intrinsic torsion of the almost quaternionic structure generated by the Weyl connections, which we describe more carefully in Subsection 6.2.3. In dimension four we obtain a similar equivalence of categories between regular normal parabolic geometries of type $\mathbb{H}\mathbb{P}^1 \cong \mathbb{S}^4$ and self-dual conformal structures.

6.2.2 Representations of $\mathfrak{sl}(n+1, \mathbb{H})$

In order to describe \mathfrak{g} - and \mathfrak{p} -representations, it will be convenient to consider the complexification $\mathfrak{g}_{\mathbb{C}} := \mathfrak{sl}(2n+2, \mathbb{C})$ of \mathfrak{g} . Then completely reducible $\mathfrak{p}_{\mathbb{C}}$ -representations are trivial extensions of representations of the complexified reductive Levi factor $\mathfrak{p}_{\mathbb{C}}^0 \cong \mathfrak{gl}(2n, \mathbb{C}) \oplus \mathfrak{sl}(2, \mathbb{C})$, so are external tensor products of representations of the two factors.

The fundamental representations of $\mathfrak{g}_{\mathbb{C}}$ are the exterior powers of \mathbb{C}^{2n+2} . Identifying \mathbb{H}^{n+1} with \mathbb{C}^{2n+2} as above, the odd exterior and symmetric powers of \mathbb{C}^{2n+2} evidently admit quaternionic structures, while the even powers admit real structures. Thus if a $\mathfrak{g}_{\mathbb{C}}$ -representation has even coefficients over the odd nodes of the Dynkin diagram, it is the complexification of a \mathfrak{g} -representation.

Let us now describe some important \mathfrak{g} - and \mathfrak{p} -representations, as well as their associated bundles. The complexified isotropy representation $(\mathfrak{g}/\mathfrak{p})_{\mathbb{C}}$ and its dual $(\mathfrak{g}/\mathfrak{p})_{\mathbb{C}}^* \cong \mathfrak{p}_{\mathbb{C}}^{\perp}$ decompose as external tensor products according to³

$$\begin{aligned} (\mathfrak{g}/\mathfrak{p})_{\mathbb{C}} &= \begin{array}{ccccccc} 1 & 0 & \dots & 0 & 0 & 0 & 1 \\ \circ & -\circ & \dots & -\circ & -\circ & -\circ & \times-\circ \end{array} = E \boxtimes H \\ \text{and } \mathfrak{p}_{\mathbb{C}}^{\perp} &= \begin{array}{ccccccc} 0 & 0 & \dots & 0 & 1 & -2 & 1 \\ \circ & -\circ & \dots & -\circ & -\circ & -\circ & \times-\circ \end{array} = E^* \boxtimes H^*, \end{aligned}$$

where

$$\begin{aligned} E &:= \begin{array}{ccccccc} 1 & 0 & \dots & 0 & 0 & 0 & 0 \\ \circ & -\circ & \dots & -\circ & -\circ & -\circ & \times-\circ \end{array}, & H &:= \begin{array}{ccccccc} 0 & 0 & \dots & 0 & 0 & 0 & 1 \\ \circ & -\circ & \dots & -\circ & -\circ & -\circ & \times-\circ \end{array} \\ \text{and } E^* &= \begin{array}{ccccccc} 0 & 0 & \dots & 0 & 1 & -1 & 0 \\ \circ & -\circ & \dots & -\circ & -\circ & -\circ & \times-\circ \end{array}, & H^* &= \begin{array}{ccccccc} 0 & 0 & \dots & 0 & 0 & -1 & 1 \\ \circ & -\circ & \dots & -\circ & -\circ & -\circ & \times-\circ \end{array} \end{aligned} \quad (6.13)$$

are the natural representations of $\mathfrak{gl}(n, \mathbb{H})_{\mathbb{C}} = \mathfrak{gl}(2n, \mathbb{C})$ on $E := \mathbb{C}^{2n} \cong \mathbb{H}^n$ and of $\mathfrak{sp}(1)_{\mathbb{C}} = \mathfrak{sl}(2, \mathbb{C})$ on $H := \mathbb{C}^2 \cong \mathbb{H}$,⁴ each of which carry a quaternionic structure. By the Cartan condition, the complexified tangent and cotangent bundles decompose as external tensor products $CTM \cong \mathcal{E} \boxtimes \mathcal{H}$ and $CT^*M \cong \mathcal{E}^* \boxtimes \mathcal{H}^*$, where \mathcal{E}, \mathcal{H} are the bundles associated to E, H .⁵ Note that \mathcal{E}, \mathcal{H} need not be defined globally, for reasons discussed below. Decompositions of $\wedge_{\mathbb{C}}^k CTM$, $S_{\mathbb{C}}^k CTM$ and their duals may

³Note that we denote representations of the complexifications $\mathfrak{g}_{\mathbb{C}}, \mathfrak{p}_{\mathbb{C}}$ on their respective Dynkin diagrams, rather than on the Satake diagrams (6.8) of $\mathfrak{g}, \mathfrak{p}$.

⁴The non-commutativity of the quaternions makes it necessary to view E as a *left* $\mathfrak{gl}(2n, \mathbb{C})$ -module, whereas we view H as a *right* $\mathfrak{sl}(2, \mathbb{C})$ -module.

⁵Thus almost quaternionic geometry is an *almost grassmannian geometry*; see [88] and [60, §4.1.3].

then be given by representation-theoretic means, for example using Schur functors [84]; decompositions for small values of k may be obtained by more direct methods. The case $k = 2$ shall be important for us in the sequel, for which

$$\begin{aligned} \wedge_{\mathbb{C}}^2(E \boxtimes H) &\cong \begin{array}{c} 0 \quad 1 \quad 0 \quad \dots \quad 0 \quad 0 \quad 0 \quad 2 \\ \circ - \circ - \circ - \dots - \circ - \circ - \times - \circ \\ \wedge_{\mathbb{C}}^2 E \boxtimes S_{\mathbb{C}}^2 H \end{array} \oplus \begin{array}{c} 2 \quad 0 \quad 0 \quad \dots \quad 0 \quad 0 \quad 1 \quad 0 \\ \circ - \circ - \circ - \dots - \circ - \circ - \times - \circ \\ S_{\mathbb{C}}^2 E \boxtimes \wedge_{\mathbb{C}}^2 H \end{array} \\ \text{and } S_{\mathbb{C}}^2(E \boxtimes H) &\cong \begin{array}{c} 0 \quad 1 \quad 0 \quad \dots \quad 0 \quad 0 \quad 1 \quad 0 \\ \circ - \circ - \circ - \dots - \circ - \circ - \times - \circ \\ \wedge_{\mathbb{C}}^2 E \boxtimes \wedge_{\mathbb{C}}^2 H \end{array} \oplus \begin{array}{c} 2 \quad 0 \quad 0 \quad \dots \quad 0 \quad 0 \quad 0 \quad 2 \\ \circ - \circ - \circ - \dots - \circ - \circ - \times - \circ \\ S_{\mathbb{C}}^2 E \boxtimes S_{\mathbb{C}}^2 H \end{array}. \end{aligned} \quad (6.14)$$

Each summand in (6.14) admits a real structure, so is the complexification of an underlying real representation. In particular $\mathfrak{sl}(2, \mathbb{C})$ acts trivially on $\wedge_{\mathbb{C}}^2 E \boxtimes \wedge_{\mathbb{C}}^2 H$, so its associated bundle may be identified with the subbundle $S_+^2 TM$ of \mathbb{Q} -invariant bilinear forms on T^*M . The complementary subbundle is associated to $(S_{\mathbb{C}}^2 E \boxtimes S_{\mathbb{C}}^2 H)_{\mathbb{R}}$ and shall be denoted by $S_-^2 TM$, although note that $S_-^2 TM$ does *not* consist of \mathbb{Q} -anti-invariant bilinear forms. Salamon [163, Prop. 9.2] provides similar decompositions of the bundles of 3- and 4-forms, while Swann [167, 168] refines these decompositions and gives a decomposition for the bundle of 5-forms; summaries may also be found in [147, 164].

The line bundle $\mathcal{L} := (\wedge^{4n} TM)^{1/(2n+2)}$ from Lemma 6.4 is associated to the $(2n+2)$ nd root L of $\wedge^{4n}(\mathfrak{g}/\mathfrak{p})$, which has highest weight

$$L := \begin{array}{c} 0 \quad 0 \quad \dots \quad 0 \quad 0 \quad 1 \quad 0 \\ \bullet - \circ - \dots - \circ - \bullet - \times - \bullet \end{array}. \quad (6.15)$$

Since E, H have complex dimension $2n, 2$ respectively, both $\wedge_{\mathbb{C}}^2 H$ and $\wedge_{\mathbb{C}}^{2n} E$ are complex line bundles isomorphic to the complexification of L ; *cf.* the spinor bundles from [17, 88]. As in real projective and \mathbb{C} -projective cases, L is the zeroth homology $H_0(\mathfrak{p}^{\perp}; \mathbb{W}^*)$, where $\mathbb{W} = (\wedge_{\mathbb{C}}^2 \mathbb{C}^{2n+2})_{\mathbb{R}}$ is the \mathfrak{g} -representation from Subsection 6.2.1 admitting a projective embedding $\mathbb{H}\mathbb{P}^n \hookrightarrow \mathbb{P}(\mathbb{W})$.

Following the discussion of Subsection 6.1.2, the bundle \mathcal{Q} of almost complex structures is pointwise isomorphic to $\mathfrak{sp}(1)$ and has a natural action of $\mathrm{SO}(3)$. Extending the adjoint action of $\mathfrak{so}(3) \cong \mathfrak{sp}(1) \cong (S_{\mathbb{C}}^2 H)_{\mathbb{R}}$ trivially to $\mathfrak{p}^0 \cong \mathfrak{gl}(n, \mathbb{H}) \oplus \mathfrak{sp}(1)$, we may view \mathcal{Q} as the bundle associated to the adjoint representation

$$Q = \begin{array}{c} 0 \quad 0 \quad \dots \quad 0 \quad 0 \quad 0 \quad 2 \\ \bullet - \circ - \dots - \circ - \bullet - \times - \bullet \end{array} = (S_{\mathbb{C}}^2 H)_{\mathbb{R}}$$

of the simple factor $\mathfrak{sp}(1)$.

As before, our choice of group $G = \mathrm{PGL}(n+1, \mathbb{H})$ with Lie algebra $\mathfrak{g} = \mathfrak{sl}(n+1, \mathbb{H})$ means that not all \mathfrak{g} -representations integrate to global G -representations, which causes problems for forming some tractor bundles. Since the centre of $\mathrm{GL}(n+1, \mathbb{H})$ consists of

all real multiples of the identity, the topology of $\mathrm{PGL}(n+1, \mathbb{H})$ is much like the topology of $\mathrm{PGL}(n+1, \mathbb{R})$ discussed in Subsection 4.2.3. Thus an irreducible \mathfrak{g} -representation with highest weight λ integrates to G if and only if the central \mathbb{Z}_2 of $\tilde{G} := \mathrm{SL}(n+1, \mathbb{H})$ acts trivially, which is the case if and only if the coefficient sum of λ is even [84]. We then form the extended Cartan bundle $F^{\tilde{P}} := F^P \times_P \tilde{P}$, where $\tilde{P} \leq \tilde{G}$ is the parabolic stabiliser of a given quaternionic line in \mathbb{H}^{n+1} (previously denoted $\langle v_0 \rangle_{\mathbb{H}}$), form tractor bundles with respect to $F^{\tilde{P}}$, and take the local quotient by \mathbb{Z}_2 if necessary.

Obvious examples of representations which do not integrate to G are E, H defined by (6.13), as well as the standard representation of \mathfrak{g} on

$$\mathbb{T} := \begin{array}{ccccccc} & 1 & 0 & & 0 & 0 & 0 \\ & \circ - \circ & \cdots & \circ - \circ & \circ - \circ & \circ & \\ & & & & & & \end{array} = \mathbb{H}^{n+1}.$$

It follows from the decomposition (6.9) that an element $\begin{bmatrix} q & \alpha \\ 0 & A \end{bmatrix} \in \tilde{P}$ acts on the quaternionic line $\mathbb{T}_0 := \langle v_0 \rangle_{\mathbb{H}} \leq \mathbb{T}$ by multiplication with q . Therefore

$$\mathbb{T}_0 = \begin{array}{ccccccc} & 0 & 0 & & 0 & -1 & 1 \\ & \circ - \circ & \cdots & \circ - \circ & \times - \circ & \circ & \\ & & & & & & \end{array} = H^* \quad \text{and} \quad \mathbb{T}/\mathbb{T}_0 = \begin{array}{ccccccc} & 1 & 0 & & 0 & 0 & 0 \\ & \circ - \circ & \cdots & \circ - \circ & \times - \circ & \circ & \\ & & & & & & \end{array} = E$$

as \tilde{P} -representations, which we identify with the socle and top of the \mathfrak{p}^\perp -filtration $\mathbb{T} \supset \mathbb{T}_0 \supset 0$. Thus $\mathbb{T} \cong E \oplus H^*$ with respect to an algebraic Weyl structure; the associated bundle \mathcal{T} is called the *standard tractor bundle* of quaternionic geometry.

In terms of structure groups, the extended bundle $F^{\tilde{P}}$ is equivalent to the double cover of the quaternionic frame bundle F^0 with structure group P^0 , giving a bundle \tilde{F}^0 with structure group $\tilde{P}^0 := \mathrm{GL}(n, \mathbb{H}) \times \mathrm{Sp}(1)$. In fact, all \mathfrak{g} -representations integrate to G provided that a certain cohomology class vanishes [132, 162, 167, 169]. In particular this class vanishes when $n+1$ is odd, since then $G = \tilde{G}$, which is the origin of Salamon's result stating that a quaternion-Kähler manifold of dimension $8n$ is spin [161].

6.2.3 Harmonic curvature

We turn now to computing the harmonic curvature of the canonical Cartan connection, which lies in the second Lie algebra homology $H_2(\mathfrak{p}^\perp; \mathfrak{g})$. The Hasse diagram computing this homology is given in Figure 6.1, from which we see that the harmonic curvature has two components, one for each summand in the third column. From top to bottom the complexifications of these \mathfrak{p} -representations are

$$\begin{aligned} & (\wedge_{\mathbb{C}}^2 E^* \otimes \wedge_{\mathbb{C}}^2 H^*) \otimes_{\mathbb{C}} (E \otimes H) \otimes_{\mathbb{C}} S_{\mathbb{C}}^2 H \\ \text{and} \quad & (S_{\mathbb{C}}^2 E^* \otimes \wedge_{\mathbb{C}}^2 H^*) \otimes_{\mathbb{C}} (E \otimes_{\mathbb{C}} E^*), \end{aligned} \tag{6.16}$$

whose underlying real representations have associated bundles $S_+^2 T^* M \otimes TM \otimes \mathcal{Q}$ and $\wedge_+^2 T^* M \otimes (\mathcal{E} \otimes_{\mathbb{C}} \mathcal{E}^*)_{\mathbb{R}}$.

The component in $S_+^2 T^*M \otimes TM \otimes \mathcal{Q}$ coincides with the intrinsic torsion T of any Weyl connection. To see this, observe that there is a natural map $S_+^2 T^*M \otimes \mathcal{Q} \hookrightarrow \wedge^2 T^*M$ defined by $g \otimes J \mapsto g(J \cdot, \cdot)$, which is clearly injective. Moreover for each $J \in \Omega^0(M; \mathcal{Q})$ there is a unique $J' \in \Omega^0(M; \mathcal{Q})$ such that $\{J, J', J \circ J'\}$ is a local quaternionic frame of \mathcal{Q} . With respect to this frame it is easy to check that $g(J \cdot, \cdot)$ is J -anti-invariant, so that this map takes values in the irreducible summand $\wedge_-^2 T^*M$. A dimension count then implies that $S_+^2 T^*M \otimes \mathcal{Q} \cong \wedge_-^2 T^*M$, so that T may be identified with a section of $\wedge_-^2 T^*M \otimes TM$. Čap and Slovák prove [60, Prop. 4.1.8] that T takes values in the irreducible subbundle given by the intersection of the kernels of the natural contractions $S_+^2 T^*M \otimes TM \otimes \mathcal{Q} \rightarrow T^*M \otimes \mathcal{Q}$ and $S_+^2 T^*M \otimes TM \otimes \mathcal{Q} \rightarrow S_+^2 T^*M \otimes TM$.

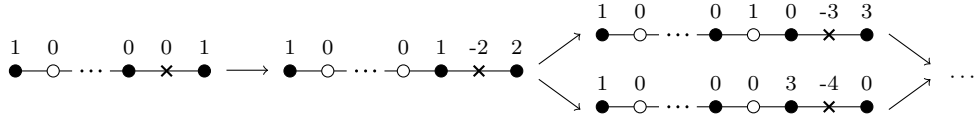

Figure 6.1: The Hasse diagram of the adjoint representation of $\mathfrak{g} = \mathfrak{sl}(n+1, \mathbb{H})$, which computes the homology $H_\bullet(\mathfrak{p}^\pm; \mathfrak{g})$, drawn here for $n \geq 4$.

The component of (6.16) in $\wedge_+^2 T^*M \otimes (\mathcal{E} \otimes_{\mathbb{C}} \mathcal{E}^*)_{\mathbb{R}}$ is the Weyl curvature W^∇ of ∇ . Since the complexification of $\mathfrak{gl}(TM)$ is associated to $(E \boxtimes H) \otimes (E^* \boxtimes H^*)$, the description of the Cartan product in [74] gives

$$\begin{aligned} (E \boxtimes H) \otimes (E^* \boxtimes H^*) &\cong ((E \otimes_{\mathbb{C}} E^*) \boxtimes (H \otimes_{\mathbb{C}} H^*)) \oplus (\mathbb{C} \boxtimes (H \otimes_{\mathbb{C}} H^*)) \\ &\oplus ((E \otimes_{\mathbb{C}} E^*) \boxtimes \mathbb{C}) \oplus (\mathbb{C} \boxtimes \mathbb{C}). \end{aligned} \quad (6.17)$$

The second summand may be identified with $Q_{\mathbb{C}}$ via a dimension count, while the final two summands respectively produce the complexifications of the trace-free part $\mathfrak{sl}(TM, \mathcal{Q})$ and trace part of $\mathfrak{gl}(TM, \mathcal{Q})$. It follows that W^∇ is \mathbb{Q} -invariant, $\mathfrak{sl}(TM)$ -valued, and totally trace-free.

By Theorem 3.36, the curvature tensor R^∇ of a Weyl connection $\nabla \in [\nabla]^q$ decomposes as $R^\nabla = W^\nabla - \llbracket \text{id} \wedge r^\nabla \rrbracket^q$, where $r^\nabla := -\square_M^{-1} \partial R^\nabla$ is the normalised Ricci tensor of ∇ . Then $\delta_\gamma W^\nabla = \llbracket T, \gamma \rrbracket^q$ by Theorem 3.36(3), so that W^∇ is quaternionically invariant if and only if T vanishes, if and only if each Weyl connection is quaternionic.

The Cotton–York tensor $C^\nabla := d^\nabla r^\nabla$ of ∇ splits into components C^{∇^\pm} according to the decomposition (6.14) of $\wedge^2 T^*M$. For later use we collect some curvature identities; their proofs are similar to the corresponding identities in Subsections 4.2.4 and 5.3.3.

Proposition 6.11. *Let $\nabla \in [\nabla]^q$ be a Weyl connection. Then:*

- (1) W^∇ satisfies the Bianchi identity

$$W_{X,Y}^\nabla \cdot Z + W_{Y,Z}^\nabla \cdot X + W_{Z,X}^\nabla \cdot Y = (d^\nabla T)_{X,Y,Z}. \quad (6.18)$$

- (2) W^∇ is a Q -invariant and valued in $\mathfrak{sl}(TM, \mathcal{Q})$; thus W^∇ is totally trace-free, and $W^\nabla \cdot J = 0$ and $W_{JX,JY}^\nabla = W_{X,Y}^\nabla$ for all unit norm $J \in \Omega^0(M; \mathcal{Q})$ and all $X, Y \in \Omega^0(M; TM)$. Moreover W^∇ is quaternionically invariant if and only if the intrinsic torsion T of $[\nabla]^q$ vanishes.

- (3) C^∇ satisfies the Bianchi identities

$$\begin{aligned} C_{X,Y}^\nabla(Z) + C_{Y,Z}^\nabla(X) + C_{Z,X}^\nabla(Y) &= 0 \\ \text{and } C_{X,Y}^\nabla(JZ) + C_{Y,Z}^\nabla(JX) + C_{Z,X}^\nabla(JY) &= 0 \end{aligned} \quad (6.19)$$

for each $J \in \Omega^0(M; \mathcal{Q})$.

- (4) We have $\varepsilon^i(\nabla_{e_i} W_{X,Y}^\nabla) = (2n-1)C_{X,Y}^{\nabla+}$ with respect to any local frame $\{e_i\}_i$ of TM with dual coframe $\{\varepsilon^i\}_i$.
- (5) r^∇ is related to the Ricci curvature ∂R^∇ of ∇ by

$$r^\nabla = -\frac{1}{2n}(\text{sym } \partial R^\nabla) - \frac{1}{2n+2}(\text{alt } \partial R^\nabla) + \frac{1}{n^2+2n}(\text{sym } \partial R^\nabla)^+.$$

In particular if r^∇ is symmetric and Q -invariant, then $r^\nabla = -\frac{1}{2n+4}\partial R^\nabla$. \square

We have already proved the claims in Proposition 6.11(2); more direct proofs can be found in [9, Prop. 1.3(2)] and [37, Prop. 4]. The Bianchi identities (6.19) follow upon precomposing the differential Bianchi identity $d^\nabla R^\nabla = 0$ with J , before evaluating the algebraic bracket with respect to the local quaternionic frame determined by J and taking a trace. Note that Q -invariance of W^∇ means that we do not get an identity for $C^{\nabla-}$ in Proposition 6.11(3), as we did in Proposition 5.9(4).

6.3 Associated BGG operators

Unsurprisingly, the metrisability of a quaternionic structure may be handled in a similar way to the metrisability of projective and c -projective structures. The flat model $\mathbb{H}\mathbb{P}^n$ embeds into the projectivisation of an irreducible \mathfrak{g} -representation \mathbb{W} , and the first BGG operator associated to \mathbb{W} has kernel isomorphic to the space of compatible quaternion-Kähler metrics. We study this BGG operator in Subsection 6.3.1.

As in c -projective geometry, the first BGG operator associated to the dual representation \mathbb{W}^* is a hessian operator whose theory proceeds in much the same way as

that of Subsection 5.4.2. We study this *quaternionic hessian* in Subsection 6.3.2, which controls which Weyl connections have symmetric \mathbb{Q} -invariant normalised Ricci tensor.

For the remainder of this chapter we assume that the intrinsic torsion T of \mathcal{Q} vanishes, in which case Weyl curvature $W := W^\nabla$ is quaternionically invariant.

6.3.1 Metrisability of quaternionic structures

Let $(M, \mathcal{Q}, [\nabla]^q)$ be a quaternionic manifold of dimension $4n$. By definition, compatible metrics are quaternion-Kähler or locally hyperkähler, depending on their scalar curvature, so are smooth sections of the \mathbb{Q} -hermitian subbundle $S_+^2 T^*M$. Following the programmes of Sections 4.3 and 5.4, we are interested in the natural decomposition

$$T^*M \otimes S_+^2 TM = (\text{id} \odot TM)_+ \oplus (T^*M \otimes_\circ S_+^2 TM), \quad (6.20)$$

where the first summand is the image of $Z \mapsto \text{id} \odot Z + \sum_{a=1}^3 J_a \odot J_a Z$ and the second summand is the kernel of the natural trace $T^*M \otimes S_+^2 TM \rightarrow TM$. We shall denote projection onto $T^*M \otimes_\circ S_+^2 TM$ in (6.20) by the subscript “ \circ ”. The proof of the following is similar to Propositions 4.11 and 5.10.

Proposition 6.12. *The first-order linear differential equation $(\nabla h)_\circ = 0$ is quaternionically invariant on sections of $\mathcal{L}^* \otimes S_+^2 TM$. \square*

We refer to the equation $(\nabla h)_\circ = 0$ as the *linear metric equation* of quaternionic geometry, and its solutions as *linear metrics*. We may equivalently write

$$\nabla_X h = X \odot Z^\nabla + \sum_{a=1}^3 J_a X \odot J_a Z^\nabla \quad (6.21)$$

for some $Z^\nabla \in \Omega^0(M; \mathcal{L}^* \otimes TM)$ and all $X \in \Omega^0(M; TM)$, which should be compared to (6.7) and the corresponding equations (4.6) and (5.9) in projective differential geometry and c-projective geometry. Taking a trace in (6.21) yields $Z^\nabla = \frac{1}{2n-1} \partial(\nabla h)$.

Identifying $\mathcal{L}^{2n+2} \cong \wedge^{4n} TM$, a non-degenerate quaternion-Kähler metric g induces a section of $\mathcal{L}^* \otimes S_+^2 TM$ defined by

$$h := (\det g)^{1/(4n+4)} g^{-1},$$

which we call the *linear metric* associated to g . Then $\det h = (\det g)^{-1/(n+1)}$ is a section of \mathcal{L}^4 , from which we may recover $g = (\det h)^{-1/4} h^{-1}$; cf. equation (6.6).

Corollary 6.13. *There is a linear isomorphism between solutions of the linear metric equation and quaternionic metric connections in $[\nabla]^q$. \square*

Thus we have reduced the metrisability problem for quaternionic structures to the

study of a quaternionically invariant first-order linear differential equation. Its prolongation proceeds as for Theorems 4.14 and 5.12.

Theorem 6.14. *There is a linear isomorphism between solutions h of the metric equation and parallel sections of the quaternionically invariant connection*

$$\nabla_X^{\mathcal{W}} \begin{bmatrix} h \\ Z \\ \lambda \end{bmatrix} = \begin{bmatrix} \nabla_X h - X \odot Z - \sum_{a=1}^3 J_a X \odot J_a Z \\ \nabla_X Z - h(r_X^{\nabla}, \cdot) - \lambda X \\ \nabla_X \lambda - r_X^{\nabla}(Z) \end{bmatrix} - \frac{1}{2n} \begin{bmatrix} 0 \\ -W_{e_i, X} \cdot h(\varepsilon^i, \cdot) \\ h(C_{e_i, X}^{\nabla+}, \varepsilon^i) \end{bmatrix} \quad (6.22)$$

defined on sections (h, Z, λ) of $\mathcal{W} := (\mathcal{L}^* \otimes S_+^2 TM) \oplus (\mathcal{L}^* \otimes TM) \oplus \mathcal{L}^*$.

Proof. We may choose a local quaternionic frame $\{J_a\}_{a=1}^3$ and apply the observations in the proof of Theorem 5.12 for each J_a . Then only the J_a -invariant pieces of the Weyl and Cotton–York tensors contribute to the curvature correction for each a , so that only the Q-invariant pieces contribute. \square

The linear metric equation may be interpreted as a first BGG operator as follows. As described in Subsection 6.2.1, the flat model $\mathbb{H}\mathbb{P}^n$ enjoys a projective embedding $\mathbb{H}\mathbb{P}^n \hookrightarrow \mathbb{P}(\mathbb{W})$ for $\mathbb{W} := (\wedge_{\mathbb{C}}^2 \mathbb{C}^{2n+2})_{\mathbb{R}}$. Identifying \mathbb{C}^{2n+2} with the standard representation $\mathbb{T} = \mathbb{H}^{n+1}$, an algebraic Weyl structure gives a decomposition

$$\begin{aligned} \mathbb{W}_{\mathbb{C}} &= \wedge_{\mathbb{C}}^2(E \otimes H^*) \cong \wedge_{\mathbb{C}}^2 E \oplus (E \otimes H^*) \oplus \wedge_{\mathbb{C}}^2 H^* \\ &\cong (\wedge_{\mathbb{C}}^2 H^* \otimes (\wedge_{\mathbb{C}}^2 E \otimes \wedge_{\mathbb{C}}^2 H)) \oplus (\wedge_{\mathbb{C}}^2 H^* \otimes \mathbb{C}TM) \oplus \wedge_{\mathbb{C}}^2 H^* \end{aligned}$$

of the complexification of \mathbb{W} , hence giving an isomorphism of the bundle associated to the underlying real representation \mathbb{W} with the bundle \mathcal{W} from Theorem 6.14. The first BGG operator associated to \mathbb{W} is a differential operator

$$\mathcal{D}^{\mathbb{W}} : \begin{array}{cccccccc} 0 & 1 & 0 & \dots & 0 & 0 & 0 & 0 \\ \bullet & \circ & \bullet & \dots & \circ & \bullet & \times & \bullet \end{array} \longrightarrow \begin{array}{cccccccc} 0 & 1 & 0 & \dots & 0 & 1 & -2 & 1 \\ \bullet & \circ & \bullet & \dots & \circ & \bullet & \times & \bullet \end{array},$$

$$L^* \otimes S_+^2 TM \qquad (L^* \otimes S_+^2 TM) \oplus T^*M$$

which is clearly first order. The prolongation connection $\nabla^{\mathcal{W}}$ from Theorem 6.14 is precisely the prolongation connection of this BGG operator. We shall call the dimension of the space of parallel sections of $\nabla^{\mathcal{W}}$ the *mobility* of the quaternionic structure. On the flat model, the space of solutions is pointwise isomorphic to the \mathfrak{g} -representation $\mathbb{W} = (\wedge_{\mathbb{C}}^2 \mathbb{C}^{2n+2})_{\mathbb{R}}$, so that the mobility is bounded above by $\dim \mathbb{W} = (n+1)(2n+1)$.

A BGG solution is called *normal* if it is parallel for the tractor connection, *i.e.* if the tractor and curvature correction parts of the prolongation connection independently act trivially. We have the following characterisation of normal solutions of the linear metric equation; a similar characterisation for projective differential geometry is given in [15, 57, 85], while the c-projective case is handled in [51, Prop. 4.8].

Proposition 6.15. *A non-degenerate $\nabla^{\mathcal{W}}$ -parallel section (h, Z, λ) of \mathcal{W} is normal if and only if the corresponding Q -hermitian metric $g := (\det h)^{-1/4} h^{-1}$ is Einstein.*

Proof. Let ∇ be the Levi-Civita connection of g . Calculating with respect to ∇ , if (h, Z, λ) is a normal solution then (6.22) reads

$$\nabla_X^{\mathcal{W}} \begin{bmatrix} h \\ Z^\nabla \\ \lambda^\nabla \end{bmatrix} = \begin{bmatrix} 0 \\ -h(r_X^\nabla, \cdot) - \lambda^\nabla X \\ \nabla_X \lambda^\nabla \end{bmatrix} = 0,$$

since $Z^\nabla = \frac{1}{2n-1} \partial(\nabla h) = 0$. We deduce that λ^∇ is a constant multiple of the global trivialisation $(\det h)^{1/4}$ of \mathcal{L} determined by h , say $\lambda = c(\det h)^{1/4}$, so that $h(r_X^\nabla, \cdot) = -c(\det h)^{1/4} X$. Applying h^{-1} to both sides gives $r_X^\nabla = -cg(X, \cdot)$ for all $X \in \Omega^0(M; TM)$, so that g is Einstein by Proposition 6.11(5).

Conversely suppose that g is an Einstein metric with $r^\nabla = -cg$. We must show that the curvature correction in (6.22) vanishes. Calculating with respect to the Levi-Civita connection ∇ of g , evidently $C^\nabla := d^\nabla r^\nabla = -c(d^\nabla g)$ vanishes. For the Weyl term $W_{e_i, X} \cdot h(\varepsilon^i, \cdot)$, since W acts trivially on \mathcal{L} it suffices to show that $W_{e_i, X} \cdot g^{-1}(\varepsilon^i, \cdot) = 0$. By the curvature decomposition, we have

$$W_{e_i, X} \cdot g^{-1}(\varepsilon^i, \cdot) = R_{e_i, X}^\nabla \cdot g^{-1}(\varepsilon^i, \cdot) + c \llbracket \text{id} \wedge g \rrbracket_{e_i, X}^q \cdot g^{-1}(\varepsilon^i, \cdot). \quad (6.23)$$

For the first term on the right-hand side of (6.23),

$$g(R_{e_i, X}^\nabla \cdot g^{-1}(\varepsilon^i, \cdot), Y) = (R_{e_i, X}^\nabla \cdot \varepsilon^i)(Y) = -(\partial R^\nabla)_X(Y) = (2n+4)r_X^\nabla(Y)$$

for all $X, Y \in \Omega^0(M; TM)$, so that $R_{e_i, X}^\nabla \cdot g^{-1}(\varepsilon^i, \cdot) = -(2n+4)cX$. For the second term, direct calculation yields

$$\begin{aligned} c \llbracket \text{id} \wedge g \rrbracket_{e_i, X}^q \cdot g^{-1}(\varepsilon^i, \cdot) &= \frac{1}{2}c (\varepsilon^i(X)e_i - \sum_{a=1}^3 [g(X, J_a e_i) J_a \varepsilon^{i\sharp} - \varepsilon^i(J_a X) J_a e_i] \\ &\quad - \varepsilon^i(e_i)X + \sum_{a=1}^3 [g(e_i, J_a X) J_a \varepsilon^{i\sharp} - \varepsilon^i(J_a e_i) J_a X]) \\ &= -(2n+4)cX, \end{aligned}$$

so that substitution in (6.23) shows that $W_{e_i, X} \cdot h(\varepsilon^i, \cdot) = 0$ as well. \square

Since by Proposition 6.5 all non-degenerate quaternion-Kähler metrics are Einstein, the following is immediate from Proposition 6.15.

Corollary 6.16. *All non-degenerate solutions of the metric equation are normal.* \square

Given the developments of Sections 4.3 and 5.4, we should expect that quaternionic geometry admits a “big” Lie algebra of the form $\mathfrak{h} := \mathbb{W} \oplus (\mathfrak{g} \oplus \mathbb{R}) \oplus \mathbb{W}^*$. This is indeed

the case: complexifying gives $\mathfrak{g}_{\mathbb{C}} = \mathfrak{sl}(2n+2, \mathbb{C})$ and $\mathfrak{g}_{\mathbb{C}} \oplus \mathbb{C} = \mathfrak{gl}(2n+2, \mathbb{C})$, so that

$$\begin{aligned} \mathfrak{h}_{\mathbb{C}} &\cong \wedge_{\mathbb{C}}^2 \mathbb{C}^{2n+2} \oplus (\mathbb{C}^{2n+2} \otimes \mathbb{C}^{2n+2*}) \oplus \wedge_{\mathbb{C}}^2 \mathbb{C}^{2n+2*} \\ &= \wedge_{\mathbb{C}}^2 (\mathbb{C}^{2n+2} \oplus \mathbb{C}^{2n+2*}), \end{aligned}$$

which is the adjoint representation of the complex Lie algebra $\mathfrak{so}(\mathbb{C}^{2n+2} \oplus \mathbb{C}^{2n+2*})$. Thus $\mathfrak{h}_{\mathbb{C}}$ has a graded Lie algebra structure isomorphic to $\mathfrak{so}(4n+4, \mathbb{C})$, with abelian subalgebras $\mathbb{W}_{\mathbb{C}}, \mathbb{W}_{\mathbb{C}}^*$ and opposite abelian parabolics $\mathfrak{q}_{\mathbb{C}} := (\mathfrak{g}_{\mathbb{C}} \oplus \mathbb{C}) \ltimes \mathbb{W}^*$ and $\hat{\mathfrak{q}}_{\mathbb{C}} := \mathbb{W} \ltimes (\mathfrak{g}_{\mathbb{C}} \oplus \mathbb{C})$. To introduce the appropriate real form \mathfrak{h} , we note that, up to isomorphism, there is a unique \mathbb{Q} -hermitian bilinear form on \mathbb{H}^{n+1} with skew-symmetric real part and symmetric imaginary part. The algebra preserving this form is

$$\mathfrak{so}^*(4n+4) := \left\{ \begin{pmatrix} A & B \\ -B^{\top} & \bar{A} \end{pmatrix} \mid A^{\top} = -A, \bar{B}^{\top} = B \right\}, \quad (6.24)$$

which is evidently a (real) subalgebra of $\mathfrak{so}(4n+4, \mathbb{C})$. The quaternionic structure on \mathbb{W} implies that $\mathfrak{so}^*(4n+4)$ is the appropriate real form of $\mathfrak{so}(4n+4, \mathbb{C})$, so that the Satake diagrams of $\mathfrak{q} \leq \mathfrak{h}$ are

$$\mathfrak{q} = \bullet \circ \dots \circ \bullet \begin{array}{l} \nearrow \bullet \\ \searrow \times \end{array} \leq \bullet \circ \dots \circ \bullet \begin{array}{l} \nearrow \bullet \\ \searrow \circ \end{array} = \mathfrak{h}.$$

Then $H \cdot \mathfrak{q}$ is the grassmannian of maximal isotropic quaternionic subspaces of \mathbb{H}^{n+1} . In terms of associated bundles, $\mathfrak{h}_M \cong \mathcal{W} \oplus \mathfrak{gl}(\mathcal{T}) \oplus \mathcal{W}^*$, where $\mathfrak{gl}(\mathcal{T})$ is the Lie algebra bundle of quaternion-linear automorphisms of \mathcal{T} .

6.3.2 The quaternionic hessian

As in c-projective geometry, the first BGG operator associated to the \mathfrak{g} -representation $\mathbb{W}^* := (\wedge_{\mathbb{C}}^2 \mathbb{C}^{2n+2*})_{\mathbb{R}}$ is a second order hessian operator: the first BGG operator is

$$\mathcal{D}^{\mathbb{W}^*} : \begin{array}{ccccccc} 0 & 0 & & 0 & 0 & 1 & 0 \\ \bullet & \circ & \dots & \circ & \bullet & \times & \bullet \end{array} \longrightarrow \begin{array}{ccccccc} 0 & 0 & & 0 & 2 & -3 & 2 \\ \bullet & \circ & \dots & \circ & \bullet & \times & \bullet \end{array},$$

$\mathcal{L} \qquad \qquad \qquad \mathcal{L} \otimes S_-^2 T^* M$

where $S_-^2 T^* M := (S_{\mathbb{C}}^2 \mathcal{E}^* \otimes S_{\mathbb{C}}^2 \mathcal{H}^*)_{\mathbb{R}}$ is the complement to the \mathbb{Q} -invariant subbundle $S_+^2 T^* M$ in $S^2 T^* M$. We call $\mathcal{D}^{\mathbb{W}^*}$ the *quaternionic hessian*. Using the inverse Cartan matrix of $\mathfrak{g}_{\mathbb{C}}$ it is straightforward to see that $\mathcal{D}^{\mathbb{W}^*}$ is second order, so that $\mathcal{D}^{\mathbb{W}^*}$ is given by projection of the Ricci-corrected second derivative onto $\mathcal{L} \otimes S_-^2 T^* M$, *i.e.*

$$\mathcal{D}_{X,Y}^{\mathbb{W}^*}(\ell) = (\nabla_{X,Y}^2 \ell + \ell r_X^{\nabla}(Y))_-. \quad (6.25)$$

A simple calculation shows that $\mathcal{D}^{\mathbb{W}^*}$ is quaternionically invariant. By Lemma 6.4, a section $\ell \in \Omega^0(M; \mathcal{L})$ uniquely determines a quaternionic connection ∇^ℓ defined by $\nabla^\ell \ell = 0$. We may then characterise solutions of the quaternionic hessian in a similar way to the c-projective hessian; cf. Proposition 5.14 and Corollary 5.15.

Proposition 6.17. *A nowhere-vanishing section $\ell \in \Omega^0(M; \mathcal{L})$ satisfies $\mathcal{D}^{\mathbb{W}^*}(\ell) = 0$ if and only if the normalised Ricci tensor r^{∇^ℓ} of ∇^ℓ is symmetric and Q -invariant. \square*

Corollary 6.18. *Let $h \in \Omega^0(M; \mathcal{L}^* \otimes \mathbb{S}_+^2 TM)$ be a linear metric. Then $(\det h)^{1/4}$ lies in the kernel of the quaternionic hessian. \square*

Remark 6.19. As remarked above, 4-dimensional almost quaternionic structure is just a 4-dimensional conformal structure, corresponding to the identification of \mathbb{S}^4 with $\mathbb{H}\mathbb{P}^1$. The aforementioned self-duality condition is equivalent to the choice of a quaternionic hessian or *Möbius structure*; see [43, §6.4].

Since $\mathcal{D}^{\mathbb{W}^*}$ is a first BGG operator, its solution space is linearly isomorphic to the space of parallel sections of a connection $\nabla^{\mathbb{W}^*}$ on $\mathcal{W}^* \cong \mathcal{L} \oplus (\mathcal{L} \otimes T^*M) \oplus (\mathcal{L} \otimes \mathbb{S}_+^2 T^*M)$.

Theorem 6.20. *There is a linear isomorphism between the space of solutions of the quaternionic hessian $\mathcal{D}^{\mathbb{W}^*}$ and the parallel sections of the quaternionically invariant connection*

$$\nabla_X^{\mathcal{W}^*} \begin{bmatrix} \ell \\ \eta \\ \theta \end{bmatrix} = \begin{bmatrix} \nabla_X \ell - \eta(X) \\ \nabla_X \eta - \theta(X, \cdot) + \ell r_X^\nabla \\ \nabla_X \theta + r_X^\nabla \odot \eta + \sum_{a=1}^3 J_a r_X^\nabla \odot J_a \eta \end{bmatrix} \quad (6.26)$$

on sections (ℓ, η, θ) of $\mathcal{W}^* \cong \mathcal{L} \oplus (\mathcal{L} \otimes TM) \oplus (\mathcal{L} \otimes \mathbb{S}_+^2 T^*M)$.

Proof. Choose a unit norm section $J \in \Omega^0(M; \mathcal{Q})$ and form the local quaternionic frame $\{J_a\}_{a=1}^3$ with $J_1 = J$. We define $\eta^\nabla := \nabla \ell \in \Omega^1(M; \mathcal{L})$ and $\theta^\nabla := (\nabla^2 \ell + \ell r^\nabla)_-$, so that $\mathcal{D}^{\mathbb{W}^*}(\ell) = 0$ if and only if $\theta^\nabla = \nabla \eta^\nabla + \ell r^\nabla$. In this case θ^∇ is Q -invariant, and by applying (6.3) we find that the same is true for $\nabla_X \theta^\nabla$. Imitating the proof of Theorem 5.17 and using Proposition 6.11, we conclude that $\mathcal{D}^{\mathbb{W}^*}(\ell) = 0$ if and only if $(\ell, \eta^\nabla, \theta^\nabla)$ is parallel for the quaternionically invariant connection

$$\tilde{\nabla}_X^{\mathcal{W}^*} \begin{bmatrix} \ell \\ \eta \\ \theta \end{bmatrix} = \begin{bmatrix} \nabla_X \ell - \eta(X) \\ \nabla_X \eta - \theta(X, \cdot) + \ell r_X^\nabla \\ \nabla_X \theta + r_X^\nabla \odot \eta + \sum_{a=1}^3 J_a r_X^\nabla \odot J_a \eta \end{bmatrix} + \begin{bmatrix} 0 \\ 0 \\ (W_{\cdot, J} \cdot \eta)(JX) + \ell C_{\cdot, J}^{\nabla+}(JX) \end{bmatrix}$$

for each such J . Since the tractor part is independent of J , it follows that the curvature correction $\Psi(Y, Z) := \eta^\nabla(W_{JY, Z} \cdot JX) - \ell C_{JY, Z}^{\nabla+}(JX)$ is also independent of the choice

of J . Exploiting this independence and the fact that Ψ is \mathbb{Q} -invariant, taking $J = J_a$ in the definition of Ψ gives

$$\begin{aligned}
\Psi(J_b Y, Z) &= \eta^\nabla(W_{J_c Y, Z} \cdot J_a X) - \ell C_{J_c Y, Z}^{\nabla+}(J_a X) \\
&= \eta^\nabla(W_{J_a J_c Y, J_a Z} \cdot J_a X) - \ell C_{J_a J_c Y, J_a Z}^{\nabla+}(J_a X) \\
&= \eta^\nabla(W_{J_b J_c Y, J_a Z} \cdot J_b X) - \ell C_{J_b J_c Y, J_a Z}^{\nabla+}(J_b X) \\
&= \eta^\nabla(W_{J_a Y, J_a Z} \cdot J_b X) - \ell C_{J_a Y, J_a Z}^{\nabla+}(J_b X) \\
&= \eta^\nabla(W_{J_b Y, J_b Z} \cdot J_b X) - \ell C_{J_b Y, J_b Z}^{\nabla+}(J_b X) \\
&= \Psi(Y, J_b Z)
\end{aligned}$$

for all cyclic permutations (a, b, c) of $(1, 2, 3)$, which contradicts the \mathbb{Q} -invariance of Ψ . Therefore $\Psi = 0$ and hence $\tilde{\nabla}^{\mathcal{W}^*} = \nabla^{\mathcal{W}^*}$ as required. \square

Corollary 6.21. *All solutions of the quaternionic hessian are normal.* \square

Note that the authors of [17] refer to solutions of $\mathcal{D}^{\mathbb{W}^*}$ as *Einstein scales*. The metric prolongation connection $\nabla^{\mathcal{W}}$ defined by (6.22) is dual to $\nabla^{\mathcal{W}^*}$ modulo a curvature correction. In particular, Corollary 6.16 implies that these connections are dual if (M, \mathcal{Q}) admits a non-degenerate linear metric.

Projective parabolic geometries

The primary goal of this thesis is to describe the classical projective structures using a common framework. The general definition is presented in Definition 7.7 and exploits the existence of a “big” \mathbb{R} -space $H \cdot \mathfrak{q}$ for each classical projective structure, induced by the graded Lie algebra $\mathfrak{h} := \mathbb{W} \oplus (\mathfrak{g} \oplus \mathbb{R}) \oplus \mathbb{W}^*$ in each case. Section 7.1 is dedicated to setting up this definition, which requires some preliminary work regarding duality for \mathbb{R} -spaces. We will see in Section 7.2 that the algebraic structure of the classical projective structures generalises in almost every detail to the projective parabolic geometry framework; in particular, there is a \mathbb{Z}^2 -graded Lie algebra in which we have tight control over the possible Lie brackets. This is made possible by a Jordan algebra structure on the infinitesimal isotropy representation $\mathbb{W} := \mathfrak{h}/\mathfrak{q}$ of \mathfrak{q} .

The constraints on a projective parabolic geometry are quite strict, resulting in a short classification which we describe in Section 7.3. Via the algebraic work of Section 7.2, the classification over \mathbb{C} can be phrased entirely in terms of a pair of integers (r, n) which have a purely Lie-theoretic origin; in particular $\dim M = rn$.

Finally, we describe the BGG operators associated to the representations \mathbb{W} and \mathbb{W}^* in Section 7.4. As for the classical structures, a projective parabolic geometry has a well-defined metrisability problem controlled by the first BGG operator associated to \mathbb{W} , while the first BGG operator associated to \mathbb{W}^* is a hessian-type equation. The algebraic work of Section 7.2 gives considerable information about these operators and their solutions, allowing us to obtain relatively explicit prolongations.

7.1 Definition and self-duality

In the previous three chapters we studied the theories of projective differential geometry, c -projective geometry and quaternionic geometry, both from their classical perspectives and as abelian parabolic geometries. Even the most inattentive reader will have noticed a great deal of similarity within these developments. We collect the appropriate

observations in Subsection 7.1.1, before introducing a notion of duality for R-spaces in Subsection 7.1.2. This allows us to present a general framework in Subsection 7.1.3, which generalises all three classical structures.

7.1.1 Key features of classical projective geometries

As explained in the corresponding chapters, projective differential geometry, c-projective geometry and almost quaternionic geometry are all abelian parabolic geometries, respectively modelled on the symmetric R-spaces $\mathbb{R}P^n$, $\mathbb{C}P^n$ and $\mathbb{H}P^n$. Each of these models enjoys a projective embedding $G \cdot \mathfrak{p} \hookrightarrow \mathbb{P}(\mathbb{W})$ for an appropriate irreducible \mathfrak{g} -representation \mathbb{W} , with associated graded representation

$$\text{gr } \mathbb{W} \cong (L^* \otimes B) \oplus (L^* \otimes \mathfrak{g}/\mathfrak{p}) \oplus L^*.$$

Here L^* is the 1-dimensional socle of the \mathfrak{p}^\perp -filtration of \mathbb{W} and B is an irreducible \mathfrak{p}^0 -subrepresentation of $S^2(\mathfrak{g}/\mathfrak{p})$, such that $L^* \otimes B \cong H_0(\mathfrak{p}^\perp; \mathbb{W})$ may be identified with the zeroth Lie algebra homology. For projective, c-projective and quaternionic geometries, we had $\mathbb{W} = S^2\mathbb{R}^{n+1}$, $\mathbb{W} = (\mathbb{C}^{n+1} \boxtimes \overline{\mathbb{C}^{n+1}})_{\mathbb{R}}$ and $\mathbb{W} = (\wedge_{\mathbb{C}}^2 \mathbb{C}^{2n+2})_{\mathbb{R}}$ respectively, where \boxtimes denotes the external tensor product.

We also observed in each case that $\mathfrak{h} := \mathbb{W} \oplus (\mathfrak{g} \oplus \mathbb{R}) \oplus \mathbb{W}^*$ admits the structure of a graded Lie algebra: for projective, c-projective and almost quaternionic geometries, we had $\mathfrak{h} \cong \mathfrak{sp}(2n+2, \mathbb{R})$, $\mathfrak{h} \cong \mathfrak{su}(n+1, n+1)$ and $\mathfrak{h} \cong \mathfrak{so}^*(4n+4)$ respectively. Moreover it follows that the trivial central extension $\mathfrak{q}^0 := \mathfrak{g} \oplus \mathbb{R}$ is a reductive Lie algebra, with $\mathfrak{q} := \mathfrak{q}^0 \ltimes \mathbb{W}^*$ and $\hat{\mathfrak{q}} := \mathbb{W} \ltimes \mathfrak{q}^0$ opposite abelian parabolic subalgebras of \mathfrak{h} ; in particular, $H \cdot \mathfrak{q}$ is a symmetric R-space. The crucial observation about the R-spaces $H \cdot \mathfrak{q}$ is as follow. For the classical projective structures, the Satake diagrams of $\mathfrak{q} \leq \mathfrak{h}$ are

$$\begin{array}{c} \circ - \circ - \dots - \circ - \circ \leftarrow \times \leq \mathfrak{sp}(2n+2, \mathbb{R}), \quad \begin{array}{c} \circ - \circ - \dots - \circ - \circ \\ \updownarrow \quad \updownarrow \quad \updownarrow \quad \updownarrow \\ \circ - \circ - \dots - \circ - \circ \end{array} \rightarrow \times \leq \mathfrak{su}(n+1, n+1) \\ \text{and} \quad \bullet - \circ - \bullet - \dots - \bullet - \circ - \bullet \rightarrow \times \leq \mathfrak{so}^*(4n+4). \end{array}$$

If $w_{\mathfrak{h}}$ is the longest element of the Weyl group of \mathfrak{h} , $-w_{\mathfrak{h}}$ induces an automorphism of the Satake diagram, which is the identity for $\mathfrak{sp}(2n+2, \mathbb{R})$ and $\mathfrak{so}^*(4n+4)$, and the involution indicated by the arrows for $\mathfrak{su}(n+1, n+1)$. In each case the single crossed node of \mathfrak{q} is preserved by this automorphism. To interpret this in terms of projective embeddings as in Subsection 2.1.4, choose a Cartan subalgebra \mathfrak{t} and simple subsystem with respect to which \mathfrak{q} is a standard parabolic. Then by Corollary 2.23

there is a projective embedding $H \cdot \mathfrak{q} \hookrightarrow \mathbb{P}(\mathbb{V}^*)$ for any irreducible \mathfrak{h} -representation \mathbb{V} whose highest weight $\lambda \in \mathfrak{t}^*$ is supported on the single crossed node of \mathfrak{q} . The highest weight of \mathbb{V}^* is $-w_{\mathfrak{h}}(\lambda)$, which in each case is also supported on the single crossed node of \mathfrak{q} , and thus the R-spaces induced by the projective embeddings into $\mathbb{P}(\mathbb{V}^*)$ and $\mathbb{P}(\mathbb{V})$ are isomorphic; we will interpret this as a self-duality condition in the next subsection.

7.1.2 Duality for R-spaces

We continue now to describe a form of duality for R-spaces, following [44]. Let $H \cdot \mathfrak{q}$ be an R-space and consider the set $(H \cdot \mathfrak{q})^*$ of parabolic subalgebras of \mathfrak{h} which are opposite to some $\mathfrak{q}' \in H \cdot \mathfrak{q}$. By the following [44, Prop. 2.3], $(H \cdot \mathfrak{q})^*$ is an R-space.

Lemma 7.1. *$(H \cdot \mathfrak{q})^*$ is a single conjugacy class of parabolic subalgebras of \mathfrak{h} .*

Proof. Let $\mathfrak{q}_1, \mathfrak{q}_2 \in (H \cdot \mathfrak{q})^*$, with $\mathfrak{q}_1, \mathfrak{q}_2$ opposite to $\mathfrak{q}, h \cdot \mathfrak{q}$ for $h \in H$. Then $h^{-1} \cdot \mathfrak{q}_2$ is opposite to \mathfrak{q} , giving $qh^{-1} \cdot \mathfrak{q}_2 = \mathfrak{q}_1$ for a unique element $q \in \exp \mathfrak{q}^\perp$ by Lemma 2.12. \square

Clearly $(H \cdot \mathfrak{q})^*$ has the same height as $H \cdot \mathfrak{q}$. Moreover since we obviously have $(H \cdot \mathfrak{q})^{**} = H \cdot \mathfrak{q}$, we make the following definition [44, Defn. 2.4].

Definition 7.2. $(H \cdot \mathfrak{q})^*$ is the *dual* of $H \cdot \mathfrak{q}$. An R-space is called *self-dual* if it coincides with its dual.

There is always a non-canonical diffeomorphism between $H \cdot \mathfrak{q}$ and its dual. Indeed, the Cartan involution θ corresponding to a maximal compact subgroup of H induces a diffeomorphism $H \cdot \mathfrak{q} \ni \mathfrak{q}' \mapsto \theta(\mathfrak{q}') \in (H \cdot \mathfrak{q})^*$; see [44, p. 8].

Corollary 7.3. *$H \cdot \mathfrak{q}$ is self-dual if and only if \mathfrak{q} is conjugate to every opposite parabolic.*

Proof. Let $\hat{\mathfrak{q}}$ be opposite to \mathfrak{q} . Then $H \cdot \mathfrak{q}$ is self-dual if and only if for all $h_1 \cdot \hat{\mathfrak{q}} \in (H \cdot \mathfrak{q})^*$ and $h_2 \cdot \mathfrak{q} \in H \cdot \mathfrak{q}$, there exists an $h \in H$ such that $hh_1 \cdot \hat{\mathfrak{q}} = h_2 \cdot \mathfrak{q}$. \square

It is straightforward to detect self-duality from the Satake diagram of \mathfrak{q} . For this recall that if $w_{\mathfrak{h}} \in \mathcal{W}_{\mathfrak{h}}$ is the longest element of the Weyl group of \mathfrak{h} , then $-w_{\mathfrak{h}}$ permutes the simple roots, hence inducing an involution of the Satake diagram of \mathfrak{h} .

Lemma 7.4. [44, p. 8] *$H \cdot \mathfrak{q}$ is self-dual if and only if the set of crossed nodes of the Satake diagram of $H \cdot \mathfrak{q}$ is preserved by $-w_{\mathfrak{h}}$.*

Proof. First note that parabolics $\mathfrak{q}, \mathfrak{q}' \leq \mathfrak{h}$ are opposite if and only if their complexifications are opposite, so we may assume that $H \cdot \mathfrak{q}$ is complex.

Now choose a Cartan subalgebra $\mathfrak{t} \leq \mathfrak{h}$ and a simple subsystem Δ^0 with respect to which \mathfrak{q} is a standard parabolic, corresponding to a subset $\Sigma \subseteq \Delta^0$. Then since

$H \cdot \mathfrak{q}$ and $(H \cdot \mathfrak{q})^*$ each contain a unique standard parabolic, it suffices to see when these coincide. Using that $w_{\mathfrak{h}}$ is an involution, the standard parabolic determined by $-w_{\mathfrak{h}}(\Sigma) \subseteq \Delta^0$ is conjugate, via $w_{\mathfrak{h}}$, to the standard parabolic opposite to \mathfrak{q} , *i.e.* the parabolic subalgebra of \mathfrak{h} consisting of \mathfrak{t} and root spaces \mathfrak{h}_{α} for which $\mathfrak{h}_{-\alpha} \leq \mathfrak{q}$. In particular the parabolic determined by $-w_{\mathfrak{h}}(\Sigma)$ lies in $(H \cdot \mathfrak{q})^*$, with equality if and only if $-w_{\mathfrak{h}}(\Sigma) = \Sigma$. \square

Equivalently, for any \mathfrak{h} -representation \mathbb{V} whose highest weight is supported on the crossed nodes of $H \cdot \mathfrak{q}$, the R -spaces determined by projective embeddings into $\mathbb{P}(\mathbb{V}^*)$ and $\mathbb{P}(\mathbb{V})$ are isomorphic. While this gives a convenient characterisation of self-duality when we know the Satake diagram, it will be useful to have a more theoretical condition.

Lemma 7.5. $(\exp(x) \cdot \mathfrak{q})^{\perp} = \exp(x) \cdot \mathfrak{q}^{\perp}$ for all $x \in \mathfrak{h}$.

Proof. Since $\exp(x)$ is an automorphism of \mathfrak{h} , we have $\langle \exp(x) \cdot \mathfrak{q}^{\perp}, \exp(x) \cdot \mathfrak{q} \rangle = \langle \mathfrak{q}^{\perp}, \mathfrak{q} \rangle = 0$ by invariance of the Killing form. \square

By combining results from [44, §4], we arrive at the following characterisation of self-duality for symmetric R -spaces.

Proposition 7.6. *Let $H \cdot \mathfrak{q}$ be a symmetric R -space. Then the following are equivalent:*

- (1) $H \cdot \mathfrak{q}$ is self-dual;
- (2) There is an $f \in \mathfrak{q}^{\perp}$ such that $\ker(\operatorname{ad} f)^2 = \mathfrak{q}$;
- (3) For any parabolic $\hat{\mathfrak{q}}$ opposite to \mathfrak{q} , there exists $e \in \hat{\mathfrak{q}}^{\perp}$ and $f \in \mathfrak{q}^{\perp}$ such that $[e, f]$ equals twice the algebraic Weyl structure ξ induced by $\hat{\mathfrak{q}}$.

Proof. Since \mathfrak{q}^{\perp} is abelian we have $[\mathfrak{h}, \mathfrak{q}^{\perp}] \leq \mathfrak{q}$ and $[\mathfrak{q}, \mathfrak{q}^{\perp}] \leq \mathfrak{q}^{\perp}$, and hence $(\operatorname{ad} x)^2$ vanishes on \mathfrak{q} for all $x \in \hat{\mathfrak{q}}^{\perp}$. Since $\operatorname{Ad} \exp(x) = \exp(\operatorname{ad} x)$, we have

$$\exp(x) \cdot y = y + [x, y] + \frac{1}{2}(\operatorname{ad} x)^2(y) \quad (7.1)$$

for all $y \in \mathfrak{h}$ by the series expansion of the exponential map.

(1) \Rightarrow (2): This is mostly [44, Lem. 4.1]. Denote by $\Omega_{\mathfrak{q}}$ the set of parabolic subalgebras of \mathfrak{h} which are opposite to \mathfrak{q} , which is a dense open subset of $H \cdot \mathfrak{q}$ by [170]. Therefore if $\hat{\mathfrak{q}} \in \Omega_{\mathfrak{q}}$, the set $\Omega_{\mathfrak{q}} \cap \Omega_{\hat{\mathfrak{q}}}$ is also open and dense; Lemma 2.12 then provides an $f \in \mathfrak{q}^{\perp}$ such that $\exp(f) \cdot \hat{\mathfrak{q}} \in \Omega_{\mathfrak{q}} \cap \Omega_{\hat{\mathfrak{q}}}$.

For arbitrary $x \in \mathfrak{q}^{\perp}$, we have $\exp(x) \cdot \hat{\mathfrak{q}} \in \Omega_{\mathfrak{q}} \cap \Omega_{\hat{\mathfrak{q}}}$ if and only if $\exp(x) \cdot \hat{\mathfrak{q}}$ is opposite to $\hat{\mathfrak{q}}$, if and only if $\exp(x) \cdot \hat{\mathfrak{q}}^{\perp} \cap \hat{\mathfrak{q}} = 0$. Taking $y \in \hat{\mathfrak{q}}^{\perp}$, the first two terms in (7.1) live in $\hat{\mathfrak{q}}$, while the third lives in \mathfrak{q}^{\perp} . Since $\mathfrak{q}, \hat{\mathfrak{q}}$ are opposite, we have $\mathfrak{h} = \hat{\mathfrak{q}} \oplus \mathfrak{q}^{\perp}$ and hence $\exp(x) \cdot y \in \exp(x) \cdot \hat{\mathfrak{q}}^{\perp} \cap \hat{\mathfrak{q}}$ if and only if $(\operatorname{ad} x)^2(y) = 0$. Therefore $\exp(x) \cdot \hat{\mathfrak{q}} \in \Omega_{\mathfrak{q}} \cap \Omega_{\hat{\mathfrak{q}}}$

if and only if $(\text{ad } x)^2$ is injective on $\hat{\mathfrak{q}}^\perp$; since also $\mathfrak{h} = \hat{\mathfrak{q}}^\perp \oplus \mathfrak{q}$ and $\ker(\text{ad } x)^2 \subseteq \mathfrak{q}$, this is equivalent to $\ker(\text{ad } x)^2 = \mathfrak{q}$.

(2) \Rightarrow (3): This is a special case of [44, Prop. 4.3]. If $\ker(\text{ad } f)^2 = \mathfrak{q}$ for some $f \in \mathfrak{q}^\perp$ then \mathfrak{q} , $\hat{\mathfrak{q}}$ and $\exp(f) \cdot \hat{\mathfrak{q}}$ are mutually opposite. Then by Lemma 2.12 there are unique elements $e \in \hat{\mathfrak{q}}^\perp$ and $x \in (\exp(f) \cdot \hat{\mathfrak{q}})^\perp = \exp(f) \cdot \hat{\mathfrak{q}}^\perp$ such that $\exp(f) \cdot \hat{\mathfrak{q}} = \exp(e) \cdot \mathfrak{q}$ and $\hat{\mathfrak{q}} = \exp(x) \cdot \mathfrak{q}$. If ξ is the algebraic Weyl structure of the pair $(\mathfrak{q}, \hat{\mathfrak{q}})$, it is straightforward to see that the algebraic Weyl structure of $(\mathfrak{q}, \exp(f) \cdot \hat{\mathfrak{q}})$ is $\exp(f) \cdot \xi = \xi + f$, where the last equality follows by (7.1). Since $\exp(f) \cdot \hat{\mathfrak{q}} = \exp(e) \cdot \mathfrak{q}$, the algebraic Weyl structure of $(\hat{\mathfrak{q}}, \exp(f) \cdot \hat{\mathfrak{q}})$ is similarly $\exp(e) \cdot (-\xi) = -\xi + e$. Writing the pair $(\mathfrak{q}, \exp(f) \cdot \hat{\mathfrak{q}})$ as $(\exp(-x) \cdot \hat{\mathfrak{q}}, \exp(e) \cdot \mathfrak{q})$, it follows that $\exp(f) \cdot \xi = -\exp(-x) \exp(e) \cdot \xi$. Using (7.1) and that $x \in \exp(e) \cdot \mathfrak{q}^\perp$, we have $\exp(-x) \exp(e) \cdot \xi = \exp(e) \cdot \xi - x$. Therefore

$$x = \exp(f) \cdot \xi + \exp(e) \cdot \xi = 2\xi - e + f$$

and hence we obtain

$$[\exp(f) \cdot \xi, \exp(e) \cdot \xi] = [x, \exp(e) \cdot \xi] = x = 2\xi - e + f. \quad (7.2)$$

On the other hand, we have

$$\begin{aligned} [\exp(f) \cdot \xi, \exp(e) \cdot \xi] &= [\xi + f, \xi - e] \\ &= -[\xi, e] + [f, \xi] - [f, e] = -e + f + [e, f]. \end{aligned} \quad (7.3)$$

Comparing (7.2) and (7.3) now gives $[e, f] = 2\xi$.

(3) \Rightarrow (1): Let $\hat{\mathfrak{q}}$ be opposite to \mathfrak{q} with corresponding algebraic Weyl structure ξ , and suppose that $e \in \hat{\mathfrak{q}}^\perp$ and $f \in \mathfrak{q}^\perp$ satisfy $[e, f] = 2\xi$. Then applying (7.1) gives

$$\begin{aligned} \exp(e) \exp(-f) \exp(e) \cdot \xi &= \exp(e) \exp(-f) \cdot (\xi - e) \\ &= \exp(x) \cdot (\xi - f - e - 2\xi + f) \\ &= \exp(x) \cdot (-\xi - e) \\ &= -\xi. \end{aligned}$$

It follows that $\exp(e) \exp(-f) \exp(e)$ is a graded automorphism of $\text{gr } \mathfrak{h}$, sending the graded component $\mathfrak{h}_{(i)}$ to $\mathfrak{h}_{(-i)}$ for all $i \in \{+1, 0, -1\}$. In particular since ξ induces isomorphisms $\mathfrak{q} \cong \mathfrak{h}_{(0)} \oplus \mathfrak{h}_{(-1)}$ and $\hat{\mathfrak{q}} \cong \mathfrak{h}_{(1)} \oplus \mathfrak{h}_{(0)}$, we have $\exp(e) \exp(-f) \exp(e) \cdot \hat{\mathfrak{q}} = \mathfrak{q}$. Thus $\hat{\mathfrak{q}}$ is conjugate to \mathfrak{q} and hence $H \cdot \mathfrak{q}$ is self-dual by Corollary 7.3. \square

Elements $f \in \mathfrak{q}^\perp$ satisfying $\ker(\text{ad } f)^2 = \mathfrak{q}$ are called *regular*. Equivalently, $(\text{ad } f)^2$ factors to an isomorphism $F_f : \mathfrak{h}/\mathfrak{q} \rightarrow \mathfrak{q}^\perp$. With notation as in Proposition 7.6(3), we immediately see that $F_f(e) = [f, [f, e]] = -[f, 2\xi] = -2f$ and hence $e = -2F_f^{-1}(f)$.

7.1.3 General definition

A symmetric R-space $H \cdot \mathfrak{q}$ induces an R-space of smaller dimension using the projective embeddings of Subsection 2.1.4. For this, let $\mathfrak{q}^0 := \mathfrak{q}/\mathfrak{q}^\perp$ be the reductive Levi factor of \mathfrak{q} , and let $\mathbb{W} := \mathfrak{h}/\mathfrak{q}$. We may decompose \mathfrak{q}^0 into its semisimple part $\mathfrak{g} := [\mathfrak{q}^0, \mathfrak{q}^0]$ and centre $\mathfrak{z}(\mathfrak{q}^0)$, whose dimension equals the number of simple factors of \mathfrak{h} by Lemma 2.6. Since \mathfrak{q} is a subalgebra of \mathfrak{h} , the adjoint representation of \mathfrak{h} induces a representation of \mathfrak{q} on \mathbb{W} via $y \cdot (x + \mathfrak{q}) = [y, x] + \mathfrak{q}$. Since $[\mathfrak{q}^\perp, \mathfrak{h}] = \mathfrak{q}$ by Lemma 2.13, the action of \mathfrak{q} on $\mathbb{W} = \mathfrak{h}/\mathfrak{q}$ descends to an action $\mathfrak{q}^0 := \mathfrak{q}/\mathfrak{q}^\perp$, thus defining a representation of \mathfrak{g} on \mathbb{W} . There is an R-space $G \cdot \mathfrak{p}$ associated to both of the projective embeddings $G \cdot \mathfrak{p} \hookrightarrow \mathbb{P}(\mathbb{W})$ and $G \cdot \mathfrak{p} \hookrightarrow \mathbb{P}(\mathbb{W}^*)$, given respectively by crossing the nodes on which the highest weights of \mathbb{W}^* and \mathbb{W} are supported. We take this “top down” view of $H \cdot \mathfrak{q}$ and $G \cdot \mathfrak{p}$ for our general definition.

Definition 7.7. Let $H \cdot \mathfrak{q}$ be a symmetric R-space with infinitesimal isotropy representation $\mathbb{W} := \mathfrak{h}/\mathfrak{q}$.

- (1) The R-space $G \cdot \mathfrak{p} \hookrightarrow \mathbb{P}(\mathbb{W})$ will be called the *isotropy R-space* of $H \cdot \mathfrak{q}$.
- (2) A *projective parabolic geometry* is a parabolic geometry modelled on the isotropy R-space of a self-dual symmetric R-space.

Recall that for the classical projective structures the R-space $G \cdot \mathfrak{p}$ is abelian, with the \mathfrak{p}^\perp -filtration of \mathbb{W} of height two. These are not *a priori* true for a general projective parabolic geometry, and establishing these properties will be the focus of Section 7.2.

For later use, we record the following method [60, Prop. 3.2.2] for determining the Dynkin (or Satake) diagram of \mathfrak{g} from that of $H \cdot \mathfrak{q}$.

Proposition 7.8. *Let $H \cdot \mathfrak{q}$ be a symmetric R-space. Then the Satake diagram of \mathfrak{g} is given by removing all crossed nodes from \mathfrak{q} and their associated edges.*

Proof. It suffices to consider the case that \mathfrak{h} is complex, so choose a Cartan subalgebra $\mathfrak{t} \leq \mathfrak{h}$ and a simple subsystem Δ^0 with respect to which \mathfrak{q} is the standard parabolic corresponding to a subset $\Sigma \subseteq \Delta^0$. These choices induce an algebraic Weyl structure of \mathfrak{q} , identifying \mathfrak{g} with a subalgebra of \mathfrak{h} . By Lemma 2.6 we know that $\Delta^0 \setminus \Sigma$ forms a simple subsystem for \mathfrak{g} , so it remains to describe the Cartan matrix.

Suppose first that $\alpha, \beta \in \Delta^0 \setminus \Sigma$ lie in different simple factors of \mathfrak{g} . Then α, β are orthogonal with respect to the Killing form of \mathfrak{g} . On the other hand, since $[\mathfrak{h}_\alpha, \mathfrak{h}_\beta] = 0$ we cannot have $\alpha + \beta$ as a root of \mathfrak{h} . But $\alpha - \beta$ is also not a root, so by considering the α -root string through β we see that $\langle \alpha, \beta \rangle = 0$ in \mathfrak{h} .

Suppose now that α, β lie in the same simple factor of \mathfrak{g} . Since the Killing form of \mathfrak{g} is determined uniquely up to scale on each simple factor, it must coincide with the

restriction of the Killing form of \mathfrak{h} . Thus the Cartan integers with respect to \mathfrak{g} coincide with the Cartan integers with respect to \mathfrak{h} . \square

Since Proposition 7.8 will form the basis of our classification, we give an example.

Example 7.9. (1) Let $\mathfrak{h} = \mathfrak{e}_6(\mathbb{C})$ and consider its R-space

$$H \cdot \mathfrak{q} := \begin{array}{c} \circ - \circ - \circ - \circ - \times \\ | \\ \circ \end{array} \hookrightarrow \mathbb{P}(\mathbb{C}_{27}),$$

where \mathbb{C}_{27} is the 27-dimensional representation of $\mathfrak{e}_6(\mathbb{C})$. The longest element of \mathfrak{h} induces the usual automorphism of the Dynkin diagram, so that $H \cdot \mathfrak{q}$ is not self-dual by Lemma 7.4. Nevertheless, Proposition 7.8 tells us that the Dynkin type of the semisimple part \mathfrak{g} of \mathfrak{q}^0 is

$$\mathfrak{g} = \begin{array}{c} \circ - \circ - \circ \\ \diagup \quad \diagdown \\ \circ \quad \circ \end{array} = \mathfrak{so}(10, \mathbb{C}).$$

(2) By way of consistency with the classical projective structures, the reader can check that for $\mathfrak{h} = \mathfrak{sp}(2n+2, \mathbb{R})$ we obtain $\mathfrak{g} = \mathfrak{sl}(n+1, \mathbb{R})$; for $\mathfrak{h} = \mathfrak{su}(n+1, n+1)$ we obtain $\mathfrak{g} = \mathfrak{sl}(n+1, \mathbb{C})$; and for $\mathfrak{h} = \mathfrak{so}^*(4n+4)$ we obtain $\mathfrak{g} = \mathfrak{sl}(n+1, \mathbb{H})$.

7.2 Algebraic structure

Fix a self-dual symmetric R-space $H \cdot \mathfrak{q}$ with infinitesimal isotropy representation $\mathbb{W} := \mathfrak{h}/\mathfrak{q}$ and isotropy R-space $G \cdot \mathfrak{p}$. Our goal in this section is to investigate the algebraic structure of a projective parabolic geometry in more detail. Indeed, we do not yet know whether $G \cdot \mathfrak{p}$ consists of abelian parabolics as in the classical cases, or the structure of \mathbb{W} . It suffices to consider the case that \mathfrak{h} is simple by the following [60, Lem. 3.2.3].

Lemma 7.10. *Let \mathfrak{h} be semisimple with abelian parabolic \mathfrak{q} , such that with respect to any algebraic Weyl structure no simple ideal of \mathfrak{h} is contained in \mathfrak{q}^0 . Then each simple factor of \mathfrak{h} has an abelian parabolic, such that \mathfrak{q} is the direct sum of these parabolics. \square*

The key step in the determination of the algebraic structures of \mathfrak{g} and \mathbb{W} is the relationship between self-dual symmetric R-spaces and Jordan algebras, which we describe in Subsection 7.2.1. In Subsection 7.2.2 we show that the structure found for the classical cases carries over in almost every detail; in particular, we see in Subsection 7.2.3 that this gives \mathfrak{h} the structure of a \mathbb{Z}^2 -graded algebra, which allows us to determine Lie brackets between many of its summands. Finally, in Subsection 7.2.4 we study a 1-dimensional representation L parametrising the space of Weyl connections, which also provides key information regarding traces of certain Lie brackets.

7.2.1 Relation to Jordan algebras

We shall see that the algebraic structure of \mathbb{W} is neatly described in terms of Jordan algebras. Fix a field \mathbb{k} , which for us will be \mathbb{R} or \mathbb{C} .

Definition 7.11. A *Jordan algebra* over \mathbb{k} is a commutative (but non-associative) \mathbb{k} -algebra (\mathbb{J}, \circ) satisfying the *Jordan identity*

$$(x \circ y) \circ (x \circ x) = x \circ (y \circ (x \circ x)) \quad (7.4)$$

for all $x, y \in \mathbb{J}$. The Jordan identity implies that \mathbb{J} is “power associative”, meaning that $(x^m \circ y) \circ x^n = x^m \circ (y \circ x^n)$ for all $x, y \in \mathbb{J}$ and $m, n \in \mathbb{Z}_{>0}$.

Example 7.12. Given any associative \mathbb{k} -algebra \mathbb{J} , it can be given the structure of a Jordan algebra via $x \circ y := \frac{1}{2}(xy + yx)$, where juxtaposition denotes the original multiplication in \mathbb{J} . Jordan algebras obtained in this way are called *special*.

Jordan algebras were introduced by Jordan [106] as an algebraic framework for the system of observable quantities in quantum mechanics. A detailed history of Jordan algebras and their role in physics may be found in McCrimmon’s excellent book [142]. Our interaction with Jordan algebras shall be limited to the close relationship between self-dual symmetric R-spaces and Jordan algebras, where we will almost exclusively favour Lie-theoretic language. By Proposition 7.6, self-duality is equivalent to the existence of a regular element $f \in \mathfrak{q}^\perp$ with $F_f := (\text{ad } f)^2 : \mathfrak{h}/\mathfrak{q} \rightarrow \mathfrak{q}^\perp$ an isomorphism.

Theorem 7.13 (Meyberg). *Suppose that $H \cdot \mathfrak{q}$ is a self-dual symmetric R-space and choose an algebraic Weyl structure $\xi^\mathfrak{q}$. Let $f \in \mathbb{W} := \mathfrak{h}/\mathfrak{q}$ be a regular element with corresponding isomorphism $F_f := (\text{ad } f)^2 : \mathbb{W} \rightarrow \mathbb{W}^*$. Then*

$$x \circ y := \frac{1}{2}[[x, f], y]$$

makes (\mathbb{W}, \circ) into a semisimple Jordan algebra with identity element $e := -2F_f^{-1}(f)$.

Sketch proof. Since $\mathbb{W} \leq \mathfrak{h}$ is an abelian subalgebra with respect to the algebraic Weyl structure, commutativity of \circ follows immediately from the Jacobi identity. The Jordan identity (7.4) follows by a direct calculation via the Jacobi identity which we omit; see [143]. To see that e is a unit for \circ , note that $e = -2F_f^{-1}(f)$ is the element from Proposition 7.6(3) which satisfies $[e, f] = 2\xi^\mathfrak{q}$. Therefore $e \circ x = \frac{1}{2}[[e, f], x] = [\xi^\mathfrak{q}, x] = x$ for all $x \in \mathbb{W}$ as required. \square

Further details may be found in [118, 130, 143]; see also [27, §1.4] and [28, §7]. Dually, \mathbb{W}^* becomes a unital semisimple Jordan algebra with product $\alpha \circ \beta := \frac{1}{2}[[\alpha, e], \beta]$

for all $\alpha, \beta \in \mathbb{W}^*$. The \mathfrak{sl}_2 -triple $(e, [e, f], f)$ integrates to a group homomorphism $\varphi : \mathrm{SL}(2, \mathbb{C}) \rightarrow H$ such that the adjoint action of $\varphi \left(\begin{bmatrix} 0 & 1 \\ -1 & 0 \end{bmatrix} \right)$ induces an isomorphism of Jordan algebras between \mathbb{W} and \mathbb{W}^* ; see [115, §2]. Of course, the regular element $f \in \mathbb{W}^*$ need not be unique. Jordan products induced by different regular elements correspond to different *isotopes* of \mathbb{W} ; see [142].

Remark 7.14. Following work of Tits [174], Koecher [116, 117] and Meyberg [143], a Jordan algebra (\mathbb{W}, \circ) can conversely be embedded into a semisimple Lie algebra \mathfrak{h} as follows. By defining

$$\{x, y, z\} := (x \circ y) \circ z - y \circ (x \circ z) + x \circ (y \circ z),$$

we give $(\mathbb{W}, \{\cdot, \cdot, \cdot\})$ the structure of a *Jordan triple system*, meaning that $\{\cdot, \cdot, \cdot\}$ is symmetric in the last two entries and $L_{x,y} : \mathbb{W} \rightarrow \mathbb{W}$ defined by $L_{x,y}(z) := \{x, y, z\}$ satisfies $[L_{x,y}, L_{z,w}] = L_{z, \{x,y,w\}} - L_{\{y,x,z\}, w}$. The space $\mathfrak{der}(\mathbb{W}) := \{L_{x,y} \mid x, y \in \mathbb{W}\}$ is then a Lie algebra under commutator, acting naturally on \mathbb{W} and \mathbb{W}^* in the obvious way. If the trace form $\langle x, y \rangle := \mathrm{tr}(L_{x,y})$ is non-degenerate, the direct sum

$$\mathfrak{h} := \mathbb{W} \oplus \mathfrak{der}(\mathbb{W}) \oplus \mathbb{W}^*$$

is a graded semisimple Lie algebra with the brackets

$$[x, \alpha] = L_{x,\alpha}, \quad [x, y] = 0 = [\alpha, \beta], \quad [A, x] = Ax \quad \text{and} \quad [A, \alpha] = -\alpha \circ A,$$

called the *Kantor–Koecher–Tits algebra* of \mathbb{W} ; see [28, 68] and the references therein.

An element e in a Jordan algebra (\mathbb{J}, \circ) is called an *idempotent* if $e \circ e = e$. Given multiple idempotents e_1, \dots, e_n , they are *orthogonal* if $e_i \circ e_j = \delta_{ij} e_i$ for all i, j . As for commutative rings, there is a *Peirce decomposition* of \mathbb{J} defined as follows. Denote by $m_e : \mathbb{J} \rightarrow \mathbb{J}$ the multiplication map by $e \in \mathbb{J}$. Then if e is idempotent, Albert proves [3, Eqn. (13)] that m_e has minimal polynomial

$$\frac{1}{2} m_e (2m_e - \mathrm{id})(m_e - \mathrm{id}),$$

i.e. m_e has eigenvalues 0, 1/2 and 1. Denoting the eigenspaces by $\mathbb{J}_e(\lambda)$, it follows that $\mathbb{J}_e(0)$ and $\mathbb{J}_e(1)$ are mutually orthogonal Jordan subalgebras of \mathbb{J} , while [3, Thm. 6]

$$\begin{aligned} \mathbb{J}_e(1/2) \circ \mathbb{J}_e(1/2) &\leq \mathbb{J}_e(0) \oplus \mathbb{J}_e(1), & \mathbb{J}_e(1) \circ \mathbb{J}_e(1/2) &\leq \mathbb{J}_e(1/2) \\ \text{and } \mathbb{J}_e(0) \circ \mathbb{J}_e(1/2) &\leq \mathbb{J}_e(1/2). \end{aligned} \tag{7.5}$$

On the other hand, if e_1, e_2 are orthogonal idempotents of \mathbb{J} then one finds that $(a \circ e_1) \circ e_2 = (a \circ e_2) \circ e_1$ for all $a \in \mathbb{J}$, which lies in the intersection $\mathbb{J}_{e_1}(1/2) \cap \mathbb{J}_{e_2}(1/2)$.

Suppose now that $\{e_1, \dots, e_n\}$ is a set of idempotents for which $e_1 + \dots + e_n = e$ is the identity in \mathbb{J} , and write $\mathbb{J}_i := \mathbb{J}_{e_i}(1)$ and $\mathbb{J}_{ij} := \mathbb{J}_{e_i}(1/2) \cap \mathbb{J}_{e_j}(1/2)$ for all $i \neq j$. Then \mathbb{J}_i is a 1-dimensional vector space, spanned by e_i , while the \mathbb{J}_{ij} are non-empty by the above.

Theorem 7.15. *Suppose that (\mathbb{J}, \circ) is a Jordan algebra with unit $e \in \mathbb{J}$, and let $e_1, \dots, e_n \in \mathbb{J}$ be pairwise orthogonal idempotents satisfying $e_1 + \dots + e_n = e$. Then there is a Peirce decomposition*

$$\mathbb{J} = \bigoplus_{i=1}^n \left(\mathbb{J}_i \oplus \bigoplus_{j>i} \mathbb{J}_{ij} \right),$$

where $\mathbb{J}_i := \mathbb{J}_{e_i}(1)$ and $\mathbb{J}_{ij} := \mathbb{J}_{e_i}(1/2) \cap \mathbb{J}_{e_j}(1/2)$ for $i \neq j$. □

The Peirce decomposition was first considered by Jordan, von Neumann and Wigner in the seminal paper [107] for so-called “totally real” Jordan algebras. The general case was developed by Albert [3, p. 559]. For later use, (7.5) and the Peirce decomposition allow us to prove the following multiplication properties for the eigenspaces [3, Thm. 12].

Corollary 7.16. *The idempotent eigenspaces satisfy*

$$\begin{aligned} \mathbb{J}_i \circ \mathbb{J}_i &\leq \mathbb{J}_i, & \mathbb{J}_i \circ \mathbb{J}_{ij} &\leq \mathbb{J}_{ij}, & \mathbb{J}_i \circ \mathbb{J}_j &= \mathbb{J}_{ij} \circ \mathbb{J}_{kl} = 0, \\ \mathbb{J}_{ij} \circ \mathbb{J}_{jk} &\leq \mathbb{J}_{ik} & \text{and} & & \mathbb{J}_{ij} \circ \mathbb{J}_{ij} &\leq \mathbb{J}_i \oplus \mathbb{J}_j \end{aligned}$$

for all distinct indices i, j, k, ℓ . □

The Peirce decomposition provides the crucial structural step in analysing the algebraic structure of the isotropy R-space $G \cdot \mathfrak{p}$; this is the subject of the next subsection.

7.2.2 Structure of \mathfrak{g} and \mathbb{W}

The aim of this subsection is to describe the structure of $G \cdot \mathfrak{p}$ and the \mathfrak{g} -representation \mathbb{W} . This is done in the following.

Theorem 7.17. *Let $H \cdot \mathfrak{q}$ be a self-dual symmetric R-space with infinitesimal isotropy representation $\mathbb{W} := \mathfrak{h}/\mathfrak{q}$ and isotropy R-space $G \cdot \mathfrak{p}$. Then:*

- (1) $G \cdot \mathfrak{p}$ is a symmetric R-space; and
- (2) The \mathfrak{p}^\perp -filtration of the \mathfrak{g} -representation \mathbb{W} induced by $\mathfrak{h}/\mathfrak{q}$ has height two.

The proof of Theorem 7.17 will require some preliminary work involving the structure theory of \mathfrak{h} and \mathfrak{g} , as well as their parabolic subalgebras \mathfrak{q} and \mathfrak{p} . It suffices to

see that both \mathfrak{g} and \mathbb{W} decompose into a direct sum of three eigenspaces with respect to an algebraic Weyl structure for \mathfrak{p} . The graded properties of \mathfrak{g} and \mathbb{W} are clearly unchanged by complexification, so we may assume that $H \cdot \mathfrak{q}$ is complex. Moreover by Lemma 7.10, it suffices to consider the case when \mathfrak{h} is simple.

Remark 7.18. Using the classification of symmetric R-spaces [22], one can easily check that Theorem 7.17 does not require that $H \cdot \mathfrak{q}$ is self-dual. F. Burstall has recently provided a much simpler proof than the one presented here, that benefits from not requiring self-duality.

Choose algebraic Weyl structures $\xi^{\mathfrak{q}} \in \mathfrak{z}(\mathfrak{q}^0)$ for $\mathfrak{q} \leq \mathfrak{h}$ and $\xi^{\mathfrak{p}} \in \mathfrak{z}(\mathfrak{p}^0)$ for $\mathfrak{p} \leq \mathfrak{g}$. Then $\xi^{\mathfrak{q}}$ and $\xi^{\mathfrak{p}}$ are linearly independent, since otherwise $\xi^{\mathfrak{p}}$ would act trivially on the whole of \mathfrak{g} , implying that $\xi^{\mathfrak{p}} = 0$. As in Lemma 2.6, we can extend $\{\xi^{\mathfrak{q}}, \xi^{\mathfrak{p}}\}$ to a basis for a Cartan subalgebra \mathfrak{t} with root system $\Delta \subset \mathfrak{t}^*$ and positive subsystem $\Delta^+ \subset \Delta$ of \mathfrak{h} . This identifies \mathfrak{q} and \mathfrak{p} with standard parabolic subalgebras of \mathfrak{h} and \mathfrak{g} . Evidently any two such Cartan subalgebras are conjugate by the action of P^0 ; since P^0 preserves the graded structure of \mathfrak{g} and \mathbb{W} , the choice of \mathfrak{t} is inconsequential for our purposes.

Convention 7.19. We normalise the Killing form of \mathfrak{h} so that $\langle \alpha, \alpha \rangle = 2$ for all long roots $\alpha \in \Delta \subset \mathfrak{t}^*$.

Let $\Delta^0 \subset \Delta^+$ be the set of simple roots and let $\beta \in \mathfrak{t}^*$ be the corresponding highest root of \mathfrak{h} . It is well-known that β is a long root, whence $\langle \beta, \beta \rangle = 2$ by Convention 7.19. Since \mathfrak{h} is simple, \mathfrak{q} is the standard parabolic given by crossing a single simple root $\alpha_r \in \Delta^0$. Writing $\beta = \sum_i n_i \alpha_i$ as a sum of simple roots, by assumption we have $\text{ht}_{\mathfrak{q}}(\beta) = n_r = 1$; equivalently, $\beta(\xi_r) = 1$ for $\xi_1, \dots, \xi_\ell \in \mathfrak{t}$ dual to $\alpha_1, \dots, \alpha_\ell \in \Delta^0$.

As in the discussion following Lemma 2.12, the algebraic Weyl structure $\xi^{\mathfrak{q}}$ provides an isomorphism $\mathfrak{h} \cong \mathbb{W} \oplus \mathfrak{q}^0 \oplus \mathbb{W}^*$, with the grading given by \mathfrak{q} -height. In particular $\text{ht}_{\mathfrak{q}}(\alpha) \in \{+1, 0, -1\}$ for all $\alpha \in \Delta$, with $\text{ht}_{\mathfrak{q}}(\beta) = 1$ and therefore $\mathfrak{h}_{\beta} \leq \mathbb{W}$.

Lemma 7.20. [45, Lem. 3.7]. α_r is a long root.

Proof. Consider the dual root system Δ^* , consisting of roots $\alpha^* := \frac{2}{\langle \alpha, \alpha \rangle} \alpha$ for $\alpha \in \Delta$. A simple subsystem for Δ^* is then given by the duals α_i^* of the simple roots $\alpha_i \in \Delta^0$. Write the highest root $\beta = \sum_i n_i \alpha_i \in \Delta$. Therefore

$$\beta^* = \frac{2}{\langle \beta, \beta \rangle} \beta = \sum_i \frac{2}{\langle \alpha_i, \alpha_i \rangle} \frac{n_i \langle \alpha_i, \alpha_i \rangle}{\langle \beta, \beta \rangle} \alpha_i = \sum_i \frac{n_i \langle \alpha_i, \alpha_i \rangle}{\langle \beta, \beta \rangle} \alpha_i^*,$$

so that the $n_i \frac{\langle \alpha_i, \alpha_i \rangle}{\langle \beta, \beta \rangle}$ are integers. However by assumption we have $\text{ht}_{\mathfrak{q}}(\beta) = n_r = 1$, so that we necessarily have α_r long. \square

Consider the fundamental weight ω_r corresponding to α_r . Then if $\alpha = \sum_i n_i \alpha_i \in \Delta$ is any root, $\langle \omega_r, \alpha \rangle = \sum_i n_i \langle \omega_r, \alpha_i \rangle = \frac{1}{2} n_r \langle \alpha_r, \alpha_r \rangle = n_r = \text{ht}_{\mathfrak{q}}(\alpha)$. Therefore the \mathfrak{q} -height is given by the inner product with ω_r .

Recall that roots $\alpha, \beta \in \Delta$ are *strongly orthogonal* if neither of $\alpha \pm \beta$ are roots. In particular, strongly orthogonal roots α, β generate commuting \mathfrak{sl}_2 -triples [1].

Lemma 7.21. *Roots $\alpha, \beta \in \Delta$ of \mathfrak{q} -height one are strongly orthogonal if and only if they are orthogonal.*

Proof. It is well-known that strong orthogonality implies orthogonality: indeed, if neither of $\alpha \pm \beta$ are roots then the β -root string through α consists solely of α , so we must have $\langle \alpha, \beta \rangle = 0$. Conversely, suppose that α, β are orthogonal. Then $\alpha + \beta$ cannot be a root since it would have \mathfrak{q} -height two; the β -root string through α then consists solely of α again, from which $\langle \alpha, \beta \rangle = 0$ implies that $\alpha - \beta$ is not a root either. \square

We are going to construct a maximal sequence $(\beta_n, \dots, \beta_0)$ of orthogonal long roots of \mathfrak{q} -height one. We will fix a particular sequence shortly; for now, take $(\beta_n, \dots, \beta_0)$ to be any maximal sequence of such roots. In particular, the β_i are mutually strongly orthogonal by Lemma 7.21 and satisfy $\langle \beta_i, \beta_j \rangle = 2\delta_{ij}$.

Assumption 7.22. We assume henceforth that $n > 0$.

We will interpret this later as excluding projective parabolic geometries over zero-dimensional manifolds; in the mean time, the reader may consult the tables in [1, §3–5] for reassurance. To construct our particular choice of $(\beta_n, \dots, \beta_0)$, we need the following lemma from [159, §2]; we shall need details from the proof, so include it for the reader's convenience. Let $\mathcal{W}_{\mathfrak{g}}$ be the Weyl group of \mathfrak{g} , viewed as a subgroup of the Weyl group $\mathcal{W}_{\mathfrak{h}}$ of \mathfrak{h} via the algebraic Weyl structure $\xi^{\mathfrak{q}}$.

Lemma 7.23. *Let $\mathcal{W}_{\mathfrak{g}}$ be the Weyl group of \mathfrak{g} . Then:*

- (1) $\mathcal{W}_{\mathfrak{g}}$ acts transitively on the set of \mathfrak{q} -height one long roots.
- (2) For each $n \geq 0$, $\mathcal{W}_{\mathfrak{g}}$ acts transitively on all orthogonal sequences $(\beta_n, \dots, \beta_0)$ of \mathfrak{q} -height one roots of a fixed length.
- (3) Every maximal orthogonal sequence of \mathfrak{q} -height one long roots has the same length.

Proof. (1) This is a special case of [159, Lem. 2.6]. Let $\alpha \in \Delta^0 \setminus \{\alpha_r\}$ be a \mathfrak{q} -height zero simple root. Then for any $\beta \in \Delta$ with $\text{ht}_{\mathfrak{q}}(\beta) = 1$, we have

$$\langle \sigma_{\alpha}(\beta), \omega_r \rangle = \langle \beta - \frac{2\langle \beta, \alpha \rangle}{\langle \alpha, \alpha \rangle} \alpha, \omega_r \rangle = \langle \beta, \omega_r \rangle - \frac{2\langle \beta, \alpha \rangle}{\langle \alpha, \alpha \rangle} \langle \alpha, \omega_r \rangle = 1,$$

so that $\sigma_{\alpha}(\beta)$ is also of \mathfrak{q} -height one. Since these simple reflections generate the Weyl group $\mathcal{W}_{\mathfrak{g}}$ of \mathfrak{g} (viewed as a subgroup of $\mathcal{W}_{\mathfrak{h}}$), it follows that $\mathcal{W}_{\mathfrak{g}}$ preserves the set

of \mathfrak{q} -height one roots. Now consider two orbits, represented by roots β, β' which we suppose are chosen to be maximal with respect to the root partial ordering. Then for any $\alpha \in \Delta^0 \setminus \{\alpha_r\}$ we have that $\sigma_\alpha(\beta) = \beta - \frac{2\langle\beta, \alpha\rangle}{\langle\alpha, \alpha\rangle}\alpha$ is a root of \mathfrak{q} -height one, so that $\langle\beta, \alpha\rangle \geq 0$ by maximality of β within its orbit. Moreover $\langle\beta, \alpha_r\rangle \geq 0$ since otherwise $\sigma_{\alpha_r}(\beta) = \beta + \alpha_r$ would be a root of \mathfrak{q} -height two. Therefore $\langle\beta, \alpha\rangle \geq 0$ for all $\alpha \in \Delta^0$, so that β is dominant. Similarly β' is dominant; but there is a unique dominant long root, so that the two orbits must coincide.

(2) This is [159, Prop. 2.8]. By (1) we may conjugate the sequence by an element of $\mathcal{W}_{\mathfrak{g}}$ and assume that $\beta_n = \beta$, the highest root of \mathfrak{h} . If $\langle\beta_n, \alpha_r\rangle \neq 0$ then since $\beta_n + \alpha_r$ is not a root, we must have $\langle\beta_n, \alpha_r\rangle > 0$. Since β_n is a dominant weight for \mathfrak{h} , it is a non-negative integral linear combination of the fundamental weights. Then $\langle\beta_n, \alpha_r\rangle > 0$ implies that the coefficient of ω_r is positive, so that $\langle\beta_n, \alpha\rangle > 0$ for all positive roots $\alpha \in \Delta^+$. However any root of \mathfrak{q} -height one is necessary positive, having a coefficient one of the simple root α_r , so since $\langle\beta_n, \beta_{n-1}\rangle = 0$ we must have $\langle\beta_n, \alpha_r\rangle = 0$.

Now α_r and the remaining β_i lie in the root subsystem $\langle\beta_n\rangle^\perp \subset \Delta$. Although this may not be irreducible, its irreducible component containing α_r also contains the remaining β_i since they have \mathfrak{q} -height one. Writing Δ_0 for the roots of \mathfrak{g} , the Weyl group of $\Delta_0 \cap \langle\beta_n\rangle^\perp$, viewed as a subgroup of $\mathcal{W}_{\mathfrak{g}}$, acts transitively on the \mathfrak{q} -height one roots in $\langle\beta_n\rangle^\perp$. Therefore we may assume that β_{n-1} is the highest root of the irreducible component of $\langle\beta_n\rangle^\perp$ containing α_r . Proceeding inductively, we see that $\mathcal{W}_{\mathfrak{g}}$ acts transitively as required.

(3) This follows immediately from (2). □

We may therefore assume that our maximal sequence $(\beta_n, \dots, \beta_0)$ is constructed as follows: $\beta_n = \beta$, the highest root of \mathfrak{h} , and we inductively define β_i to be the highest root of the irreducible component of $\langle\beta_n, \dots, \beta_{i+1}\rangle^\perp$ containing α_r . This construction is familiar in the context of hermitian symmetric spaces [183, Eqn. (3.2)], and apparently is originally due to Harish-Chandra.

Lemma 7.24. $\beta_0 = \alpha_r$.

Proof. Since $H \cdot \mathfrak{q}$ is self-dual, the standard parabolic \mathfrak{q} is conjugate to the standard opposite parabolic $\hat{\mathfrak{q}}$, which occurs if and only if the corresponding parabolic normalisers $Q := N_H(\mathfrak{q})$ and $\hat{Q} := N_H(\hat{\mathfrak{q}})$ of H are conjugate. There is a natural isomorphism of the Weyl group $\mathcal{W}_{\mathfrak{h}}$ of \mathfrak{h} with the quotient $N_H(\mathfrak{t})/Z_H(\mathfrak{t})$ of the adjoint normaliser of the Cartan subalgebra \mathfrak{t} by the centraliser of \mathfrak{t} [60, Thm. 3.2.19(1)], and it follows from the Bruhat decomposition [158, §6.4] that Q, \hat{Q} are in fact conjugate by an element $w \in \mathcal{W}_{\mathfrak{h}}$; see Remark 7.25(2) below. It is proved in [159, Prop. 3.12] that we may take

w to be the element $w_n := \sigma_{\beta_0} \circ \cdots \circ \sigma_{\beta_n}$. In particular, w_n takes roots of \mathfrak{q} -height $k \in \{+1, 0, -1\}$ to roots of \mathfrak{q} -height $-k$.

Since $\alpha_r \leq \beta_0$ in the root partial ordering, if $\beta_0 \neq \alpha_r$ then maximality of the sequence $(\beta_n, \dots, \beta_0)$ implies that $\langle \alpha_r, \beta_0 \rangle \neq 0$. We must then have $\langle \alpha_r, \beta_0 \rangle > 0$, since $\beta_0 + \alpha_r$ is not a root. Therefore the Cartan integer $\langle \alpha_r, \beta_0 \rangle = 1$; indeed, $\langle \alpha_r, \beta_0 \rangle \in \{1, 2\}$ and $\langle \alpha_r, \beta_0 \rangle = 2$ would imply that $\beta_0 = \alpha_r$ by the Cauchy–Schwarz inequality. In particular, $\sigma_{\alpha_r}(\beta_0) = \beta_0 - \alpha_r$ is a positive root of \mathfrak{q} -height zero. Since $\langle \alpha_r, \beta_i \rangle = 0$ for $i > 0$ by construction, it follows that

$$w_n(\alpha_r) := \alpha_r - \sum_{i=0}^n \langle \beta_i, \alpha_r \rangle \beta_i = \alpha_r - \beta_0,$$

so that w_n takes a root of \mathfrak{q} -height one to a root of \mathfrak{q} -height zero. But this contradicts self-duality of $H \cdot \mathfrak{q}$ by the first paragraph, implying that $\beta_0 = \alpha_r$ as required. \square

Remark 7.25. (1) One can check that $\beta_0 \neq \alpha_r$ when $H \cdot \mathfrak{q}$ is not self-dual. As an example, crossing node $k \leq n + 1$ in $\mathfrak{sl}(2n + 2, \mathbb{C})$ yields a maximal orthogonal sequence given by $\beta_i = \alpha_{k-i} + \cdots + \alpha_{2n+2-k+i}$ for $i = k - 1, \dots, 0$. In particular, $\beta_0 = \alpha_k + \cdots + \alpha_{2n+2-k} \neq \alpha_k$ unless $k = n + 1$, *i.e.* unless we cross the central node.

(2) More carefully, it suffices to see that w and w_n lie in the same coset of the Cartan subgroup $Z_H(\mathfrak{t})$ in $\mathcal{W}_{\mathfrak{h}} \cong N_H(\mathfrak{t})/Z_H(\mathfrak{t})$. This is because elements of $Z_H(\mathfrak{t})$ act on H preserving the grading, thus having no effect on the conjugacy between Q and \hat{Q} .

Choose an \mathfrak{sl}_2 -triple $\{e_i, h_i, f_i\}$ corresponding to each β_i , where $e_i \in \mathfrak{h}_{\beta_i} \leq \mathbb{W}$, $f_i \in \mathfrak{h}_{-\beta_i} \leq \mathbb{W}^*$ and $h_i := [e_i, f_i] \in \mathfrak{t}$. By Convention 7.19, the corresponding co-root is $\beta_i^\vee := \frac{2}{\langle \beta_i, \beta_i \rangle} h_i = h_i$. Moreover since the β_i are strongly orthogonal, we have $[e_i, f_j] = \delta_{ij} h_i$ for all i, j . It follows that

$$e := \sum_{i=0}^n e_i \in \mathbb{W}, \quad f := \sum_{i=0}^n f_i \in \mathbb{W}^*, \quad \text{and} \quad h := \sum_{i=0}^n h_i \in \mathfrak{t}$$

satisfies $h = [e, f]$ and hence $\{e, h, f\}$ is also an \mathfrak{sl}_2 -triple for \mathfrak{h} . Thus the $\{e_i, h_i, f_i\}$ generate commuting subalgebras isomorphic to $\mathfrak{sl}(2, \mathbb{C})$, with the subalgebra generated by $\{e, h, f\}$ the diagonal subalgebra in their direct sum.

Lemma 7.26. $F_f := (\text{ad } f)^2 : \mathbb{W} \rightarrow \mathbb{W}^*$ is a linear isomorphism.

Proof. We will show that the linear map $\frac{1}{4}(\text{ad } e)^2 : \mathbb{W}^* \rightarrow \mathbb{W}$ is inverse to F_f . For $\alpha \in \Delta$ a root of \mathfrak{q} -height one and all $x \in \mathfrak{h}_\alpha \leq \mathbb{W}$, the Jacobi identity yields

$$\begin{aligned} (\text{ad } e)^2(\text{ad } f)^2(x) &= [e, [e, [f, [f, x]]]] \\ &= [e, [h, [f, x]]] + [e, [f, [h, x]]] \end{aligned}$$

$$\begin{aligned}
&= -2[e, [f, x]] + 2[h, [h, x]] \\
&= -2[h, x] + 2[h, [h, x]] \\
&= 2\alpha(h)(\alpha(h) - 1)x.
\end{aligned} \tag{7.6}$$

Since $\langle \beta_i, \beta_j \rangle = 2\delta_{ij}$, the root reflections σ_{β_i} through β_i mutually commute and hence

$$w_n(\alpha) := (\sigma_{\beta_0} \circ \cdots \circ \sigma_{\beta_n})(\alpha) = \alpha - \sum_{i=0}^n \langle \alpha, \beta_i \rangle \beta_i$$

is a root of \mathfrak{q} -height $1 - \sum_{i=0}^n \langle \alpha, \beta_i \rangle \in \{+1, 0, -1\}$. Since the β_i are all long roots, $\langle \alpha, \beta_i \rangle = \frac{2\langle \alpha, \beta_i \rangle}{\langle \beta_i, \beta_i \rangle}$ is integral for all $i = n, \dots, 0$. Therefore either $\langle \alpha, \beta_i \rangle = 2$ for a unique i , with $\langle \alpha, \beta_j \rangle = 0$ for $j \neq i$; or $\langle \alpha, \beta_i \rangle = 1$ for at most two i , with $\langle \alpha, \beta_j \rangle = 0$ otherwise; or $\langle \alpha, \beta_i \rangle = 0$ for all i . The last case cannot occur, since by Lemma 7.24 the root subsystem $\langle \beta_n, \dots, \beta_0 \rangle^\perp \subseteq \langle \alpha_r \rangle^\perp$ contains no roots of \mathfrak{q} -height one. The case where $\langle \alpha, \beta_i \rangle = 1$ for a unique i also cannot occur, since this contradicts self-duality of $H \cdot \mathfrak{q}$ as in the proof of Lemma 7.24. The remaining two cases both give $\alpha(h) = \sum_{i=0}^n \langle \alpha, \beta_i \rangle = 2$, yielding $(\text{ad } e)^2 \circ (\text{ad } f)^2 = 4 \text{ id}$ by (7.6). \square

Note that Lemma 7.26 gives an alternative proof of the implication (1) \Rightarrow (2) from Proposition 7.6. Indeed, we have explicitly constructed a regular element $f \in \mathfrak{q}^\perp$.

Corollary 7.27. $h = [e, f]$ is equal to twice the algebraic Weyl structure $\xi^{\mathfrak{q}}$ of \mathfrak{q} .

Proof. Lemma 7.26 equivalently states that $f \in \mathbb{W}^*$ is a regular element. Since $F_f(e) = [[e, f], f] = [h, f] = -2f$, we obtain that $e = -2F_f^{-1}(f)$ is the corresponding element from Proposition 7.6(3) with $[e, f] = 2\xi^{\mathfrak{q}}$. \square

By Meyberg's Theorem 7.13, the \mathfrak{sl}_2 -triple $\{e, h, f\}$ induces dual Jordan algebra structures on \mathbb{W} and \mathbb{W}^* , defined by

$$x \circ y := \frac{1}{2}[[x, f], y] \quad \text{and} \quad \alpha \circ \beta := \frac{1}{2}[[\alpha, e], \beta]$$

for all $x, y \in \mathbb{W}$ and $\alpha, \beta \in \mathbb{W}^*$. Since we have chosen the β_i with root spaces contained in \mathbb{W} , we shall work predominantly with the Jordan multiplication on \mathbb{W} .

Lemma 7.28. The $e_i \in \mathbb{W}$ are mutually orthogonal Jordan idempotents.

Proof. Lemma 7.21 gives $e_i \circ e_j = \frac{1}{2}[[e_i, f], e_j] = \frac{1}{2}[h_i, e_j] = \delta_{ij}e_i$ for all i, j . \square

By Theorem 7.15 we consequently have a Peirce decomposition¹

$$\mathbb{W} = \bigoplus_{i=0}^n \left(\mathbb{W}_i \oplus \bigoplus_{j>i} \mathbb{W}_{ij} \right), \tag{7.7}$$

¹The idea to utilise the Peirce decomposition and strongly orthogonal roots comes from [115].

where the Jordan eigenspaces are defined by

$$\begin{aligned} \mathbb{W}_i &:= \{x \in \mathbb{W} \mid e_i \circ x = x\} \\ \text{and } \mathbb{W}_{ij} &:= \{x \in \mathbb{W} \mid e_i \circ x = \tfrac{1}{2}x = e_j \circ x\}. \end{aligned} \tag{7.8}$$

In terms of root data, if $x \in \mathfrak{h}_\alpha \leq \mathbb{W}_i$ then $x = e_i \circ x = \frac{1}{2}[h_i, x] = \frac{1}{2}\langle \alpha, \beta_i \rangle x$, giving $\langle \alpha, \beta_i \rangle = 2$ and hence $\alpha = \beta_i$ by the Cauchy–Schwarz inequality. On the other hand for $x \in \mathfrak{h}_\alpha \leq \mathbb{W}_{ij}$, a similar line of argument gives $\langle \alpha, \beta_i \rangle = \langle \alpha, \beta_j \rangle = 1$. Combined with the multiplication properties of Corollary 7.16, it follows that

$$\begin{aligned} \mathbb{W}_i &= \mathfrak{h}_{\beta_i} = \langle e_i \rangle \\ \text{and } \mathbb{W}_{ij} &= \langle \mathfrak{h}_\alpha \mid \langle \beta_i, \alpha \rangle = \langle \beta_j, \alpha \rangle = 1 \text{ and } \langle \beta_k, \alpha \rangle = 0 \ \forall k \neq i, j \rangle. \end{aligned}$$

In particular, \mathbb{W}_i is 1-dimensional spanned by e_i . There is a dual Peirce decomposition $\mathbb{W}^* = \bigoplus_{i=0}^n (\mathbb{W}_i^* \oplus \bigoplus_{j>i} \mathbb{W}_{ij}^*)$ defined in much the same way.

Now we turn to describing the root data of the semisimple part \mathfrak{g} of \mathfrak{q}^0 . The roots of \mathfrak{g} are precisely the roots of \mathfrak{h} of \mathfrak{q} -height zero, with simple subsystem $\Delta^0 \setminus \{\alpha_r\}$. By Lemma 2.6, the corresponding Cartan subalgebra is

$$\mathfrak{t}_0 := \langle \alpha^\vee \mid \alpha \in \Delta^0 \setminus \{\alpha_r\} \rangle = \{H \in \mathfrak{t} \mid \omega_r(H) = 0\}. \tag{7.9}$$

The isotropy R-space $G \cdot \mathfrak{p}$ is, by definition, induced by the stabiliser of the lowest weight orbit in \mathbb{W} . Identifying $\mathbb{W} = \mathfrak{h}/\mathfrak{q} = H_0(\mathfrak{q}^\perp; \mathbb{W})$ using Corollary 2.29, the highest weight of \mathfrak{g} on \mathbb{W} is the restriction $\beta_n|_{\mathfrak{t}_0}$ of the highest root of \mathfrak{h} to \mathfrak{t}_0 . Note that $\beta_n|_{\mathfrak{t}_0} = 0$ if and only if $\langle \beta_n, \alpha \rangle = 0$ for all $\alpha \in \Delta^0 \setminus \{\alpha_r\}$; since $n > 0$, we have $\langle \beta_n, \alpha_r \rangle = 0$ automatically, and thus $\beta_n|_{\mathfrak{t}_0} \neq 0$. Moreover $\alpha_r|_{\mathfrak{t}_0} \neq 0$: the expansion of α_r in fundamental weights is $\alpha_r = 2\omega_r + \sum_{i \neq r} \frac{2\langle \alpha_r, \alpha_i \rangle}{\langle \alpha_i, \alpha_i \rangle} \omega_i$, which has a non-zero coefficient for at least one other ω_i by connectedness of the Dynkin diagram of \mathfrak{h} .

Lemma 7.29. *Let $w_{\mathfrak{g}}$ be the longest element of $\mathcal{W}_{\mathfrak{g}}$. Then $w_{\mathfrak{g}}(\beta_n) = \alpha_r$.*

Proof. Since α_r and β_n are both long roots of \mathfrak{q} -height one, Lemma 7.23(1) provides an element $w \in \mathcal{W}_{\mathfrak{g}}$ such that $w(\beta_n) = \alpha_r$. Then $w \leq w_{\mathfrak{g}}$ in the Bruhat order on $\mathcal{W}_{\mathfrak{g}}$, implying that $\alpha_r = w(\beta_n) \geq w_{\mathfrak{g}}(\beta_n)$ since β_n is dominant. But by definition α_r is the least root of \mathfrak{q} -height one, so that $w_{\mathfrak{g}}(\beta_n) = \alpha_r$ as required. \square

Since the highest weight of the \mathfrak{g} -representation \mathbb{W}^* is $-w_{\mathfrak{g}}(\beta_n|_{\mathfrak{t}_0})$, it follows from Proposition 2.22 that the standard parabolic $\mathfrak{p} \leq \mathfrak{g}$ is associated to the subset

$$\Sigma := \{ \alpha \in \Delta^0 \setminus \{\alpha_r\} \mid \langle \alpha, \alpha_r \rangle \neq 0 \} \subseteq \Delta^0 \tag{7.10}$$

of \mathfrak{q} -height zero simple roots.

As a final ingredient, consider the Lie algebra automorphism $\sigma : \mathfrak{h} \rightarrow \mathfrak{h}$ induced by the \mathfrak{sl}_2 -triple (e_0, h_0, f_0) , defined by

$$\sigma(y) := \exp(e_0) \exp(-f_0) \exp(e_0) \cdot y. \quad (7.11)$$

The inverse is given explicitly by $\sigma^{-1}(y) = \exp(-e_0) \exp(f_0) \exp(-e_0) \cdot y$.

Lemma 7.30. [53, Prop. 2.33] *Consider the automorphism σ defined by (7.11). Then:*

- (1) σ preserves \mathfrak{t} , where it restricts to the root reflection through $\beta_0 = \alpha_r$.
- (2) For every $\alpha \in \Delta$, we have $\sigma(\mathfrak{h}_\alpha) = \mathfrak{h}_{\sigma(\alpha)}$.

Proof. (1) The automorphism σ restricts to the identity on $\ker \beta_0$ and maps \mathfrak{h}_{β_0} to $\mathfrak{h}_{-\beta_0}$, so that $\sigma(H) = H - \beta_0(H)h_0 = \sigma_{\beta_0}(H)$ for all $H \in \mathfrak{t}$.

(2) For all $x \in \mathfrak{h}_\alpha$ and $H \in \mathfrak{t}$ we have

$$\begin{aligned} [H, \sigma(x)] &= \sigma([\sigma^{-1}(H), x]) = \sigma([\sigma(H), x]) \\ &= \sigma(\alpha(\sigma(H))x) = (\sigma(\alpha))(H)\sigma(x), \end{aligned}$$

giving $\sigma(\mathfrak{h}_\alpha) \subseteq \mathfrak{h}_{\sigma(\alpha)}$. Since both root spaces are 1-dimensional and σ is an automorphism, this is an equality. \square

We are finally in a position to prove Theorem 7.17.

Proof of Theorem 7.17. It suffices to describe the eigenspaces of the algebraic Weyl structure $\xi^{\mathfrak{p}}$ of \mathfrak{p} , so our first task is to identify $\xi^{\mathfrak{p}}$. We first calculate how $\sigma(\xi^{\mathfrak{q}}) = 2\sigma(h)$ acts on root spaces \mathfrak{h}_α contained in \mathfrak{g} . Then $\text{ht}_{\mathfrak{q}}(\alpha) = 0$, so we may write $\alpha = \sum_{i \neq r} a_i \alpha_i$ for some $a_i \in \mathbb{Z}$ with the same signs. For all $x \in \mathfrak{h}_\alpha$ we have

$$\begin{aligned} [\sigma(h), x] &= \sigma([h, \sigma^{-1}(x)]) \\ &= \sigma((\sigma^{-1}(\alpha))(h)\sigma^{-1}(x)) \\ &= \alpha(h - 2h_0)x \\ &= \alpha(h)x - 2\sum_{i \neq r} a_i \langle \alpha_r, \alpha_i \rangle x \end{aligned}$$

by Lemma 7.24. The first term here vanishes, since it equals $\alpha(h)x = [h, x] = 2(\text{ht}_{\mathfrak{q}}(\alpha))x = 0$ by Corollary 7.27. Since $\alpha_i + k\alpha_r$ is not a root for $k > 1$, it follows from (7.10) that $\langle \alpha_r, \alpha_i \rangle = -1$ for all $\alpha_i \in \Sigma$. On the other hand, $\langle \alpha_r, \alpha_i \rangle = 0$ for $\alpha_i \in \Delta^0 \setminus (\{\alpha_r\} \cup \Sigma)$, and the above gives $[\sigma(h), x] = 2(\sum_{i: \alpha_i \in \Sigma} a_i)x = 2(\text{ht}_{\mathfrak{p}}(\alpha))x$. Therefore $\sigma(h)$ acts by twice the \mathfrak{p} -height on root spaces contained in \mathfrak{g} . Since $h \in \mathfrak{t} \leq \mathfrak{g} \oplus \mathfrak{z}(\mathfrak{q}^0)$, we conclude that $\sigma(h) \in \mathfrak{z}(\mathfrak{p}^0) \oplus \mathfrak{z}(\mathfrak{q}^0)$. In particular since $\mathfrak{z}(\mathfrak{q}^0)$ is 1-dimensional and spanned by $\xi^{\mathfrak{q}}$, we have $\xi^{\mathfrak{p}} = \sigma(\xi^{\mathfrak{q}}) - k\xi^{\mathfrak{q}}$ for some $k \in \mathbb{R}$ for which

$\xi^{\mathfrak{p}} \in \mathfrak{t}_0$. By the description (7.9) of \mathfrak{t}_0 , we require that k satisfies

$$\begin{aligned}
0 &= \omega_r(\xi^{\mathfrak{p}}) = \omega_r(\sigma(\xi^{\mathfrak{q}}) - k\xi^{\mathfrak{q}}) \\
&= \omega_r((1-k)\xi^{\mathfrak{q}} - \beta_0(\xi^{\mathfrak{q}})h_0) \\
&= \frac{1}{2}\omega_r((1-k)(h_n + \cdots + h_0) - \beta_0(h_n + \cdots + h_0)h_0) \\
&= \frac{1}{2}(1-k)(n+1) - 1.
\end{aligned}$$

Therefore $k = \frac{n-1}{n+1}$ and consequently

$$\xi^{\mathfrak{p}} = \sigma(\xi^{\mathfrak{q}}) - \frac{n-1}{n+1}\xi^{\mathfrak{q}} = \frac{2}{n+1}\xi^{\mathfrak{q}} - h_0 \quad (7.12)$$

We can now complete the proof.

(1) Since $\xi^{\mathfrak{q}}$ acts trivially on $\mathfrak{g} \leq \mathfrak{q}^0$, we have $[\xi^{\mathfrak{p}}, x] = \sigma([\xi^{\mathfrak{q}}, \sigma^{-1}(x)]) = \text{ht}_{\mathfrak{q}}(\sigma(\alpha))x$ and thus $\text{ht}_{\mathfrak{p}}(\alpha) = \text{ht}_{\mathfrak{q}}(\sigma(\alpha))$ for all $\alpha \in \Delta$ with $\mathfrak{h}_{\alpha} \leq \mathfrak{g}$. Since \mathfrak{q} is an abelian parabolic, it remains to prove that each eigenspace occurs. For this, note that $\mathfrak{p}^0 \leq \mathfrak{q}^0$ has \mathfrak{p} -height zero, while $\sigma(\mathbb{W}_{0i})$ and $\sigma(\mathbb{W}_{0i}^*)$ consist respectively of root spaces of \mathfrak{p} -height ± 1 .

(2) It remains to identify the eigenspaces of $\xi^{\mathfrak{p}}$ on \mathbb{W} . Given a root α of \mathfrak{q} -height one, the descriptions (7.8) give $\mathfrak{h}_{\alpha} \leq \mathbb{W}_i$ if and only if $\alpha = \beta_i$, so that $\sigma(\alpha) = \alpha$ for $i \neq 0$ and $\sigma(\alpha) = -\alpha$ for $i = 0$. On the other hand, $\mathfrak{h}_{\alpha} \leq \mathbb{W}_{ij}$ if and only if $\langle \alpha, \beta_i \rangle = 1 = \langle \alpha, \beta_j \rangle$ and $\langle \alpha, \beta_k \rangle = 0$ for all $k \neq i, j$, so that $\sigma(\alpha) = \alpha$ for $j \neq 0$ and $\sigma(\alpha) = \alpha - \beta_0$ for $j = 0$. It follows that $\sigma(\xi^{\mathfrak{q}})$ acts on \mathbb{W}_i by the identity for $i > 0$, and by -1 for $i = 0$; while it acts on \mathbb{W}_{ij} by $+1$ for $j > i > 0$, and trivially for $j > i = 0$. Since $\xi^{\mathfrak{q}}$ acts on all root spaces contained in \mathbb{W} by the identity, we conclude from above that

$$\begin{aligned}
[\xi^{\mathfrak{p}}, x] &= \frac{2}{n+1}x & \forall x \in \bigoplus_{i=1}^n (\mathbb{W}_i \oplus \bigoplus_{j>i} \mathbb{W}_{ij}) \\
[\xi^{\mathfrak{p}}, x] &= -\frac{n-1}{n+1}x & \forall x \in \bigoplus_{i=1}^n \mathbb{W}_{0i} \\
\text{and } [\xi^{\mathfrak{p}}, x] &= -\frac{2n}{n+1}x & \forall x \in \mathbb{W}_0,
\end{aligned} \quad (7.13)$$

which is the eigenspace decomposition of \mathbb{W} as a \mathfrak{p}^0 -representation. Therefore \mathbb{W} has three graded components, hence height two as a \mathfrak{g} -representation. \square

Remark 7.31. We observed above that a simple root $\alpha \in \Delta^0 \setminus \{\alpha_r\}$ lies in Σ if and only if $\langle \alpha_i, \alpha_r \rangle = -1$. Since both α and α_r are simple roots, $\alpha - \alpha_r$ is not a root and hence $\langle \alpha, \alpha_r \rangle \leq 0$. Moreover since \mathfrak{q} is an abelian parabolic $\alpha + 2\alpha_r$ is not a root. Consequently $\langle \alpha, \alpha_r \rangle = -1$ is the only non-zero option. In particular, to form \mathfrak{p} we cross the nodes of the Dynkin diagram of \mathfrak{g} that were connected to crossed nodes in the Dynkin diagram of \mathfrak{q} . This makes the classification in Section 7.3 very straightforward.

7.2.3 The \mathbb{Z}^2 -grading

Theorem 7.17 describes the structure of \mathfrak{g} and \mathbb{W} as \mathfrak{p}^0 -representations, with respect to algebraic Weyl structures for \mathfrak{q} and \mathfrak{p} . We can use this to describe \mathfrak{h} as a \mathfrak{p}^0 -representation, and the Lie brackets between various irreducible components. For this, we first identify the summands of \mathbb{W} with certain \mathfrak{p}^0 -representations.

Consider an irreducible \mathfrak{g} -representation \mathbb{V} whose \mathfrak{p}^\perp -filtration has height k and socle \mathbb{V}_0 . Since $H_0(\mathfrak{p}^\perp; \mathbb{V}) := \mathbb{V}/(\mathfrak{p}^\perp \cdot \mathbb{V})$, there is a natural linear map

$$\begin{aligned} \Psi : H_0(\mathfrak{p}^\perp; \mathbb{V}) &\rightarrow \text{Hom}(\otimes^k \mathfrak{p}^\perp, \mathbb{V}_0) \\ \Psi[v](\alpha_1 \otimes \cdots \otimes \alpha_k) &:= \alpha_1 \cdot (\alpha_2 \cdots (\alpha_k \cdot v)). \end{aligned} \tag{7.14}$$

Then Ψ is well-defined since \mathbb{V}_0 is, by definition, the kernel of the \mathfrak{p}^\perp -action; moreover since \mathfrak{p}^\perp is abelian, Ψ takes values in $\text{Hom}(S^k \mathfrak{p}^\perp, \mathbb{V}_0)$. In the case that \mathbb{V} is an irreducible \mathfrak{g} -representation, $H_0(\mathfrak{p}^\perp; \mathbb{V})$ is an irreducible \mathfrak{p} -representation and therefore by Schur's lemma Ψ is an isomorphism onto its image, which is an irreducible \mathfrak{p} -subrepresentation of $\text{Hom}(S^k \mathfrak{p}^\perp, \mathbb{V}_0)$. Applying this to the case $\mathbb{V} = \mathbb{W}$, we deduce the following.

Proposition 7.32. *Let $L^* := \mathbb{W}_0$ be the \mathfrak{p}^\perp -socle of \mathbb{W} . Then with respect to any algebraic Weyl structure for \mathfrak{p} , we have*

$$\mathbb{W} \cong (L^* \otimes B) \oplus (L^* \otimes \mathfrak{g}/\mathfrak{p}) \oplus L^*$$

for a \mathfrak{p} -subrepresentation $B \leq S^2(\mathfrak{g}/\mathfrak{p})$.

Proof. By Lemma 7.10, it suffices to suppose that \mathfrak{h} is simple, in which case \mathbb{W} is an irreducible \mathfrak{g} -representation and L^* is 1-dimensional by the theory of Subsection 7.2.2. By Theorem 7.17(2) there are three graded components of \mathbb{W} , and hence $k = 2$ in (7.14). Then by definition, the lowest and highest weight summands are L^* and $H_0(\mathfrak{p}^\perp; \mathbb{W}) := \mathbb{W}/(\mathfrak{p}^\perp \cdot \mathbb{W})$ respectively, and using the map Ψ from (7.14) we identify $H_0(\mathfrak{p}^\perp; \mathbb{W})$ with $L^* \otimes B \leq \text{Hom}(S^2 \mathfrak{p}^\perp, L^*)$ for some irreducible \mathfrak{p} -subrepresentation $B \leq S^2(\mathfrak{g}/\mathfrak{p})$. Thus it remains to identify the graded component $\mathbb{W}_{(1)} := (\mathfrak{p}^\perp \cdot \mathbb{W})/L^*$.

Since \mathfrak{p} is an abelian parabolic by Theorem 7.17(1), the action of \mathfrak{p}^\perp in the filtration $\mathbb{W} \supset \mathfrak{p}^\perp \cdot \mathbb{W} \supset L^* \supset 0$ of \mathbb{W} can only lower the weight by at most one. Then the action of \mathfrak{g} on L^* induces a linear map $L^* \otimes \mathfrak{g} \rightarrow \mathfrak{p}^\perp \cdot \mathbb{W}$. By composing with the quotient by L^* we obtain a linear map $L^* \otimes \mathfrak{g} \rightarrow (\mathfrak{p}^\perp \cdot \mathbb{W})/L^*$ which vanishes identically on $L^* \otimes \mathfrak{p}$ since the action of \mathfrak{p} is filtration preserving, thus giving a linear map $q : L^* \otimes (\mathfrak{g}/\mathfrak{p}) \rightarrow (\mathfrak{p}^\perp \cdot \mathbb{W})/L^*$ which surjects by construction. Finally, observe that an element $\lambda \otimes (X + \mathfrak{p}) \in L^* \otimes \mathfrak{g}/\mathfrak{p}$ lies in $\ker q$ if and only if $X \cdot \lambda \in L^*$, if and only if $X \in \mathfrak{p}$, so that q is also injective and hence an isomorphism. \square

We will frequently omit the tensor product symbol when tensoring with elements of L or L^* . The following is immediate from the isomorphism $\mathbb{W}_{(1)} \cong L^* \otimes \mathfrak{g}/\mathfrak{p}$.

Corollary 7.33. *Under the identifications of Proposition 7.32, the Lie bracket between $\lambda \in L^*$ and $X \in \mathfrak{g}/\mathfrak{p}$ is given by $[\lambda, X] = \lambda X \in L^* \otimes \mathfrak{g}/\mathfrak{p}$. \square*

In terms of the Peirce decomposition (7.7), we may identify²

$$\begin{aligned} L^* \otimes B &= \bigoplus_{i=1}^n \left(\mathbb{W}_i \oplus \bigoplus_{j>i} \mathbb{W}_{ij} \right) \\ L^* \otimes \mathfrak{g}/\mathfrak{p} &= \bigoplus_{i=1}^n \mathbb{W}_{0i} \\ L^* &= \mathbb{W}_0. \end{aligned}$$

Moreover, by (7.13) any algebraic Weyl structure for \mathfrak{p} acts on these summands by multiplication by $\frac{2}{n+1}$, $-\frac{n-1}{n+1}$ and $-\frac{2n}{n+1}$ respectively. This is precisely the idempotent decomposition of \mathbb{W} with respect to the single idempotent e_0 .

It follows from Lemma 7.23(2) that the Jordan eigenspaces \mathbb{W}_{ij} all have the same dimension, say $r := \dim \mathbb{W}_{ij}$.³ This leads to the following dimension formulae.

Corollary 7.34. *We have $\dim \mathbb{W} = \frac{1}{2}(n+1)(rn+2)$ and $\dim(\mathfrak{g}/\mathfrak{p}) = rn$, and consequently $\dim B = \frac{1}{2}n(rn-r+2)$. \square*

For projective parabolic geometries, the Cartan condition then implies that M has dimension rn . This justifies why we ignored the case $n=0$ in Assumption 7.22, since it corresponds to a projective parabolic geometry over a zero-dimensional manifold.

Definition 7.35. We shall refer to r and n respectively as the *scalar parameter* and *projective dimension* of a projective parabolic geometry.

Recall that a Lie algebra \mathfrak{h} is said to be \mathbb{Z}^2 -graded if $\mathfrak{h} = \bigoplus_{(i,j) \in \mathbb{Z}^2} \mathfrak{h}_{(i,j)}$ such that $[\mathfrak{h}_{(i_1,j_1)}, \mathfrak{h}_{(i_2,j_2)}] \subseteq \mathfrak{h}_{(i_1+i_2, j_1+j_2)}$. That is, each $\mathfrak{h}_{(i)} := \bigoplus_{j \in \mathbb{Z}} \mathfrak{h}_{(j, i-j)}$ is a graded component of \mathfrak{h} . We have the following as a direct consequence of Theorem 7.17 and Proposition 7.32, which is the key result that allows us to compute Lie brackets in \mathfrak{h} .

Theorem 7.36. *The choice of algebraic Weyl structures for $\mathfrak{q} \leq \mathfrak{h}$ and $\mathfrak{p} \leq \mathfrak{g}$ induces the \mathbb{Z}^2 -grading of the Lie algebra \mathfrak{h} pictured in Figure 7.1. \square*

Using the \mathbb{Z}^2 -grading, each $(a, b) \in \mathbb{Z}$ induces a \mathbb{Z} -grading of \mathfrak{h} : this is the grading with algebraic Weyl structure $b\xi^{\mathfrak{q}} + a\xi^{\mathfrak{p}}$, which corresponds to the grading given by

²This is why we labelled the highest root of \mathfrak{h} by β_n , rather than β_0 as is arguably more logical.

³Alternatively, Albert proves this directly using Jordan-theoretic methods [3, Thm. 13].

$$\begin{array}{rcl}
\mathfrak{h} & & \\
\cong & & \\
\mathbb{W} & \cong & (L^* \otimes B) \oplus (L^* \otimes \mathfrak{g}/\mathfrak{p}) \oplus L^* \\
\oplus & & \oplus \\
\mathfrak{q}^0 & \cong & \mathfrak{g}/\mathfrak{p} \oplus (\mathfrak{p}^0 \oplus \mathfrak{z}(\mathfrak{q}^0)) \oplus \mathfrak{p}^\perp \\
\oplus & & \oplus \\
\mathbb{W}^* & \cong & L \oplus (L \otimes \mathfrak{p}^\perp) \oplus (L \otimes B^*).
\end{array} \tag{7.15}$$

Figure 7.1: The \mathbb{Z}^2 -grading on \mathfrak{h} described by Theorem 7.36.

stepping a line of gradient b/a through (7.15). For example, choosing $(1, 0)$ yields the grading $\mathfrak{h} \cong \mathbb{W} \oplus \mathfrak{q}^0 \oplus \mathbb{W}^*$, while the slope $(1, 1)$ yields a $|2|$ -grading

$$\begin{aligned}
\mathfrak{h} \cong & (L^* \otimes B) \oplus (\mathfrak{g}/\mathfrak{p} \oplus (L^* \otimes \mathfrak{g}/\mathfrak{p})) \oplus (L \oplus (\mathfrak{p}^0 \oplus \mathfrak{z}(\mathfrak{q}^0)) \oplus L^*) \\
& \oplus ((L \otimes \mathfrak{p}^\perp) \oplus \mathfrak{p}^\perp) \oplus (L \otimes B^*).
\end{aligned}$$

Note that this map from \mathbb{Z}^2 to \mathbb{Z} -gradings of \mathfrak{h} is not injective: for example, the pairs (ka, kb) yield the same “diagonal” \mathbb{Z} -grading for all $k \in \mathbb{N}$.

The automorphism σ defined by (7.11) may be viewed as a “reflection” of the diagram (7.15) as follows.⁴ From the relation (7.12), for any $x \in L^* \otimes \mathfrak{g}/\mathfrak{p}$ we have $[\xi^q, x] = x$ and $[\xi^p, x] = -\frac{n-1}{n+1}x$ by (7.13). Consequently Lemma 7.30(2) gives

$$\begin{aligned}
[\xi^q, \sigma(x)] &= \sigma([\sigma(\xi^q), x]) = \sigma([\xi^p + \frac{n-1}{n+1}\xi^q, x]) = 0 \\
\text{and } [\xi^p, \sigma(x)] &= \sigma([\xi^q - \frac{n-1}{n+1}\sigma(\xi^q), x]) = \sigma([\xi^q - \frac{n-1}{n+1}(\xi^p + \frac{n-1}{n+1}\xi^q), x]) = x,
\end{aligned}$$

implying that $\sigma(x) \in \mathfrak{g}/\mathfrak{p}$. Therefore $\sigma(L^* \otimes \mathfrak{g}/\mathfrak{p}) = \mathfrak{g}/\mathfrak{p}$; similarly we have $\sigma(L \otimes \mathfrak{p}^\perp) = \mathfrak{p}^\perp$, $\sigma(L) = L^*$, while σ preserves $L^* \otimes B$, $L \otimes B^*$ and $\mathfrak{p}^0 \oplus \mathfrak{z}(\mathfrak{q}^0)$. In particular, σ exchanges the horizontal and vertical gradings of \mathfrak{h} . Consequently σ induces dual Jordan algebra structures on $\widetilde{\mathbb{W}} := (L^* \otimes B) \oplus \mathfrak{g}/\mathfrak{p} \oplus L$ and $\widetilde{\mathbb{W}}^* := L^* \oplus \mathfrak{p}^\perp \oplus (L \otimes B^*)$, with Jordan products defined by $x \tilde{\circ} y := \sigma(\sigma^{-1}(x) \circ \sigma^{-1}(y))$.

Up to the overall normalisation fixed by Convention 7.19, the Killing form on \mathfrak{h} is the orthogonal direct sum of the Killing form on \mathfrak{g} , the standard inner product on $\mathfrak{z}(\mathfrak{q}^0)$ and the (symmetrised) pairing $\mathbb{W} \times \mathbb{W}^* \rightarrow \mathbb{C}$. We chose the normalisation Convention 7.19 so that the Killing form between dual summands is simply the natural contraction. In particular,

$$\langle h, \theta \rangle = \theta \lrcorner h, \quad \langle Z, \eta \rangle = \eta(Z), \quad \langle \ell, \lambda \rangle = \ell\lambda \quad \text{and} \quad \langle X, \alpha \rangle = \alpha(X)$$

for $(h, Z, \lambda) \in \mathbb{W}$, $(X, \alpha) \in \mathfrak{g}/\mathfrak{p} \oplus \mathfrak{p}^\perp$ and $(\ell, \eta, \theta) \in \mathbb{W}^*$. We can now calculate a large

⁴But note that perhaps $\sigma^2 \neq \text{id}$ in general, since Lemma 7.30(2) only guarantees that $\sigma^2(\mathfrak{h}_\alpha) = \mathfrak{h}_\alpha$.

number of algebraic brackets between the summands of (7.15).

Theorem 7.37. *Consider elements*

$$\begin{aligned} (h, Z, \lambda) \in \mathbb{W} &\cong (L^* \otimes B) \oplus (L^* \otimes \mathfrak{g}/\mathfrak{p}) \oplus L^*, \\ (X, A, \alpha) \in \mathfrak{q}^0 &\cong \mathfrak{g}/\mathfrak{p} \oplus (\mathfrak{p}^0 \oplus \mathfrak{z}(\mathfrak{q}^0)) \oplus \mathfrak{p}^\perp \\ \text{and } (\ell, \eta, \theta) \in \mathbb{W}^* &\cong L \oplus (L \otimes \mathfrak{p}^\perp) \oplus (L \otimes B^*), \end{aligned} \quad (7.16)$$

as well as their primed counterparts. Then with normalisation conventions as above, Lie brackets between the various summands in \mathfrak{h} are given by Table 7.1.

| | h' | Z' | λ' | X' | A' | α' | ℓ' | η' | θ' |
|-----------|------|------|------------|---|--|--|--|--|--|
| h | 0 | 0 | 0 | 0 | $[h, A']$ $\in L^* \otimes B$ | $h(\alpha', \cdot)$ $\in L^* \otimes \mathfrak{g}/\mathfrak{p}$ | 0 | $-h(\eta', \cdot)$ $\in \mathfrak{g}/\mathfrak{p}$ | $[h, \theta']$ $\in \mathfrak{p}^0 \oplus \mathfrak{z}(\mathfrak{q}^0)$ |
| Z | | 0 | 0 | $[Z, X']$ $\in L^* \otimes B$ | $[Z, A']$ $\in L^* \otimes \mathfrak{g}/\mathfrak{p}$ | $\alpha'(Z)$ $\in L^*$ | $-\ell' Z$ $\in \mathfrak{g}/\mathfrak{p}$ | $[Z, \eta']$ $\in \mathfrak{p}^0 \oplus \mathfrak{z}(\mathfrak{q}^0)$ | $-\theta'(Z, \cdot)$ $\in \mathfrak{p}^\perp$ |
| λ | | | 0 | $\lambda X'$ $\in L^* \otimes \mathfrak{g}/\mathfrak{p}$ | $\frac{2(\text{tr } A')}{r(n+1)} \lambda$ $\in L^*$ | 0 | $[\lambda, \ell']$ $\in \mathfrak{p}^0 \oplus \mathfrak{z}(\mathfrak{q}^0)$ | $-\lambda \eta'$ $\in \mathfrak{p}^\perp$ | 0 |
| X | | | | 0 | $-A' X$ $\in \mathfrak{g}/\mathfrak{p}$ | $[X, \alpha']$ $\in \mathfrak{p}^0$ | 0 | $\eta'(X)$ $\in L$ | $\theta'(X, \cdot)$ $\in L \otimes \mathfrak{p}^\perp$ |
| A | | | | | $AA' - A'A$ $\in \mathfrak{p}^0$ | $-\alpha' \circ A$ $\in \mathfrak{p}^\perp$ | $\frac{2(\text{tr } A)}{r(n+1)} \ell'$ $\in L$ | $[A, \eta']$ $\in L \otimes \mathfrak{p}^\perp$ | $[A, \theta']$ $\in L \otimes B^*$ |
| α | | | | | | 0 | $\ell' \alpha$ $\in L \otimes \mathfrak{p}^\perp$ | $[\alpha, \eta']$ $\in L \otimes B^*$ | 0 |
| ℓ | | | | | | | 0 | 0 | 0 |
| η | | | | | | | | 0 | 0 |
| θ | | | | | | | | | 0 |

Table 7.1: Lie brackets between the various summands of \mathfrak{h} according to the \mathbb{Z}^2 -grading (7.15), where the entry labelled by row x and column y is the bracket $[x, y]$. Elements are defined in (7.16), the colouring pertains to the proof of Theorem 7.36, and the empty part of the table may be determined by skew-symmetry.

Proof. Since \mathbb{W} and \mathbb{W}^* are abelian Lie algebras, all brackets in the top-left and bottom-right squares of Table 7.1 are zero. Moreover $[X, X'] = 0$ and $[\alpha, \alpha'] = 0$ by Theorem 7.17(1), while the form of the \mathbb{Z}^2 -grading implies that the brackets $[h, X']$, $[\lambda, \alpha']$, $[h, \ell']$, $[\lambda, \theta']$, $[X, \ell']$ and $[\alpha, \theta']$ all vanish. This accounts for all the zeroes in Table 7.1.

Next, we have $[\lambda, X] = \lambda X \in L^* \otimes \mathfrak{g}/\mathfrak{p}$ by Corollary 7.33. From the \mathbb{Z}^2 -grading we know that $[\eta, \lambda] \in \mathfrak{p}^\perp$. Since the Killing form between $L \otimes \mathfrak{p}^\perp$ and $L^* \otimes \mathfrak{g}/\mathfrak{p}$ is just the contraction, it follows that $\langle [\eta, \lambda], X \rangle = \langle \eta, [\lambda, X] \rangle = \eta(\lambda X)$ for all $X \in \mathfrak{g}/\mathfrak{p}$, so

that $[\eta, \lambda] = \lambda\eta \in \mathfrak{p}^\perp$ by non-degeneracy. Similarly $[X, \eta] \in L$, for which $\langle [X, \eta], \lambda \rangle = \langle X, [\eta, \lambda] \rangle = \eta(\lambda X)$ and hence $[X, \eta] = \eta(X) \in L$.

The reflection σ allows us to ascertain the Lie bracket $[\ell, \alpha]$: since $L = \sigma(L^*)$ and $\mathfrak{p}^\perp = \sigma(L \otimes \mathfrak{p}^\perp)$, we may write $\ell = \sigma(\lambda)$ and $\alpha = \sigma(\eta)$, for which $[\ell, \alpha] = \sigma([\lambda, \eta]) = -\sigma(\lambda\eta)$. Since σ is defined in terms of the adjoint action, the Leibniz rule gives $\sigma(\lambda\eta) = \sigma(\lambda) \otimes \sigma(\eta) = \ell\alpha$ and hence $[\ell, \alpha] = -\ell\alpha$. Arguing as in the previous paragraph, it follows also that $[Z, \alpha] = \alpha(Z) \in L^*$ and $[Z, \ell] = -\ell Z \in \mathfrak{g}/\mathfrak{p}$.

The bracket $[h, \alpha]$ may be calculated using the map (7.14). By construction, $h \in L^* \otimes B$ is identified with the linear map $\alpha \otimes \beta \mapsto h(\alpha, \beta) := [\alpha, [\beta, h]]$. Since $[\beta, h] \in L^* \otimes \mathfrak{g}/\mathfrak{p}$, the above gives $h(\alpha, \beta) = -\alpha([\beta, h]) \in L^*$, which implies that $[h, \alpha] = h(\alpha, \cdot)$. For $[\theta, X] \in L \otimes \mathfrak{p}^\perp$, we identify $L \otimes B^* = H^0(\mathfrak{p}^\perp; \mathbb{W}^*) \cong H_0(\mathfrak{g}/\mathfrak{p}; \mathbb{W}^*)$ by (2.4). Thus θ may be identified with the linear map $X \otimes Y \mapsto \theta(X, Y) = [X, [Y, \theta]]$, giving $[\theta, X] = -\theta(X, \cdot)$. Writing $\eta = \ell\alpha = [\alpha, \ell]$, we then have $[h, \eta] = [[h, \alpha], \ell] = -\ell h(\alpha, \cdot) = -h(\eta, \cdot)$ by the previous computations; $[\theta, Z] = \theta(Z, \cdot)$ similarly.

By the grading on \mathfrak{g} , we view \mathfrak{p}^0 as a subalgebra of $\mathfrak{gl}(\mathfrak{g}/\mathfrak{p}) \cong \mathfrak{gl}(rn, \mathbb{C})$ and the brackets of \mathfrak{p}^0 with $\mathfrak{g}/\mathfrak{p}$ and \mathfrak{p}^\perp are the natural actions; whence $[B, X] = BX$ and $[B, \alpha] = -\alpha \circ B$ for all $B \in \mathfrak{p}^0$. Since $\mathfrak{z}(\mathfrak{q}^0)$ is abelian and acts trivially on \mathfrak{g} , the brackets involving X, A and α follow. Finally, the entries highlighted in light grey depend on the Lie algebra \mathfrak{h} and may be determined on a case-by-case basis as in Remark 7.41; entries highlighted in dark grey will follow from the forthcoming Proposition 7.38. \square

Note that elements $h \in L^* \otimes B$ may be viewed as L^* -valued symmetric bilinear forms on \mathfrak{p}^\perp ; indeed (7.14) gives $h(\alpha, \beta) = [[h, \alpha], \beta]$ for all $\alpha, \beta \in \mathfrak{p}^\perp$, for which $h(\alpha, \beta) = h(\beta, \alpha)$ since \mathfrak{p}^\perp is abelian by Theorem 7.17(1). Similarly, elements $\theta \in L \otimes B^*$ may be viewed as L -valued symmetric bilinear forms on $\mathfrak{g}/\mathfrak{p}$.

7.2.4 Characterisation of L

Here we describe the role of L , as well as completing the entries of Table 7.1.

Proposition 7.38. $\wedge^{rn}(\mathfrak{g}/\mathfrak{p})$ and $L^{r(n+1)/2}$ are isomorphic as \mathfrak{p}^0 -representations.

Proof. Since $\dim(\mathfrak{g}/\mathfrak{p}) = rn$, both $\wedge^{rn}(\mathfrak{g}/\mathfrak{p})$ and L are 1-dimensional and hence irreducible \mathfrak{p}^0 -representations. By Schur's lemma the action is by a scalar, so it suffices to compare the actions of the grading element of \mathfrak{p} . By (7.13), the algebraic Weyl structure of \mathfrak{p} acts on $L \cong \mathbb{W}_0^*$ by multiplication by $2n/(n+1)$. Since $\mathfrak{g}/\mathfrak{p}$ has weight one, $\wedge^{rn}(\mathfrak{g}/\mathfrak{p})$ has weight

$$rn = \frac{r(n+1)}{2} \cdot \frac{2n}{n+1}$$

and hence the isomorphism follows. \square

The isomorphism afforded by Proposition 7.38 may be used to gain information about the Lie bracket $[X, \alpha] \in \mathfrak{p}^0$ between elements $X \in \mathfrak{g}/\mathfrak{p}$ and $\alpha \in \mathfrak{p}^\perp$.

Lemma 7.39. $[[X, \alpha], \ell] = \alpha(X)\ell$ and $[[X, \alpha], \lambda] = -\alpha(X)\lambda$ for all $\ell \in L$ and $\lambda \in L^*$.

Proof. We have $[[X, \alpha], \ell] = [[X, \ell], \alpha] + [X, [\alpha, \ell]]$ by the Jacobi identity, where the first summand vanishes since the bracket between $\mathfrak{g}/\mathfrak{p}$ and L is trivial. The second summand equals $[X, \ell\alpha] = \alpha(X)\ell$ by Table 7.1. \square

Corollary 7.40. $[A, \ell] = \frac{2}{r(n+1)}(\text{tr } A)\ell \in L$ for all $A \in \mathfrak{p}^0$ and $\ell \in L$. In particular, $[X, \alpha]$ has trace $\frac{1}{2}r(n+1)$ as an endomorphism of $\mathfrak{g}/\mathfrak{p}$ for all $X \in \mathfrak{g}/\mathfrak{p}$ and $\alpha \in \mathfrak{p}^\perp$.

Proof. The action of $A \in \mathfrak{p}^0$ on $\wedge^{rn}(\mathfrak{g}/\mathfrak{p})$ is given by multiplication by the determinant of A . Since the derivative of the determinant is the trace, the action of $A \in \mathfrak{p}^0$ is given by multiplication by the trace of A . The first claim now follows from Proposition 7.38, while the second claim follows from Lemma 7.39. \square

Remark 7.41. Note that Corollary 7.40 proves the dark grey entries in Table 7.1. Indeed, the brackets $[A, \ell]$ and $[A, \lambda]$ follow immediately, while we have

$$\begin{aligned} [A, h](\alpha, \beta) &= [A, h(\alpha, \beta)] - h([A, \alpha], \beta) - h(\alpha, [A, \alpha]) \\ &= -\frac{r(n+1)}{2}h(\alpha, \beta) + h(\alpha \circ A, \beta) + h(\alpha, \beta \circ A) \end{aligned}$$

by the Leibniz rule. It also allows us to calculate the light grey entries in terms of the Lie bracket $\mathfrak{g}/\mathfrak{p} \times \mathfrak{p}^\perp \rightarrow \mathfrak{p}^0$, which depend on the Lie algebra \mathfrak{h} in question. For example, for $Z \in L^* \otimes B$ and $X \in \mathfrak{g}/\mathfrak{p}$ we have $[Z, X] \in L^* \otimes B$ by the \mathbb{Z}^2 -grading. Therefore by the Jacobi identity

$$\begin{aligned} [Z, X](\alpha, \beta) &:= [[[Z, X], \alpha], \beta] \\ &= [[\alpha(Z), X], \beta] + [[Z, [X, \alpha]], \beta] \\ &= [\alpha ZX, \beta] + [\beta(Z), [X, \alpha]] + [Z, [[X, \alpha], \beta]] \\ &= \alpha(Z)\beta(X) + \alpha(X)\beta(Z) + [[X, \alpha], \beta](Z) \end{aligned}$$

for all $\alpha, \beta \in \mathfrak{p}^\perp$. The brackets $[\alpha, \eta]$, $[\lambda, \ell]$, $[Z, \eta]$ and $[h, \theta]$ may be determined similarly. For example, in the case $\mathfrak{h} = \mathfrak{sp}(2n+2, \mathbb{C})$ one finds that $\mathfrak{p}^0 = \mathfrak{gl}(n, \mathbb{C})$ and $[X, \alpha] = \frac{1}{2}(\alpha(X)\text{id} + X \otimes \alpha)$, yielding $[Z, X] = X \odot Z$ and $[\alpha, \eta] = \alpha \odot \eta$.

For the classical projective structures, there was a bijection between the affine space of Weyl structures and the induced connections on the bundle \mathcal{L} associated to L .

Corollary 7.42. *For any projective parabolic geometry, there is a bijection between Weyl structures and their induced connections on \mathcal{L} .*

Proof. Let $\nabla, \hat{\nabla}$ be the Weyl connections associated to two Weyl structures, and suppose that $\hat{\nabla} = \nabla + \llbracket \cdot, \gamma \rrbracket$ for some $\gamma \in \Omega^1(M)$. Then on sections of \mathcal{L} we have $\hat{\nabla}\ell = \nabla\ell + \ell\gamma$, so that the induced connections coincide if and only if $\gamma = 0$. \square

In the terminology of [59, §3.5], this means that \mathcal{L} is a *bundle of scales* for the underlying parabolic geometry. Corollarys 7.40 and 7.42 may then be viewed as special cases of Proposition 3.2(2) and Theorem 3.8(1) from [59]. We shall not need this level of generality here.

Remark 7.43. The \mathbb{Z}^2 -grading from Theorem 7.36 and the Lie brackets calculated in Theorem 7.37 only require that \mathfrak{p} is an abelian parabolic and \mathbb{W} has height two. Therefore they go through in the non-self-dual case alluded to in Remark 7.18. The key difference is that we do not have a Peirce decomposition for \mathbb{W} , and cannot identify an integer $r := \dim \mathbb{W}_{ij}$. In this case, we find that $L \cong (\wedge^m(\mathfrak{g}/\mathfrak{p}))^{(2w-1)/mw}$, where $m := \dim(\mathfrak{g}/\mathfrak{p})$ and $w := \langle \omega_r, \omega_r \rangle$.

7.3 Classification

Having described the algebraic structure associated to a projective parabolic geometry, we are overdue writing down a classification. This is a straightforward application of the classification of symmetric R-spaces, which is well-known; see for example [60, Prop. 3.2.3]. We first give a classification over \mathbb{C} in Subsection 7.3.1, before selecting appropriate real forms in Subsection 7.3.2.

7.3.1 Classification over \mathbb{C}

Suppose that \mathfrak{h} is a complex semisimple Lie algebra with parabolic \mathfrak{q} , and choose a Cartan subalgebra \mathfrak{t} and simple subsystem Δ^0 with respect to which \mathfrak{q} is the standard parabolic associated to a subset $\Sigma \subseteq \Delta^0$. These choices carry an algebraic Weyl structure for \mathfrak{q} with them, hence splitting the \mathfrak{q}^\perp -filtration of \mathfrak{h} , with grading given by the Σ -height of roots of \mathfrak{h} . In particular, the height of \mathfrak{q} is therefore equal to the Σ -height of the highest root. It follows that \mathfrak{q} is an abelian parabolic if and only if the crossed node corresponds to a one in the highest root, leading to a short and simple classification of irreducible symmetric R-spaces. Tables of highest roots may be found in [60, Tbl. B.2] and [103].

To classify the flat models of projective parabolic geometries, it suffices then to decide which symmetric R-spaces are self-dual, and consider their isotropy R-spaces. This is straightforward thanks to Proposition 7.8, so it remains to go through each Dynkin type, determine whether $H \cdot \mathfrak{q}$ is self-dual, and if so find the algebra \mathfrak{g} , the

\mathfrak{g} -representation \mathbb{W} and the parabolic \mathfrak{p} . The integer n , which by definition equals the maximal number of orthogonal roots of \mathfrak{q} -height one, may be read off from the tables of [1, §3-5]; Corollary 7.34 then gives $r = \dim(\mathfrak{g}/\mathfrak{p})/n$. Equivalently $r := \dim \mathbb{W}_{ij}$ and $n = \dim(\mathfrak{g}/\mathfrak{p})/r$, so that one may calculate (r, n) from the Peirce decomposition.

Type A_k . The highest root of $\mathfrak{h} = \mathfrak{sl}(k+1, \mathbb{C})$ is the sum of all simple roots, so we may cross any node to obtain an abelian parabolic \mathfrak{q} . Crossing the ℓ th node determines a symmetric R-space $H \cdot \mathfrak{q}$ with minimal embedding $H \cdot \mathfrak{q} \hookrightarrow \mathbb{P}(\wedge_{\mathbb{C}}^{\ell} \mathbb{C}^{k+1})$ which, since the usual involution flips the Dynkin diagram, is self-dual if and only if $k = 2m - 1$ is odd and we cross the m th node. Thus there is a single self-dual symmetric R-space of this type, corresponding to $\mathfrak{h} = \mathfrak{sl}(2m, \mathbb{C})$ and $H \cdot \mathfrak{q} \hookrightarrow \mathbb{P}(\wedge_{\mathbb{C}}^m \mathbb{C}^{2m})$, given by the grassmannian $\text{Gr}_m(\mathbb{C}^{2m})$ of complex m -planes in \mathbb{C}^{2m} .

The Dynkin diagram of the semisimple part \mathfrak{g} of \mathfrak{q}^0 is given by

$$\mathfrak{g} = \begin{array}{c} \circ - \circ \cdots - \circ - \circ \\ \circ - \circ \cdots - \circ - \circ \end{array} = \mathfrak{sl}(m, \mathbb{C}) \oplus \mathfrak{sl}(m, \mathbb{C}).$$

In particular, \mathfrak{g} is not simple. The adjoint representation of \mathfrak{h} and the \mathfrak{g} -representation \mathbb{W} induced by $\mathfrak{h}/\mathfrak{q}$ have highest weights

$$\mathfrak{h} = \begin{array}{cccc} 1 & 0 & \cdots & 0 & 0 \\ \circ - \circ & \cdots & - \circ & - \circ & \circ \\ & & & & \diagdown \\ & & & & \circ \text{ } 0 \\ & & & & \diagup \\ 1 & 0 & \cdots & 0 & 0 \\ \circ - \circ & \cdots & - \circ & - \circ & \circ \end{array} \quad \text{and} \quad \mathbb{W} = \begin{array}{cccc} 1 & 0 & \cdots & 0 & 0 \\ \circ - \circ & \cdots & - \circ & - \circ & \circ \\ & & & & \diagdown \\ & & & & \circ \\ & & & & \diagup \\ 1 & 0 & \cdots & 0 & 0 \\ \circ - \circ & \cdots & - \circ & - \circ & \circ \end{array} = \mathbb{C}^m \boxtimes \overline{\mathbb{C}^m}.$$

Then the highest weight of \mathbb{W}^* is supported on the final node of each branch, so that

$$G \cdot \mathfrak{p} = \begin{array}{c} \circ - \circ \cdots - \circ \rightarrow \mathbf{x} \\ \circ - \circ \cdots - \circ \rightarrow \mathbf{x} \end{array} = \mathbb{C}\mathbb{P}^{m-1} \times \mathbb{C}\mathbb{P}^{m-1}$$

is a product of projective spaces. The Jordan algebra \mathbb{W} is the (complexification of) the space of $m \times m$ hermitian matrices under multiplication, with $r = 2$ and $n = m - 1 = \frac{1}{2}(k - 1)$. In future, it will be convenient to talk about type A_{2n+1} .

Type B_k . The highest root of $\mathfrak{h} = \mathfrak{so}(2k+1, \mathbb{C})$ has a coefficient of one for only the first simple root, so there is a symmetric R-space $H \cdot \mathfrak{q}$ determined by crossing this node. The corresponding minimal projective embedding is $H \cdot \mathfrak{q} \hookrightarrow \mathbb{P}(\mathbb{C}^{2k+1})$, identifying $H \cdot \mathfrak{q}$ with the complex conformal sphere $\mathbb{C}\mathbb{S}^{2k-1}$.

The Dynkin diagram of \mathfrak{g} is given by removing the first node of \mathfrak{h} , so that $\mathfrak{g} = \mathfrak{so}(2k - 1, \mathbb{C})$. The adjoint representation of \mathfrak{h} has highest weight

$$\mathfrak{h} = \begin{array}{ccccccc} 0 & 1 & 0 & \cdots & 0 & 0 & 0 \\ \circ - \circ - \circ & \cdots & - \circ & - \circ & - \circ & - \circ & \circ \end{array} \quad \text{and hence} \quad \mathbb{W} = \begin{array}{ccccccc} 1 & 0 & \cdots & 0 & 0 & 0 \\ \circ - \circ & \cdots & - \circ & - \circ & - \circ & - \circ & \circ \end{array} = \mathbb{C}^{2k-1}$$

as a \mathfrak{g} -representation. Then, since the fundamental representations in type B are isomorphic to their duals, we have $G \cdot \mathfrak{p} = \times \text{---} \circ \text{---} \cdots \text{---} \circ \text{---} \circ \text{---} \circ$, which is the complexified conformal sphere $\mathbb{C}\mathbb{S}^{2k-3}$. The Jordan algebra \mathbb{W} should be viewed as $\mathbb{C}^{2k-2} \oplus \mathbb{C}$, the algebra of *spin factors* [142], with product given by Clifford multiplication; this may equally be viewed as 1-dimensional projective geometry over \mathbb{C}^{2k-3} as in [123]. The integers (r, n) are given by $r = 2k - 3$ and $n = 1$.

Type C_k . The long simple root alone has coefficient one in the highest root of $\mathfrak{h} = \mathfrak{sp}(2k, \mathbb{C})$, giving a single symmetric R-space $H \cdot \mathfrak{q}$ given by crossing this node. It has minimal projective embedding $H \cdot \mathfrak{q} \hookrightarrow \mathbb{P}(\wedge_0^k \mathbb{C}^{2k})$ into the space of primitive k -forms, which identifies $H \cdot \mathfrak{q}$ with the complex grassmannian of langrangian subspaces of \mathbb{C}^{2k} .

The Dynkin diagram of \mathfrak{g} is given by removing the long node of \mathfrak{h} , so that $\mathfrak{g} = \mathfrak{sl}(k, \mathbb{C})$. The adjoint representation of \mathfrak{h} has highest weight

$$\mathfrak{h} = \begin{array}{cccccc} 2 & 0 & & 0 & 0 & 0 \\ \circ & \text{---} \circ & \cdots & \text{---} \circ & \text{---} \circ & \text{---} \circ \end{array} \quad \text{and hence} \quad \mathbb{W} = \begin{array}{cccccc} 2 & 0 & & 0 & 0 & \\ \circ & \text{---} \circ & \cdots & \text{---} \circ & \text{---} \circ & \end{array} = \mathbb{S}_{\mathbb{C}}^2 \mathbb{C}^k$$

as a \mathfrak{g} -representation. It follows that $G \cdot \mathfrak{p} = \circ \text{---} \circ \text{---} \cdots \text{---} \circ \text{---} \times$, which is the complex projective space $\mathbb{C}\mathbb{P}^{k-1}$. The Jordan algebra \mathbb{W} is the space of $k \times k$ complex symmetric matrices, with $r = 1$ and $n = k - 1$; thus we shall talk about type C_{n+1} in future.

Type D_k . The highest root of $\mathfrak{h} = \mathfrak{so}(2k, \mathbb{C})$ has a one over either the first node, or either half-spin node, so we may cross any of these. Crossing the first node yields the self-dual R-space $H \cdot \mathfrak{q} = \mathbb{C}\mathbb{S}^{2k-2}$, with $\mathfrak{g} = \mathfrak{so}(2k - 2, \mathbb{C})$ and $G \cdot \mathfrak{p} = \mathbb{C}\mathbb{S}^{2k-4}$. The Jordan algebra is $\mathbb{W} = \mathbb{C}^{2k-2}$, with $r = 2k - 4$ and $n = 1$. Types B_{k+2} and D_{k+2} may therefore be treated concurrently, which we refer to as type BD_{n+4} .

On the other hand, crossing either spin node yields two isomorphic symmetric R-spaces $H \cdot \mathfrak{q}$ with minimal projective embeddings $H \cdot \mathfrak{q} \hookrightarrow \mathbb{P}(\mathbb{S}^{\pm})$. The usual involution preserves this crossed node if and only if k is even, so we obtain a self-dual R-space only when $k = 2m$. The Dynkin diagram of \mathfrak{g} is then given by removing one spin node, yielding $\mathfrak{g} = \mathfrak{sl}(2m, \mathbb{C})$. The adjoint representation of \mathfrak{h} is

$$\mathfrak{h} = \begin{array}{ccccccc} & 0 & 1 & 0 & & 0 & 0 & \circ & 0 \\ & \circ & \text{---} \circ & \text{---} \circ & \cdots & \text{---} \circ & \text{---} \circ & \diagup \circ & \\ & & & & & & & \diagdown \circ & \\ & & & & & & & & 0 \end{array} \quad \text{and hence} \quad \mathbb{W} = \begin{array}{ccccccc} & 0 & 1 & 0 & & 0 & 0 & 0 \\ & \circ & \text{---} \circ & \text{---} \circ & \cdots & \text{---} \circ & \text{---} \circ & \text{---} \circ \end{array} = \wedge_{\mathbb{C}}^2 \mathbb{C}^{2m}$$

as a \mathfrak{g} -representation. Therefore $G \cdot \mathfrak{p} = \circ \text{---} \circ \text{---} \circ \text{---} \cdots \text{---} \circ \text{---} \times \text{---} \circ$, which is the grassmannian of complex 2-planes in \mathbb{C}^{2m-2} . The Jordan algebra \mathbb{W} is the complexification of the space of $m \times m$ quaternion-hermitian matrices under multiplication, with $r = 4$ and $n = m - 1 = \frac{1}{2}(k - 2)$; it will be convenient to talk about type D_{2n+2} in future.

Type E_6 . Temporarily writing the coefficients of simple roots in the Dynkin diagram,

the highest root of $\mathfrak{h} = \mathfrak{e}_6(\mathbb{C})$ is given by

$$\begin{array}{cccccc} 1 & 2 & 3 & 2 & 1 & \\ \circ & \circ & \circ & \circ & \circ & \\ & & | & & & \\ & & \circ & & & \\ & & 2 & & & \end{array},$$

so that we get isomorphic symmetric R-spaces by crossing either the left-most or right-most node. However the usual involution exchanges these two nodes, so there are no self-dual symmetric R-spaces in this type.

Type E₇. Returning to usual fundamental weight notation, the highest root of $\mathfrak{h} = \mathfrak{e}_7(\mathbb{C})$ is given by

$$\begin{array}{cccccc} 0 & 0 & 0 & 0 & 0 & 1 \\ \circ & \circ & \circ & \circ & \circ & \circ \\ & & | & & & \\ & & \circ & & & \\ & & 0 & & & \end{array},$$

so we get a single symmetric R-space $H \cdot \mathfrak{q}$ by crossing the right-most node, which is self-dual since the usual involution is just the identity. Its minimal projective embedding is $H \cdot \mathfrak{q} \hookrightarrow \mathbb{P}(\mathbb{C}_{56}^*)$, where \mathbb{C}_{56} is the 56-dimensional representation of $\mathfrak{e}_7(\mathbb{C})$, so that $H \cdot \mathfrak{q}$ is an exceptional manifold of dimension 27.

The Dynkin diagram of \mathfrak{g} is given by removing the right-most node, so that $\mathfrak{g} = \mathfrak{e}_6(\mathbb{C})$. The adjoint representation of \mathfrak{h} has highest weight

$$\mathfrak{h} = \begin{array}{cccccc} 1 & 0 & 0 & 0 & 0 & 0 \\ \circ & \circ & \circ & \circ & \circ & \circ \\ & & | & & & \\ & & \circ & & & \\ & & 0 & & & \end{array} \quad \text{and hence} \quad \mathbb{W} = \begin{array}{cccccc} 1 & 0 & 0 & 0 & 0 & \\ \circ & \circ & \circ & \circ & \circ & \\ & & | & & & \\ & & \circ & & & \\ & & 0 & & & \end{array} = \mathbb{C}_{27}.$$

The symmetric R-space $G \cdot \mathfrak{p}$ is given by

$$G \cdot \mathfrak{p} = \begin{array}{cccc} \circ & \circ & \circ & \circ \\ & & | & \\ & & \circ & \\ & & & \times \end{array},$$

which is Rosenfeld's projective plane $\mathbb{P}(\mathbb{C} \otimes \mathbb{O})$ over the bi-octonions $\mathbb{C} \otimes \mathbb{O}$; see [160, §1.5], [16, §4.3], and [29, pp. 313–316] for further details.

Types E₈, F₄ and G₂. Temporarily writing the coefficients of simple roots over the nodes of the Dynkin diagram, the highest roots of $\mathfrak{e}_8(\mathbb{C})$, $\mathfrak{f}_4(\mathbb{C})$ and $\mathfrak{g}_2(\mathbb{C})$ are

$$\begin{array}{cccccc} 2 & 3 & 4 & 5 & 6 & 4 & 2 \\ \circ & \circ & \circ & \circ & \circ & \circ & \circ \\ & & | & & & & \\ & & \circ & & & & \\ & & 3 & & & & \end{array}, \quad \begin{array}{cccc} 2 & 3 & 4 & 2 \\ \circ & \circ & \circ & \circ \\ & & \rightarrow & \end{array} \quad \text{and} \quad \begin{array}{cc} 3 & 2 \\ \circ & \circ \\ \circ & \circ \end{array}$$

respectively, so there are no symmetric R-spaces in these types.

In summary, we have the following classification of irreducible projective parabolic geometries over the complex numbers. Here we choose the rank of \mathfrak{h} to ensure a simple expression for n and consequently the dimension of $G \cdot \mathfrak{p}$.

Theorem 7.44. *The data $\{\mathfrak{h}, \mathfrak{g}, \mathbb{W}\}$ describing the flat model of an irreducible projective parabolic geometry is contained in Table 7.2.*

| Type | \mathfrak{h} | \mathfrak{g} | \mathbb{W} | r | n |
|------------|-----------------------------------|--|--|-----|-----|
| C_{n+1} | $\mathfrak{sp}(2n+2, \mathbb{C})$ | $\mathfrak{sl}(n+1, \mathbb{C})$ | $S_{\mathbb{C}}^2 \mathbb{C}^{n+1}$ | 1 | n |
| A_{2n+1} | $\mathfrak{sl}(2n+2, \mathbb{C})$ | $\mathfrak{sl}(n+1, \mathbb{C}) \oplus \mathfrak{sl}(n+1, \mathbb{C})$ | $\mathbb{C}^{n+1} \boxtimes \overline{\mathbb{C}^{n+1}}$ | 2 | n |
| D_{2n+2} | $\mathfrak{so}(4n+4, \mathbb{C})$ | $\mathfrak{sl}(2n+2, \mathbb{C})$ | $\wedge_{\mathbb{C}}^2 \mathbb{C}^{2n+2}$ | 4 | n |
| E_7 | $\mathfrak{e}_7(\mathbb{C})$ | $\mathfrak{e}_6(\mathbb{C})$ | \mathbb{C}_{27} | 8 | 2 |
| BD_{n+4} | $\mathfrak{so}(n+4, \mathbb{C})$ | $\mathfrak{so}(n+2, \mathbb{C})$ | \mathbb{C}^{n+2} | n | 1 |

Table 7.2: The classification of the complexified flat models of projective parabolic geometries.

Note in particular that there is a unique r for each admissible simple type, so that the classification may be phrased entirely in terms of r .

Remark 7.45. Note that there are some special isomorphisms between the symmetric R-spaces $G \cdot \mathfrak{p}$. Namely, the complexified conformal spheres $\mathbb{C}\mathbb{S}^1$, $\mathbb{C}\mathbb{S}^2$ and $\mathbb{C}\mathbb{S}^4$ are isomorphic to $\mathbb{C}\mathbb{P}^1$, $\mathbb{C}\mathbb{P}^1 \times \mathbb{C}\mathbb{P}^1$ and $\text{Gr}_2(\mathbb{C}^4)$; moreover $\mathbb{C}\mathbb{S}^8$ may be viewed as Rosenfeld's $\mathbb{P}(\mathbb{C} \otimes \mathbb{O})$. This is the origin of Remarks 5.16 and 6.19 which identified $\mathbb{C}\mathbb{P}^n$ and $\mathbb{H}\mathbb{P}^n$ with self-dual conformal structures of dimensions two and four.

We collect some useful numerical data in Table 7.3. By Corollary 7.40, the bracket $[X, \alpha]$ has trace $\frac{1}{2}r(n+1)\alpha(X)$; the value $\text{tr}[X, \alpha] = \frac{1}{2}(n+1)\alpha(X)$ in type C_{n+1} justifies our unusual normalisation convention for the algebraic bracket (4.1) in Chapter 4.

Finally, the highest weights of the graded components of \mathbb{W} and \mathbb{W}^* are collected in Tables B.3 and B.4 respectively. Note in particular that we recover the 1-dimensional representations L defined by (4.12), (5.15) and (6.15) for the classical cases.

| Type | r | n | $\dim \mathbb{W}$ | $\dim(\mathfrak{g}/\mathfrak{p})$ | $\dim B$ | $\frac{1}{2}r(n+1)$ |
|------------|-----|-----|-------------------------|-----------------------------------|---------------------|---------------------|
| C_{n+1} | 1 | n | $\frac{1}{2}(n+1)(n+2)$ | n | $\frac{1}{2}n(n+1)$ | $\frac{1}{2}(n+1)$ |
| A_{2n+1} | 2 | n | $(n+1)^2$ | $2n$ | n^2 | $n+1$ |
| D_{2n+2} | 4 | n | $(n+1)(2n+1)$ | $4n$ | $n(2n-1)$ | $2n+2$ |
| E_7 | 8 | 2 | 27 | 16 | 10 | 12 |
| BD_{n+4} | n | 1 | $n+2$ | n | 1 | n |

Table 7.3: Some useful numerical data for each complex projective parabolic geometry, written in terms of the integers (r, n) .

7.3.2 Real forms

Using Table 7.2, it is a simple task to classify irreducible projective parabolic geometries over \mathbb{R} : we look for real forms where \mathfrak{q} is formed by crossing a single white nodes in \mathfrak{h} ,

which is not joined to any other nodes by an arrow. Tables of simple real Lie algebras may be found in [60, Tbl. B.4]. This classification is also summarised in Table B.2.

Type C_{n+1} . There is a single permitted real form, the split real form $\mathfrak{h} = \mathfrak{sp}(2n+2, \mathbb{R})$ of $\mathfrak{sp}(2n+2, \mathbb{C})$. Then $\mathfrak{g} = \mathfrak{sl}(n+1, \mathbb{R})$, with Satake diagrams

$$\mathfrak{h} = \circ - \circ - \cdots - \circ - \circ \leftarrow \circ \quad \text{and} \quad \mathfrak{g} = \circ - \circ - \cdots - \circ - \circ .$$

The R-space $G \cdot \mathfrak{p}$ is the real projective space \mathbb{RP}^n while $\mathbb{W} = \mathbb{S}^2 \mathbb{R}^{n+1}$ is the space of symmetric real $(n+1) \times (n+1)$ matrices, so that this projective parabolic geometry is projective differential geometry as studied in Chapter 4.

Type A_{2n+1} . There are two permitted real forms:

- The split real form $\mathfrak{h} = \mathfrak{sl}(2n+2, \mathbb{R})$ of $\mathfrak{sl}(2n+2, \mathbb{C})$, so that $\mathfrak{g} = \mathfrak{sl}(n+1, \mathbb{R}) \oplus \mathfrak{sl}(n+1, \mathbb{R})$ and the corresponding Satake diagrams are

$$\mathfrak{h} = \begin{array}{c} \circ - \circ - \cdots - \circ - \circ \\ \circ - \circ - \cdots - \circ - \circ \end{array} \leftarrow \circ \quad \text{and} \quad \mathfrak{g} = \begin{array}{c} \circ - \circ - \cdots - \circ - \circ \\ \circ - \circ - \cdots - \circ - \circ \end{array} .$$

The R-space $G \cdot \mathfrak{p}$ is $\mathbb{RP}^n \times \mathbb{RP}^n$, a product of projective spaces; the resulting geometry should perhaps be called “para-c-projective” geometry. The Jordan algebra \mathbb{W} is the external tensor product $\mathbb{R}^{n+1} \boxtimes \overline{\mathbb{R}^{n+1}}$.

- The real form $\mathfrak{h} = \mathfrak{su}(n+1, n+1)$ of $\mathfrak{sl}(2n+2, \mathbb{C})$, so that $\mathfrak{g} = \mathfrak{sl}(n+1, \mathbb{C})$ is the underlying real Lie algebra and the corresponding Satake diagrams are

$$\mathfrak{h} = \begin{array}{c} \circ - \circ - \cdots - \circ - \circ \\ \circ - \circ - \cdots - \circ - \circ \end{array} \leftarrow \circ \quad \text{and} \quad \mathfrak{g} = \begin{array}{c} \circ - \circ - \cdots - \circ - \circ \\ \circ - \circ - \cdots - \circ - \circ \end{array} \begin{array}{c} \updownarrow \\ \updownarrow \\ \updownarrow \\ \updownarrow \end{array} .$$

The R-space $G \cdot \mathfrak{p}$ is complex projective space \mathbb{CP}^n , viewed as a real manifold with complex structure, corresponding to c-projective geometry as studied in Chapter 5. The Jordan algebra \mathbb{W} is the real representation underlying $\mathbb{C}^{n+1} \boxtimes \overline{\mathbb{C}^{n+1}}$, which may be viewed as the space of $(n+1) \times (n+1)$ hermitian matrices.

Type D_{2n+2} . There are two suitable real forms:

- The split real form $\mathfrak{h} = \mathfrak{so}(4n+4, \mathbb{R})$ of $\mathfrak{so}(4n+4, \mathbb{C})$, so that $\mathfrak{g} = \mathfrak{sl}(2n+2, \mathbb{R})$ is the split real form of $\mathfrak{sl}(2n+2, \mathbb{C})$ and the Satake diagrams of interest are

$$\mathfrak{h} = \circ - \circ - \cdots - \circ - \circ \begin{array}{c} \circ \\ \circ \end{array} \quad \text{and} \quad \mathfrak{g} = \circ - \circ - \cdots - \circ - \circ .$$

The R-space $G \cdot \mathfrak{p}$ is the grassmannian of real 2-planes in \mathbb{R}^{2n+2} , with Jordan algebra $\mathbb{W} = \wedge^2 \mathbb{R}^{n+1}$.

- The real form $\mathfrak{h} = \mathfrak{so}^*(4n + 4)$ of $\mathfrak{so}(4n + 4, \mathbb{C})$, with $\mathfrak{g} = \mathfrak{sl}(n + 1, \mathbb{H})$ and Satake diagrams

$$\mathfrak{h} = \bullet \text{---} \circ \text{---} \cdots \text{---} \circ \text{---} \bullet \begin{cases} \nearrow \bullet \\ \searrow \circ \end{cases} \quad \text{and} \quad \mathfrak{g} = \bullet \text{---} \circ \text{---} \bullet \text{---} \cdots \text{---} \bullet \text{---} \circ \text{---} \bullet .$$

The Lie algebra $\mathfrak{so}^*(4n + 4)$ is described in (6.24). The R-space $G \cdot \mathfrak{p}$ is the quaternionic projective space $\mathbb{H}\mathbb{P}^n$, so that this projective parabolic geometry is almost quaternionic geometry as studied in Chapter 6. The Jordan algebra \mathbb{W} is the real representation underlying $\wedge_{\mathbb{C}}^2 \mathbb{C}^{2n+2}$, which may be viewed as the space of $(n + 1) \times (n + 1)$ quaternion-hermitian matrices.

Type E_7 . There are again two permitted real forms:

- The split real form $\mathfrak{h} = \mathfrak{e}_{7(7)}$ of $\mathfrak{e}_7(\mathbb{C})$ (sometimes called E_V), so that $\mathfrak{g} = \mathfrak{e}_{6(6)}$ (sometimes called E_I) and the Satake diagrams are

$$\mathfrak{h} = \circ \text{---} \circ \text{---} \circ \text{---} \circ \text{---} \circ \text{---} \circ \quad \text{and} \quad \mathfrak{g} = \circ \text{---} \circ \text{---} \circ \text{---} \circ \text{---} \circ .$$

The R-space $G \cdot \mathfrak{p}$ appears to not have a name, but could perhaps be understood in terms of Freudenthal's magic square [81].

- The real form $\mathfrak{h} = \mathfrak{e}_{7(-25)}$ of $\mathfrak{e}_7(\mathbb{C})$ (sometimes called E_{VII}), so that $\mathfrak{g} = \mathfrak{e}_{6(-26)}$ (sometimes called E_{IV}) with Satake diagrams

$$\mathfrak{h} = \circ \text{---} \bullet \text{---} \bullet \text{---} \bullet \text{---} \circ \text{---} \circ \quad \text{and} \quad \mathfrak{g} = \circ \text{---} \bullet \text{---} \bullet \text{---} \bullet \text{---} \circ .$$

The R-space $G \cdot \mathfrak{p}$ is the octonionic (Cayley) plane $\mathbb{O}\mathbb{P}^2$, a non-Desarguesian projective plane discovered by Moufang [148]; see also Baez's treatise [16] on the octonions. The Jordan algebra \mathbb{W} is the exceptional Albert algebra

$$\mathfrak{alb}(3) := \left\{ \begin{pmatrix} a & \alpha & \beta \\ \bar{\alpha} & b & \gamma \\ \bar{\beta} & \bar{\gamma} & c \end{pmatrix} \mid a, b, c \in \mathbb{R}, \alpha, \beta, \gamma \in \mathbb{O} \right\}$$

of 3×3 octonion-hermitian matrices.

Type BD_{n+4} . There are a number of real forms, parameterised by the number of white nodes of the Satake diagram. If there are p white nodes, we have the indefinite real form $\mathfrak{h} = \mathfrak{so}(p + 2, n - p + 2)$ of $\mathfrak{so}(n + 4, \mathbb{C})$. Then \mathfrak{g} is formed by removing the left-most white node, giving $\mathfrak{g} = \mathfrak{so}(p + 1, n - p + 1)$ and Satake diagrams

$$\mathfrak{h} = \underbrace{\circ \text{---} \circ \text{---} \circ \text{---} \cdots \text{---} \circ}_{p+2} \text{---} \bullet \text{---} \cdots \text{---} \bullet \begin{cases} \nearrow \bullet \\ \searrow \bullet \\ \rightarrow \bullet \end{cases} \quad \text{and} \quad \mathfrak{g} = \underbrace{\circ \text{---} \circ \text{---} \cdots \text{---} \circ}_{p+1} \text{---} \bullet \text{---} \cdots \text{---} \bullet \begin{cases} \nearrow \bullet \\ \searrow \bullet \\ \rightarrow \bullet \end{cases} .$$

The R-spaces $H \cdot \mathfrak{q}$ and $G \cdot \mathfrak{p}$ are conformal spheres of signatures $(p + 1, n - p + 1)$ and

$(p, n - p)$ respectively. Note that we allow $p = 0$ and $p = n + 2$, leading to positive-definite and negative-definite conformal geometries. The Jordan algebra \mathbb{W} is the indefinite real inner product space $\mathbb{R}^{p+1, n+1-p}$, equipped with Clifford multiplication.

This classification is summarised in Table B.2. Except in Subsection 8.3.4, we will not need to distinguish between different real forms of each type.

Remark 7.46. Notice that our classification includes the compact rank one riemannian symmetric spaces $\mathbb{R}\mathbb{P}^n$, $\mathbb{C}\mathbb{P}^n$, $\mathbb{H}\mathbb{P}^n$, $\mathbb{O}\mathbb{P}^2$ and \mathbb{S}^n , which are precisely the flat models $G \cdot \mathfrak{p}$ admitting a positive definite metric. By a result of Hirzebruch [99], we obtain a one-to-one correspondence between rank one riemannian symmetric spaces and formally real Jordan algebras. Roughly, the riemannian metric on $G \cdot \mathfrak{p}$ has isometry group a maximal compact subgroup $K \leq G$, giving $G \cdot \mathfrak{p} \cong G/P \cong K/(K \cap P)$ by the second isomorphism theorem. Then the resulting Cartan decomposition $\mathfrak{g} = \mathfrak{k} \oplus \mathfrak{m}$ and homogeneity of G/P allow us to equip \mathfrak{m} with the structure of a formally real Jordan algebra. Koecher's theorem establishes a one-to-one correspondence between formally real Jordan algebras and so-called symmetric cones; $G \cdot \mathfrak{p}$ may be viewed as the space of primitive idempotents in the corresponding cone.

In particular, we could have classified the flat models which admit positive definite metrics either via Cartan's classification of rank one riemannian symmetric spaces [66, 67] or by Jordan, von Neumann and Wigner's classification of formally real Jordan algebras [107]. The data describing $G \cdot \mathfrak{p}$ as a riemannian symmetric space is listed in Table 7.4.

| Type | \mathfrak{h} | G | \mathbb{W} | $G \cdot \mathfrak{p}$ | K |
|------------|-------------------------------------|-----------------------------------|---|--------------------------|-----------------------|
| C_{n+1} | $\mathfrak{sp}(2n + 2, \mathbb{R})$ | $\mathrm{PGL}(n + 1, \mathbb{R})$ | $\mathbb{S}^2\mathbb{R}^{n+1}$ | $\mathbb{R}\mathbb{P}^n$ | $\mathrm{PSO}(n + 1)$ |
| A_{2n+1} | $\mathfrak{su}(n + 1, n + 1)$ | $\mathrm{PGL}(n + 1, \mathbb{C})$ | $(\mathbb{C}^{n+1} \boxtimes \overline{\mathbb{C}^{n+1}})_{\mathbb{R}}$ | $\mathbb{C}\mathbb{P}^n$ | $\mathrm{PSU}(n + 1)$ |
| D_{2n+2} | $\mathfrak{so}^*(4n + 4)$ | $\mathrm{PGL}(n + 1, \mathbb{H})$ | $(\wedge_{\mathbb{C}}^2 \mathbb{C}^{2n+2})_{\mathbb{R}}$ | $\mathbb{H}\mathbb{P}^n$ | $\mathrm{PSp}(n + 1)$ |
| E_7 | $\mathfrak{e}_{7(-25)}$ | $E_{6(-26)}$ | \mathbb{R}_{27} | $\mathbb{O}\mathbb{P}^2$ | $F_{4(-52)}$ |
| BD_{n+4} | $\mathfrak{so}(n + 2, 2)$ | $\mathrm{SO}(n + 1, 1)$ | $\mathbb{R}^{n+1, 1}$ | \mathbb{S}^n | $\mathrm{SO}(n + 1)$ |

Table 7.4: The flat models $G \cdot \mathfrak{p}$ admitting a positive definite metric, together with the corresponding Jordan algebra \mathbb{W} and maximal compact subgroup $K \leq G$.

7.4 Calculus and associated BGG operators

In this subsection, we develop the theory of the important BGG operators for a projective parabolic geometry. For the classical projective structures, the first BGG operator associated to \mathbb{W} controls the family of compatible metrics, while the first BGG operator associated to \mathbb{W}^* is a hessian-type equation.

We begin by deriving some curvature identities in Subsection 7.4.1, some of which hold for general abelian parabolic geometries and others which result from the \mathbb{Z}^2 -grading of Table 7.1. This allows us to describe the first BGG operator associated to \mathbb{W} , which again controls the space of compatible metrics. We do this in Subsection 7.4.2, in particular obtaining a relatively explicit prolongation.

In Subsection 7.4.3 we study the normalised Ricci tensor of a compatible metric, in particular showing that it defines a section of \mathcal{B}^* . In c-projective geometry, this corresponds to the fact that the normalised Ricci tensor of a Kähler metric is symmetric and J -invariant. We also characterise so-called *normal solutions*, which correspond to compatible Einstein metrics. Finally, we describe the first BGG operator associated to \mathbb{W}^* in Subsection 7.4.4, which is again a hessian-type equation. Notably, every compatible metric determines a solution of the hessian.

We fix a projective parabolic geometry over M with parameters (r, n) , where we continue to assume that $n > 0$.

7.4.1 Projective parabolic calculus

Theorem 3.36 says that the curvature tensor R^∇ of a Weyl structure ∇ decomposes into Weyl and normalised Ricci parts according to

$$R^\nabla = W^\nabla - [\text{id} \wedge r^\nabla], \quad (7.17)$$

where by construction $\partial W^\nabla = 0$ and $r^\nabla := -\square_M^{-1} \partial R^\nabla$. The algebraic work of Section 7.2 allows us to extract other useful curvature identities. For this we fix a local frame $\{e_i\}_i$ of M with dual coframe $\{\varepsilon^i\}_i$, often omitting the summation symbol when summing over $i = 1, \dots, rn$.

Proposition 7.47. *There is the Bianchi identity*

$$W_{X,Y}^\nabla \cdot Z + W_{Y,Z}^\nabla \cdot X + W_{Z,X}^\nabla \cdot Y = (d^\nabla T)_{X,Y,Z} \quad (7.18)$$

with respect to any Weyl structure.

Proof. Since TM is abelian, (7.17) and the Bianchi identity for R^∇ give the result. \square

Corollary 7.48. *The Weyl curvature satisfies $\text{tr}(W_{X,Y}^\nabla) = \varepsilon^i((d^\nabla T)_{e_i, X, Y})$. In particular, if $T = 0$ then W^∇ is totally trace-free.*

Proof. The result follows immediately from $\partial W^\nabla = 0$ and Proposition 7.47. \square

By Corollary 7.42, every nowhere-vanishing section ℓ of \mathcal{L} uniquely determines a Weyl structure ∇^ℓ by decreeing that $\nabla^\ell \ell = 0$. If ℓ_1, ℓ_2 are two such sections related

by $\ell_1 = e^f \ell_2$ for some $f \in \Omega^0(M)$, a general section is of the form $\ell = h\ell_1 = he^f \ell_2$ for $h \in \Omega^0(M)$. Then $\nabla^{\ell_1} \ell = dh \otimes \ell_1$ and

$$\nabla^{\ell_2} \ell = d(he^f) \otimes \ell_2 = dh \otimes \ell_1 + df \otimes \ell = \nabla^{\ell_1} \ell + df \otimes \ell,$$

so that $\nabla^{\ell_2} = \nabla^{\ell_1} + \llbracket \cdot, df \rrbracket$ as Weyl connections. In particular ∇^{ℓ_1} and ∇^{ℓ_2} are related by an exact 1-form, so the class of Weyl connections obtained in this manner form an affine space modelled on the exact 1-forms; for this reason they are referred to as *exact Weyl structures* in the literature [59, 60].

Corollary 7.49. $r_X^{\nabla^\ell}(Y) - r_Y^{\nabla^\ell}(X) = -\text{tr}(W_{X,Y}^{\nabla^\ell})$ for every exact Weyl structure $\nabla^\ell \in \llbracket \nabla \rrbracket$. In particular, if $T = 0$ then r^{∇^ℓ} is symmetric.

Proof. Since $\nabla^\ell \ell = 0$ by construction, $R_{X,Y}^{\nabla^\ell} \cdot \ell = 0$ also and hence $\llbracket \text{id} \wedge r^{\nabla^\ell} \rrbracket_{X,Y} \cdot \ell = W_{X,Y}^{\nabla^\ell} \cdot \ell$ by the decomposition (7.17). Applying Lemma 7.39 and Corollary 7.40 then proves the first claim, while the second follows from Corollary 7.48. \square

The differential Bianchi identity $d^\nabla R^\nabla = 0$ also yields some useful curvature identities, generalising Propositions 4.10, 5.9, and 6.11. Since we will soon impose the condition $T = 0$ anyway, we make this assumption now for convenience. In this case Theorem 3.36(3) says that the Weyl curvature W^∇ is invariant, so we write $W := W^\nabla$.

Proposition 7.50. *Suppose that $T = 0$. Then with respect to any Weyl structure:*

- (1) $d^\nabla W = -\llbracket \text{id} \wedge C^\nabla \rrbracket = -\partial^* C^\nabla$;
- (2) *There is a Bianchi identity $C_{X,Y}^\nabla(Z) + C_{Y,Z}^\nabla(X) + C_{Z,X}^\nabla(Y) = 0$; and*
- (3) $\varepsilon^i((\nabla_{e_i} W)_{X,Y}) = -(\square C^\nabla)_{X,Y}$.

Proof. (1) Applying d^∇ to the decomposition (7.17), the differential Bianchi identity $d^\nabla R^\nabla = 0$ yields $d^\nabla W = d^\nabla \llbracket \text{id} \wedge r^\nabla \rrbracket = -\llbracket \text{id} \wedge C^\nabla \rrbracket$ as required.

(2) Taking a trace of both sides in (1), the left-hand side vanishes since W is totally trace-free by Corollary 7.48. On the right-hand side we obtain

$$\begin{aligned} 0 &= \text{tr} \left[\llbracket X, C_{Y,Z}^\nabla \rrbracket + \llbracket Y, C_{Z,X}^\nabla \rrbracket + \llbracket Z, C_{X,Y}^\nabla \rrbracket \right] \\ &= \frac{1}{2} r(n+1) \left[C_{X,Y}^\nabla(Z) + C_{Y,Z}^\nabla(X) + C_{Z,X}^\nabla(Y) \right] \end{aligned}$$

by Corollary 7.40. Since $r(n+1) \neq 0$, the result follows.

(3) We apply ∂ to the differential Bianchi identity. On the left-hand side we obtain

$$\begin{aligned} \partial(d^\nabla W^\nabla)_{X,Y} &= \sum_i \varepsilon^i \cdot (d^\nabla W^\nabla)_{e_i, X, Y} \\ &= \sum_i \varepsilon^i \cdot (\nabla_{e_i} W_{X,Y}^\nabla + \nabla_X W_{Y, e_i}^\nabla + \nabla_Y W_{e_i, X}^\nabla \\ &\quad - W_{[e_i, X], Y}^\nabla - W_{[X, Y], e_i}^\nabla - W_{[Y, e_i], X}^\nabla) \end{aligned}$$

$$\begin{aligned}
&= \sum_i \varepsilon^i \cdot ((\nabla_{e_i} W^\nabla)_{X,Y} + (\nabla_X W^\nabla)_{Y,e_i} + (\nabla_Y W^\nabla)_{e_i,X}) \\
&= \sum_i \varepsilon^i \cdot (\nabla_{e_i} W)_{X,Y}
\end{aligned}$$

since $\partial W = 0$. On the right-hand side, since T^*M acts trivially on itself, we have

$$\partial[\text{id} \wedge C^\nabla] = \partial\partial^*C^\nabla = \square C^\nabla.$$

Therefore $\varepsilon^i ((\nabla_{e_i} W)_{X,Y}) = \partial(d^\nabla W)_{X,Y} = -(\square C^\nabla)_{X,Y}$ as required. \square

Here C^∇ is a section of $\wedge^2 T^*M \otimes T^*M$, which in general is not an irreducible P -bundle. Therefore \square may scale each component independently, as we see in Proposition 5.9(4) for c-projective geometry; in particular, there is not a general formula for $\square C^\nabla$ in terms of the integers (r, n) .

We previously described the components of the harmonic curvature for the classical projective structures, and completeness demands that we do the same for types E_7 and BD_{n+4} . By Subsection 7.3.1, the Hasse diagrams computing the homologies $H_\bullet(\mathfrak{p}^\perp; \mathfrak{g})$ are given by Figures 7.2 and 7.3 respectively.

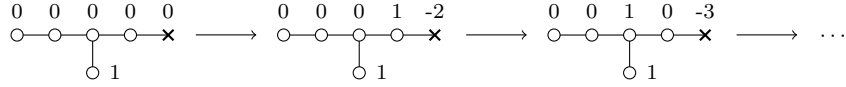

Figure 7.2: The Hasse diagram computing the homology $H_\bullet(\mathfrak{p}^\perp; \mathfrak{e}_6(\mathbb{C}))$.

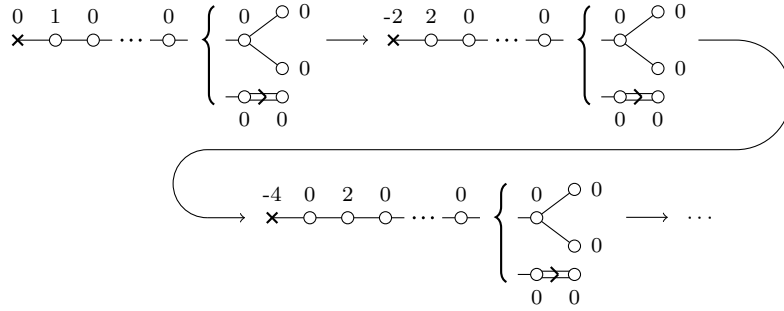

Figure 7.3: The Hasse diagram computing the homology $H_\bullet(\mathfrak{p}^\perp; \mathfrak{so}(n+2, \mathbb{C}))$.

We find a single component of harmonic curvature in type E_7 , which lives in the bundle associated to

$$\begin{aligned}
\begin{array}{c} 0 \quad 0 \quad 1 \quad 0 \quad -3 \\ \circ - \circ - \circ - \circ - \times \\ | \\ \circ \quad 1 \end{array} &= \begin{array}{c} 0 \quad 0 \quad 0 \quad 0 \quad 0 \\ \circ - \circ - \circ - \circ - \times \\ | \\ \circ \quad 1 \end{array} \otimes_{\mathbb{C}} \wedge_{\mathbb{C}}^2 \left(\begin{array}{c} 0 \quad 0 \quad 1 \quad 0 \quad -2 \\ \circ - \circ - \circ - \circ - \times \\ | \\ \circ \quad 0 \end{array} \right) \\
&= \mathbb{C}(TM \otimes \wedge^2 T^*M)
\end{aligned}$$

and may therefore be identified with the Cartan torsion T . In particular, the T is the only obstruction to local flatness for type E_7 , giving flat M locally isomorphic to a real form of $\mathbb{P}(\mathbb{O} \otimes \mathbb{C})$. This makes the assumption $T = 0$ rather unfortunate, but seemingly necessary to obtain any interesting results in the following subsections.

For type BD_{n+4} we again find a single component of harmonic curvature, which of course coincides with (the complexification of) the conformal Weyl curvature W . In particular, the torsion component T vanishes automatically. It is well-known that W gives a complete obstruction to local conformal flatness [29, 43, 165].

7.4.2 Metrisability of projective parabolic geometries

Recall that metrisability of each classical projective structure is controlled by an invariant first-order differential equation, which we called the *linear metric equation*. In each case, this equation was the first BGG operator associated to the irreducible \mathfrak{g} -representation \mathbb{W} .

Definition 7.51. The differential equation $\mathcal{D}^{\mathbb{W}}(h) = 0$ determined by the first BGG operator $\mathcal{D}^{\mathbb{W}}$ associated to \mathbb{W} is called the *linear metric equation*, and its solutions will be called *linear metrics*.

We will see shortly that the (non-degenerate) solutions of $\mathcal{D}^{\mathbb{W}}$ correspond to metrics compatible with the underlying geometric structure. For this, fix a Weyl structure and hence an isomorphism $\mathcal{W} \cong (\mathcal{L}^* \otimes \mathcal{B}) \oplus (\mathcal{L}^* \otimes TM) \oplus \mathcal{L}^*$ by Proposition 7.32. Here $\mathcal{L}^* \otimes \mathcal{B} \cong H_0(\mathfrak{p}^\perp; \mathcal{W})$ and $\mathcal{L} \cong H_0(\mathfrak{p}^\perp; \mathcal{W}^*)$, for \mathcal{B} associated to a \mathfrak{p}^0 -subrepresentation $B \leq S^2(\mathfrak{g}/\mathfrak{p})$. By applying the results of Subsection 7.2.3 to the associated bundles, sections h of $\mathcal{L}^* \otimes \mathcal{B}$ may be viewed as \mathcal{L}^* -valued symmetric bilinear forms on T^*M , defined by $h(\alpha, \beta) := \llbracket [h, \alpha], \beta \rrbracket$. Here $\llbracket \cdot, \cdot \rrbracket$ is the algebraic bracket on \mathfrak{h}_M .

Definition 7.52. A section h of $\mathcal{L}^* \otimes \mathcal{B}$ is *non-degenerate* if it is non-degenerate as an \mathcal{L}^* -valued symmetric bilinear-form on T^*M .

Recall that Proposition 7.38 provides an isomorphism $\mathcal{L} \cong (\wedge^{rn} TM)^{2/r(n+1)}$. Then $(\det h)^{1/r}$ is a section of $\wedge^{rn}(\mathcal{L}^* \otimes \mathcal{B})^{1/r} \cong \mathcal{L}$, and evidently h is non-degenerate if and only if $(\det h)^{1/r}$ is nowhere-vanishing. In this case it follows that $g := (\det h)^{1/r} h^{-1}$ is a non-degenerate section of $S^2 T^*M$, *i.e.* a metric on M . Recall that an element $f \in \mathbb{W}^*$ is called regular if $(\text{ad } f)^2$ factors to an isomorphism $\mathbb{W} \rightarrow \mathbb{W}^*$. Non-degenerate sections of $\mathcal{L}^* \otimes \mathcal{B}$ are a source of regular elements.

Proposition 7.53. *Let h be a non-degenerate section of $\mathcal{L}^* \otimes \mathcal{B}$. Then at every point, $f := h^{-1} + (\det h)^{1/r}$ is a regular element of \mathbb{W}^* .*

Proof. Since h is non-degenerate, $\lambda := (\det h)^{-1/r}$ is a nowhere-vanishing section of \mathcal{L}^* , thus yielding a section λ^{-1} of \mathcal{L} . Applying Proposition 7.6 pointwise, if ξ is the Weyl structure of \mathfrak{q} inducing the splitting $\mathfrak{h}_M \cong \mathcal{W} \oplus \mathfrak{q}_M^0 \oplus \mathcal{W}^*$ then it suffices to find a section e of \mathcal{W} for which $\llbracket e, f \rrbracket = 2\xi$; we show that $e := h + \lambda$ is such a section.

We first compute the two brackets $\llbracket h, h^{-1} \rrbracket$ and $\llbracket \lambda, \lambda^{-1} \rrbracket$. Since both are sections of $\mathfrak{p}_M^0 \oplus \mathfrak{z}(\mathfrak{q}^0)_M$ by the \mathbb{Z}^2 -grading, we can write $\llbracket h, h^{-1} \rrbracket = A + a\xi$ and $\llbracket \lambda, \lambda^{-1} \rrbracket = B + b\xi$ for some $A, B \in \Omega^0(M; \mathfrak{p}_M^0)$ and $a, b \in \Omega^0(M)$. By Table 7.1 we have

$$\begin{aligned} \llbracket \llbracket h, h^{-1} \rrbracket, X \rrbracket &= -\llbracket h, h^{-1}(X, \cdot) \rrbracket = -X \\ \text{and } \llbracket \llbracket \lambda, \lambda^{-1} \rrbracket, X \rrbracket &= \llbracket \lambda X, \lambda^{-1} \rrbracket = X \end{aligned}$$

for all $X \in \Omega^0(M; TM)$, giving $A = -\text{id}$ and $B = \text{id}$ since ξ acts trivially on $TM \leq \mathfrak{q}_M^0$.

The Jacobi identity implies that $\llbracket h, h^{-1} \rrbracket$ acts trivially on sections ℓ of \mathcal{L} . Then

$$0 = \llbracket -\text{id} + a\xi, \ell \rrbracket = \left(\frac{2}{r(n+1)} \text{tr}(-\text{id}) - a \right) \ell = \left(-\frac{2n}{n+1} - a \right) \ell$$

by Corollarys 7.34 and 7.40, whence $a = -\frac{2n}{n+1}$. On the other hand, $\llbracket \lambda, \lambda^{-1} \rrbracket$ acts trivially on sections θ of $\mathcal{L} \otimes \mathcal{B}^*$. Then for all $X, Y \in \Omega^0(M; TM)$, we have

$$\begin{aligned} \llbracket \llbracket \lambda, \lambda^{-1} \rrbracket, \theta \rrbracket(X, Y) &= \llbracket \llbracket \lambda, \lambda^{-1} \rrbracket, \theta(X, Y) \rrbracket \\ &\quad - \theta(\llbracket \llbracket \lambda, \lambda^{-1} \rrbracket, X \rrbracket, Y) - \theta(X, \llbracket \llbracket \lambda, \lambda^{-1} \rrbracket, Y \rrbracket) \\ &= \llbracket \text{id} + b\xi, \theta(X, Y) \rrbracket \\ &\quad - \theta(\llbracket \lambda X, \lambda^{-1} \rrbracket, Y) - \theta(X, \llbracket \lambda Y, \lambda^{-1} \rrbracket) \\ &= \left(\frac{2}{r(n+1)} (\text{tr id}) - b + 2 \right) \theta(X, Y) \\ &= \left(\frac{2n}{n+1} - b + 2 \right) \theta(X, Y) = 0, \end{aligned}$$

whence $b = \frac{2n}{n+1} + 2$. By Table 7.1 and the previous calculations, we then obtain

$$\begin{aligned} \llbracket h + \lambda, h^{-1} + \lambda^{-1} \rrbracket &= \llbracket h, h^{-1} \rrbracket + \llbracket \lambda, \lambda^{-1} \rrbracket \\ &= \left(-\text{id} - \frac{2n}{n+1}\xi \right) + \left(\text{id} + \left(\frac{2n}{n+1} + 2 \right) \xi \right) = 2\xi \end{aligned}$$

as required. The result now follows by Proposition 7.6. \square

Remark 7.54. In the non-self-dual theory mentioned in Remarks 7.18 and 7.43, Proposition 7.53 implies that $\mathcal{L}^* \otimes \mathcal{B}$ admits non-degenerate sections only when $H \cdot \mathfrak{q}$ is self-dual. This is the first place that self-duality becomes a necessary assumption.

Since we are looking for compatible metric connections in the class $[\nabla]$ of Weyl connections, we shall assume henceforth that the torsion T of any Weyl connection

vanishes. As mentioned previously, this assumption has the regrettable side-effect of local flatness for projective parabolic geometries modelled on real forms of $\mathfrak{e}_6(\mathbb{C})$. Since $\delta_\gamma W^\nabla = \llbracket T, \gamma \rrbracket = 0$, the Weyl curvature $W := W^\nabla$ is an invariant.

Our first task is to give an explicit formula for the linear metric equation. For this, we shall need the tractor connection $\nabla^\mathbb{W}$ on \mathcal{W} and its curvature $R^\mathbb{W}$.

Lemma 7.55. *The tractor connection $\nabla^\mathbb{W}$ on \mathcal{W} and its curvature $R^\mathbb{W}$ may be written*

$$\nabla_X^\mathbb{W} \begin{bmatrix} h \\ Z \\ \lambda \end{bmatrix} = \begin{bmatrix} \nabla_X h - \llbracket Z, X \rrbracket \\ \nabla_X Z - \lambda X - h(r_X^\nabla, \cdot) \\ \nabla_X \lambda - r_X^\nabla(Z) \end{bmatrix} \quad (7.19)$$

$$R_{X,Y}^\mathbb{W} \cdot \begin{bmatrix} h \\ Z \\ \lambda \end{bmatrix} = \begin{bmatrix} W_{X,Y}^\nabla \cdot h \\ W_{X,Y}^\nabla \cdot Z - h(C_{X,Y}^\nabla, \cdot) \\ C_{X,Y}^\nabla(Z) \end{bmatrix} \quad (7.20)$$

with respect to any Weyl structure.

Proof. This is immediate from the general formulae $\nabla_X^\mathbb{W} s = X \cdot s + \nabla_X s + r_X^\nabla \cdot s$ and, since the torsion is assumed to vanish, $R_{X,Y}^\mathbb{W} \cdot s = W_{X,Y}^\nabla \cdot s + C_{X,Y}^\nabla \cdot s$. \square

Via the Weyl structure, the algebraic laplacian induces a bundle map $\square : \mathcal{W} \rightarrow \mathcal{W}$ which acts on \mathfrak{p} -irreducible components according to Kostant's Spectral Theorem 2.31.

Lemma 7.56. \square *acts trivially on $\mathcal{L}^* \otimes \mathcal{B}$, by multiplication with $\frac{1}{2}(rn - r + 2)$ on $\mathcal{L}^* \otimes TM$, and by multiplication with rn on \mathcal{L}^* .*

Proof. The first slot is clear, since $\mathcal{L}^* \otimes \mathcal{B}$ is the zeroth homology of \mathcal{W} . Since ∂ acts trivially on \mathcal{W} , the algebraic laplacian is given by $\square s = \partial \partial^* s$ for all $s \in \Omega^0(M; \mathcal{W})$. Then for the second slot,⁵

$$\square Z = \partial \partial^* Z = \partial(\varepsilon^i \otimes \llbracket e_i, Z \rrbracket) = \llbracket \varepsilon^i, \llbracket e_i, Z \rrbracket \rrbracket = -\llbracket \llbracket e_i, \varepsilon^i \rrbracket, Z \rrbracket - \llbracket e_i, \varepsilon^i(Z) \rrbracket$$

Breaking $Z \in \Omega^0(M; \mathcal{L}^* \otimes TM)$ into \mathcal{L}^* - and TM -factors, Corollary 7.40 and the symmetry of the bracket imply that $\llbracket \llbracket e_i, \varepsilon^i \rrbracket, Z \rrbracket = -\varepsilon^i(e_i)Z + \frac{1}{2}r(n+1)Z = -\frac{1}{2}(rn-r)Z$. Since $\llbracket e_i, \varepsilon^i(Z) \rrbracket = -Z$ by Table 7.1, the claim for $\mathcal{L}^* \otimes TM$ follows. Finally, we easily compute that \square acts on \mathcal{L}^* by

$$\square \lambda = -\llbracket \varepsilon^i, \lambda e_i \rrbracket = \varepsilon^i(e_i \lambda) = rn \lambda$$

by the previous results and Corollary 7.34. \square

⁵We continue to suppress summation signs when contracting with respect to a local (co)frame.

Proposition 7.57. *The BGG splitting operator associated to \mathbb{W} is given by*

$$L^{\mathbb{W}} : h \mapsto \begin{bmatrix} h \\ Z^{\nabla} \\ \lambda^{\nabla} \end{bmatrix} := \begin{bmatrix} h \\ \frac{2}{rn-r+2}\varepsilon^i(\nabla_{e_i}h) \\ \frac{2}{rn(rn-r+2)}(\nabla_{e_i,e_j}^2 h)(\varepsilon^i, \varepsilon^j) - \frac{1}{rn}h(r_{e_i}^{\nabla}, \varepsilon^i) \end{bmatrix}. \quad (7.21)$$

Proof. By definition $L^{\mathbb{W}} := \Pi^{\mathbb{W}} \circ \text{repr} : \Omega^0(M; H_0(\mathfrak{p}^{\perp}; \mathcal{W})) \rightarrow \Omega^0(M; \mathcal{W})$ where, since $\text{im}(\text{repr}) \subseteq \ker \partial$, we have $\Pi^{\mathbb{W}}(s) = s - \square_M^{-1} \partial(\text{d}^{\mathbb{W}} s)$; see (3.13). The exterior covariant derivative $\text{d}^{\mathbb{W}}$ coincides with the tractor connection (7.19) on \mathcal{W} , so that

$$\partial(\text{d}^{\mathbb{W}} \text{repr}(h)) = \partial \begin{bmatrix} \nabla h \\ -h(r^{\nabla}, \cdot) \\ 0 \end{bmatrix} = \begin{bmatrix} 0 \\ \llbracket \varepsilon^i, \nabla_{e_i} h \rrbracket \\ -\llbracket \varepsilon^i, h(r_{e_i}^{\nabla}, \cdot) \rrbracket \end{bmatrix} = \begin{bmatrix} 0 \\ -\varepsilon^i(\nabla_{e_i} h) \\ h(r_{e_i}^{\nabla}, \varepsilon^i) \end{bmatrix}$$

with respect to any local frame of M . To compute the action of \square_M^{-1} , we use the Neumann series (3.12). With respect to any Weyl structure, we have

$$(\square_M - \square) \square^{-1} \partial \begin{bmatrix} \nabla h \\ -h(r^{\nabla}, \cdot) \\ 0 \end{bmatrix} = \begin{bmatrix} 0 \\ 0 \\ \frac{2}{rn-r+2}\varepsilon^i(\nabla_{e_i} \varepsilon^j(\nabla_{e_j} h)) \end{bmatrix}$$

by (3.11) and Lemma 7.56. Therefore

$$\begin{aligned} \square_M^{-1} \partial \begin{bmatrix} \nabla h \\ -h(r^{\nabla}, \cdot) \\ 0 \end{bmatrix} &= (\text{id} - \square^{-1}(\square_M - \square)) \square^{-1} \partial \begin{bmatrix} \nabla h \\ -h(r^{\nabla}, \cdot) \\ 0 \end{bmatrix} \\ &= \begin{bmatrix} 0 \\ -\frac{2}{rn-r+2}\varepsilon^i(\nabla_{e_i} h) \\ \frac{1}{rn}h(r_{e_i}^{\nabla}, \varepsilon^i) - \frac{2}{rn(rn-r+2)}(\nabla_{e_i,e_j}^2 h)(\varepsilon^i, \varepsilon^j) \end{bmatrix}. \end{aligned}$$

Using that $\Pi^{\mathbb{W}} = \text{id} - \square_M^{-1} \partial \circ \text{d}^{\mathbb{W}}$, the result follows. \square

By the general theory, the first BGG operator is given by $\mathcal{D}^{\mathbb{W}} := \text{proj} \circ \Pi^{\mathbb{W},1} \circ \nabla^{\mathbb{W}} \circ L^{\mathbb{W}}$. The projection $\Pi^{\mathbb{W},1}$ acts by the identity on homology, so the linear metric equation is the projection of (7.21) onto the non-zero graded component of highest weight. For $r = 1, 2, 4$ and 8 this gives

$$\mathcal{D}^{\mathbb{W}}(h) = \nabla h - \llbracket Z^{\nabla}, \cdot \rrbracket, \quad (7.22)$$

where $Z^{\nabla} := \frac{2}{rn-r+2}\varepsilon^i(\nabla_{e_i} h) \in \Omega^0(M; \mathcal{L}^* \otimes TM)$ is a non-zero multiple of $\partial(\nabla h)$. Equivalently, we may write

$$\nabla h = 0 \pmod{\mathcal{L}^* \otimes TM},$$

where we identify $\mathcal{L}^* \otimes TM$ with its injective image in $\mathcal{L}^* \otimes \mathcal{B}$ via the bracket $Z \mapsto \llbracket Z, \cdot \rrbracket$.

Equation (7.22) is satisfied tautologically when $r = n$: there $\mathcal{L}^* \otimes \mathcal{B} \cong \mathcal{L}$ is 1-dimensional, spanned by the (inverse) conformal metric \mathbf{c} , and the Weyl connections are conformal in the sense that $\nabla \mathbf{c} = 0$ for all $\nabla \in [\nabla]$. Therefore if $h = f\mathbf{c}$ we have $\llbracket \varepsilon^i(\nabla_{e_i} h), \cdot \rrbracket = \llbracket \mathbf{c}(df, \cdot), \cdot \rrbracket = df \otimes \mathbf{c}$ via the isomorphism $\mathcal{L}^* \otimes \mathcal{B} \cong \mathcal{L}$ provided by \mathbf{c} . Therefore the first BGG equation is given by

$$\begin{aligned} \mathcal{D}^{\mathbb{W}^*}(h) &= ((\nabla_{e_i}^2 \cdot h)(\varepsilon^i, \cdot) - h(r^\nabla, \cdot)) \\ &\quad - \frac{1}{n}((\nabla_{e_i, e_j}^2 h)(\varepsilon^i, \varepsilon^j) - h(r_{e_i}^\nabla, \varepsilon^i))\text{id}. \end{aligned} \tag{7.23}$$

Identifying $\mathcal{L}^* \otimes \mathcal{B} \cong \mathcal{L}$ as above, (7.23) may be written as $\mathcal{D}^{\mathbb{W}^*}(\ell) = (\nabla^2 \ell - \ell r^\nabla)_\circ$, where the subscript “ \circ ” denotes the trace-free part with respect to \mathbf{c} . This is the *Einstein scale equation* from conformal geometry, whose solutions parametrise Einstein metrics in the conformal class. In particular, the conformal metric equation has more in common with the previous hessian-type equations; we shall explain this in Subsection 7.4.4.

The invariance of (7.22) and (7.23) of course follow from the fact that they are first BGG operators, so there is no need to do calculations as in Propositions 4.11, 5.10, and 6.12. The variations of the quantities $(h, Z^\nabla, \lambda^\nabla)$ with respect to a Weyl structure are also easily calculated: one finds that

$$\delta_\gamma Z^\nabla = h(\gamma, \cdot) \quad \text{and} \quad \delta_\gamma \lambda^\nabla = \gamma(Z^\nabla). \tag{7.24}$$

By the Taylor expansion (3.7), it follows that $Z^\nabla \mapsto Z^\nabla + h(\gamma, \cdot)$ and $\lambda^\nabla \mapsto \lambda^\nabla + \gamma(Z^\nabla) + \frac{1}{2}h(\gamma, \gamma)$ under change of Weyl structure according to $\nabla \mapsto \nabla + \llbracket \cdot, \gamma \rrbracket$.

Corollary 7.58. *There is a bijection between non-degenerate solutions h of (7.22) and metric connections in the class $[\nabla]$ of Weyl connections.*

Proof. If $h \in \Omega^0(M; \mathcal{L}^* \otimes \mathcal{B})$ is a non-degenerate solution of (7.22) with $\nabla h = \llbracket Z^\nabla, \cdot \rrbracket$, then $h^{-1}(Z^\nabla, \cdot)$ is a 1-form. Hence $\nabla^g := \nabla - \llbracket \cdot, h^{-1}(Z^\nabla, \cdot) \rrbracket \in [\nabla]$ is independent of $\nabla \in [\nabla]$ and satisfies $\nabla^g h = 0$, so that ∇^g is the Levi-Civita connection of the corresponding metric $g := (\det h)^{1/r} h^{-1} \in \Omega^0(M; S^2 T^* M)$. Conversely if $\nabla^g \in [\nabla]$ is the Levi-Civita connection of a metric $g \in \Omega^0(M; \mathcal{B}^*)$, we have $\nabla^g h = 0$ for $h := (\det g)^{1/r(n+1)} g^{-1} \in \Omega^0(M; \mathcal{L}^* \otimes \mathcal{B})$, meaning that h is a solution of (7.22). \square

Since the linear metric equation is a first BGG operator, its solutions are in bijection with the parallel sections of a prolongation operator $d^{\mathcal{W}}$. Thanks to Table 7.1, we can compute this prolongation fairly explicitly. By the differential identity from Proposition 7.50(3), it turns out that in fact $d^{\mathcal{W}}$ is a prolongation connection $\nabla^{\mathcal{W}}$.

Theorem 7.59. *There is a linear isomorphism between solutions of the linear metric equation and the parallel sections of the prolongation connection*

$$\nabla_X^{\mathcal{W}} \begin{bmatrix} h \\ Z \\ \lambda \end{bmatrix} = \begin{bmatrix} \nabla_X h - \llbracket Z, X \rrbracket \\ \nabla_X Z - \lambda X - h(r_X^\nabla, \cdot) \\ \nabla_X \lambda - r_X^\nabla(Z) \end{bmatrix} - \begin{bmatrix} 0 \\ w \partial \llbracket W, h \rrbracket_X \\ \square^{-1} \partial \llbracket C^\nabla - w \square C^\nabla, h \rrbracket_X \end{bmatrix} \quad (7.25)$$

on sections of $\mathcal{W} \cong (\mathcal{L}^* \otimes \mathcal{B}) \oplus (\mathcal{L}^* \otimes TM) \oplus \mathcal{L}^*$, where $w \in \mathbb{R}$ is the eigenvalue of \square^{-1} on $\partial \llbracket W, h \rrbracket$. The isomorphism is given explicitly by the splitting operator (7.21).

Proof. We apply the general prolongation procedure. Equation (7.20) gives

$$\partial \left(R^{\mathbb{W}} \cdot \begin{bmatrix} h \\ Z \\ \lambda \end{bmatrix} \right) = \begin{bmatrix} 0 \\ \partial \llbracket W, h \rrbracket \\ \partial \llbracket W, Z \rrbracket + \partial \llbracket C^\nabla, h \rrbracket \end{bmatrix}.$$

The term $\partial \llbracket W, Z \rrbracket$ vanishes, since $\sum_i \llbracket \varepsilon^i, W_{e_i, X} \cdot Z \rrbracket = -\sum_i \varepsilon^i (W_{e_i, X} \cdot Z) = 0$. Next we have

$$(\square_M - \square) \partial \left(R^\nabla \cdot \begin{bmatrix} h \\ Z \\ \lambda \end{bmatrix} \right) = \varepsilon^i \cdot \left((\nabla_{e_i} + r_{e_i}^\nabla) \begin{bmatrix} 0 \\ \partial \llbracket W, h \rrbracket \\ * \end{bmatrix} \right) = \begin{bmatrix} 0 \\ 0 \\ \partial(\nabla \partial \llbracket W, h \rrbracket) \end{bmatrix},$$

where we do not care about the \mathcal{L}^* -slot since it “drops off the bottom” upon application of ε^i anyway. The Neumann series then gives

$$\square_M^{-1} \partial \left(R^\nabla \cdot \begin{bmatrix} h \\ Z \\ \lambda \end{bmatrix} \right) = \begin{bmatrix} 0 \\ \square^{-1} \partial \llbracket W, h \rrbracket \\ \square^{-1} \partial \llbracket C^\nabla, h \rrbracket - \partial(\nabla \square^{-1} \partial \llbracket W, h \rrbracket) \end{bmatrix}.$$

We next simplify the term $\partial(\nabla \square^{-1} \partial \llbracket W, h \rrbracket)$. Since \square^{-1} acts on $\partial \llbracket W, h \rrbracket$ by a scalar $w \in \mathbb{R}$, it suffices to consider $\partial(\nabla \partial \llbracket W, h \rrbracket)$, which equals

$$\begin{aligned} & \partial(\nabla \partial \llbracket W, h \rrbracket)_X \\ &= \sum_{i,j} \varepsilon^i \cdot (\nabla_{e_i} (\varepsilon^j \cdot \llbracket W_{e_j, X}, h \rrbracket) - \varepsilon^j \cdot \llbracket W_{e_j, \nabla_{e_i}} \cdot X, h \rrbracket) \\ &= -\sum_{i,j} \varepsilon^i \cdot (\nabla_{e_i} (W_{e_j, X} \cdot h(\varepsilon^j, \cdot)) - W_{e_j, \nabla_{e_i} X} \cdot h(\varepsilon^j, \cdot)) \\ &= -\sum_{i,j} \varepsilon^i \cdot ((\nabla_{e_i} W)_{e_j, X} \cdot h(\varepsilon^j, \cdot) + W_{e_j, X} \cdot (\nabla_{e_i} h)(\varepsilon^j, \cdot)) \\ &= -\sum_{i,j} \left(\llbracket \varepsilon^i, \llbracket (\nabla_{e_i} W)_{e_j, X}, h(\varepsilon^j, \cdot) \rrbracket \rrbracket + \llbracket \varepsilon^i, W_{e_j, X} \cdot (\nabla_{e_i} h)(\varepsilon^j, \cdot) \rrbracket \right) \\ &= -\sum_{i,j} \left(\llbracket \llbracket \varepsilon^i, (\nabla_{e_i} W)_{e_j, X} \rrbracket, h(\varepsilon^j, \cdot) \rrbracket + \llbracket (\nabla_{e_i} W)_{e_j, X}, \llbracket \varepsilon^i, h(\varepsilon^j, \cdot) \rrbracket \rrbracket \right. \\ & \quad \left. + \llbracket \varepsilon^i, W_{e_j, X} \cdot \llbracket Z^\nabla, e_i \rrbracket(\varepsilon^j, \cdot) \rrbracket \right). \end{aligned} \quad (7.26)$$

The second term on the right-hand side vanishes, since

$$\begin{aligned}
[[\nabla_{e_i} W]_{e_j, X}, h(\varepsilon^i, \varepsilon^j)] &= [[\nabla_{e_i} W_{e_j, X} - W_{e_j, \nabla_{e_i} X}, h(\varepsilon^i, \varepsilon^j)]] \\
&= \nabla_{e_i} [[W_{e_j, X}, h(\varepsilon^i, \varepsilon^j)]] - [[W_{e_j, X}, \nabla_{e_i} h(\varepsilon^i, \varepsilon^j)]] \\
&\quad - [[W_{e_j, \nabla_{e_i} X}, h(\varepsilon^i, \varepsilon^j)]] \\
&= 0
\end{aligned}$$

as $W_{X, Y}$ acts trivially on \mathcal{L}^* by Corollary 7.48. The third term in (7.26) equals

$$\begin{aligned}
&[[\varepsilon^i, [[W_{e_j, X}, [[Z^\nabla, e_i], \varepsilon^j]]]] \\
&= [[\varepsilon^i, [[W_{e_j, X}, \varepsilon^j(Z^\nabla) e_i + [Z^\nabla, [e_i, \varepsilon^j]]]]]] \\
&= -\varepsilon^j(Z^\nabla)(\text{tr } W_{e_j, X}) + [[\varepsilon^i, [[W_{e_j, X}, [Z^\nabla, [e_i, \varepsilon^j]]]]]] \\
&= [[\varepsilon^i, [[W_{e_j, X}, Z^\nabla], [e_i, \varepsilon^j]]]] + [[\varepsilon^i, [Z^\nabla, [[W_{e_j, X}, e_i], \varepsilon^j]]]] \\
&= [[[\varepsilon^i, [W_{e_j, X}, Z^\nabla]], [e_i, \varepsilon^j]]] + [[W_{e_j, X}, Z^\nabla], [\varepsilon^i, [e_i, \varepsilon^j]]] \\
&\quad + [[\varepsilon^i, [Z^\nabla, [[W_{e_j, X}, e_i], \varepsilon^j]]]] \tag{7.27}
\end{aligned}$$

The first term here is $-\varepsilon^j(e_i)\varepsilon^j(W_{e_j, X} \cdot Z^\nabla) = -(\partial W)_X(Z^\nabla) = 0$ by Lemma 7.39, while the second term equals $\frac{1}{2}r(n+1)[[[W_{e_j, X}, Z^\nabla], \varepsilon^j]] = \frac{1}{2}(\partial W)_X(Z^\nabla) = 0$ by Corollary 7.40. Applying the Bianchi identity (7.18) to the third term and using (7.27) yields

$$\begin{aligned}
&[[\varepsilon^i, [[W_{e_j, X}, [[Z^\nabla, e_i], \varepsilon^j]]]] \\
&= -[[\varepsilon^i, [Z^\nabla, [[W_{X, e_i}, e_j] + [W_{e_i, e_j}, X], \varepsilon^j]]]] \\
&= [[Z^\nabla, [[W_{X, e_i}, e_j], \varepsilon^j], \varepsilon^i]] + [[Z^\nabla, [[W_{e_i, e_j}, X], \varepsilon^j], \varepsilon^i]] \\
&= [[\varepsilon^i(Z^\nabla), [[W_{X, e_i}, e_j], \varepsilon^j]]] + [Z^\nabla, [[W_{e_i, e_j}, X], \varepsilon^j], \varepsilon^i]] \\
&\quad + [[\varepsilon^i(Z^\nabla), [[W_{e_i, e_j}, X], \varepsilon^j]]] + [Z^\nabla, [[W_{e_i, e_j}, X], \varepsilon^j], \varepsilon^i]]
\end{aligned}$$

The first term on the right-hand side equals $\varepsilon^i(Z^\nabla) \text{tr}(W_{X, e_i}) = 0$ by Corollary 7.48. The third term is $-\varepsilon^i(Z^\nabla)(\partial W)_{e_i}(X) = 0$. The last term is symmetric under exchange of ε^i and ε^j , but skew-symmetric under exchange of e_i and e_j ; since we are summing over i, j , this term must vanish. Consequently

$$[[\varepsilon^i, [W_{e_j, X}, [[Z^\nabla, e_i], \varepsilon^j]]]] = [Z^\nabla, [[W_{X, e_i}, e_j], \varepsilon^j], \varepsilon^i]].$$

The inner algebraic bracket is a section of T^*M ; contracting with a vector field Y yields

$$\begin{aligned}
\langle [[[[W_{X, e_i}, e_j], \varepsilon^j], \varepsilon^i], Y \rangle &= \langle W_{X, e_i}, [e_j, [[Y, \varepsilon^i], \varepsilon^j]] \rangle \\
&= \langle W_{X, e_i}, [Y, [[e_j, \varepsilon^i], \varepsilon^j]] + [[Y, \varepsilon^i], [e_j, \varepsilon^j]] \rangle
\end{aligned}$$

$$\begin{aligned}
&= \frac{1}{2}r(n+1)\langle W_{X,e_i}, -[[Y, \varepsilon^i] + [[[Y, \varepsilon^i], \text{id}]] \rangle \\
&= -\frac{1}{2}r(n+1)\varepsilon^i(W_{X,e_i} \cdot Y) \\
&= \frac{1}{2}r(n+1)(\partial W)_X(Y) = 0
\end{aligned}$$

Therefore the third term in (7.27) also vanishes, leaving

$$\begin{aligned}
\partial(\nabla\partial[[W, h]])_X &= -[[[\varepsilon^i, (\nabla_{e_i}W)_{e_j,X}], h(\varepsilon^j, \cdot)]] \\
&= -\varepsilon^i((\nabla_{e_i}W)_{e_j,X}h(\varepsilon^j, \cdot)) \\
&= h((\square C^\nabla)_{e_i,X}, \varepsilon^i)
\end{aligned}$$

by the differential Bianchi identity of Proposition 7.50(3). Reintroducing the eigenvalue $w \in \mathbb{R}$ of \square^{-1} on $\partial[[W, h]]$ now gives the desired formula for the curvature correction. \square

The eigenvalue w of \square^{-1} on $\partial[[W, h]]$ empirically equals $rn/2$, but unfortunately the author could not find a general argument for this.

7.4.3 Normalised Ricci curvature and Einstein metrics

Having described the metrisability of projective parabolic geometries, our next goal is to better understand the normalised Ricci tensor r^g of a compatible metric g . As observed with the classical projective structures, there is a close relationship between r^g and the Ricci curvature Ric^g of the riemannian curvature tensor, which we describe in Proposition 7.64. This allows us to understand the role of Einstein metrics in the theory, generalising Proposition 6.15 in quaternionic geometry. First however, we must develop some algebraic tools for dealing with sections of \mathcal{B}^* .

Lemma 7.60. *Let $g \in \Omega^0(M; \mathcal{B}^*)$ be non-degenerate and suppose that A is a g -self-adjoint section of $\mathfrak{gl}(TM)$. Then $\hat{g} := g(A \cdot, \cdot)$ is a section of \mathcal{B}^* if and only if A is a section of the subbundle $\mathfrak{p}_M^0 \leq \mathfrak{gl}(TM)$.*

Proof. Suppose first that $\hat{g} := g(A \cdot, \cdot)$ is a section of \mathcal{B}^* and let $\pi := (\det g)^{-1/r(n+1)}$. Then since g is non-degenerate, π is nowhere-vanishing and so we may write

$$AX = g^{-1}(\hat{g}(X, \cdot), \cdot) = \pi^{-1}g^{-1}(\pi\hat{g}(X, \cdot), \cdot)$$

for all $X \in \Omega^0(M; TM)$. Using Table 7.1 this gives

$$AX = -\pi^{-1}g^{-1}([\pi\hat{g}, X], \cdot) = [\pi^{-1}g^{-1}, [\pi\hat{g}, X]] = [[\pi^{-1}g^{-1}, \pi\hat{g}], X],$$

where the last equality holds since $\pi^{-1}g^{-1} \in \Omega^0(M; \mathcal{L}^* \otimes \mathcal{B})$ has zero bracket with $X \in \Omega^0(M; TM)$. Here $[\pi^{-1}g^{-1}, \pi\hat{g}]$ is a section of $\mathfrak{p}_M^0 \oplus \mathfrak{z}(\mathfrak{q}^0)_M$. But since $\mathfrak{z}(\mathfrak{q}^0)_M$

acts trivially on TM , it has trivial intersection with $\mathfrak{gl}(TM)$; thus the component of $\llbracket \pi^{-1}g^{-1}, \pi\hat{g} \rrbracket$ in $\mathfrak{z}(\mathfrak{q}^0)_M$ vanishes.

Conversely suppose that $A \in \Omega^0(M; \mathfrak{p}_M^0)$. Then since A is self-adjoint with respect to g , we may write

$$\begin{aligned} \pi g(AX, Y) &= \frac{1}{2}(\pi g(AX, Y) + \pi g(X, AY)) \\ &= -\frac{1}{2}\pi(A \cdot g)(X, Y) \\ &= -\frac{1}{2}\llbracket A, \pi g \rrbracket(X, Y) + \frac{1}{2}\llbracket A, \pi \rrbracket g(X, Y) \\ &= -\frac{1}{2}\llbracket A, \pi g \rrbracket(X, Y) + \frac{\text{tr } A}{r(n+1)}\pi g(X, Y) \end{aligned}$$

by Corollary 7.40. Since the action of \mathfrak{p}_M^0 preserves the subbundle $\mathcal{L} \otimes \mathcal{B}^* \leq \mathcal{W}^*$, it follows that $\pi g(A \cdot, \cdot)$ is a section of $\mathcal{L} \otimes \mathcal{B}^*$, and hence $g(A \cdot, \cdot)$ is a section of \mathcal{B}^* since π is nowhere-vanishing. \square

Lemma 7.60 frames an intuitive notion from c-projective and quaternionic geometry in Lie-theoretic terms: the composition of a hermitian inner product with a self-adjoint endomorphism is hermitian if and only if the endomorphism is complex- or quaternion-linear.

Corollary 7.61. *Suppose that $A \in \Omega^0(M; \mathfrak{p}_M^0)$ is self-adjoint with respect to g . Then $A^k \in \Omega^0(M; \mathfrak{p}_M^0)$ for all $k \in \mathbb{N}$.*

Proof. Suppose that $A^k \in \Omega^0(M; \mathfrak{p}_M^0)$ for some $k \in \mathbb{N}$. Then $g_k := g(A^k \cdot, \cdot)$ is a section of \mathcal{B}^* by Lemma 7.60, so that $g_{k+1} := g_k(A \cdot, \cdot) = g(A^{k+1} \cdot, \cdot)$ is a section of \mathcal{B}^* as well. Then $A^{k+1} \in \Omega^0(M; \mathfrak{p}_M^0)$ by Lemma 7.60 again; now apply induction. \square

We next show that r^g is a section of \mathcal{B}^* whenever g is a compatible metric. Note that this is tautological for conformal geometries: there the metric equation is the Einstein scale equation, and a solution necessarily has r^g a multiple of the metric g in the conformal class. We extract the following technical lemma for later use.

Lemma 7.62. *Let h be a non-degenerate linear metric with corresponding metric $g := (\det h)^{1/r} h^{-1}$. Then $X \mapsto (\det h)^{1/r} \partial \llbracket W, h \rrbracket_X$ defines a g -self-adjoint section of \mathfrak{p}_M^0 .*

Proof. Denote the given endomorphism by $\Phi : X \mapsto (\det h)^{1/r} \partial \llbracket W, h \rrbracket_X$. As an initial sanity check, we note that $\partial \llbracket W, h \rrbracket$ is an $(\mathcal{L}^* \otimes TM)$ -valued 1-form, so that $\Phi(X)$ is a section of TM as required.

We first prove that Φ is self-adjoint with respect to g . Since W acts trivially on \mathcal{L} ,

$$g(\Phi(X), Y) = (\det h)^{1/r} g(\llbracket \varepsilon^i, W_{e_i, X} \cdot h \rrbracket, Y) = -g(W_{e_i, X} \cdot \varepsilon^{i\sharp}, Y)$$

since $W_{e_i, X} \cdot \varepsilon^i = 0$ by virtue of $\partial W = 0$. Then by the Leibniz rule,

$$\begin{aligned} g(W_{e_i, X} \cdot \varepsilon^{i\sharp}, Y) &= -(W_{e_i, X} \cdot g)(\varepsilon^{i\sharp}, Y) - g(\varepsilon^{i\sharp}, W_{e_i, X} \cdot Y) \\ &= -(W_{e_i, X} \cdot g)(\varepsilon^{i\sharp}, Y) - (\partial W)_X(Y). \end{aligned}$$

By Corollary 7.58, the Levi-Civita connection ∇^g of g lies in $[\nabla]$. Then since $R^g \cdot g = 0$ we have $W \cdot g = \llbracket \text{id} \wedge r^g \rrbracket \cdot g$ by (7.17), giving

$$\begin{aligned} (W_{e_i, X} \cdot g)(\varepsilon^{i\sharp}, Y) &= g(\llbracket \text{id} \wedge r^g \rrbracket_{e_i, X}, \varepsilon^{i\sharp}, Y) + g(\varepsilon^{i\sharp}, \llbracket \text{id} \wedge r^g \rrbracket_{e_i, X}, Y) \\ &= g(\llbracket [e_i, r_X^g], \varepsilon^{i\sharp} \rrbracket, Y) - g(\llbracket [X, r_{e_i}^g], \varepsilon^{i\sharp} \rrbracket, Y) \\ &\quad + \varepsilon^i(\llbracket [e_i, r_X^g], Y \rrbracket) - \varepsilon^i(\llbracket [X, r_{e_i}^g], Y \rrbracket) \\ &= \langle \llbracket [e_i, r_X^g], \varepsilon^{i\sharp} \rrbracket^b, Y \rangle - g(\llbracket [X, r_{e_i}^g], \varepsilon^{i\sharp} \rrbracket, Y) \\ &\quad + \frac{1}{2}r(n+1)r_X^g(Y) - \varepsilon^i(\llbracket [X, r_{e_i}^g], Y \rrbracket), \end{aligned} \tag{7.28}$$

where we have evaluated the third term using Corollary 7.40. Using Lemma A.1, the first term above equals

$$\begin{aligned} \langle \llbracket [e_i, r_X^g], \varepsilon^{i\sharp} \rrbracket^b, Y \rangle &= \langle \llbracket [e_i^b, r_X^{g\sharp}], \varepsilon^i \rrbracket, Y \rangle \\ &= \langle \llbracket [r_X^{g\sharp}, e_i^b], Y \rrbracket, \varepsilon^i \rangle \\ &= (2-r)r_X^g(Y) \end{aligned}$$

by Lemma A.3(1), which is also symmetric in X, Y by Corollary 7.49. For the second term on the right-hand side of (7.28), we note that

$$g(\llbracket [X, r_{e_i}^g], \varepsilon^{i\sharp} \rrbracket, Y) = \langle \llbracket [X, r_{e_i}^g], \varepsilon^{i\sharp} \rrbracket^b, Y \rangle = \varepsilon^i(\llbracket [Y, X^b], r_{e_i}^{g\sharp} \rrbracket) \tag{7.29}$$

by using Lemma A.1 again. Writing $\rho : X \mapsto r_X^{g\sharp}$, the symmetry of r^g implies that ρ is self-adjoint with respect to g . Alternating (7.29) in X, Y then yields

$$\varepsilon^i(\llbracket [Y, X^b], r_{e_i}^{g\sharp} \rrbracket - \llbracket [X, Y^b], r_{e_i}^{g\sharp} \rrbracket) = -\text{tr}(\llbracket \text{id} \wedge g \rrbracket_{X, Y} \circ \rho).$$

However, $\llbracket \text{id} \wedge g \rrbracket_{X, Y}$ is skew-adjoint with respect to g by Corollary A.2, while ρ is self-adjoint; therefore the trace vanishes identically and the term $g(\llbracket [X, r_{e_i}^g], \varepsilon^{i\sharp} \rrbracket, Y)$ is symmetric in X, Y . Since the fourth term in (7.28) is evidently symmetric in X, Y , we conclude that $g(W_{e_i, X} \cdot \varepsilon^{i\sharp}, Y)$ is symmetric in X, Y , *i.e.* that Φ is g -self-adjoint.

The proof that Φ defines a section of \mathfrak{p}_M^0 unfortunately requires some case-by-case analysis using the classification of Subsection 7.3.2. For $r = 1$ we have $\mathfrak{p}_M^0 = \mathfrak{gl}(TM)$, so there is nothing to prove. For $r = 8$ we have one of two octonionic geometries, for which the Weyl curvature vanishes identically (see Figure 7.2); thus there is nothing to prove since Φ is identically zero. For $r = n$ we have various conformal geometries,

and a linear metric defines an Einstein metric g . Then r^g is proportional to g , giving $[[\text{id} \wedge r^g]] \cdot g = 0$ and hence $[[W, h]] = 0$; thus $\Phi = 0$ again.

For the remaining geometries, we are going to construct a subbundle $\mathcal{Z} \leq \mathfrak{p}_M^0$ in which the Weyl curvature takes values, and which may be identified with the $\mathfrak{gl}(TM)$ -centraliser of a finite-dimensional subbundle $\mathcal{A} \leq \mathfrak{p}_M^0$ spanned by endomorphisms $\{A_i\}_i$ that satisfy $A_i^2 = \pm \text{id}$, all with the same sign, and $g(A_i \cdot, A_i \cdot) = g(\cdot, \cdot)$. Supposing that we have done this, for each $A \in \Omega^0(M; \mathcal{A})$ we may decompose W into $\pm A$ -hermitian parts as

$$W_{X,Y} = \underbrace{\frac{1}{2}(W_{X,Y} + W_{AX,AY})}_{=: W_{X,Y}^{A+}} + \underbrace{\frac{1}{2}(W_{X,Y} - W_{AX,AY})}_{=: W_{X,Y}^{A-}},$$

where $W_{AX,AY}^{A\pm} = \pm W_{X,Y}^{A\pm}$. Henceforth we write “ \pm ” to mean the sign of $A^2 = \pm \text{id}$. Then since A commutes with $W_{X,Y}$, the Bianchi identity (7.18) gives

$$\begin{aligned} W_{AX,Y}^{A\pm} \cdot Z &= \frac{1}{2}(W_{AX,Y} \cdot Z + W_{X,AY} \cdot Z) \\ &= -\frac{1}{2}(W_{Y,Z} \cdot AX + W_{Z,AX} \cdot Y + W_{AY,Z} \cdot X + W_{Z,X} \cdot AX) \\ &= -\frac{1}{2}A(W_{Y,Z} \cdot X \pm W_{Z,AX} \cdot AY \pm W_{AY,Z} \cdot AX + W_{Z,X} \cdot Y) \\ &= \frac{1}{2}A(W_{X,Y} \cdot Z \pm W_{AX,AY} \cdot Z) \\ &= AW_{X,Y}^{A\pm} \cdot Z, \end{aligned}$$

i.e. $W_{AX,Y}^{A\pm} = A \circ W_{X,Y}^{A\pm}$. Since A is invertible, $\{Ae_i\}_i$ is a local frame of TM with dual coframe $\{\mp A\varepsilon^i\}$; indeed, $\mp A\varepsilon^i(Ae_j) = \pm \varepsilon^i(A^2e_j) = +\delta_{ij}$ as required. Moreover, since g is A -hermitian, we have $AX^b = \mp (AX)^b$. Then

$$\begin{aligned} W_{e_i,X}^{A\pm} \cdot \varepsilon^{i\sharp} &= W_{Ae_i,X}^{A\pm} \cdot A\varepsilon^{i\sharp} \\ &= \mp A^2 W_{e_i,X}^{A\pm} \cdot \varepsilon^{i\sharp} = -W_{e_i,X}^{A\pm} \cdot \varepsilon^{i\sharp}, \end{aligned}$$

which consequently vanishes. Thus the only component of W which contributes to $W_{e_i,X} \cdot \varepsilon^{i\sharp}$ is the component W^\mp which is $\mp A$ -hermitian with respect to all A in our chosen basis of \mathcal{A} , giving $W_{e_i,AX} \cdot \varepsilon^{i\sharp} = AW_{e_i,X} \cdot \varepsilon^{i\sharp}$. By construction of \mathcal{A} , this implies that $\Phi : X \mapsto W_{e_i,X} \cdot \varepsilon^{i\sharp}$ takes values in the subbundle $\mathcal{Z} \leq \mathfrak{p}_M^0$ in which W takes values; in particular, Φ defines a section of \mathfrak{p}_M^0 . It remains to construct the subbundles \mathcal{Z} and \mathcal{A} , which we do on a case-by-case basis:

- For the real form $\mathfrak{g} = \mathfrak{sl}(n+1, \mathbb{C})$ in type A_{2n+1} , we have $\mathfrak{p}^0 = \mathfrak{gl}(n, \mathbb{C})$ and are dealing with c-projective geometry. We may identify \mathfrak{p}_M^0 with the $\mathfrak{gl}(TM)$ -centraliser of the complex structure J , which preserves g and satisfies $J^2 = -\text{id}$. Thus we may take $\mathcal{Z} = \mathfrak{p}_M^0$ and $\mathcal{A} = \langle J \rangle \leq \mathfrak{p}_M^0$ in this case.

- For the split real form $\mathfrak{g} = \mathfrak{sl}(n+1, \mathbb{R}) \oplus \mathfrak{sl}(n+1, \mathbb{R})$ in type A_{2n+1} we have $\mathfrak{p}^0 = \mathfrak{gl}(n, \mathbb{R}) \oplus \mathfrak{gl}(n, \mathbb{R})$, embedded into $\mathfrak{gl}(2n, \mathbb{R})$ as block-diagonal matrices $\begin{bmatrix} A & 0 \\ 0 & B \end{bmatrix}$. A generic element of $\mathfrak{gl}(2n, \mathbb{R})$ lies in \mathfrak{p}^0 if and only if it commutes with $I = \begin{bmatrix} \text{id} & 0 \\ 0 & -\text{id} \end{bmatrix}$, which satisfies $I^2 = \text{id}$, so that $\mathfrak{p}^0 = \mathfrak{z}_{\mathfrak{gl}}(I)$. Moreover from Table B.4 we have

$$B^* = \begin{array}{ccccccc} & 0 & 0 & & 0 & 1 & -2 \\ & \circ & -\circ & \cdots & -\circ & -\circ & \times \\ & & & & & & \\ & \circ & -\circ & \cdots & -\circ & -\circ & \times \\ & 0 & 0 & & 0 & 1 & -2 \end{array} = \mathbb{R}^{n*} \boxtimes \overline{\mathbb{R}^{n*}},$$

where conjugate denotes representations of the second factor. Since I acts by id on \mathbb{R}^{n*} and by $-\text{id}$ on $\overline{\mathbb{R}^{n*}}$, we conclude that elements of B^* are I -hermitian. Thus we may take $\mathcal{Z} = \mathfrak{p}_M^0$ again, and \mathcal{A} to be the span of the endomorphism of TM induced pointwise by I .

- For the real form $\mathfrak{g} = \mathfrak{sl}(n+1, \mathbb{H})$ in type D_{2n+2} , we have $\mathfrak{p}^0 = \mathfrak{gl}(n, \mathbb{H}) \oplus \mathfrak{sp}(1)$ and are dealing with quaternionic geometry. We may take \mathcal{Z} to be the quaternion-linear endomorphisms $\mathfrak{gl}(TM, \mathcal{Q})$ of TM , and \mathcal{A} to be the quaternionic bundle \mathcal{Q} . The Weyl curvature is quaternion-linear by Proposition 6.11(2).
- The split real form $\mathfrak{g} = \mathfrak{sl}(2n+2, \mathbb{R})$ in type D_{2n+2} is the only tricky case. We have $\mathfrak{p}^0 = \mathfrak{s}(\mathfrak{gl}(2n, \mathbb{R}) \oplus \mathfrak{gl}(2, \mathbb{R}))$, giving grassmannian geometry as studied in [60, §4.1.3] and [88]. We embed \mathfrak{p}^0 into $\mathfrak{gl}(4n, \mathbb{R})$ using the outer matrix product

$$(A, \begin{bmatrix} a & b \\ c & d \end{bmatrix}) \mapsto \begin{pmatrix} aA & bA \\ cA & dA \end{pmatrix}.$$

The tangent bundle has highest weight

$$TM = \begin{array}{ccccccc} & 1 & 0 & 0 & & 0 & 0 & 1 \\ & \circ & -\circ & -\circ & \cdots & -\circ & -\circ & \times & -\circ \end{array} = \mathcal{E} \boxtimes \mathcal{H},$$

where \mathcal{E}, \mathcal{H} are associated to the representations $E := \mathbb{R}^{2n}$ and $H := \mathbb{R}^2$, giving

$$\mathfrak{gl}(TM) = (\mathcal{E} \otimes \mathcal{E}^*) \boxtimes (\mathcal{H} \otimes \mathcal{H}^*) = \mathfrak{gl}(\mathcal{E}) \boxtimes \mathfrak{sl}(\mathcal{H}) \oplus \mathfrak{gl}(\mathcal{E}) \boxtimes \mathbb{R};$$

cf. (6.17). The summand $\mathfrak{gl}(\mathcal{E}) \boxtimes \mathbb{R}$ may be viewed as the space of all endomorphisms commuting with $\mathfrak{sl}(\mathcal{H}) \cong \mathfrak{sl}(2, \mathbb{R})$, which is 3-dimensional with basis

$$\begin{bmatrix} \text{id} & 0 \\ 0 & -\text{id} \end{bmatrix}, \quad \begin{bmatrix} 0 & \text{id} \\ \text{id} & 0 \end{bmatrix} \quad \text{and} \quad \begin{bmatrix} \frac{1}{\sqrt{2}}\text{id} & \text{id} \\ \frac{1}{2}\text{id} & -\frac{1}{\sqrt{2}}\text{id} \end{bmatrix}. \quad (7.30)$$

These all satisfy $A^2 = \text{id}$. Moreover

$$\mathcal{B}^* = \begin{array}{ccccccc} & 0 & 0 & & 0 & 1 & 0 & -2 & 0 \\ & \circ & -\circ & \cdots & -\circ & -\circ & -\circ & \times & -\circ \end{array} = \wedge^2 \mathcal{E}^* \boxtimes \wedge^2 \mathcal{H}^*$$

and $\mathfrak{sl}(\mathcal{H})$ acts trivially on $\wedge^2 \mathcal{H}^* \cong \mathbb{R}$, so that $\mathfrak{sl}(\mathcal{H})$ preserves elements of \mathcal{B}^* . Thus we take $\mathcal{A} = \mathfrak{sl}(\mathcal{H})$ with the basis (7.30). By [60, p. 377], the Weyl curvature takes values in $\mathfrak{sl}(\mathcal{E}) \leq \mathcal{Z} := \mathfrak{gl}(\mathcal{E}) \boxtimes \mathbb{R}$.

This exhausts all the remaining real forms, so we are done. \square

Theorem 7.63. *Let h be a non-degenerate solution of the linear metric equation with Levi-Civita connection $\nabla \in [\nabla]$. Then r^g is a section of \mathcal{B}^* .*

Proof. Since $g := (\det h)^{-1/r} h^{-1}$ is a section of \mathcal{B}^* , by Lemma 7.60 it suffices to show that $X \mapsto (r_X^g)^\sharp$ is a section of \mathfrak{p}_M^0 . Evaluating the metric prolongation connection (7.25) with respect to $\nabla = \nabla^g$, we find that $Z^\nabla = 0$ and hence

$$g^{-1}(r^g, \cdot) = -\pi \lambda^g \text{id} - \pi \square^{-1} \partial \llbracket W, h \rrbracket.$$

The first term on the right-hand side clearly lies in \mathfrak{p}_M^0 , and $X \mapsto \pi \partial \llbracket W, h \rrbracket_X$ is a section of \mathfrak{p}_M^0 by Lemma 7.62. Since \mathfrak{p}_M^0 acts on \mathcal{W} preserving the grading, $\llbracket W, h \rrbracket$ lies in the irreducible subbundle $\mathcal{L}^* \otimes \mathcal{B}$, which implies that $\partial \llbracket W, h \rrbracket$ also lies in an irreducible subbundle of $T^*M \otimes \mathcal{W}$. Therefore \square^{-1} acts by a scalar, so we see that $X \mapsto g^{-1}(r_X^g, \cdot)$ is a section of \mathfrak{p}_M^0 as required. \square

For projective differential geometry, $\mathcal{B}^* = \mathbb{S}^2 T^*M$ and this statement is vacuous. In c -projective and quaternionic geometries, Theorem 7.63 amounts to saying that r^g is J - or Q -hermitian. As noted above, this result is tautological for conformal geometries.

With the technical work completed, it is straightforward to relate r^g and Ric^g .

Proposition 7.64. *Let g be a non-degenerate compatible metric with Levi-Civita connection $\nabla^g \in [\nabla]$. Then*

$$\text{Ric}^g = -\frac{1}{2}(rn + 3r - 4)r^g. \quad (7.31)$$

Proof. Since g is non-degenerate and r^g is symmetric, we may write $r^g = g(\rho \cdot, \cdot)$ for some endomorphism $\rho \in \Omega^0(M; \mathfrak{gl}(TM))$ which is evidently self-adjoint with respect to g . Then $\rho \in \Omega^0(M; \mathfrak{p}_M^0)$ by Lemma 7.60 and Theorem 7.63. We have

$$(\rho X)^\flat(Y) = g(\rho X, Y) = g(X, \rho Y) = X^\flat(\rho Y) = -\llbracket \rho, X^\flat \rrbracket(Y)$$

by self-adjointness, so the Ricci curvature Ric^g is given by

$$\begin{aligned} \text{Ric}^g(X, Y) &:= \varepsilon^i (R_{e_i, X}^g \cdot Y) = \varepsilon^i (W_{e_i, X} \cdot Y) - \varepsilon^i (\llbracket \text{id} \wedge r^g \rrbracket_{e_i, X}, Y) \\ &= -\varepsilon^i (\llbracket e_i, (\rho X)^\flat \rrbracket, Y) - \llbracket X, (\rho e_i)^\flat \rrbracket, Y \end{aligned}$$

since $\partial W = 0$. By Corollary 7.40, the first term on the right-hand side evaluates to

$$-\varepsilon^i (\llbracket Y, (\rho X)^\flat \rrbracket, e_i) = -\frac{1}{2}r(n+1)(\rho X)^\flat(Y) = -\frac{1}{2}r(n+1)r_X^g(Y).$$

For the second term, the Jacobi identity yields

$$\begin{aligned}
\varepsilon^i(\llbracket \llbracket X, (\rho e_i)^b \rrbracket, Y \rrbracket) &= -\varepsilon^i(\llbracket \llbracket X, \llbracket \rho, e_i^b \rrbracket \rrbracket, Y \rrbracket) \\
&= -\varepsilon^i(\llbracket \llbracket \llbracket X, \rho \rrbracket, e_i^b \rrbracket, Y \rrbracket + \llbracket \llbracket \rho, \llbracket X, e_i^b \rrbracket \rrbracket, Y \rrbracket) \\
&= -\varepsilon^i(-\llbracket \llbracket \rho X, e_i^b \rrbracket, Y \rrbracket + \llbracket \llbracket \rho, Y \rrbracket, \llbracket X, e_i^b \rrbracket \rrbracket + \llbracket \rho, \llbracket \llbracket X, e_i^b \rrbracket, Y \rrbracket \rrbracket) \\
&= \varepsilon^i(\llbracket \llbracket \rho X, e_i^b \rrbracket, Y \rrbracket) + \varepsilon^i(\llbracket \llbracket X, e_i^b \rrbracket, \rho Y \rrbracket - \varepsilon^i(\rho \llbracket \llbracket X, e_i^b \rrbracket, Y \rrbracket)) \\
&= (2-r)g(\rho X, Y) + (2-r)g(X, \rho Y) - (2-r)g(\rho X, Y) \\
&= (2-r)r_X^g(Y)
\end{aligned}$$

by Lemma A.3. Therefore

$$\begin{aligned}
\text{Ric}^g(X, Y) &= -\frac{1}{2}r(n+1)r_X^g(Y) + (2-r)r_X^g(Y) \\
&= -\frac{1}{2}(rn+3r-4)r_X^g(Y)
\end{aligned}$$

as claimed. \square

Note that (7.31) is much simpler than the formula relating Ric^∇ and r^∇ for an arbitrary Weyl connection $\nabla \in [\nabla]$, which will contain, for example, skew-symmetric components. Indeed, generally we only have that r^∇ is a section of $T^*M \otimes T^*M$, which is not irreducible. The reducible nature of $T^*M \otimes T^*M$ explains why we see different scalings on the irreducible components of r^∇ in the classical cases. Note also that $r^g := -\square_M^{-1}\text{Ric}^g$, so Proposition 7.64 calculates the action of \square_M^{-1} on sections of $\mathcal{B}^* \leq T^*M \otimes T^*M$.

The classification of Theorem 7.44 implies that the constant $\frac{1}{2}(rn+3r-4)$ is always positive for $n > 1$, which equals $\frac{1}{2}(n-1)$ when $r = 1$; equals $n+1$ when $r = 2$; and equals $2n+4$ when $r = 4$. Thus Proposition 7.64 is consistent with Propositions 4.9, 5.9(5) and 6.11(5). It is interesting to note that $\frac{1}{2}(rn+3r-4) = 2(r-1)$ when $n = 1$, implying in particular that r^g cannot be recovered from $\text{Ric}^g = 0$ for 1-dimensional projective structures.

Our description of normalised Ricci curvature allows us to understand the role of Einstein metrics in the theory: they are normal solutions of the linear metric equation.

Definition 7.65. A solution $\sigma \in \Omega^0(M; H_0(\mathfrak{p}^\perp; \mathcal{V}))$ of a first BGG equation is *normal* if it is of the form $\sigma = \pi^\nabla(s)$ for some ∇^∇ -parallel section $s \in \Omega^0(M; \mathcal{V})$.

Equivalently, a solution σ is normal if the curvature corrections of the prolongation connection act trivially on $L^\nabla(\sigma)$.

Theorem 7.66. A non-degenerate linear metric $h \in \Omega^0(M; \mathcal{L}^* \otimes \mathcal{B})$ is a normal solution if and only if the corresponding metric $g := (\det h)^{-1/r} h^{-1}$ is Einstein.

Proof. The proof is similar to the quaternionic case of Proposition 6.15. First suppose that $(h, Z^\nabla, \lambda^\nabla)$ is $\nabla^{\mathbb{W}}$ -parallel. Then writing $\nabla^{\mathbb{W}}$ with respect to the Levi-Civita connection ∇^g of $g := (\det h)^{1/r} g^{-1}$, we have $Z^g = \frac{2}{rn-r+2} \partial(\nabla^g h) = 0$ and hence

$$\nabla_X^{\mathbb{W}} \begin{bmatrix} h \\ Z^g \\ \lambda^g \end{bmatrix} = \begin{bmatrix} 0 \\ -\lambda^g X - h(r_X^\nabla, \cdot) \\ \nabla_X \lambda^g \end{bmatrix} = 0.$$

Therefore λ^∇ is a constant multiple of the global trivialisation $(\det h)^{-1/r}$ of \mathcal{L}^* , say $\lambda^\nabla = c(\det h)^{-1/r}$. Since $\text{Ric}^g = -\frac{1}{2}(rn + 3r - 4)r^g$ by Proposition 7.64, we obtain

$$\text{Ric}^g(X, \cdot) = \frac{1}{2}(rn + 3r - 4)h^{-1}(\lambda^\nabla X, \cdot) = \frac{1}{2}c(rn + 3r - 4)g(X, \cdot)$$

for all vector fields X , *i.e.* that g is Einstein.

Conversely, suppose that g is an Einstein metric. Then $r^g = cg$ for some constant c by Proposition 7.64, a section of \mathcal{B}^* . We must show that the curvature corrections in (7.25) vanish identically. Calculating $\nabla^{\mathcal{W}}$ with respect to the Levi-Civita connection ∇^g of g , the Cotton–York tensor $C^g := d^{\nabla^g} r^g = c(d^{\nabla^g} g) = 0$ clearly vanishes, so it remains to show that $\partial[[W, h]] = 0$. Since W acts trivially on \mathcal{L} , it suffices to show that $W_{e_i, X} \cdot \varepsilon^{i\sharp} = 0$ for all $X \in \Omega^0(M; TM)$, for which

$$W_{e_i, X} \cdot \varepsilon^{i\sharp} = R_{e_i, X}^g \cdot \varepsilon^{i\sharp} + c[[\text{id} \wedge g]]_{e_i, X} \cdot \varepsilon^{i\sharp}. \quad (7.32)$$

For the first term on the right-hand side of (7.32),

$$\begin{aligned} g(R_{e_i, X}^g \cdot \varepsilon^{i\sharp}, Y) &= -\varepsilon^i(R_{e_i, X}^g \cdot Y) \\ &= -\text{Ric}^g(X, Y) = \frac{1}{2}(rn + 3r - 4)r_X^g(Y) \end{aligned}$$

by Proposition 7.64, so that $R_{e_i, X}^g \cdot \varepsilon^{i\sharp} = \frac{1}{2}(rn + 3r - 4)cX$. For the second term on the right-hand side of (7.32),

$$\begin{aligned} g([[\text{id} \wedge g]]_{e_i, X} \cdot \varepsilon^{i\sharp}, Y) &= -g(g^{-1}(\varepsilon^i, \cdot), [[\text{id} \wedge g]]_{e_i, X} \cdot Y) \\ &= -\varepsilon^i([[[e_i, X^\flat], Y] - [[[X, e_i^\flat], Y]]) \\ &= -\frac{1}{2}r(n+1)g(X, Y) + (2-r)g(X, Y) \\ &= -\frac{1}{2}(rn + 3r - 4)g(X, Y) \end{aligned}$$

by Corollary A.2 and Lemma A.3. Therefore

$$W_{e_i, X} \cdot \varepsilon^{i\sharp} = \frac{1}{2}(rn + 3r - 4)r_X^g(Y) - \frac{1}{2}(rn + 3r - 4)cg(X, Y) = 0$$

as required. \square

7.4.4 The hessian equation

For c-projective and quaternionic geometries, the first BGG operator associated to the dual \mathfrak{g} -representation \mathbb{W}^* was a second order hessian equation. For the most part, the same is true in general. As for the metric equation, we start by obtaining an explicit formula for the first BGG operator. We continue to fix a Weyl structure and assume that $T = 0$.

Lemma 7.67. *The tractor connection $\nabla^{\mathbb{W}^*}$ and its curvature $R^{\mathbb{W}^*}$ may be written*

$$\nabla_X^{\mathbb{W}^*} \begin{bmatrix} \ell \\ \eta \\ \theta \end{bmatrix} = \begin{bmatrix} \nabla_X \ell + \eta(X) \\ \nabla_X \eta + \theta(X, \cdot) + \ell r_X^\nabla \\ \nabla_X \theta + \llbracket r_X^\nabla, \eta \rrbracket \end{bmatrix}$$

$$R_{X,Y}^{\mathbb{W}^*} \cdot \begin{bmatrix} \ell \\ \eta \\ \theta \end{bmatrix} = \begin{bmatrix} 0 \\ W_{X,Y} \cdot \eta + C_{X,Y}^\nabla \ell \\ W_{X,Y} \cdot \theta + \llbracket C_{X,Y}^\nabla, \eta \rrbracket \end{bmatrix}$$

with respect to any Weyl structure.

Proof. This follows from the general formulae and the algebraic brackets. \square

Note the different sign conventions in Lemma 7.67 compared to the c-projective hessian (5.25) and quaternionic hessian (6.26), which we intentionally chose to avoid having minus signs throughout those derivations. The signs above are those dictated by our conventions from Chapter 3.

Lemma 7.68. \square *acts trivially on \mathcal{L} , by the identity on $\mathcal{L} \otimes T^*M$, and by multiplication with r on $\mathcal{L} \otimes \mathcal{B}^*$.*

Proof. The ℓ -slot is immediate, since $\mathcal{L} \cong H_0(\mathfrak{p}^\perp; \mathcal{W}^*)$. For the η -slot, we have

$$\square \eta = \partial \partial^* \eta = \llbracket \varepsilon^i, \llbracket e_i, \eta \rrbracket \rrbracket = \llbracket \varepsilon^i, \eta(e_i) \rrbracket = \eta(e_i) \varepsilon^i = \eta.$$

For the θ -slot, we have $\square \theta = \sum_i \llbracket \varepsilon^i, \theta(e_i, \cdot) \rrbracket$ and hence

$$\begin{aligned} (\square \theta)(X, Y) &= \llbracket \llbracket \varepsilon^i, \theta(e_i, \cdot) \rrbracket, X \rrbracket, Y \\ &= -\llbracket \llbracket X, \varepsilon^i \rrbracket, Y \rrbracket, \theta(e_i, \cdot) \rrbracket + \llbracket \llbracket X, \varepsilon^i \rrbracket, \theta(e_i, Y) \rrbracket + \llbracket \llbracket Y, \varepsilon^i \rrbracket, \theta(e_i, X) \rrbracket \\ &= -\theta(e_i, \llbracket X, \varepsilon^i \rrbracket, Y) + 2\theta(X, Y) \end{aligned}$$

by the Jacobi identity. Suppose first that θ is non-degenerate as an \mathcal{L} -valued bilinear form on TM . Then we may write $\theta = \ell g$ for a non-degenerate section g of \mathcal{B}^* , for

which the first term equals

$$\begin{aligned}
-\ell g(e_i, \llbracket [X, \varepsilon^i], Y \rrbracket) &= -\ell \langle e_i^b, \llbracket [X, \varepsilon^i], Y \rrbracket \rangle \\
&= -\ell \varepsilon^i(\llbracket [X, e_i^b], Y \rrbracket) \\
&= (r-2)\theta(X, Y)
\end{aligned}$$

by Lemma A.3. Combining this with the previous expression, we obtain $\square\theta = r\theta$ in the case that θ is non-degenerate. Since the non-degenerate bilinear forms constitute a dense open subset of $\mathcal{L} \otimes \mathcal{B}^*$, the general result follows by continuity. \square

Proposition 7.69. *The BGG splitting operator associated to \mathbb{W}^* is given by*

$$L^{\mathbb{W}^*} : \ell \mapsto \begin{bmatrix} \ell \\ -\nabla\ell \\ \frac{1}{r} \llbracket \varepsilon^i, \nabla_{e_i} \nabla\ell - \ell r_{e_i}^\nabla \rrbracket \end{bmatrix}. \quad (7.33)$$

with respect to any Weyl structure.

Proof. We calculate the operator $\Pi^{\mathbb{W}^*} : \Omega^0(M; \mathcal{W}^*) \rightarrow \Omega^1(M; \mathcal{W}^*)$, which is given by $\Pi^{\mathbb{W}^*}(s) := s - \square_M^{-1} \partial(\nabla^{\mathbb{W}^*} s)$ since $\partial s = 0$ for all $s \in \Omega^0(M; \mathcal{W}^*)$. We have

$$\partial(\nabla^{\mathbb{W}^*} \text{repr}(\ell)) = \varepsilon^i \cdot \begin{bmatrix} \nabla_{e_i} \ell \\ \ell r_{e_i}^\nabla \\ 0 \end{bmatrix} = \begin{bmatrix} 0 \\ (\nabla_{e_i} \ell) \varepsilon^i \\ \llbracket \varepsilon^i, \ell r_{e_i}^\nabla \rrbracket \end{bmatrix},$$

where we note that $(\nabla_{e_i} \ell) \varepsilon^i = \nabla\ell$. To compute the action of \square_M^{-1} , we note that

$$\begin{aligned}
&(\square_M - \square) \square_M^{-1} \partial(\nabla^{\mathbb{W}^*} \text{repr}(\ell)) \\
&= \varepsilon^j \cdot \nabla_{e_j} \begin{bmatrix} 0 \\ \square_M^{-1} \nabla\ell \\ \square_M^{-1} \llbracket \varepsilon^i, \ell r_{e_i}^\nabla \rrbracket \end{bmatrix} + \varepsilon^i \cdot r_{e_j}^\nabla \cdot \begin{bmatrix} 0 \\ \square_M^{-1} \nabla\ell \\ \square_M^{-1} \llbracket \varepsilon^i, \ell r_{e_i}^\nabla \rrbracket \end{bmatrix} = \begin{bmatrix} 0 \\ 0 \\ \llbracket \varepsilon^i, \nabla_{e_i} \nabla\ell \rrbracket \end{bmatrix}.
\end{aligned}$$

The Neumann series (3.12) for \square_M^{-1} then gives

$$\begin{aligned}
\square_M^{-1} \partial(\nabla^{\mathbb{W}^*} \text{repr}(\ell)) &= (\text{id} - \square_M^{-1}(\square_M - \square)) \square_M^{-1} \partial(\nabla^{\mathbb{W}^*} \text{repr}(\ell)) \\
&= \begin{bmatrix} 0 \\ \nabla\ell \\ \frac{1}{r} \llbracket \varepsilon^i, \ell r_{e_i}^\nabla - \nabla_{e_i} \nabla\ell \rrbracket \end{bmatrix}
\end{aligned}$$

by Lemma 7.68. The claimed form of $L^{\mathbb{W}^*}$ now follows. \square

It follows easily that the first BGG operator $\mathcal{D}^{\mathbb{W}^*}$ is given by the projection to the

first homology of

$$\text{proj} \begin{bmatrix} 0 \\ -(\nabla^2 \ell - \ell r^\nabla) + \frac{1}{r} \llbracket \varepsilon^i, \nabla_{e_i} \nabla \ell - \ell r_{e_i}^\nabla \rrbracket \\ \frac{1}{r} \nabla \llbracket \varepsilon^i, \nabla_{e_i} \nabla \ell - \ell r_{e_i}^\nabla \rrbracket \end{bmatrix}. \quad (7.34)$$

Using Corollary 7.48 and the assumption $T = 0$, it is easy to see that $\nabla^2 \ell - \ell r^\nabla$ defines a section of $\mathcal{L} \otimes S^2 T^* M$. The term $\frac{1}{r} \llbracket \varepsilon^i, \nabla_{e_i} \nabla \ell - \ell r_{e_i}^\nabla \rrbracket$ should then be viewed as the projection to $\mathcal{L} \otimes \mathcal{B}^*$ of $\nabla^2 \ell - \ell r^\nabla$; this is made more precise by Proposition 7.72. If the second slot is non-zero, we then have

$$\mathcal{D}^{\mathbb{W}^*}(\ell) = -(\nabla^2 \ell - \ell r^\nabla) + \frac{1}{r} \llbracket \varepsilon^i, \nabla_{e_i} \nabla \ell - \ell r_{e_i}^\nabla \rrbracket, \quad (7.35)$$

the projection away from $\mathcal{L} \otimes \mathcal{B}^*$ inside $\mathcal{L} \otimes S^2 T^* M$. For \mathfrak{h} simple and not of type C_{n+1} , observe that \mathcal{B}^* is complementary to the Cartan square $\odot^2 T^* M$ inside $S^2 T^* M$.

For type C_{n+1} , we have $\mathcal{B}^* = S^2 T^* M$ and one can check that (7.35) is trivial. The first BGG equation is given by projection onto the third slot of (7.34), *i.e.* by the third-order ‘‘Tanno equation’’ [135, 137, 171]

$$\ell \mapsto \llbracket \varepsilon^i, \nabla(\nabla_{e_i} \nabla \ell) - (\nabla \ell) r_{e_i}^\nabla - \ell (\nabla r^\nabla)_{e_i} \rrbracket - \llbracket r^\nabla, \nabla \ell \rrbracket.$$

This is precisely the third-order operator considered in Subsection 5.4.2. This difference is already visible from the representation theory: for type C_{n+1} we have

$$H_0(\mathfrak{p}^\perp; \mathbb{W}^*) = \begin{array}{ccccccc} 0 & 0 & \cdots & 0 & 0 & 2 & \\ \circ & -\circ & \cdots & -\circ & -\circ & \times & \end{array} \quad \text{and} \quad H_1(\mathfrak{p}^\perp; \mathbb{W}^*) = \begin{array}{ccccccc} 0 & 0 & \cdots & 0 & 3 & -4 & \\ \circ & -\circ & \cdots & -\circ & -\circ & \times & \end{array},$$

which have weights $\frac{2n}{n+1}$ and $-\frac{n+3}{n+1}$ respectively, so that the first BGG operator has order $\frac{1}{n+1}(2n + (n+3)) = 3$. There is in fact a second order operator defined on $\mathcal{L}^{1/2}$, but we will not need this here; for $r = 1$ we shall understand that the hessian is trivial.

Definition 7.70. Equation (7.35) is called the *hessian equation*.

Remark 7.71. In the conformal case ($r = n$), the representation \mathbb{W} is isomorphic to its dual via the conformal metric. Therefore the conformal hessian and conformal metric equation coincide: they are both the Einstein scale equation

$$\mathcal{D}^{\mathbb{W}^*} : \begin{array}{ccccccc} 1 & 0 & \cdots & 0 & & & \\ \times & -\circ & \cdots & -\circ & & & \end{array} \left\{ \begin{array}{l} \circ \quad \circ \quad 0 \\ \circ \quad \circ \quad 0 \\ \circ \quad \circ \quad 0 \\ 0 \quad 0 \end{array} \right. \rightarrow \begin{array}{ccccccc} -3 & 2 & \cdots & 0 & & & \\ \times & -\circ & \cdots & -\circ & & & \end{array} \left\{ \begin{array}{l} \circ \quad \circ \quad 0 \\ \circ \quad \circ \quad 0 \\ \circ \quad \circ \quad 0 \\ 0 \quad 0 \end{array} \right.$$

parametrising the family of Einstein scales.

As for the c-projective and quaternionic Hessians, solutions of the hessian equation

may be characterised using exact Weyl structures.

Proposition 7.72. *A nowhere-vanishing section $\ell \in \Omega^0(M; \mathcal{L})$ satisfies $\mathcal{D}^{\mathbb{W}^*}(\ell) = 0$ if and only if the normalised Ricci tensor r^{∇^ℓ} of ∇^ℓ is a section of \mathcal{B}^* .*

Proof. Suppose first that $\mathcal{D}^{\mathbb{W}^*}(\ell) = 0$. Then calculating with respect to ∇^ℓ gives $\ell r^{\nabla^\ell} = \frac{1}{r} \llbracket \varepsilon^i, r_{e_i}^{\nabla^\ell} \rrbracket$, where using Corollary 7.49 we view r^{∇^ℓ} as a section of $S^2 T^*M$ on the left-hand side, and as a T^*M -valued 1-form on the right-hand side. In particular ℓr^{∇^ℓ} is a section of $\mathcal{L} \otimes \mathcal{B}^*$ which, since ℓ is nowhere-vanishing, gives that r^{∇^ℓ} is a section of \mathcal{B}^* . On the other hand, suppose that r^{∇^ℓ} is a section of \mathcal{B}^* . Then

$$\begin{aligned}
\llbracket \varepsilon^i, \ell r_{e_i}^{\nabla^\ell} \rrbracket(X, Y) &= \llbracket \llbracket \llbracket \varepsilon^i, \ell r_{e_i}^{\nabla^\ell} \rrbracket, X \rrbracket, Y \\
&= \llbracket \llbracket \llbracket \varepsilon^i, [e_i, \ell r^{\nabla^\ell}] \rrbracket, X \rrbracket, Y \\
&= \llbracket \llbracket \llbracket \varepsilon^i, e_i \rrbracket, \ell r^{\nabla^\ell} \rrbracket, X \rrbracket, Y \\
&= -\llbracket \llbracket \llbracket [e_i, \varepsilon^i], X \rrbracket, \ell r^{\nabla^\ell} \rrbracket, Y \rrbracket - \llbracket \llbracket [e_i, \varepsilon^i], \ell r_X^{\nabla^\ell} \rrbracket, Y \rrbracket \\
&= -\frac{1}{2}r(n+1)\llbracket \llbracket X, \ell r^{\nabla^\ell} \rrbracket, Y \rrbracket - (rn - \frac{1}{2}r(n+1))\llbracket \ell r_X^{\nabla^\ell}, Y \rrbracket \\
&= \frac{1}{2}r(n+1)\ell r_X^{\nabla^\ell}(Y) - (rn - \frac{1}{2}r(n+1))\ell r_X^{\nabla^\ell}(Y) \\
&= r \ell r_X^{\nabla^\ell}(Y),
\end{aligned}$$

which implies that $\mathcal{D}^{\mathbb{W}^*}(\ell) = \ell r^{\nabla^\ell} - \frac{1}{r}r\ell r^{\nabla^\ell} = 0$ as required. \square

Corollary 7.73. *Let $h \in \Omega^0(M; \mathcal{L}^* \otimes \mathcal{B})$ be a non-degenerate solution of the linear metric equation. Then $\ell := (\det h)^{1/r} \in \Omega^0(M; \mathcal{L})$ is a solution of the hessian.*

Proof. If h is non-degenerate then $\pi := (\det h)^{1/r}$ is a nowhere-vanishing section of \mathcal{L} which is parallel with respect to the Levi-Civita connection ∇^g of h , and $r^g \in \Omega^0(M; \mathcal{B}^*)$ by Theorem 7.63. The result now follows from Proposition 7.72. \square

Finally, the general theory gives an isomorphism between the solution space of the hessian equation and the space of parallel sections of a prolongation connection on \mathcal{W}^* .

Theorem 7.74. *For $r > 1$, there is a linear isomorphism between the solutions of the hessian equation (7.35) and the parallel sections of the prolongation connection*

$$\nabla_X^{\mathcal{W}^*} \begin{bmatrix} \ell \\ \eta \\ \theta \end{bmatrix} = \begin{bmatrix} \nabla_X \ell + \eta(X) \\ \nabla_X \eta - \theta(X, \cdot) + \ell r_X^{\nabla} \\ \nabla_X \theta + \llbracket r_X^{\nabla}, \eta \rrbracket \end{bmatrix} - \square^{-1} \begin{bmatrix} 0 \\ 0 \\ W_{e_i, X} \cdot \llbracket \varepsilon^i, \eta \rrbracket + \llbracket \varepsilon^i, \ell C_{e_i, X}^{\nabla} \rrbracket \end{bmatrix} \quad (7.36)$$

on sections of $\mathcal{W}^* \cong \mathcal{L} \oplus (\mathcal{L} \otimes T^*M) \oplus (\mathcal{L} \otimes \mathcal{B}^*)$. The isomorphism is given explicitly by the splitting operator (7.33). For $r = 1$ the hessian equation is trivial, with solution space isomorphic to $\Omega^0(M; \mathcal{L})$.

Proof. The distinction between $r = 1$ and $r > 1$ is discussed above; for $r > 1$ this is a straightforward application of the general theory. By Lemma 7.67 we have

$$\partial \left(R^{\mathbb{W}^*} \cdot \begin{bmatrix} \ell \\ \eta \\ \theta \end{bmatrix} \right) = \begin{bmatrix} 0 \\ 0 \\ \partial(W \cdot \eta + \ell C^\nabla) \end{bmatrix} \quad (7.37)$$

Since the nilpotent differential operator $\square_M - \square$ appearing in the Neumann series (3.12) necessarily lowers the weight, it acts trivially in (7.37). Therefore

$$\square_M^{-1} \partial \left(R^{\mathbb{W}^*} \cdot \begin{bmatrix} \ell \\ \eta \\ \theta \end{bmatrix} \right) = \square^{-1} \begin{bmatrix} 0 \\ 0 \\ \partial(W \cdot \eta + \ell C^\nabla) \end{bmatrix}.$$

To obtain (7.36), it remains to calculate the action of ∂ . This is immediate for the Cotton–York term, while for the Weyl term we have

$$\partial \llbracket W, \eta \rrbracket_X = \sum_i \llbracket \varepsilon^i, \llbracket W_{e_i, X} \cdot \eta, \rrbracket \rrbracket = \sum_i W_{e_i, X} \cdot \llbracket \varepsilon^i, \eta \rrbracket$$

by the Jacobi identity, since $\partial W = 0$ implies that $\llbracket \varepsilon^i, W_{e_i, X} \rrbracket = \varepsilon^i \circ W_{e_i, X} = 0$. \square

Unfortunately the author was unsuccessful in finding a general expression for the action of \square^{-1} in (7.36). Closed expressions are given by Theorems 5.17 and 6.20 in c-projective and quaternionic geometries. For octonionic geometry, the harmonic curvature consists solely of the Cartan torsion T ; in particular the Weyl curvature vanishes identically. The prolongation of the conformal hessian (*i.e.* the Einstein scale equation) is discussed by Hammerl in [93, 94].

Projective parabolic geometries of mobility two

The classical formulations of projective, c-projective and quaternionic geometries proceed by assuming the existence of a “background” metric and imposing an appropriate equivalence condition. The linear metric equations then become the main equations (4.6), (5.9) and (6.7), with equivalent metrics inducing a 1-parameter family called a *metrisability pencil*. We describe a similar formulation for projective parabolic geometry in Section 8.1, as well as generalising results of Matveev and Topalov [140, 178] on the geodesic flow. A metrisability pencil also induces a 1-parameter family of commuting vector fields, defined using the bilinear differential pairings from the BGG complex, which we study in Section 8.2.

Given a metrisability pencil, it is common to look at the eigenvalues of the corresponding solution A of the main equation. These turn out to be tightly controlled in the classical cases; as we shall see in Section 8.3, similar results hold in the general case. In c-projective geometry these eigenvalues give insight to a classification of pencils [11]; unfortunately the author was unable to make any progress in this direction.

We fix, once and for all, a manifold M supporting a projective parabolic geometry with parameters (r, n) , where we assume that $n > 0$ as per Assumption 7.22. We also continue to assume that the Cartan torsion T vanishes.

8.1 Metrisability pencils and integrability

The linearity of the metric equation (7.22) implies that any two linearly independent solutions h, \hat{h} span a two-dimensional real vector space V of solutions. More invariantly, we can avoid choosing a basis by supposing that a projective parabolic geometry admits a two-dimensional family \mathbf{h} of linear metrics parameterised by V .

Definition 8.1. A (*metrisability*) *pencil* is a family $\mathbf{h} \in \Omega^0(M; \mathcal{L}^* \otimes \mathcal{B} \otimes V^*)$ of linear metrics parameterised by a two-dimensional real vector space V .

Sometimes it will be fruitful to “projectivise” Definition 8.1 as follows. Let $\mathcal{O}_V(1)$ denote the tautological line bundle over the projective line $\mathbb{P}(V)$, whose fibre $\mathcal{O}_V(1)_{[v]}$ over $[v] \in \mathbb{P}(V)$ is the line spanned by v . There is a natural map $\mathbb{P}(V) \times V^* \rightarrow \mathcal{O}_V(1)$ given by $([v], \alpha) \mapsto \alpha(v) \in \mathcal{O}_V(1)_{[v]}$, which induces an isomorphism of V^* with the space of algebraic functions $\mathbb{P}(V) \rightarrow \mathcal{O}_V(1)$ and therefore a *natural lift* $\natural : \mathbb{P}(V) \rightarrow V \otimes \mathcal{O}_V(1)$. We may then identify a pencil \mathbf{h} , which is by definition a section of $\mathcal{L}^* \otimes \mathcal{B} \otimes V^*$ over M , with a section of $\mathcal{L}^* \otimes \mathcal{B} \otimes \mathcal{O}_V(1)$ over $M \times \mathbb{P}(V)$. Indeed, the terminology “pencil” more typically refers to the projective line $\mathbb{P}(V)$.

While the previous definition is more natural, the concreteness obtained by choosing a basis $\{h, \hat{h}\}$ of V is often beneficial. This picture may be projectivised by identifying h, \hat{h} with the points at $\infty, 0$ respectively in an affine chart for $\mathbb{P}(V)$ with affine parameter t ; then any linear metric in the pencil, other than h , is proportional to $h_t := \hat{h} - th$ for some $t \in \mathbb{R}$. As a final ingredient, introduce the endomorphism $A = A(h, \hat{h})$ of T^*M defined by $\hat{h} = h(A \cdot, \cdot)$. Clearly A is self-adjoint with respect to both h, \hat{h} , and moreover defines a section of \mathfrak{p}_M^0 by Lemma 7.60. It follows that A is self-adjoint with respect to any metric h_t in the pencil; of course, we may write $h_t = h(A_t \cdot, \cdot)$ for $A_t := A - \text{tid}$.

Remark 8.2. For conformal geometries, $\mathcal{L}^* \otimes \mathcal{B} \cong \mathcal{L}$ is spanned by the (inverse) conformal metric \mathbf{c} . Since here $\mathfrak{p}_M^0 = \mathfrak{co}(TM) = \mathfrak{so}(TM) \oplus (M \times \mathbb{R})$, any self-adjoint section of \mathfrak{p}_M^0 is necessarily a (functional) multiple of the identity. However, note that this does not obstruct the existence of metrisability pencils: for conformal geometries the first-order linear metric equation (7.22) is trivial, and the second-order equation (7.23) coincides with the hessian equation (7.35). Linear metrics are then Einstein metrics in the conformal class; pencils of Einstein metrics do exist, although they are rare [40, 41].

8.1.1 The pfaffian of a linear metric

Here we formalise a concept used previously. Recall the \mathfrak{g} -representation $\mathbb{W} := \mathfrak{h}/\mathfrak{q}$, and consider its zeroth homology $H_0(\mathfrak{p}^\perp; \mathbb{W}) \cong L^* \otimes B$, where B is a \mathfrak{p}^0 -subrepresentation of $S^2(\mathfrak{g}/\mathfrak{p})$. Any element $h \in L^* \otimes B$ may be viewed as a linear map $h : \mathfrak{p}^\perp \rightarrow L^* \otimes \mathfrak{g}/\mathfrak{p}$, whose determinant is a linear map

$$\det h : L^{-r(n+1)/2} \rightarrow L^{-rn} \otimes L^{r(n+1)/2}$$

since $\wedge^{rn}(\mathfrak{g}/\mathfrak{p}) \cong L^{r(n+1)/2}$ by Proposition 7.38. By an abuse of notation we obtain an element $\det h \in L^r$ by dualising, which coincides with the square of the volume form of h . As usual, $\det h$ vanishes if and only if h is degenerate.

Definition 8.3. The *pfaffian* of h is the element $\text{pf } h := (\det h)^{1/r}$ of L .

In terms of associated bundles, the determinant of a section h of $\mathcal{L}^* \otimes \mathcal{B}$ defines a section of \mathcal{L}^r , yielding a pfaffian $\text{pf } h \in \Omega^0(M; \mathcal{L})$. For a pencil \mathbf{h} of linear metrics, \mathbf{h} is, by definition, a linear functional on V , so that $\det \mathbf{h}$ is a homogeneous polynomial of degree rn on V . We will see in Corollary 8.8 that the pfaffian $\boldsymbol{\pi} := \text{pf } \mathbf{h}$ defines a section of $\mathcal{L} \otimes S^n V^*$ over M , or equivalently a section of $\mathcal{L} \otimes \mathcal{O}_V(n)$ over $M \times \mathbb{P}(V)$, thus giving a polynomial of degree n in any affine chart.

As before, the pfaffian allows us to transform more efficiently between a (non-degenerate) linear metric $h \in \Omega^0(M; \mathcal{L}^* \otimes \mathcal{B})$ and a metric in the usual sense. Indeed, $g := (\text{pf } h)^{-1} h^{-1}$ is a section of $S^2 T^* M$, and taking the top exterior power gives

$$\det g = (\text{pf } h)^{-rn} (\det h)^{-1} = (\text{pf } h)^{-r(n+1)}$$

so that $h = (\det g)^{1/r(n+1)} g^{-1}$. As an immediate result, we may give a more concrete relation between the linear metric equation and the main equations (4.6), (5.9) and (6.7) of projective, c-projective and quaternionic geometries. Consider the endomorphism A associated to two linear metrics h, \hat{h} . Substituting $h = (\det g)^{1/r(n+1)} g^{-1}$ and $\hat{h} = (\det \hat{g})^{1/r(n+1)} \hat{g}^{-1}$ into the defining equation $\hat{h} = h(A \cdot, \cdot)$, we see that

$$A = \left(\frac{\det \hat{g}}{\det g} \right)^{1/r(n+1)} \hat{\mathfrak{H}} \circ \flat \tag{8.1}$$

is just the familiar endomorphism featured in these main equations. Moreover, we have the following characterisation of the section \hat{Z}^∇ of $\mathcal{L}^* \otimes TM$ defined by (7.21).

Proposition 8.4. *Let \mathbf{h} be a metrisability pencil with non-degenerate linear metrics h, \hat{h} at $\infty, 0$ in an affine chart, and form the endomorphism $A = A(h, \hat{h})$. Let ∇ be the Levi-Civita connection of $g := (\text{pf } h)^{-1/r} h^{-1}$ and consider the section \hat{Z}^∇ of $\mathcal{L}^* \otimes TM$ satisfying $\nabla_X \hat{h} = \llbracket \hat{Z}^\nabla, X \rrbracket$. Then $(\text{pf } h) \hat{Z}^\nabla = \frac{1}{r} \text{grad}_g(\text{tr } A)$.*

Proof. Differentiating the identity $\hat{h} = h(A \cdot, \cdot)$ with respect to ∇ yields $\nabla_X \hat{h} = h((\nabla_X A) \cdot, \cdot)$, so that $\nabla_X A = h^{-1} \circ \llbracket \hat{Z}^\nabla, X \rrbracket$. Taking a trace with respect to a local frame $\{e_i\}_i$ with dual coframe $\{\varepsilon^i\}_i$, the left-hand side gives $((\nabla_X A)(\varepsilon^i))(e_i) = d(\text{tr } A)(X)$. The right-hand side gives

$$\begin{aligned} h^{-1}(\llbracket \hat{Z}^\nabla, X \rrbracket(\varepsilon^i, \cdot), e_i) &= \langle \llbracket e_i, h^{-1} \rrbracket, \llbracket \llbracket \hat{Z}^\nabla, X \rrbracket, \varepsilon^i \rrbracket \rangle \\ &= \langle h^{-1}, \llbracket \llbracket \llbracket \hat{Z}^\nabla, X \rrbracket, \varepsilon^i \rrbracket, e_i \rrbracket \rangle \\ &= \langle h^{-1}, \llbracket \llbracket e_i, \varepsilon^i \rrbracket, \llbracket \hat{Z}^\nabla, X \rrbracket \rrbracket \rangle \end{aligned}$$

by the invariance of $\langle \cdot, \cdot \rangle$ and the Jacobi identity. Since $\llbracket \llbracket e_i, \varepsilon^i \rrbracket, X \rrbracket = \frac{1}{2} r(n+1) X$ for all vector fields X by Corollary 7.40, we obtain $\llbracket \llbracket e_i, \varepsilon^i \rrbracket, \hat{Z}^\nabla \rrbracket = -\frac{1}{2} r(n-1) \hat{Z}^\nabla$ by

the Leibniz rule and hence

$$\begin{aligned} \llbracket [e_i, \varepsilon^i], [\hat{Z}^\nabla, X] \rrbracket &= (-\varepsilon^i(e_i) + \tfrac{1}{2}r(n+1)\llbracket \hat{Z}^\nabla, X \rrbracket + \tfrac{1}{2}r(n+1)\llbracket \hat{Z}^\nabla, X \rrbracket \\ &= r\llbracket \hat{Z}^\nabla, X \rrbracket \end{aligned}$$

by the Jacobi identity. Then $\text{tr}(h^{-1} \circ \llbracket \hat{Z}^\nabla, X \rrbracket) = r\langle h^{-1}, \llbracket \hat{Z}^\nabla, X \rrbracket \rangle = rh^{-1}(\hat{Z}^\nabla, X)$. Thus $d(\text{tr } A) = rh^{-1}(\hat{Z}^\nabla, \cdot)$, so that writing $h^{-1} = (\text{pf } h)g$ and applying \sharp to both sides completes the proof. \square

8.1.2 Adjugate tensors

In addition to the pfaffian, there is another operation that we can perform on linear metrics. By definition the flat model of a projective parabolic geometry has a projective embedding $G \cdot \mathfrak{p} \hookrightarrow \mathbb{P}(\mathbb{W})$, so that Kostant's Theorem 2.25 tells us that $G \cdot \mathfrak{p}$ is an intersection of quadrics whose defining equations are given by projection away from the Cartan square in $S^2\mathbb{W}$. We let $\mathbb{U} := S^2\mathbb{W}/\odot^2\mathbb{W}$, so that (2.2) identifies $\mathbb{U}^* \subseteq S^2\mathbb{W}^*$ with the quadratic defining equations of $G \cdot \mathfrak{p}$.

Proposition 8.5. $H_0(\mathfrak{p}^\perp; \mathbb{U}^*) \cong L^2 \otimes B^*$.

Proof. It suffices to consider the case that \mathfrak{h} is simple. Then by Proposition 7.32, the \mathfrak{g} -representation \mathbb{W}^* has associated graded representation $\mathbb{W}^* \cong L \oplus (L \otimes \mathfrak{p}^\perp) \oplus (L \otimes B^*)$ with respect to any algebraic Weyl structure for \mathfrak{p} . Therefore

$$\begin{aligned} S^2\mathbb{W}^* &\cong L^2 \oplus (L^2 \otimes \mathfrak{p}^\perp) \oplus (L^2 \otimes B^*) \oplus (L^2 \otimes S^2\mathfrak{p}^\perp) \\ &\quad \oplus (L^2 \otimes \mathfrak{p}^\perp \otimes B^*) \oplus (L^2 \otimes S^2B^*), \end{aligned} \tag{8.2}$$

so it suffices to exhibit $L^2 \otimes B^*$ as the highest weight summand *not* lying in $\odot^2\mathbb{W}^*$. By (7.13), the summands of (8.2) are written in order of non-increasing weight.

Since $\odot^2\mathbb{W}^*$ is the highest weight \mathfrak{g} -subrepresentation of $S^2\mathbb{W}^*$, its associated graded representation must contain the highest weight summand L^2 of $S^2\mathbb{W}^*$. Dualising, it follows also that $\odot^2\mathbb{W}^*$ contains the lowest weight irreducible summand, which is an irreducible \mathfrak{p}^0 -subrepresentation of $L^2 \otimes S^2B^*$. Then the associated graded of $\odot^2\mathbb{W}^*$ must contain at least one irreducible summand of each weight between the weights of its highest and lowest components; *cf.* [50, Eqn. (2.3)]. The only summand in (8.2) of the same weight as $\mathfrak{p}^\perp \cdot L^2$ is $L^2 \otimes \mathfrak{p}^\perp$, so this must lie in $\odot^2\mathbb{W}^*$. In all cases except $r = 1$, Table 7.2 implies that B^* is complementary to the Cartan square in $S^2\mathfrak{p}^\perp$; thus in these cases $L^2 \otimes B^*$ cannot lie in $\odot^2\mathbb{W}^*$, so is the highest weight summand. For $r = 1$, we have $B^* = S^2\mathfrak{p}^\perp$ and thus have two copies of $L^2 \otimes S^2\mathfrak{p}^\perp$. The kernel of the anti-diagonal action of \mathfrak{p}^\perp on $(L^2 \otimes B^*) \oplus (L^2 \otimes B^*)$ lies in $\odot^2\mathbb{W}^*$ by the results

of [74], so that its complement forms a highest weight component of \mathbb{U}^* isomorphic to $L^2 \otimes B$. Thus in all cases, $L^2 \otimes B^*$ is a highest weight summand in $\text{gr}(\mathbb{U}^*)$. Since B^* is irreducible and the remaining summands in (8.2) have strictly lower weights, we conclude that $H_0(\mathfrak{p}^\perp; \mathbb{U}^*) \cong L^2 \otimes B^*$. \square

Let us calculate the complex representation $\mathbb{U}^* \leq S^2\mathbb{W}^*$ for each irreducible complex projective parabolic geometry, as well as its graded components, using Table 7.2. For notational convenience, we identify all representations and Lie algebras with their complexifications. This information is summarised in Table B.5.

Type \mathbf{C}_{n+1} . Here $\mathfrak{g} = \mathfrak{sl}(n+1, \mathbb{C})$ and $\mathbb{W}^* = S^2\mathbb{C}^{n+1*}$, giving $S^2\mathbb{W}^* \cong S^4\mathbb{C}^{n+1*} \oplus \odot^2 \wedge^2 \mathbb{C}^{n+1*}$. The Cartan square is $\odot^2 \mathbb{W}^* = S^4\mathbb{C}^{n+1*}$, so that

$$\begin{aligned} \mathbb{U}^* &= \begin{array}{cccccc} 0 & 0 & & 0 & 2 & 0 \\ \circ & -\circ & \cdots & -\circ & -\circ & -\circ \end{array} = \odot^2 \wedge^2 \mathbb{C}^{n+1*} \\ &\cong \begin{array}{cccccc} 0 & 0 & & 0 & 2 & 0 \\ \circ & -\circ & \cdots & -\circ & -\circ & \times \end{array} \oplus \begin{array}{cccccc} 0 & 0 & & 0 & 1 & 1 & -1 \\ \circ & -\circ & \cdots & -\circ & -\circ & -\circ & \times \end{array} \oplus \begin{array}{cccccc} 0 & 0 & & 0 & 2 & 0 & -2 \\ \circ & -\circ & \cdots & -\circ & -\circ & -\circ & \times \end{array} . \\ &\quad \quad \quad L^2 \otimes B^* \quad \quad \quad L^2 \otimes \mathfrak{p}^\perp \otimes \wedge^2 \mathfrak{p}^\perp \quad \quad \quad L^2 \otimes \odot^2 \wedge^2 \mathfrak{p}^\perp \end{aligned}$$

Type \mathbf{A}_{2n+1} . Here $\mathfrak{g} = \mathfrak{sl}(n+1, \mathbb{C}) \oplus \mathfrak{sl}(n+1, \mathbb{C})$ and $\mathbb{W}^* = \mathbb{C}^{n+1*} \boxtimes \overline{\mathbb{C}^{n+1*}}$, giving $S^2\mathbb{W}^* \cong (S^2\mathbb{C}^{n+1*} \boxtimes S^2\overline{\mathbb{C}^{n+1*}}) \oplus (\wedge^2 \mathbb{C}^{n+1*} \boxtimes \wedge^2 \overline{\mathbb{C}^{n+1*}})$. The first summand here is the Cartan square, so that

$$\begin{aligned} \mathbb{U}^* &= \begin{array}{cccccc} 0 & 0 & & 0 & 1 & 0 \\ \circ & -\circ & \cdots & -\circ & -\circ & -\circ \end{array} = \wedge^2 \mathbb{C}^{n+1*} \boxtimes \wedge^2 \overline{\mathbb{C}^{n+1*}} \\ &\cong \begin{array}{cccccc} 0 & 0 & & 0 & 1 & 0 \\ \circ & -\circ & \cdots & -\circ & -\circ & \times \\ 0 & 0 & & 0 & 1 & 0 \end{array} \oplus \left[\begin{array}{cccccc} 0 & 0 & & 0 & 1 & 0 & -1 \\ \circ & -\circ & \cdots & -\circ & -\circ & -\circ & \times \\ \circ & -\circ & \cdots & -\circ & -\circ & -\circ & \times \\ 0 & 0 & & 0 & 0 & 1 & 0 \end{array} \oplus \mathbb{C}\mathfrak{c} \right] \oplus \begin{array}{cccccc} 0 & 0 & & 0 & 1 & 0 & -1 \\ \circ & -\circ & \cdots & -\circ & -\circ & -\circ & \times \\ \circ & -\circ & \cdots & -\circ & -\circ & -\circ & \times \\ 0 & 0 & & 0 & 1 & 0 & -1 \end{array} \\ &\quad \quad \quad L^2 \otimes B^* \quad \quad \quad (L^2 \otimes \wedge^{1,0} M \otimes \wedge^{0,2} M) \oplus \mathbb{C}\mathfrak{c} \quad \quad \quad L^2 \otimes \wedge^{1,1} M \end{aligned}$$

where by $\mathbb{C}\mathfrak{c}$ we mean the complex-conjugate representation.

Type \mathbf{D}_{2n+2} . Here $\mathfrak{g} = \mathfrak{so}(4n+4, \mathbb{C})$ and $\mathbb{W}^* = \wedge^2 \mathbb{C}^{2n+2*}$, thus giving $S^2\mathbb{W}^* \cong \odot^2 \wedge^2 \mathbb{C}^{2n+2*} \oplus \wedge^4 \mathbb{C}^{2n+2*}$. By [74] the Cartan square consists of the trace-free symmetric elements; therefore

$$\begin{aligned} \mathbb{U}^* &= \begin{array}{cccccc} 0 & & 0 & 1 & 0 & 0 & 0 \\ \circ & \cdots & -\circ & -\circ & -\circ & -\circ & -\circ \end{array} = \wedge^4 \mathbb{C}^{2n+2*} \\ &\cong \begin{array}{cccccc} 0 & & 0 & 1 & 0 & 0 & 0 \\ \circ & \cdots & -\circ & -\circ & -\circ & \times & -\circ \end{array} \oplus \begin{array}{cccccc} 0 & & 0 & 1 & 0 & 0 & -1 & 1 \\ \circ & \cdots & -\circ & -\circ & -\circ & -\circ & \times & -\circ \end{array} \oplus \begin{array}{cccccc} 0 & & 0 & 1 & 0 & 0 & 0 & -1 & 0 \\ \circ & \cdots & -\circ & -\circ & -\circ & -\circ & -\circ & \times & -\circ \end{array} . \\ &\quad \quad \quad \wedge^2 E^* \otimes \wedge^2 H \quad \quad \quad \wedge^3 E^* \otimes H \quad \quad \quad \wedge^4 E^* \end{aligned}$$

The representations $E \cong \mathbb{C}^{2n}$ and $H \cong \mathbb{C}^2$ are defined in (6.13).

Type E₇. Here $\mathfrak{g} = \mathfrak{e}_6(\mathbb{C})$ and \mathbb{W}^* is dual to the 27-dimensional representation \mathbb{C}_{27} of $\mathfrak{e}_6(\mathbb{C})$. Calculating using LiE,¹ the symmetric square decomposes as

$$S^2 \left(\begin{array}{cccccc} 0 & 0 & 0 & 0 & 1 & \\ \circ & \circ & \circ & \circ & \circ & \\ & & & & & \circ \\ & & & & & | \\ & & & & & 0 \end{array} \right) \cong \begin{array}{cccccc} 0 & 0 & 0 & 0 & 2 & \\ \circ & \circ & \circ & \circ & \circ & \\ & & & & & \circ \\ & & & & & | \\ & & & & & 0 \end{array} \oplus \begin{array}{cccccc} 1 & 0 & 0 & 0 & 0 & \\ \circ & \circ & \circ & \circ & \circ & \\ & & & & & \circ \\ & & & & & | \\ & & & & & 0 \end{array},$$

where the first summand is the Cartan square and the second is \mathbb{C}_{27} . Therefore

$$\begin{aligned} \mathbb{U}^* &= \begin{array}{cccccc} 1 & 0 & 0 & 0 & 0 & \\ \circ & \circ & \circ & \circ & \circ & \\ & & & & & \circ \\ & & & & & | \\ & & & & & 0 \end{array} = \mathbb{C}_{27} \\ &\cong \begin{array}{cccccc} 1 & 0 & 0 & 0 & 0 & \\ \circ & \circ & \circ & \circ & \times & \\ & & & & & \circ \\ & & & & & | \\ & & & & & 0 \end{array} \oplus \begin{array}{cccccc} 0 & 0 & 0 & 0 & -1 & \\ \circ & \circ & \circ & \circ & \times & \\ & & & & & \circ \\ & & & & & | \\ & & & & & 1 \end{array} \oplus \begin{array}{cccccc} 0 & 0 & 0 & 0 & -1 & \\ \circ & \circ & \circ & \circ & \times & \\ & & & & & \circ \\ & & & & & | \\ & & & & & 0 \end{array} \cong \mathbb{W}. \\ &\quad L^* \otimes B \quad \quad L^* \otimes \mathfrak{g}/\mathfrak{p} \quad \quad L^* \end{aligned}$$

Notice in particular that $\mathbb{U}^* \cong \mathbb{W}$.

Type BD_{n+4}. Here $\mathfrak{g} = \mathfrak{so}(n+2, \mathbb{C})$ and $\mathbb{W}^* = \mathbb{C}^{n+2*}$. Since the Cartan product in the orthogonal algebras is the trace-free symmetric product, $S^2\mathbb{W}^* \cong S^2_{\circ}\mathbb{W}^* \oplus \mathbb{C}$. Therefore \mathbb{U}^* is the trivial representation,

$$\mathbb{U}^* = \begin{array}{cccc} 0 & 0 & \dots & 0 \\ \circ & \circ & & \circ \end{array} \left\{ \begin{array}{l} \begin{array}{ccc} & \circ & 0 \\ & / & \backslash \\ \circ & & \circ \\ & \backslash & / \\ & \circ & 0 \end{array} \\ \begin{array}{ccc} \circ & \circ & \\ / & \backslash & \\ \circ & & \circ \\ \backslash & / & \\ \circ & & \circ \end{array} \\ \begin{array}{ccc} \circ & \circ & \\ \backslash & / & \\ \circ & & \circ \\ / & \backslash & \\ \circ & & \circ \end{array} \end{array} \right. = \mathbb{C}$$

This conforms with what we know already: in type BD_{n+4} we have $\mathbb{W} \cong \mathbb{W}^*$ and hence $L^2 \otimes B^* \cong L \otimes L^* \cong \mathbb{C}$ must be the trivial representation.

Recalling that $L^* \otimes B = H_0(\mathfrak{p}^\perp; \mathbb{W})$ and $L = H_0(\mathfrak{p}^\perp; \mathbb{W}^*)$, the pairing $(L^2 \otimes B^*) \times (L^* \otimes B) \rightarrow L$ is really a pairing on Lie algebra homology, so is induced by a \mathfrak{p} -invariant pairing $\mathbb{U}^* \times \mathbb{W} \rightarrow \mathbb{W}^*$ of \mathfrak{g} -representations. Dualising then yields a map $\text{adj} : L^* \otimes B \rightarrow L^2 \otimes B^*$ such that the contraction $\langle \text{adj } h, h \rangle$ equals $\text{pf } h$ for all $h \in L^* \otimes B$.

Definition 8.6. The image of $h \in L^* \otimes B$ under the map $\text{adj} : L^* \otimes B \rightarrow L^2 \otimes B^*$ is called the *adjugate* of h , denoted by $h^* := \text{adj } h$.

Clearly if $h \in L^* \otimes B$ is non-degenerate then the condition $\langle h^*, h \rangle = \text{pf } h$ implies that $h^* = (\text{pf } h)h^{-1} = (\det h)^{1/r}h^{-1}$.

Proposition 8.7. *Given linearly independent elements $h, \hat{h} \in L^* \otimes B$, the adjugate of $h_t := \hat{h} - th$ is a polynomial of degree $n - 1$ in t .*

¹An online service is available at <http://wwwmathlabo.univ-poitiers.fr/~maavl/LiE/form.html>.

Proof. We complexify h_t and proceed on a case-by-case basis using Theorem 7.44. In each case, the construction is evidently polynomial of degree $n - 1$ in t .

For $r = 1$, we view h_t as a linear map $\mathfrak{p}^\perp \rightarrow L^* \otimes \mathfrak{g}/\mathfrak{p}$. Via the non-degenerate pairing $\wedge : \mathfrak{g}/\mathfrak{p} \times \wedge^{n-1} \mathfrak{g}/\mathfrak{p} \rightarrow \wedge^n \mathfrak{g}/\mathfrak{p} \cong L^{r(n+1)/2}$, the $(n-1)$ -fold wedge power $\wedge^{n-1} h_t : \wedge^{n-1} \mathfrak{p}^\perp \rightarrow L^{-n+1} \otimes \wedge^{n-1} \mathfrak{g}/\mathfrak{p}$ may be viewed as the adjugate linear map $\mathfrak{g}/\mathfrak{p} \rightarrow L^2 \otimes \mathfrak{p}^\perp$. The contraction with h_t is the n -fold wedge power, which is $\det h_t = \text{pf } h_t$ by definition.

For $r = 2$ we have $(L^* \otimes B)_\mathbb{C} \cong L^{-1,-1} \otimes S_\mathbb{C}^{1,1}(\mathfrak{g}/\mathfrak{p})$, where we retain notation from Chapter 5. Then h_t defines a conjugate-linear map $h_t : \wedge_\mathbb{C}^{1,0} \rightarrow L^{-1,-1} \otimes T^{0,1}$, whose $(n-1)$ -wedge power yields a conjugate-linear adjugate map $T^{1,0} \rightarrow L^{2,2} \otimes \wedge_\mathbb{C}^{0,1}$ via the pairings $\wedge^{1,0} \times \wedge_\mathbb{C}^{n-1} \wedge^{1,0} \rightarrow \wedge_\mathbb{C}^n \wedge^{1,0} \cong L^{-(n+1),0}$ and $T^{1,0} \times \wedge_\mathbb{C}^{n-1} T^{1,0} \rightarrow \wedge_\mathbb{C}^n T^{0,1} \cong L^{0,n+1}$. This may equivalently be viewed as an element of $(L^2 \otimes B^*)_\mathbb{C}$, whose contraction with h is the usual matrix pfaffian $\text{pf } h = (\det h)^{1/2}$.

For $r = 4$, the complexification of $\mathfrak{g}/\mathfrak{p}$ decomposes as $(\mathfrak{g}/\mathfrak{p})_\mathbb{C} = E \boxtimes H$ for $E \cong \mathbb{C}^{2n}$ and $H \cong \mathbb{C}^2$, where $\wedge_\mathbb{C}^{2n} E \cong \wedge_\mathbb{C}^2 H$. The complexification of h_t may be viewed as an element of $\wedge_\mathbb{C}^2 E$, so that its $(n-1)$ -fold wedge power defines an element of $\wedge_\mathbb{C}^{2n-2} E \cong \wedge_\mathbb{C}^2 E^* \boxtimes \wedge_\mathbb{C}^2 H \cong (L^2 \otimes B^*)_\mathbb{C}$ via the induced pairing $\wedge_\mathbb{C}^2 E \times \wedge_\mathbb{C}^{2n-2} \rightarrow \wedge_\mathbb{C}^2 H$. The contraction with h_t is an element of $\wedge_\mathbb{C}^n (\wedge_\mathbb{C}^2 E) \cong \wedge_\mathbb{C}^2 H$ which equals $\text{pf } h_t = (\det h_t)^{1/4}$.

For $r = 8$, we have $n = 2$ and h_t is an element of the standard representation of $\mathfrak{p} \cong \mathfrak{so}(10, \mathbb{C})$, defining metrics on the 16-dimensional half-spin representations. These are dual, with contraction the conformal quadratic form on the standard representation \mathbb{C}^{10} . This must be a non-zero multiple of $\text{pf } h_t = (\det h_t)^{1/8}$ by homogeneity, so that $h_t^* = h_t$ up to normalisation. Finally, $L^2 \otimes B^*$ is the trivial representation for $r = n$ and thus $h_t^* = 1$ up to normalisation. \square

Corollary 8.8. *The pfaffian $\text{pf } h_t$ is a polynomial of degree n in t .*

Proof. Since $h_t := \hat{h} - th$ is affine in t , the result follows immediately from Proposition 8.7 and the defining relation $\langle h_t^*, h_t \rangle = \text{pf } h_t$. \square

Moving to associated bundles, h_t^* and $\text{pf } h_t$ are polynomials of degrees $n - 1$ and n in t , whose coefficients are sections of $\mathcal{L}^2 \otimes \mathcal{B}^*$ and \mathcal{L} respectively.

8.1.3 Integrals of the geodesic flow

Recall from Chapter 4 that the Weyl connections of projective differential geometry are those linear connections with the same (unparameterised) geodesics. If a projective manifold admits a pencil of compatible metrics, it does not seem unreasonable to expect the dynamics of the (co)geodesic flow to have special properties. In this subsection we describe the geodesic flow of a metric as a hamiltonian mechanical system and recall some related results from projective and c-projective geometry.

We first recall the basic elements of symplectic geometry and hamiltonian mechanics; a detailed introduction may be found in [69]. A *symplectic structure* on a manifold M is the assignment of a closed non-degenerate 2-form $\omega \in \Omega^2(M)$. Then ω induces an inverse 2-vector $\omega^{-1} \in \Omega^0(M; \wedge^2 TM)$ and hence a *Poisson bracket*

$$\begin{aligned} \{ \cdot, \cdot \} : \Omega^0(M) \times \Omega^0(M) &\rightarrow \Omega^0(M) \\ \{f, g\} &:= \omega^{-1}(df, dg), \end{aligned}$$

i.e. a skew-symmetric bilinear pairing on $\Omega^0(M)$ satisfying the product rule $\{fg, h\} = \{f, h\}g + f\{g, h\}$; the Poisson bracket also equips $\Omega^0(M)$ with a Lie bracket. Then $h \mapsto \{f, h\}$ is a derivation of $\Omega^0(M)$ for all $f \in \Omega^0(M)$, giving a *hamiltonian vector field* X_f which satisfies $\partial_{X_f} h = \{f, h\}$. Given a symplectic form ω , we may also write $X_f = \omega^{-1}(df, \cdot)$. The assignment $f \mapsto X_f$ is linear and satisfies $[X_f, X_g] = X_{\{f, g\}}$.

A choice of $H \in \Omega^0(M)$ makes the triple (M, ω, H) into a *hamiltonian mechanical system*, where H is the *hamiltonian* (or energy function). This yields a favoured vector field X_H , the hamiltonian vector field of H , whose integral curves provide a 1-parameter family of transformations of M which describe the evolution of the hamiltonian system according to Hamilton's equations [125, Eqn. 22.11]. In this picture, a function $f \in \Omega^0(M)$ is preserved by the system if and only if it is constant along the integral curves of X_H ; such a function is called an *integral* of the hamiltonian system.

Proposition 8.9. $f \in \Omega^0(M)$ is an integral of (M, ω, H) if and only if $\{f, H\} = 0$. \square

In particular $\{H, H\} = 0$ by skew-symmetry, which corresponds to conservation of energy. If $f_1, f_2 \in \Omega^0(M)$ are integrals, the Jacobi identity implies that $\{f_1, f_2\}$ is again an integral, so that the space of integrals is a Lie subalgebra of $\Omega^0(M)$. Two integrals are said to be in *involution* if they also Poisson-commute, *i.e.* $\{f_1, f_2\} = 0$. If $\dim M = 2n$ then the linear space of hamiltonian vector fields corresponding to integrals is isotropic, so has dimension at most n . The system is (*Liouville*) *integrable* if it admits n linearly independent integrals in involution.

We can apply this to the geodesic flow of a riemannian manifold (M, g) . The cotangent bundle $\pi : T^*M \rightarrow M$ of M admits a canonical 1-form defined by

$$\Theta_\alpha(X) := \alpha(\pi_*(X))$$

for all $\alpha \in T^*M$, viewed as maps $\alpha : TM \rightarrow \mathbb{R}$, and all $X \in \Omega^0(T^*M; TT^*M)$. Clearly $\Omega = d\Theta$ defines a symplectic form on T^*M , called the *canonical symplectic form*, so that (M, Ω) is a symplectic manifold. The inverse metric $g^{-1} \in \Omega^0(M; S^2 TM)$ may be viewed as a homogeneous quadratic function on T^*M , so may be used as a hamiltonian function, and the integral curves of its hamiltonian vector field $X_{g^{-1}} \in$

$\Omega^0(T^*M; TT^*M)$ project to geodesics on M under π . Pulling everything back to TM using the musical isomorphisms of g , we obtain the *geodesic flow* of (M, g) . It is straightforward to show that the g^{-1} is constant along geodesics.

Definition 8.10. A smooth function $f : TM \rightarrow \mathbb{R}$ is an *integral of g* if $s \mapsto f(\gamma'(s))$ is constant for all affinely parameterised geodesics γ .

For homogeneous polynomial functions, we may reformulate being an integral of g in terms of its Levi-Civita connection ∇^g , see [177, Prop. 1].

Lemma 8.11. *A homogeneous polynomial function $Q : TM \rightarrow \mathbb{R}$ is an integral of g if and only if the symmetrisation $\text{sym}(\nabla^g Q)$ of $\nabla^g Q$ vanishes. \square*

Note that for homogeneous quadratic functions $Q \in \Omega^0(M; S^2 T^* M)$,

$$\text{sym}(\nabla^g Q)(X, Y, Z) = (\nabla_X^g Q)(Y, Z) + (\nabla_Y^g Q)(Z, X) + (\nabla_Z^g Q)(X, Y)$$

for all $X, Y, Z \in TM$.

As remarked previously, one might expect a metrisability pencil on a projective manifold (*i.e.* $r = 1$) to admit integrals of the metrics of the pencil. Given metrics g, \hat{g} at $\infty, 0$, a 1-parameter family of homogeneous quadratic integrals defined by

$$I_t := (\det(A - t\text{id}))g((A - t\text{id})^{-1} \cdot, \cdot)$$

were discovered by Matveev and Topalov [140, 178] and studied further by Topalov [175, 176], where A is the usual endomorphism (8.1). In particular, the I_t are polynomial of degree $n - 1$ in t and mutually Poisson-commuting with respect to the Poisson bracket on TM induced by g . Similar integrals were discovered in the c-projective setting by Kiyohara and Topalov [112] (see also [51]), where the Weyl connections are those linear connections with the same c-geodesics. The c-projective integrals are also polynomial and mutually Poisson-commute. In the next subsection, we will define an analogous 1-parameter family of Poisson-commuting integrals of any metric of the pencil.

8.1.4 Killing 2-tensors

Consider a non-degenerate linear metric $h \in \Omega^0(M; \mathcal{L}^* \otimes \mathcal{B})$ on M , with corresponding metric $g := (\text{pf } h)^{-1} h^{-1}$. Our next goal is to describe homogeneous polynomial integrals of g independently of $\nabla \in [\nabla]$. This may be done by introducing weights to counteract the effect of changing the connection in $[\nabla]$, and by using Lemma 8.11.

Proposition 8.12. *For sections k of $\mathcal{L}^2 \otimes \mathcal{B}^*$, the equation*

$$(\nabla_X k)(Y, Z) + (\nabla_Y k)(Z, X) + (\nabla_Z k)(X, Y) = 0 \tag{8.3}$$

is independent of $\nabla \in [\nabla]$.

Proof. Since $\delta_\gamma \nabla_X k = \llbracket X, \gamma \rrbracket \cdot k$, the Leibniz rule gives

$$\begin{aligned}
\delta_\gamma((\nabla_X k)(Y, Z)) &= (\llbracket X, \gamma \rrbracket \cdot k)(Y, Z) \\
&= \llbracket X, \gamma \rrbracket \cdot k(Y, Z) - k(\llbracket \llbracket X, \gamma \rrbracket, Y \rrbracket, Z) - k(Y, \llbracket \llbracket X, \gamma \rrbracket, Z \rrbracket) \\
&= 2\gamma(X)k(Y, Z) - k(\llbracket \llbracket X, \gamma \rrbracket, Y \rrbracket, Z) - k(Y, \llbracket \llbracket X, \gamma \rrbracket, Z \rrbracket) \quad (8.4)
\end{aligned}$$

since $k(Y, Z)$ is a section of \mathcal{L}^2 . To analyse the remaining algebraic bracket terms, we write $k = \ell\theta$ for some $\ell \in \Omega^0(M; \mathcal{L})$ and $\theta \in \Omega^0(M; \mathcal{L} \otimes \mathcal{B}^*)$. Then $k(\llbracket \llbracket X, \gamma \rrbracket, Y \rrbracket, Z) = \ell\theta(\llbracket \llbracket X, \gamma \rrbracket, Y \rrbracket, Z)$, for which

$$\begin{aligned}
\theta(\llbracket \llbracket X, \gamma \rrbracket, Y \rrbracket, Z) &= \llbracket Z, \llbracket \llbracket \llbracket X, \gamma \rrbracket, Y \rrbracket, \theta \rrbracket \\
&= \llbracket Z, \llbracket \llbracket \llbracket X, \theta \rrbracket, \gamma \rrbracket, Y \rrbracket \rrbracket + \llbracket Z, \llbracket \llbracket X, \gamma \rrbracket, \llbracket Y, \theta \rrbracket \rrbracket \rrbracket \\
&= \llbracket Z, \llbracket \llbracket \theta(X, \cdot), \gamma \rrbracket, Y \rrbracket \rrbracket + \llbracket Z, \llbracket \llbracket X, \gamma \rrbracket, \theta(Y, \cdot) \rrbracket \rrbracket \\
&= \llbracket \llbracket \theta(X, Z), \gamma \rrbracket, Y \rrbracket + \llbracket \llbracket \theta(X, \cdot), \llbracket Z, \gamma \rrbracket \rrbracket, Y \rrbracket \\
&\quad + \llbracket \llbracket Z, \llbracket X, \gamma \rrbracket \rrbracket, \theta(Y, \cdot) \rrbracket + \llbracket \llbracket X, \gamma \rrbracket, \theta(Y, Z) \rrbracket \\
&= -\llbracket \theta(X, Z)\gamma, Y \rrbracket - \llbracket \theta(X, Y), \llbracket Z, \gamma \rrbracket \rrbracket + \llbracket \theta(X, \cdot), \llbracket \llbracket Z, \gamma \rrbracket, Y \rrbracket \rrbracket \\
&\quad - \theta(Y, \llbracket \llbracket X, \gamma \rrbracket, Z \rrbracket) + \gamma(X)\theta(Y, Z) \\
&= \gamma(Y)\theta(X, Z) + \gamma(Z)\theta(X, Y) - \theta(X, \llbracket \llbracket Z, \gamma \rrbracket, Y \rrbracket) \\
&\quad - \theta(Y, \llbracket \llbracket X, \gamma \rrbracket, Z \rrbracket) + \gamma(X)\theta(Y, Z). \quad (8.5)
\end{aligned}$$

By symmetry of $\llbracket \llbracket X, \gamma \rrbracket, Y \rrbracket$ in X, Y and (8.4), we have

$$\begin{aligned}
&\frac{1}{2}\delta_\gamma((\nabla_X k)(Y, Z) + (\nabla_Y k)(Z, X) + (\nabla_Z k)(X, Y)) \\
&= \gamma(X)k(Y, Z) + \gamma(Y)k(Z, X) + \gamma(Z)k(X, Y) \\
&\quad - k(\llbracket \llbracket X, \gamma \rrbracket, Y \rrbracket, Z) - k(\llbracket \llbracket Y, \gamma \rrbracket, Z \rrbracket, X) - k(\llbracket \llbracket Z, \gamma \rrbracket, X \rrbracket, Y).
\end{aligned}$$

Taking the tensor product of (8.5) with ℓ and substituting the result on the right-hand side, it is clear that all terms cancel. Therefore (8.3) is independent of $\nabla \in [\nabla]$. \square

Calculating with respect to the Levi-Civita connection of h , Lemma 8.11 implies immediately that $k \in \Omega^0(M; \mathcal{L}^2 \otimes \mathcal{B}^*)$ is a solution if and only if $(\text{pf } h)^{-2}k$, viewed as a section of $S^2 T^*M$, is a homogeneous quadratic integral of $g := (\text{pf } h)^{-1}h^{-1}$.

Definition 8.13. The equation (8.3) is called the *Killing 2-tensor equation*, and its solutions $k \in \Omega^0(M; \mathcal{L}^2 \otimes \mathcal{B}^*)$ are called *Killing 2-tensors*.

In projective differential geometry, it is known [144] that the Killing 2-tensor equation is the first BGG operator associated to the representation \mathbb{U}^* from Subsection 8.1.2. The same holds in c-projective geometry [51, Cor. 5.8]. In these cases (8.3)

prolongs to a linear connection on the associated bundle $\mathcal{U}^* := F^P \times_P \mathbb{U}^*$, and the dimension of the solution space is bounded above by $\dim \mathbb{U}^*$. The Killing 2-tensor equation is trivial for conformal geometries, since there \mathbb{U}^* is the trivial representation, and more naturally one studies the *conformal Killing equation*; see [87, §2.4].

Proposition 8.14. *The adjugate of any linear metric h is a Killing 2-tensor.*

Proof. If h is non-degenerate then by Corollary 7.58, the Levi-Civita connection ∇^g of h lies in $[\nabla]$. Since we may write $h^* = (\text{pf } h)h^{-1}$, it follows that h^* is ∇^g -parallel and hence (8.3) holds. In the general case, note that the 1-jet of h^* is polynomial in the 1-jet of h , so the result follows by continuity. \square

If M admits a pencil $\mathbf{h} \in \Omega^0(M; \mathcal{L}^* \otimes \mathcal{B} \otimes V^*)$ of linear metrics, then every linear metric \mathbf{h}_v defines a Killing 2-tensor \mathbf{h}_v^* . Applying Proposition 8.7 to the metrisability pencil \mathbf{h} we may view its adjugate \mathbf{h}^* as a section of $\mathcal{L}^2 \otimes \mathcal{B}^* \otimes \mathcal{O}_V(n-1)$ over $M \times \mathbb{P}(V)$, *i.e.* as a homogeneous polynomial of degree $n-1$ in the parameters of the pencil. Choosing an affine chart, the 1-parameter family h_t^* of Killing 2-tensors is polynomial of degree $n-1$ in t , whose coefficients are also Killing 2-tensors. Trivialising \mathcal{L} with respect to the pfaffian $\text{pf } \mathbf{h}_u \in \Omega^0(M; \mathcal{L})$ of some metric \mathbf{h}_u in the pencil, each Killing 2-tensor \mathbf{h}_v^* yields a quadratic integral of the geodesic flow of $\mathbf{g}_u = (\text{pf } \mathbf{h}_u)^{-1} \mathbf{h}_u^{-1}$.

Viewing \mathbf{h} instead as a section of $\mathcal{L}^* \otimes \mathcal{B} \otimes \mathcal{O}_V(1)$ over $M \times \mathbb{P}(V)$ and choosing an affine chart with metrics h, \hat{h} at $\infty, 0$ respectively, every metric in the pencil is proportional to a metric in the 1-parameter family $h_t = \hat{h} - th$. This yields a 1-parameter family h_t^* of Killing 2-tensors, and it is straightforward to check that we recover the quadratic integrals of the geodesic flow of $g = (\text{pf } h)^{-1} h^{-1}$ by trivialising \mathcal{L} with respect to the metric at ∞ . Indeed, in this trivialisation

$$\begin{aligned} (\text{pf } h)^{-2} h_t^* &= (\text{pf } h_t)(\text{pf } h)^{-1} [(\text{pf } h_t)^{-1} h^{-1}(A_t^{-1} \cdot, \cdot)] \\ &= (\text{pf } h_t)(\text{pf } h)^{-1} g(A_t^{-1} \cdot, \cdot) \\ &= (\det A_t)^{1/r} g(A_t^{-1} \cdot, \cdot), \end{aligned} \tag{8.6}$$

where $A_t \in \Omega^0(M; \mathfrak{p}_M^0)$ denotes both the endomorphism satisfying $h_t = h(A_t \cdot, \cdot)$ and its transpose. It is clear from (8.6) that we recover Topalov and Matveev's integrals [140, 175, 177] of the geodesic flow in the projective case, and Kiyohara and Topalov's integrals [112, Prop. 2.1] in the c-projective case. It is well-known that the corresponding integrals of the geodesic flow mutually commute with respect to the Poisson bracket induced on TM by any metric in the pencil. The same result holds in general.

Theorem 8.15. *Let \mathbf{h} be a metrisability pencil. Then the components of \mathbf{h}^* Poisson-commute with respect to the Poisson bracket on TM induced by any metric in \mathbf{h} .*

To prove Theorem 8.15, we shall first need to describe the Poisson bracket on TM induced by a linear metric in more detail. We restrict attention to homogeneous polynomial functions on T^*M of degree k , which may equivalently be viewed as sections of $S^k TM$ over M . In this picture the canonical Poisson bracket becomes the *Schouten–Nijenhuis bracket* on symmetric multivectors, given by²

$$\begin{aligned} \{ \cdot, \cdot \} : \Omega^0(M; S^k TM) \times \Omega^0(M; S^\ell TM) &\rightarrow \Omega^0(M; S^{k+\ell-1} TM), \\ \{Q, R\} &:= \text{sym} (k(\varepsilon^i \lrcorner Q) \otimes \nabla_{e_i} R - \ell(\varepsilon^i \lrcorner R) \otimes \nabla_{e_i} Q) \end{aligned}$$

for any local frame $\{e_i\}_i$ of TM with dual coframe $\{\varepsilon^i\}_i$. In particular, the Schouten–Nijenhuis bracket between homogeneous quadratic functions is given by

$$\{Q, R\} = 2 \text{sym} (Q(\varepsilon^i, \cdot) \otimes \nabla_{e_i} R - R(\varepsilon^i, \cdot) \otimes \nabla_{e_i} Q), \quad (8.7)$$

a section of $S^3 TM$, where evaluating the symmetrisation of $Q(\varepsilon^i, \cdot) \otimes (\nabla_{e_i} R)$, a section of $TM \otimes S^2 TM$, on $\alpha, \beta, \gamma \in \Omega^1(M)$ entails taking the cyclic sum over α, β, γ .

Lemma 8.16. *Let h be a non-degenerate linear metric, with pfaffian $\pi := \text{pf } h$ and adjugate $h^* := \text{adj } h$. Then*

$$\nabla_X h^* = h^{-1}(Z^\nabla, X) h^* + \pi \otimes \llbracket h^{-1}(X, \cdot), h^{-1}(Z^\nabla, \cdot) \rrbracket \quad (8.8)$$

for all $\nabla \in [\nabla]$, where $Z^\nabla \in \Omega^0(M; \mathcal{L}^* \otimes TM)$ satisfies $\nabla_X h = \llbracket Z^\nabla, X \rrbracket$.

Proof. By Corollary 7.58 there is $\nabla^h \in [\nabla]$ with $\nabla^h h = 0$; therefore also $\nabla^h \pi = 0$ and $\nabla^h h^* = 0$. For any other $\nabla \in [\nabla]$ we can write $\nabla = \nabla^h + \llbracket \cdot, \gamma \rrbracket$ for some $\gamma \in \Omega^1(M)$, and it follows that $\nabla_X h = \llbracket \llbracket X, \gamma \rrbracket, h \rrbracket = \llbracket h(\gamma, \cdot), X \rrbracket$ by the Jacobi identity. Applying ∂ then gives $\gamma = h^{-1}(Z^\nabla, \cdot)$.

By non-degeneracy of h , we can write $h^* = \pi h^{-1}$. Then since $\nabla h^* = \llbracket \cdot, \gamma \rrbracket \cdot h^*$, the Leibniz rule yields

$$\begin{aligned} \nabla_X h^* &= \llbracket \llbracket X, \gamma \rrbracket, \pi \rrbracket \otimes h^{-1} + \pi \otimes \llbracket \llbracket X, \gamma \rrbracket, h^{-1} \rrbracket \\ &= \gamma(X) \pi h^{-1} + \pi (\llbracket \llbracket X, h^{-1} \rrbracket, \gamma \rrbracket + \llbracket X, \llbracket \gamma, h^{-1} \rrbracket \rrbracket) \\ &= \gamma(X) h^* + \pi \llbracket h^{-1}(X, \cdot), \gamma \rrbracket, \end{aligned}$$

Substituting $\gamma = h^{-1}(Z^\nabla, \cdot)$ from above gives the result. \square

Proof of Theorem 8.15. Choose an affine chart for \mathbf{h} with linear metrics h, \hat{h} at $\infty, 0$

²This may be more familiar in Penrose's abstract index notation [157]. Writing Q, R with k, ℓ contravariant indices, employing the summation convention and letting round brackets denote symmetrisation, the Schouten–Nijenhuis bracket reads $\{Q, R\}^{a \cdots e} = k Q^{f(a \cdots b} \nabla_f R^{cd \cdots e)} - \ell \nabla_f^{(a \cdots bc} R^{d \cdots e)f}$.

respectively. It then suffices to consider the 1-parameter family $h_t := \hat{h} - th$ of linear metrics, for which $\nabla_X h_t = \llbracket Z_t^\nabla, X \rrbracket$ with $Z_t^\nabla = \hat{Z}^\nabla - tZ^\nabla$ for all $t \in \mathbb{R}$.

The 1-parameter family h_t^* of Killing 2-tensors yields a 1-parameter family $Q_t \in \Omega^0(M; S^2 TM)$ of quadratic integrals of $g := (\text{pf } h)^{-1} h^{-1}$, which may be written as

$$Q_t(\alpha, \beta) = h_t^*(h(\alpha, \cdot), h(\beta, \cdot))$$

for $\alpha, \beta \in \Omega^1(M)$. We must show that the Schouten–Nijenhuis bracket (8.7) vanishes for all $s, t \in \mathbb{R}$. Since $\{Q_s, Q_t\} = 0$ trivially when $s = t$, we assume that $s \neq t$. It suffices also to assume that h_s, h_t are non-degenerate; the general case will then follow by continuity.

Let $\nabla \in [\nabla]$ be the Levi-Civita connection of h . Then since $\nabla h = 0$,

$$(\nabla_X Q_t)(\alpha, \beta) = (\nabla_X h_t^*)(h(\alpha), h(\beta))$$

for all $\alpha, \beta \in \Omega^1(M)$, where we write $h(\alpha) := h(\alpha, \cdot)$ for notational convenience. Since h is non-degenerate and $\pi := \text{pf } h$ is ∇ -parallel, it suffices to take 1-forms of the form $\pi^{-1} h^{-1}(X, \cdot)$ and prove that

$$\text{sym} [h_s^*(h(\varepsilon^i), \cdot) \otimes \nabla_{e_i} h_t^* - h_t^*(h(\varepsilon^i), \cdot) \otimes \nabla_{e_i} h_s^*] = 0 \quad (8.9)$$

as a section of $\mathcal{L}^3 \otimes S^3 T^* M$. Notice that we may write

$$\begin{aligned} h &= \frac{1}{s-t} ((\hat{h} - th) - (\hat{h} - sh)) \\ &= \frac{1}{s-t} (h_t - h_s) \end{aligned}$$

for any $s \neq t$, so that (8.9) holds if and only if

$$\text{sym} \begin{bmatrix} h_s^*(h_t(\varepsilon^i) \cdot) \otimes \nabla_{e_i} h_t^* - h_s^*(h_s(\varepsilon^i) \cdot) \otimes \nabla_{e_i} h_t^* \\ - h_t^*(h_t(\varepsilon^i) \cdot) \otimes \nabla_{e_i} h_s^* + h_t^*(h_s(\varepsilon^i) \cdot) \otimes \nabla_{e_i} h_s^* \end{bmatrix} = 0. \quad (8.10)$$

Let us analyse the terms inside the symmetrisation one at a time. Writing $\pi(t) := \text{pf } h_t$, for the third term above we have

$$\begin{aligned} h_t^*(h_t(\varepsilon^i, \cdot), X) (\nabla_{e_i} h_s^*)(Y, Z) &= \pi(t) h_t^{-1}(h_t(\varepsilon^i), X) (\nabla_{e_i} h_s^*)(Y, Z) \\ &= \pi(t) \varepsilon^i(X) (\nabla_{e_i} h_s^*)(Y, Z) \\ &= \pi(t) (\nabla_X h_s^*)(Y, Z), \end{aligned}$$

whose symmetrisation in X, Y, Z vanishes because h_s^* is a Killing 2-tensor. Switching the roles of s, t , the second term in (8.10) also vanishes.

Observe now that, since we are computing with respect to the Levi-Civita connec-

tion ∇ of h , $Z^\nabla = 0$ and therefore $Z_t^\nabla = \hat{Z}^\nabla - tZ^\nabla = \hat{Z}^\nabla$ for all $t \in \mathbb{R}$. By Lemma 8.16 it follows that the first term in (8.10) is given by

$$\begin{aligned} & h_s^*(h_t(\varepsilon^i, \cdot), X) \otimes \nabla_{e_i} h_t^* \\ &= \pi(s)\varepsilon^i(h_t(h_s^*(X, \cdot), \cdot))(h_t^{-1}(\hat{Z}^\nabla, e_i)h_t^* + \pi(t) \otimes \llbracket h_t^{-1}(e_i, \cdot), h_t^{-1}(\hat{Z}^\nabla, \cdot) \rrbracket) \\ &= \pi(s)\pi(t)(h_s^{-1}(\hat{Z}^\nabla, X)h_t^{-1} + \llbracket h_s^{-1}(X, \cdot), h_t^{-1}(\hat{Z}^\nabla, \cdot) \rrbracket). \end{aligned}$$

We note that $h_s^{-1}(X, \cdot) \in \Omega^0(M; \mathcal{L} \otimes T^*M)$ and $h_t^{-1}(Z_t^\nabla, \cdot) \in \Omega^1(M)$, so that the algebraic bracket term is a section of $\mathcal{L} \otimes \mathcal{B}^*$ as required. Writing $\alpha_s := h_s^{-1}(\hat{Z}^\nabla, \cdot) \in \Omega^1(M)$, the previous two calculations imply that (8.10) is equivalent to

$$\pi(s)\pi(t) \operatorname{sym}_{X,Y,Z} \left[\begin{array}{c} \alpha_s(X)h_t^{-1}(Y, Z) + \llbracket h_s^{-1}(X, \cdot), \alpha_t \rrbracket(Y, Z) \\ + \alpha_t(X)h_s^{-1}(Y, Z) + \llbracket h_t^{-1}(X, \cdot), \alpha_s \rrbracket(Y, Z) \end{array} \right] = 0, \quad (8.11)$$

where by $\operatorname{sym}_{X,Y,Z}$ we mean the cyclic sum over X, Y, Z . Since $\pi(t) \in \Omega^0(M; \mathcal{L})$, we have

$$\pi(t)\alpha_s(X)h_t^{-1}(Y, Z) = \llbracket \llbracket X, \alpha_s \rrbracket, \pi(t) \rrbracket \otimes h_t^{-1}(Y, Z), \quad (8.12)$$

a section of \mathcal{L}^3 . The Jacobi identity then yields

$$\llbracket h_t^{-1}(X, \cdot), \alpha_s \rrbracket = \llbracket \llbracket X, h_t^{-1} \rrbracket, \alpha_s \rrbracket = \llbracket \llbracket X, \alpha_s \rrbracket, h_t^{-1} \rrbracket$$

since the bracket between T^*M and $\mathcal{L} \otimes \mathcal{B}^*$ is zero. Therefore, combining this with (8.12) and omitting the evaluation on vector fields Y, Z , the first and last terms inside the symmetrisation in (8.11) equal

$$\begin{aligned} & \pi(s) \otimes (\llbracket \llbracket X, \alpha_s \rrbracket, \pi(t) \rrbracket \otimes h_t^{-1} + \pi(t) \otimes \llbracket \llbracket X, \alpha_s \rrbracket, h_t^{-1} \rrbracket) \\ &= \pi(s) \otimes (\llbracket X, \alpha_s \rrbracket \cdot \pi(t)h_t^{-1}) \\ &= \pi(s) \otimes (\delta_{\alpha_s} \nabla_X h_t^*), \end{aligned} \quad (8.13)$$

where δ_{α_s} is the linear variation of Weyl structure with respect to α_s . The symmetrisation of (8.13) is zero by Proposition 8.12. Therefore, upon symmetrisation, the first and last terms in (8.11) sum to zero; exchanging s, t , so do the middle two terms. Since (8.11) was equivalent to commutativity of the h_t^* , we are done. \square

8.2 Canonical vector fields

In c-projective geometry, the role of the canonically defined Killing vector fields associated to a metrisability pencil has been emphasised by a number of authors, most notably in [11, 12, 36, 138]. These Killing fields are defined as symplectic gradients

$J \operatorname{grad}_g \sigma_i$ for certain functions σ_i associated to the pencil, and mutually commute. More recently, analogous gradient fields $\operatorname{grad}_g \sigma_i$ have been discovered in projective geometry by Eastwood [76] and developed further in the c-projective setting in [36, 51]. While these gradient fields mutually commute, they are not Killing in general. The present author believes that these gradient fields $X(t)$ play the more fundamental role, and it is merely a happy accident that the symplectic gradients of c-projective geometry are Killing fields. Indeed, in quaternionic geometry the vector fields $J_a X(t)$ are not Killing unless the manifold is hypercomplex.

In this section, we develop the theory of the canonically defined gradient vector fields associated to a pencil. Subsection 8.2.1 is devoted to an invariant description of these vector fields, using the bilinear pairing provided by the general BGG calculus, while Subsection 8.2.2 undertakes a somewhat gruesome proof that they mutually commute.

8.2.1 Definition using BGG pairings

By Proposition 7.32, an algebraic Weyl structure for \mathfrak{p} induces decompositions

$$\begin{aligned} \mathbb{W} &\cong (L^* \otimes B) \oplus (L^* \otimes \mathfrak{g}/\mathfrak{p}) \oplus L^* \\ \mathbb{W}^* &\cong L \oplus (L \otimes \mathfrak{p}^\perp) \oplus (L \otimes B^*) \end{aligned} \tag{8.14}$$

of \mathbb{W} and \mathbb{W}^* , where $B \leq S^2(\mathfrak{g}/\mathfrak{p})$ is a \mathfrak{p}^0 -subrepresentation and, by Proposition 7.38, $L \cong (\wedge^{rn} \mathfrak{g}/\mathfrak{p})^{2/r(n+1)}$. Since also $\mathfrak{g} \cong \mathfrak{g}/\mathfrak{p} \oplus \mathfrak{p}^0 \oplus \mathfrak{p}^\perp$, taking Lie brackets of appropriate elements in (8.14) yields a bilinear pairing

$$\mathbb{W} \times \mathbb{W}^* \rightarrow \mathfrak{g}. \tag{8.15}$$

The $(\mathfrak{g}/\mathfrak{p})$ -valued component of (8.15) is \mathfrak{p} -invariant, so descends to a pairing $(L^* \otimes B) \times L \rightarrow \mathfrak{g}/\mathfrak{p}$ on zeroth homology modules. The theory of Section 3.3.1 then provides a bilinear differential pairing $(\mathcal{L}^* \otimes \mathcal{B}) \times \mathcal{L} \rightarrow TM$ between associated bundles of the form (3.14). In terms of the BGG splitting operators (7.21) and (7.33) this is

$$(h, \pi) \mapsto X(h, \pi) := h(\eta^\nabla, \cdot) - \pi Z^\nabla \tag{8.16}$$

for any $\nabla \in [\nabla]$, where $\eta^\nabla := \nabla \pi$ and $Z^\nabla := \frac{2}{rn-r+2} \partial(\nabla h)$ as in (7.25) and (7.36).

Lemma 8.17. *$X(h, \pi)$ is independent of $\nabla \in [\nabla]$.*

Proof. From Section 7.4 we have $\delta_\gamma Z^\nabla = h(\gamma, \cdot)$ and $\delta_\gamma \eta^\nabla = [[[\cdot, \gamma], \pi]] = \pi \gamma$, so that $\delta_\gamma X(h, \pi) = h(\pi \gamma, \cdot) - \pi h(\gamma, \cdot) = 0$. \square

If h is non-degenerate then $X(h, \pi)$ is a gradient vector field with respect to $g := (\operatorname{pf} h)^{-1} h^{-1}$: we may trivialise the line bundle \mathcal{L} with respect to $\operatorname{pf} h$ and write $X(h, \pi)$

with respect to the Levi-Civita connection ∇ of h , yielding

$$X(h, \pi) = h(\nabla\pi, \cdot) = g^{-1}(d((\text{pf } h)^{-1}\pi), \cdot) = \text{grad}_g((\text{pf } h)^{-1}\pi). \quad (8.17)$$

Since this simple fact shall be important in the sequel, we record the following property of gradient vector fields.

Lemma 8.18. *Let (M, g) be a (pseudo-)riemannian manifold with Levi-Civita connection ∇ . Then ∇X is self-adjoint with respect to g for all gradient vector fields X .*

Proof. Suppose that $X = \text{grad}_g f$. Then for all vector fields Y, Z , we have $g(\nabla_Y X, Z) = g(\nabla_Y df^\sharp, Z) = (\nabla_Y df)(Z) = \partial_Y \partial_Z f - df(\nabla_Y Z)$. Since ∇ is torsion-free, we obtain $g(\nabla_Y X, Z) - g(Y, \nabla_Z X) = \partial_{[Y, Z]} f - df([Y, Z]) = 0$ as required. \square

Observe also that $X(h, \text{pf } h) = 0$ for all $h \in \Omega^0(M; \mathcal{L}^* \otimes B)$: either h is degenerate, in which case $\text{pf } h = 0$ and $\eta^\nabla = 0$; or else h is non-degenerate and we may evaluate $X(h, \text{pf } h)$ with respect to the Levi-Civita connection ∇ of h , giving $\eta^\nabla = 0$ and $Z^\nabla = 0$.

Suppose now that we have a pencil $\mathbf{h} \in \Omega^0(M; \mathcal{L}^* \otimes \mathcal{B} \otimes V^*)$ of compatible linear metrics. The pfaffian $\boldsymbol{\pi} := \text{pf } \mathbf{h}$ is a section of $\mathcal{L} \otimes S^n V^*$, so may be viewed as a homogeneous polynomial of degree n in the parameters of the pencil. We would like to define the vector fields $X(\mathbf{h}, \boldsymbol{\pi})$, but since $X(h, \text{pf } h) = 0$ some care is needed to avoid making a trivial definition. There are two equivalent approaches:

- We may choose an affine chart on $\mathbb{P}(V)$ with linear metrics h, \hat{h} at $\infty, 0$ respectively. Then each metric in the pencil is proportional to some $h_t := \hat{h} - th$ and $\pi(t) := \text{pf } h_t$ is a polynomial of degree n in t by Corollary 8.8. Since (8.16) is linear in h ,

$$\begin{aligned} X(h_s, \pi(t)) &= X(h_s, \pi(t)) - X(h_t, \pi(t)) \\ &= X(\hat{h} - sh, \pi(t)) - X(\hat{h} - th, \pi(t)) = (t - s)X(h, \pi(t)) \end{aligned} \quad (8.18)$$

for each $s, t \in \mathbb{R}$, where $X(t) := X(h, \pi(t))$ is independent of s and polynomial of degree $n - 1$ in t .

- More invariantly, we view \mathbf{h} and $\boldsymbol{\pi}$ respectively as sections of $\mathcal{L}^* \otimes \mathcal{B} \otimes V^*$ and $\mathcal{L} \otimes S^n V^*$ over M , so that $X(\mathbf{h}, \boldsymbol{\pi})$ is a section of $TM \otimes V^* \otimes S^n V^*$. The Clebsch–Gordan formula [84] gives

$$V^* \otimes S^n V^* \cong S^{n+1} V^* \oplus (S^{n-1} V^* \otimes \wedge^2 V^*)$$

and, since $X(h, \text{pf } h) = 0$ for each $h \in \Omega^0(M; \mathcal{L}^* \otimes \mathcal{B})$, the $S^{n+1} V^*$ -component must vanish identically. It follows that we may write $X(\mathbf{h}, \boldsymbol{\pi}) = \mathbf{X} \odot \varepsilon$ for a section \mathbf{X} of $TM \otimes S^{n-1} V^*$ and a constant area form $\varepsilon \in \wedge^2 V^*$. Of course, \mathbf{X} is identified with $X(t)$ from above in an affine chart, while the evaluation of ε on $(1, s), (1, t) \in V$ is (proportional to) the coefficient $(t - s)$ in (8.18).

The pencil \mathbf{h} therefore induces a homogeneous family \mathbf{X} of gradient vector fields. For concreteness, we shall often work with the vector fields $X(t)$ in an affine chart.

Definition 8.19. The homogeneous family $\mathbf{X} \in \Omega^0(M; TM \otimes S^{n-1}V^*)$ will be called the *family of canonical vector fields* associated to the pencil \mathbf{h} .

Remark 8.20. In an affine chart, $X(t) = \sum_{i=1}^{n-1} (-1)^i t^i X_i$ is polynomial of degree $n-1$ in t . Identifying $X(t)$ with the gradient field $\text{grad}_g((\text{pf } h)^{-1}\pi(t))$, we have $X_i = \text{grad}_g \sigma_i$ for σ_i the elementary symmetric function of the n roots of $\pi(t)$; these are Eastwood's gradient fields in projective geometry [76]. In c-projective geometry, since J is parallel and X_i is gradient, the symplectic gradients $K_i := J \text{grad}_g \sigma_i$ are Killing fields.

Proposition 8.21. *Choose an affine chart for $\mathbb{P}(V)$ with non-degenerate linear metrics h, \hat{h} at $\infty, 0$ respectively, and let ∇^g be the Levi-Civita connection of $g := (\text{pf } h)^{-1/r} h^{-1}$. Then $\nabla^g X(t)$, is a g -self-adjoint section of \mathfrak{p}_M^0 for all $t \in \mathbb{R}$.*

Proof. The fact that $\nabla X(t)$ is self-adjoint with respect to g follows from (8.17) and Lemma 8.18. Differentiating (8.16) using the prolongation (7.25) gives

$$\begin{aligned} \nabla_Y X(t) &= \llbracket Z^\nabla, Y \rrbracket (\nabla \pi(t), \cdot) + h(\nabla_Y \nabla \pi(t), \cdot) \\ &\quad - (\nabla_Y Z^\nabla) \pi(t) - (\nabla_Y \pi(t)) Z^\nabla \\ &= \llbracket \llbracket Z^\nabla, \nabla \pi(t) \rrbracket, Y \rrbracket + \llbracket Z^\nabla, \nabla_Y \pi(t) \rrbracket + h(\nabla_Y \nabla \pi(t) - \pi(t) r_Y^\nabla, \cdot) \\ &\quad - (\nabla_Y \pi(t)) Z^\nabla - \lambda^\nabla \pi(t) Y - \pi(t) \square^{-1} \partial \llbracket W, h \rrbracket_Y \\ &= \llbracket \llbracket Z^\nabla, \nabla \pi(t) \rrbracket, Y \rrbracket + h(\nabla_Y \nabla \pi(t) - \pi(t) r_Y^\nabla, \cdot) \\ &\quad - \lambda^\nabla \pi(t) Y - \pi(t) \square^{-1} \partial \llbracket W, h \rrbracket_Y \end{aligned}$$

for all vector fields Y . The bracket $\llbracket Z^\nabla, \nabla \pi(t) \rrbracket$ lies in $\mathfrak{p}_M^0 \oplus \mathfrak{z}(\mathfrak{q}^0)_M$; however $\mathfrak{gl}(TM)$ has zero intersection with $\mathfrak{z}(\mathfrak{q}^0)_M$, so $\llbracket Z^\nabla, \nabla \pi(t) \rrbracket$ is a section of \mathfrak{p}_M^0 . Since h_t is a linear metric for each $t \in \mathbb{R}$, its pfaffian $\pi(t)$ defines a solution of the hessian equation by Corollary 7.73. Thus $\nabla^2 \pi(t) - \pi(t) r^\nabla$ is a section of $\mathcal{L} \otimes \mathcal{B}^*$, implying that $Y \mapsto h(\nabla_Y \nabla \pi(t) - \pi(t) r_Y^\nabla, \cdot)$ is a section of \mathfrak{p}_M^0 by Lemma 7.60. Since $\lambda^\nabla \pi(t)$ is just a smooth function, the third term is proportional to the identity map and hence a section of \mathfrak{p}_M^0 . Finally, the Weyl curvature term defines a section of \mathfrak{p}_M^0 by Lemma 7.62. Therefore the right-hand side above is the image of Y under a section of \mathfrak{p}_M^0 . \square

By Proposition 8.4, the vector field $\pi \hat{Z}^\nabla$ may be identified with the vector field $\Lambda := \mu^\sharp$ appearing in the main equation (5.9) of c-projective geometry. Thus Proposition 8.21 generalises the well-known fact that Λ is holomorphic; see [52, 138]. In quaternionic geometry, one finds that in fact $\nabla X(t)$ is quaternion-linear, implying that $X(t)$ is a gradient quaternionic vector field by [8, Lem. 1(2)].

8.2.2 Commutativity

The objective of this subsection is to prove that the canonical vector fields mutually commute. This is well-known in c-projective geometry [11, 12, 36, 138], where one usually works with the canonical Killing fields $K(t) := JX(t)$.

Theorem 8.22. *The components of $X(\mathbf{h}, \boldsymbol{\pi})$ mutually commute.*

The proof of Theorem 8.22 will require some preliminary technical work. Note that it suffices to prove that the components of $\mathbf{X} \in \Omega^0(M; TM \otimes S^{n-1}V^*)$ from above commute; equivalently, we may choose an affine chart on $\mathbb{P}(V)$ with metrics h, \hat{h} at $\infty, 0$ respectively and show that $[X(s), X(t)] = 0$ for all $s, t \in \mathbb{R}$.

Lemma 8.23. *Let g be a non-degenerate section of \mathcal{B}^* and suppose that $A \in \Omega^0(M; \mathfrak{p}_M^0)$ is self-adjoint with respect to g . Then for all vector fields X , we have:*

- (1) $[[[X, X^b], X^b]] = -g(X, X)X^b$; and
- (2) $[[[AX, X^b], X^b]] = -g(AX, X)X^b$,

where $\flat : TM \rightarrow T^*M$ is the musical isomorphism $X \mapsto g(X, \cdot)$ of g .

Proof. (1) Let $h := (\det g)^{1/r(n+1)}g^{-1}$ be the corresponding section of $\mathcal{L}^* \otimes \mathcal{B}$. For an arbitrary vector field Y , we may write

$$\begin{aligned}
[[[X, X^b], X^b]](Y) &= h([[X, X^b], X^b], h^{-1}(Y, \cdot)) \\
&= \langle h^{-1}(Y, \cdot), h([[X, X^b], X^b], \cdot) \rangle \\
&= \langle [Y, h^{-1}], [h, [[X, X^b], X^b]] \rangle \\
&= \langle Y, [[h^{-1}, [h, [[X, X^b], X^b]]]] \rangle
\end{aligned} \tag{8.19}$$

by the Jacobi identity and invariance of the Killing form on \mathfrak{h}_M . Using Table 7.1, successive applications of the Jacobi identity to last display yield

$$\begin{aligned}
&[[h^{-1}, [h, [[X, X^b], X^b]]]] \\
&= [[h^{-1}, [[X, [h, X^b]], X^b]] + [[h^{-1}, [[X, X^b], [h, X^b]]]] \\
&= [[h^{-1}, [[X, h(X^b, \cdot)], X^b]] + [[h^{-1}, [[X, X^b], h(X^b, \cdot)]]] \\
&= [[[[h^{-1}, X], h(X^b, \cdot)], X^b]] + [[X, [h^{-1}, h(X^b, \cdot)]]], X^b] \\
&\quad + [[[[h^{-1}, X], X^b], h(X^b, \cdot)]] + [[X, X^b], [h^{-1}, h(X^b, \cdot)]] \\
&= -[[[h^{-1}(X, \cdot), h(X^b, \cdot)], X^b]] - [[h^{-1}(X, \cdot), X^b], h(X^b, \cdot)] \\
&\quad + 2[[X, X^b], X^b].
\end{aligned} \tag{8.20}$$

Writing $\pi := \text{pf } h \neq 0$, we have $h(X^b, \cdot) = \pi^{-1}X$ and $h^{-1}(X, \cdot) = \pi X^b$. Making this

substitution in (8.20) and using the Jacobi identity on the second term, we obtain

$$\begin{aligned}
& \llbracket h^{-1}, \llbracket h, \llbracket \llbracket X, X^b \rrbracket, X^b \rrbracket \rrbracket \\
&= -\llbracket \llbracket \pi X^b, \pi^{-1} X \rrbracket, X^b \rrbracket - \llbracket \llbracket \pi X^b, X^b \rrbracket, \pi^{-1} X \rrbracket + 2\llbracket \llbracket X, X^b \rrbracket, X^b \rrbracket \\
&= -2\llbracket \llbracket \pi X^b, \pi^{-1} X \rrbracket, X^b \rrbracket - \llbracket \pi X^b, \llbracket X^b, \pi^{-1} X \rrbracket \rrbracket + 2\llbracket \llbracket X, X^b \rrbracket, X^b \rrbracket. \tag{8.21}
\end{aligned}$$

Consider the first term on the right-hand side of (8.21). Since we may write $\pi^{-1} X = \llbracket \pi^{-1}, X \rrbracket$, the Jacobi identity yields

$$\begin{aligned}
\llbracket \llbracket \pi X^b, \llbracket \pi^{-1}, X \rrbracket \rrbracket, X^b \rrbracket &= \llbracket \llbracket \llbracket \pi X^b, \pi^{-1} \rrbracket, X \rrbracket, X^b \rrbracket + \llbracket \llbracket \pi^{-1}, \llbracket \pi X^b, X \rrbracket \rrbracket, X^b \rrbracket \\
&= \llbracket \llbracket X^b, X \rrbracket, X^b \rrbracket - \llbracket \llbracket \pi^{-1}, \pi g(X, X) \rrbracket, X^b \rrbracket, \tag{8.22}
\end{aligned}$$

where we have used that the inner-most brackets are the contractions $\llbracket \pi X^b, \pi^{-1} \rrbracket = X^b$ and $\llbracket \pi X^b, X \rrbracket = -\pi g(X, X)$. The bracket between $\pi^{-1} \in \Omega^0(M; \mathcal{L}^*)$ and $X^b \in \Omega^1(M)$ vanishes, so applying the Jacobi identity to the second term in (8.22) gives

$$\begin{aligned}
\llbracket \llbracket \pi X^b, \llbracket \pi^{-1}, X \rrbracket \rrbracket, X^b \rrbracket &= -\llbracket \llbracket X, X^b \rrbracket, X^b \rrbracket - \llbracket \llbracket \pi^{-1}, \llbracket \pi g(X, X), X^b \rrbracket \rrbracket \\
&= -\llbracket \llbracket X, X^b \rrbracket, X^b \rrbracket + \llbracket \llbracket \pi^{-1}, \pi g(X, X) X^b \rrbracket \\
&= -\llbracket \llbracket X, X^b \rrbracket, X^b \rrbracket - g(X, X) X^b. \tag{8.23}
\end{aligned}$$

Consider now the second term in (8.21). Since the inner algebraic bracket is (minus) the contraction, we have

$$-\llbracket \pi X^b, \llbracket X^b, \pi^{-1} X \rrbracket \rrbracket = \llbracket \pi X^b, \pi^{-1} g(X, X) \rrbracket = g(X, X) X^b. \tag{8.24}$$

Now substituting (8.22), (8.23) and (8.24) into (8.19), we obtain

$$\langle Y, \llbracket \llbracket X, X^b \rrbracket, X^b \rrbracket \rangle = \langle Y, 4\llbracket \llbracket X, X^b \rrbracket, X^b \rrbracket + 3g(X, X) X^b \rangle.$$

and therefore

$$\langle Y, \llbracket \llbracket X, X^b \rrbracket, X^b \rrbracket + g(X, X) X^b \rangle = 0$$

by rearranging. Since this holds for all vector fields Y , the result follows by non-degeneracy of the Killing form.

(2) Following the steps of (1) with $\llbracket \llbracket X, X^b \rrbracket, X^b \rrbracket$ replaced by $\llbracket \llbracket AX, X^b \rrbracket, X^b \rrbracket$ until we reach equations analogous to (8.22) and (8.23), we find that

$$\begin{aligned}
\langle Y, \llbracket \llbracket AX, X^b \rrbracket, X^b \rrbracket \rangle &= \langle Y, -2\llbracket \llbracket (AX)^b, X \rrbracket, X^b \rrbracket - 2\llbracket \llbracket \pi^{-1}, \llbracket \pi(AX)^b, X^b \rrbracket \rrbracket, X^b \rrbracket \rangle \\
&= \langle Y, -2\llbracket \llbracket (AX)^b, X \rrbracket, X^b \rrbracket + 2g(AX, X) X^b \\
&\quad + g(X, X)(AX)^b + 2\llbracket \llbracket AX, X^b \rrbracket, X^b \rrbracket \rangle. \tag{8.25}
\end{aligned}$$

Consider the first term above. Since A is self-adjoint with respect to g , we have $(AX)^b(Y) = g(X, AY) = (X^b \circ A)(Y) = \llbracket X^b, A \rrbracket(Y)$, and thus $(AX)^b = \llbracket X^b, A \rrbracket$. By the Jacobi identity, the first term on the right-hand side above equals

$$\begin{aligned}
\llbracket \llbracket (AX)^b, X \rrbracket, X^b \rrbracket &= \llbracket \llbracket \llbracket X^b, A \rrbracket, X \rrbracket, X^b \rrbracket \\
&= \llbracket \llbracket \llbracket X^b, X \rrbracket, A \rrbracket, X^b \rrbracket + \llbracket \llbracket X^b, AX \rrbracket, X^b \rrbracket \\
&= \llbracket \llbracket \llbracket X^b, X \rrbracket, X^b \rrbracket, A \rrbracket - \llbracket \llbracket X^b, X \rrbracket, (AX)^b \rrbracket \\
&\quad + \llbracket \llbracket X^b, AX \rrbracket, X^b \rrbracket.
\end{aligned} \tag{8.26}$$

The first term on the right-hand side equals $-\llbracket g(X, X)X^b, A \rrbracket = -g(X, X)(AX)^b$ by part (1), while the second term equals $-\llbracket \llbracket (AX)^b, X \rrbracket, X^b \rrbracket$ by symmetry in X^b and $(AX)^b$. Since this term equals the negative of the left-hand side, rearranging (8.26) gives

$$\llbracket \llbracket (AX)^b, X \rrbracket, X^b \rrbracket = -\frac{1}{2}(g(X, X)(AX)^b + \llbracket \llbracket AX, X^b \rrbracket, X^b \rrbracket). \tag{8.27}$$

Substituting (8.27) into (8.25), the $g(X, X)(AX)^b$ terms cancel and we obtain

$$\langle Y, \llbracket \llbracket AX, X^b \rrbracket, X^b \rrbracket \rangle = \langle Y, 3\llbracket \llbracket AX, X^b \rrbracket, X^b \rrbracket + 2g(AX, X)X^b \rangle. \tag{8.28}$$

Noting that the first term on the right-hand side of (8.28) equals three times the left-hand side, rearranging and dividing by two gives

$$\langle Y, \llbracket \llbracket AX, X^b \rrbracket, X^b \rrbracket + g(AX, X)X^b \rangle = 0$$

and hence the result by the non-degeneracy of the Killing form on \mathfrak{g}_M . \square

Remark 8.24. Lemma 8.23 is trivial to verify when working with a particular geometry, since the algebraic bracket $\llbracket \cdot, \cdot \rrbracket : TM \times T^*M \rightarrow \mathfrak{p}_M^0$ is known explicitly. However, care must be taken in the conformal case: the bracket in Lemma 8.23(2) equals

$$\llbracket \llbracket AX, X^b \rrbracket, X^b \rrbracket = -2g(AX, X)X^b + g(X, X)(AX)^b,$$

so one must use that the g -self-adjoint sections of \mathfrak{p}_M^0 are multiples of the identity.

It will be convenient henceforth to work with the Levi-Civita connection ∇ of h , so that $X(t) = h(\nabla\pi(t), \cdot)$. We can also trivialise the line bundles \mathcal{L} and \mathcal{L}^* using the pfaffian $\pi := \text{pf } h \in \Omega^0(M; \mathcal{L})$ and its inverse $\pi^{-1} \in \Omega^0(M; \mathcal{L}^*)$. As discussed in Subsection 8.2.1, if h_t is degenerate then $\pi(t) = 0$ and hence $X(t) = 0$ identically.

Form the usual endomorphism $A = \llbracket h^{-1}, \hat{h} \rrbracket$ and denote its transpose map by the same symbol. The following result is well-known in the projective [32, 33] and c -projective [36, 51] cases. However, we pursue a different proof to these sources.

Proposition 8.25. *Let $\nabla, \hat{\nabla}$ be the Levi-Civita connections of h, \hat{h} respectively and suppose that $\hat{Z}^\nabla \in \Omega^0(M; \mathcal{L}^* \otimes TM)$ satisfies $\nabla \hat{h} = \llbracket \hat{Z}^\nabla, \cdot \rrbracket$. Then the endomorphisms $A, \nabla(\pi \hat{Z}^\nabla) \in \Omega^0(M; \mathfrak{gl}(TM))$ commute.*

Proof. From the prolongation (7.25) of the linear metric equation, we have

$$\nabla_X \hat{Z}^\nabla = \hat{\lambda}^\nabla X + \hat{h}(r_X^\nabla, \cdot) + \square^{-1} \partial \llbracket W, \hat{h} \rrbracket_X. \quad (8.29)$$

Since we are assuming that ∇ is torsion-free, the Weyl curvature W and hence also the final Weyl curvature term $\square^{-1} \partial \llbracket W, \hat{h} \rrbracket$ in (8.29) are projectively invariant, and therefore may be computed with respect to either ∇ or $\hat{\nabla}$; in the latter case we obtain

$$\square^{-1} \partial \llbracket W, \hat{h} \rrbracket_X = -\hat{\lambda}^{\hat{\nabla}} X - \hat{h}(r_X^{\hat{\nabla}}, \cdot)$$

since $\hat{Z}^{\hat{\nabla}} = 0$. Substituting this into (8.29), we obtain

$$\nabla_X \hat{Z}^\nabla = (\hat{\lambda}^\nabla - \hat{\lambda}^{\hat{\nabla}}) X - \hat{h}(r_X^\nabla - r_X^{\hat{\nabla}}, \cdot).$$

Using Corollary 7.49 and that A is self-adjoint with respect to h^{-1} , it follows that

$$\begin{aligned} h^{-1}(\nabla_{AX} \hat{Z}^\nabla, Y) &= (\hat{\lambda}^\nabla - \hat{\lambda}^{\hat{\nabla}}) h^{-1}(AX, Y) - h^{-1}(\hat{h}(r_{AX}^\nabla - r_{AX}^{\hat{\nabla}}, \cdot), Y) \\ &= (\hat{\lambda}^\nabla - \hat{\lambda}^{\hat{\nabla}}) h^{-1}(AY, X) - (r_{AY}^\nabla - r_{AY}^{\hat{\nabla}})(AX) \\ &= h^{-1}(\nabla_{AY} \hat{Z}^\nabla, X) \end{aligned} \quad (8.30)$$

for all vector fields X, Y . Since $h^{-1} = \pi g$, (8.30) now implies that $\nabla(\pi \hat{Z}^\nabla) \circ A$ is self-adjoint with respect to g . But by Proposition 8.4, $\pi \hat{Z}^\nabla$ is a gradient vector field with respect to g , so is g -self-adjoint by Lemma 8.18. Then since $A, \nabla(\pi \hat{Z}^\nabla)$ and $\nabla(\pi \hat{Z}^\nabla) \circ A$ are all self-adjoint, it follows easily that A commutes with $\nabla(\pi \hat{Z}^\nabla)$. \square

Lemma 8.26. *Choose $t \in \mathbb{R}$ such that h_t is non-degenerate. Then for all vector fields X and all $\nabla \in [\nabla]$, the following identities hold:*

- (1) $\nabla_X \pi(t) = h_t^{-1}(\hat{Z}^\nabla, X) \pi(t)$; and
- (2) $\nabla_X h_t^{-1} = \llbracket h_t^{-1}(X, \cdot), h_t^{-1}(\hat{Z}^\nabla, \cdot) \rrbracket$.

Proof. Since h_t is non-degenerate, there is a connection $\nabla^t \in [\nabla]$ with $\nabla^t h_t = 0$. Writing $\nabla = \nabla^t + \llbracket \cdot, \gamma_t \rrbracket$ for some $\gamma_t \in \Omega^1(M)$, we then have $\nabla_X h_t = \llbracket \llbracket X, \gamma_t \rrbracket, h_t \rrbracket = \llbracket h_t(\gamma_t, \cdot), X \rrbracket$. But also $\nabla_X h_t = \llbracket Z_t^\nabla, X \rrbracket$ for a section \hat{Z}^∇ of $\mathcal{L}^* \otimes TM$, which is independent of t ; applying ∂ to both expressions gives $\gamma_t = h_t^{-1}(\hat{Z}^\nabla, \cdot)$.

(1) Since $\nabla^t h_t = 0$ we also have $\nabla^t \pi(t) = 0$, giving $\nabla_X \pi(t) = \llbracket \llbracket X, h_t^{-1}(\hat{Z}^\nabla, \cdot) \rrbracket, \pi(t) \rrbracket = h_t^{-1}(\hat{Z}^\nabla, X) \pi(t)$ as claimed.

(2) Also $\nabla^t h_t^{-1} = 0$, so that $\nabla_X h_t^{-1} = \llbracket [X, h_t^{-1}(\hat{Z}^\nabla, \cdot)], h_t^{-1} \rrbracket$. Applying the Jacobi identity and observing that the bracket between $h_t^{-1}(\hat{Z}^\nabla, \cdot)$ and h_t^{-1} is trivial, we immediately obtain

$$\nabla_X h_t^{-1} = \llbracket [X, h_t^{-1}], h_t^{-1}(\hat{Z}^\nabla, \cdot) \rrbracket = \llbracket h_t^{-1}(X, \cdot), h_t^{-1}(\hat{Z}^\nabla, \cdot) \rrbracket$$

as required. \square

We are finally in a position to prove that the vector fields $X(t)$ mutually commute.

Proof of Theorem 8.22. The result is trivial if $s = t$, so assume that $s \neq t$. Moreover if h_t is degenerate then $X(t) = 0$ identically, so we may assume that h_s, h_t are both non-degenerate.

By Lemma 8.26(1) we have $\nabla \pi(t) = \pi(t)h_t^{-1}(\hat{Z}^\nabla, \cdot)$, so that writing $X(t)$ with respect to the Levi-Civita connection ∇ of h yields

$$X(t) = \pi(t)h(h_t^{-1}(\hat{Z}^\nabla, \cdot), \cdot). \quad (8.31)$$

Using both parts of Lemma 8.26, we find that the covariant derivative of $X(t)$ with respect to ∇ is given by

$$\begin{aligned} \nabla_Y X(t) &= \pi(t)h_t^{-1}(\hat{Z}^\nabla, Y)h(h_t^{-1}(\hat{Z}^\nabla)) + \pi(t)h(\llbracket h_t^{-1}(Y), h_t^{-1}(\hat{Z}^\nabla) \rrbracket(\hat{Z}^\nabla)) \\ &\quad + \pi(t)h(h_t^{-1}(\nabla_Y \hat{Z}^\nabla)), \end{aligned} \quad (8.32)$$

where we have written $h(\alpha) := h(\alpha, \cdot)$ and $h_t^{-1}(X) := h_t^{-1}(X, \cdot)$ for notational convenience. Since the algebraic bracket between $\pi(t)h_t^{-1}(\hat{Z}^\nabla, Y) \in \Omega^0(M; \mathcal{L})$ and $h(h_t^{-1}(\hat{Z}^\nabla)) \in \Omega^0(M; \mathcal{L}^* \otimes TM)$ is just the contraction, the first term on the right-hand side of (8.32) equals $\llbracket h_t^{-1}(\pi(t)\hat{Z}^\nabla, Y), h(h_t^{-1}(\hat{Z}^\nabla)) \rrbracket$. Writing $h(h_t^{-1}(\hat{Z}^\nabla)) = \llbracket h, h_t^{-1}(\hat{Z}^\nabla) \rrbracket$ and noting that the bracket between $\llbracket \pi(t)\hat{Z}^\nabla, h_t^{-1}(Y) \rrbracket \in \Omega^0(M; \mathcal{L})$ and $h \in \Omega^0(M; \mathcal{L}^* \otimes \mathcal{B})$ is trivial, applying the Jacobi identity to this term yields

$$\begin{aligned} &\llbracket h_t^{-1}(\pi(t)\hat{Z}^\nabla, Y), h(h_t^{-1}(\hat{Z}^\nabla)) \rrbracket \\ &= \llbracket \llbracket \pi(t)\hat{Z}^\nabla, h_t^{-1}(Y) \rrbracket, \llbracket h, h_t^{-1}(\hat{Z}^\nabla) \rrbracket \rrbracket \\ &= \llbracket h, \llbracket \llbracket \pi(t)\hat{Z}^\nabla, h_t^{-1}(Y) \rrbracket, h_t^{-1}(\hat{Z}^\nabla) \rrbracket \rrbracket \\ &= \llbracket h, \llbracket \llbracket \pi(t)\hat{Z}^\nabla, h_t^{-1}(\hat{Z}^\nabla) \rrbracket, h_t^{-1}(Y) \rrbracket \rrbracket \\ &\quad + \llbracket h, \llbracket \pi(t)\hat{Z}^\nabla, \llbracket h_t^{-1}(Y), h_t^{-1}(\hat{Z}^\nabla) \rrbracket \rrbracket \rrbracket \\ &= -h(\llbracket \llbracket \pi(t)\hat{Z}^\nabla, h_t^{-1}(\hat{Z}^\nabla) \rrbracket, h_t^{-1}(Y) \rrbracket, \cdot) \\ &\quad - h(\llbracket h_t^{-1}(Y), h_t^{-1}(\hat{Z}^\nabla) \rrbracket(\pi(t)\hat{Z}^\nabla, \cdot), \cdot). \end{aligned} \quad (8.33)$$

The second term on the right-hand side of (8.33) cancels with the second term on the

right-hand side of (8.32), so that

$$\nabla_Y X(t) = -h(\llbracket \llbracket \pi(t)\hat{Z}^\nabla, h_t^{-1}(\hat{Z}^\nabla) \rrbracket, h_t^{-1}(Y) \rrbracket, \cdot) + \pi(t)h(h_t^{-1}(\nabla_Y \hat{Z}^\nabla)). \quad (8.34)$$

Now let $Y = X(s) = \pi(s)h(h_s^{-1}(\hat{Z}^\nabla))$. We first deal with the second term on the right-hand side above. Since we may write $h_t = h(A_t \cdot, \cdot)$ for an invertible self-adjoint endomorphism $A_t : T^*M \rightarrow T^*M$, we have $h(h_t^{-1}(Y)) = A_t^{-1}Y$, where we use the same symbol to denote the transpose endomorphism $A_t : TM \rightarrow TM$. Trivialising \mathcal{L} with respect to $\pi := \text{pf } h$ and writing $\pi(t) = p(t)\pi$ for all $t \in \mathbb{R}$, (8.31) becomes $X(t) = p(t)A_t^{-1}(\pi\hat{Z}^\nabla)$. Therefore, the term under scrutiny becomes

$$\pi(t)h(h_t^{-1}(\nabla_{X(s)}\hat{Z}^\nabla)) = p(s)p(t)A_t^{-1}\nabla_{A_s^{-1}(\pi\hat{Z}^\nabla)}(\pi\hat{Z}^\nabla). \quad (8.35)$$

Since $A = \hat{h} \circ h^{-1} : TM \rightarrow TM$ and $\nabla(\pi\hat{Z}^\nabla)$ commute by Proposition 8.25, so also do A_t^{-1} and $\nabla(\pi\hat{Z}^\nabla)$; combining this with the fact that A_s^{-1} and A_t^{-1} commute for all $s, t \in \mathbb{R}$, we see that (8.35) is symmetric in s, t . Thus, it suffices to show that the first term alone in (8.34) (with $Y = X(s)$) vanishes upon alternation in s, t .

Since we may write $h = \frac{1}{s-t}(h_t - h_s)$, we have

$$h_t^{-1}(X(s), \cdot) = \frac{1}{s-t}\pi(s)(h_s^{-1}(\hat{Z}^\nabla) - h_t^{-1}(\hat{Z}^\nabla)),$$

and the first term on the right-hand side of (8.34) becomes

$$-\frac{1}{s-t}p(s)p(t)h(\llbracket \llbracket \pi\hat{Z}^\nabla, h_t^{-1}(\hat{Z}^\nabla) \rrbracket, \pi h_s^{-1}(\hat{Z}^\nabla) - \pi h_t^{-1}(\hat{Z}^\nabla) \rrbracket, \cdot).$$

Since both $\frac{1}{s-t}p(s)p(t)$ and $\pi h_s^{-1}(\hat{Z}^\nabla) - \pi h_t^{-1}(\hat{Z}^\nabla)$ are skew-symmetric in s, t , alternation yields

$$\frac{1}{s-t}p(s)p(t)h(\llbracket \llbracket \pi\hat{Z}^\nabla, h_s^{-1}(\hat{Z}^\nabla) - h_t^{-1}(\hat{Z}^\nabla) \rrbracket, \pi h_s^{-1}(\hat{Z}^\nabla) - \pi h_t^{-1}(\hat{Z}^\nabla) \rrbracket, \cdot). \quad (8.36)$$

Considering the metric $g := \pi^{-1}h^{-1}$ corresponding to the linear metric h , we have $h_s^{-1}(\hat{Z}^\nabla) - h_t^{-1}(\hat{Z}^\nabla) = g((A_s^{-1} - A_t^{-1})(\pi\hat{Z}^\nabla), \cdot)$. It is straightforward to see that $A_s^{-1} - A_t^{-1} = (s-t)A_s^{-1}A_t^{-1}$, so that the previous expression yields

$$\pi\hat{Z}^\nabla = \frac{1}{s-t}A_sA_t(h_s^{-1}(\hat{Z}^\nabla) - h_t^{-1}(\hat{Z}^\nabla))^\sharp.$$

Then (8.36) is of the form $\llbracket \llbracket A_{s,t}X, X^\flat \rrbracket, \pi X^\flat \rrbracket$, where

$$A_{s,t} := \frac{1}{(s-t)^2}p(s)p(t)A_sA_t$$

and $X := h(h_s^{-1}(\hat{Z}^\nabla) - h_t^{-1}(\hat{Z}^\nabla), \cdot)$.

Here $A_{s,t}$ is a g -self-adjoint element of \mathfrak{p}_M^0 by Lemma 7.60, so the Leibniz rule and

Lemma 8.23(2) yield

$$\begin{aligned} \llbracket [A_{s,t}X, X^b], \pi X^b \rrbracket &= \llbracket [A_{s,t}X, X^b], \pi \rrbracket \otimes X^b + \pi \otimes \llbracket [A_{s,t}X, X^b], X^b \rrbracket \\ &= g(X, A_{s,t}X)X^b - g(A_{s,t}X, X)X^b = 0. \end{aligned}$$

We conclude that $\nabla_{X(s)}X(t)$ is symmetric in s, t ; since we assume that ∇ is torsion-free, it follows that $[X(s), X(t)] = \nabla_{X(s)}X(t) - \nabla_{X(t)}X(s) = 0$ for all $s, t \in \mathbb{R}$. \square

Remark 8.27. The author suspects a more conceptually satisfactory proof of Theorem 8.22 is available, which exploits the facts that \mathbf{h} and $\boldsymbol{\pi}$ are in the kernels of the appropriate BGG operators, and that $X(\mathbf{h}, \boldsymbol{\pi})$ is the result of the BGG bilinear pairing operator $\mathcal{W} \times \mathcal{W}^* \rightarrow \mathfrak{g}$. One might expect strong restrictions on the pairings when there is a 2-dimensional family of solutions of each BGG operator. Unfortunately, the author was unable to make progress in this direction.

8.3 Relative eigenvalues and the order of a pencil

Suppose that M admits a pencil \mathbf{h} of linear metrics containing a non-degenerate metric, which we view as a section of $\mathcal{L}^* \otimes \mathcal{B} \otimes \mathcal{O}_V(1)$ over $M \times \mathbb{P}(V)$. The pfaffian $\boldsymbol{\pi} := \text{pf } \mathbf{h}$ lies in the kernel of the hessian (7.35) by Corollary 7.73. Choosing an affine chart on $\mathbb{P}(V)$ with linear metrics h, \hat{h} at $\infty, 0$, Corollary 8.8 allows us to view $\boldsymbol{\pi}$ as a polynomial $\pi(t)$ of degree n in t . Writing $\hat{h} = h(A \cdot, \cdot)$ as before,

$$\pi(t) := \text{pf } h_t = (\det(A - t\text{id}))^{1/r} (\text{pf } h)$$

and therefore the (possibly complex-valued) roots $\xi : M \rightarrow \mathbb{C}$ of $\pi(t)$ are precisely the eigenvalues of A . The following is immediate from Corollary 8.8.

Corollary 8.28. *The eigenvalues of A have algebraic multiplicity divisible by r .* \square

Forgetting the affine chart on $\mathbb{P}(V)$ and viewing $\boldsymbol{\pi}$ as a homogeneous polynomial of degree n in the parameters of the pencil, the roots of $\boldsymbol{\pi}$ are functions $\xi : M \rightarrow \mathbb{P}_{\mathbb{C}}(V \otimes \mathbb{C})$.

Definition 8.29. The (*relative*) *eigenvalues* of \mathbf{h} are the roots $\xi : M \rightarrow \mathbb{P}_{\mathbb{C}}(V \otimes \mathbb{C})$ of the pfaffian $\boldsymbol{\pi} = \text{pf } \mathbf{h}$. In an affine chart, we identify these with functions $\xi : M \rightarrow \mathbb{C}$.

Note that since A is self-adjoint with respect to all metrics in the pencil, its eigenvalues are either real-valued or occur in complex-conjugate pairs. In particular, if \mathbf{h} contains a positive definite linear metric then the eigenvalues are necessarily real-valued. Since we will not assume this, it will be necessary to deal with the Jordan normal form of \mathbf{h} , whose details we recall in Subsection 8.3.1. The eigenvalues of \mathbf{h} are not *a priori*

smooth functions $\xi : M \rightarrow \mathbb{C}$, so we must deal with the set of points on which the eigenvalues are “well-behaved”. There are two relevant notions of well-behaved here; we study both in Subsection 8.3.2 and show them to be equivalent, following Topalov’s treatment in the projective case [175] and in PQ^c -projective geometry [177].

In Subsection 8.3.3 we define an integer invariant of a pencil, called its *order*. This definition is well-known (and more readily accessible) in riemannian c-projective geometry, where the order equals the maximal dimension of the pointwise span of the canonical Killing fields [11]. Recently this definition has been extended to pseudo-riemannian c-projective geometry [51, §5.6]. Finally, we contemplate pencils containing a riemannian metric in Subsection 8.3.4.

8.3.1 Review of Jordan normal forms

The theory of Jordan normal forms over the complex numbers is well-known, but less common over the real numbers. We review this theory here for completeness; a readable introduction may be found in [180].

Let V be a complex vector space and $A \in \mathfrak{gl}(V)$ an endomorphism. The minimal polynomial of A splits as $m_A(t) = \prod_{i=1}^k (t - \xi_i)^{m_i}$ for ξ_i the eigenvalues of A . If an eigenvalue ξ has geometric multiplicity m , the Jordan decomposition theorem states that there is a basis of V in which the restriction of A to the *generalised eigenspace* $G_A(\xi) := \ker(A - \xi \text{id})^m$ of ξ is represented by a sum of the *Jordan blocks* of the form

$$J_k(\xi) = \begin{bmatrix} \xi & 1 & \cdots & 0 & 0 \\ 0 & \xi & \cdots & 0 & 0 \\ \vdots & \vdots & \ddots & \vdots & \vdots \\ 0 & 0 & \cdots & \xi & 1 \\ 0 & 0 & \cdots & 0 & \xi \end{bmatrix}, \quad (8.37)$$

with A represented by a direct sum of such blocks. For later use, we note that if $\xi \neq 0$ then the Jordan block $J_k(\xi)$ is invertible, with inverse

$$J_k(\xi)^{-1} = \begin{bmatrix} \xi^{-1} & -\xi^{-2} & \cdots & (-1)^{k+1} \xi^{-k} \\ 0 & \xi^{-1} & \cdots & (-1)^k \xi^{-k+1} \\ \vdots & \vdots & \ddots & \vdots \\ 0 & 0 & \cdots & \xi^{-1} \end{bmatrix}. \quad (8.38)$$

The part v_1, \dots, v_k of the Jordan basis spanning $G_A(\xi)$ is called the *Jordan chain*, and satisfies $Av_i = \xi v_i + v_{i-1}$. The following lemma will be useful later.

Lemma 8.30. *Let v_1, \dots, v_k be generalised eigenvectors of an endomorphism A corresponding to distinct eigenvalues ξ_1, \dots, ξ_k . Then v_1, \dots, v_k are linearly independent.*

Proof. By definition, there are $m_i \in \mathbb{N}$ such that $(A - \xi_i \text{id})^{m_i} v_i = 0$ for each $i = 1, \dots, k$. Suppose first that $v \in \ker(A - \xi_i)^{m_i} \cap \ker(A - \xi_j)$ for $i \neq j$. Then $Av = \xi_j v$ yields $(A - \xi_i \text{id})^{m_i} v = (\xi_j - \xi_i)^{m_i} v = 0$, so that $\xi_i \neq \xi_j$ implies $v = 0$ and hence

$$\ker(A - \xi_i \text{id})^{m_i} \cap \ker(A - \xi_j \text{id}) = 0.$$

Now suppose that $v \in \ker(A - \xi_i \text{id})^{m_i} \cap \ker(A - \xi_j \text{id})^{m_j}$ for $i \neq j$ and $m_j > 1$. Then $(A - \xi_j \text{id})^{m_j-1} v \in \ker(A - \xi_i \text{id})^{m_i} \cap \ker(A - \xi_j \text{id}) = 0$ by the above, so that $v \in \ker(A - \xi_i \text{id})^{m_i} \cap \ker(A - \xi_j \text{id})^{m_j-1}$. By induction we conclude that $v = 0$.

We prove the lemma by induction on k . It is obvious for $k = 1$, so assume it holds for some $k \geq 1$ and let $v_i \in \ker(A - \xi_i \text{id})^{m_i}$ for $i = 1, \dots, k+1$. Suppose that $\sum_{i=1}^{k+1} a_i v_i = 0$. Applying $(A - \xi_{k+1} \text{id})^{m_{k+1}}$ to this linear combination, we obtain

$$\sum_{i=1}^{k+1} a_i (A - \xi_{k+1} \text{id})^{m_{k+1}} v_i = \sum_{i=1}^k a_i (A - \xi_{k+1} \text{id})^{m_{k+1}} v_i = 0.$$

By the first paragraph we must have $(A - \xi_{k+1} \text{id})^{m_{k+1}} v_i \neq 0$ for $i \neq k+1$, so that $(A - \xi_{k+1} \text{id})^{m_{k+1}} v_i \in \ker(A - \xi_i \text{id})^{m_i}$ implies that $a_i = 0$ for $i = 1, \dots, k$ by the induction hypothesis. Since $v_{k+1} \neq 0$, it follows also that $a_{k+1} = 0$. \square

The Jordan normal form over a real vector space V may be described as follows. The inclusion $\mathfrak{gl}(n, \mathbb{C}) \hookrightarrow \mathfrak{gl}(2n, \mathbb{R})$ identifies each complex entry $z = a + \mathbf{i}b \in \mathbb{C}$ of a matrix in $\mathfrak{gl}(n, \mathbb{C})$ with the 2×2 real matrix $\begin{bmatrix} a & -b \\ b & a \end{bmatrix} \in \mathfrak{gl}(2, \mathbb{R})$. Complexifying V and writing each complex eigenvalue of A in real and complex parts, this substitution in the Jordan normal form (8.37) yields we arrive at the real Jordan normal form of A .

If $v_1, \dots, v_k \in V \otimes \mathbb{C}$ comprise a Jordan chain for an eigenvalue $\xi \in \mathbb{C}$, we can write $\xi = a + \mathbf{i}b$ and $v_i = x_i + \mathbf{i}y_i$ for $x_i, y_i \in V$. Comparing real and imaginary parts, the identity $Av_i = \xi v_i + v_{i-1}$ gives $Ax_i = ax_i - by_i + x_{i-1}$ and $Ay_i = ay_i + bx_i + y_{i-1}$. However, it is often convenient to complexify and avoid the real Jordan normal form altogether.

8.3.2 Stable and regular points

This subsection acts mainly as a technical stepping stone for defining the order of a pencil in Subsection 8.3.3. Since we are not assuming our metrisability pencil \mathbf{h} admits riemannian members, we must entertain the possibility that \mathbf{h} admits non-trivial Jordan blocks. Choosing an affine chart with linear metrics h, \hat{h} at $\infty, 0$ respectively, this means that the minimal and characteristic polynomials of the usual endomorphism $A = h^{-1} \circ \hat{h}$ of T^*M need not coincide. The minimal polynomial yields a section $\tilde{\pi}(t)$ of \mathcal{L} , which is polynomial in t of degree at most $n = \deg \pi(t)$ and whose roots are the eigenvalues of \mathbf{h} . Denote by $\text{rk } \mathbf{h}|_x$ the degree of $\tilde{\pi}(t)$ at $x \in M$, and write $\text{rk } \mathbf{h} = \max_{x \in M} \{\text{rk } \mathbf{h}|_x\}$.

Definition 8.31. Let $x \in M$.

- (1) Call x a *stable point* if there is an open neighbourhood $U \ni x$ on which $\text{rk } \mathbf{h}|_y$ is constant for all $y \in U(x)$. Denote the set of stable points in M by M^0 . A point is *singular* if it is not regular.
- (2) Call x a *regular point* if the rank $\text{rk } \mathbf{h}|_x$ is maximal among all points in M , *i.e.* $\text{rk } \mathbf{h}|_x = \text{rk } \mathbf{h}$. Denote the set of regular points by M^{reg} .

The goal of this subsection is to show that, if M is connected, the stable set M^0 and regular set M^{reg} coincide. We adapt the proof given by Topalov in PQ^c -projective geometry [177], which is largely algebraic and depends critically on the quadratic integrals of the geodesic flow constructed in Subsection 8.1.4.

Lemma 8.32. *Fix $x \in M$ and suppose that $U \subset \mathbb{R}$ is an open interval containing no eigenvalues of $\mathbf{h}|_x$. Then:*

- (1) $\dim \langle h_t^*|_x \mid t \in U \rangle = \text{rk } \mathbf{h}|_x$;
- (2) $\dim \langle h_t^*|_x(X, \cdot) \mid t \in U \rangle \leq \text{rk } \mathbf{h}|_x$ for every $X \in T_x M$, with equality for X lying in a dense open subset of $T_x M$; and
- (3) if $t_1, \dots, t_k \in U$ are $k := \text{rk } \mathbf{h}|_x$ distinct real numbers, the pointwise Killing 2-tensors $h_{t_1}^*|_x, \dots, h_{t_k}^*|_x$ are linearly independent elements of $\mathcal{L}_x^2 \otimes \mathcal{B}_x^*$.

Proof. For notational simplicity, we omit the evaluation at x from all tensors in this proof. Since by Proposition 8.7 the Killing 2-tensor h_t^* is a polynomial of degree $n - 1$ in t , we may write $h_t^* = \sum_{i=0}^{n-1} (-1)^i k_i t^i$, where the k_i are Killing 2-tensors by linearity of the Killing equation (8.3). Since this is a Vandermonde system (see [11, App. B]) and therefore invertible, we have

$$\begin{aligned} \langle h_t^* \mid t \in U \rangle &= \langle k_0, \dots, k_{n-1} \rangle \\ \text{and } \langle h_t^*(X, \cdot) \mid t \in U \rangle &= \langle k_0(X, \cdot), \dots, k_{n-1}(X, \cdot) \rangle \end{aligned} \tag{8.39}$$

for each $X \in T_x M$. Let $\ell \in \mathbb{N}$ denote the maximal rank of the $h_i^*(X, \cdot)$, *i.e.*

$$\ell := \max_{X \in T_x M} \{ \dim \langle h_0^*(X, \cdot), \dots, h_{n-1}^*(X, \cdot) \rangle \}.$$

The remainder of the proof is more straightforward if we assume without loss of generality that the linear metric h at ∞ is in Jordan normal form, for which we should complexify our current picture. Denoting the set of eigenvalues of $\mathbf{h}|_x$ by $S \subset \mathbb{C}$, complexifying yields complex Killing 2-tensors h_z^* for $z \in \mathbb{C} \setminus S$. As above, we may write $h_z^* = \sum_{i=0}^{n-1} (-1)^i k_i^{\mathbb{C}} z^i$ for complex Killing 2-tensors $k_i^{\mathbb{C}} \in (\mathcal{L}_x^2 \otimes \mathcal{B}_x^*) \otimes \mathbb{C}$. Clearly then

$$\dim \langle h_0^*, \dots, h_{n-1}^* \rangle = \dim_{\mathbb{C}} \langle k_0^{\mathbb{C}}, \dots, k_{n-1}^{\mathbb{C}} \rangle_{\mathbb{C}}, \tag{8.40}$$

and arguing using a Vandermonde system as above yields a complex analogue of (8.39):

$$\begin{aligned} \langle h_z^* \mid z \in \mathbb{C} \setminus S \rangle_{\mathbb{C}} &= \langle k_0^{\mathbb{C}}, \dots, k_{n-1}^{\mathbb{C}} \rangle_{\mathbb{C}} \\ \text{and } \langle h_z^*(X, \cdot) \mid z \in \mathbb{C} \setminus S \rangle_{\mathbb{C}} &= \langle k_0^{\mathbb{C}}(X, \cdot), \dots, k_{n-1}^{\mathbb{C}}(X, \cdot) \rangle_{\mathbb{C}} \end{aligned} \quad (8.41)$$

for each $X \in \mathbb{C}T_xM$. Combining (8.39), (8.40) and (8.41) we obtain

$$\begin{aligned} \dim \langle h_t^* \mid t \in U \rangle &= \dim_{\mathbb{C}} \langle h_z^* \mid z \in \mathbb{C} \setminus S \rangle_{\mathbb{C}} \\ \text{and } \ell &= \max_{X \in \mathbb{C}T_xM} \{ \dim_{\mathbb{C}} \langle h_z^*(X, \cdot) \mid z \in \mathbb{C} \setminus S \rangle_{\mathbb{C}} \}. \end{aligned} \quad (8.42)$$

With these preliminaries in hand, we may continue with the proof of the lemma.

(1) Continue to work with the complexification $h^{\mathbb{C}}$ of h , given in Jordan normal form. By the formula $h_z^* = (\det_{\mathbb{C}} h_z)^{1/r} (h_z^{\mathbb{C}})^{-1}$ for $z \in \mathbb{C} \setminus S$, the direct sum decomposition of $h^{\mathbb{C}}$ contains a Jordan block $J_k(\xi)$ if and only if the direct sum decomposition of h_z^* contains a Jordan block $\pi(t)J_k(\xi - z)^{-1}$. Since the size k of this block is at most the multiplicity of ξ as a root of $\pi(z)$, it is clear that $\text{rk } \mathbf{h}^{\mathbb{C}}|_x = \dim_{\mathbb{C}} \langle h_z^* \mid z \in \mathbb{C} \setminus S \rangle_{\mathbb{C}}$ by (8.38). Combining this with (8.42) completes the proof.

(2) We have $\dim_{\mathbb{C}} \langle h_z^*(X, \cdot) \mid z \in \mathbb{C} \setminus S \rangle_{\mathbb{C}} \leq \ell = \text{rk } \mathbf{h}|_x$ by (8.40) and the second equation of (8.42). By definition of ℓ , there is an $X \in T_xM$ and a multi-index $I = (i_1, \dots, i_{\ell})$ for $i_j \in \{0, \dots, n-1\}$ such that the weighted ℓ -covector

$$h_I^*(X, \cdot) := h_{i_1}^*(X, \cdot) \wedge \dots \wedge h_{i_{\ell}}^*(X, \cdot) \in \mathcal{L}_x^{2\ell} \otimes \wedge^{\ell} T_x^*M$$

is non-zero, with $h_J^*(X, \cdot) = 0$ for multi-indices J of length greater than ℓ . Choosing a basis in T_xM , the equation $h_I^*(X, \cdot) = 0$ is a homogeneous polynomial of degree ℓ in the components of X . It follows that the set of tangent vectors X for which $h_I^*(X, \cdot) \neq 0$ is open and dense in T_xM .

(3) Writing $h_t^* = \sum_{i=1}^{n-1} (-1)^i k_i t^i$ as above, evidently the k_i are linearly independent and independent of t . If t_1, \dots, t_k are $k := \text{rk } \mathbf{h}|_x = \dim \langle k_0, \dots, k_{n-1} \rangle$ distinct real numbers, a linear combination of the $h_{t_i}^*$ has the form

$$\begin{aligned} \sum_{i=1}^k a_i h_{t_i}^* &= \sum_{i=1}^k \sum_{j=1}^{n-1} (-1)^j a_i k_j t_i^j \\ &= (-1)^{n-1} k_{n-1} \sum_{i=1}^k a_i t_i^{n-1} + \dots + k_0 \sum_{i=1}^k a_i. \end{aligned} \quad (8.43)$$

This is a $k \times k$ Vandermonde system relating the t_i and a_i , which is invertible because the t_i are distinct. Thus, a linear combination (8.43) is zero if and only if the a_i all vanish, *i.e.* $h_{t_1}^*, \dots, h_{t_k}^*$ are linearly independent. \square

Our next task is to show that a generic point of M is stable.

Proposition 8.33. *The set $M^0 \subseteq M$ of stable points in M is open and dense.*

Proof. Clearly $M^0 \subseteq M$ is open by construction. We claim that if $x \in M$ is singular, then every open neighbourhood $U \ni x$ contains a point $y \in U$ for which $\text{rk } \mathbf{h}|_y > \text{rk } \mathbf{h}|_x$.

To prove the claim, choose $k := \text{rk } \mathbf{h}|_x$ distinct real numbers t_1, \dots, t_k which are not eigenvalues of $A|_x$. Using Lemma 8.32(3), the Killing 2-tensors $h_{t_1}^*|_x, \dots, h_{t_k}^*|_x$ are linearly independent elements of $\mathcal{L}_x^2 \otimes \mathcal{B}_x^*$, and by the smoothness of h_t^* and the implicit function theorem there is an open neighbourhood $U \ni x$ on which this linear independence holds. By Lemma 8.32(1),

$$\dim \langle h_t^*|_y \mid t \in \mathbb{R} \rangle = \text{rk } \mathbf{h}|_y$$

for all $y \in U$, so that the fact that $h_{t_1}^*|_y, \dots, h_{t_k}^*|_y$ are linearly independent implies that $\text{rk } \mathbf{h}|_y \geq k = \text{rk } \mathbf{h}|_x$ for all $y \in U$. However x is singular, so that $\text{rk } \mathbf{h}$ is non-constant on every open neighbourhood of x . In particular, every open neighbourhood of x contains a point y for which $\text{rk } \mathbf{h}|_y > \text{rk } \mathbf{h}|_x$.

It remains to show that $M^0 \subseteq M$ is dense. Suppose that $S \subset M$ is an open set consisting of singular points, and take $x_1 \in S$ with $\text{rk } \mathbf{h}|_{x_1} = k_1$. Applying the previous claim to $x = x_1$ yields a singular point $x_2 \in S$ with $\text{rk } \mathbf{h}|_{x_2} = k_2 > k_1$. Iterating now yields a singular point $x_\ell \in S$ of maximal rank, any neighbourhood of which contains a point of strictly larger rank. This contradicts the maximality of $\text{rk } \mathbf{h}|_{x_\ell}$, so that the singular open subset S cannot exist. It follows that the singular subset $S := M \setminus M^0$ has empty interior; equivalently, the closure of $M^0 = M \setminus (M \setminus S)$ equals the whole of M , so that M^0 is dense in M . \square

The inclusion $M^{\text{reg}} \subseteq M^0$ was proved in the final paragraph of Proposition 8.33.

Corollary 8.34. *Every regular point is stable, i.e. $M^{\text{reg}} \subseteq M^0$.* \square

Theorem 8.35. *If M is connected, every stable point is regular; thus $M^{\text{reg}} = M^0$.*

Proof. Suppose that $x \in M^0$ with $\text{rk } \mathbf{h}|_x = k$. By Lemma 8.32(3) there are distinct real numbers $t_1, \dots, t_k \in \mathbb{R}$ such that the pointwise Killing 2-tensors $h_{t_1}^*|_x, \dots, h_{t_k}^*|_x$ are linearly independent. By smoothness this also holds in a neighbourhood $U \ni x$ and, shrinking U if necessary, we may assume that \mathbf{h} has constant rank k on U . It follows that $h_t^* = \sum_{i=1}^k a_i h_{t_i}^*$ on U for smooth functions $a_i \in \Omega^0(U; \mathbb{R})$. Trivialising \mathcal{L}^2 with respect to the metric h at ∞ , both $(\text{pf } h)^{-2} h_t^*$ and the $(\text{pf } h)^{-2} h_{t_i}^*$ are integrals of the geodesic flow of $g := (\text{pf } h)^{-1} h^{-1}$, so by Proposition 8.9 they Poisson-commute with the hamiltonian of g . By linearity of the Poisson bracket, it follows that the functions a_i are also integrals of g , so are constant on U .

Viewing $h_t^*|_x$ as a quadratic function on $T_x M$, we have $d_X h_t^*|_x = 2h_t^*|_x(X, \cdot)$ for all $X \in T_x M$ once we make the canonical identification $T_X T_x M \cong T_x M$. By

Lemma 8.32(2), there is a dense open subset $V \subset T_x M$ for which $h_{t_1}^*|_x(X, \cdot), \dots, h_{t_k}^*|_x(X, \cdot)$ are linearly independent, so that $d_X h_{t_1}^*|_x, \dots, d_X h_{t_k}^*|_x$ are also linearly independent on V . By the implicit function theorem, their linear independence holds in a small neighbourhood of x which, shrinking U if necessary, coincides with U .

Now let $x_0 \in M^0$ and $x \in M^{\text{reg}}$ have ranks $k_0 \leq k$ respectively, and suppose that $k_0 < k$. By the above, there are k distinct real numbers t_1, \dots, t_k and a neighbourhood $U \ni x$ on which $h_{t_1}^*|_x, \dots, h_{t_k}^*|_x$ are functionally independent. Suppose that x, x_0 may be connected by a geodesic γ , with $\gamma(0) = x$ and $\gamma(1) = x_0$. If $\gamma'(0) \in T_x M$ does not lie in the subset $V \subset T_x M$ from above, replace γ with a geodesic with $\gamma(0) = x$ and $\gamma'(0) \in V$. Since V is dense in $T_x M$ and the exponential map is smooth, $\gamma'(0) \in V$ can be chosen so that $\gamma(1) = \exp \gamma'(0)$ lies in the neighbourhood of x_0 on which $\text{rk } \mathbf{h}|_{x_0} = k_0$ is constant. Replacing x_0 with $\gamma(1) \in M^0$, we may assume without loss of generality that $\gamma'(0) \in V$. By the above, $d_{\gamma'(0)} h_{t_1}^*|_x, \dots, d_{\gamma'(0)} h_{t_k}^*|_x$ are linearly independent at x . Moreover since $d_X h_t^*|_x = 2h_t^*|_X(X, \cdot)$ from above, the $(\text{pf } h)^{-2}|_x d_X h_t^*|_X$ are also integrals of g . Noting that $d_{\gamma'(1)} h_{t_i}^*|_{x_0}$ is the image of $d_{\gamma'(0)} h_{t_i}^*|_x$ under the 1-parameter family of diffeomorphisms of TM induced by the geodesic flow of g , we conclude that $d_{\gamma'(1)} h_{t_1}^*|_{x_0}, \dots, d_{\gamma'(1)} h_{t_k}^*|_{x_0}$ are linearly independent at x_0 .

On the other hand, by Lemma 8.32(2) we know that the $h_{t_i}^*|_{x_0}$ have span at most $k_0 < k$, and therefore by the previous paragraph we must have $h_{t_{k_0+1}}^*|_{x_0} = \sum_{i=1}^{k_0} a_i h_{t_i}^*|_{x_0}$ for constants a_i . Differentiating gives $d_{\gamma'(1)} h_{t_{k_0+1}}^*|_{x_0} = \sum_{i=1}^{k_0} a_i d_{\gamma'(1)} h_{t_i}^*|_{x_0}$, contradicting the linear independence of $d_{\gamma'(1)} h_{t_1}^*|_{x_0}, \dots, d_{\gamma'(1)} h_{t_k}^*|_{x_0}$ deduced in the previous paragraph. Thus it is impossible that $k_0 < k$, giving $k_0 = k$ by maximality of k , and therefore all stable points which are geodesically connected to a regular point are themselves regular. Finally, if M is connected, any two points may be connected by a finite sequence of geodesic segments, so that $M^{\text{reg}} \subseteq M^0$. \square

Recall that a set of functions are *functionally independent* if their differentials are linearly independent on a dense open subset. The following is immediate.

Corollary 8.36. *If t_1, \dots, t_k are $k := \text{rk } \mathbf{h}$ distinct real numbers which are not eigenvalues of \mathbf{h} , the Killing 2-tensors $h_{t_1}^*, \dots, h_{t_k}^*$ are functionally independent on TM . \square*

When M is connected, we shall dispense with the notation M^{reg} and simply write M^0 for the subset of regular points, which necessarily have maximal rank $\text{rk } \mathbf{h}$.

8.3.3 The order of a pencil

The order of a metrisability pencil \mathbf{h} will be a canonical integer $\ell \in \mathbb{Z}$ associated to the eigenvalues of \mathbf{h} . To define it, we will split the study of the eigenvalues of \mathbf{h} into the

study of the constant and non-constant eigenvalues. We begin by analysing eigenvalues of higher geometric multiplicity, following the methods of [31, Prop. 1].

Theorem 8.37. *Let $U \subset M^0$ be an open subset of regular points of M , and suppose that $\xi : U \rightarrow \mathbb{C}$ is a smooth eigenvalue of \mathbf{h} with geometric multiplicity at least two at all points of U . Then:*

- (1) ξ is a constant function; and
- (2) if M is connected, ξ is an eigenvalue of \mathbf{h} of geometric multiplicity at least two at all points of M .

Proof. (1) Choose an affine chart for \mathbf{h} with non-degenerate linear metrics at $\infty, 0$, and form the usual endomorphism A defined by $\hat{h} = h(A \cdot, \cdot)$. Since A is self-adjoint with respect to any metric in the pencil, there are two cases to consider: either (a) $\xi : U \rightarrow \mathbb{R}$ is real-valued; or (b) $\xi, \bar{\xi} : U \rightarrow \mathbb{C}$ is a pair of complex-conjugate eigenvalues. We treat these two cases individually.

(a) Suppose that $\xi : U \rightarrow \mathbb{R}$ is real-valued and non-constant. Then there is a point $x_0 \in U$ such that $d\xi|_{x_0} \neq 0$, and, shrinking U if necessary, it follows that x_0 is a regular value of ξ . Then by Sard's theorem, the level set

$$U_0 := \{x \in U \mid \xi(x) = \xi(x_0)\} \subseteq U$$

is a regular submanifold of U of codimension one. By the assumption that ξ is non-constant, we can choose a point $y \in U$ with $y \notin U_0$. Let $\gamma_{x,y}$ be a geodesic joining a point $x \in U_0$ to y with $\gamma_{x,y}(0) = x$ and $\gamma_{x,y}(1) = y$, and consider all such geodesics as $x \in U_0$ varies. Choose $y \notin U_0$ in a small neighbourhood of x_0 onto which the exponential map is a diffeomorphism from a neighbourhood of zero in $T_{x_0}M$. Since U_0 has codimension one, it follows that for such y the subset

$$V_{x_0,y} := \bigcup_{x \in U_0} \langle \gamma'_{x,y}(1) \rangle \subseteq T_y M \tag{8.44}$$

contains a non-empty open subset of $T_y M$. Since ξ is also a root of $\pi(t) := (\det h_t)^{1/r}$, the linear metric $h_{\xi(x_0)}|_x$ is degenerate and hence $(\text{pf } h_{\xi(x_0)})h_{\xi(x_0)}^*|_x = 0$ for all $x \in U_0$. In particular, $(\text{pf } h_{\xi(x_0)})h_{\xi(x_0)}^*|_x(\gamma'_{x,y}(0), \gamma'_{x,y}(0)) = 0$, yielding $(\text{pf } h_{\xi(x_0)})h_{\xi(x_0)}^*|_y(v, v) = 0$ for all $v \in V_{x_0,y}$. Since $(\text{pf } h_{\xi(x_0)})h_{\xi(x_0)}^*|_y$ is bilinear and $V_{x_0,y}$ contains a non-empty open subset of $T_y M$, it follows that $(\text{pf } h_{\xi(x_0)})h_{\xi(x_0)}^*|_y = 0$ and hence $\text{pf } h_{\xi(x_0)}|_y = 0$. Thus $\xi(x_0)$ is an eigenvalue of \mathbf{h} at y , so that ξ is constant in a neighbourhood of x_0 . This contradicts our assumption that $d\xi|_{x_0} \neq 0$.

(b) Suppose now that $\xi, \bar{\xi} : U \rightarrow \mathbb{C}$ are a pair of complex-conjugate eigenvalues. For each $z \in \mathbb{C}$, h_z^* is a complex Killing 2-tensor, so both its real and imaginary parts

are real Killing 2-tensors. Suppose that $x_0 \in U$ is a point with $d\xi|_{x_0} \neq 0$, and let $U_0 := \{x \in M \mid \xi(x) = \xi(x_0)\}$ as in (a).

Suppose first that the differentials of $\operatorname{Re}[\xi]$ and $\operatorname{Im}[\xi]$ are proportional. Then, shrinking U if necessary, U_0 is a regular submanifold of codimension one in U . Arguing as in (a), we conclude that both $\operatorname{Re}[\xi]$, $\operatorname{Im}[\xi]$ and hence ξ are constant in a neighbourhood of x_0 , contradicting our assumption that $d\xi|_{x_0} \neq 0$.

Suppose instead that the differentials of $\operatorname{Re}[\xi]$ and $\operatorname{Im}[\xi]$ are not proportional. Then, shrinking U if necessary, U_0 is regular submanifold of U of codimension two. Let $y \in U$ and, as before, consider all geodesics $\gamma_{x,y}$ connecting points $x \in U_0$ to y ; we suppose that $\gamma_{x,y}(0) = x$ and $\gamma_{x,y}(1) = y$. Arguing as in (a), if y lies in a sufficiently small open subset of x_0 then the subset $V_{x_0,y}$ defined by (8.44) contains a non-empty submanifold of $T_y M$ of codimension one. Then, since

$$h_{\xi(x_0)}^*|_y(X, X) = h_{\xi(x_0)}^*|_x(\gamma'_{x,y}(0), \gamma'_{x,y}(0)) = 0$$

for all $X \in V_{x_0,y}$, we conclude that $\operatorname{Re}[h_{\xi(x_0)}^*|_y(X, X)]$ and $\operatorname{Im}[h_{\xi(x_0)}^*|_y(X, X)]$ are proportional for all $X \in T_y M$. Since these components are Killing 2-tensors, the function of proportionality must be constant, so that there is a complex number $0 \neq a + \mathbf{b}i \in \mathbb{C}$ satisfying

$$(a + \mathbf{b}i)h_{\xi(x_0)}^*|_y(X, X) = (a - \mathbf{b}i)h_{\bar{\xi}(x_0)}^*|_y(X, X) \quad (8.45)$$

for all $X \in T_y M$. At points $y \in U$ with $y \notin U_0$, $\xi(y) \neq \xi(x_0)$ and thus $h_{\xi(x_0)}|_y$ is non-degenerate. Taking a trace in (8.45) with respect to the linear metric h at ∞ yields that $h_{\xi(x_0)}^*|_y$ and $h_{\bar{\xi}(x_0)}^*|_y$ are proportional, implying that $\xi(x_0) = \bar{\xi}(x_0)$. This contradicts our assumption that ξ is not real.

(2) Suppose now that $\xi : U \rightarrow \mathbb{C}$ is a constant (real- or complex-valued) eigenvalue of \mathbf{h} of geometric multiplicity at least two. Choose a point $y \in M \setminus U$ which can be connected to a point $x \in U$ by a geodesic γ , with $\gamma(0) = y$ and $\gamma(1) = x \in U$; thus $\gamma = \gamma_{y,\gamma'(0)}$. Consider also the geodesics $\gamma_{y,Y}$ with $\gamma_{y,Y}(0) = y$ and $\gamma'_{y,Y}(0) = Y \in T_y M$. Since the exponential map is smooth, there is an open neighbourhood $V \subset T_y M$ of $\gamma'(0)$ such that $\gamma_{y,Y}(1) = \exp_y Y$ lies in U for all $Y \in V$. Now, because ξ is an eigenvalue of geometry multiplicity at least two, we have $h_{\xi}^*|_x(\gamma'_{y,Y}(1), \gamma'_{y,Y}(1)) = 0$ for all $Y \in V$. Since $(\operatorname{pf} h)^{-2} h_{\xi}^*$ is an integral of $g := (\operatorname{pf} h)^{-2} h^{-1}$, this yields $h_{\xi}^*|_y(\gamma'_{y,v}(0), \gamma'_{y,v}(0)) = h_{\xi}^*|_y(Y, Y) = 0$ for all $Y \in V$ also. Then $h_{\xi}^*|_y$ vanishes on a non-empty open subset of $T_y M$, so vanishes identically on the whole of $T_y M$ by bilinearity, and it follows that ξ is an eigenvalue of geometric multiplicity at least two at y .

Any point in a neighbourhood $U_0 \ni y$ is also geodesically connected to a point in U , so ξ is an eigenvalue of geometric multiplicity at least two in U_0 . Finally, if M is

connected, then any two points may be connected by a piecewise geodesic curve. \square

In particular, the contrapositive of Theorem 8.37(1) implies that there is a single Jordan block for each non-constant eigenvalue of \mathbf{h} . Note however that the opposite implication does not hold in general: constant eigenvalues may still have geometric multiplicity one.

Next we would like to analyse the derivatives of the eigenvalues of the pencil \mathbf{h} . In \mathbb{C} -projective geometry, Calderbank *et al.* have recently shown [51, Cor. 5.17] that $d\xi$ is an eigenform with eigenvalue ξ ; see also [36]. This is not quite true for a general projective parabolic geometry. We will need the following lemma; this is presumably well-known, but the author could not find a reference.

Lemma 8.38. *Suppose that $A : V \rightarrow V$ is a linear endomorphism of a vector space V , and let ξ of be an eigenvalue of A with generalised eigenspace $G_A(\xi)$. Then the linear map given by projection onto $G_A(\xi)$ is polynomial in A .*

Proof. Let m denote the multiplicity of ξ as a root of the minimal polynomial $m_A(t)$ of A . Then $q(t) := m_A(t)/(t - \xi)^m$ is polynomial in t which is coprime to $(t - \xi)^m$, so by Euclid's algorithm there are polynomials $a(t), b(t)$ such that

$$a(t)q(t) = 1 - b(t)(t - \xi)^m. \quad (8.46)$$

Substituting the linear operator A in place of t , we have

$$\begin{aligned} (a(A)q(A))^2 &= a(A)q(A)(1 - b(A)(A - \xi \text{id})^m) \\ &= a(A)q(A) - a(A)b(A)q(A)(A - \xi \text{id})^m \\ &= a(A)q(A) - a(A)b(A)m_A(A) \\ &= a(A)q(A) \end{aligned}$$

since $m_A(A) = 0$ by definition, so that $a(A)q(A)$ is a projection. Moreover, since $G_A(\xi)$ coincides with the kernel of $(A - \xi \text{id})^m$, the identity $(A - \xi \text{id})^m q(A) = m_A(A) = 0$ implies that $q(A)$ takes values in $G_A(\xi)$. Since A preserves $G_A(\xi)$, it follows that $a(A)q(A)$ also takes values in $G_A(\xi)$. Finally, (8.46) implies that $a(A)q(A)$ restricts to the identity on $G_A(\xi)$. Therefore $a(A)q(A)$ is the projection to $G_A(\xi)$, which is polynomial in A as required. \square

Theorem 8.39. *Let $\xi : M \rightarrow \mathbb{C}$ be an eigenvalue of the pencil \mathbf{h} in a neighbourhood U of regular points. Choose an affine chart for \mathbf{h} with non-degenerate metrics h, \hat{h} at $\infty, 0$, and form the usual endomorphism A defined by $\hat{h} = h(A \cdot, \cdot)$. Then $d\xi$ is a generalised eigenform of A with eigenvalue ξ on U .*

Proof. Choose an affine chart of \mathbf{h} with metrics h, \hat{h} at $\infty, 0$, with h non-degenerate, and form the usual endomorphism A defined by $\hat{h} = h(A \cdot, \cdot)$. Then ξ is an eigenvalue of A , and in a neighbourhood of a point $x \in U$, we can choose a local frame with respect to which A is in Jordan normal form. If ξ is constant then $d\xi = 0$ and there is nothing to prove. Therefore we assume that $d\xi|_x \neq 0$ for at least one point $x \in U$.

Suppose that the generalised eigenspace $G_A(\xi)$ has dimension k . Then by the contrapositive of Theorem 8.37(1), $G_A(\xi)$ is spanned by a single Jordan chain $\alpha_k, \dots, \alpha_1$ of generalised eigenforms, which satisfy $A\alpha_i = \xi\alpha_i + \alpha_{i-1}$ with $\alpha_0 := 0$. Let X_k, \dots, X_1 be the dual coframe. Then the transpose endomorphism $A^\top : TM \rightarrow TM$ satisfies

$$\begin{aligned} \alpha_i(A^\top X_i) &= (A\alpha_i)(X_j) \\ &= (\xi\alpha_i + \alpha_{i-1})(X_j) = \alpha_i(\xi X_j + X_{j+1}), \end{aligned} \quad (8.47)$$

so that the restriction of A^\top to $G_A(\xi)$ is also in Jordan normal with respect to the X_i , providing we reverse their order. In particular $A^\top X_i = \xi X_i + X_{i+1}$, where $X_{k+1} := 0$.

Let $\nabla \in [\nabla]$ be the Levi-Civita connection of h provided by Corollary 7.58. Then $\nabla_X \hat{h} = \llbracket \hat{Z}^\nabla, X \rrbracket$ for some $\hat{Z}^\nabla \in \Omega^0(M; \mathcal{L}^* \otimes TM)$ by (7.25), so that the defining relation $\hat{h} = h(A \cdot, \cdot)$ gives $(\nabla_X A)\alpha = \llbracket h^{-1}, \llbracket \hat{Z}^\nabla, X \rrbracket, \alpha \rrbracket$ for all $\alpha \in \Omega^1(M)$. For all $i = 1, \dots, k$, differentiating the identity $A\alpha_i = \xi\alpha_i + \alpha_{i-1}$ then gives

$$\llbracket h^{-1}, \llbracket \hat{Z}^\nabla, X \rrbracket, \alpha_i \rrbracket + A(\nabla_X \alpha_i) = d\xi(X)\alpha_i + \xi(\nabla_X \alpha_i) + \nabla_X \alpha_{i-1}. \quad (8.48)$$

Now (8.47) implies that

$$(A\nabla_X \alpha_i)(X_i) = (\nabla_X \alpha_i)(A^\top X_i) = (\nabla_X \alpha_i)(\xi X_i + X_{i+1}),$$

so that by contracting (8.48) with X_i and rearranging we obtain

$$\begin{aligned} d\xi(X) &= \langle \llbracket h^{-1}, \llbracket \hat{Z}^\nabla, X \rrbracket, \alpha_i \rrbracket, X_i \rangle \\ &\quad + (\nabla_X \alpha_i)(\xi X_i + X_{i+1}) - \xi(\nabla_X \alpha_i)(X_i) - (\nabla_X \alpha_{i-1})(X_i) \\ &= \langle \llbracket h^{-1}, \llbracket \hat{Z}^\nabla, X \rrbracket, \alpha_i \rrbracket, X_i \rangle \\ &\quad + (\nabla_X \alpha_i)(X_{i+1}) - (\nabla_X \alpha_{i-1})(X_i). \end{aligned}$$

Summing over $i = 1, \dots, k$, the two terms on the last line telescopically cancel, leaving

$$k d\xi(X) = \sum_{i=1}^k \langle \llbracket h^{-1}, \llbracket \hat{Z}^\nabla, X \rrbracket, \alpha_i \rrbracket, X_i \rangle. \quad (8.49)$$

For each i , invariance of the Killing form gives

$$\langle \llbracket h^{-1}, \llbracket \hat{Z}^\nabla, X \rrbracket, \alpha_i \rrbracket, X_i \rangle = \langle \llbracket \alpha_i, \llbracket X_i, h^{-1} \rrbracket \rrbracket, \hat{Z}^\nabla, X \rangle.$$

On the other hand $d\xi(X) = \langle d\xi, X \rangle$, thus giving

$$k d\xi = \sum_{i=1}^k \llbracket \llbracket \alpha_i, [X_i, h^{-1}] \rrbracket, \hat{Z}^\nabla \rrbracket \quad (8.50)$$

by non-degeneracy of the Killing form. For each summand, the Jacobi identity yields

$$\begin{aligned} \llbracket \llbracket \alpha_i, [X_i, h^{-1}] \rrbracket, \hat{Z}^\nabla \rrbracket &= \llbracket \llbracket \llbracket \alpha_i, X_i \rrbracket, h^{-1} \rrbracket, \hat{Z}^\nabla \rrbracket \\ &= \llbracket \llbracket \llbracket \alpha_i, X_i \rrbracket, \hat{Z}^\nabla \rrbracket, h^{-1} \rrbracket + \llbracket \llbracket \alpha_i, X_i \rrbracket, [h^{-1}, \hat{Z}^\nabla] \rrbracket \\ &= h^{-1}(\llbracket \llbracket X_i, \alpha_i \rrbracket, \hat{Z}^\nabla \rrbracket, \cdot) - \llbracket \llbracket X_i, \alpha_i \rrbracket, h^{-1}(\hat{Z}^\nabla, \cdot) \rrbracket. \end{aligned} \quad (8.51)$$

For notational convenience, write $\pi := \text{pf } h$ and suppose that $g := \pi^{-1}h^{-1}$ is the metric associated to h . Then we can write $\hat{Z}^\nabla = \pi^{-1}\Lambda$ for $\Lambda := \pi\hat{Z}^\nabla \in \Omega^0(M; TM)$,³ and the first term on the right-hand side of (8.51) evaluates to

$$\begin{aligned} h^{-1}(\llbracket \llbracket X_i, \alpha_i \rrbracket, \pi^{-1}\Lambda \rrbracket, \cdot) &= -h^{-1}(\alpha_i(X_i)\pi^{-1}\Lambda, \cdot) + h^{-1}(\pi^{-1}\llbracket \llbracket X_i, \alpha_i \rrbracket, \Lambda \rrbracket, \cdot) \\ &= -\Lambda^\flat + \llbracket \llbracket X_i, \alpha_i \rrbracket, \Lambda \rrbracket^\flat \end{aligned}$$

It follows from (8.51) and Lemma A.1 that

$$\begin{aligned} \llbracket \llbracket \alpha_i, h^{-1}(X_i, \cdot) \rrbracket, \hat{Z}^\nabla \rrbracket &= -\Lambda^\flat + \llbracket \llbracket X_i, \alpha_i \rrbracket, \Lambda \rrbracket^\flat - \llbracket \llbracket X_i, \alpha_i \rrbracket, \Lambda^\flat \rrbracket \\ &= -\Lambda^\flat + \llbracket \llbracket X_i, \alpha_i \rrbracket, \Lambda \rrbracket^\flat + \llbracket \llbracket \alpha_i^\sharp, X_i \rrbracket, \Lambda \rrbracket^\flat \\ &= -\Lambda^\flat + \llbracket \llbracket \text{id} \odot g \rrbracket_{X_i, \alpha_i^\sharp}, \Lambda \rrbracket^\flat. \end{aligned}$$

Substituting the last display into (8.50), applying \sharp to both sides and dividing by $k \neq 0$, we obtain

$$d\xi^\sharp = -\Lambda + \frac{1}{k} \sum_{i=1}^k \llbracket \llbracket \text{id} \odot g \rrbracket_{X_i, \alpha_i^\sharp}, \Lambda \rrbracket. \quad (8.52)$$

We next evaluate the symmetrised algebraic bracket. First observe that since A is g -self-adjoint, the musical isomorphisms $\flat = \sharp^{-1} : TM \rightarrow T^*M$ restrict to isomorphisms of the ξ -generalised eigenspaces G_{A^\top} of A^\top and $G_A(\xi)$ of A . Since $\{X_i\}_{i=1}^k$ is a basis of $G_{A^\top}(\xi)$ with dual basis $\{\alpha_i\}_{i=1}^k$, for any $Y \in \Omega^0(M; TM)$ and any $\beta \in \Omega^1(M)$ we have

$$\sum_{i=1}^k \beta(\llbracket \llbracket X_i, \alpha_i \rrbracket, Y \rrbracket) = \sum_{i=1}^k \alpha_i(\llbracket \llbracket Y, \beta \rrbracket, X_i \rrbracket) = \text{tr}(\llbracket Y, \beta \rrbracket|_{G_{A^\top}(\xi)}), \quad (8.53)$$

where $\cdot|_{G_{A^\top}(\xi)}$ denotes the restriction to $G_{A^\top}(\xi)$. If $\Pi_\xi : \Omega^0(M; TM) \rightarrow \Omega^0(M; TM)$ is the projection onto $G_{A^\top}(\xi)$ then it is easy to see that Π_ξ is self-adjoint with respect to g . Moreover Π_ξ is polynomial in $A^\top \in \Omega^0(M; \mathfrak{p}_M^0)$ by Lemma 8.38, hence itself a

³By Proposition 8.4, Λ coincides with the vector field of the same name appearing in [36, 52, 138].

section of \mathfrak{p}_M^0 by Corollary 7.61. Therefore we may apply Lemma A.4 to (8.53), yielding

$$\mathrm{tr}(\llbracket Y, \beta \rrbracket|_{G_A(\xi)}) = \mathrm{tr}(\llbracket Y, \beta \rrbracket \circ \Pi_\xi) = \frac{1}{2}((\mathrm{tr} \Pi_\xi)\beta(Y) + r\beta(\Pi_\xi Y)).$$

Since $G_A(\xi)$ has dimension k by assumption, the projection Π_ξ has trace k . Moreover if Y lies in a generalised eigenspace for an eigenvalue $\mu \neq \xi$, we have $\Pi_\xi Y = 0$ and hence $\mathrm{tr}(\llbracket Y, \beta \rrbracket|_{G_{A^\top}(\xi)}) = \frac{k}{2}\beta(Y)$. Since $\beta \in \Omega^1(M)$ is arbitrary, we conclude from (8.53) that

$$\sum_{i=1}^k \llbracket X_i, \alpha_i \rrbracket = \frac{k}{2} \mathrm{id} \quad \mathrm{mod} \ G_{A^\top}(\xi).$$

Since $\{X_i^\flat\}_{i=1}^k$ and $\{\alpha_i^\sharp\}_{i=1}^k$ are also dual bases of $G_A(\xi)$ and $G_{A^\top}(\xi)$, we similarly obtain $\sum_{i=1}^k \llbracket X_i^\flat, \alpha_i^\sharp \rrbracket = \frac{k}{2} \mathrm{id} \quad \mathrm{mod} \ G_{A^\top}(\xi)$, thus giving

$$\sum_{i=1}^k \llbracket \mathrm{id} \odot g \rrbracket_{X_i, \alpha_i^\sharp} = k \mathrm{id} \quad \mathrm{mod} \ G_{A^\top}(\xi). \quad (8.54)$$

Now write $\Lambda = \sum_\mu \Lambda_\mu$ according to the generalised eigenspace decomposition of A^\top , where the sum runs over all distinct eigenvalues of A , and $\Lambda_\mu \in G_{A^\top}(\mu)$. Applying (8.54) to the expression (8.52) for $d\xi^\sharp$, we conclude that

$$d\xi^\sharp = -\Lambda_\xi + \sum_{i=1}^k \llbracket \llbracket \mathrm{id} \odot g \rrbracket_{X_i, \alpha_i^\sharp}, \Lambda_\xi \rrbracket. \quad (8.55)$$

It remains to see that $\llbracket X_i, \alpha_i \rrbracket$ preserves $G_{A^\top}(\xi)$. If ξ has multiplicity m as a root of the minimal polynomial of A then $G_{A^\top}(\xi)$ coincides with the kernel of $A_\xi^m := (A^\top - \xi \mathrm{id})^m$, which is a section of \mathfrak{p}_M^0 by Corollary 7.61. Then for any $Y \in G_{A^\top}(\xi)$, we have

$$\begin{aligned} A_\xi^m(\llbracket \llbracket X_i, \alpha_i \rrbracket, Y \rrbracket) &= \llbracket \llbracket A_\xi^m, X_i \rrbracket, \alpha_i \rrbracket, Y \rrbracket + \llbracket \llbracket X_i, \llbracket A_\xi^m, \alpha_i \rrbracket \rrbracket, Y \rrbracket \\ &\quad + \llbracket \llbracket X_i, \alpha_i \rrbracket, \llbracket A_\xi^m, Y \rrbracket \rrbracket \\ &= 0, \end{aligned}$$

whence $\llbracket \llbracket X_i, \alpha_i \rrbracket, Y \rrbracket \in G_{A^\top}(\xi)$ also. Similarly $\llbracket \alpha_i^\sharp, X_i \rrbracket$ preserves $G_{A^\top}(\xi)$, so that (8.55) implies that $d\xi^\sharp \in G_{A^\top}(\xi)$. Finally, we recall that \flat restricts to an isomorphism between $G_{A^\top}(\xi)$ and $G_A(\xi)$, giving $d\xi \in G_A(\xi)$ as required. \square

Corollary 8.40. *There is an integer $\ell \in \mathbb{N}$, equal to the number of distinct non-constant eigenvalues of \mathbf{h} , such that the span of the $d\xi_i|_x$ has dimension ℓ for all $x \in M^0$. In particular, the ξ_i are functionally independent on M .*

Proof. Suppose $x \in M^0$ is a regular point. Then, by the results of Subsection 8.3.2, the minimal polynomial of \mathbf{h} has constant and maximal degree in a neighbourhood

$U \ni x$; equivalently, the number of distinct eigenvalues of $\mathbf{h}|_y$ is constant and maximal for all $y \in U$. It follows that if $\xi_j(x) = \xi_k(x)$ for $j \neq k$ then $x \notin M^0$, so that the ξ_i are pointwise distinct on M^0 ; cf. [51, Rmk. 5.4]. Applying Theorem 8.39, the $d\xi_i|_x$ lie in distinct generalised eigenspaces of $\mathbf{h}|_x$ and are therefore linearly independent at x by Lemma 8.30. Since $M^0 \subset M$ is open and dense by Proposition 8.33, it also follows that the ξ_i are functionally independent. \square

The integer $\ell \in \mathbb{N}$ from Corollary 8.40 is then an invariant of the metrisability pencil \mathbf{h} , prompting the following definition; cf. [11, 12, 36].

Definition 8.41. The integer $\ell := \dim_{\mathbb{C}} \langle d\xi_1|_{M^0}, \dots, d\xi_n|_{M^0} \rangle_{\mathbb{C}}$ satisfying $0 \leq \ell \leq n$ from Corollary 8.40 is called the *order* of the metrisability pencil \mathbf{h} .

In the case $\ell = n$, all roots of $\pi(t)$ are distinct and non-constant. Then the minimal and characteristic polynomials of \mathbf{h} coincide, *i.e.* $\tilde{\pi}(t) = \pi(t)$, and each eigenvalue has both characteristic and geometric multiplicities equal to one. In particular, \mathbf{h} is semisimple. On the other hand, if $\ell = 0$ then \mathbf{h} has no non-constant eigenvalues. Applying Proposition 8.4 to an affine chart we conclude that $\hat{Z}^{\nabla} = 0$, so that all linear metrics in \mathbf{h} are affinely equivalent.

Remark 8.42. In c-projective geometry (and also hypercomplex geometry), the existence of Killing vector fields allows us to replace “geometric multiplicity” with “algebraic multiplicity” in the previous results. Indeed, the Killing fields provide linear integrals of the geodesic flow, and let us argue using the characteristic polynomial $\pi(t)$ of A rather than the minimal polynomial $\tilde{\pi}(t)$; see [51, Lem. 5.16] for details.

8.3.4 Special features of riemannian pencils

Let \mathbf{h} be a non-degenerate pencil of linear metrics. Choosing an affine chart with linear metrics h, \hat{h} at $\infty, 0$ respectively, we remarked above that the eigenvalues of a pencil \mathbf{h} are either real-valued or come in complex-conjugate pairs. In particular, if it is possible to choose h, \hat{h} to be positive definite, the eigenvalues of \mathbf{h} are real-valued. This is the situation most commonly encountered in the literature.

Definition 8.43. A *riemannian pencil* is a pencil admitting an affine chart with linear metrics of riemannian signature at $\infty, 0$.

Note that it is sufficient for the pencil to admit a single linear metric \hat{h} of riemannian signature. Indeed, putting this metric at 0 and any other linear metric h at ∞ defines an affine chart, and $h_t := \hat{h} - th$ will have riemannian signature for t close to zero.

In projective geometry, it is known that the (necessarily real-valued) eigenvalues of such a pencil have a global ordering [34, 134, 178], and a similar result is implicit in \mathbb{C} -projective by the results of [12]. Adapting the proof given by Bolsinov and Matveev in [34, Thm. 3], we generalise this result to all projective parabolic geometries admitting a riemannian pencil \mathbf{h} . We fix an affine chart with riemannian linear metrics h, \hat{h} at $\infty, 0$ and denote the (possibly indistinct) n roots of $\pi(t) := \text{pf } h_t$ by ξ_1, \dots, ξ_n .

Lemma 8.44. *Let $x \in M$, and consider the roots $t_1(x, X) \leq \dots \leq t_{n-1}(x, X)$ of the degree $n - 1$ polynomial $h_t^*|_x(X, X)$ at x . Then:*

- (1) $t_i(x, X) \in \mathbb{R}$ and satisfies $\xi_i(x) \leq t_i(x, X) \leq \xi_{i+1}(x)$ for all $X \in T_x M$ and every $i = 1, \dots, n - 1$; and
- (2) if $\xi_i(x) < \xi_{i+1}(x)$ then for every $c \in \mathbb{R}$ the set

$$V_c := \{X \in T_x M \mid t_i(x, X) = c\} \subseteq T_x M$$

has zero Lebesgue measure.

Proof. (1) Let $g := (\text{pf } h)^{-1} h^{-1}$ be the metric associated to h . Since h, \hat{h} are riemannian and the ξ_i are the eigenvalues of the usual endomorphism A , we can decompose $T_x M = \bigoplus_{i=1}^n E_A(\xi_i)|_x$ into the eigenspaces of $A|_x \in \mathfrak{gl}(T_x M)$. In this decomposition, $h_t^*|_x \in \mathcal{L}_x^2 \otimes \mathcal{B}_x^*$ takes the diagonal block form

$$h_t^*|_x = (\text{pf } h|_x)^2 \sum_{i=1}^n \left(\prod_{j \neq i} (\xi_j(x) - t) \right) g_i|_x, \quad (8.56)$$

where $g_i := g|_{E_A(\xi_i)}$ is the restriction of g to the ξ_i -eigendistribution $E_A(\xi_i)$. Let $X \in T_x M$ and write $X = X_1 + \dots + X_n$ according to the eigenspace decomposition of $T_x M$. Since the coefficients of $h_t^*|_x(X, X)$ depend continuously on the $\xi_i(x)$ and X , it suffices to prove (1) when all $\xi_i(x)$ are distinct and $X \neq 0$.

Write $c_i := \xi_i(x)$ for notational convenience. Reordering if necessary, we may suppose that the ξ_i are labelled so that $c_1 \leq \dots \leq c_n$. By (8.56) we obtain

$$\begin{aligned} h_{c_i}^*|_x(X, X) &= (\text{pf } h|_x)^2 \prod_{j \neq i} (c_j - c_i) g_i(X, X) \\ &= (\text{pf } h|_x)^2 \underbrace{(c_1 - c_i) \cdots (c_{i-1} - c_i)}_{\text{sign } (-1)^{i-1}} \underbrace{(c_{i+1} - c_i) \cdots (c_n - c_i)}_{> 0} \underbrace{g(X_i, X_i)}_{\geq 0}. \end{aligned}$$

If $g(X_i, X_i) = 0$ then $c_i = t_i(x, X)$ is a root of $h_t^*|_x$, and likewise for c_{i+1} ; otherwise $h_{c_i}^*|_x$ and $h_{c_{i+1}}^*|_x$ have opposite signs, so that there is a root $t_i(x, X)$ of $h_t^*|_x$ in the interval (c_i, c_{i+1}) . Since $h_t^*(v, v)$ has degree $n - 1$ and there $n - 1$ such roots, we have accounted for all possible roots and (1) follows.

(2) Suppose first that $\xi_i(x) < c < \xi_{i+1}(x)$. Then $h_c^*|_x$ is not identically zero, so that $V_c = \{X \in T_x M \mid h_c^*|_x(X, X) = 0\}$ is a non-zero quadric in $T_x M$. Any such quadric has zero Lebesgue measure.

Now suppose that $c = \xi_i(x)$ or $c = \xi_{i+1}(x)$; without loss of generality we assume the former. Let k_i be the multiplicity of $\xi_i(x)$ as a root of $\pi(t)$. Then every direct summand of (8.56) has a factor $(\xi_i(x) - t)^{k_i-1}$, so that

$$\hat{h}_t^*|_x = (\xi_i(x) - t)^{-k_i+1} h_t^*|_x$$

is a non-zero quadratic form which is polynomial of degree $n - k_i$ in t . Moreover $\hat{h}_t^*|_x$ vanishes on V_c , so that V_c is contained in a non-trivial quadric in $T_x M$. As above, this quadric has zero Lebesgue measure. \square

Theorem 8.45. *Suppose that M is connected and consider a riemannian pencil with linear metrics h, \hat{h} at $\infty, 0$. Let ξ_1, \dots, ξ_n denote the roots of $\pi(t) := \text{pf } h_t$. Then:*

- (1) $\xi_i(x) \leq \xi_{i+1}(y)$ for all $x, y \in M$; and
- (2) if $\xi_i(x) < \xi_{i+1}(x)$ at some $x \in M$, then $\xi_i(y) < \xi_{i+1}(y)$ at almost every $y \in M$.

Proof. (1) Take $x, y \in M$ and join them by a piecewise geodesic $\gamma : [0, 1] \rightarrow M$ with $\gamma(0) = x$ and $\gamma(1) = y$. As in Lemma 8.44, let $X \in T_x M$ and consider the 1-parameter family $(\text{pf } h)^{-2} h_t^*(X, X)$ of integrals of the geodesic flow of $g := (\text{pf } h)^{-1} h^{-1}$ and its ordered roots $t_1(x, X) \leq \dots \leq t_{n-1}(x, X)$. Since $(\text{pf } h)^{-2} h_t^*(X, X)$ is an integral of the geodesic flow of g , so are the $t_i(x, X)$. It follows that $t_i(\gamma(0), \gamma'(0)) = t_i(\gamma(1), \gamma'(1))$, so that by Lemma 8.44(1) we have

$$\xi_i(x) = \xi_i(\gamma(0)) \leq t_i(\gamma(0), \gamma'(0)) = t_i(\gamma(1), \gamma'(1)) \leq \xi_{i+1}(\gamma(1)) = \xi_{i+1}(y)$$

as required.

(2) Suppose that $\xi_i(y) = \xi_{i+1}(y)$ holds for every y in some open subset $U \subset M$. Then item (1) implies that

$$\xi_i(y_1) \leq \xi_{i+1}(y_2) = \xi_i(y_2) \leq \xi_{i+1}(y_1) = \xi_i(y_1)$$

for every $y_1, y_2 \in U$, so that ξ_i equals a constant $c \in \mathbb{R}$ on U .

Now consider all possible geodesics $\gamma_{x,y} : [0, 1] \rightarrow M$ joining x to some $y \in U$. Let $V_c \subseteq T_x M$ denote the set of their initial velocity vectors $\gamma'_{x,y}(0)$. Then $t_i(\gamma(0), \gamma'(0)) = t_i(\gamma(1), \gamma'(1)) = c$ since $\gamma(1) \in U$, so that $V_c \subseteq \{X \in T_x M \mid t_i(x, X) = 0\}$. By Lemma 8.44(2) this set has zero Lebesgue measure, and since $U \subset \exp V_c$ it follows that U also has zero Lebesgue measure. \square

Some algebraic identities

This appendix contains some algebraic identities whose proofs would have disrupted the flow of the main thesis. They are all formal consequences of the Jacobi identity and the brackets provided by Table 7.1, and may be phrased either in terms of elements of the \mathbb{Z}^2 -graded Lie algebra \mathfrak{h} or its associated graded bundle. We assume throughout that a projective parabolic geometry with parameters (r, n) has been fixed, together with (algebraic) Weyl structures for both parabolics.

Lemma A.1. $[[X, \alpha], Y]^b = [[X^b, \alpha^\sharp], Y^b]$.

Proof. Write $\pi := (\det g)^{-1/r(n+1)} \in L$ and $h := \pi^{-1}g^{-1}$, so that $X^b = -[\pi^{-1}, [X, h^{-1}]]$ and $\alpha^\sharp = [\pi, [h, \alpha]]$. Then by the Jacobi identity we have

$$\begin{aligned}
[X^b, \alpha^\sharp] &= [X^b, [\pi, h(\alpha, \cdot)]] \\
&= [\pi X^b, h(\alpha, \cdot)] + [\pi, [X^b, h(\alpha, \cdot)]] \\
&= [h^{-1}(X, \cdot), h(\alpha, \cdot)] - [\pi, [[\pi^{-1}, h^{-1}(X, \cdot)], h(\alpha, \cdot)]] \\
&= [h^{-1}(X, \cdot), h(\alpha, \cdot)] - [\pi, [\pi^{-1}, [h^{-1}(X, \cdot), h(\alpha, \cdot)]]]. \tag{A.1}
\end{aligned}$$

Applying the Jacobi identity to the term $[h^{-1}(X, \cdot), h(\alpha, \cdot)]$ in (A.1) gives

$$\begin{aligned}
[h^{-1}(X, \cdot), h(\alpha, \cdot)] &= [[X, h^{-1}], [h, \alpha]] \\
&= [[[X, h^{-1}], h], \alpha] + [h, [[X, h^{-1}], \alpha]] \\
&= [X, \alpha] + [h, [[X, \alpha], h^{-1}]].
\end{aligned}$$

Substituting the last display into (A.1) then yields

$$\begin{aligned}
[X^b, \alpha^\sharp] &= [X, \alpha] + [h, [[X, \alpha], h^{-1}]] \\
&\quad - [\pi, [\pi^{-1}, [X, \alpha]]] - [\pi, [\pi^{-1}, [h, [[X, \alpha], h^{-1}]]]] \\
&= [X, \alpha] + [h, [[X, \alpha], h^{-1}]] - [\pi, \alpha(X)\pi^{-1}], \tag{A.2}
\end{aligned}$$

where the last term vanishes by virtue of the Jacobi identity and the fact that $\pi^{-1} \in L^*$ has trivial bracket with both $h \in L^* \otimes B$ and $[[X, \alpha], h^{-1}] \in L \otimes B^*$. Taking the Lie

bracket with Y^b , equation (A.2) yields

$$\begin{aligned} [[X^b, \alpha^\sharp], Y^b] &= [[X, \alpha], Y^b] + [[h, [[X, \alpha], h^{-1}], Y^b] \\ &\quad - \alpha(X)[[\pi, \pi^{-1}], Y^b]. \end{aligned} \tag{A.3}$$

Writing $Y^b = \pi^{-1}h^{-1}(Y, \cdot)$ and using the Jacobi identity, the second term on the right-hand side of (A.3) equals

$$\begin{aligned} [[h, [[X, \alpha], h^{-1}], \pi^{-1}h^{-1}(Y, \cdot)] &= [[h, \pi^{-1}h^{-1}(Y, \cdot)], [[X, \alpha], h^{-1}]] \\ &= [\pi^{-1}Y, [[X, \alpha], h^{-1}]] \\ &= [[\pi^{-1}, Y], [[X, \alpha], h^{-1}]]. \end{aligned}$$

Noting that $[[X, \alpha], h^{-1}] \in L \otimes B^*$ brackets trivially with $\pi^{-1} \in L^*$, this equals

$$\begin{aligned} &[[\pi^{-1}, Y], [[X, \alpha], h^{-1}]] \\ &= [\pi^{-1}, [[Y, [X, \alpha]], h^{-1}]] + [\pi^{-1}, [[X, \alpha], [Y, h^{-1}]]] \\ &= -[\pi^{-1}, [[[X, \alpha], Y], h^{-1}]] + [\pi^{-1}, [[X, \alpha], h^{-1}(Y, \cdot)]] \\ &= -[\pi^{-1}, h^{-1}([[X, \alpha], Y], \cdot)] + [\alpha(X)\pi^{-1}, h^{-1}(Y, \cdot)] \\ &\quad + [[X, \alpha], [\pi^{-1}, h^{-1}(Y, \cdot)]] \\ &= [[X, \alpha], Y]^b - \alpha(X)Y^b - [[X, \alpha], Y^b]. \end{aligned} \tag{A.4}$$

On the other hand, the third term on the right-hand side of (A.3) equals

$$-\alpha(X)[[\pi, \pi^{-1}], Y^b] = -\alpha(X)[[\pi, Y^b], \pi^{-1}] = \alpha(X)Y^b.$$

Substituting these expressions into the right-hand side of (A.3), the first and third terms of (A.3) cancel with the third and second terms of (A.4) respectively, leaving only the desired term $[[X, \alpha], Y]^b$. \square

Corollary A.2. $[\text{id} \wedge g]_{X,Y} \in \mathfrak{p}^0$ is skew-adjoint with respect to g .

Proof. Since the Killing form between $\mathfrak{g}/\mathfrak{p}$ and \mathfrak{p}^\perp is simply contraction,

$$\begin{aligned} g([\text{id} \wedge g]_{X,Y}, Z) &= \langle [[Z, Y^b], X] - [[Z, X^b], Y], W^b \rangle \\ &= \langle Z, [[Y^b, X], W^b] - [[X^b, Y], W^b] \rangle \end{aligned}$$

by invariance of $\langle \cdot, \cdot \rangle$. But $[[Y^b, X], W^b] = [[Y, X^b], W]^b$ by Lemma A.1, from which the result easily follows. \square

Lemma A.3. *Suppose that $A \in \mathfrak{p}^0$ is self-adjoint with respect to a non-degenerate element $g \in B^*$, and let $\flat = \sharp^{-1} : \mathfrak{g}/\mathfrak{p} \rightarrow \mathfrak{p}^\perp$ be the musical isomorphisms of g . Then:*

- (1) $\varepsilon^i([[X, e_i^\flat], Y]) = (2 - r)g(X, Y)$; and
- (2) $\varepsilon^i(A[[X, e_i^\flat], Y]) = (2 - r)g(AX, Y)$

for all $X, Y \in \mathfrak{g}/\mathfrak{p}$.

Proof. (1) Let $h := \pi^{-1}g^{-1}$ be the corresponding element of $L^* \otimes B$, where $\pi := (\det g)^{-1/r(n+1)} \in L$. Then we may write $e_i^\flat = h^{-1}(\pi^{-1}e_i, \cdot) = [h^{-1}, [\pi^{-1}, e_i]]$, for which Table 7.1 and successive applications of the Jacobi identity yield

$$\begin{aligned} [[X, e_i^\flat], Y] &= [[X, [h^{-1}, \pi^{-1}e_i]], Y] \\ &= [[h^{-1}(X, \cdot), \pi^{-1}e_i], Y] + [[h^{-1}, [X, \pi^{-1}e_i]], Y] \\ &= -[h^{-1}(X, Y), \pi^{-1}e_i] + [h^{-1}(X, \cdot), [\pi^{-1}e_i, Y]] \\ &\quad - [h^{-1}(Y, \cdot), [e_i, \pi^{-1}X]] \end{aligned}$$

Now $[\pi^{-1}e_i, Y] = [[\pi^{-1}, e_i], Y] = [\pi^{-1}Y, e_i]$ since $\mathfrak{g}/\mathfrak{p}$ is abelian, so we obtain

$$\begin{aligned} &[[X, e_i^\flat], Y] \\ &= -\pi^{-1}h^{-1}(X, Y)e_i + [h^{-1}(X, \cdot), [\pi^{-1}Y, e_i]] - [h^{-1}(Y, \cdot), [e_i, \pi^{-1}X]] \\ &= -g(X, Y)e_i \\ &\quad + [[[h^{-1}(X, \cdot), \pi^{-1}], Y], e_i] - [[[\pi^{-1}, h^{-1}(X, Y)], e_i] - [\pi^{-1}Y, h^{-1}(X, e_i)]] \\ &\quad + [[[h^{-1}(Y, \cdot), \pi^{-1}], X], e_i] - [[[\pi^{-1}, h^{-1}(Y, X)], e_i] - [\pi^{-1}X, h^{-1}(Y, e_i)]] \\ &= -g(X, Y)e_i + [[X^\flat, Y], e_i] - [\pi^{-1}e_i, h^{-1}(X, Y)] + g(X, e_i)Y \\ &\quad + [[Y^\flat, X], e_i] - [\pi^{-1}e_i, h^{-1}(Y, X)] + g(Y, e_i)X \\ &= -g(X, Y)e_i - [[Y, X^\flat], e_i] + g(X, Y)e_i + g(X, e_i)Y \\ &\quad - [[X, Y^\flat], e_i] + g(Y, X)e_i + g(X, e_i)Y \\ &= g(X, Y)e_i + g(X, e_i)Y + g(Y, e_i)X - [[X, Y^\flat], e_i] - [[Y, X^\flat], e_i]. \end{aligned}$$

Using Corollary 7.40, evaluating on ε^i and summing over i now yields

$$\begin{aligned} \varepsilon^i([[X, e_i^\flat], Y]) &= -rng(X, Y) + g(X, Y) + g(Y, X) \\ &\quad - \frac{1}{2}r(n+1)g(Y, X) - \frac{1}{2}r(n+1)g(X, Y) \\ &= (2 - r)g(X, Y) \end{aligned}$$

as claimed.

(2) Using the Gram-Schmidt algorithm, we may suppose that $\{e_i\}_i$ is a g -orthonormal

frame. Then by the Jacobi identity and (1),

$$\begin{aligned}
\varepsilon^i(A[[X, e_i^b], Y]) &= \varepsilon^i([[AX, e_i^b], Y] + [[X, e_i^b], AY] \\
&\quad + [[X, [A, e_i^b]], Y]) \\
&= 2(2-r)g(AX, Y) + \langle \varepsilon^i, [[X, [A, e_i^b]], Y] \rangle. \tag{A.5}
\end{aligned}$$

However g -orthonormality of the e_i implies that $e_i^b = \varepsilon^i$, so this becomes

$$\begin{aligned}
\langle \varepsilon^i, [[X, [A, e_i^b]], Y] \rangle &= \langle e_i^b, [[X, [A, \varepsilon^i]], Y] \rangle \\
&= \langle [A, \varepsilon^i], [[X, [e_i^b]], Y] \rangle \\
&= -\varepsilon^i(A[[X, e_i^b], Y]),
\end{aligned}$$

which is minus the left-hand side of (A.5); rearranging now completes the proof. \square

Lemma A.4. *Let $A \in \mathfrak{p}^0$ be self-adjoint with respect to a non-degenerate element $g \in B^*$. Then $[Ae_i, \varepsilon^i] = \frac{1}{2}((\text{tr } A)\text{id} + rA)$.*

Proof. Let $h := \pi^{-1}g^{-1}$ be the corresponding element of $L^* \otimes B$, where we write $\pi := (\det g)^{1/r(n+1)}$ for brevity. Then $g([[Ae_i, \varepsilon^i], X], Y) = h^{-1}([[Ae_i, \varepsilon^i], X], \pi^{-1}Y)$, for which the Jacobi identity and Table 7.1 yield

$$\begin{aligned}
&h^{-1}([[Ae_i, \varepsilon^i], X], \pi^{-1}Y) \\
&= \langle [[[Ae_i, \varepsilon^i], X], h^{-1}], [\pi^{-1}, Y] \rangle \\
&= -\langle [\pi^{-1}, [[[Ae_i, \varepsilon^i], X], h^{-1}]], Y \rangle \\
&= -\langle [[\pi^{-1}Ae_i, \varepsilon^i], X] + [[Ae_i, \varepsilon^i], \pi^{-1}X], [h^{-1}, Y] \rangle \\
&= \langle [\varepsilon^i(\pi^{-1}Ae_i), X] + [[Ae_i, \pi^{-1}X], \varepsilon^i] + [Ae_i, [\varepsilon^i, \pi^{-1}X]], h^{-1}(Y, \cdot) \rangle \\
&= \langle \varepsilon^i(\pi^{-1}Ae_i)X + \varepsilon^i(\pi^{-1}X)Ae_i, h^{-1}(Y, \cdot) \rangle \\
&\quad + \langle [[Ae_i, \pi^{-1}X], \varepsilon^i], h^{-1}(Y, \cdot) \rangle \\
&= (\text{tr } A)g(X, Y) + g(AX, Y) + \langle [[Ae_i, \pi^{-1}X], \varepsilon^i], h^{-1}(Y, \cdot) \rangle. \tag{A.6}
\end{aligned}$$

We evaluate the final term on the right-hand side of (A.6) separately. We have

$$\begin{aligned}
&\langle [[Ae_i, \pi^{-1}X], \varepsilon^i], h^{-1}(Y, \cdot) \rangle \\
&= \langle [Ae_i, \pi^{-1}X], [[\varepsilon^i, Y], h^{-1}] \rangle \\
&= -\langle [h^{-1}, [Ae_i, \pi^{-1}X]], [Y, \varepsilon^i] \rangle \\
&= \langle [h^{-1}(Ae_i, \cdot), \pi^{-1}X], [Y, \varepsilon^i] \rangle - \langle [Ae_i, X^b], [Y, \varepsilon^i] \rangle \\
&= -\langle [\pi^{-1}, h^{-1}(Ae_i, X)] - [(Ae_i)^b, X], [Y, \varepsilon^i] \rangle - \langle [X^b, [Ae_i, \varepsilon^i]], Y \rangle
\end{aligned}$$

$$\begin{aligned}
&= \langle h^{-1}(Ae_i, X), \varepsilon^i(Y)\pi^{-1} \rangle - \langle [(Ae_i)^b, X], [Y, \varepsilon^i] \rangle - \langle [X^b, [Ae_i, \varepsilon^i]], Y \rangle \\
&= g(AX, Y) - \langle [(Ae_i)^b, X], [Y, \varepsilon^i] \rangle - \langle [X^b, [Ae_i, \varepsilon^i]], Y \rangle. \tag{A.7}
\end{aligned}$$

We have $(Ae_i)^b = -[A, e_i^b]$ since A is g -self-adjoint, so the second term on the right-hand side of (A.7) equals

$$\begin{aligned}
-\langle [(Ae_i)^b, X], [Y, \varepsilon^i] \rangle &= \langle [[A, e_i^b], X], [Y, \varepsilon^i] \rangle \\
&= \langle [A, [e_i^b, X]] - [AX, e_i^b], [Y, \varepsilon^i] \rangle \\
&= -\langle [e_i^b, X], [AY, \varepsilon^i] + [Y, [A, \varepsilon^i]] \rangle - \langle [[AX, e_i^b], Y], \varepsilon^i \rangle \\
&= \varepsilon^i(\langle [X, e_i^b], AY \rangle) - \langle [e_i^b, X], [Y, [A, \varepsilon^i]] \rangle - \varepsilon^i(\langle [[AX, e_i^b], Y] \rangle) \\
&= (2-r)g(X, AY) - \langle [e_i^b, X], [Y, [A, \varepsilon^i]] \rangle - (2-r)g(AX, Y) \\
&= -\varepsilon^i(A\langle [X, e_i^b], Y \rangle) \\
&= -(2-r)g(AX, Y) \tag{A.8}
\end{aligned}$$

by Lemma A.3(2). The third term on the right-hand side of (A.7) equals

$$\begin{aligned}
\langle [X^b, [Ae_i, \varepsilon^i]], Y \rangle &= \langle [X^b, [Ae_i, \varepsilon^i]]^\sharp, Y^b \rangle \\
&= \langle [X, [(Ae_i)^b, \varepsilon^{i\sharp}]], Y^b \rangle
\end{aligned}$$

by Lemma A.3. We may as well assume that $\{e_i\}_i$ is a g -orthonormal frame, so that $e_i^b = \varepsilon^i$. Then the last display becomes

$$\begin{aligned}
\langle [X^b, [Ae_i, \varepsilon^i]], Y \rangle &= -\langle [X, [[A, \varepsilon^i], e_i]], Y^b \rangle \\
&= -\langle [A, [X, [\varepsilon^i, e_i]]] - [AX, [\varepsilon^i, e_i]] - [X, [\varepsilon^i, Ae_i]], Y^b \rangle \\
&= -\langle \frac{1}{2}r(n+1)AX - \frac{1}{2}r(n+1)AX + [[Ae_i, \varepsilon^i], X], Y^b \rangle \\
&= g(\langle [[Ae_i, \varepsilon^i], X], Y \rangle). \tag{A.9}
\end{aligned}$$

Substituting (A.7), (A.8) and (A.9) into (A.6) now yields

$$\begin{aligned}
g(\langle [[Ae_i, \varepsilon^i], X], Y \rangle) &= (\operatorname{tr} A)g(X, Y) + g(AX, Y) + g(AX, Y) \\
&\quad - (2-r)g(AX, Y) - g(\langle [[Ae_i, \varepsilon^i], X], Y \rangle) \\
&= (\operatorname{tr} A)g(X, Y) + rg(AX, Y),
\end{aligned}$$

from which the result follows. \square

APPENDIX B
Tables

For the convenience of the reader, we collect together some representation-theoretic information about the flat models of both the “big” and “small” R-spaces of a projective parabolic geometry.

| Type | $H \cdot \mathfrak{q}$ | $G \cdot \mathfrak{p}$ |
|------------|---|---|
| C_{n+1} |  $\leq \mathfrak{sp}(2n + 2, \mathbb{C})$ |  $\leq \mathfrak{sl}(n + 1, \mathbb{C})$ |
| A_{2n+1} |  $\leq \mathfrak{sl}(2n + 2, \mathbb{C})$ |  $\leq \mathfrak{sl}(n + 1, \mathbb{C}) \oplus \mathfrak{sl}(n + 1, \mathbb{C})$ |
| D_{2n+2} |  $\leq \mathfrak{so}(4n + 4, \mathbb{C})$ |  $\leq \mathfrak{sl}(2n + 2, \mathbb{C})$ |
| E_7 |  $\leq \mathfrak{e}_7(\mathbb{C})$ |  $\leq \mathfrak{e}_6(\mathbb{C})$ |
| BD_{n+4} |  $\leq \mathfrak{so}(n + 4, \mathbb{C})$ |  $\leq \mathfrak{so}(n + 2, \mathbb{C})$ |

Table B.1: The symmetric R-spaces $H \cdot \mathfrak{q}$ and $G \cdot \mathfrak{p}$ associated to the irreducible complex projective parabolic geometry.



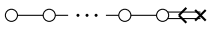
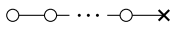
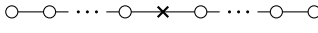
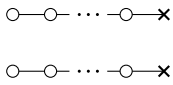
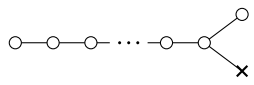
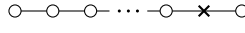
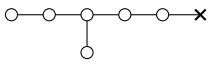
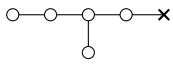
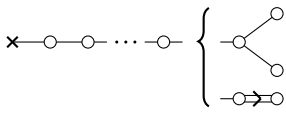
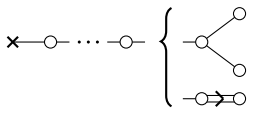

| Type | $\mathfrak{q} \leq \mathfrak{h}$ | $\mathfrak{p} \leq \mathfrak{g}$ | Geometry |
|------------|---|---|--|
| C_{n+1} |  $\leq \mathfrak{sp}(2n+2, \mathbb{R})$ |  $\leq \mathfrak{sl}(n+1, \mathbb{R})$ | Projective geometry |
| A_{2n+1} |  $\leq \mathfrak{sl}(2n+2, \mathbb{R})$ |  $\leq \mathfrak{sl}(n+1, \mathbb{R}) \oplus \mathfrak{sl}(n+1, \mathbb{R})$ | ??? |
| |  $\leq \mathfrak{su}(n+1, n+1)$ |  $\leq \mathfrak{sl}(n+1, \mathbb{C})$ | C-projective geometry |
| D_{2n+2} |  $\leq \mathfrak{so}(4n+4, \mathbb{R})$ |  $\leq \mathfrak{sl}(2n+2, \mathbb{R})$ | Grassmannian of 2-planes |
| |  $\leq \mathfrak{so}^*(4n+4)$ |  $\leq \mathfrak{sl}(2n+2, \mathbb{R})$ | Almost quaternionic geometry |
| E_7 |  $\leq \mathfrak{e}_{7(7)} = E_V$ |  $\leq \mathfrak{e}_{6(6)} = E_I$ | ??? |
| |  $\leq \mathfrak{e}_{7(-25)} = E_{VII}$ |  $\leq \mathfrak{e}_{6(-26)} = E_{IV}$ | Cayley plane |
| BD_{n+4} |  $\leq \mathfrak{so}(p+2, q+2)$ |  $\leq \mathfrak{so}(p+1, q+1)$ | Conformal geometry of signature (p, q) |

Table B.2: Real forms of the irreducible projective parabolic geometries.

| Type | \mathbb{W} | $L^* \otimes B$ | $L^* \otimes \mathfrak{g}/\mathfrak{p}$ | L^* |
|------------|---|--|--|---|
| C_{n+1} | $\begin{array}{c} 2 \ 0 \ \dots \ 0 \ 0 \\ \circ - \circ - \dots - \circ - \circ \\ = S_{\mathbb{C}}^2 \mathbb{C}^{n+1} \end{array}$ | $\begin{array}{c} 2 \ 0 \ \dots \ 0 \ 0 \\ \circ - \circ - \dots - \circ - \times \end{array}$ | $\begin{array}{c} 1 \ 0 \ \dots \ 0 \ -1 \\ \circ - \circ - \dots - \circ - \times \end{array}$ | $\begin{array}{c} 0 \ 0 \ \dots \ 0 \ -2 \\ \circ - \circ - \dots - \circ - \times \end{array}$ |
| A_{2n+1} | $\begin{array}{c} 1 \ 0 \ \dots \ 0 \ 0 \\ \circ - \circ - \dots - \circ - \circ \\ \circ - \circ - \dots - \circ - \circ \\ 1 \ 0 \ \dots \ 0 \ 0 \\ = \mathbb{C}^{n+1} \boxtimes \overline{\mathbb{C}^{n+1}} \end{array}$ | $\begin{array}{c} 1 \ 0 \ \dots \ 0 \ 0 \\ \circ - \circ - \dots - \circ - \times \\ \circ - \circ - \dots - \circ - \times \\ 1 \ 0 \ \dots \ 0 \ 0 \end{array}$ | $\begin{array}{c} 1 \ 0 \ \dots \ 0 \ 0 \\ \circ - \circ - \dots - \circ - \times \\ \oplus \mathbb{C} \mathfrak{c} \\ \circ - \circ - \dots - \circ - \times \\ 0 \ 0 \ \dots \ 0 \ -1 \end{array}$ | $\begin{array}{c} 0 \ 0 \ \dots \ 0 \ -1 \\ \circ - \circ - \dots - \circ - \times \\ \circ - \circ - \dots - \circ - \times \\ 0 \ 0 \ \dots \ 0 \ -1 \end{array}$ |
| D_{2n+2} | $\begin{array}{c} 0 \ 1 \ 0 \ \dots \ 0 \ 0 \ 0 \\ \circ - \circ - \circ - \dots - \circ - \circ - \circ \\ = \wedge_{\mathbb{C}}^2 \mathbb{C}^{2n+2} \end{array}$ | $\begin{array}{c} 0 \ 1 \ 0 \ \dots \ 0 \ 0 \ 0 \\ \circ - \circ - \circ - \dots - \circ - \times - \circ \end{array}$ | $\begin{array}{c} 1 \ 0 \ 0 \ \dots \ 0 \ -1 \ 1 \\ \circ - \circ - \circ - \dots - \circ - \times - \circ \end{array}$ | $\begin{array}{c} 0 \ 0 \ 0 \ \dots \ 0 \ -1 \ 0 \\ \circ - \circ - \circ - \dots - \circ - \times - \circ \end{array}$ |
| E_7 | $\begin{array}{c} 1 \ 0 \ 0 \ 0 \ 0 \\ \circ - \circ - \circ - \circ - \circ \\ \quad \quad \quad \circ \ 0 \\ = \mathbb{C}_{27} \end{array}$ | $\begin{array}{c} 1 \ 0 \ 0 \ 0 \ 0 \\ \circ - \circ - \circ - \circ - \times \\ \quad \quad \quad \circ \ 0 \end{array}$ | $\begin{array}{c} 0 \ 0 \ 0 \ 0 \ -1 \\ \circ - \circ - \circ - \circ - \times \\ \quad \quad \quad \circ \ 1 \end{array}$ | $\begin{array}{c} 0 \ 0 \ 0 \ 0 \ -1 \\ \circ - \circ - \circ - \circ - \times \\ \quad \quad \quad \circ \ 0 \end{array}$ |
| BD_{n+4} | $\begin{array}{c} 1 \ 0 \ \dots \ 0 \\ \circ - \circ - \dots - \circ \\ \left\{ \begin{array}{l} \circ \ 0 \\ \circ \ 0 \\ \circ \ 0 \end{array} \right. \\ = \mathbb{C}^{n+2} \end{array}$ | $\begin{array}{c} 1 \ 0 \ \dots \ 0 \\ \times - \circ - \dots - \circ \\ \left\{ \begin{array}{l} \circ \ 0 \\ \circ \ 0 \\ \circ \ 0 \end{array} \right. \end{array}$ | $\begin{array}{c} -1 \ 1 \ \dots \ 0 \ 0 \\ \times - \circ - \dots - \circ - \circ \\ \left\{ \begin{array}{l} \circ \ 0 \\ \circ \ 0 \\ \circ \ 0 \end{array} \right. \end{array}$ | $\begin{array}{c} -1 \ 0 \ \dots \ 0 \\ \times - \circ - \dots - \circ \\ \left\{ \begin{array}{l} \circ \ 0 \\ \circ \ 0 \\ \circ \ 0 \end{array} \right. \end{array}$ |

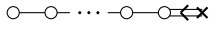
Table B.3: The infinitesimal isotropy representation $\mathbb{W} := \mathfrak{h}/\mathfrak{q}$ and its graded components.

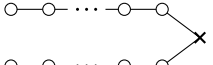
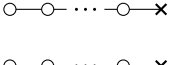
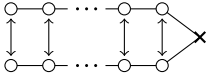
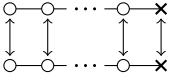
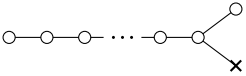
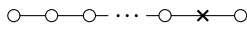
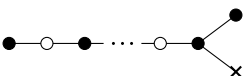
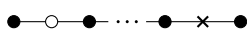
| Type | \mathbb{W}^* | L | $L \otimes \mathfrak{p}^\perp$ | $L \otimes B^*$ |
|------------|---|---|--|--|
| C_{n+1} | $\begin{array}{c} 0 \ 0 \ \dots \ 0 \ 2 \\ \circ - \circ - \dots - \circ - \circ \\ = S_{\mathbb{C}}^2 C^{n+1*} \end{array}$ | $\begin{array}{c} 0 \ 0 \ \dots \ 0 \ 2 \\ \circ - \circ - \dots - \circ - \times \end{array}$ | $\begin{array}{c} 0 \ 0 \ \dots \ 0 \ 1 \ 0 \\ \circ - \circ - \dots - \circ - \circ - \times \end{array}$ | $\begin{array}{c} 0 \ 0 \ \dots \ 0 \ 2 \ -2 \\ \circ - \circ - \dots - \circ - \circ - \times \end{array}$ |
| A_{2n+1} | $\begin{array}{c} 0 \ 0 \ \dots \ 0 \ 1 \\ \circ - \circ - \dots - \circ - \circ \\ \\ \circ - \circ - \dots - \circ - \circ \\ 0 \ 0 \ \dots \ 0 \ 1 \\ = C^{n+1*} \boxtimes \overline{C^{n+1*}} \end{array}$ | $\begin{array}{c} 0 \ 0 \ \dots \ 0 \ 1 \\ \circ - \circ - \dots - \circ - \times \\ \\ \circ - \circ - \dots - \circ - \times \\ 0 \ 0 \ \dots \ 0 \ 1 \end{array}$ | $\begin{array}{c} 0 \ 0 \ \dots \ 0 \ 1 \ -1 \\ \circ - \circ - \dots - \circ - \circ - \times \\ \\ \circ - \circ - \dots - \circ - \circ - \times \\ 0 \ 0 \ \dots \ 0 \ 0 \ -1 \end{array} \oplus \mathbb{C} \mathbf{c}$ | $\begin{array}{c} 0 \ 0 \ \dots \ 0 \ 1 \ -1 \\ \circ - \circ - \dots - \circ - \circ - \times \\ \\ \circ - \circ - \dots - \circ - \circ - \times \\ 0 \ 0 \ \dots \ 0 \ 1 \ -1 \end{array}$ |
| D_{2n+2} | $\begin{array}{c} 0 \ 0 \ 0 \ \dots \ 0 \ 1 \ 0 \\ \circ - \circ - \circ - \dots - \circ - \circ - \circ \\ = \wedge_{\mathbb{C}}^2 C^{2n+2*} \end{array}$ | $\begin{array}{c} 0 \ 0 \ 0 \ \dots \ 0 \ 1 \ 0 \\ \circ - \circ - \circ - \dots - \circ - \times - \circ \end{array}$ | $\begin{array}{c} 0 \ 0 \ \dots \ 0 \ 1 \ -1 \ 1 \\ \circ - \circ - \dots - \circ - \circ - \times - \circ \end{array}$ | $\begin{array}{c} 0 \ 0 \ \dots \ 0 \ 1 \ 0 \ -1 \ 0 \\ \circ - \circ - \dots - \circ - \circ - \circ - \times - \circ \end{array}$ |
| E_7 | $\begin{array}{c} 0 \ 0 \ 0 \ 0 \ 1 \\ \circ - \circ - \circ - \circ - \circ \\ \quad \quad \quad \circ \ 0 \\ = C_{27}^* \end{array}$ | $\begin{array}{c} 0 \ 0 \ 0 \ 0 \ 1 \\ \circ - \circ - \circ - \circ - \times \\ \quad \quad \quad \circ \ 0 \end{array}$ | $\begin{array}{c} 0 \ 0 \ 0 \ 0 \ -1 \\ \circ - \circ - \circ - \circ - \times \\ \quad \quad \quad \circ \ 1 \end{array}$ | $\begin{array}{c} 1 \ 0 \ 0 \ 0 \ -1 \\ \circ - \circ - \circ - \circ - \times \\ \quad \quad \quad \circ \ 0 \end{array}$ |
| BD_{n+4} | $\begin{array}{c} 1 \ 0 \ \dots \ 0 \\ \circ - \circ - \dots - \circ \\ \left\{ \begin{array}{l} \circ \ 0 \\ \circ \ 0 \\ \circ \ 0 \end{array} \right. \\ \left\{ \begin{array}{l} \circ \ 0 \\ \circ \ 0 \end{array} \right. \\ = C^{n+2} \end{array}$ | $\begin{array}{c} 1 \ 0 \ \dots \ 0 \\ \times - \circ - \dots - \circ \\ \left\{ \begin{array}{l} \circ \ 0 \\ \circ \ 0 \\ \circ \ 0 \end{array} \right. \\ \left\{ \begin{array}{l} \circ \ 0 \\ \circ \ 0 \end{array} \right. \end{array}$ | $\begin{array}{c} -1 \ 1 \ 0 \ \dots \ 0 \\ \times - \circ - \circ - \dots - \circ \\ \left\{ \begin{array}{l} \circ \ 0 \\ \circ \ 0 \\ \circ \ 0 \end{array} \right. \\ \left\{ \begin{array}{l} \circ \ 0 \\ \circ \ 0 \end{array} \right. \end{array}$ | $\begin{array}{c} -1 \ 0 \ \dots \ 0 \\ \times - \circ - \dots - \circ \\ \left\{ \begin{array}{l} \circ \ 0 \\ \circ \ 0 \\ \circ \ 0 \end{array} \right. \\ \left\{ \begin{array}{l} \circ \ 0 \\ \circ \ 0 \end{array} \right. \end{array}$ |

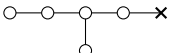
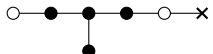
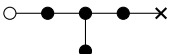
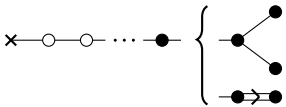
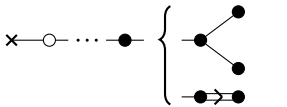
Table B.4: The representation $\mathbb{W}^* \cong \mathfrak{q}^\perp$ and its graded components.

| Type | \mathbb{U}^* | $L^2 \otimes B^*$ | $L^2 \otimes \mathfrak{p}^\perp \wedge B^*$ | $L^2 \otimes B^* \wedge B^*$ |
|------------|--|---|---|--|
| C_{n+1} | $\begin{array}{c} 0 \ 0 \ \dots \ 0 \ 2 \ 0 \\ \circ - \circ - \dots - \circ - \circ - \circ \\ = \odot^2 \wedge^2 \mathbb{C}^{n+1*} \end{array}$ | $\begin{array}{c} 0 \ 0 \ \dots \ 0 \ 2 \ 0 \\ \circ - \circ - \dots - \circ - \circ - \times \end{array}$ | $\begin{array}{c} 0 \ 0 \ \dots \ 0 \ 1 \ 1 \ -1 \\ \circ - \circ - \dots - \circ - \circ - \times \end{array}$ | $\begin{array}{c} 0 \ 0 \ \dots \ 0 \ 2 \ 0 \ -2 \\ \circ - \circ - \dots - \circ - \circ - \times \end{array}$ |
| A_{2n+1} | $\begin{array}{c} 0 \ 0 \ \dots \ 0 \ 1 \ 0 \\ \circ - \circ - \dots - \circ - \circ - \circ \\ \\ 0 \ 0 \ \dots \ 0 \ 1 \ 0 \\ \circ - \circ - \dots - \circ - \circ - \circ \\ = \wedge^2 \mathbb{C}^{n+1*} \boxtimes \overline{\wedge^2 \mathbb{C}^{n+1*}} \end{array}$ | $\begin{array}{c} 0 \ 0 \ \dots \ 0 \ 1 \ 0 \\ \circ - \circ - \dots - \circ - \circ - \times \\ \\ 0 \ 0 \ \dots \ 0 \ 1 \ 0 \\ \circ - \circ - \dots - \circ - \circ - \circ \end{array}$ | $\begin{array}{c} 0 \ 0 \ \dots \ 0 \ 1 \ 0 \ -1 \\ \circ - \circ - \dots - \circ - \circ - \times \\ \\ 0 \ 0 \ \dots \ 0 \ 0 \ 1 \ 0 \\ \circ - \circ - \dots - \circ - \circ - \circ \end{array} \oplus \mathbb{C} \mathbf{c}$ | $\begin{array}{c} 0 \ 0 \ \dots \ 0 \ 1 \ 0 \ -1 \\ \circ - \circ - \dots - \circ - \circ - \times \\ \\ 0 \ 0 \ \dots \ 0 \ 1 \ 0 \ -1 \\ \circ - \circ - \dots - \circ - \circ - \times \end{array}$ |
| D_{2n+2} | $\begin{array}{c} 0 \ \dots \ 0 \ 1 \ 0 \ 0 \ 0 \\ \circ - \dots - \circ - \circ - \circ - \circ - \circ \\ = \wedge^4_{\mathbb{C}} \mathbb{C}^{2n+2*} \end{array}$ | $\begin{array}{c} 0 \ \dots \ 0 \ 1 \ 0 \ 0 \ 0 \\ \circ - \dots - \circ - \circ - \circ - \times - \circ \end{array}$ | $\begin{array}{c} 0 \ \dots \ 0 \ 1 \ 0 \ 0 \ -1 \ 1 \\ \circ - \dots - \circ - \circ - \circ - \times - \circ \end{array}$ | $\begin{array}{c} 0 \ \dots \ 0 \ 1 \ 0 \ 0 \ 0 \ -1 \ 0 \\ \circ - \dots - \circ - \circ - \circ - \circ - \times - \circ \end{array}$ |
| E_7 | $\begin{array}{c} 1 \ 0 \ 0 \ 0 \ 0 \\ \circ - \circ - \circ - \circ - \circ \\ \\ \circ \ 0 \\ = \mathbb{C}_{27} \end{array}$ | $\begin{array}{c} 1 \ 0 \ 0 \ 0 \ 0 \\ \circ - \circ - \circ - \circ - \times \\ \\ \circ \ 0 \end{array}$ | $\begin{array}{c} 0 \ 0 \ 0 \ 0 \ -1 \\ \circ - \circ - \circ - \circ - \times \\ \\ \circ \ 1 \end{array}$ | $\begin{array}{c} 0 \ 0 \ 0 \ 0 \ -1 \\ \circ - \circ - \circ - \circ - \times \\ \\ \circ \ 0 \end{array}$ |
| BD_{n+4} | $\begin{array}{c} 0 \ 0 \ \dots \ 0 \\ \circ - \circ - \dots - \circ \end{array} \left\{ \begin{array}{l} \circ - \circ - \circ \\ \\ \circ \ 0 \\ \circ \ 0 \end{array} \right. \\ = \mathbb{C}$ | $\begin{array}{c} 0 \ 0 \ \dots \ 0 \\ \times - \circ - \dots - \circ \end{array} \left\{ \begin{array}{l} \circ - \circ - \circ \\ \\ \circ \ 0 \\ \circ \ 0 \end{array} \right.$ | - | - |

Table B.5: The representation $\mathbb{U}^* := S^2 \mathbb{W}^* / \odot^2 \mathbb{W}^*$ defining the adjugate, together with its graded components.

Bibliography

- [1] Y. Agaoka and Kaneda E., *Strongly orthogonal subsets in root systems*, Hokkaido Math. J., **31**:107–136, 2002.
- [2] A. A. Albert, *On a certain algebra of quantum mechanics*, Ann. Math., pages 65–73, 1934.
- [3] A. A. Albert, *A structure theory for Jordan algebras*, Ann. Math., pages 546–567, 1947.
- [4] D. V. Alekseevsky and S. Marchiafava, *Quaternionic-like structures on a manifold: Note I. 1- integrability and integrability conditions*, Atti della Accademia Nazionale dei Lincei, **4**(1):43–52, 1993.
- [5] D. V. Alekseevsky and S. Marchiafava, *Quaternionic-like structures on a manifold: Note II. Automorphism groups and their interrelations*, Atti della Accademia Nazionale dei Lincei, **4**(1):53–61, 1993.
- [6] D. V. Alekseevsky and S. Marchiafava, *A report on quaternionic-like structures on a manifold*, in *International Workshop on Differential Geometry and its Applications, Bucharest*, 1993.
- [7] D. V. Alekseevsky and S. Marchiafava, *Gradient quaternionic vector fields and a characterization of the quaternionic projective space*, Preprint ESI, **138**, 1994.
- [8] D. V. Alekseevsky and S. Marchiafava, *Quaternionic Transformations and the First Eigenvalues of Laplacian on a Quaternionic Kähler Manifold*, Preprint ESI, **150**, 1994.
- [9] D. V. Alekseevsky and S. Marchiafava, *Quaternionic structures on a manifold and subordinated structures*, Ann. Mat. Pur. Appl., **171**(1):205–273, 1996.
- [10] V. Apostolov, D. M. J. Calderbank, and P. Gauduchon, *The geometry of weakly self-dual Kähler surfaces*, Invent. Math., **135**(3):279–322, 2003.
- [11] V. Apostolov, D. M. J. Calderbank, and P. Gauduchon, *Hamiltonian 2-forms in Kähler geometry, I. General theory*, J. Diff. Geom., **73**(3):359–412, 2006.
- [12] V. Apostolov, D. M. J. Calderbank, P. Gauduchon, and C. W. Tønnesen-Friedman, *Hamiltonian 2-forms in Kähler geometry, II. Global classification*, J. Diff. Geom., **68**(2):277–345, 2004.
- [13] V. Apostolov, D. M. J. Calderbank, P. Gauduchon, and C. W. Tønnesen-Friedman, *Hamiltonian 2-forms in Kähler geometry, IV. Weakly Bochner-flat Kähler manifolds*, Commun. Anal. Geom., **16**:91–126, 2008.

- [14] V. Apostolov, D. M. J. Calderbank, P. Gauduchon, and C. W. Tønnesen-Friedman, *Hamiltonian 2-forms in Kähler geometry, III. Extremal metrics and stability*, Invent. Math., **173**(3):547–601, 2008.
- [15] S. Armstrong, *Projective holonomy I: principles and properties*, **33**(1):47–69, 2008.
- [16] J. Baez, *The octonions*, B. Amer. Math. Soc., **39**(2):145–205, 2002.
- [17] T. N. Bailey and M. G. Eastwood, *Complex paraconformal manifolds: their differential geometry and twistor theory*, in *Forum Math.*, volume 3, page 99, 1991.
- [18] T. N. Bailey, M. G. Eastwood, and A. R. Gover, *Thomas’s structure bundle for conformal, projective and related structures*, Rocky Mt. J. Math., **24**:1191–1191, 1994.
- [19] R. J. Baston, *Verma modules and differential conformal invariants*, J. Diff. Geom., **32**(3):851–898, 1990.
- [20] R. J. Baston, *Almost Hermitian symmetric manifolds, I. Local twistor theory*, Duke Mathematical Journal, **63**(1):81–112, 1991.
- [21] R. J. Baston, *Almost Hermitian symmetric manifolds, II. Differential invariants*, Duke Math. J., **63**(1):113–138, 1991.
- [22] R. J. Baston and M. G. Eastwood, *The Penrose transform: its interaction with representation theory*, Clarendon Press, 1989.
- [23] E. Beltrami, *Risoluzione del problema: riportare i punti di una superficie sopra un piano in modo che le linee geodetiche vengano rappresentate da linee rette*, Ann. Math., **7**(1):185–204, 1865.
- [24] M. Berger, *Sur les groupes d’holonomie homogène des variétés riemanniennes*, Bulletin de la Société Mathématique de France, **83**:279–330, 1955.
- [25] M. Berger, *Sur les groupes d’holonomie homogènes de variétés à connexion affine et des varités riemanniennes*, B. Soc. Math. Fr., **83**:279–330, 1955.
- [26] W. Bertram, *Generalized projective geometries: general theory and equivalence with Jordan structures*, Adv. Geom., **2**(4):329–369, 2002.
- [27] W. Bertram. Jordan structures and non-associative geometry. in *Developments and Trends in Infinite-Dimensional Lie Theory*, pages 221–241. Springer, 2011.
- [28] W. Bertram, *Jordan- and Lie geometries*, Arch. Math., **49**(5):275–293, 2013.
- [29] A. L. Besse, *Einstein manifolds*, Springer, 1987.
- [30] A. Bolsinov and V. Matveev, *Splitting and gluing lemmas for geodesically equivalent pseudo-Riemannian metrics*, Trans. Amer. Math. Soc., **363**(8):4081–4107, 2011.
- [31] A. Bolsinov and V. Matveev, *Local normal forms for geodesically equivalent pseudo-Riemannian metrics*, Trans. Amer. Math. Soc., **367**:6719–6749, 2014.
- [32] A. Bolsinov and D. Tsonev, *On a new class of holonomy groups in pseudo-Riemannian geometry*, J. Diff. Geom., **97**(3):377–394, 2014.

- [33] A. V. Bolsinov, V. Kiosak, and V. S. Matveev, *A Fubini theorem for pseudo-Riemannian geodesically equivalent metrics*, J. London Math., **80**(2):341–356, 2009.
- [34] A. V. Bolsinov and V. S. Matveev, *Geometrical interpretation of Benenti systems*, J. Geom. Phys., **44**(4):489–506, 2003.
- [35] A. V. Bolsinov, V. S. Matveev, and G. Pucacco, *Normal forms for pseudo-Riemannian 2-dimensional metrics whose geodesic flows admit integrals quadratic in momenta*, J. Geom. Phys., **59**(7):1048–1062, 2009.
- [36] A. V. Bolsinov, V. S. Matveev, and S. Rosemann, *Local normal forms for c -projectively equivalent metrics and proof of the Yano–Obata conjecture in arbitrary signature. proof of the projective lichnerowicz conjecture for lorentzian metrics*, arXiv:1510.00275v1, 2015.
- [37] A. Borowka, *Twistor constructions of quaternionic manifolds and asymptotically hyperbolic Einstein–Weyl spaces*, D. Phil. thesis, University of Bath, 2012.
- [38] N. Bourbaki, *Eléments de mathématique: Groupes et algèbres de Lie: Chapitre 8, Algèbres de Lie semi-simples déployées*, Hermann, 1975.
- [39] T. Branson, A. Čap, M. Eastwood, and A. R. Gover, *Prolongations of geometric overdetermined systems*, Int. J. Math., **17**(6):641–664, 2006.
- [40] H. W. Brinkmann, *Riemann spaces conformal to Einstein spaces*, Math. Ann, **91**(3):269–278, 1924.
- [41] H. W. Brinkmann, *Einstein spaces which are mapped conformally on each other*, Math. Ann., **94**(1):119–145, 1925.
- [42] F. Burstall and J. Rawnsley, *Affine connections with $W = 0$* , arXiv:math/0702032v2, 2007.
- [43] F. E. Burstall and D. M. J. Calderbank, *Conformal submanifold geometry I-III*, arXiv:1006.5700v1, 2010.
- [44] F. E. Burstall, N. M. Donaldson, F. Pedit, and U. Pinkall, *Isothermic submanifolds of symmetric R -spaces*, J. reine angew. Math., **2011**(660):191–243, 2011.
- [45] F. E. Burstall and J. H. Rawnsley, *Twistor theory for Riemannian symmetric spaces: with applications to harmonic maps of Riemann surfaces*, volume 1424 of Lect. Notes in Math., Springer, 1990.
- [46] D. M. J. Calderbank, *Möbius structures and two dimensional Einstein-Weyl geometry*, J. reine angew Math., pages 37–54, 1998.
- [47] D. M. J. Calderbank, *Hamiltonian 2-vectors in H -projective geometry*, unpublished note, 2012.
- [48] D. M. J. Calderbank, L. David, and P. Gauduchon, *The Guillemin formula and Kähler metrics on toric symplectic manifolds*, J. Symp. Geom., **1**(4):767–784, 2002.
- [49] D. M. J. Calderbank and T. Diemer, *Differential invariants and curved Bernstein-Gelfand- Gelfand sequences*, J. reine angew. Math., **537**:67–103, 2001.

- [50] D. M. J. Calderbank, T. Diemer, and V. Souček, *Ricci-corrected derivatives and invariant differential operators*, *Diff. Geom. Appl.*, **23**(2):149–175, 2005.
- [51] D. M. J. Calderbank, M. G. Eastwood, V. S. Matveev, and K. Neusser, *C-projective geometry*, [arXiv:1512.04516v1](https://arxiv.org/abs/1512.04516v1), 2015.
- [52] D. M. J. Calderbank, V. S. Matveev, and S. Rosemann, *Curvature and the c-projective mobility of Kaehler metrics with hamiltonian 2-forms*, [arXiv:1501.04841v1](https://arxiv.org/abs/1501.04841v1), 2015.
- [53] D. M. J. Calderbank and P. Noppakaew, *Parabolic subalgebras, parabolic buildings and parabolic projection*, in preparation, 2015.
- [54] A. Čap, A. R. G., and M. Hammer, *Projective BGG equations, algebraic sets, and compactifications of Einstein geometries*, *J. London Math. Soc.*, page jds002, 2012.
- [55] A. Čap and A. Gover, *Tractor calculi for parabolic geometries*, *Trans. Amer. Math. Soc.*, **354**(4):1511–1548, 2002.
- [56] A. Čap and A. R. Gover, *Tractor bundles for irreducible parabolic geometries*, in *Global Analysis and Harmonic Analysis (Marseille-Luminy, 1999)*, volume 4 of *Sémin. Congr.*, pages 129–154, 2000.
- [57] A. Čap, A. R. Gover, and H. R. Macbeth, *Einstein metrics in projective geometry*, **168**(1):235–244, 2014.
- [58] A. Čap and H. Schichl, *Parabolic geometries and canonical Cartan connections*, *Hokkaido Math. J.*, **29**:453–505, 2000.
- [59] A. Čap and J. Slovák, *Weyl structures for parabolic geometries*, *Math. Scand.*, **93**(1):53–90, 2003.
- [60] A. Čap and J. Slovák, *Parabolic Geometries: Background and general theory*, American Mathematical Society, 2009.
- [61] A. Čap, J. Slovák, and V. Souček, *Bernstein-Gelfand-Gelfand sequences*, *Ann. Math.*, **154**(1):97–113, 2001.
- [62] A. Čap and V. Soucek, *Curved Casimir operators and the BGG machinery*, [arXiv:0708.3180v2](https://arxiv.org/abs/0708.3180v2), 2007.
- [63] É. Cartan, *Sur les variétés à connexion affine et la théorie de la relativité généralisée (première partie)*, *Ann. Sci. Ecole Norm. S.*, **40**:325–412, 1923.
- [64] É. Cartan, *Sur les variétés à connexion projective*, *B. Soc. Math. Fr.*, **52**:205–241, 1924.
- [65] É. Cartan, *Espaces à connexion affine, projective et conforme*, *Acta Math.*, **48**:1–42, 1926.
- [66] É. Cartan, *Sur une classe remarquable d’espaces de Riemann. I*, *B. Soc. Math. Fr.*, **54**:214–264, 1926.
- [67] É. Cartan, *Sur une classe remarquable d’espaces de Riemann. II*, *B. Soc. Math. Fr.*, **55**:114–134, 1927.

- [68] C.-H. Chu, *Jordan triples and Riemannian symmetric spaces*, Adv. Math., **219**(6):2029–2057, 2008.
- [69] A. C. Da Silva, *Lectures on symplectic geometry*, volume 1764, Springer Science & Business Media, 2001.
- [70] M. Demazure, *A very simple proof of Bott’s theorem*, **33**(3):271–272, 1976.
- [71] U. Dini, *Sopra un problema che si presenta nella teoria generale delle rappresentazioni geografiche di una superficie su di un’altra*, Ann. Mat. Pur. Appl., **3**(1):269–293, 1869.
- [72] J. Dixmier, *Polarisation dans les algèbres de Lie. II*, B. Soc. Math. Fr., **104**:145–164, 1976.
- [73] V. V. Domashev and Mikeš, *On the theory of holomorphically projective mappings of Kaehlerian spaces*, Math. Zametki, **23**:297–303, 1978.
- [74] M. Eastwood, *The Cartan product*, B. Belg. Math. Soc.-Sim., **11**(5):641–651, 2005.
- [75] M. Eastwood, *Notes on projective differential geometry*, Symmetries and overdetermined systems of partial differential equations, pages 41–60, 2008.
- [76] M. Eastwood, *Canonical fields in projective geometry*, unpublished note, 2014.
- [77] M. Eastwood and V. Matveev, *Metric connections in projective differential geometry*, Symmetries and overdetermined systems of partial differential equations, pages 339–350, 2008.
- [78] M.G. Eastwood and A.R. Gover, *The BGG Complex on Projective Space*, SIGMA, **7**:060, 2011.
- [79] L. P. Eisenhart, *Riemannian geometry*, Princeton University Press, 2nd edition, 1949.
- [80] J. Faraut, S. Kaneyuki, A. Korányi, Q. Lu, and G. Roos, *Analysis and geometry on complex homogeneous domains*, volume 185, Springer Science & Business Media, 2012.
- [81] H. Freudenthal, *Beziehungen der e_7 und e_8 zur oktavenebene. i–xi*, in *Indagationes Mathematicae (Proceedings)*, volume 58, pages 277–285, 1955.
- [82] S. Fujimura, *Q-connections and their changes on an almost quaternion manifold*, Hokkaido Math. J., **5**:239–248, 1976.
- [83] W. Fulton, *Introduction to toric varieties*, Princeton University Press, 1993.
- [84] W. Fulton and J. Harris, *Representation theory: a first course*, Springer, 1991.
- [85] A. R. Gover and H. R. Macbeth, *Detecting Einstein geodesics: Einstein metrics in projective and conformal geometry*, Diff. Geom. Appl., **33**:44–69, 2014.
- [86] A. R. Gover and V. S. Matveev, *Projectively related metrics, Weyl nullity, and metric projectively invariant equations*, arXiv:1507.02375v1, 2015.
- [87] A. R. Gover and J. Šilhan, *The conformal Killing equation on forms: prolongations and applications*, Diff. Geom. Appl., **26**(3):244–266, 2008.
- [88] A. R. Gover and J. Slovák, *Invariant local twistor calculus for quaternionic structures and related geometries*, J. Geom. Phys., **32**(1):14–56, 1999.

- [89] A. Gray, *Minimal varieties and almost hermitian submanifolds*, Michigan Math. J., **12**:273–287, 1965.
- [90] A. Gray, *A note on manifolds whose holonomy group is a subgroup of $\mathrm{Sp}(n) \cdot \mathrm{Sp}(1)$* , Mich. Math. J., **16**(2):125–128, 1969.
- [91] V. Guillemin, *Kaehler structures on toric varieties*, J. Diff. Geom., **40**(2):285–309, 1994.
- [92] V. Guillemin, *Moment maps and combinatorial invariants of Hamiltonian T^n -spaces*, Springer, 1994.
- [93] M. Hammerl, *Invariant prolongation of BGG-operators in conformal geometry*, Arch. Math. (Brno), **44**(5):367–384, 2008.
- [94] M. Hammerl, *Natural prolongations of BGG-operators*, D. Phil. thesis, Universität Wien, 2009.
- [95] M. Hammerl, P. Somberg, V. Souček, and J. Šilhan, *On a new normalization for tractor covariant derivatives*, arXiv:1003.6090v1, 2010.
- [96] M. Hammerl, P. Somberg, V. Souček, and J. Šilhan, *Invariant prolongation of overdetermined PDEs in projective, conformal, and Grassmannian geometry*, Ann. Glob. Anal. Geom., **42**(1):121–145, 2012.
- [97] J. Harris, *Algebraic geometry: a first course*, volume 133, Springer Science & Business Media, 2013.
- [98] I. Hinterleitner, J. Mikeš, and A. Vanžurová, *Geodesic mappings and some generalizations*, Palacký University, 2009.
- [99] U. Hirzebruch, *Über Jordan-Algebren und kompakte Riemannsche symmetrische Räume vom Rang 1*, Math. Z., **90**(5):339–354, 1965.
- [100] N. Hitchin, *Hyperkähler manifolds*, Astérisque, **34**(206):137–166, 1992.
- [101] N. J. Hitchin, A. Karlhede, U. Lindström, and M. Roček, *Hyperkähler metrics and supersymmetry*, Comm. Math. Phys., **108**(4):535–589, 1987.
- [102] J. Hrdina, *Almost complex projective structures and their morphisms*, Arch. Math. Brno, **45**(4):255–264, 2009.
- [103] J. E. Humphreys, *Introduction to Lie algebras and representation theory*, volume 9 of Graduate Texts in Mathematics, Springer Science & Business Media, 1972.
- [104] J. E. Humphreys, *Representations of semisimple Lie algebras in the BGG category \mathcal{O}* , volume 94 of Graduate Studies in Mathematics, American Mathematical Society, 2008.
- [105] S. Ishihara and S. Tachibana, *On infinitesimal holomorphically projective transformations in Kählerian manifolds*, Tohoku Math. J., **12**(1):77–101, 1960.
- [106] P. Jordan, *Über verallgemeinerungsmöglichkeiten des formalismus der quantenmechanik*, Nachr. Akad. Wiss. Göttingen. Math. Phys. Kl. I, **41**:209–217, 1933.
- [107] P. Jordan, J. von Neumann, and E. P. Wigner, *On an Algebraic Generalization of the Quantum Mechanical Formalism*, Ann. Math., **35**(1):29–64, 1934.

- [108] D. Joyce, *The hypercomplex quotient and the quaternionic quotient*, *Mathematische Annalen*, **290**(1):323–340, 1991.
- [109] D. Joyce, *Riemannian holonomy groups and calibrated geometry*, Springer, 2003.
- [110] B. Keller, *Introduction to A-infinity algebras and modules*, [arXiv:math/9910179v2](https://arxiv.org/abs/math/9910179v2), 1999.
- [111] V. Kiosak and V. S. Matveev, *Proof of the projective Lichnerowicz conjecture for pseudo-Riemannian metrics with degree of mobility greater than two*, *Comm. Math. Phys.*, **297**(2):401–426, 2010.
- [112] K. Kiyohara and P. Topalov, *On Liouville integrability of h-projectively equivalent Kähler metrics*, *Proc. Amer. Math. Soc.*, **139**(1):231–242, 2011.
- [113] S. Kobayashi and K. Nomizu, *Foundations of differential geometry*, volume 1, Wiley Classics, 1996.
- [114] S. Kobayashi and K. Nomizu, *Foundations of differential geometry*, volume 2, Wiley Classics, 1996.
- [115] T. Kobayashi and G. Savin, *Global uniqueness of small representations*, *Math. Z.*, pages 1–25, 2015.
- [116] M. Koecher, *Imbedding of Jordan algebras into Lie algebras. I*, *Amer. J. Math.*, pages 787–816, 1967.
- [117] M. Koecher, *Imbedding of Jordan algebras into Lie algebras. II*, *Amer. J. Math.*, pages 476–510, 1968.
- [118] M. Koecher, *Jordan algebras and differential geometry*, in *Proc. ICM (Nice 1970)*, pages 279–283, 1970.
- [119] B. Kostant, *Lie algebra cohomology and the generalized Borel–Weil theorem*, *Ann. Math.*, **74**(2):329–387, 1961.
- [120] V. Y. Kraines, *Topology of quaternionic manifolds*, *Trans. Amer. Math. Soc.*, **122**(2):357–367, 1966.
- [121] R. S. Kulkarni, *On the principle of uniformization*, *J. Diff. Geom.*, **13**(1):109–138, 1978.
- [122] G. Lancaster and J. Towber, *Representation-functors and flag-algebras for the classical groups*, *J. Algebra*, **59**(1):16–38, 1979.
- [123] S. C. Lau and N. C. Leung, *Conformal geometry and special holonomy*, [arXiv:1009.5040v1](https://arxiv.org/abs/1009.5040v1), 2010.
- [124] J. M. Lee, *Riemannian manifolds: an introduction to curvature*, Springer, 1997.
- [125] J. M. Lee, *Smooth manifolds*, Springer New York, 2003.
- [126] N. C. Leung, *Riemannian geometry over different normed division algebras*, *J. Diff. Geom.*, **61**(2):289–333, 2002.
- [127] T. Levi-Civita, *On the transformations of the dynamical equations*, *Regul. Chaotic Dyn.*, **14**(4-5):580–614, 2009. Translated by S. Benenti.

- [128] W. Lichtenstein, *A system of quadrics describing the orbit of the highest weight vector*, Proc. Amer. Math. Soc., **84**(4):605–608, 1982.
- [129] R. Liouville, *Sur les invariants de certaines équations différentielles et sur leurs applications*, J. Éc. polytech. Math., **59**:7–76, 1889.
- [130] O. Loos, *Jordan triple systems, R-spaces, and bounded symmetric domains*, B. Am. Math. Soc., **77**(4):558–561, 1971.
- [131] Y. Maeda, *On a characterization of quaternion projective space by differential equations*, Kadai Math. Sere. Rep, **27**, 1976.
- [132] S. Marchiafava and G. Romani, *Sui fibrati con struttura quaternionale generalizzata*, Ann. Mat. Pur. Appl., **107**(1):131–157, 1975.
- [133] W. S. Massey, *Non-existence of almost-complex structures on quaternionic projective spaces*, Pacific J. Math., **12**:1379–1384, 1962.
- [134] V. S. Matveev, *The eigenvalues of the Sinyukov mapping for geodesically equivalent metrics are globally ordered*, Math. Notes+, **77**(3-4):380–390, 2005.
- [135] V. S. Matveev, *Gallot–Tanno theorem for pseudo-Riemannian metrics and a proof that decomposable cones over closed complete pseudo-Riemannian manifolds do not exist*, Diff. Geom. Appl., **28**(2):236–240, 2010.
- [136] V. S. Matveev, *Geodesically equivalent metrics in general relativity*, J. Geom. Phys., **62**(3):675–691, 2012.
- [137] V. S. Matveev and P. Mounoud, *Gallot–Tanno theorem for closed incomplete pseudo-Riemannian manifolds and applications*, Ann. Glob. Anal. Geom., **38**(3):259–271, 2010.
- [138] V. S. Matveev and S. Rosemann, *Proof of the Yano–Obata conjecture for h -projective transformations*, J. Diff. Geom., **92**(1):221–261, 2012.
- [139] V. S. Matveev and S. Rosemann, *Conification construction for Kaehler manifolds and its application in c -projective geometry*, arXiv:1307.4987v1, 2013.
- [140] V. S. Matveev and P. J. Topalov, *Trajectory equivalence and corresponding integrals*, Regul. Chaotic Dyn., **3**(2):30–45, 1998.
- [141] K. McCrimmon, *Jordan algebras and their applications*, B. Am. Math. Soc., **84**(4):612–627, 1978.
- [142] K. McCrimmon, *A taste of Jordan algebras*, Springer Science & Business Media, 2006.
- [143] K. Meyberg, *Jordan-Tripelsysteme und die Koecher-Konstruktion von Lie-Algebren*, Math. Z., **115**(1):58–78, 1970.
- [144] J. P. Michel, P. Somberg, and J. Šilhan, *Prolongation of symmetric Killing tensors and commuting symmetries of the Laplace operator*, arXiv:1403.7226v1, 2014.
- [145] J. Mikeš, *Geodesic mappings of affine-connected and riemannian spaces*, J. Math. Sci., **78**(3):311–333, 1996.

- [146] J. Mikeš, *Holomorphically projective mappings and their generalizations*, J. Math. Sci., **89**(3):1334–1353, 1998.
- [147] A. Moroianu and U. Semmelmann, *Killing forms on quaternion-Kähler manifolds*, Ann. Glob. Anal. Geom., **28**(4):319–335, 2005.
- [148] R. Moufang, *Alternativkörper und der satz vom vollständigen vierseit (d 9)*, in *Abhandlungen aus dem Mathematischen Seminar der Universität Hamburg*, volume 9, pages 207–222, 1933.
- [149] K. Neusser, *Weighted Jet Bundles and Differential Operators for Parabolic Geometries*, D. Phil. thesis, Universität Wien, 2010.
- [150] A. Newlander and L. Nirenberg, *Complex analytic coordinates in almost complex manifolds*, Ann. Math., pages 391–404, 1957.
- [151] P. Noppakaew, *Parabolic Projection and Generalized Cox Configurations*, D. Phil. thesis, University of Bath, 2014.
- [152] H. Nuchi, *Hopf fibrations are characterized by being fiberwise homogeneous*, arXiv:1407.4549v2, 2014.
- [153] T. Ōtsuki and Y. Tashiro, *On curves in Kaehlerian spaces*, Math. J. Okayama Univ., **4**(1):57–78, 1954.
- [154] P. Painlevé, *Sur les intégrales quadratiques des équations de la dynamique*, Compt. Rend. Math., **124**:221–224, 1897.
- [155] H. Pedersen, *Hypercomplex geometry*, in *Second Meeting on Quaternionic Structures in Mathematics and Physics*, pages 313–320, 2000.
- [156] H. Pedersen and Y. S. Poon, *Hamiltonian constructions of Kähler-Einstein metrics and Kähler metrics of constant scalar curvature*, Comm. Math. Phys., **136**(2):309–326, 1991.
- [157] R. Penrose and W. Rindler, *Spinors and space-time: Volume 1, Two-spinor calculus and relativistic fields*, volume 1, Cambridge University Press, 1987.
- [158] C. Procesi, *Lie groups: an approach through invariants and representations*, Springer Science & Business Media, 2007.
- [159] R. Richardson, G. Röhrle, and R. Steinberg, *Parabolic subgroups with abelian unipotent radical*, Invent. Math., **110**(1):649–671, 1992.
- [160] B. Rosenfeld, *Geometry of Lie groups*, volume 393, Springer Science, 1997.
- [161] S. Salamon, *Quaternionic Kähler manifolds*, Invent. Math., **67**(1):143–171, 1982.
- [162] S. M. Salamon, *Differential geometry of quaternionic manifolds*, in *Annales scientifiques de l’Ecole normale supérieure*, volume 19, pages 31–55, 1986.
- [163] S. M. Salamon, *Riemannian geometry and holonomy groups*, volume 201 of Pitman Research, 1989.
- [164] S. M. Salamon, *Quaternion-Kähler geometry*, in *Surveys in differential geometry VI: essays on Einstein manifolds*, pages 83–121, International Press, 1999.

- [165] R. W. Sharpe, *Differential geometry: Cartan's generalization of Klein's Erlangen program*, volume 166 of Graduate Texts in Mathematics, Springer Science & Business Media, 1997.
- [166] N. S. Sinjukov, *Geodesic mappings of Riemannian spaces*, 1979.
- [167] A. Swann, *HyperKähler and quaternionic Kähler geometry*, Math. Ann., **289**(1):421–450, 1991.
- [168] A. Swann, *HyperKähler and quaternionic Kähler geometry*, D. Phil. thesis, Oxford University, 1991.
- [169] A. Swann, *Twisting Hermitian and hypercomplex geometries*, Duke Math. J., **155**(2):403–431, 2010.
- [170] M. Takeuchi, *Cell decompositions and morse equalities on certain symmetric spaces*, J. Fac. Sci. Univ. Tokyo, **12**:81–192, 1965.
- [171] S. Tanno, *Some differential equations on Riemannian manifolds*, J. Math. Soc. Japan, **30**(3):509–531, 1978.
- [172] Y. Tashiro, *On holomorphically projective correspondences in an almost complex space*, Math. J. Okayama Univ, **6**(2):147–152, 1957.
- [173] T. Y. Thomas, *Announcement of a projective theory of affinely connected manifolds*, P. Natl. Acad. Sci. USA, **11**(10):588, 1925.
- [174] J. Tits, *Une classe d'algèbres de Lie en relation avec les algèbres de Jordan*, in *Proceedings of the Koninklijke Nederlandse Academie van Wetenschappen. Series A. Mathematical sciences*, volume 65, pages 530–535, 1962.
- [175] P. Topalov, *Hierarchy of integrable geodesic flows*, Publ. Mat., **44**(1):257–276, 2000.
- [176] P. Topalov, *Geodesic hierarchies and involutivity*, J. Math. Phys., **42**(8):3898–3914, 2001.
- [177] P. Topalov, *Geodesic compatibility and integrability of geodesic flows*, J. Math. Phys., **44**(2):913–929, 2003.
- [178] P. Topalov and V. S. Matveev, *Geodesic equivalence via integrability*, Geometriae Dedicata, **96**(1):91–115, 2003.
- [179] C. Voisin, *Hodge theory and complex algebraic geometry, I*, volume 76 of Cambridge Studies in Advanced Mathematics, Cambridge University Press, 2002.
- [180] S. H. Weintrauß, *Jordan canonical form: theory and practice*, Synthesis Lectures on Mathematics and Statistics, **2**(1):1–108, 2009.
- [181] H. Weyl, *Zur Infinitesimalgeometrie: Einordnung der projektiven und der konformen Auffassung*, NGWG philos.-hist. Kl., 1921.
- [182] D. Widdows, *Quaternion algebraic geometry*, D. Phil. thesis, University of Oxford, 2000.
- [183] J. A. Wolf, *Fine structure of Hermitian symmetric spaces*, in *Symmetric Spaces, Short Courses Presented at Washington University*, pages 271–357, 1972.

- [184] K. Yamaguchi, *Differential systems associated with simple graded Lie algebras*, Adv. Stud. Pure Math., **22**:413–494, 1993.

Index of notation

| | | | |
|--------------------------|--|----------------------------|---|
| <u>Ad</u> | Adjoint action of G on G | $H_k(\mathfrak{g}; V)$ | k th V -valued Lie homology of \mathfrak{g} |
| Ad | Adjoint action of G on \mathfrak{g} | $H^k(\mathfrak{g}; V)$ | k th V -valued Lie algebra cohomology of \mathfrak{g} |
| ad | Adjoint action of \mathfrak{g} on \mathfrak{g} | | |
| $A(g, \hat{g})$ | Solution of main equation | \mathbf{i}, \mathbf{i}_a | Imaginary units in \mathbb{C} or \mathbb{H} |
| B | Inverse metric repn. of a PPG | J, J_a | Almost complex structures |
| $\mathbb{C}\mathbb{P}^n$ | Complex projective space | $\mathcal{J}^k(E)$ | k th jet bundle of E |
| $\mathbb{C}E$ | Complexification of E | L | Bundle of scales of a PPG |
| C^∇ | Cotton–York tensor of ∇ | \mathcal{L}_X | Lie derivative wrt. X |
| \mathbb{C}_{27} | 27-dimensional repn. of $\mathfrak{e}_6(\mathbb{C})$ | n | Projective dimension of a PPG |
| \mathbb{C}_{56} | 56-dimensional repn. of $\mathfrak{e}_7(\mathbb{C})$ | \mathbb{N} | Natural numbers $\mathbb{Z}_{\geq 0}$ |
| d | Exterior derivative | N^J | Nijenhuis torsion of J |
| d^∇ | Exterior covariant derivative induced by ∇ | \mathbb{O} | Octonion algebra |
| \mathcal{D}^∇ | First BGG operator of ∇ | $\mathbb{O}\mathbb{P}^2$ | Octonionic projective plane |
| ∂ | Lie homology boundary map | $\mathbb{P}(V)$ | Projectivisation of V |
| ∂^* | Lie cohomology differential | pf | Pfaffian |
| δ_γ | Change in Weyl structure wrt. γ | \mathcal{Q} | Almost quaternionic structure |
| div_g | Divergence wrt. g | r | Scalar dimension of a PPG |
| $\{e_i\}_i$ | Local frame of M | $\mathbb{R}\mathbb{P}^n$ | Real projective space |
| $\{\varepsilon^i\}_i$ | Coframe dual to $\{e_i\}_i$ | r^∇ | Normalised Ricci curvature of ∇ |
| exp | Exponential map | R^∇ | Curvature of ∇ |
| F^P | Cartan P -frame bundle | rk | Rank |
| $G \cdot \mathfrak{p}$ | Flat model of a PPG | Ric^∇ | Ricci curvature of ∇ |
| $\mathfrak{gl}(V)$ | Endomorphisms of V | \mathbb{S}^n | Unit sphere in \mathbb{R}^{n+1} |
| grad_g | Gradient wrt. g | $\$, \$^\pm$ | (Half)-spin repn. of $\mathfrak{so}(n, \mathbb{C})$ |
| $\text{Gr}_k(V)$ | Grassmannian of k -planes in V | $\text{Scal}(g)$ | Scalar curvature of g |
| \mathbb{H} | Quaternion algebra | \mathbb{T} | Standard repn. of a PPG |
| $\mathbb{H}\mathbb{P}^n$ | Quaternionic projective space | T^∇ | Torsion of ∇ |
| $H \cdot \mathfrak{q}$ | Big R-space of a PPG | tr | Trace |

| | | | |
|------------------------------------|--|------------------------------|---|
| U^* | Defining quadric of a PPG | X, Y, Z | Vector fields |
| $V_{\mathbb{R}}$ | Real repn. underlying V | α, β, γ | Differential forms |
| $V_{\mathbb{C}}$ | Complexification of V | g | (Pseudo-)riemannian metric |
| vol_g | Volume form of g | G, H | Semisimple Lie groups |
| \mathbb{W} | Isotropy representation of $\mathfrak{h}/\mathfrak{q}$ | $\mathfrak{g}, \mathfrak{h}$ | Semisimple Lie algebras |
| W^{∇} | Weyl curvature of ∇ | P, Q | Parabolic subgroups |
| ω | Kähler form | $\mathfrak{p}, \mathfrak{q}$ | Parabolic subalgebras |
| Ω^Q | (Fundamental) Kraines form | \mathfrak{p}^{\perp} | Killing polar of \mathfrak{p} |
| $\Omega^k(M; E)$ | Sections of $\wedge^k T^*M \otimes E$ over M | \mathfrak{p}^0 | Reductive Levi factor $\mathfrak{p}/\mathfrak{p}^{\perp}$ of \mathfrak{p} |
| $\mathfrak{z}(\mathfrak{g}), Z(G)$ | Centre of \mathfrak{g}, G | $\hat{\mathfrak{p}}$ | Parabolic opposite to \mathfrak{p} |
| | | V, W | Lie algebra repns. |
| | | \mathbb{V}, \mathbb{W} | Lie algebra repns., restricted to a parabolic subalgebra |
| | | \mathcal{V}, \mathcal{W} | Bundles associated to either V, W or \mathbb{V}, \mathbb{W} |

Miscellaneous symbols

| | | | |
|--------------------------------|--|---------------|--|
| \otimes | Tensor product | h | Element of $L^* \otimes B$ |
| \boxtimes | External tensor product | Z | Element of $L^* \otimes \mathfrak{g}/\mathfrak{p}$ |
| \wedge | Wedge product | λ | Element of L^* |
| \odot | Symmetric product | ℓ, π | Elements of L |
| \circledast | Cartan product | ζ, η | Elements of $L \otimes \mathfrak{p}^{\perp}$ |
| $[\cdot, \cdot]$ | Lie bracket | θ | Element of $L \otimes B^*$ |
| $[\cdot \wedge \cdot]$ | Skew-symmetrisation of $[\cdot, \cdot]$ | | |
| $\langle \cdot, \cdot \rangle$ | Killing form | | |
| $[[\cdot, \cdot]]$ | Algebraic bracket | | |
| $[[\cdot \wedge \cdot]]$ | Skew-symmetrisation of $[[\cdot, \cdot]]$ | | |
| $[[\cdot \odot \cdot]]$ | Symmetrisation of $[[\cdot, \cdot]]$ | | |
| $\{\cdot, \cdot\}$ | Poisson bracket | | |
| ∇ | (Weyl) connection | | |
| $[\nabla]$ | Space of Weyl connections | | |
| $\nabla^{\mathbb{V}}$ | Tractor connection induced by \mathbb{V} | | |
| $\nabla^{\mathcal{V}}$ | Prolongation connection on \mathcal{V} | | |
| \square | Algebraic laplacian | | |
| \square_M | First-order laplacian | | |
| \lrcorner | Contraction | | |
| $\cdot _x$ | Evaluation at a point x | | |
| \hookrightarrow | Injective map | | |
| \twoheadrightarrow | Surjective map | | |
| b, \sharp | Musical isomorphisms | | |

Generic notations

| | |
|-----|---------------------------------|
| M | Smooth manifold |
| m | Typical dimension of a manifold |