

ISOPERIMETRY IN SUPERCRITICAL BOND PERCOLATION IN DIMENSIONS THREE AND HIGHER

JULIAN GOLD

ABSTRACT. We study the isoperimetric subgraphs of the infinite cluster \mathbf{C}_∞ for supercritical bond percolation on \mathbb{Z}^d with $d \geq 3$. Specifically, we consider subgraphs of $\mathbf{C}_\infty \cap [-n, n]^d$ having minimal open edge boundary to volume ratio. We prove a shape theorem for these subgraphs: when suitably rescaled, they converge almost surely to a translate of a deterministic shape. This deterministic shape is itself an isoperimetric set for a norm we construct. As a corollary, we obtain sharp asymptotics on a natural modification of the Cheeger constant for $\mathbf{C}_\infty \cap [-n, n]^d$, settling a conjecture of Benjamini for the version of the Cheeger constant defined here.

arXiv:1602.05598v2 [math.PR] 27 Oct 2017

CONTENTS

1. Introduction and results	3
1.1. Motivation	3
1.2. Results	4
1.3. History and discussion	5
1.4. Outline	6
1.5. Open problems	7
1.6. Acknowledgements	8
2. Definitions and notation	8
2.1. Paths, boundaries, cutsets	8
2.2. A metric on measures	9
2.3. Geometric measure theory, miscellaneous notation	9
3. The norm $\beta_{p,d}$ and the Wulff crystal	10
3.1. Discrete cylinders	11
3.2. Cutsets in discrete cylinders	12
3.3. Defining the norm	14
3.4. The chosen orientation and properties of $\beta_{p,d}$	17
4. Concentration estimates for $\beta_{p,d}$	20
5. Consequences of concentration estimates	23
5.1. Lower bounds for cuts in thin cylinders	23
5.2. Upper bounds on $\widehat{\Phi}_n$, or efficient carvings of ice	25
6. Coarse graining	30
6.1. Preliminary notation	31
6.2. Discovering a cutset	31
6.3. Properties of the discovered cutset	34
7. Coarse graining applied	36
7.1. Contours	36
7.2. Webbing	38
7.3. A Peierls argument	40
7.4. Properties of F_n	42
8. Contiguity	43
8.1. Contour and perimeter control	44
8.2. A contiguity argument	46
8.3. Closeness to sets of finite perimeter	49
9. Lower bounds and main results	50
9.1. Setup, the reduced boundary and a covering lemma	50
9.2. Local surgery on each $\partial^\omega G_n$	52
9.3. Lower bounds on $ \partial^\omega G_n $	57
9.4. Proof of main results	61
Appendix A. Tools from percolation, graph theory and geometry	66
A.1. Tools from percolation	66
A.2. Tools from graph theory, approximation, miscellany.	69
References	70

1. INTRODUCTION AND RESULTS

1.1. Motivation. Isoperimetric problems, namely the problem of finding a set of given size and minimal boundary measure, have been studied for millennia. In the continuum, such problems are the subject of geometric measure theory and the calculus of variations. Isoperimetric inequalities give a lower bound on the boundary measure of a set in terms of the volume measure of the set. Their applications in mathematics range from concentration of measure to PDE theory.

Isoperimetric problems are also well-studied in the discrete setting. One can encode isoperimetric inequalities for graphs in the *Cheeger constant*, or modifications thereof. Define the Cheeger constant of a graph G to be

$$(1.1) \quad \Phi_G := \min \left\{ \frac{|\partial_G H|}{|H|} : H \subset G, 0 < |H| \leq |G|/2 \right\},$$

where $\partial_G H$ is the edge boundary of H in the graph G and where $|H|$ and $|G|$ respectively denote cardinalities of the vertex sets of H and G . Introduced in the context of manifolds in Cheeger's thesis [21], the Cheeger constant was used to give a lower bound on the smallest positive eigenvalue of the negative Laplacian. Its discrete analogue, introduced by Alon [3], plays a similar role in spectral graph theory (see for instance Chapter 2 of [22]). Indeed, Cheeger's inequality and its variants are used to study mixing times of random walks and Markov chains. Ultimately, the Cheeger constant provides one of many ways to study the geometry of a graph.

The goal of this paper is to explore the geometry of random graphs arising from bond percolation on \mathbb{Z}^d . We view \mathbb{Z}^d as a graph, with edge set $E(\mathbb{Z}^d)$ determined by nearest-neighbor pairs, and we form the probability space $(\{0, 1\}^{E(\mathbb{Z}^d)}, \mathcal{F}, \mathbb{P}_p)$, where \mathcal{F} denotes the product σ -algebra on $\{0, 1\}^{E(\mathbb{Z}^d)}$ and where \mathbb{P}_p is the product Bernoulli measure associated to the *percolation parameter* $p \in [0, 1]$. Elements $\omega = (\omega_e)_{e \in E(\mathbb{Z}^d)}$ of the probability space are *percolation configurations*. An edge $e \in E(\mathbb{Z}^d)$ is *open* in the configuration ω if $\omega_e = 1$ and is *closed* otherwise. The open edges determine a random subgraph of \mathbb{Z}^d whose connected components are called *open clusters*. It is well-known (see Grimmett [34] for details) that when $d \geq 2$, bond percolation exhibits a phase transition: there is a $p_c(d) \in (0, 1)$ so that whenever $p > p_c(d)$, there exists a unique infinite open cluster \mathbb{P}_p -almost surely, and whenever $p < p_c(d)$, there is no infinite open cluster \mathbb{P}_p -almost surely. We work in the supercritical ($p > p_c(d)$) regime, and denote the unique infinite open cluster by \mathbf{C}_∞ .

We may now be more specific: our goal is to explore the geometry of \mathbf{C}_∞ . There are many ways to do this, for example, one can study the asymptotic graph distance in \mathbf{C}_∞ (e.g. Antal and Pisztora [4]), the asymptotic shapes of balls in the graph distance metric of \mathbf{C}_∞ (e.g. Cox and Durrett [23]), or the effective resistance of \mathbf{C}_∞ within a large box (e.g. Grimmett and Kesten [35]). Our aim is to study the isoperimetry of \mathbf{C}_∞ through the Cheeger constant.

By definition, $\Phi_G = 0$ for any amenable graph, and one can show that $\Phi_{\mathbf{C}_\infty} = 0$ almost surely. We instead study the Cheeger constant of $\mathbf{C}_n := \mathbf{C}_\infty \cap [-n, n]^d$. Let $\widetilde{\mathbf{C}}_n$ be the largest connected component of \mathbf{C}_n . It is known (Benjamini and Mossel [5], Mathieu and Remy [43], Rau [52], Berger, Biskup, Hoffman and Kozma [6] and Pete [47]) that $\Phi_{\widetilde{\mathbf{C}}_n} \asymp n^{-1}$ as $n \rightarrow \infty$, prompting the following conjecture of Benjamini.

Conjecture 1.1. *For $p > p_c(d)$ and $d \geq 2$, the limit*

$$(1.2) \quad \lim_{n \rightarrow \infty} n \Phi_{\widetilde{\mathbf{C}}_n}$$

exists \mathbb{P}_p -almost surely and is a positive deterministic constant.

Procaccia and Rosenthal [51] made progress towards resolving this conjecture: they proved upper bounds on the variance of the Cheeger constant, showing $\text{Var}(n\Phi_{\tilde{\mathbf{C}}_n}) \leq cn^{2-d}$ for some positive $c = c(p, d)$. Recently, Biskup, Louidor, Procaccia and Rosenthal [7] settled this conjecture positively for a natural modification of $\Phi_{\tilde{\mathbf{C}}_n}$ in dimension two. Define the *modified Cheeger constant* $\widehat{\Phi}_n$ of \mathbf{C}_n in dimensions $d \geq 2$:

$$(1.3) \quad \widehat{\Phi}_n := \min \left\{ \frac{|\partial_{\mathbf{C}_\infty} H|}{|H|} : H \subset \mathbf{C}_n, 0 < |H| \leq |\mathbf{C}_n|/d! \right\},$$

where $\partial_{\mathbf{C}_\infty} H$ denotes the open edge boundary of H within *all of* \mathbf{C}_∞ as opposed to \mathbf{C}_n . This modification is natural in the sense that subgraphs H are treated as living within \mathbf{C}_∞ , and the $d!$ in the volume upper bound ensures that H need not touch the boundary of the box. Thanks to Proposition 1.2 of [5], the asymptotics of $\widehat{\Phi}_n$ are unchanged whether we use \mathbf{C}_n or $\tilde{\mathbf{C}}_n$ in (1.3).

Both $\Phi_{\tilde{\mathbf{C}}_n}$ and $\widehat{\Phi}_n$ are closely related to the so-called *anchored isoperimetric profile*, defined in the context of the infinite cluster as

$$(1.4) \quad \Phi_{\mathbf{C}_\infty, 0}(n) := \inf \left\{ \frac{|\partial_{\mathbf{C}_\infty} H|}{|H|} : 0 \in H \subset \mathbf{C}_\infty, H \text{ connected}, 0 < |H| \leq n \right\},$$

where of course we must condition on the positive probability event $\{0 \in \mathbf{C}_\infty\}$. In [7], the analogue of Benjamini's conjecture for the anchored isoperimetric profile was also established in dimension two. Moreover, the subgraphs of \mathbf{C}_n and \mathbf{C}_∞ achieving each minimum were studied in both cases, and in fact were shown to scale uniformly to the same deterministic limit shape. This *shape theorem* implies the existence of the limit in Conjecture 1.1 for (1.3). Indeed, the perimeter of this limit shape appears in the limiting value of the modified Cheeger constant.

1.2. Results. We extend the work of [7] to the setting $d \geq 3$ by settling Benjamini's conjecture for the modified Cheeger constant and by proving a shape theorem for isoperimetric subgraphs of \mathbf{C}_n . As the arguments in [7] rely heavily on planar geometry and graph duality, a much different approach is needed. Nevertheless, we share a common starting point in the Wulff construction, described below, and there are structural similarities between both arguments.

We state the main theorem of the paper first. For each n , let \mathcal{G}_n be the (random) collection of subgraphs of \mathbf{C}_n realizing the minimum in (1.3). For $A \subset \mathbb{R}^d$, $r > 0$ and $x \in \mathbb{R}^d$ the sets rA and $x + A$ are defined as usual by

$$(1.5) \quad rA := \{ra : a \in A\}, \quad x + A := \{x + a : a \in A\},$$

and we write $\|\cdot\|_{\ell^1}$ to denote the ℓ^1 -norm on \mathbb{Z}^d . Here is our main result:

Theorem 1.2. *Let $d \geq 3$ and $p > p_c(d)$. There is a deterministic, convex set $W_{p,d} \subset [-1, 1]^d$ so that*

$$(1.6) \quad \max_{\tilde{G}_n \in \mathcal{G}_n} \inf_{x \in \mathbb{R}^d} n^{-d} \left\| \mathbf{1}_{\tilde{G}_n} - \mathbf{1}_{\mathbf{C}_n \cap (x+nW_{p,d})} \right\|_{\ell^1} \xrightarrow{n \rightarrow \infty} 0$$

holds \mathbb{P}_p -almost surely.

Following [7], we build the limit shape $W_{p,d}$ through what is known as the Wulff construction, a method for solving anisotropic isoperimetric problems first introduced by Wulff [63] in 1901. Given a norm τ on \mathbb{R}^d , one can form an associated isoperimetric problem:

$$(1.7) \quad \text{minimize } \frac{\mathcal{I}_\tau(E)}{\mathcal{L}^d(E)} \quad \text{subject to } \mathcal{L}^d(E) \leq 1,$$

ranging over $E \subset \mathbb{R}^d$ with Lipschitz boundary, where \mathcal{L}^d denotes d -dimensional Lebesgue measure, and where $\mathcal{I}_\tau(E)$ is defined as

$$(1.8) \quad \mathcal{I}_\tau(E) := \int_{\partial E} \tau(v_E(x)) \mathcal{H}^{d-1}(dx).$$

Here \mathcal{H}^{d-1} is the $(d-1)$ -dimensional Hausdorff measure on ∂E and $v_E(x)$ the unit exterior normal to E at the point $x \in \partial E$, which is defined for \mathcal{H}^{d-1} -almost every point of ∂E . Wulff's isoperimetric set is the following intersection of half-spaces:

$$(1.9) \quad \widehat{W}_\tau := \bigcap_{v \in \mathbb{S}^{d-1}} \{x \in \mathbb{R}^d : x \cdot v \leq \tau(v)\},$$

where \cdot denotes the standard dot product in \mathbb{R}^d , and where \mathbb{S}^{d-1} is the unit sphere in \mathbb{R}^d . We call \widehat{W}_τ the *unit Wulff crystal* associated to τ ; this object is the unit ball in the norm τ' dual to τ (recall that τ' is defined on $y \in \mathbb{R}^d$ by $\tau'(y) = \sup\{x \cdot y : x \in \mathbb{R}^d, \tau(x) \leq 1\}$). When \widehat{W}_τ is scaled to have unit volume, it becomes a candidate minimizer for (1.7). Taylor [57] ultimately proved this rescaled shape is optimal within a wide class of Borel sets, and moreover (in [58]) that this rescaled shape is the unique optimizer up to translations and modifications on a null set.

The Wulff construction is relevant because a norm emerges naturally when our problem is viewed correctly. Denoted $\beta_{p,d}$, this norm is first defined on \mathbb{S}^{d-1} : in a given direction $v \in \mathbb{S}^{d-1}$, first rotate a large cube so that its top and bottom faces are normal to v , then consider the restriction of percolation to this rotated cube. The minimum size of a cutset separating the faces of the cube in this percolated graph functions as a discrete surface energy. By requiring these cutsets to be anchored near the middle of the cube, we may employ a subadditivity argument and extract a limit as the diameter of the cube tends to infinity. This homogenized surface energy is $\beta_{p,d}(v)$.

We build $\beta_{p,d}$ in Section 3, and we define the *Wulff crystal* $W_{p,d}$ to be the dilate of the unit Wulff crystal $\widehat{W}_{p,d}$ associated via (1.9) to $\beta_{p,d}$ so that $\mathcal{L}^d(W_{p,d}) = 2^d/d!$. The Wulff crystal is then the limit shape from Theorem 1.2, and we note that the norm $\beta_{p,d}$ gives rise to a *surface energy functional* of the form (1.8) denoted $\mathcal{I}_{p,d}$. As in [7], the shape theorem we present is intimately linked with the limiting value of the Cheeger constant. Let $\theta_p(d) := \mathbb{P}_p(0 \in \mathbf{C}_\infty)$ be the density of the infinite cluster within \mathbb{Z}^d .

Theorem 1.3. *Let $d \geq 3$, $p > p_c(d)$ and let $\beta_{p,d}$ be the norm to be constructed in Proposition 3.4. Let $W_{p,d}$ be the Wulff crystal for this norm, that is, the ball in the dual norm $\beta'_{p,d}$ such that $\mathcal{L}^d(W_{p,d}) = 2^d/d!$. Then,*

$$(1.10) \quad \lim_{n \rightarrow \infty} n \widehat{\Phi}_n = \frac{\mathcal{I}_{p,d}(W_{p,d})}{\theta_p(d) \mathcal{L}^d(W_{p,d})}$$

holds \mathbb{P}_p -almost surely.

1.3. History and discussion. Within the last thirty years, the Wulff construction has grown into an important tool in the rigorous analysis of equilibrium crystal shapes. Such problems are concerned with understanding the macroscopic behavior of one phase of matter immersed within another.

The present work fits into this paradigm in that we may regard each Cheeger optimizer G_n as a large droplet of a *crystalline* phase within $\mathbf{C}_\infty \setminus G_n$, regarded as the *ambient* phase. The value of the norm $\beta_{p,d}$ in a given direction represents the energy required to form a flat interface between the two phases in this direction, and gives rise to a surface energy functional of the form (1.8). It was

Gibbs [32] who postulated that, in general, the asymptotic shape of the crystalline phase should minimize this surface energy. The Wulff construction furnishes this minimal shape.

The spirit of Theorem 1.2 can be traced back to the work of Minlos and Sinai [44, 45] from the 1960s, in which the geometric properties of phase separation in a material are rigorously studied. The first rigorous characterizations of phase separation via the Wulff construction are due independently to Dobrushin, Kotecký and Shlosman [25] in the context of the two-dimensional Ising model and to Alexander, Chayes and Chayes [2] in the context of two-dimensional bond percolation. The results of [25], valid in the low-temperature regime, were extended up to the critical temperature thanks to the work of Ioffe [37] and Ioffe and Schonmann [38].

The first rigorous derivation of the Wulff construction for a genuine short-range model in three dimensions was achieved by Cerf in the context of bond percolation [15]. Analogous results for the Ising model and in higher dimensions were achieved in several substantial works of Bodineau [8, 9] and Cerf and Pisztora [17, 18]. The coarse graining results of Pisztora [50] played an integral role in this study of the Ising model, FK percolation and bond percolation in higher dimensions. A comprehensive survey of these results and of others can be found in Section 5.5 of Cerf’s monograph [16] and in the review article of Bodineau, Ioffe and Velenik [10].

In all cases, the jump to dimensions strictly larger than two has, at least so far, necessitated a shift from the uniform topology to the ℓ^1 -topology on the space of shapes (we are intentionally vague about which space we consider). Indeed, the variational problem (1.7) is not stable in $d \geq 3$ when the space of shapes is equipped with the uniform topology: it is possible to construct a sequence of shapes bounded away from the optimal shape in the uniform topology, but whose surface energies tend to the optimal surface energy. This has implications at the microscopic level; to prove a uniform shape theorem in $d \geq 3$ for the Cheeger optimizers, one would first have to rule out the existence of long thin filaments (as in Figure 1) in these discrete objects with high probability.

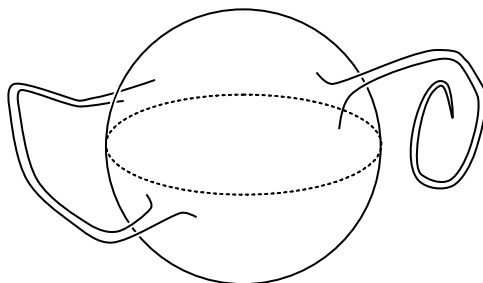

FIGURE 1. In $d = 3$, filaments added to the optimal shape for the Euclidean isoperimetric problem produce a set which is almost optimal and yet has large uniform distance to the sphere.

This lack of regularity at the microscopic level requires that we consider the variational problem over a wider class of shapes, and it is here that geometric measure theory emerges as a valuable tool, as first realized by Alberti, Bellettini, Cassandro and Presutti [1].

1.4. Outline. Our goals may be summarized as follows: we wish to show that the sequence of discrete, random isoperimetric problems (1.3) scale to a continuous, deterministic isoperimetric problem (1.7) corresponding to some norm $\beta_{p,d}$ on \mathbb{R}^d . We do not use the language of Γ -convergence, though this has been used in recent related work of Braides and Piatnitski [12, 13].

The first task is to construct a suitable norm $\beta_{p,d}$ on \mathbb{R}^d , done in Section 3 after introducing some definitions and notation in Section 2. The key to the existence of $\beta_{p,d}$ is a spatial subadditivity argument applied to the geometric setting described briefly before Theorem 1.3.

The resulting norm $\beta_{p,d}$ gives rise to a surface energy $\mathcal{I}_{p,d}$, and the remainder of the paper is concerned with demonstrating that the unique optimizer of the isoperimetric problem associated to $\mathcal{I}_{p,d}$ faithfully describes the macroscopic shape of each large $G_n \in \mathcal{G}_n$. We must show a correspondence between discrete objects (the various subgraphs of \mathbf{C}_n) and continuous objects (Borel subsets of $[-1, 1]^d$ for which isoperimetric problems can be defined). This correspondence should be strong enough to link the isoperimetric ratio of subgraphs of \mathbf{C}_n to the ratio for continuous objects, as in the limiting value of Theorem 1.3.

Concentration estimates proved in Section 4 allow us to pass from continuous objects to discrete objects in Section 5, yielding high probability upper bounds on $\widehat{\Phi}_n$. This is in line with the strategy of [7], and is in contrast to large deviation methods used in some of the work referenced in Section 1.3, where the nature of these earlier problems requires working within events of small probability. All arguments presented up to this point work in the setting $d \geq 2$.

Passing from discrete objects to continuous objects is more delicate, and requires a renormalization argument given in Section 6. We base our argument on a construction from an unpublished note of Zhang [64], but we must improve this construction and study it carefully in order to apply it to our situation. It is here that, for reasons which will be made clear in Section 7, we must restrict ourselves to the setting $d \geq 3$. This is no loss as the case $d = 2$ is covered by results in [7].

In Section 8, we reap the efforts of Section 7, passing from $G_n \in \mathcal{G}_n$ to sets of finite perimeter (defined in Section 2). Such sets have just enough regularity that we may work locally on their boundaries. We exploit this in Section 9 to show whenever a G_n is close to a set of finite perimeter, the surface energy of this set is roughly a lower bound on the open edge boundary of G_n . Our notion of closeness allows us to relate the volumes of these objects; we may then deduce that whenever G_n is close to a set of finite perimeter, the isoperimetric ratio of G_n (hence the Cheeger constant) is controlled from below by the isoperimetric ratio of the given continuum set.

Invoking the results of Section 5 and the work of Taylor [57, 58], we find that with high probability, each G_n must be close to the Wulff crystal, giving Theorem 1.2 and Theorem 1.3 in quick succession.

1.5. Open problems. We pose several open questions, some of which were stated in [7].

(1) *Boundary conditions and more general domains:* Conjecture 1.1 was recently settled for the unmodified Cheeger constant in dimension two [33], though it remains to link the set of limit shapes in this case with the Wulff shape. Motivated by the Winterbottom construction (see [62, 48, 49, 11]), we conjecture the limit shapes in this case are rescaled quarter-Wulff crystals.

One can generalize Benajmini's conjecture in the two-dimensional setting to domains other than boxes: given a nice bounded open set $\Omega \subset \mathbb{R}^2$, one can study the asymptotics of the unmodified Cheeger constant as well as the shapes of the Cheeger optimizers for the largest connected component of $\mathbf{C}_\infty \cap n\Omega$.

(2) *More information on the Wulff crystal:* Little is known about the geometric properties of the Wulff crystal. One recent result of Garet, Marchand, Procaccia and Th  ret [31] is that, in two dimensions, the Wulff crystal varies continuously with respect to the uniform metric on compact sets as a function of the percolation parameter $p \in (p_c(2), 1]$. It was conjectured in [7] that the

two-dimensional Wulff crystal tends to a Euclidean ball as $p \downarrow p_c(2)$; this is still widely open. It is natural to ask whether the Wulff crystal has facets (open portions of the boundary with zero curvature) or corners, and how such questions depend on the percolation parameter.

(3) *Uniform convergence for $d \geq 3$* : An interesting and challenging question is whether a form of Theorem 1.2 holds in $d \geq 3$ when we replace ℓ^1 -convergence by uniform convergence. Such a result would have to overcome the challenges outlined in Section 1.3.

1.6. Acknowledgements. I thank my advisor Marek Biskup for suggesting this problem, for his guidance and his support. I am deeply indebted to Raphaël Cerf for patiently sharing his expertise and insight during my time in Paris. I likewise thank Eviatar Procaccia for his guidance. I am grateful to Vincent Vargas, Claire Berenger and Shannon Starr for making it possible for me to attend the IHP Disordered Systems trimester. I thank Yoshihiro Abe, Ian Charlesworth, Arko Chatterjee, Hugo Duminil-Copin, Aukosh Jagannath, Ben Krause, Sangchul Lee, Tom Liggett, Jeff Lin, Peter Petersen, Jacob Rooney and Ian Zemke for helpful conversations. Finally, I wish to express my gratitude to anonymous referees for their helpful comments. This research has been partially supported by the NSF grant DMS-1407558.

2. DEFINITIONS AND NOTATION

2.1. Paths, boundaries, cutsets. We work almost entirely within the graph \mathbb{Z}^d , whose vertex set consists of all integer d -tuples, and where there is an edge between two vertices if their Euclidean distance is one. Edges have no orientation, and if vertices x and y are adjacent, we write $x \sim y$.

A *path* between vertices x and y in \mathbb{Z}^d is a finite, alternating sequence of vertices and edges $\gamma = (x \equiv x_0, e_1, x_1, \dots, e_m, x_m \equiv y)$ such that e_i joins x_{i-1} and x_i for $i = 1, \dots, m$. The path γ *joins* x and y , and the *length* of γ is m . A subgraph $G = (V(G), E(G))$ of \mathbb{Z}^d is *connected* if for any vertices $x, y \in G$, there is a path using only vertices and edges of G joining x and y . For a vertex $x \in \mathbb{Z}^d$, a *path from x to ∞* is an infinite alternating sequence of vertices and edges $\gamma = (x \equiv x_0, e_1, x_1, \dots)$ where no finite box contains all e_i . In both the finite and infinite cases, a path is *simple* if it uses each vertex no more than once, and paths are often regarded as sequences of edges out of convenience.

For the rest of this subsection, let G be a finite subgraph of \mathbb{Z}^d . The *edge boundary* and *outer edge boundary* of G are respectively the following sets of edges:

$$(2.1) \quad \partial G := \{e \in E(\mathbb{Z}^d) : \text{exactly one endpoint of } e \text{ lies in } G\}$$

$$(2.2) \quad \partial_o G := \left\{ e \in \partial G : \begin{array}{l} \text{the endpoint of } e \text{ in } G \text{ is connected to } \infty \\ \text{via a path using no other vertices of } G \end{array} \right\}.$$

The *vertex boundary* of G is the following set of vertices:

$$(2.3) \quad \partial_* G := \{v \in V(G) : v \text{ is an endpoint of an edge in } \partial_o G\}.$$

A *cutset separating G from ∞* is a finite collection of edges $S \subset E(\mathbb{Z}^d)$ where any path from G to ∞ uses an edge of S . If $A, B \subset V(G)$ are disjoint vertex sets, a *cutset separating A and B in G* is a finite collection of edges $S \subset E(G)$ where any path in G from A to B uses an edge of S . A cutset is *minimal* if it is no longer a cutset upon removing an edge.

We occasionally work with the graph \mathbb{L}^d , which has the same vertex set as \mathbb{Z}^d , but where vertices x and y are now adjacent if their ℓ^∞ -distance is one. When x and y are adjacent in \mathbb{L}^d , write $x \sim_* y$ and say they are **-adjacent*. Paths in \mathbb{L}^d are **-paths*, and $G \subset \mathbb{Z}^d$ is **-connected* if any two vertices

of G are joined by a $*$ -path whose vertices all lie in G . Proposition 2.1 is standard in the literature and is useful for Peierls estimates appearing frequently in the study of lattice models.

Proposition 2.1. (*Deuschel-Pisztora [24], Timár [61]*) *Let $G \subset \mathbb{Z}^d$ be a finite, connected subgraph of \mathbb{Z}^d . Then $\partial_* G$ is $*$ -connected, as is the set of vertices which are endpoints of edges in $\partial_o G$.*

For $K \subset \mathbb{R}^d$ compact, write $G \cap K$ for the graph obtained by restricting G to the vertex set $V(G) \cap K$ in the natural way. Write $|G|$ for the cardinality of the vertex set of G , and in general if F is any finite set, let $|F|$ denote the cardinality of F .

Bond percolation gives rise to another notion of graph boundary: if G is a finite subgraph of \mathbf{C}_∞ , the *open edge boundary* of G is

$$(2.4) \quad \partial^\omega G := \{e \in \partial G : \omega(e) = 1\},$$

and the *conductance* of G , written φ_G , is the ratio $|\partial^\omega G|/|G|$. A subgraph G of $\mathbf{C}_n = \mathbf{C}_\infty \cap [-n, n]^d$ is *valid* if it satisfies $0 < |G| \leq |\mathbf{C}_n|/d!$, and a valid subgraph $G \subset \mathbf{C}_n$ is *optimal* if $\varphi_G = \widehat{\Phi}_n$.

Remark 2.2. Each $G_n \in \mathcal{G}_n$ is determined by its vertex set, else we could strictly reduce $|\partial^\omega G_n|$.

2.2. A metric on measures. To prove Theorem 1.2, we first encode each optimizer G_n as a measure and prove closeness to a set of limiting measures. Given $G_n \in \mathcal{G}_n$, the *empirical measure* of G_n is the following non-negative Borel measure on $[-1, 1]^d$:

$$(2.5) \quad \mu_n := \frac{1}{n^d} \sum_{x \in V(G_n)} \delta_{x/n}.$$

Given a Borel set $E \subset [-1, 1]^d$, define ν_E as the measure on $[-1, 1]^d$ having density $\theta_p(d)\mathbf{1}_E$ with respect to Lebesgue measure, and say that ν_E *represents* E . The collection of finite signed Borel measures on $[-1, 1]^d$ is denoted $\mathcal{M}([-1, 1]^d)$, and the closed ball (with respect to the total variation norm) of radius 3^d about the zero measure in this space is written \mathcal{B}_d . For every percolation configuration ω , the empirical measures μ_n lie within \mathcal{B}_d , as does every ν_E for $E \subset [-1, 1]^d$ Borel.

We now equip \mathcal{B}_d with a metric. For $k \in \{0, 1, 2, \dots\}$, the *dyadic cubes at scale k* are all sets of the form $2^{-k}([-1, 1]^d + x)$ for $x \in \mathbb{Z}^d$. Let $\Delta^k \equiv \Delta^{k,d}$ denote the dyadic cubes at scale k contained in $[-1, 1]^d$. Given $\mu, \nu \in \mathcal{B}_d$, define

$$(2.6) \quad \mathfrak{d}(\mu, \nu) := \sum_{k=0}^{\infty} \frac{1}{2^k} \sum_{Q \in \Delta^k} \frac{1}{|\Delta^k|} |\mu(Q) - \nu(Q)|.$$

The metric \mathfrak{d} is useful for comparing discrete and continuous objects when both are encoded as measures. It figures prominently in the final section of the paper.

2.3. Geometric measure theory, miscellaneous notation. We introduce sets of finite perimeter; the following definitions are taken from Sections 13.3 and 14.1 of [16]. Write \mathcal{L}^d for d -dimensional Lebesgue measure and \mathcal{H}^d for d -dimensional Hausdorff measure. Given a norm τ on \mathbb{R}^d and a Borel subset E of \mathbb{R}^d , define the *surface energy of E with respect to τ* as

$$(2.7) \quad \mathcal{I}_\tau(E) := \sup \left\{ \int_E \operatorname{div} f(x) \mathcal{L}^d(dx) : f \in C_c^\infty(\mathbb{R}^d, \widehat{W}_\tau) \right\},$$

where \widehat{W}_τ is the unit Wulff crystal defined in (1.9). Here $\operatorname{div}(f)$ denotes the divergence of the function f , which is a smooth compactly supported function on \mathbb{R}^d taking values in \widehat{W}_τ . By the

divergence theorem, (2.7) extends (1.8) to Borel sets. When τ is the Euclidean norm, call $I_\tau(E)$ the *perimeter* of E , writing $\text{per}(E)$. Naturally, E has *finite perimeter* if $\text{per}(E) < \infty$.

The following theorem is vital to the proof of Theorem 1.2.

Theorem 2.3. (Taylor [57, 58, 59]) *Let τ be a norm on \mathbb{R}^d and consider the variational problem for Borel sets $E \subset \mathbb{R}^d$:*

$$(2.8) \quad \text{minimize } I_\tau(E) \quad \text{subject to } \mathcal{L}^d(E) \leq \mathcal{L}^d(\widehat{W}_\tau),$$

A set E is a minimizer of this variational problem if and only if there is $x \in \mathbb{R}^d$ such that the symmetric difference of \widehat{W}_τ and $E + x$ has Lebesgue measure zero.

We close the section by collecting some notation. For $p \in [1, \infty]$, use $|\cdot|_p$ to denote the ℓ^p -norm on \mathbb{R}^d . For $x \in \mathbb{R}^d$ and $r > 0$, let $B(x, r)$ denote the closed r -ball centered at x in the ℓ^2 -norm. For $E \subset \mathbb{R}^d$ and $a > 0$, let $N_a(E)$ denote the closed Euclidean a -neighborhood of E : $N_a(E) := E + B(0, a)$, and define the closed a -neighborhood of E in the ℓ^1 -norm analogously, writing this as $N_a^{(1)}(E)$. Lastly, the Hausdorff metric on compact subsets of \mathbb{R}^d is defined via

$$(2.9) \quad d_H(A, B) := \max \left(\sup_{x \in A} \inf_{y \in B} |x - y|_\infty, \sup_{y \in B} \inf_{x \in A} |x - y|_\infty \right).$$

3. THE NORM $\beta_{p,d}$ AND THE WULFF CRYSTAL

To motivate the construction of the norm, we regard an optimizer $G_n \in \mathcal{G}_n$ as a droplet in \mathbf{C}_∞ , and look at a small but macroscopic (diameter on the order of n) box intersecting the boundary of G_n , as in Figure 2.

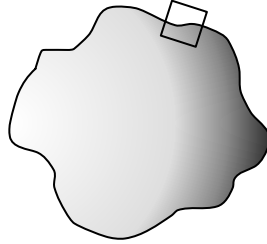

FIGURE 2. A small box B placed on the boundary of G_n .

The small box B captures a piece of ∂G_n , which we imagine separates the top and bottom faces of B . The position of this cutset does not greatly affect the enclosed volume $|G_n|$ as B is so small relative to G_n , so minimizing the number of open edges used by this cutset is most important to minimizing the conductance of G_n . This minimal number of open edges in a cutset separating the faces of B is a microscopic *surface energy* in the direction normal to these faces. This energy grows like $O(n^{d-1})$ regardless of the normal direction. We then construct $\beta_{p,d}$ as a limit of these microscopic surface energies, properly normalized.

Minimal randomly weighted cutsets in boxes ($d \geq 2$) well-studied. In $d = 2$, such cutsets are dual to paths and fall within the realm of first-passage percolation. In higher dimensions, they were first examined by Kesten [40]. Variants of these objects have been studied by Th eret [60], Rossignol and Th eret [53, 54], Zhang [64] and Garet [30]. For a detailed list of these results, see Section 3.1 of [20].

Most of the work above constructs and uses the norm we are about to build. We emphasize that results presented in this section and in Section 4 are neither new nor optimal. Nevertheless, we find it important to present a relatively self-contained argument, and the notation introduced here will be used heavily throughout the paper.

3.1. Discrete cylinders. We set up objects and notation needed to define $\beta_{p,d}$. We use notation from Cerf and Th  ret [16, 20] to build cylinders over $(d - 1)$ -dimensional objects; among other things these will function as boxes as in Figure 2.

Let $F \subset \mathbb{R}^d$ be the isometric image (see Remark A.13) of either a non-degenerate polytope in \mathbb{R}^{d-1} or a Euclidean ball in \mathbb{R}^{d-1} . Polytopes are defined at the beginning of Section 5.2; in the present section we only ever need F to be a square.

Write $\text{hyp}(F)$ to denote the hyperplane spanned by F , and let $\nu(F)$ denote one of the two unit vectors normal to $\text{hyp}(F)$; the choice does not matter for our definitions. For $\rho > 0$, define $\text{cyl}(F, \rho)$ to be the closed cylinder in \mathbb{R}^d whose top and bottom faces are respectively $F_\rho^+ := F + \rho\nu(F)$ and $F_\rho^- := F - \rho\nu(F)$. The choice of $\nu(F)$ creates ambiguity over which face of the cylinder is the top, but this ambiguity is unimportant and plays no role in the definition of the norm. Define

$$(3.1) \quad \text{slab}(F, \rho) := \text{hyp}(F) + B(0, \rho).$$

Figure 3 depicts the geometric objects introduced so far.

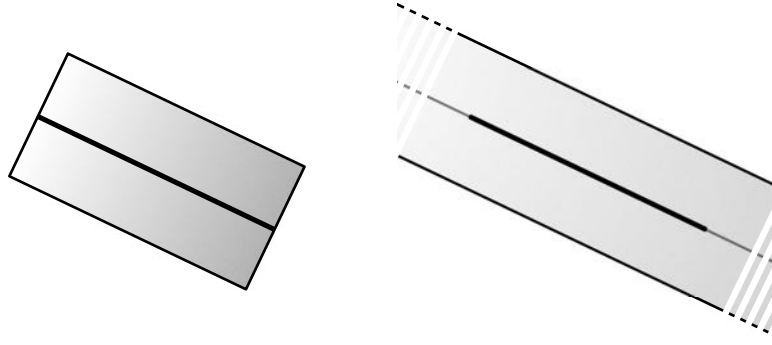

FIGURE 3. In both graphics, the bold line is F . The set $\text{cyl}(F, \rho)$ is depicted as a box on the left. The top and bottom faces of this box are F_ρ^+ and F_ρ^- respectively. The set $\text{slab}(F, \rho)$ is on the right, and the pale line running through the center is $\text{hyp}(F)$.

For $r > 0$, which we think of as large, define the *discrete cylinder* $\text{d-cyl}(F, \rho, r)$ as

$$(3.2) \quad \text{d-cyl}(F, \rho, r) := \{x \in \mathbb{Z}^d : x/r \in \text{cyl}(F, \rho)\},$$

and note that $\text{cyl}(F, \rho) \setminus \text{hyp}(F)$ consists of two connected components. The top component, which contains F_ρ^+ , is denoted $\text{cyl}^+(F, \rho)$, while the bottom is denoted $\text{cyl}^-(F, \rho)$. The following sets are the top (corresponding to “+”) and bottom (“-”) *hemispheres* of $\text{d-cyl}(F, \rho, r)$:

$$(3.3) \quad \text{d-hemi}^\pm(F, \rho, r) := \{x \in \partial_* \text{d-cyl}(F, \rho, r) : x/r \in \text{cyl}^\pm(F, \rho)\}.$$

Define the top and bottom *faces* of $\text{d-cyl}(F, \rho, r)$:

$$(3.4) \quad \text{d-face}^\pm(F, \rho, r) := \{x \in \partial_* [(r \cdot \text{slab}(F, \rho)) \cap \mathbb{Z}^d] : x/r \in \text{cyl}^\pm(F, \rho)\}.$$

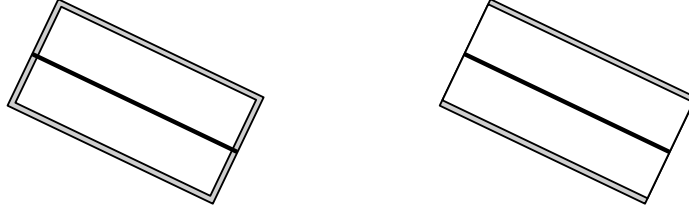

FIGURE 4. On the left, the vertex set $d\text{-hemi}^+(F, \rho, r)$ (respectively $d\text{-hemi}^-(F, \rho, r)$) is the shaded region above (respectively below) the bold line. On the right, the vertex sets $d\text{-face}^\pm(F, \rho, r)$ are the shaded regions above (+) and below (-) the bold line.

This definition of $d\text{-face}$ looks complicated, but is conceptually even simpler than $d\text{-hemi}$, it is depicted on the right side of Figure 4.

3.2. Cutsets in discrete cylinders. The vertex sets $d\text{-hemi}^\pm(F, \rho, r)$ and $d\text{-face}^\pm(F, \rho, r)$ are contained in $d\text{-cyl}(F, \rho, r)$, which inherits a graph structure from \mathbb{Z}^d . We may then consider cutsets within $d\text{-cyl}(F, \rho, r)$ separating opposite hemispheres or faces. Bond percolation on \mathbb{Z}^d induces bond percolation within $d\text{-cyl}(F, \rho, r)$, yielding a relevant *weight* to assign to these cutsets. For any cutset S , let $|S|_\omega$ denote the number of open edges in S , so that $|S|_\omega$ is a random variable. Define

$$(3.5) \quad \Xi_{\text{hemi}}(F, \rho, r) := \min(|S|_\omega : S \text{ separates } d\text{-hemi}^\pm(F, \rho, r) \text{ within } d\text{-cyl}(F, \rho, r)),$$

and likewise define

$$(3.6) \quad \Xi_{\text{face}}(F, \rho, r) := \min(|S|_\omega : S \text{ separates } d\text{-face}^\pm(F, \rho, r) \text{ within } d\text{-cyl}(F, \rho, r)).$$

The cutsets in the definition of $\Xi_{\text{hemi}}(F, \rho, r)$ are *anchored* at the equator of the cylinder $\text{cyl}(F, \rho, r)$, whereas the cutsets in the definition of $\Xi_{\text{face}}(F, \rho, r)$ are allowed to meet the sides of $\text{cyl}(F, \rho, r)$ at any height relative to the equator.

Remark 3.1. Whenever r or ρ are too small relative to F , $\Xi_{\text{hemi}}(F, \rho, r)$ and $\Xi_{\text{face}}(F, \rho, r)$ may not be well-defined. Say the parameters r and ρ are *suitable* for F if the vertex sets $d\text{-hemi}^\pm(F, \rho, r)$ and $d\text{-face}^\pm(F, \rho, r)$ are non-empty, and if the vertex sets $d\text{-face}^\pm(F, \rho, r)$ are a Euclidean distance of at least $100d$. When ρ and r are suitable for F , define $\Xi_{\text{hemi}}(F, \rho, r)$ and $\Xi_{\text{face}}(F, \rho, r)$ as in (3.5) and (3.6) respectively. Otherwise define these random variables to be zero.

To study cutsets within large discrete boxes, we specialize the above construction to cylinders based at squares. A *square* in \mathbb{R}^d is the isometric image of $[-1, 1]^{d-1} \times \{0\}$. For $v \in \mathbb{S}^{d-1}$, consider a square in \mathbb{R}^d centered at 0 whose spanning hyperplane is normal to v . In dimensions at least three, this constraint does not uniquely determine the square, so we must assign each direction $v \in \mathbb{S}^{d-1}$ a unique square to define the norm. Let \mathbf{S} be such an assignment; that is for each $v \in \mathbb{S}^{d-1}$, $\mathbf{S}(v)$ is a square in \mathbb{R}^d centered at 0 with $\text{hyp}(\mathbf{S}(v))$ normal to v . Refer to \mathbf{S} as the *chosen orientation*.

The value of $\beta_{p,d}$ in a given direction will not depend on \mathbf{S} (as we show in Proposition 3.4). However, later proofs are simplified by building $\beta_{p,d}$ from a chosen orientation varying nicely over the sphere. Throughout this subsection and the next, treat \mathbf{S} as given. The random variables used to define $\beta_{p,d}$ are

$$(3.7) \quad \mathfrak{X}(x, v, r) := \Xi_{\text{hemi}}(\mathbf{S}(v) + x, 1, r).$$

The final observation of this subsection is that the expected value of these random variables is not too sensitive to where the cylinder is centered.

Lemma 3.2. *Let $d \geq 2$. There is a positive constant $c(d)$ so that for all $p \in [0, 1]$, $x \in \mathbb{R}^d$, $v \in \mathbb{S}^{d-1}$ and $r > 0$,*

$$(3.8) \quad \mathbb{E}_p \mathfrak{X}(x, v, r + d^{1/2}) \leq \mathbb{E}_p \mathfrak{X}(0, v, r) + c(d)r^{d-2}.$$

Proof. The idea of this proof is captured in Figure 5. It is intuitive that by starting with an anchored cutset for the smaller box and adding a microscopic ring of edges around the equator of this box, we produce an anchored cutset in a slightly larger box. This is indeed the case, though we are careful to show in the next lemma that patching these edge sets together truly is a cutset in the larger box.

Let $x \in \mathbb{R}^d$ and $v \in \mathbb{S}^{d-1}$. Choose $x' \in \mathbb{Z}^d$ so that $|x - x'|_\infty \leq 1$. For notational ease, make the following abbreviations within this proof and the next.

$$(3.9) \quad \text{cyl}(x') := \text{rcyl}(\mathbb{S}(v) + x', 1) \quad \text{cyl}(x) := (r + d^{1/2}) \text{cyl}(\mathbb{S}(v) + x, 1)$$

$$(3.10) \quad \text{hyp}(x) := \text{hyp}((r + d^{1/2})(\mathbb{S}(v) + x)).$$

Thus, $\text{cyl}(x')$ is the slightly larger box with integer center containing $\text{cyl}(x)$. Let A be the microscopic ring of edges, formally the collection of edges in \mathbb{Z}^d having non-empty intersection with the neighborhood

$$(3.11) \quad \mathcal{N}_{5d}((\text{cyl}(x) \setminus \text{cyl}(x')) \cap \text{hyp}(x)).$$

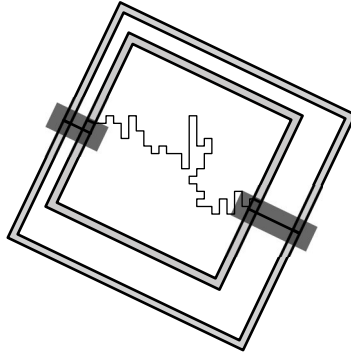

FIGURE 5. The inner box is $\text{cyl}(x')$, the outer box is $\text{cyl}(x)$, and the darker shaded region is the neighborhood (3.11) used to define A . The thin discrete interface is the cutset E .

From the construction of A , there is $c(d) > 0$ with $|A| \leq c(d)r^{d-2}$. This is because (3.11) is a microscopic thickening of a $(d - 2)$ -dimensional set. We now choose a cutset in the smaller

cylinder. For notational clarity, make the following abbreviations.

$$(3.12) \quad \text{d-cyl}(x') := \text{d-cyl}(\mathbf{S}(v) + x', 1, r),$$

$$(3.13) \quad \text{d-hemi}^\pm(x') := \text{d-hemi}^\pm(\mathbf{S}(v) + x', 1, r),$$

$$(3.14) \quad \text{d-cyl}(x) := \text{d-cyl}(\mathbf{S}(v) + x, 1, r + d^{1/2}),$$

$$(3.15) \quad \text{d-hemi}^\pm(x) := \text{d-hemi}^\pm(\mathbf{S}(v) + x, 1, r + d^{1/2}).$$

Let $E = E(\omega)$ be a minimal cutset separating $\text{d-hemi}^\pm(x')$ within $\text{d-cyl}(x')$. We claim the edges in $A \cup E$ which lie in $\text{d-cyl}(x)$ separate $\text{d-hemi}^\pm(x)$ in $\text{d-cyl}(x)$. Assuming this, we have

$$(3.16) \quad \mathfrak{X}(x, v, r + d^{1/2}) \leq \mathfrak{X}(x', v, r) + c(d)r^{d-2},$$

and the lemma is proved upon taking expectations as $x' \in \mathbb{Z}^d$. \square

We now carefully show that the patching of edge sets produces a cutset in the larger box. We appeal to the following argument at several points in the future without repeating details.

Lemma 3.3. *In the proof of the preceding lemma, the edges of $A \cup E$ contained in $\text{d-cyl}(x)$ separate $\text{d-hemi}^\pm(x)$ in $\text{d-cyl}(x)$.*

Proof. Adopt the notation from the proof of Lemma 3.2. It suffices to show that any \mathbb{Z}^d -path joining $\text{d-hemi}^\pm(x)$ within $\text{d-cyl}(x)$ uses an edge of $A \cup E(\omega)$. Let $y^\pm \in \text{d-hemi}^\pm(x)$, and let γ be a simple path from y^- to y^+ using only edges of $\text{d-cyl}(x)$. If γ does not pass through a vertex of $\partial_* \text{d-cyl}(x')$, γ lies entirely within $\text{cyl}(x) \setminus \text{cyl}(x')$, in which case γ must use an edge of A . We may then suppose that γ passes through a vertex of $\partial_* \text{d-cyl}(x')$ and consider several cases.

Case (i): Suppose that the last vertex z^+ of $\text{d-cyl}(x')$ used by γ lies within $\text{d-hemi}^-(x')$. Let γ' denote the subpath of γ connecting z^+ to y^+ , and observe that γ' is contained within $\text{cyl}(x) \setminus \text{cyl}(x')$. As γ' starts either in the bottom half of $\text{cyl}(x)$ or in the neighborhood defined in (3.11), γ' must use an edge in A .

Case (ii): Suppose that the first vertex z^- of $\text{d-cyl}(x')$ used by γ lies in $\text{d-hemi}^+(x')$. Using the same reasoning as in Case (i), we see that γ must use an edge in A between y^- and z^- .

Case (iii): We may now suppose $z^\pm \in \text{d-hemi}^\pm(x')$. Let z be the vertex of $\text{d-hemi}^-(x')$ used last by γ , and consider the subpath γ' of γ joining z to z^+ . If γ' is contained completely within $\text{d-cyl}(x')$, then γ' uses an edge of $E(\omega)$. On the other hand, if γ' is not contained in $\text{d-cyl}(x')$, we may assume the vertex following z in the path γ' lies outside of $\text{d-cyl}(x')$, else γ' would either use an edge of $E(\omega)$, or would not use z last among all vertices of $\text{d-hemi}^-(x')$. Under this assumption, γ' leaves $\text{d-cyl}(x')$ at the vertex z , and only returns to $\text{d-cyl}(x')$ at some vertex $z' \in \text{d-hemi}^+(x')$. Along the subpath γ'' of γ' joining z with z' , all intermediate vertices lie in $\text{cyl}(x) \setminus \text{cyl}(x')$, and γ'' uses an edge of A . \square

3.3. Defining the norm. To define $\beta_{p,d}$ as quickly as possible, we use a subadditivity argument taken from Rossignol and Th eret (see Section 4.3 of [54]).

Proposition 3.4. *Let $d \geq 2$. For all $v \in \mathbb{S}^{d-1}$, the limit*

$$(3.17) \quad \beta_{p,d}(v) := \lim_{n \rightarrow \infty} \frac{\mathbb{E}_p \mathfrak{X}(0, v, n)}{(2n)^{d-1}}$$

exists and is finite. Moreover, this limit is independent of the chosen orientation \mathbf{S} .

Proof. Let $n, m \in \mathbb{N}$ with n much larger than m and both numbers larger than d . Write $n = km + r$ for $k, r \in \mathbb{N} \cup \{0\}$ and $r < m$. Let \mathbf{S} be the chosen orientation, and let $\widetilde{\mathbf{S}}$ be another assignment of unit vectors $v \in \mathbb{S}^{d-1}$ to squares $\widetilde{\mathbf{S}}(v)$ so that v is normal to $\text{hyp}(\widetilde{\mathbf{S}}(v))$. Define $\widetilde{\mathfrak{X}}(x, v, r)$ using $\widetilde{\mathbf{S}}$ in place of \mathbf{S} :

$$(3.18) \quad \widetilde{\mathfrak{X}}(x, v, r) := \Xi_{\text{hemi}}(\widetilde{\mathbf{S}}(v) + x, 1, r).$$

Choose a finite collection $\{\widetilde{\mathcal{S}}_i\}_{i=1}^\ell$ of translates of $(m + d^{1/2})\widetilde{\mathbf{S}}(v)$, each contained in $n\mathbf{S}(v)$, so that:

- (i) The translates $\{\widetilde{\mathcal{S}}_i\}_{i=1}^\ell$ are disjoint.
- (ii) There is a positive constant $c(d)$ so that $\mathcal{H}^{d-1}(n\mathbf{S}(v) \setminus \bigcup_{i=1}^\ell \widetilde{\mathcal{S}}_i) \leq c(d)mn^{d-2}$.
- (iii) $\ell \leq (k + 1)^{d-1}$.

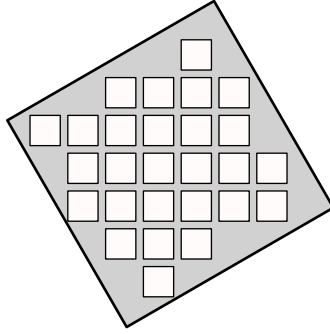

FIGURE 6. The small white squares are the collection $\{\widetilde{\mathcal{S}}_i\}_{i=1}^\ell$, which are disjoint and nearly exhaust the large square $n\mathbf{S}(v)$. In this diagram, we draw squares as two-dimensional objects, whereas in all previous diagrams they were drawn as one-dimensional objects.

Make the abbreviations

$$(3.19) \quad \text{d-cyl}(i) := \text{d-cyl}(\widetilde{\mathcal{S}}_i, m + d^{1/2}, 1),$$

$$(3.20) \quad \text{d-hemi}^\pm(i) := \text{d-hemi}^\pm(\widetilde{\mathcal{S}}_i, m + d^{1/2}, 1),$$

$$(3.21) \quad \text{d-cyl} := \text{d-cyl}(\mathbf{S}(v), 1, n),$$

$$(3.22) \quad \text{d-hemi}^\pm := \text{d-hemi}^\pm(\mathbf{S}(v), 1, n).$$

For each $\widetilde{\mathcal{S}}_i$, let E_i be a minimal cutset in separating $\text{d-hemi}^\pm(i)$ within $\text{d-cyl}(i)$. Let A be the collection of edges in \mathbb{Z}^d having non-empty intersection with

$$(3.23) \quad \mathcal{N}_{5d} \left(n\mathbf{S}(v) \setminus \bigcup_{i=1}^\ell \widetilde{\mathcal{S}}_i \right).$$

By (ii) above, there is $c(d) > 0$ so that $|A| \leq c(d)mn^{d-2}$. We soon take n to infinity, thus we lose no generality supposing n is large enough so that each $\text{d-cyl}(i)$ is contained in d-cyl , and in particular, that each E_i is contained in the edge set of d-cyl across all configurations ω .

The argument of Lemma 3.3 shows that the edges $A \cup \left(\bigcup_{i=1}^\ell E_i \right)$ lying in d-cyl separate d-hemi^\pm in d-cyl . Though there are more boxes in this case, the complexity of the argument does not go up: we can always reduce to the case that our simple path γ last uses any vertex of $\text{d-hemi}^-(i)$ for all

i , and we may also assume γ uses a vertex within some $d\text{-hemi}^+(j)$ at a later point. Between these two points, we find that we must either use an edge in A , or an edge in one of the E_i . Thus,

$$(3.24) \quad \mathfrak{X}(0, v, n) \leq \sum_{i=1}^{\ell} \Xi_{\text{hemi}}(\widetilde{S}_i, m + d^{1/2}, 1) + c(d)mn^{d-2}.$$

The chosen orientation thus far has been arbitrary, so the preceding lemma also applies to $\widetilde{\mathfrak{X}}(0, v, n)$. Take expectations of both sides in (3.24) and apply Lemma 3.2 to each term in the sum of (3.24), using the bound $\ell \leq (k+1)^{d-1}$ from (iii).

$$(3.25) \quad \mathbb{E}_p \mathfrak{X}(0, v, n) \leq \ell \mathbb{E}_p \widetilde{\mathfrak{X}}(0, v, m) + \ell c(d)m^{d-2} + c(d)mn^{d-2},$$

$$(3.26) \quad \leq (k+1)^{d-1} \mathbb{E}_p \widetilde{\mathfrak{X}}(0, v, m) + (k+1)^{d-1} c(d)m^{d-2} + c(d)mn^{d-2}.$$

Divide through by n^{d-1} :

$$(3.27) \quad \frac{\mathbb{E}_p \mathfrak{X}(0, v, n)}{n^{d-1}} \leq (k+1)^{d-1} \frac{\mathbb{E}_p \widetilde{\mathfrak{X}}(0, v, m)}{n^{d-1}} + \frac{(k+1)^{d-1} m^{d-2} c(d)}{n^{d-1}} + \frac{c(d)m}{n},$$

$$(3.28) \quad \leq \left(\frac{k+1}{k}\right)^{d-1} k^{d-1} \cdot \frac{\mathbb{E}_p \widetilde{\mathfrak{X}}(0, v, m)}{n^{d-1}} + \left(\frac{k+1}{k}\right)^{d-1} \left(\frac{k}{n}\right)^{d-1} m^{d-2} c(d) + \frac{c(d)m}{n},$$

$$(3.29) \quad \leq \left(\frac{k+1}{k}\right)^{d-1} \frac{\mathbb{E}_p \widetilde{\mathfrak{X}}(0, v, m)}{m^{d-1}} + \left(\frac{k+1}{k}\right)^{d-1} \frac{c(d)}{m} + \frac{c(d)m}{n}.$$

First take the lim sup of both sides in n ,

$$(3.30) \quad \limsup_{n \rightarrow \infty} \frac{\mathbb{E}_p \mathfrak{X}(0, v, n)}{n^{d-1}} \leq \frac{\mathbb{E}_p \widetilde{\mathfrak{X}}(0, v, m)}{m^{d-1}} + \frac{c(d)}{m},$$

and then the lim inf of both sides in m :

$$(3.31) \quad \limsup_{n \rightarrow \infty} \frac{\mathbb{E}_p \mathfrak{X}(0, v, n)}{n^{d-1}} \leq \liminf_{m \rightarrow \infty} \frac{\mathbb{E}_p \widetilde{\mathfrak{X}}(0, v, m)}{m^{d-1}},$$

and the proof is complete upon dividing both sides by 2^{d-1} : setting $\widetilde{\mathbf{S}} \equiv \mathbf{S}$ gives us the existence of the limit in question, and interchanging $\widetilde{\mathbf{S}}$ and \mathbf{S} in the above argument tells us this limit does not depend on the chosen orientation. The finiteness of this limit can be seen as follows: given a direction $v \in \mathbb{S}^{d-1}$, the collection of edges intersecting the neighborhood $\mathcal{N}_{5d}(n\mathbf{S}(v))$ forms a cutset in $d\text{-cyl}(\mathbf{S}(v), 1, n)$ separating $d\text{-hemi}^\pm(\mathbf{S}(v), 1, n)$ and this cutset has cardinality bounded above by $c(d)n^{d-1}$ for some positive constant $c(d)$ not depending on the direction. \square

We immediately deduce that $\beta_{p,d}$ inherits the symmetries of \mathbb{Z}^d .

Corollary 3.5. *Let $d \geq 2$. For all $v \in \mathbb{S}^{d-1}$ and for all linear transformations $L : \mathbb{R}^d \rightarrow \mathbb{R}^d$ such that $L(\mathbb{Z}^d) = \mathbb{Z}^d$, we have $\beta_{p,d}(Lv) = \beta_{p,d}(v)$.*

Proof. Let $v \in \mathbb{S}^{d-1}$, and let \mathbf{S} be the chosen orientation. Then

$$(3.32) \quad \widetilde{\mathbf{S}}(v) := L^{-1}\mathbf{S}(Lv)$$

is a rotation of $\mathbf{S}(v)$ contained in $\text{hyp}(\mathbf{S}(v))$. From the preceding Proposition 3.4, we know

$$(3.33) \quad \lim_{n \rightarrow \infty} \frac{\mathbb{E}_p \Xi_{\text{hemi}}(\widetilde{\mathbf{S}}(v), 1, n)}{(2n)^{d-1}} = \lim_{n \rightarrow \infty} \frac{\mathbb{E}_p \mathfrak{X}(0, v, n)}{(2n)^{d-1}}.$$

Moreover, because L induces a graph automorphism of \mathbb{Z}^d , we know $\mathbb{E}_p \Xi_{\text{hemi}}(\widetilde{\mathbf{S}}(v), 1, n) = \mathbb{E}_p \mathfrak{X}(0, Lv, n)$, so that

$$(3.34) \quad \lim_{n \rightarrow \infty} \frac{\mathbb{E}_p \mathfrak{X}(0, Lv, n)}{(2n)^{d-1}} = \lim_{n \rightarrow \infty} \frac{\mathbb{E}_p \mathfrak{X}(0, v, n)}{(2n)^{d-1}},$$

as desired. \square

3.4. The chosen orientation and properties of $\beta_{p,d}$. Defining $\beta_{p,d}$ using cylinders based at squares (instead of discs, for instance) allows us to execute subadditivity arguments with ease. There is a tradeoff between the tidiness of these arguments and the artificial nature of the chosen orientation; we feel we have taken the route which is ultimately cleanest. Part of this tradeoff is that \mathbf{S} must vary over most of the sphere in a Lipschitz way. Given an \mathbf{S} and $A \subset \mathbb{S}^{d-1}$, say \mathbf{S} is *nicely varying over A* if there is $M(d) > 0$ so that \mathbf{S} satisfies

$$(3.35) \quad d_H(\mathbf{S}(v), \mathbf{S}(w)) \leq M\epsilon$$

whenever $|v - w|_2 < \epsilon$ and $v, w \in A$. Here d_H is defined in (2.9). For \mathbf{S} nicely varying on \mathbb{S}^{d-1} , one can show the functions $v \mapsto \mathbb{E}_p \mathfrak{X}(0, v, n)/(2n)^{d-1}$ converge uniformly to $\beta_{p,d}$, allowing us to prove concentration estimates in Section 4.

For topological reasons (the hairy ball theorem) it is not in general possible to have \mathbf{S} vary nicely over the entire sphere. However, it will suffice to work with \mathbf{S} varying nicely over the upper and lower hemispheres of \mathbb{S}^{d-1} . Introduce the closed upper hemisphere $\mathbb{S}_+^{d-1} := \mathbb{S}^{d-1} \cap \{x \in \mathbb{R}^d : x_d \geq 0\}$. A corollary of Proposition A.16 is that we may first define \mathbf{S} over \mathbb{S}_+^{d-1} so that \mathbf{S} is nicely varying over \mathbb{S}_+^{d-1} . With such \mathbf{S} defined on the upper hemisphere, extend the definition of \mathbf{S} to the rest of \mathbb{S}^{d-1} in a natural way by reflection. This yields \mathbf{S} which varies nicely over \mathbb{S}_+^{d-1} and $\mathbb{S}^{d-1} \setminus \mathbb{S}_+^{d-1}$. Henceforth we suppose \mathbf{S} has these two properties.

Proposition 3.6. *Let $d \geq 2$, $p > p_c(d)$ and suppose \mathbf{S} varies nicely over \mathbb{S}_+^{d-1} and $\mathbb{S}^{d-1} \setminus \mathbb{S}_+^{d-1}$. Then the functions $v \mapsto \mathbb{E}_p \mathfrak{X}(0, v, n)/(2n)^{d-1}$ converge uniformly to $\beta_{p,d}$.*

Proof. Let $\epsilon > 0$, Let $v, w \in \mathbb{S}_+^{d-1}$ be such that $|v - w|_2 < \epsilon$. Let us fix some notation:

$$(3.36) \quad \text{cyl}(v) := n \text{cyl}(\mathbf{S}(v), 1),$$

$$(3.37) \quad \text{d-cyl}(v) := \text{d-cyl}(\mathbf{S}(v), 1, n),$$

$$(3.38) \quad \text{d-hemi}^\pm(v) := \text{d-hemi}^\pm(\mathbf{S}(v), 1, n),$$

$$(3.39) \quad \text{cyl}(w) := \lceil n(1 + M\epsilon) \rceil \text{cyl}(\mathbf{S}(w), 1),$$

$$(3.40) \quad \text{d-cyl}(w) := \text{d-cyl}(\mathbf{S}(w), 1, \lceil n(1 + M\epsilon) \rceil),$$

$$(3.41) \quad \text{d-hemi}^\pm(w) := \text{d-hemi}^\pm(\mathbf{S}(w), 1, \lceil n(1 + M\epsilon) \rceil).$$

Let E be a minimal cutset separating $\text{d-hemi}^\pm(v)$ in $\text{d-cyl}(v)$. By the hypothesis on \mathbf{S} , $\text{cyl}(v) \subset \text{cyl}(w)$, and E is contained in the edge set of $\text{d-cyl}(w)$. As before, we use E in conjunction with a small collection of edges to produce a cut separating the hemispheres of $\text{d-cyl}(w)$. We actually use two other collections of edges to do this.

Writing $\text{hyp}(w)$ for $\text{hyp}(\lceil n(1 + M\epsilon) \rceil \mathbf{S}(w))$, we define the edge set A as in Lemma 3.2 to be the edges of \mathbb{Z}^d intersecting the neighborhood

$$(3.42) \quad \mathcal{N}_{5d}((\text{cyl}(w) \setminus \text{cyl}(v)) \cap \text{hyp}(w)).$$

Likewise, let B be the collection of edges having non-empty intersection with

$$(3.43) \quad \mathcal{N}_{5d}(\partial \text{cyl}(v) \cap \text{slab}(\mathbf{S}(v), nM\epsilon)) .$$

Here we suppose that ϵ is small enough so that $\text{slab}(\mathbf{S}(v), nM\epsilon)$ does not contain the top and bottom faces of the cube $\text{cyl}(v)$. The neighborhood (3.43) is thus slight thickening of an equatorial band of height $nM\epsilon$ in $\partial \text{cyl}(v)$, and it follows that $|B| \leq c(d)M\epsilon n^{d-1}$ for some $c(d) > 0$.

The neighborhood (3.42) forms a bridge between the neighborhood (3.43) defining B and the equator of the larger cube $\text{cyl}(w)$. By construction, we also have $|A| \leq c(d)M\epsilon n^{d-1}$ for some $c(d) > 0$. Figure 7 illustrates the cutset E with the edge sets A and B .

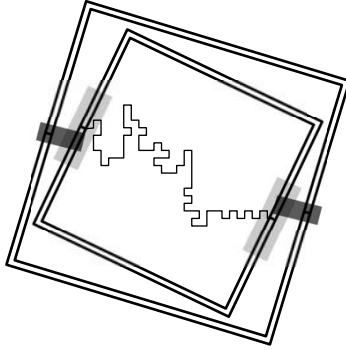

FIGURE 7. The cutset E in the smaller cube $\text{cyl}(v)$ is central. At the equator of $\text{cyl}(v)$, this cutset meets with the edge set B , the lightly shaded regions. B is joined to the equator of the larger cube $\text{cyl}(w)$ by A , the darker shaded regions.

The edges of the union $E \cup A \cup B$ contained in $d\text{-cyl}(w)$ form a cutset separating the hemispheres $d\text{-hemi}^\pm(w)$. The argument for this is nearly identical to the proof of Lemma 3.3. Indeed, we are looking at nested cubes, with the only difference that one is tilted slightly relative to the other. This tilt is why B is introduced. Thus,

$$(3.44) \quad \mathfrak{X}(0, w, \lceil n(1 + M\epsilon) \rceil) \leq \mathfrak{X}(0, v, n) + c(d)M\epsilon n^{d-1} ,$$

so that by taking expectations,

$$(3.45) \quad \frac{\mathbb{E}_p \mathfrak{X}(0, w, \lceil n(1 + M\epsilon) \rceil)}{(2\lceil n(1 + M\epsilon) \rceil)^{d-1}} \leq \frac{\mathbb{E}_p \mathfrak{X}(0, v, n)}{(2n)^{d-1}} + c(d)M\epsilon .$$

Taking $n \rightarrow \infty$, we have shown when $v, w \in \mathbb{S}_+^{d-1}$ satisfy $|v - w|_2 < \epsilon$,

$$(3.46) \quad |\beta_{p,d}(v) - \beta_{p,d}(w)| < c(d)M\epsilon .$$

A symmetric argument shows the same bounds hold when $v, w \in \mathbb{S}_+^{d-1} \setminus \mathbb{S}_+^{d-1}$ and $|v - w|_2 < \epsilon$.

Choose a finite collection of unit vectors $\{v_i\}_{i=1}^m$ (with $m = m(\epsilon)$), so that for any $v \in \mathbb{S}_+^{d-1}$, there is $v_i \in \mathbb{S}_+^{d-1}$ with $|v - v_i|_2 < \epsilon$, and if $v \in \mathbb{S}_+^{d-1} \setminus \mathbb{S}_+^{d-1}$, there is $v_i \in \mathbb{S}_+^{d-1} \setminus \mathbb{S}_+^{d-1}$ with $|v - v_i|_2 < \epsilon$. Take N large enough so that whenever $n \geq N$, for each i ,

$$(3.47) \quad \left| \frac{\mathbb{E}_p \mathfrak{X}(0, v_i, n)}{(2n)^{d-1}} - \beta_{p,d}(v_i) \right| < \epsilon .$$

Let $v \in \mathbb{S}^{d-1}$ and take v_i in the same hemisphere so that $|v - v_i|_2 < \epsilon$. Apply (3.45) twice:

$$(3.48) \quad \frac{\mathbb{E}_p \mathfrak{X}(0, v_i, \lceil n(1 + M\epsilon) \rceil (1 + M\epsilon))}{(2 \lceil n(1 + M\epsilon) \rceil (1 + M\epsilon))^{d-1}} - c(d)M\epsilon \leq \frac{\mathbb{E}_p \mathfrak{X}(0, v, \lceil n(1 + M\epsilon) \rceil)}{(2 \lceil n(1 + M\epsilon) \rceil)^{d-1}}$$

$$(3.49) \quad \leq \frac{\mathbb{E}_p \mathfrak{X}(0, v_i, n)}{(2n)^{d-1}} + c(d)M\epsilon.$$

By (3.46), we have

$$(3.50) \quad \beta_p(v) - \epsilon - 2c(d)M\epsilon \leq \frac{\mathbb{E}_p \mathfrak{X}(0, v, \lceil n(1 + M\epsilon) \rceil)}{(2 \lceil n(1 + M\epsilon) \rceil)^{d-1}} \leq \beta_p(v) + \epsilon + 2c(d)M\epsilon,$$

which establishes the desired uniform convergence. \square

Extend $\beta_{p,d}$ to a function on all of \mathbb{R}^d via homogeneity; for $x \in \mathbb{R}^d$ define

$$(3.51) \quad \beta_{p,d}(x) := \begin{cases} |x|_2 \beta_{p,d}(x/|x|_2) & |x|_2 > 0 \\ 0 & |x|_2 = 0 \end{cases}.$$

Proposition 3.7. *For $d \geq 2$ and $p > p_c(d)$, the function $\beta_{p,d} : \mathbb{R}^d \rightarrow [0, \infty)$ defines a norm on \mathbb{R}^d .*

Proof. The proof of Proposition 11.6 in [16] (or Proposition 4.5 of [54]) tells us that $\beta_{p,d}$ satisfies the weak triangle inequality. By Corollary 11.7 of [16], $\beta_{p,d}$ is a convex function on \mathbb{R}^d . To show non-degeneracy of $\beta_{p,d}$, it suffices to show non-degeneracy in the cardinal directions. By Corollary 3.5, it suffices to show non-degeneracy in a single cardinal direction.

This non-degeneracy is a consequence of Theorem 7.68 in [34], for instance: within a large axis-parallel cube, with high probability, there are at least cn^{d-1} edge-disjoint open paths between the top and bottom faces, for some $c(p, d) > 0$. Menger's theorem converts this fact into a high probability lower bound on the size of a minimal cut separating opposing faces of this cube. \square

Remark 3.8. That $\beta_{p,d}$ is a norm allows us to define the associated surface energy $\mathcal{I}_{p,d}$, as in Section 2, as well as the unit Wulff crystal $\widehat{W}_{p,d}$, which is the unit ball in the norm dual to $\beta_{p,d}$. Define the *Wulff crystal* $W_{p,d}$ to be the dilate of $\widehat{W}_{p,d}$ about the origin so that $\mathcal{L}^d(W_{p,d}) = 2^d/d!$. The Wulff crystal $W_{p,d}$ is the limit shape appearing in Theorem 1.2. So that this theorem makes sense, we must know that $W_{p,d}$ is contained in $[-1, 1]^d$.

Lemma 3.9. *For $d \geq 2$ and $p > p_c(d)$, the Wulff crystal $W_{p,d}$ is contained in $[-1, 1]^d$.*

Proof. By Corollary 3.5, the unit Wulff crystal $\widehat{W}_{p,d}$ satisfies

$$(3.52) \quad cB_1 \subset \widehat{W}_{p,d} \subset cB_\infty$$

for some $c > 0$, where B_1 and B_∞ respectively denote unit ℓ^1 - and unit ℓ^∞ -balls in \mathbb{R}^d centered at the origin. The claim follows from the fact that $\mathcal{L}^d(B_1) = 2^d/d!$. \square

Remark 3.10. We may use $\mathcal{I}_{p,d}$ to define an analogous notion of conductance in the continuum: for $E \subset \mathbb{R}^d$ a set of finite perimeter, we define the *conductance* of E as $\mathcal{I}_{p,d}(E)/\theta_p(d)\mathcal{L}^d(E)$.

4. CONCENTRATION ESTIMATES FOR $\beta_{p,d}$

We now derive concentration estimates for the random variables used to define $\beta_{p,d}$, following an argument of Zhang in Section 9 of [64]. We use results from his paper in conjunction with the following concentration estimate due to Talagrand.

Theorem 4.1. (Talagrand [56], Section 8.3) *Let (V, E) be a finite graph with $\{X_e\}_{e \in E}$ a collection of iid Bernoulli(p) random variables. Let \mathcal{S} denote a family of sets of edges and for $S \in \mathcal{S}$, let $X_S := \sum_{e \in S} X_e$. Let $Z_S := \inf_{S \in \mathcal{S}} X_S$, and let M_S be a median of Z_S . There is $c(p) > 0$ so that for all $u > 0$,*

$$(4.1) \quad \mathbb{P}_p(|Z_S - M_S| \geq u) \leq 4 \exp\left(-c \min\left(\frac{u^2}{\alpha}, u\right)\right),$$

where $\alpha = \sup_{S \in \mathcal{S}} |S|$.

Remark 4.2. The random variables Ξ_{hemi} and Ξ_{face} are easily expressed as Z_S for some family of edge sets \mathcal{S} , but use of Theorem 4.1 requires control over the size of the largest edge set in \mathcal{S} through the term α . We must then control the size of the largest minimal cut separating opposing hemispheres (or faces) of a cube.

Remark 4.3. The chosen orientation \mathbf{S} , introduced in the previous section, has been fixed since the beginning of Section 3.4. Following Zhang in [64], we use Theorem 4.1 to prove concentration for a variant of the $\mathfrak{X}(0, v, n)$.

Let $\gamma > 0$, and let $\mathcal{S}_{n,v}(\gamma)$ be the family of cutsets in $\text{d-cyl}(\mathbf{S}(v), 1, n)$ satisfying $|S| \leq \gamma(2n)^{d-1}$, and which separate $\text{d-hemi}^\pm(\mathbf{S}(v), 1, n)$. Define $Z_{n,v}^{(\gamma)}(\omega) := \inf_{S \in \mathcal{S}_{n,v}(\gamma)} |S|_\omega$, and apply Theorem 4.1 to $Z_{n,v}^{(\gamma)}$, using the bound $\alpha \leq \gamma(2n)^{d-1}$.

Proposition 4.4. *Let $\epsilon, \gamma > 0$. There are $c_1(p, \gamma, \epsilon), c_2(p, \gamma, \epsilon) > 0$ so that for all $v \in \mathbb{S}^{d-1}$ and $n \geq 1$*

$$(4.2) \quad \mathbb{P}_p\left(\frac{|Z_{n,v}^{(\gamma)} - \mathbb{E}_p Z_{n,v}^{(\gamma)}|}{(2n)^{d-1}} \geq \epsilon\right) \leq c_1 \exp(-c_2 n^{(d-1)/3}).$$

Proof. We follow the argument at the beginning of Section 9 in [64]. Write $A = A(n) := (2n)^{d-1}$ for the \mathcal{H}^{d-1} -measure (or ‘‘area’’) of the square $n\mathbf{S}(v)$. Let $M_{n,v}^{(\gamma)}$ be a median of $Z_{n,v}^{(\gamma)}$. Then,

$$(4.3) \quad |\mathbb{E}_p Z_{n,v}^{(\gamma)} - M_{n,v}^{(\gamma)}| \leq \mathbb{E}_p |Z_{n,v}^{(\gamma)} - M_{n,v}^{(\gamma)}|,$$

$$(4.4) \quad \leq \sum_{j=1}^{\lfloor A^{2/3} \rfloor} \mathbb{P}_p(|Z_{n,v}^{(\gamma)} - M_{n,v}^{(\gamma)}| \geq j) + \sum_{j=\lceil A^{2/3} \rceil}^{\infty} \mathbb{P}_p(|Z_{n,v}^{(\gamma)} - M_{n,v}^{(\gamma)}| \geq j).$$

Apply Theorem 4.1 with $\alpha \leq \gamma A$ to the right-most sum above:

$$(4.5) \quad |\mathbb{E}_p Z_{n,v}^{(\gamma)} - M_{n,v}^{(\gamma)}| \leq A^{2/3} + 4 \left(\sum_{j=\lceil A^{4/3} \rceil}^{\infty} \exp\left(-c \frac{j}{\gamma A}\right) + \sum_{j=\lceil A^{2/3} \rceil}^{\infty} \exp(-cj) \right),$$

$$(4.6) \quad \leq A^{2/3} + \frac{4}{1 - \exp(-c/\gamma A)} \exp(-cA^{1/3}/\gamma) + \frac{4}{1 - \exp(-c)} \exp(-cA^{2/3}).$$

For n large depending on p and γ , $|\mathbb{E}_p Z_{n,v}^{(\gamma)} - M_{n,v}^{(\gamma)}| \leq (3/2)A^{2/3}$. Use the triangle inequality to conclude that,

$$(4.7) \quad \mathbb{P}_p(|Z_{n,v}^{(\gamma)} - \mathbb{E}_p Z_{n,v}^{(\gamma)}| \geq 4A^{2/3}) \leq \mathbb{P}_p(|Z_{n,v}^{(\gamma)} - M_{n,v}^{(\gamma)}| + |M_{n,v}^{(\gamma)} - \mathbb{E}_p Z_{n,v}^{(\gamma)}| \geq 4A^{2/3}),$$

$$(4.8) \quad \leq \mathbb{P}_p(|Z_{n,v}^{(\gamma)} - M_{n,v}^{(\gamma)}| \geq 2A^{2/3}).$$

Use Theorem 4.1 again to complete the proof:

$$(4.9) \quad \mathbb{P}_p(|Z_{n,v}^{(\gamma)} - \mathbb{E}_p Z_{n,v}^{(\gamma)}| \geq 4A^{2/3}) \leq 4 \exp\left(-c \min\left(\frac{4}{\gamma}A^{1/3}, 2A^{2/3}\right)\right).$$

□

To use Proposition 4.4 on the $\mathfrak{X}(0, v, n)$, we need the following input. For a percolation configuration ω , let $N_{n,v}(\omega)$ denote the minimum cardinality $|S|$ over all cutsets S in $\text{d-cyl}(\mathbf{S}(v), 1, n)$ separating $\text{d-hemi}^\pm(\mathbf{S}(v), 1, n)$ such that $|S|_\omega = [\mathfrak{X}(0, v, n)](\omega)$.

Proposition 4.5. (Rossignol-Théret [54], Proposition 4.2) *Let $d \geq 2$ and let $p > p_c(d)$. There are positive constants $\gamma(p, d)$, $c_1(p, d)$ and $c_2(p, d)$ so that for all $u > 0$, all $v \in \mathbb{S}^{d-1}$ and all $n \geq 1$,*

$$(4.10) \quad \mathbb{P}_p(N_{n,v} \geq \gamma u \text{ and } \mathfrak{X}(0, v, n) \leq u) \leq c_1 \exp(-c_2 u).$$

Using Proposition 4.5 with Proposition 4.4, we deduce the following.

Corollary 4.6. *Let $d \geq 2$, $p > p_c(d)$, $v \in \mathbb{S}^{d-1}$ and let $\epsilon > 0$. There are positive constants $c_1(p, d, \epsilon)$ and $c_2(p, d, \epsilon)$ so that for all $n \geq 1$,*

$$(4.11) \quad \mathbb{P}_p\left(\frac{|\mathfrak{X}(0, v, n) - \mathbb{E}_p \mathfrak{X}(0, v, n)|}{(2n)^{d-1}} \geq \epsilon\right) \leq c_1 \exp(-c_2 n^{(d-1)/3}).$$

Proof. As remarked at the end of the proof of Proposition 3.4, uniformly in $v \in \mathbb{S}^{d-1}$ and all configurations ω , $[\mathfrak{X}(0, v, n)](\omega) \leq c(d)n^{d-1}$ for some $c(d) > 0$. Apply Proposition 4.5 with $u = c(d)n^{d-1}$ to obtain $\gamma(p, d)$ so that

$$(4.12) \quad \mathbb{P}_p(N_{n,v} \geq \gamma c(d)n^{d-1}) \leq c_1 \exp(-c_2 c(d)n^{d-1}).$$

We use this bound shortly. For this γ and for $\epsilon > 0$, use Proposition 4.4 to obtain $c_1(p, \gamma, \epsilon)$, $c_2(p, \gamma, \epsilon) > 0$ so that

$$(4.13) \quad \mathbb{P}_p\left(\frac{|\mathfrak{X}(0, v, n) - \mathbb{E}_p \mathfrak{X}(0, v, n)|}{(2n)^{d-1}} \geq \epsilon\right) \leq \mathbb{P}_p(Z_{n,v}^{(\gamma)} \neq \mathfrak{X}(0, v, n)) + \mathbb{P}_p\left(\frac{|Z_{n,v}^{(\gamma)} - \mathbb{E}_p Z_{n,v}^{(\gamma)}|}{(2n)^{d-1}} \geq \epsilon\right),$$

$$(4.14) \quad \leq \mathbb{P}_p(Z_{n,v}^{(\gamma)} \neq \mathfrak{X}(0, v, n)) + c_1 \exp(-c_2 n^{(d-1)/3}).$$

As $\{Z_{n,v}^{(\gamma)} \neq \mathfrak{X}(0, v, n)\} \subset \{N_{n,v} \geq \gamma c(d)n^{d-1}\}$, (4.12) implies

$$(4.15) \quad \mathbb{P}_p\left(\frac{|\mathfrak{X}(0, v, n) - \mathbb{E}_p \mathfrak{X}(0, v, n)|}{(2n)^{d-1}} \geq \epsilon\right) \leq \mathbb{P}_p(N_{n,v} \geq \gamma c(d)n^{d-1}) + c_1 \exp(-c_2 n^{(d-1)/3}),$$

$$(4.16) \quad \leq c_1 \exp(-c_2 c(d)n^{d-1}) + c_1 \exp(-c_2 n^{(d-1)/3}).$$

The proof is complete. □

We obtain the desired concentration estimates by combining Corollary 4.6 with Proposition 3.6. The following is the main result of the section.

Theorem 4.7. *Let $d \geq 2$, $p > p_c(d)$, and let $\epsilon > 0$. There are positive constants $c_1(p, d, \epsilon)$, $c_2(p, d, \epsilon)$ so that for all $x \in \mathbb{R}^d$, $v \in \mathbb{S}^{d-1}$, and all $r > 0$,*

$$(4.17) \quad \mathbb{P}_p \left(\left| \frac{\mathfrak{X}(x, v, r)}{(2n)^{d-1}} - \beta_{p,d}(v) \right| \geq \epsilon \right) \leq c_1 \exp(-c_2 r^{(d-1)/3}).$$

Proof. We first prove (4.17) in the case that $x = 0$ and $r = n \in \mathbb{N}$. Use Proposition 3.6 to choose $n_0(\epsilon)$ large so that for all $v \in \mathbb{S}^{d-1}$, $n \geq n_0$ implies

$$(4.18) \quad \left| \frac{\mathbb{E}_p \mathfrak{X}(0, v, n)}{(2n)^{d-1}} - \beta_{p,d}(v) \right| < \epsilon/2.$$

For $n \geq n_0$,

$$(4.19) \quad \mathbb{P}_p \left(\left| \frac{\mathfrak{X}(0, v, n)}{(2n)^{d-1}} - \beta_{p,d}(v) \right| \geq \epsilon \right) \leq \mathbb{P}_p \left(\frac{|\mathfrak{X}(0, v, n) - \mathbb{E}_p \mathfrak{X}(0, v, n)|}{(2n)^{d-1}} + \left| \frac{\mathbb{E}_p \mathfrak{X}(0, v, n)}{(2n)^{d-1}} - \beta_{p,d}(v) \right| \geq \epsilon \right),$$

$$(4.20) \quad \leq \mathbb{P}_p \left(\frac{|\mathfrak{X}(0, v, n) - \mathbb{E}_p \mathfrak{X}(0, v, n)|}{(2n)^{d-1}} \geq \epsilon/2 \right),$$

and (4.17) is shown to hold by applying Corollary 4.6 to the right-hand side.

Now consider general x and r ; we claim that for any $r > 0$ and $x \in \mathbb{R}^d$, there is $c(d) > 0$ so that

$$(4.21) \quad \mathfrak{X}(x, v, \lceil r \rceil) - c(d)r^{d-2} \leq \mathfrak{X}(x, v, r) \leq \mathfrak{X}(x, v, \lfloor r \rfloor) + c(d)r^{d-2}.$$

To see this, let A be the collection of edges having non-empty intersection with

$$(4.22) \quad \mathcal{N}_{5d}(r\mathbf{S}(v) \setminus \lfloor r \rfloor \mathbf{S}(v)),$$

and let E be a minimal cutset in $d\text{-cyl}(\mathbf{S}(v), 1, \lfloor r \rfloor)$ separating $d\text{-hemi}^\pm(\mathbf{S}(v), 1, \lfloor r \rfloor)$. The now standard argument from Lemma 3.3 tells us the edges of $E \cup A$ contained in $d\text{-cyl}(\mathbf{S}(v), 1, r)$ separate $d\text{-hemi}^\pm(\mathbf{S}(v), 1, r)$. That $|A| \leq c(d)r^{d-2}$ establishes the upper bound on $\mathfrak{X}(0, v, r)$ in (4.21), and we obtain the lower bound through a similar procedure.

The proof of Lemma 3.2 tells us that for $x \in \mathbb{R}^d$ and $r > 0$, there exists $x' \in \mathbb{Z}^d$ so that

$$(4.23) \quad \mathfrak{X}(x', v, r + d^{1/2}) - c(d)r^{d-2} \leq \mathfrak{X}(x, v, r) \leq \mathfrak{X}(x', v, r - d^{1/2}) + c(d)r^{d-2}.$$

Apply (4.21) to conclude

$$(4.24) \quad \mathfrak{X}(x', v, \lceil r + d^{1/2} \rceil) - c(d)r^{d-2} \leq \mathfrak{X}(x, v, r) \leq \mathfrak{X}(x', v, \lfloor r - d^{1/2} \rfloor) + c(d)r^{d-2}.$$

As $x' \in \mathbb{Z}^d$, the variables $\mathfrak{X}(x', v, \lceil r + d^{1/2} \rceil)$ and $\mathfrak{X}(x', v, \lfloor r - d^{1/2} \rfloor)$ have the same law as $\mathfrak{X}(0, v, \lceil r + d^{1/2} \rceil)$ and $\mathfrak{X}(0, v, \lfloor r - d^{1/2} \rfloor)$ respectively, so concentration estimates (4.17) established in the case $x = 0$ and $r = n \in \mathbb{N}$ hold for these variables as well. Within the high probability event

$$(4.25) \quad \left\{ \left| \frac{\mathfrak{X}(x', v, \lceil r + d^{1/2} \rceil)}{(2 \lceil r + d^{1/2} \rceil)^{d-1}} - \beta_{p,d}(v) \right| < \epsilon \right\} \cap \left\{ \left| \frac{\mathfrak{X}(x', v, \lfloor r - d^{1/2} \rfloor)}{(2 \lfloor r - d^{1/2} \rfloor)^{d-1}} - \beta_{p,d}(v) \right| < \epsilon \right\},$$

and for r taken large depending on ϵ and d , we obtain

$$(4.26) \quad \beta_{p,d}(v) - 3\epsilon \leq \frac{\mathfrak{X}(x, v, r)}{(2r)^{d-1}} \leq \beta_{p,d}(v) + 3\epsilon,$$

completing the proof. □

5. CONSEQUENCES OF CONCENTRATION ESTIMATES

We now derive important consequences of Theorem 4.7. In Section 5.1, we obtain information about the random variables Ξ_{hemi} and Ξ_{face} for cylinders with small height, a crucial input for Section 9. In Section 5.2, we show any polytope $P \subset [-1, 1]^d$ satisfying $\mathcal{L}^d(P) \leq 2^d/d!$ gives an upper bound on $\widehat{\Phi}_n$. Specializing these results to a sequence of polytopes which are progressively better approximates of the Wulff crystal, we obtain the easier half of Theorem 1.3.

5.1. Lower bounds for cuts in thin cylinders. We apply our concentration estimates to random variables Ξ_{face} for cylinders of small height. It is important to recall the convention established in Remark 3.1. Throughout this section, adopt the notation $\mathbf{S}(x, v) := \mathbf{S}(v) + x$.

Lemma 5.1. *Let $d \geq 2$, $p > p_c(d)$ and let $\epsilon > 0$. There exists $\eta(p, d, \epsilon) > 0$ small and positive constants $c_1(p, d, \epsilon)$, $c_2(p, d, \epsilon)$ so that for all $x \in \mathbb{R}^d$, all $v \in \mathbb{S}^{d-1}$, $h \in (0, \eta)$, and $r > 0$ taken sufficiently large depending on h , we have*

$$(5.1) \quad \mathbb{P}_p \left(\Xi_{\text{face}}(\mathbf{S}(x, v), h, r) \leq (1 - \epsilon) \mathcal{H}^{d-1}(r\mathbf{S}(x, v)) \beta_{p,d}(v) \right) \leq c_1 \exp \left(-c_2 r^{(d-1)/3} \right).$$

Proof. Write S for $\mathbf{S}(x, v)$ and consider a minimal cutset E in $\text{d-cyl}(S, h, r)$ separating $\text{d-face}^\pm(S, h, r)$. Recall that S_h^+ and S_h^- are the top and bottom faces of the cylinder $\text{cyl}(S, h)$, and consider the collection of edges A which intersect

$$(5.2) \quad \mathcal{N}_{5d}(r(\partial \text{cyl}(S, h) \setminus (S_h^+ \cup S_h^-))).$$

The edges of $E \cup A$ contained in $\text{d-cyl}(S, h, r)$ separate $\text{d-hemi}^\pm(S, h, r)$ within $\text{d-cyl}(S, h, r)$, and hence also $\text{d-hemi}^\pm(S, 1, r)$ in the larger cylinder $\text{d-cyl}(S, 1, r)$, provided that h and r are suitable for S in the sense of Remark 3.1. It is for this reason we must take r large depending on h . By construction, the cardinality of A is at most $c(d)hr^{d-1}$ for some $c(d) > 0$, and

$$(5.3) \quad \mathfrak{X}(x, v, r) \leq \Xi_{\text{face}}(S, h, r) + c(d)hr^{d-1}.$$

Thus,

$$(5.4) \quad \left\{ \Xi_{\text{face}}(S, h, r) \leq (1 - \epsilon) \mathcal{H}^{d-1}(rS) \beta_{p,d}(v) \right\} \subset \left\{ \mathfrak{X}(x, v, r) \leq (1 - \epsilon) \mathcal{H}^{d-1}(rS) \beta_{p,d}(v) + c(d)hr^{d-1} \right\},$$

$$(5.5) \quad \subset \left\{ \mathfrak{X}(x, v, r) \leq (1 - \epsilon/2) \mathcal{H}^{d-1}(rS) \beta_{p,d}(v) \right\},$$

where h is chosen small depending on p, d, ϵ to obtain the second line directly above. We complete the proof by applying Theorem 4.7 to the event on the second line. \square

We now prove the analogue of Lemma 5.1 for cylinders of small height based at discs.

Proposition 5.2. *Let $d \geq 2$, $p > p_c(d)$ and let $\epsilon > 0$. Given $x \in \mathbb{R}^d$ and $v \in \mathbb{S}^{d-1}$, let $D(x, v)$ be the isometric image of the unit Euclidean ball in \mathbb{R}^{d-1} centered at x and oriented so that $\text{hyp}(D(x, v))$ is orthogonal to v . There is $\eta(p, d, \epsilon) > 0$ small and positive constants $c_1(p, d, \epsilon)$ and $c_2(p, d, \epsilon)$ so that for all $x \in \mathbb{R}^d$, $v \in \mathbb{S}^{d-1}$, $h \in (0, \eta)$ and $r > 0$ sufficiently large depending on h , we have*

$$(5.6) \quad \mathbb{P}_p \left(\Xi_{\text{face}}(D(x, v), h, r) \leq (1 - \epsilon) \mathcal{H}^{d-1}(rD(x, v)) \beta_{p,d}(v) \right) \leq c_1 \exp \left(-c_2 r^{(d-1)/3} \right).$$

Proof. Figure 6 captures the idea of this proof: we tile the disc with a collection of small, nearly exhaustive squares. Let $\epsilon' > 0$, write $D = D(x, \nu)$ and let $D' := \{x \in \mathbb{R}^{d-1} : |x|_2 \leq 1\}$. Let $\varphi : D' \rightarrow \mathbb{R}^d$ be an isometry taking D' to D and let $\Delta^k \equiv \Delta^{k,d-1}$ be the dyadic squares in $[-1, 1]^{d-1}$ at scale k . Choose $k \in \mathbb{N}$ large enough (depending on ϵ' and d) so that

$$(5.7) \quad \mathcal{L}^{d-1} \left(D' \setminus \bigcup_{S' \in \Delta^k, S' \subset D'} S' \right) \leq \epsilon' \mathcal{L}^{d-1}(D'),$$

and enumerate the squares $S' \in \Delta^k$ with $S' \subset D'$ as S'_1, \dots, S'_m . The number m of these squares depends on ϵ' and d . Shrink each square slightly to form a new disjoint collection $\{S''_i\}_{i=1}^m$ of closed squares. Specifically, S''_i shall be the $(1 - \delta)$ -dilate of S'_i about its center for some $\delta \in (0, 1)$. For each i , define $S_i := \varphi(S''_i)$ and choose δ small enough (also depending on ϵ' and d) so that

$$(5.8) \quad \mathcal{H}^{d-1} \left(D \setminus \bigcup_{i=1}^m S_i \right) \leq 2\epsilon' \mathcal{H}^{d-1}(D).$$

We arrange that the isometry φ is compatible with the chosen orientation, in that for each i , $S_i = \alpha \mathbf{S}(y_i, \nu)$ for some $y_i \in \mathbb{R}^d$, where $\alpha := (1 - \delta)2^{-k}$. Let $\epsilon > 0$, choose $\eta = \eta(p, d, \epsilon/2)$ as in Lemma 5.1 and let $h \in (0, \alpha\eta)$.

Let E be a minimal cutset separating $\text{d-face}^\pm(D, h, r)$ within $\text{d-cyl}(D, h, r)$. Let E_i denote the edges of E lying in edge set of $\text{d-cyl}(S_i, h, r)$. Each E_i separates $\text{d-face}^\pm(S_i, h, r)$ within $\text{d-cyl}(S_i, h, r)$, so by the disjointness of the $\{S_i\}_{i=1}^m$, we have

$$(5.9) \quad \sum_{i=1}^m \Xi_{\text{face}}(S_i, h, r) \leq \Xi_{\text{face}}(D, h, r),$$

and thus,

$$(5.10) \quad \mathbb{P}_p \left(\Xi_{\text{face}}(D, h, r) \leq (1 - \epsilon) \mathcal{H}^{d-1}(rD) \beta_{p,d}(\nu) \right)$$

$$(5.11) \quad \leq \mathbb{P}_p \left(\sum_{i=1}^m \Xi_{\text{face}}(S_i, h, r) \leq (1 - \epsilon) \mathcal{H}^{d-1}(rD) \beta_{p,d}(\nu) \right),$$

$$(5.12) \quad \leq \mathbb{P}_p \left(\sum_{i=1}^m \Xi_{\text{face}}(S_i, h, r) \leq \frac{(1 - \epsilon)}{1 - 2\epsilon'} \sum_{i=1}^m \mathcal{H}^{d-1}(rS_i) \beta_{p,d}(\nu) \right),$$

with (5.12) following from our choice of δ and the squares S'_i . As $\mathcal{H}^{d-1}(rS_i)$ is the same for each i , a union bound gives

$$(5.13) \quad \mathbb{P}_p \left(\Xi_{\text{face}}(D, h, r) \leq (1 - \epsilon) \mathcal{H}^{d-1}(rD) \beta_{p,d}(\nu) \right)$$

$$(5.14) \quad \leq \sum_{i=1}^m \mathbb{P}_p \left(\Xi_{\text{face}}(S_i, h, r) \leq \left(\frac{1 - \epsilon}{1 - 2\epsilon'} \right) \beta_{p,d}(\nu) \mathcal{H}^{d-1}(rS_i) \right),$$

$$(5.15) \quad \leq \sum_{i=1}^m \mathbb{P}_p \left(\Xi_{\text{face}}(S_i, h, r) \leq (1 - \epsilon/2) \beta_{p,d}(\nu) \mathcal{H}^{d-1}(rS_i) \right).$$

To obtain (5.15), we have taken ϵ' small enough so that $1 - \epsilon/2 > \frac{1 - \epsilon}{1 - 2\epsilon'}$. Thus, m and α now depend on ϵ and d . Use that φ was chosen to be compatible with the chosen orientation \mathbf{S} , writing each S_i

as $\alpha\mathbf{S}(y_i, v)$ for some y_i . Making this switch in (5.15), we find

$$(5.16) \quad \mathbb{P}_p\left(\Xi_{\text{face}}(D, h, r) \leq (1 - \epsilon)\mathcal{H}^{d-1}(rD)\beta_{p,d}(v)\right)$$

$$(5.17) \quad \leq \sum_{i=1}^m \mathbb{P}_p\left(\Xi_{\text{face}}(\mathbf{S}(y_i, v), h/\alpha, \alpha r) \leq (1 - \epsilon/2)\beta_{p,d}(v)\mathcal{H}^{d-1}(\alpha r\mathbf{S}(y_i, v))\right).$$

Having chosen h so that $h/\alpha \leq \eta$, we apply Lemma 5.1 to each summand directly above, using αr in place of r and $\epsilon/2$ in place of ϵ in the statement of this lemma:

$$(5.18) \quad \mathbb{P}_p\left(\Xi_{\text{face}}(D, h, r) \leq (1 - \epsilon)\mathcal{H}^{d-1}(rD)\beta(v)\right) \leq mc_1 \exp\left(-c_2(\alpha r)^{(d-1)/3}\right).$$

To apply Lemma 5.1, r is taken large depending on h . We take $\alpha\eta$ to be the η in the statement of this proposition and complete the proof by renaming constants and noting their dependencies. \square

Until this point, we have only used the concentration estimates from Section 4 to show the random variables Ξ_{face} cannot be too small. In the next subsection, we put the complementary estimates to use.

5.2. Upper bounds on $\widehat{\Phi}_n$, or efficient carvings of ice. A *convex polytope* is a compact subset of \mathbb{R}^d which can be written as a finite intersection of closed half-spaces. A *polytope* is a compact subset of \mathbb{R}^d which may be written as finite union of convex polytopes. We do not require polytopes to be connected subsets of \mathbb{R}^d , but say a polytope is *connected* if its interior is a connected subset of \mathbb{R}^d . A polytope $P \subset \mathbb{R}^d$ is a *d-polytope* if it is non-degenerate ($\mathcal{L}^d(P) > 0$).

To obtain upper bounds on $\widehat{\Phi}_n$, we use a polytope P to obtain a valid subgraph of \mathbf{C}_n , controlling both the volume and open edge boundary of this subgraph. Equivalently, we view \mathbf{C}_n as a block of ice, and we use the dilate nP as a blueprint for carving this block.

Our first task is to perform an *efficient* carving at the boundary of nP , and this is where the other side of our concentration estimates are used. The next result allows us to work on each face of the polytope P individually. We think of a $(d-1)$ -polytope $\sigma \subset \mathbb{R}^d$ as a face of a d -polytope P . For such σ , let v_σ denote one of the unit vectors orthogonal to $\text{hyp}(\sigma)$.

Proposition 5.3. *Let $d \geq 2$, $p > p_c(d)$ and $\epsilon > 0$. Let $\sigma \subset \mathbb{R}^d$ be a connected $(d-1)$ -polytope. There is a positive constant $\eta(p, d, \epsilon, \sigma)$ and another connected $(d-1)$ -polytope $\widetilde{\sigma}$ depending on p, d, ϵ and σ so that:*

(i) $\widetilde{\sigma} \subset \sigma$, $\widetilde{\sigma} \cap \mathcal{N}_\eta(\partial\sigma) = \emptyset$ and $\mathcal{H}^{d-1}(\sigma \setminus \widetilde{\sigma}) \leq \epsilon\mathcal{H}^{d-1}(\sigma)$.

(ii) *There are positive constants $c_1(p, d, \epsilon, \sigma)$ and $c_2(p, d, \epsilon, \sigma)$ so that when $h \in (0, \eta)$ and for all $r > 0$ sufficiently large depending on h ,*

$$(5.19) \quad \mathbb{P}_p\left(\Xi_{\text{hemi}}(\widetilde{\sigma}, h, r) \geq (1 + \epsilon)\mathcal{H}^{d-1}(r\sigma)\beta_{p,d}(v_\sigma)\right) \leq c_1 \exp\left(-c_2r^{(d-1)/3}\right).$$

Proof. Let $\epsilon' > 0$, and for the parameter $\eta > 0$, define $\widetilde{\sigma}$ to be the closure of $\sigma \setminus \mathcal{N}_{2\eta}^{(1)}(\partial\sigma)$, where we recall from Section 2.3 the notation for the ℓ^1 -neighborhood of a set. Then $\widetilde{\sigma}$ is a $(d-1)$ polytope, and because σ is connected, we may choose η sufficiently small depending on σ and ϵ so that $\widetilde{\sigma}$ is also connected, and so that

$$(5.20) \quad \mathcal{H}^{d-1}(\sigma \setminus \widetilde{\sigma}) \leq \epsilon'\mathcal{H}^{d-1}(\sigma).$$

For such $\widetilde{\sigma}$, property (i) is already satisfied after requiring $\epsilon' \leq \epsilon$.

To show (ii) holds, we employ the strategy used in the proof of Proposition 5.2. Let $h \leq \eta$, and let $\tilde{\sigma}' \subset \mathbb{R}^{d-1}$ be a $(d-1)$ -polytope with an isometry $\varphi : \tilde{\sigma}' \rightarrow \tilde{\sigma}$. Choose $k \in \mathbb{N}$ to be smallest such that $2^{-k} < h$, but large enough so that

$$(5.21) \quad \mathcal{L}^{d-1} \left(\tilde{\sigma}' \setminus \bigcup_{S' \in \Delta^k, S' \subset \tilde{\sigma}'} S' \right) \leq \epsilon' \mathcal{L}^{d-1}(\tilde{\sigma}'),$$

where, as before, $\Delta^k \equiv \Delta^{k,d-1}$ denotes the dyadic squares in $[-1, 1]^{d-1}$ at scale k . Enumerate such squares contained in $\tilde{\sigma}'$ as S'_1, \dots, S'_m . Let $\delta > 0$ and dilate each S'_i about its center by a factor of $(1 - \delta)$ to produce a new, disjoint collection $\{S''_i\}_{i=1}^m$ of closed squares contained in $\tilde{\sigma}'$. Let $S_i = \varphi(S''_i)$, and choose δ small enough so that

$$(5.22) \quad \mathcal{H}^{d-1} \left(\tilde{\sigma} \setminus \bigcup_{i=1}^m S_i \right) < 2\epsilon' \mathcal{H}^{d-1}(\sigma).$$

As before, write $\alpha := (1 - \delta)2^{-k}$; we lose no generality assuming $\tilde{\sigma}'$ and φ are compatible with \mathbb{S} , so that each S_i is $\alpha \mathbb{S}(y_i, v_\sigma)$ for some $y_i \in \mathbb{R}^d$. For each i , let E_i denote a cutset in $\mathbf{d}\text{-cyl}(S_i, \alpha, r)$ separating $\mathbf{d}\text{-hemi}^\pm(S_i, \alpha, r)$. Let A denote the edges intersecting

$$(5.23) \quad \mathcal{N}_{5d} \left(r \left(\tilde{\sigma} \setminus \bigcup_{i=1}^m S_i \right) \right)$$

so that $|A| \leq c(d)\epsilon' \mathcal{H}^{d-1}(r\sigma)$ for some $c(d) > 0$. The now standard argument from Lemma 3.3 tells us the edges of $A \cup \bigcup_{i=1}^m E_i$ contained in $\mathbf{d}\text{-cyl}(\tilde{\sigma}, h, r)$ separate $\mathbf{d}\text{-hemi}^\pm(\tilde{\sigma}, h, r)$. Here r is taken sufficiently large depending on h to ensure this argument goes through. It is here we use that k satisfies $\alpha \leq 2^{-k} \leq h$. Under these conditions, we conclude

$$(5.24) \quad \Xi_{\text{hemi}}(\tilde{\sigma}, h, r) \leq c(d)\epsilon' \mathcal{H}^{d-1}(r\sigma) + \sum_{i=1}^m \Xi_{\text{hemi}}(S_i, \alpha, r),$$

and thus,

$$(5.25) \quad \mathbb{P}_p \left(\Xi_{\text{hemi}}(\tilde{\sigma}, h, r) \geq (1 + \epsilon) \mathcal{H}^{d-1}(r\sigma) \beta_{p,d}(v_\sigma) \right)$$

$$(5.26) \quad \leq \mathbb{P}_p \left(\sum_{i=1}^m \Xi_{\text{hemi}}(S_i, \alpha, r) \geq (1 + \epsilon - c(p, d)\epsilon') \mathcal{H}^{d-1}(r\sigma) \beta_{p,d}(v_\sigma) \right).$$

Now choose ϵ' small enough depending on p, d, ϵ so that $1 + \epsilon - c(p, d)\epsilon' \geq 1 + \epsilon/2$:

$$(5.27) \quad \mathbb{P}_p \left(\Xi_{\text{hemi}}(\tilde{\sigma}, h, r) \geq (1 + \epsilon) \mathcal{H}^{d-1}(r\sigma) \beta_{p,d}(v_\sigma) \right)$$

$$(5.28) \quad \leq \mathbb{P}_p \left(\sum_{i=1}^m \Xi_{\text{hemi}}(S_i, \alpha, r) \geq (1 + \epsilon/2) \sum_{i=1}^m \mathcal{H}^{d-1}(rS_i) \beta_{p,d}(v_\sigma) \right),$$

$$(5.29) \quad \leq \sum_{i=1}^m \mathbb{P}_p \left(\Xi_{\text{hemi}}(S_i, \alpha, r) \geq (1 + \epsilon/2) \mathcal{H}^{d-1}(rS_i) \beta_{p,d}(v_\sigma) \right),$$

$$(5.30) \quad \leq \sum_{i=1}^m \mathbb{P}_p \left(\mathfrak{X}(y_i, v_\sigma, \alpha r) \geq (1 + \epsilon/2) \mathcal{H}^{d-1}(\alpha r \mathbb{S}(y_i, v_\sigma)) \beta_{p,d}(v_\sigma) \right).$$

Here we have used a union bound and that each $S_i = \alpha \mathbf{S}(y_i, v_\sigma)$ for some $y_i \in \mathbb{R}^d$. Applying Theorem 4.7 to each summand on the right, we obtain

$$(5.31) \quad \mathbb{P}_p \left(\Xi_{\text{hemi}}(\bar{\sigma}, h, r) \geq (1 + \epsilon) \mathcal{H}^{d-1}(r\sigma) \beta_p(v_\sigma) \right) \leq mc_1 \exp \left(-c_2(\alpha r)^{(d-1)/3} \right),$$

completing the proof. \square

We now use a d -polytope P to obtain a high probability upper bound on $\widehat{\Phi}_n$ in terms of the conductance of P .

Theorem 5.4. *Let $d \geq 2$ and let $p > p_c(d)$. Let $P \subset [-1, 1]^d$ be a polytope such that $\mathcal{L}^d(P) \leq 2^d/d!$, and let $\epsilon > 0$. There exist positive constants $c_1(p, d, \epsilon, P)$ and $c_2(p, d, \epsilon, P)$ so that*

$$(5.32) \quad \mathbb{P}_p \left(\widehat{\Phi}_n \geq (1 + \epsilon) \left(\frac{\mathcal{I}_{p,d}(nP)}{\theta_p(d) \mathcal{L}^d(nP)} \right) \right) \leq c_1 \exp \left(-c_2 n^{(d-1)/3} \right).$$

Proof. Begin by working with $P_\delta := (1 - \delta)P$ for $\delta \in (0, 1)$, so that the Euclidean distance from P_δ to $\partial[-1, 1]^d$ is positive. We choose δ carefully at the end of the argument. Let $\epsilon, \epsilon' > 0$ and enumerate the faces of P_δ as $\sigma_1, \dots, \sigma_m$, suppressing the dependence of these faces on δ . Use Proposition 5.3, picking η depending on ϵ' and on each face σ_i ; for each i , we produce $\bar{\sigma}_i$ so that

- (1) $\mathcal{H}^{d-1}(\sigma_i \setminus \bar{\sigma}_i) \leq \epsilon' \mathcal{H}^{d-1}(\sigma_i)$
- (2) $\bar{\sigma}_i \subset \sigma_i$, $\bar{\sigma}_i \cap \mathcal{N}_\eta(\partial\sigma_i) = \emptyset$ and $\mathcal{H}^{d-1}(\sigma_i \setminus \bar{\sigma}_i) \leq \epsilon' \mathcal{H}^{d-1}(\sigma_i)$.
- (3) There are positive constants $c_1(p, d, \epsilon', P, \delta)$ and $c_2(p, d, \epsilon', P, \delta)$ so that if $h \in (0, \eta)$, and if $r > 0$ is sufficiently large depending on h ,

$$(5.33) \quad \mathbb{P}_p \left(\Xi_{\text{hemi}}(\bar{\sigma}_i, h, r) \geq (1 + \epsilon') \mathcal{H}^{d-1}(r\sigma_i) \beta_{p,d}(v_\sigma) \right) \leq c_1 \exp \left(-c_2 r^{(d-1)/3} \right).$$

Assume η is small enough so that $\mathcal{N}_\eta(P_\delta)$ is contained in $[-1, 1]^d$, and choose $h \in (0, \eta)$, henceforth fixed, so that the cylinders $\{\text{cyl}(\bar{\sigma}_i, h, n)\}_{i=1}^m$ are disjoint. We will use Proposition 5.3 in each cylinder $\text{cyl}(\bar{\sigma}_i, h, n)$ to control the open edge boundary of a subgraph of \mathbf{C}_n , to be constructed momentarily. Before doing so, we position ourselves to control the volume of this subgraph.

Let Q_1, \dots, Q_ℓ enumerate the dyadic cubes at scale k within $[-1, 1]^d$. Suppose these cubes are ordered so that for $\ell_1 \leq \ell_2 \in \{1, \dots, \ell\}$, the collection Q_1, \dots, Q_{ℓ_2} enumerates all cubes intersecting $\mathcal{N}_\eta(P_\delta)$, and that Q_1, \dots, Q_{ℓ_1} enumerates all cubes contained in $P_\delta \setminus \mathcal{N}_\eta(P_\delta)$. Take k sufficiently large and take η smaller if necessary so that

$$(5.34) \quad \mathcal{L}^d \left(\bigcup_{j=\ell_1+1}^{\ell_2} Q_j \right) < \epsilon' \mathcal{L}^d(P_\delta),$$

and for each $j \in \{1, \dots, \ell\}$, let $\mathcal{E}_n^{(j)}$ be the event that

$$(5.35) \quad \left\{ \frac{|\mathbf{C}_\infty \cap nQ_j|}{\mathcal{L}^d(nQ_j)} \in (\theta_p(d) - \epsilon', \theta_p(d) + \epsilon') \right\}.$$

We now construct a subgraph of \mathbf{C}_n from P . Fix a percolation configuration ω , and for each face σ_i , let $E_n^{(i)}(\omega)$ denote a cutset within $\text{d-cyl}(\bar{\sigma}_i, h, n)$ separating $\text{d-hemi}^\pm(\bar{\sigma}_i, h, n)$, with $|E_n^{(i)}(\omega)|_\omega = \Xi_{\text{hemi}}(\bar{\sigma}_i, h, n)$ in the configuration ω . Let A_n be the edges intersecting

$$(5.36) \quad \mathcal{N}_{5d} \left(n \left(\partial P_\delta \setminus \bigcup_{i=1}^m \bar{\sigma}_i \right) \right).$$

We chose $\tilde{\sigma}_i$ to satisfy (2), thus $|A_n| \leq c(d)\epsilon'\mathcal{H}^{d-1}(\partial P_\delta)n^{d-1}$ for some $c(d) > 0$. Define

$$(5.37) \quad \Gamma_n := \left(\bigcup_{i=1}^m E_n^{(i)}(\omega) \right) \cup A_n.$$

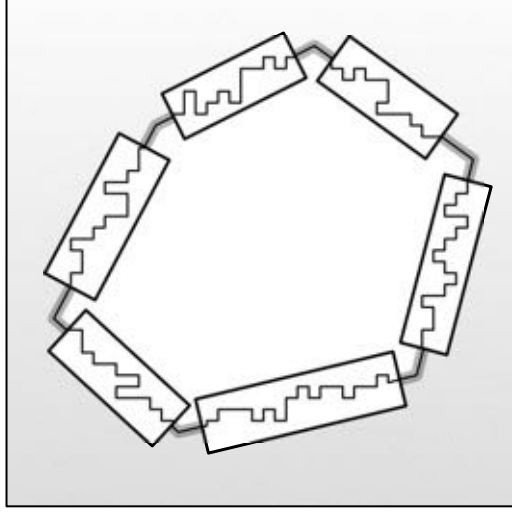

FIGURE 8. The polytope nP has six faces. Each of the boxes at the boundary of nP is one of the $\text{cyl}(\tilde{\sigma}_i, h, n)$, and within each is the corresponding cutset $E_n^{(i)}$. The set A_n is the grey outline of each corner.

Define the vertex set $H_n(\omega)$ to be all $x \in \mathbf{C}_n$ separated from ∞ by $\Gamma_n(\omega)$. The proof of Lemma 3.3 tells us $H_n(\omega)$ is non-empty and in fact contains every vertex $x \in \mathbf{C}_\infty \cap Q_j$ for $j \in \{1, \dots, \ell_1\}$. For this proof to go through, we ensure n is large enough depending on h so that the cylinders $\text{cyl}(\tilde{\sigma}_i, h, n)$ are suitable in the sense of Remark 3.1. As h has been fixed and depends only on ϵ' and P , this is no issue, and $H_n(\omega)$ is well-defined for all n sufficiently large. Though $H_n(\omega)$ was defined as a collection of vertices, we now view it as a graph whose structure comes from restricting \mathbf{C}_n and suppress the dependence of H_n and Γ_n on the percolation configuration.

We now exhibit control on the volume and open edge boundary of H_n , first working within the intersection \mathcal{E} of the high probability events $\mathcal{E}_n^{(j)}$ defined in (5.35) to control $|H_n|$. For all $\omega \in \mathcal{E}$,

$$(5.38) \quad (\theta_p(d) - \epsilon') \left(\sum_{j=1}^{\ell_1} \mathcal{L}^d(nQ_j) \right) - \ell c(d) (2^{-k}n)^{d-1} \leq |H_n| \leq (\theta_p(d) + \epsilon') \sum_{j=1}^{\ell_2} \mathcal{L}^d(nQ_j),$$

where the term subtracted on the left arises because the Q_j only have disjoint *interiors*. For n sufficiently large (depending on p, d, ϵ', P), we have

$$(5.39) \quad (\theta_p(d) - 2\epsilon') \sum_{j=1}^{\ell_1} \mathcal{L}^d(nQ_j) \leq |H_n| \leq (\theta_p(d) + \epsilon') \sum_{j=1}^{\ell_2} \mathcal{L}^d(nQ_j),$$

and hence that

$$(5.40) \quad (\theta_p(d) - 2\epsilon')(1 - \epsilon')\mathcal{L}^d(nP_\delta) \leq |H_n| \leq (\theta_p(d) + \epsilon')(1 + \epsilon')\mathcal{L}^d(nP_\delta),$$

$$(5.41) \quad (\theta_p(d) - 2\epsilon')(1 - \epsilon')(1 - \delta)^d \mathcal{L}^d(nP) \leq |H_n| \leq (\theta_p(d) + \epsilon')(1 + \epsilon')(1 - \delta)^d \mathcal{L}^d(nP).$$

We now show that H_n is a valid subgraph of \mathbf{C}_n when δ is chosen appropriately. On \mathcal{E} ,

$$(5.42) \quad |\mathbf{C}_n| \geq (\theta_p(d) - \epsilon')(2n)^d - \ell c(d)(2^{-k}n)^{d-1},$$

$$(5.43) \quad \geq (\theta_p(d) - 2\epsilon')(2n)^d.$$

for n sufficiently large. As $\mathcal{L}^d(P) \leq 2^d/d!$, choosing δ in accordance with (5.41) so that

$$(5.44) \quad (\theta_p(d) + \epsilon')(1 + \epsilon')(1 - \delta)^d = (\theta_p(d) - 2\epsilon'),$$

ensuring H_n is a valid subgraph of \mathbf{C}_n within \mathcal{E} . Defining δ this way implies $\delta \rightarrow 0$ as $\epsilon' \rightarrow 0$.

Not only have we shown H_n is valid within a high probability event, we also have exhibited a lower bound on $|H_n|$. To bound $\widehat{\Phi}_n$, it then suffices to bound $|\partial^\omega H_n|$ from above. The construction of H_n , guarantees $\partial^\omega H_n \subset \Gamma_n$. Using the disjointness of the cylinders $\text{cyl}(\widetilde{\sigma}_i, h, n)$,

$$(5.45) \quad |\partial^\omega H_n| \leq \sum_{i=1}^m |E_n^{(i)}(\omega)|_\omega + c(d)\mathcal{H}^{d-1}(\partial P_\delta)\epsilon' n^{d-1}.$$

For $i \in \{1, \dots, m\}$, let $\mathcal{F}_n^{(i)}$ be the event in (5.33). On the intersection \mathcal{F} of all $\mathcal{F}_n^{(i)}$,

$$(5.46) \quad |\partial^\omega H_n| \leq (1 + \epsilon')\mathcal{I}_{p,d}(nP) + c(d)\mathcal{H}^{d-1}(\partial P)\epsilon' n^{d-1},$$

$$(5.47) \quad \leq (1 + \epsilon' + c(p, d)\epsilon')\mathcal{I}_{p,d}(nP).$$

Thus, on the intersection of \mathcal{E} and \mathcal{F} , we have

$$(5.48) \quad \widehat{\Phi}_n \leq \left(\frac{1 + \epsilon' + c(p, d)\epsilon'}{(\theta_p(d) - 2\epsilon')(1 - \epsilon')(1 - \delta)^d} \right) \frac{\mathcal{I}_{p,d}(nP)}{\mathcal{L}^d(nP)},$$

and we take ϵ' small enough (recall $\delta = \delta(\epsilon')$ goes to zero as ϵ' does) so that

$$(5.49) \quad \widehat{\Phi}_n \leq (1 + \epsilon) \frac{\mathcal{I}_{p,d}(nP)}{\theta_p(d)\mathcal{L}^d(nP)}.$$

Use the bounds in Corollary A.4 on \mathcal{E} and in Proposition 5.3 on \mathcal{F} to conclude

$$(5.50) \quad \mathbb{P}_p((\mathcal{E} \cap \mathcal{F})^c) \leq mc_1 \exp(-c_2 n^{(d-1)/3}) + \ell c_1 \exp(-c_2(2^{-k}n)^{d-1}),$$

which completes the proof, upon tracking the dependencies of ℓ and k . □

Using Proposition A.15, Theorem 5.4 and Borel-Cantelli we deduce the following.

Corollary 5.5. *Let $d \geq 2$ and let $p > p_c(d)$. Consider the Wulff crystal $W_{p,d}$ corresponding $\beta_{p,d}$, and let $\epsilon > 0$. The event below occurs \mathbb{P}_p -almost surely:*

$$(5.51) \quad \left\{ \limsup_{n \rightarrow \infty} n\widehat{\Phi}_n \leq (1 + \epsilon) \frac{\mathcal{I}_{p,d}(W_{p,d})}{\theta_p(d)\mathcal{L}^d(W_{p,d})} \right\}.$$

Proof. Recall $\mathcal{L}^d(W_{p,d}) = 2^d/d!$. Let $\epsilon, \epsilon' > 0$ and apply Proposition A.15 to obtain a polytope $P_{\epsilon'} \subset W_{p,d}$ with $|\mathcal{I}_{p,d}(P_{\epsilon'}) - \mathcal{I}_{p,d}(W_{p,d})| < \epsilon'$ and with $\mathcal{L}^d(W_{p,d} \setminus P_{\epsilon'}) < \epsilon'$. Apply Theorem 5.4 to $P_{\epsilon'}$ to obtain positive constants $c_1(p, d, \epsilon, P_{\epsilon'})$ and $c_2(p, d, \epsilon, P_{\epsilon'})$ so that

$$(5.52) \quad \mathbb{P}_p \left(n\widehat{\Phi}_n \geq (1 + \epsilon/2) \left(\frac{1 + \epsilon'}{1 - \epsilon'} \right) \left(\frac{\mathcal{I}_{p,d}(W_{p,d})}{\theta_p(d)\mathcal{L}^d(W_{p,d})} \right) \right) \leq \mathbb{P}_p \left(n\widehat{\Phi}_n \geq (1 + \epsilon/2) \left(\frac{\mathcal{I}_{p,d}(P_{\epsilon'})}{\theta_p(d)\mathcal{L}^d(P_{\epsilon'})} \right) \right)$$

$$(5.53) \quad \leq c_1 \exp(-c_2 n^{(d-1)/3}).$$

Choosing ϵ' sufficiently small depending on ϵ and applying Borel-Cantelli completes the proof. \square

Corollary 5.5 is the easier half of Theorem 1.3. Before moving to the next section, we make an observation to aid in the proof of Theorem 1.2. For $K \subset [-1, 1]^d$ convex with non-empty interior, define the *empirical measure* associated to K as

$$(5.54) \quad \bar{\nu}_K(n) := \frac{1}{n^d} \sum_{x \in \mathcal{C}_n \cap nK} \delta_{x/n}.$$

Following the proof of Theorem 5.4, it is not difficult to deduce the following result (recall that the metric \mathfrak{d} introduced in (2.6)).

Corollary 5.6. *Let $d \geq 2$, $p > p_c(d)$ and let $W \subset [-1, 1]^d$ be a translate of $W_{p,d}$. For $\epsilon > 0$, there are positive constants $c_1(p, d, \epsilon)$ and $c_2(p, d, \epsilon)$ so that*

$$(5.55) \quad \mathbb{P}_p(\mathfrak{d}(\bar{\nu}_W(n), \nu_W) > \epsilon) \leq c_1 \exp(-c_2 n^{d-1}).$$

Remark 5.7. Corollary 5.6 follows from the approximation result Proposition A.15, from the density result Corollary A.4 (used as in the proof of Theorem 5.4) applied to a fine mesh of dyadic cubes and finally from the definition of the metric \mathfrak{d} . No concentration estimates for $\beta_{p,d}$ are needed, so the proof of Corollary 5.6 is less involved than that of Theorem 5.4, and we choose to omit it.

6. COARSE GRAINING

Having spent the last section passing from continuous objects to discrete objects, we now move in the more difficult direction. To each $G_n \in \mathcal{G}_n$, we associate a set of finite perimeter $P_n \subset [-1, 1]^d$ with comparable conductance. A natural candidate for P_n is

$$(6.1) \quad \frac{1}{n} \left(\bigcup_{x \in \mathcal{V}(G_n)} Q(x) \right),$$

where $Q(x)$ is the unit dual cube corresponding to $x \in \mathbb{Z}^d$. However, the perimeter of the set in (6.1) is directly related to $n^{-(d-1)}|\partial G_n|$ instead of $n^{-(d-1)}|\partial^\omega G_n|$ and may grow with n due to vacant percolation, unless p is taken close to one. This suggests a renormalization argument, and indeed, in the present section we clarify and modify a procedure due to Zhang [64]. Because of the intricacy of the coarse graining is, we do not build the P_n until Section 8.

The construction works only in dimensions strictly larger than two. We comment on this in Section 7.2, and for now we simply assume $d \geq 3$ for the remainder of the paper.

6.1. Preliminary notation. Let k be a natural number called the *renormalization parameter*. Given $x \in \mathbb{Z}^d$, define the k -cube centered at x as:

$$(6.2) \quad \underline{B}(x) := (2k)x + [-k, k]^d,$$

suppressing the dependence of $\underline{B}(x)$ on k to avoid cumbersome notation. Underscores are used to denote sets of k -cubes. If \underline{G} is a set of k -cubes and $x \in V(\mathbb{Z}^d)$, write $x \in \underline{G}$ if x is contained in one of the k -cubes of \underline{G} . Likewise, if $e \in E(\mathbb{Z}^d)$ is an edge, we write $e \in \underline{G}$ if both endpoint vertices of e lie in \underline{G} .

A $3k$ -cube centered at x is defined as follows:

$$(6.3) \quad \underline{B}_3(x) := (2k)x + [-3k, 3k]^d.$$

We emphasize that x lies in \mathbb{Z}^d , thus each $3k$ -cube contains exactly 3^d k -cubes. Two cubes $\underline{B}(x)$ and $\underline{B}(x')$ are *adjacent* if $x \sim x'$, or equivalently if they share a face. Two cubes $\underline{B}(x)$ and $\underline{B}(x')$ are **-adjacent* if $x \sim_* x'$, or equivalently if either $\underline{B}(x') \subset \underline{B}_3(x)$ or $\underline{B}(x) \subset \underline{B}_3(x')$.

6.2. Discovering a cutset. We describe Zhang's method in general, then apply it to the Cheeger optimizers in the next section. The idea is to form a collection of k -cubes containing $\partial_o G_n$, and then to discover within these cubes a more tame cutset separating G_n from ∞ .

Let $G = G(\omega) \subset \mathbf{C}_\infty$ be a finite connected graph and from G , define several sets of k -cubes:

$$(6.4) \quad \underline{G} := \{ \underline{B}(x) : \underline{B}(x) \cap (G \cup \partial_o G) \neq \emptyset \}, \quad \underline{A} := \{ \underline{B}(x) : \underline{B}(x) \cap \partial_o G \neq \emptyset \}.$$

Figure 9 depicts a possible G and \underline{A} . As G is finite, so too is \underline{G} , thus the cubes $\underline{B}(x)$ not in \underline{G} split into a single infinite *-connected component called the *ocean*, labeled \underline{Q} , and finitely many finite *-connected components $\underline{Q}'(1), \dots, \underline{Q}'(u')$, called *ponds*.

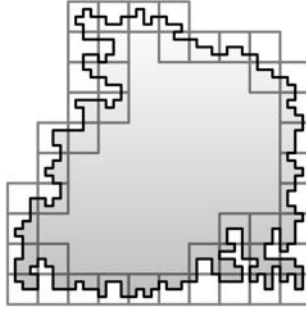

FIGURE 9. The black contour and its interior are $\partial_o G$ and G respectively. Notice that \underline{A} , depicted by the squares covering $\partial_o G$, is not necessarily the boundary of \underline{G} .

Let $\Delta \underline{Q}$ denote the k -cubes *-adjacent to a cube in the ocean \underline{Q} but not contained in \underline{Q} . Likewise, for each pond $\underline{Q}'(i)$, let $\Delta \underline{Q}'(i)$ denote the k -cubes *-adjacent to $\underline{Q}'(i)$ but not contained in $\underline{Q}'(i)$.

Remark 6.1. The next step in Zhang's construction is to pass to the unique configuration ω' obtained by closing each open edge in $\partial_o G$. This is done while preserving both G and \mathbf{C}_∞ , so that we still work with the graphs $G(\omega)$ and $\mathbf{C}_\infty(\omega)$, now with each modified by closing each open edge of $\partial_o G$. Counterintuitively, \mathbf{C}_∞ is then a disconnected graph after passing to the configuration ω' . This is only a *formal* procedure as we eventually pass *back* to the configuration ω .

Pass to the configuration ω' . Each pond may intersect an open cluster connected to the ocean, and we emphasize these open clusters need not be contained in \mathbf{C}_∞ . A pond is *live* if it intersects an open cluster also intersecting the ocean. If $\underline{Q}'(i)$ intersects an open cluster also intersecting a distinct live pond, say it is *almost-live*. If $\underline{Q}'(i)$ intersects an open cluster also intersecting a distinct pond labeled as almost-live, call $\underline{Q}'(i)$ *almost-live* also. Thus, the label almost-live *propagates* through the $\underline{Q}'(i)$ via open clusters, starting with the live ponds.

A pond is *dead* if it is neither live nor almost-live. Refine the collection of ponds $\{\underline{Q}'(i)\}_{i=1}^{u'}$ to the live and almost-live ponds $\underline{Q}(1), \dots, \underline{Q}(u)$; Figure 10 depicts a possible configuration of ponds.

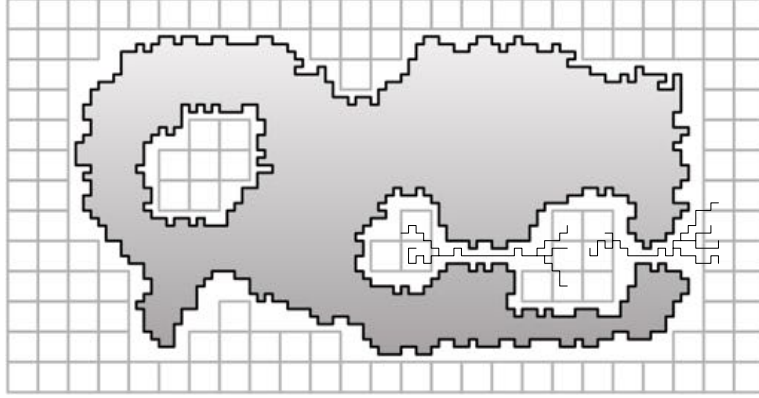

FIGURE 10. The graph G is the shaded region between closed curves. The connected components of cubes in the diagram are ponds or the ocean. The left-most pond is dead, the right-most pond is live and the middle pond is almost-live. The portions of the thin curves which do not intersect any cube represent the set bridge.

Now construct a graph called *bridge* which joins the live and almost-live ponds. Let C be the union of all open clusters intersecting \underline{Q} , and let C_i be the union of all open clusters intersecting the live or almost-live pond $\underline{Q}(i)$. The components of C and C_i are not necessarily in \mathbf{C}_∞ . To specify the vertices of C_i contained in $\underline{Q}(i)$ only, define $Q_i := C_i \cap \underline{Q}(i)$, and likewise define $Q := C \cap \underline{Q}$. Let *bridge* be the *remainder* of these components in \underline{G} :

$$(6.5) \quad \text{bridge} := \left[\left(\bigcup_{B(x) \in \underline{G}} \underline{B}(x) \right) \cap \left(C \cup \left(\bigcup_{i=1}^u C_i \right) \right) \right] \setminus \left(Q \cup \left(\bigcup_{i=1}^u Q_i \right) \right).$$

The set *bridge* inherits a graph structure from C and the C_i . Let us make an observation.

Lemma 6.2. *In the configuration ω' , the vertex sets of *bridge* and G are disjoint, and all edges of ∂bridge are closed, except those joining a vertex of *bridge* and a vertex in some Q_i or those joining a vertex of *bridge* with a vertex in Q .*

Proof. To show *bridge* and G are disjoint, it suffices to show $C_i \cap G = \emptyset$ for each i and that $C \cap G = \emptyset$. If the intersection of C and G were non-empty, there would then be an open path beginning from a vertex of G and ending at a vertex contained in \underline{Q} , which is impossible in the configuration ω' , as it would imply ∂G is not a cutset separating the vertices of G from ∞ . The same reasoning shows that $C_i \cap G = \emptyset$ for each i .

As C and the C_i are unions of open clusters, it is impossible that ∂C or any ∂C_i contain open edges. Due to the construction of bridge , the only open edges present in ∂bridge either join bridge with some vertex in the ocean \underline{Q} , or they join bridge with a vertex in $\underline{Q}(i)$ for some i . \square

The coarse-grained image of bridge is the last ingredient in a cube set which will nearly contain a closed cutset. Define

$$(6.6) \quad \underline{\text{bridge}} := \{ \underline{B}(x) : \underline{B}(x) \text{ contains a vertex of } \text{bridge} \},$$

and then define the cube set $\underline{\Gamma}$:

$$(6.7) \quad \underline{\Gamma} := \underline{\Delta Q} \cup \underline{\text{bridge}} \cup \left(\bigcup_{i=1}^u \underline{\Delta Q}(i) \right).$$

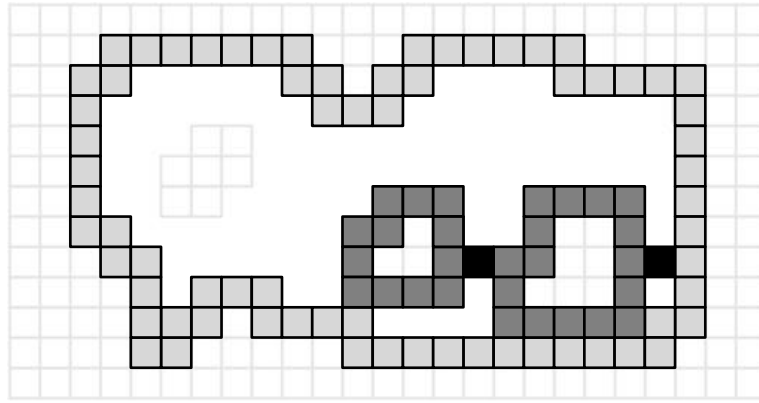

FIGURE 11. This image is built from Figure 10. We have removed $\partial_o G$ and bridge from the diagram for clarity. The light-grey cubes depict $\underline{\Delta Q}$, the dark-grey cubes depict the two $\underline{\Delta Q}(i)$ and the black cubes depict $\underline{\text{bridge}}$. The cubes adjacent to the black cubes are also in $\underline{\text{bridge}}$, so $\underline{\text{bridge}}$ is not necessarily disjoint from the boundary of the ponds and ocean.

Remark 6.3. The cube set $\underline{\Gamma}$ insulates G from ∞ , and is depicted in Figure 11. The boundaries of the ocean and live / almost-live ponds cover the relevant parts of $\partial_o G$, and $\underline{\text{bridge}}$ connects these boundaries, allowing $\underline{\Gamma}$ to be $*$ -connected.

We introduce one more piece of notation to state the central result of this section. For a k -cube $\underline{B}(x)$, define the corresponding *augmented cube* as follows:

$$(6.8) \quad \underline{B}^+(x) := 2kx + [-2k - 1, 2k + 1]^d.$$

Proposition 6.4. *In the configuration ω' , the augmented cube set*

$$(6.9) \quad \underline{\Gamma}^+ := \{ \underline{B}^+(x) : \underline{B}(x) \in \underline{\Gamma} \}$$

contains a closed cutset Γ which separates G from ∞ .

Proof. Let γ' be a path from G to ∞ . We show γ' uses a closed edge contained in $\underline{\Gamma}^+$. We lose no generality supposing γ' is simple. As \underline{G} and each pond are finite sets, there is a first vertex $v_0 \in \underline{Q}$ used by γ' . Consider the subpath of γ' starting at the beginning of γ' and ending at v_0 . Name the

reversal of this subpath γ , so that γ is a path from v_0 to G . It will suffice to show γ uses a closed edge which is contained in $\underline{\Gamma}^+$.

If the edge following v_0 in γ is closed, we are happy, as this edge lies in ΔQ . Thus we may suppose that the edge following v_0 in γ is open, so that γ joins bridge. The path γ must connect with G . As bridge and G are disjoint (by Lemma 6.2), and because γ eventually uses a vertex of G , γ eventually leaves bridge. If γ leaves bridge through a closed edge, this edge lies in one of the augmented cubes corresponding to the set bridge, and the proposition holds.

We may then suppose γ first leaves bridge through an open edge. By Lemma 6.2, and because γ cannot return to \underline{Q} , γ must pass into some Q_i . As γ is simple and the Q_i are disjoint from G , there is a vertex v_1 , last among all Q_i used by γ . Let γ_1 denote the subpath of γ obtained by starting from v_1 . If the first edge of γ_1 is closed, our claim holds as this edge lies in $\Delta Q(i)$ for some i . Thus we may suppose the first edge of γ_1 is open, so that γ_1 rejoins bridge. However, γ_1 can no longer exit bridge through a pond or through the ocean, and thus γ_1 must exit bridge through a closed edge.

This establishes that $\underline{\Gamma}^+$ contains a closed cutset separating G from ∞ . Via some deterministic method, choose a minimal cutset within $\underline{\Gamma}^+$ and label it Γ . \square

6.3. Properties of the discovered cutset. We now derive properties of the cutset Γ and the cube set $\underline{\Gamma}$. We begin by showing $\underline{\Gamma}$ is contained in the coarse grained image of $\partial_o G$.

Lemma 6.5. *The k -cube set $\underline{\Gamma}$ is contained in \underline{A} .*

Proof. Suppose $\underline{B}(x) \in \underline{\text{bridge}}$. We claim $\underline{B}(x)$ either contains a vertex of G or the endpoint vertex of an edge in $\partial_o G$, that is, $\underline{B}(x) \in \underline{G}$. If not, either $\underline{B}(x) \in \underline{Q}(i)$ or $\underline{B}(x) \in \underline{Q}$. As $\underline{B}(x) \in \underline{\text{bridge}}$, there is $y \in \underline{B}(x)$ lying in an open cluster connected to a live or almost-live pond. Thus, if $\underline{B}(x)$ is a member of a pond, this pond is live or almost-live. Then either $y \in Q_i$ for some i or $y \in Q$. Both are impossible, as we cut out such vertices in the construction of bridge, and we conclude $\underline{\text{bridge}} \subset \underline{G}$.

Continue to suppose $\underline{B}(x) \in \underline{\text{bridge}}$. As $\underline{B}(x)$ contains $y \in \underline{\text{bridge}} \subset C \cup \bigcup_i C_i$, and as this union is disjoint from G , any path γ from y to G within $\underline{B}(x)$ uses an edge in ∂G . But any $y \in C \cup \bigcup_i C_i$ is connected to ∞ via a path disjoint from G . Thus the path γ from y to G in $\underline{B}(x)$ must actually use an edge of $\partial_o G$, and $\underline{\text{bridge}} \subset \underline{A}$.

We now show $\Delta Q(i) \subset \underline{A}$ for each i . Let $\underline{B}(x) \in \Delta Q(i)$, so that $\underline{B}(x)$ is $*$ -adjacent to a cube $\underline{B}(x') \in \underline{Q}(i)$. Then $\underline{B}(x)$ either contains a vertex of G or an endpoint vertex of an edge in $\partial_o G$, otherwise $\underline{B}(x)$ would be a member of $\underline{Q}(i)$. If $\underline{B}(x)$ contains an endpoint vertex of an edge in $\partial_o G$, we are done, thus we suppose $\underline{B}(x)$ contains a vertex y of G .

Note that $\underline{B}(x)$ and $\underline{B}(x')$ have at least one vertex z in common, and z (by virtue of lying within some $\underline{Q}(i)$) is connected to ∞ in via a \mathbb{Z}^d -path disjoint from G . Any path joining y and z in $\underline{B}(x)$ then intersects $\partial_o G$, showing $\Delta Q(i) \subset \underline{A}$. An identical argument shows $\Delta Q \subset \underline{A}$. \square

We now apply analogues of Proposition 2.1 to $\Delta Q(i)$ and ΔQ to establish the following essential result.

Lemma 6.6. *The k -cube set $\underline{\Gamma}$ is $*$ -connected.*

Proof. It follows directly from Lemma 2 of Timár [61] that ΔQ and each $\Delta Q(i)$ are $*$ -connected cube sets. Let D be a connected component of bridge, and let \underline{D} be the collection of k -cubes containing a vertex of D , so that $\underline{D} \subset \underline{\text{bridge}}$. It follows from the construction of bridge that \underline{D} either intersects $\Delta Q(i)$ for some i , or \underline{D} intersects \underline{Q} . As D is connected in \mathbb{Z}^d , it is immediate that

coarse grained image \underline{D} is $*$ -connected. The set $\underline{\text{bridge}}$ is itself the union of all such cube sets \underline{D} , and it follows from the defining properties of live and almost-live ponds that $\underline{\Gamma}$ is $*$ -connected. \square

We finish the section by showing that, in the configuration ω' , each cube in $\underline{\Gamma}$ has one of two rare geometric properties, defined below. Each k -cube $\underline{B}(x)$ has $2d$ faces $\sigma_1(x), \dots, \sigma_{2d}(x)$, each of which is a $(d-1)$ -dimensional square of side-length $2k$. A *surface* of $\underline{B}(x)$ is a vertex set of the form $\sigma_i(x) \cap \mathbb{Z}^d$; each k -cube $\underline{B}(x)$ possesses $2d$ distinct surfaces. In the context of a $3k$ -cube $\underline{B}_3(x)$, a surface is any surface of any of the k -cubes $\underline{B}(x') \subset \underline{B}_3(x)$.

Definition 6.7. A k -cube $\underline{B}(x)$ is *Type-I* if there is an open path γ and a surface $\sigma \cap \mathbb{Z}^d$ in $\underline{B}_3(x)$ so that γ joins a vertex in $\underline{B}^+(x)$ to a vertex of $\partial \underline{B}_3(x) \cap \mathbb{Z}^d$, with no vertex along γ joined via another open path to $\sigma \cap \mathbb{Z}^d$. We require all paths in this definition to use only edges which are *internal* to $\underline{B}_3(x)$, that is, no edge in any path has both endpoints in $\partial \underline{B}_3(x)$.

Definition 6.8. A k -cube $\underline{B}(x)$ is *Type-II* if there are disjoint open paths γ_1 and γ_2 , each joining vertices of $\underline{B}^+(x)$ to vertices in $\partial \underline{B}_3(x)$, with no open path in $\underline{B}_3(x)$ from any vertex in γ_1 to a vertex in γ_2 . All paths in this definition are required to use only edges internal to $\underline{B}_3(x)$.

Figure 12 illustrates these geometric properties. Because of the requirement that all paths in the above definitions are internal, the event that a k -cube $\underline{B}(x)$ is Type-I or Type-II does not depend on the state of any edge contained in $\partial \underline{B}_3(x)$.

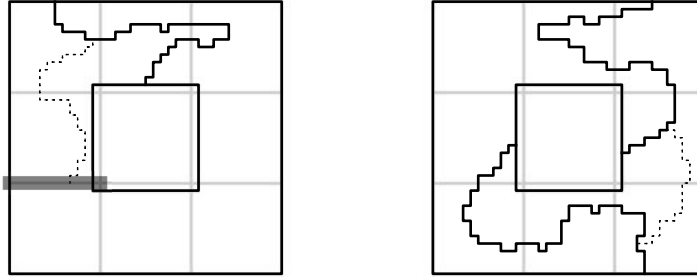

FIGURE 12. On the left is an illustration of what *cannot* happen in a Type-I cube. The dotted line is an open path joining the solid line (also an open path) to one of the surfaces of the $3k$ -cube. Likewise, on the right is an illustration of what *cannot* happen in a Type-II cube.

Proposition 6.9. *Suppose G is not contained within any $3k$ -cube. Then, in the configuration ω' , each k -cube of $\underline{\Gamma}$ is either Type-I or Type-II.*

Proof. Following Zhang, consider two cases. First suppose $\underline{B}(x) \in \underline{\Gamma}$ is a member of

$$(6.10) \quad \Delta \underline{Q} \cup \left(\bigcup_{i=1}^u \Delta \underline{Q}(i) \right).$$

Such a $\underline{B}(x)$ is $*$ -adjacent to a cube $\underline{B}(x')$ which neither intersects G nor an endpoint vertex of $\partial_o G$. By Lemma 6.5, $\underline{B}(x) \in \underline{A}$, so that $\underline{B}(x)$ contains an endpoint vertex of $\partial_o G$. Thus, $\underline{B}^+(x)$ contains a vertex $y \in G$. There can be no open path from any surface of $\underline{B}(x')$ to y : such a path could not

use an edge of $\partial_o G$ but could be extended to a path from y to ∞ using no other vertices of G . On the other hand, as G is not contained in any $3k$ -cube, there must be an open path from y to a vertex of $\partial \underline{B}_3(x)$. We may arrange this open path uses edges internal to $\underline{B}_3(x)$ by stopping it at the first vertex of $\partial \underline{B}_3(x)$ it meets. Thus in the first case, $\underline{B}(x)$ is Type-I.

In the second case, suppose $\underline{B}(x)$ is a member of

$$(6.11) \quad \underline{\text{bridge}} \setminus \left(\Delta \underline{Q} \cup \left(\bigcup_{i=1}^u \Delta \underline{Q}(i) \right) \right),$$

and let $y \in \underline{B}(x) \cap \underline{\text{bridge}}$. Then y lies in some connected component D of either C or one of the C_i . The component D cannot be contained in $\underline{B}_3(x)$, otherwise one of the k -cubes $*$ -adjacent to $\underline{B}(x)$ would be a member of either \underline{Q} or some $\underline{Q}(i)$. This is impossible as it would imply $\underline{B}(x) \in \Delta \underline{Q}$ or $\underline{B}(x) \in \Delta \underline{Q}(i)$ for some i . It follows that y is joined to the the boundary of $\underline{B}_3(x)$ by an open internal path (contained in D).

On the other hand, thanks to Lemma 6.5, the cube $\underline{B}(x)$ contains an endpoint vertex of an edge in $\partial_o G$, and $\underline{B}^+(x)$ contains a vertex $z \in G$. As G is not contained in any $3k$ -cube, the vertex z is connected to the boundary of $\underline{B}_3(x)$ by an open internal path (in G). But D and G are disjoint, thus the corresponding paths from y and z to the boundary of $\underline{B}_3(x)$ cannot lie in the same open cluster. We conclude that in this second case, $\underline{B}(x)$ is Type-II. \square

We close the section by citing that it is rare for a cube to be Type-I or Type-II when k is large.

Proposition 6.10. (*Grimmet [34], Lemma 7.89 and Zhang [64], Section 3*) *Let $d \geq 2$ and let $p > p_c(d)$. There are positive constants $c_1(p, d)$ and $c_2(p, d)$ so that for each k -cube $\underline{B}(x)$,*

$$(6.12) \quad \mathbb{P}_p(\underline{B}(x) \text{ is Type-I or Type-II}) \leq c_1 \exp(-c_2 k).$$

7. COARSE GRAINING APPLIED

The point of applying Zhang's construction to the G_n is that, as we will see, the associated cutset Γ_n has cardinality on the order of n^{d-1} with high probability. The cutset Γ_n may be thought of as a *deformation* of the contour $\partial_o G_n$, and the vertices enclosed by this deformation form a subgraph of $F_n \subset \mathbf{C}_n$ which we *flatten* into a continuum set whose perimeter is bounded by $|\Gamma_n|$. The rescaled continuum set then has a bounded perimeter (not depending on n). This is how we pass from Cheeger optimizers to sets of finite perimeter.

Our notion of closeness in Theorem 1.2 comes from the ℓ^1 -metric, thus $|G_n \Delta F_n|$ must be small. Figures 9 and 13 suggests the extra volume enclosed by Γ_n may be substantial, for instance due to ponds trapped by Γ_n . These large enclosed components are surgically removed using another application of Zhang's construction. The boundary of F_n is then more complicated than we first asserted: it is made of all contours created through Zhang's construction. We tie these contours together via an auxiliary edge set called the webbing and execute a Peierls argument to bound their total size.

7.1. Contours. We formalize the argument sketched above. Given $G_n = G_n(\omega) \in \mathcal{G}_n$, list the connected components of G_n as $G_n^{(1)}, \dots, G_n^{(M)}$. For each $G_n^{(q)}$, let ω'_q be the unique configuration obtained from ω by closing each open edge in $\partial^\omega G_n^{(q)}$. Within ω'_q , apply Zhang's construction, producing a closed cutset $\Gamma_n^{(q)}$ and k -cube set $\underline{\Gamma}_n^{(q)}$ having the properties discussed in Section 6.3.

Remark 7.1. In light of our notation for $3k$ -cubes, we emphasize that each $\underline{\Gamma}_n^{(q)}$ is a set of k -cubes.

Let ω' be the configuration built from ω in which all edges of $\partial^\omega G_n$ are closed. Given a collection of edges S , a connected component of Λ of \mathbf{C}_∞ (in ω' , see Remark 6.1) is *surrounded* by S if every path from Λ to ∞ uses an edge of S . Only the connected components of \mathbf{C}_∞ surrounded by S matter, not other open clusters. Define

$$(7.1) \quad \epsilon(d) := 1 - \frac{d}{(d-1)^2},$$

and observe $\epsilon(d)$ is positive when $d \geq 3$. Within ω' , the cutsets $\Gamma_n^{(q)}$ may surround other connected components of \mathbf{C}_∞ aside from the $G_n^{(q)}$. If Λ is such a component, say Λ is *large* if $|\Lambda| \geq n^{1-\epsilon(d)}$, and say Λ is *small* otherwise. Enumerate the large components L_1, \dots, L_m of \mathbf{C}_∞ surrounded by any of the cutsets $\Gamma_n^{(q)}$, but do not include any of the $G_n^{(q)}$ in this list. Likewise enumerate the small components S_1, \dots, S_t of \mathbf{C}_∞ surrounded by any of the cutsets $\Gamma_n^{(q)}$. Our notation suppresses the dependence of the L_i and the S_j on n, ω and G_n . Figure 13 depicts how large and small components may arise.

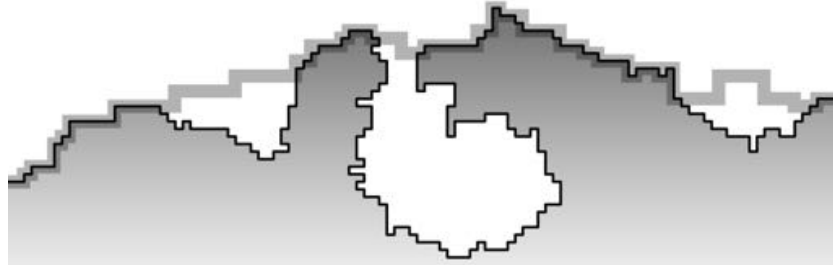

FIGURE 13. The black contour is a close-up of the boundary of some $G_n^{(q)}$. The thicker grey contour is the associated cutset $\Gamma_n^{(q)}$. It is possible that connected components of \mathbf{C}_∞ are bounded between these two contours (see Remark 6.1).

Define $F_n \subset \mathbf{C}_\infty$ from G_n by *filling in* the small components.

$$(7.2) \quad F_n := G_n \cup \left(\bigcup_{j=1}^t S_j \right).$$

We build cutsets surrounding the large components to fashion the boundary of F_n . Given a large component L_i , let ω'_i denote the configuration in which all open edges of $\partial^\omega L_i$ are closed. Within ω'_i , apply Zhang's construction, producing a closed cutset $\widehat{\Gamma}_n^{(i)}$ separating L_i from ∞ , and a corresponding k -cube set $\underline{\Gamma}_n^{(i)}$. The edge sets $\Gamma_n^{(q)}$ and $\widehat{\Gamma}_n^{(i)}$ together represent the boundary of F_n , and we define:

$$(7.3) \quad \Gamma_n := \left(\bigcup_{q=1}^M \Gamma_n^{(q)} \right) \cup \left(\bigcup_{i=1}^m \widehat{\Gamma}_n^{(i)} \right), \quad \underline{\Gamma}_n := \left(\bigcup_{q=1}^M \underline{\Gamma}_n^{(q)} \right) \cup \left(\bigcup_{i=1}^m \underline{\Gamma}_n^{(i)} \right).$$

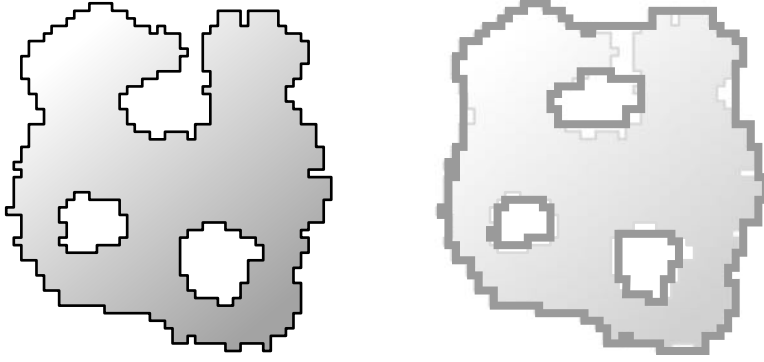

FIGURE 14. On the left is $G_n \in \mathcal{G}_n$. On the right, the thick grey contours together form the edge set Γ_n . The inner contours arise from large components and are of the form $\widehat{\Gamma}_n^{(i)}$. The outer contour corresponds to G_n itself. It is natural to wonder how these contours *interact*; we address this question at the start of Section 8.

7.2. Webbing. We now tie the contours together using an edge set called the webbing. We think of the webbing as a one-dimensional object because it is made up of paths; as the number of large components grows with n , the size of the webbing becomes too large in dimension two, which is why our argument works only in dimensions three and higher.

By, for instance, fixing an ordering of finite subsets of \mathbb{Z}^d , choose in a unique way an endpoint vertex ζ_q of an edge in $\Gamma_n^{(q)}$. Do the same for each $\widehat{\Gamma}_n^{(i)}$, calling these vertices z_i . These are the endpoints of paths making up the webbing. Let $\alpha > 0$ be a parameter to be chosen later. Consider all cubes of the form $[n^\alpha]x + [-[n^\alpha], [n^\alpha]]^d$ intersecting $[-2n, 2n]^d$, where $x \in \mathbb{Z}^d$. List these cubes as $\{\overline{B}_j\}_{j=1}^\ell$, ordered so that consecutive cubes share a face. For n sufficiently large (depending on the renormalization parameter k), all ζ_q and z_i lie in the union of the \overline{B}_j . For each $j \in \{1, \dots, \ell\}$, let m_j be the number of z_i contained in the cube \overline{B}_j .

In each \overline{B}_j , do the following: begin with $z_i \in \overline{B}_j$ least in our ordering of finite subsets of \mathbb{Z}^d . Pick (in some unique way) a not necessarily open \mathbb{Z}^d -path in \overline{B}_j joining this “smallest” vertex to the next smallest z_k , arranging for the path to use the fewest edges possible. Continue building paths between the current vertex in \overline{B}_j and the next smallest within \overline{B}_j until all z_i in \overline{B}_j are used. The union of all paths created this way is a graph T_j called a *tangle*. Define T_j to be empty if $m_j = 0$.

We link each tangle using a single long path. Begin with \overline{B}_1 and select $z_i \in \overline{B}_1$ minimal in our ordering, then select a minimal vertex from \overline{B}_2 and connect the two vertices by a uniquely chosen shortest path in \mathbb{Z}^d . Do nothing when these vertices are identical, and if at any point a cube \overline{B}_j contains no z_i , take instead the vertex of $\mathbb{Z}^d \cap \overline{B}_j$ minimal in our ordering. Continue joining consecutive vertices until the minimal vertex in the last $[n^\alpha]$ -cube has been used. Link this last vertex to ζ_1 , and then to successive ζ_q 's by uniquely chosen shortest paths until we reach ζ_M . The union of all paths created here is denoted string. We have suppressed the n , ω and G_n dependence of both string and the T_j . The webbing is

$$(7.4) \quad \text{web}_n := \text{string} \cup \left(\bigcup_{j=1}^{\ell} T_j \right).$$

To bound the size of web_n , we first bound the number of large components associated to each G_n .

Lemma 7.2. *Let $d \geq 3$ and $p > p_c(d)$. For each $G_n \in \mathcal{G}_n$, let $m(G_n, n, \omega)$ be the number of large components surrounded by the $\Gamma_n^{(q)}$. Let $M_n(\omega)$ be the maximum of $m(G_n)$ over all $G_n \in \mathcal{G}_n$. There are positive constants $c_1(p, d, k)$, $c_2(p, d, k)$ and $c_3(p, d)$ so that*

$$(7.5) \quad \mathbb{P}_p \left(M_n > c_3 n^{d-1-1/(d-1)} \right) \leq c_1 \exp \left(-c_2 n^{1/(d-1)} \right).$$

Proof. Fix $G_n \in \mathcal{G}_n$ and specialize Corollary A.2 to the setting $d \geq 3$, $\alpha = 1 - \epsilon(d)$: work within the high probability event $\{R \leq n\}$. By Lemma 6.5, all large components L_i corresponding to G_n are contained in C_{2n} . On $\{R \leq n\}$,

$$(7.6) \quad |\partial^\omega L_i| \geq cn^{1/(d-1)},$$

for each $i \in \{1, \dots, m\}$. Also work in the high probability event (from Lemma A.10) that there is $\eta_3(p, d) > 0$ so that for all $G_n \in \mathcal{G}_n$, we have $|\partial^\omega G_n| \leq \eta_3 n^{d-1}$. Use this upper bound with (7.6) and the fact that distinct large components have disjoint open edge boundaries to obtain

$$(7.7) \quad m \leq \frac{\eta_3}{c} n^{d-1-1/(d-1)}.$$

We use the estimates from Lemma A.10 and Corollary A.2 to complete the proof. \square

We now deduce bounds on the number of edges in the web_n .

Remark 7.3. In the following proof, we fix the parameter α (controlling the side-length of the cubes \bar{B}_j) to be $\frac{1}{(d-1)}$.

Proposition 7.4. *Let $d \geq 3$ and $p > p_c(d)$. Let $W_n = W_n(\omega)$ be the maximum of $|\text{E}(\text{web}_n)|$ taken over all $G_n \in \mathcal{G}_n$. There are positive constants $c_1(p, d, k)$, $c_2(p, d, k)$ and $c_3(p, d)$ so that*

$$(7.8) \quad \mathbb{P}_p \left(W_n > c_3 n^{d-1} \right) \leq c_1 \exp \left(-c_2 n^{1/(d-1)} \right).$$

Proof. Work in the high probability event from Lemma 7.2 that the maximum number M of large components L_i across all $G_n \in \mathcal{G}_n$ is at most $cn^{d-1-1/(d-1)}$. Also work in the high probability event from Corollary A.9 that the number of connected components of any $G_n \in \mathcal{G}_n$ is at most $\eta_4 > 0$.

Fix $G_n \in \mathcal{G}_n$ for the rest of the proof. Consider the tangle T_j for G_n associated to the $[n^\alpha]$ -cube \bar{B}_j . Based on our construction of each tangle, the number of edges $|\text{E}(T_j)|$ is at most the ℓ^1 -diameter of \bar{B}_j times the number of z_i within \bar{B}_j . Choosing constants below appropriately,

$$(7.9) \quad \sum_{j=1}^{\ell} |\text{E}(T_j)| \leq 8dn^\alpha \sum_{j=1}^{\ell} m_j,$$

$$(7.10) \quad \leq c(d)mn^\alpha,$$

$$(7.11) \quad \leq c(p, d)n^{\alpha+n-1-1/(d-1)},$$

where to obtain second line directly above, we use that each vertex z_i lies in at most $2d$ distinct $[n^\alpha]$ -cubes, and to obtain the third line we used Lemma 7.2. It remains to bound $|\text{E}(\text{string})|$. A shortest \mathbb{Z}^d -path between the vertices of two adjacent $[n^\alpha]$ -cubes uses at most $16n^\alpha$ edges, and there are at most $c(d)n^{d(1-\alpha)}$ cubes in total. The final paths in the construction of string which join the vertices ζ_q each use at most $c(d)n$ edges. Thus,

$$(7.12) \quad |\text{E}(\text{string})| \leq c(d)n^\alpha n^{d(1-\alpha)} + \eta_4 c(d)n,$$

so that upon choosing $\alpha := 1/(d-1)$,

$$(7.13) \quad |\mathbb{E}(\text{web}_n)| \leq c(p, d) \left[n^{\alpha+(d-1)-1/(d-1)} + n^{\alpha+d(1-\alpha)} + n \right],$$

$$(7.14) \quad \leq c(p, d)n^{d-1}.$$

Use the estimates from Lemma 7.2 and from Corollary A.9 to complete the proof. \square

We are finished working with $\lceil n^\alpha \rceil$ -cubes. Define the coarse-grained image of each web_n as

$$(7.15) \quad \underline{\text{web}}_n := \left\{ \underline{B}(x) : \underline{B}(x) \cap \text{web}_n \neq \emptyset \right\}$$

so that each $\underline{\text{web}}_n$ is a collection of k -cubes depending on n, ω and G_n . The last lemma of this subsection follows directly from the construction of web_n and from Lemma 6.6:

Lemma 7.5. *For each $G_n \in \mathcal{G}_n$, the k -cube set $\underline{\Gamma}_n \cup \underline{\text{web}}_n$ corresponding to G_n is $*$ -connected.*

7.3. A Peierls argument. We use a Peierls argument to show that when the renormalization parameter k is taken large, each $|\Gamma_n|$ is with high probability on the order of n^{d-1} . We make a small observation first.

Lemma 7.6. *For each $G_n \in \mathcal{G}_n$, any edge of \mathbb{Z}^d is contained in at most $(11k)^d$ distinct edge sets among the $\Gamma_n^{(q)}$ and the $\widehat{\Gamma}_n^{(i)}$ corresponding to G_n .*

Proof. Fix $G_n \in \mathcal{G}_n$. If $\Gamma_n^{(q)}$ uses $e \in \mathbb{E}(\mathbb{Z}^d)$, there is $\underline{B}(x) \in \underline{\Gamma}_n^{(q)}$ so that $e \in \underline{B}^+(x)$. By Lemma 6.5, \underline{B}^+ also contains a vertex $y \in G_n^{(q)}$. Suppose another cutset, say $\widehat{\Gamma}_n^{(i)}$, also uses e . Identical reasoning tells us the five-fold dilate of $\underline{B}(x)$,

$$(7.16) \quad \underline{B}_5(x) := 2kx + [-5k, 5k]^d$$

contains both y and a vertex $z \in L_i$. If cutsets corresponding to other connected components of G_n or other L_i also use e , at least one vertex in each of these graphs must also lie in $\underline{B}_5(x)$. As the components of G_n and the L_i are all disjoint, and because $\underline{B}_5(x)$ contains at most $(11k)^d$ vertices, the claim holds. \square

In the Peierls argument below, the renormalization parameter k is fixed once and for all.

Proposition 7.7. *Let $d \geq 3$ and $p > p_c(d)$. There is $\gamma = \gamma(p, d) > 0$ and positive constants $c_1(p, d)$ and $c_2(p, d)$ so that*

$$(7.17) \quad \mathbb{P}_p \left(\max_{G_n \in \mathcal{G}_n} |\Gamma_n| \geq \gamma n^{d-1} \right) \leq c_1 \exp \left(-c_2 n^{1/(d-1)} \right).$$

Proof. Let \mathcal{E}_{web} be the event from Proposition 7.4 that for all $G_n \in \mathcal{G}_n$, the corresponding graphs web_n satisfy $|\mathbb{E}(\text{web}_n)| \leq c(p, d)n^{d-1}$. We work with a fixed $G_n \in \mathcal{G}_n$ and corresponding Γ_n throughout the proof, and begin by using the bounds in Proposition 7.4 and in Lemma A.10:

$$(7.18) \quad \mathbb{P}_p \left(|\Gamma_n| \geq \gamma n^{d-1} \right) \leq c_1 \exp \left(-c_2 n^{1/(d-1)} \right) + \mathbb{P}_p \left(\left\{ |\Gamma_n| \geq \gamma n^{d-1} \right\} \cap \left\{ |\partial^\omega G_n| \leq \eta_3 n^{d-1} \right\} \cap \mathcal{E}_{\text{web}} \right),$$

$$(7.19) \quad \leq c_1 \exp \left(-c_2 n^{1/(d-1)} \right) + \sum_{j=\gamma n^{d-1}}^{\infty} \mathbb{P}_p \left(\left\{ |\Gamma_n| = j \right\} \cap \left\{ |\partial^\omega G_n| \leq (\eta_3/\gamma)j \right\} \cap \mathcal{E}_{\text{web}} \right).$$

Take γ large depending on k, p and d so that $\eta_3/\gamma < [2 \cdot 4^d(11k)^d(4k)^{d+1}]^{-1}$:

$$(7.20) \quad \mathbb{P}_p(|\Gamma_n| \geq \gamma n^{d-1}) \leq c_1 \exp(-c_2 n^{1/(d-1)})$$

$$(7.21) \quad + \sum_{j=\gamma n^{d-1}}^{\infty} \mathbb{P}_p(\{|\Gamma_n| = j\} \cap \{|\partial^\omega G_n| < [2 \cdot 4^d(11k)^d(4k)^{d+1}]^{-1} j\} \cap \mathcal{E}_{\text{web}}).$$

Equip $\underline{\Gamma}_n$ with a graph structure: the vertices are the k -cubes in $\underline{\Gamma}_n$, and an edge exists between two vertices $\underline{B}(x)$ and $\underline{B}(y)$ if $x \sim_* y$. The maximum degree of any vertex in *this* graph is 3^d , so by Theorem A.11, there is a subcollection of cubes $\underline{\Gamma}'_n \subset \underline{\Gamma}_n$ so that $|\underline{\Gamma}'_n| \geq |\underline{\Gamma}_n|/4^d$, and whenever $\underline{B}(x), \underline{B}(y) \in \underline{\Gamma}'_n$, the corresponding $3k$ -cubes $\underline{B}_3(x)$ and $\underline{B}_3(y)$ have disjoint interiors. Thus,

$$(7.22) \quad |\underline{\Gamma}'_n| \geq \frac{|\underline{\Gamma}_n|}{4^d} \geq \frac{|\Gamma_n|}{4^d(11k)^d(4k)^{d+1}},$$

as when $k \geq d$, there are at most $(4k)^{d+1}$ edges of \mathbb{Z}^d having an endpoint in a given augmented k -cube, and Lemma 7.6 implies each such edge lies in at most $(11k)^d$ distinct cutsets among the $\Gamma_n^{(q)}$ and $\widehat{\Gamma}_n^{(i)}$. Consider the following event:

$$(7.23) \quad \{|\Gamma_n| = j\} \cap \{|\partial^\omega G_n| < [2 \cdot 4^d(11k)^d(4k)^{d+1}]^{-1} j\} \cap \mathcal{E}_{\text{web}}.$$

Within (7.23), we know from (7.22) that at most half of the cubes in $\underline{\Gamma}'_n$ may contain an edge of $\partial^\omega G_n$. Thus there is a further subcollection $\underline{\Gamma}''_n \subset \underline{\Gamma}'_n$ so that

$$(7.24) \quad |\underline{\Gamma}''_n| \geq \frac{|\Gamma_n|}{2 \cdot 4^d(11k)^d(4k)^{d+1}},$$

such that each cube of $\underline{\Gamma}''_n$ is either Type-I or Type-II by Proposition 6.9.

Of course, $\underline{\Gamma}''_n$ inherits from $\underline{\Gamma}'_n$ the property that any two $\underline{B}(x), \underline{B}(y) \in \underline{\Gamma}''_n$ are such that $\underline{B}_3(x)$ and $\underline{B}_3(y)$ have disjoint interiors. Thus, for distinct $\underline{B}(x)$ and $\underline{B}(y)$ in $\underline{\Gamma}''_n$, the event that $\underline{B}(x)$ is Type-I or Type-II is independent from the event that $\underline{B}(y)$ is Type-I or Type-II.

Continue to work within (7.23). Write $s := |\underline{\Gamma}''_n|$; on \mathcal{E}_{web} , we have $|\underline{\text{web}}_n| \leq c(p, d)n^{d-1}$. By Proposition 7.5, $\underline{\Gamma}_n \cup \underline{\text{web}}_n$ is $*$ -connected, so Proposition A.12 implies there are at most

$$(7.25) \quad (3n)^d [c(d)]^{s+cn^{d-1}}$$

distinct possibilities for the k -cube set $\underline{\Gamma}_n \cup \underline{\text{web}}_n$. The factor of $(3n)^d$ is a crude upper bound on the number of vertices in $\mathbb{Z}^d \cap [-n, n]^d$. There are at most $2^{s+cn^{d-1}}$ ways to choose $\underline{\Gamma}_n$ from $\underline{\Gamma}_n \cup \underline{\text{web}}_n$, at most the same number of ways to choose $\underline{\Gamma}'_n$ from $\underline{\Gamma}_n$ and likewise for $\underline{\Gamma}''_n$ from $\underline{\Gamma}'_n$. We use a union bound and aforementioned independence to obtain

$$(7.26) \quad \mathbb{P}_p(\{|\Gamma_n| = j\} \cap \{|\partial^\omega G_n| < [2 \cdot 4^d(11k)^d(4k)^{d+1}]^{-1} j\} \cap \mathcal{E}_{\text{web}})$$

$$(7.27) \quad \leq (3n)^d [c(d)]^{s+cn^{d-1}} [c_1 \exp(-c_2 k)]^{s/(2 \cdot 4^d)}.$$

Above, we've used the lower bound on $|\underline{\Gamma}''_n|$ in terms of s following from (7.22) and Proposition 6.10. From (7.22) we have $s \geq j/(11k)^d(4k)^{d+1}$, and as $j \geq \gamma n^{d-1}$, we may take γ larger if necessary, again in a way depending on k, p and d , so that $s \geq cn^{d-1}$, giving

$$(7.28) \quad \mathbb{P}_p(\{|\Gamma_n| = j\} \cap \{|\partial^\omega G_n| < [2 \cdot 4^d(11k)^d(4k)^{d+1}]^{-1} j\} \cap \mathcal{E}_{\text{web}})$$

$$(7.29) \quad \leq (3n)^d [c(d)]^{2s} [c_1 \exp(-c_2 k)]^{s/(2 \cdot 4^d)}$$

Choose k large enough depending on p and d so that $[c(d)]^2 [c_1 \exp(-c_2 k)]^{1/2 \cdot 4^d} < e^{-1}$, at which point k is fixed. For this k ,

$$(7.30) \quad \mathbb{P}_p\left(\left\{|\Gamma_n| = j\right\} \cap \left\{|\partial^\omega G_n| < [2 \cdot 4^d \eta_4 (4k)^{d+1}]^{-1} j\right\} \cap \mathcal{E}_{\text{web}}\right) \leq (3n)^d \exp(-s),$$

and we combine this bound with (7.20) and (7.22) to obtain

$$(7.31) \quad \mathbb{P}_p\left(|\Gamma_n| \geq \gamma n^{d-1}\right) \leq c_1 \exp\left(-c_2 n^{1/(d-1)}\right) + \sum_{j=\gamma n^{d-1}}^{\infty} (3n)^d \exp(-s),$$

$$(7.32) \quad \leq c_1 \exp\left(-c_2 n^{1/(d-1)}\right) + \sum_{j=\gamma n^{d-1}}^{\infty} (3n)^d \exp\left(-j / [(11k)^d (4k)^{d+1}]\right).$$

We choose γ sufficiently large depending on p, d and $k = k(p, d)$ to complete the proof. \square

Remark 7.8. In the proof of Proposition 7.7, the renormalization parameter $k = k(p, d)$ has been fixed. All constructions given in Sections 6 and 7 depended implicitly on this parameter.

7.4. Properties of F_n . Having exhibited control on $|\Gamma_n|$, we now return to the F_n defined in (7.2). We asserted that Γ_n could be thought of as the boundary of F_n ; the next proposition justifies this. By Lemma 6.5, we can only conclude $F_n \subset [-n - 2k, n + 2k]^d$ instead of $F_n \subset [-n, n]^d$. Recall the convention that for $E \subset \mathbb{R}^d$ and $S \subset E(\mathbb{Z}^d)$, we say $E \cap S \neq \emptyset$ if E contains an endpoint vertex of an edge in S .

Proposition 7.9. *Let $d \geq 3$ and $p > p_c(d)$. Define $\ell(n) := \lfloor n^{(1-\epsilon(d))/2d} \rfloor$. There are positive constants $c_1(p, d)$ and $c_2(p, d)$ so that with probability at least*

$$(7.33) \quad 1 - c_1 \exp\left(-c_2 n^{(1-\epsilon(d))/2d}\right),$$

whenever F_n corresponds to $G_n \in \mathcal{G}_n$, and whenever $B = [-\ell(n), \ell(n)]^d + x$, for some $x \in \mathbb{Z}^d$ satisfies $B \cap F_n \neq \emptyset$ and $B \cap F_n \neq B \cap C_\infty$, then either $B \cap \Gamma_n \neq \emptyset$, or else the three-fold dilate of B around its center intersects $\partial^\omega G_n$ non-trivially.

Proof. Fix $G_n \in \mathcal{G}_n$, and consider F_n corresponding to G_n . Let B be as in the statement of the proposition, so that $B \cap F_n \neq \emptyset$ and $B \cap F_n \neq B \cap C_\infty$. Write $B = [-\ell(n), \ell(n)]^d + x$ for $x \in \mathbb{Z}^d$, and define

$$(7.34) \quad B_3 := [-3\ell(n), 3\ell(n)]^d + x.$$

Suppose B contains $y \in C_\infty \setminus F_n$ connected to ∞ by a (not necessarily open) \mathbb{Z}^d -path γ' using no edges of Γ_n . As $B \cap F_n \neq \emptyset$, B contains some vertex z which is either a member of some $G_n^{(q)}$ or some small component S_j . If γ is a path from z to y in B , γ must use an edge of Γ_n , otherwise Γ_n would not surround some $G_n^{(q)}$ or some S_j .

Thus we may suppose every vertex $y \in (C_\infty \setminus F_n) \cap B$ is surrounded by one of the cutsets $\Gamma_n^{(q)}$ or $\widehat{\Gamma}_n^{(i)}$. Any y with this property lies in some large component L_i . Choose $z \in F_n \cap B$, and suppose $B_3 \cap \partial^\omega G_n = \emptyset$, so there is no open path from z to y in B_3 .

Work within the high probability event from Lemma A.8 that for each $G_n \in \mathcal{G}_n$, every connected component of G_n satisfies $|G_n^{(q)}| \geq \eta_1 n^d$. For all n sufficiently large, the connected component of F_n containing z is not contained within B_3 . Likewise, by the largeness of each L_i , and due to our choice of $\ell(n)$, no L_i is contained in B_3 .

Thus there is an open path from z to $\partial_*(B_3 \cap \mathbb{Z}^d)$ and an open path from y to $\partial_*(B_3 \cap \mathbb{Z}^d)$, and these paths are not joined by any open path in B_3 . We have shown that, if B does not contain an edge of Γ_n , and if $B_3 \cap \partial^\omega G_n = \emptyset$, then B_3 has the Type-II property (see Definition 6.8). Use Proposition 6.10 with a union bound (taken over all such B centered at $x \in \mathbb{Z}^d \cap [-n - 2k, n + 2k]^d$) to see that with probability at most

$$(7.35) \quad (3n)^d c_1 \exp\left(-c_2 n^{(1-\epsilon(n))/2d}\right),$$

there is a cube B of this form with the Type-II property. Combine this with the bounds of Lemma A.8 to complete the proof. \square

To prepare for the contiguity argument in the next section, we demonstrate that when F_n and G_n are encoded as measures, they roughly agree on Borel sets. In Section 2, from each $G_n \in \mathcal{G}_n$ we built the empirical measure $\mu_n \in \mathcal{M}([-1, 1]^d)$ defined in (2.5). For each F_n associated to $G_n \in \mathcal{G}_n$, define the *empirical measure* $\tilde{\mu}_n$ associated to F_n similarly:

$$(7.36) \quad \tilde{\mu}_n := \frac{1}{n^d} \sum_{x \in \mathbb{V}(F_n)} \delta_{x/n}.$$

Note that $\tilde{\mu}_n$ is a signed Borel measure on $[-1 - 2k/n, 1 + 2k/n]^d$.

Lemma 7.10. *Let $d \geq 3$ and let $p > p_c(d)$. There are positive constants $c_1(p, d)$, $c_2(p, d)$ and $\eta_3(p, d)$ so that for each Borel $K \subset [-1 - 2k/n, 1 + 2k/n]^d$,*

$$(7.37) \quad \mathbb{P}\left(\max_{G_n \in \mathcal{G}_n} |\mu_n(K) - \tilde{\mu}_n(K)| > \eta_3 n^{-\epsilon(d)}\right) \leq c_1 \exp\left(-c_2 n^{(d-1)/2d}\right).$$

Proof. Work within the high probability event from Lemma A.10 $|\partial^\omega G_n| \leq \eta_3 n^{d-1}$ for all $G_n \in \mathcal{G}_n$. For each small component S_j , the edge set $\partial^\omega S_j$ intersects $\partial^\omega G_n$. The $\partial^\omega S_j$ are pairwise disjoint, thus the number t of small components S_j is at most $\eta_3 n^{d-1}$. From the definition of a small component,

$$(7.38) \quad |F_n \setminus G_n| = \sum_{j=1}^t |S_j| \leq \eta_3 n^{d-\epsilon(d)}$$

The lemma follows from the definitions of empirical measures for G_n (2.5) and F_n (7.36). \square

8. CONTIGUITY

We now pass from each F_n (7.2) to a continuum object through another coarse graining procedure. The empirical measures $\tilde{\mu}_n$ (7.36) associated to each F_n become *flattened* or homogenized into measures representing sets of finite perimeter.

Remark 8.1. We rely heavily on the notation introduced in the previous section, in particular, we reference the large components $\{L_i\}_{i=1}^m$ defined in Section 7.2 for a given $G_n \in \mathcal{G}_n$. We no longer use k -cubes, and the renormalization parameter k of the last section will not come up except to say that the empirical measures $\tilde{\mu}_n$ are elements of $\mathcal{M}([-1 - 2k/n, 1 + 2k/n]^d)$. The parameter k has itself been fixed since the proof of Proposition 7.7.

Let us build the relevant continuum objects. Given a finite collection of edges S , define

$$(8.1) \quad \text{hull}(S) := \left\{ x \in \mathbb{Z}^d : \text{any } \mathbb{Z}^d\text{-path from } x \text{ to } \infty \text{ must use an edge of } S \right\},$$

and recall that for $x \in \mathbb{Z}^d$, the unit dual cube $Q(x)$ is defined as $[-1/2, 1/2]^d + x$. For fixed $G_n \in \mathcal{G}_n$, enumerate the connected components of G_n as $\{G_n^{(q)}\}_{q=1}^M$ and for each $q \in \{1, \dots, M\}$, define

$$(8.2) \quad A_q := \left\{ i \in \{1, \dots, m\} : L_i \text{ is surrounded by } \Gamma_n^{(q)} \right\}.$$

For each $q \in \{1, \dots, M\}$, define $H_n^{(q)}$ as the following *collection of vertices*

$$(8.3) \quad H_n^{(q)} := \text{hull}\left(\Gamma_n^{(q)}\right) \setminus \left(\bigcup_{i \in A_q} \text{hull}\left(\widehat{\Gamma}_n^{(i)}\right) \right),$$

and let $H_n = \bigcup_{q=1}^M H_n^{(q)}$. Define the polytope P_n from H_n via

$$(8.4) \quad P_n = \left(\bigcup_{x \in H_n} n^{-1}Q(x) \right) \cap [-1, 1]^d.$$

Finally, form the measure $\nu_n = \nu_n(\omega, G_n) \in \mathcal{M}([-1, 1]^d)$ representing P_n in the sense of Section 2.2: for $E \subset [-1, 1]^d$ Borel,

$$(8.5) \quad \nu_n(E) := \theta_p(d)\mathcal{L}^d(E \cap P_n),$$

The goal of this section is to show for each G_n , the measures $\mu_n, \widetilde{\mu}_n$ and ν_n are all close in the metric \mathfrak{d} defined in (2.6).

8.1. Contour and perimeter control. We thought of the edge sets Γ_n , defined in (7.3), as collections of contours, as in Figure 14. To prove \mathfrak{d} -closeness of $\widetilde{\mu}_n$ and ν_n , we first examine how such contours interact with one another and rule out pathological configurations.

For a fixed G_n , consider the large components L_i : each is surrounded by some cutset $\Gamma_n^{(q)}$. A large component L_i is *bad* if it is surrounded by $\Gamma_n^{(q)}$, with the corresponding connected component $G_n^{(q)}$ of G_n surrounded by $\widehat{\Gamma}_n^{(i)}$. If L_i is bad, subtracting the hull of $\widehat{\Gamma}_n^{(i)}$ in (8.3) from the hull of $\Gamma_n^{(q)}$ removes $G_n^{(q)}$ itself, and we cannot expect ν_n and $\widetilde{\mu}_n$ to be close.

Lemma 8.2. *For each $G_n \in \mathcal{G}_n$, it is impossible for any associated large component to be bad, in the sense just defined.*

Proof. Fix $G_n \in \mathcal{G}_n$, and suppose L_i is a bad large component associated to G_n . Recall that ω'_q is the configuration obtained from ω by closing each open edge in $\partial^\omega G_n^{(q)}$. As L_i is surrounded by $\Gamma_n^{(q)}$, it follows that $\partial_o L_i$ is a closed cutset separating L_i from ∞ in ω'_q (one must remember that the large components were defined as the connected components of the infinite cluster after passing to ω'_q). Back in ω , it follows that

$$(8.6) \quad \partial_o L_i \cap \partial^\omega L_i \subset \partial^\omega G_n^{(q)}.$$

Let us see how this gives rise to a contradiction: let $y \in G_n^{(q)}$. Working in the original configuration ω , consider a simple path γ from y to ∞ within \mathbf{C}_∞ , so that γ uses only open edges. We may assume that y is the only vertex of $G_n^{(q)}$ used by γ , as γ must eventually leave $G_n^{(q)}$ and not return. Because $G_n^{(q)}$ is surrounded by $\widehat{\Gamma}_n^{(i)}$, γ must use an open edge e in $\widehat{\Gamma}_n^{(i)}$. As $\widehat{\Gamma}_n^{(i)}$ is a closed cutset in

the configuration ω'_i , this open edge e must lie in $\partial^\omega L_i$. We have shown γ uses a vertex of L_i , and thus γ contains an open path from L_i to ∞ using no vertices of $G_n^{(q)}$, contradicting (8.6). \square

We extract another useful observation from the proof of Lemma 8.2.

Lemma 8.3. *Let $G_n \in \mathcal{G}_n$. Each large component L_i corresponding to G_n is surrounded by exactly one cutset $\Gamma_n^{(q)}$ associated to a connected component $G_n^{(q)}$ of G_n .*

Proof. Fix $G_n \in \mathcal{G}_n$. Each large component L_i associated to G_n is surrounded by at least one of the cutsets $\Gamma_n^{(q)}$. Suppose L_i is surrounded by $\Gamma_n^{(q)}$ and by $\Gamma_n^{(q')}$ for $q \neq q'$. Appealing to (8.6) in the proof of Lemma 8.2, we find $\partial_o L_i \cap \partial^\omega L_i \subset \partial^\omega G_n^{(q)}$ and $\partial_o L_i \cap \partial^\omega L_i \subset \partial^\omega G_n^{(q')}$. As $L_i \subset \mathbf{C}_\infty$, the edge set $\partial_o L_i \cap \partial^\omega L_i$ is non-empty, thus $\partial^\omega G_n^{(q)} \cap \partial^\omega G_n^{(q')}$ is non-empty. But this is impossible, as distinct connected components of G_n must have disjoint open edge boundary. \square

We use Lemma 8.2 to relate F_n and H_n .

Lemma 8.4. *For each $G_n \in \mathcal{G}_n$, the vertices of F_n are contained in H_n . Moreover, the vertex set of F_n is identically $H_n \cap \mathbf{C}_\infty$.*

Proof. Fix $G_n \in \mathcal{G}_n$. We begin with *Claim (1)*: if $y \in F_n$ and $y \notin H_n$, there are L_i and $G_n^{(q)}$ so that y is surrounded by $\Gamma_n^{(q)}$ and $\widehat{\Gamma}_n^{(i)}$, with L_i itself surrounded by $\Gamma_n^{(q)}$. *Claim (1)* follows directly from the definition of H_n : as $y \in F_n$, we have $y \in \text{hull}(\Gamma_n^{(q)})$ for some q . From the definition of H_n , $y \notin H_n$ implies y is surrounded by some $\widehat{\Gamma}_n^{(i)}$ for $i \in A_q$, where we recall that A_q indexes the large components L_i which are surrounded by $\Gamma_n^{(q)}$.

Suppose for the sake of contradiction there is $y \in F_n \setminus H_n$, and consider L_i and $G_n^{(q)}$ given by *Claim (1)*. Pass to the configuration ω'_i in which each edge of $\partial^\omega L_i$ is closed. In this configuration, $\widehat{\Gamma}_n^{(i)}$ consists only of closed edges. Let Λ be the open cluster containing y in the configuration ω'_i , so that Λ is surrounded by $\widehat{\Gamma}_n^{(i)}$.

Claim (2) is that Λ contains $F_n^{(q)}$, defined to be the connected component of F_n containing $G_n^{(q)}$. Let $z \in F_n^{(q)}$ and suppose for the sake of contradiction that $z \notin \Lambda$. Let γ be a path from y to z within $F_n^{(q)}$, so that in ω , the path γ uses only open edges. From the assumption $z \notin \Lambda$, if we pass to ω'_i , we see γ uses a closed edge e , which is necessarily an element of $\partial^\omega L_i$ back in ω .

As γ is a path in $F_n^{(q)}$, it joins two vertices which are either in G_n or in one of the small components S_j . But $e \in \partial^\omega L_i$, so an endpoint of e must also lie in L_i . It is impossible for e to satisfy all these requirements. Thus, *Claim (2)* holds, and consequently $G_n^{(q)} \subset \Lambda$. In particular, $G_n^{(q)}$ is surrounded by $\widehat{\Gamma}_n^{(i)}$, which implies through *Claim (1)* that L_i is bad. We apply Lemma 8.2 to conclude the vertex set of F_n is contained in H_n .

Thus, $F_n \subset H_n \cap \mathbf{C}_\infty$, and to complete the proof it remains to show the opposite containment. This is immediate from the construction of H_n . Indeed, suppose $x \in H_n \cap \mathbf{C}_\infty$. Then x is surrounded by some $\Gamma_n^{(q)}$, and hence x is either in $G_n^{(q)}$ for some q , or x is an element of one of the large or small components (L_i or S_j) associated to G_n . It is impossible for x to lie in any L_i , as these components were excised in the construction (8.3) of H_n . \square

In the last result of this subsection, we use Proposition 7.7 to bound the perimeter of each P_n .

Corollary 8.5. *Let $d \geq 3$ and $p > p_c(d)$. There are positive constants $c_1(p, d)$, $c_2(p, d)$ and $\gamma(p, d)$ so that*

$$(8.7) \quad \mathbb{P}_p \left(\max_{G_n \in \mathcal{G}_n} \text{per}(nP_n) \geq \gamma n^{d-1} \right) \leq c_1 \exp(-c_2 n^{1/(d-1)}).$$

Proof. Work in the event \mathcal{E} corresponding to Proposition 7.7 that for each $G_n \in \mathcal{G}_n$, the corresponding cutset Γ_n satisfies $|\Gamma_n| < \gamma n^{d-1}$. Define the polytope $n\tilde{P}_n$ as

$$(8.8) \quad n\tilde{P}_n := \bigcup_{x \in H_n} Q(x).$$

Every boundary face of $n\tilde{P}_n$ has \mathcal{H}^{d-1} -measure one, and these boundary faces are in one-to-one correspondence with Γ_n . Thus, in \mathcal{E} , the polytope $n\tilde{P}_n$ has perimeter at most γn^{d-1} . As $nP_n = n\tilde{P}_n \cap [-n, n]^d$, the perimeter of nP_n is at most $\gamma n^{d-1} + 2d(2n)^{d-1}$, completing the proof. \square

8.2. A contiguity argument. Recall the metric \mathfrak{d} introduced in (2.6) We adapt the argument of Section 16.2 of [16] to our situation to show μ_n and ν_n are \mathfrak{d} -close with high probability.

Remark 8.6. We use another renormalization argument, now at a different scale. It is convenient to reuse notation from Section 6. Define $\ell(n) := \lfloor n^{(1-\epsilon(d))/2d} \rfloor$, and suppress the dependence of on n by writing $\ell(n)$ as ℓ . Redefine $\underline{B}(x)$ to be the ℓ -cube $(2\ell)x + [-\ell, \ell]^d$. We also work with 3ℓ -cubes, defined as in (6.3), insofar as they are present in the statement of Proposition 7.9.

For $\delta > 0$, introduce the \mathbb{Z}^d -process $\{Z_x^{(\delta)}\}_{x \in \mathbb{Z}^d}$, with each $Z_x^{(\delta)}$ the indicator function of

$$(8.9) \quad \left\{ \frac{|\mathbf{C}_\infty \cap \underline{B}(x)|}{\mathcal{L}^d(\underline{B}(x))} \in (\theta_p(d) - \delta, \theta_p(d) + \delta) \right\}.$$

Using Corollary A.4 and a careful examination of the contours defining F_n and nP_n , we show $\tilde{\mu}_n$ and ν_n are close. Recall that $\epsilon(d)$ was defined in (7.1).

Proposition 8.7. *Let $d \geq 3$ and let $p > p_c(d)$. Let $Q \subset [-1, 1]^d$ be an axis-parallel cube. For all $\delta > 0$, there are positive constants $c_1(p, d, \delta)$ and $c_2(p, d, \delta)$ so that*

$$(8.10) \quad \mathbb{P}_p \left(\max_{G_n \in \mathcal{G}_n} |\tilde{\mu}_n(Q) - \nu_n(Q)| \geq \delta \right) \leq c_1 \exp(-c_2 n^{(1-\epsilon(d))/2d}).$$

Proof. Fix $G_n \in \mathcal{G}_n$, and let $F_n, \tilde{\mu}_n, P_n$ and ν_n be the objects constructed above for this G_n . Throughout the proof, we use bounds involving positive constants $c(d)$, $c(p, d)$ and so on, which may change from line to line. Let \underline{L} denote the following collection of ℓ -cubes:

$$(8.11) \quad \underline{L} := \left\{ \underline{B}(x) : \underline{B}(x) \cap [-n - 2k, n + 2k]^d \neq \emptyset \right\},$$

For each ℓ -cube $\underline{B}(x)$, we have the bounds

$$(8.12) \quad \tilde{\mu}_n(n^{-1}\underline{B}(x)) \leq c(d) \left(\frac{\ell}{n} \right)^d, \quad \nu_n(n^{-1}\underline{B}(x)) \leq c(d) \left(\frac{\ell}{n} \right)^d.$$

The boundary ∂Q intersects at most $c(d)n^{d-1}$ cubes $\underline{B}(x)$, thus by (8.12), we have

$$(8.13) \quad |\tilde{\mu}_n(Q) - \nu_n(Q)| \leq c(d) \left(\frac{\ell^d}{n} \right) + \sum_{\underline{B}(x) \in \underline{L}} \left| \tilde{\mu}_n(n^{-1}\underline{B}(x)) - \nu_n(n^{-1}\underline{B}(x)) \right|.$$

Define

$$(8.14) \quad \mathcal{E}_1 := \left\{ \max_{G_n \in \mathcal{G}_n} \text{per}(nP_n) < \gamma n^{d-1} \right\}, \quad \mathcal{E}_2 := \left\{ \max_{G_n \in \mathcal{G}_n} |\Gamma_n| < \gamma n^{d-1} \right\},$$

$$(8.15) \quad \mathcal{E}_3 := \left\{ \max_{G_n \in \mathcal{G}_n} |\partial^\omega G_n| \leq \eta_3 n^{d-1} \right\},$$

so that \mathcal{E}_1 , \mathcal{E}_2 and \mathcal{E}_3 are respectively high probability events from Corollary 8.5, Proposition 7.7 and Lemma A.10. Finally, let \mathcal{E}_4 be the high probability event in the statement of Proposition 7.9. Work within the intersection of \mathcal{E}_1 through \mathcal{E}_4 . This allows us to think of nP_n and F_n as objects with perimeters on the order of n^{d-1} .

Motivated by \mathcal{E}_4 , define $\underline{L}' \subset \underline{L}$ as

$$(8.16) \quad \underline{L}' := \left\{ \underline{B}(x) \in \underline{L} : \begin{array}{l} \underline{B}(x) \cap nP_n = \emptyset \text{ or } \underline{B}(x) \cap nP_n = \underline{B}(x) \\ \text{and} \\ \underline{B}(x) \cap F_n = \emptyset \text{ or } \underline{B}(x) \cap F_n = \underline{B}(x) \cap \mathbf{C}_\infty \end{array} \right\}.$$

From working in \mathcal{E}_1 through \mathcal{E}_4 , there are at most $c(p, d)n^{d-1}$ ℓ -cubes $\underline{B}(x)$ in $\underline{L} \setminus \underline{L}'$. This is especially due to the event \mathcal{E}_4 from Proposition 7.9, which was designed for use here. Thus,

$$(8.17) \quad |\bar{\mu}_n(Q) - \nu_n(Q)| \leq c(p, d) \left(\frac{\ell^d}{n} \right) + \sum_{\underline{B}(x) \in \underline{L}'} \left| \bar{\mu}_n(n^{-1}\underline{B}(x)) - \nu_n(n^{-1}\underline{B}(x)) \right|.$$

Define a further subcollection of boxes, $\underline{L}'' \subset \underline{L}'$:

$$(8.18) \quad \underline{L}'' := \left\{ \underline{B}(x) \in \underline{L}' : \begin{array}{l} \underline{B}(x) \cap nP_n = \emptyset \text{ and } \underline{B}(x) \cap F_n = \emptyset \\ \text{or} \\ \underline{B}(x) \cap nP_n = \underline{B}(x) \text{ and } \underline{B}(x) \cap F_n = \underline{B}(x) \cap \mathbf{C}_\infty \end{array} \right\}.$$

We claim $\underline{L}'' = \underline{L}'$. To prove this, we show two of the four cases defining \underline{L}' are impossible.

Case (i): Suppose $\underline{B}(x) \cap F_n = \underline{B}(x) \cap \mathbf{C}_\infty$ and $\underline{B}(x) \cap nP_n = \emptyset$. Appealing to Lemma 8.4, as $F_n \subset H_n$, this is impossible unless $\mathbf{C}_\infty \cap \underline{B}(x) = \emptyset$, one of the two allowed options.

Case (ii): Suppose $\underline{B}(x) \cap F_n = \emptyset$ and $\underline{B}(x) \cap nP_n = \underline{B}(x)$. If $\underline{B}(x) \cap \mathbf{C}_\infty = \emptyset$, we are in one of the two allowed options, so we may assume there is $y \in \underline{B}(x) \cap \mathbf{C}_\infty$. As $\underline{B}(x) \cap nP_n = \underline{B}(x)$, it follows that $y \in H_n$. Thus y is surrounded by some $\Gamma_n^{(q)}$, and either $y \in F_n$ or $y \in L_i$ for some i . The former option is impossible by hypothesis, and $y \in L_i$ for some i . By Lemma 8.3, L_i is surrounded by exactly one of the $\Gamma_n^{(q)}$, and $y \in H_n$ implies $y \in H_n^{(q)}$ and $y \notin H_n^{(q')}$ whenever $q' \neq q$. But in the construction of $H_n^{(q)}$, the hull of $\widehat{\Gamma}_n^{(i)}$ is removed from the hull of $\Gamma_n^{(q)}$. As the hull of $\widehat{\Gamma}_n^{(i)}$ contains L_i and hence y , it is impossible that $y \in H_n^{(q)}$, a contradiction.

We thus conclude $\underline{L}'' = \underline{L}'$. Replace \underline{L}' by \underline{L}'' in (8.17) and use the defining properties of \underline{L}'' with the definitions of $\bar{\mu}_n$ and ν_n :

$$(8.19) \quad |\bar{\mu}_n(Q) - \nu_n(Q)| \leq c(p, d) \left(\frac{\ell^d}{n} \right) + \sum_{\underline{B}(x) \in \underline{L}''} \left| \bar{\mu}_n(n^{-1}\underline{B}(x)) - \nu_n(n^{-1}\underline{B}(x)) \right|,$$

$$(8.20) \quad \leq c(p, d) \left(\frac{\ell^d}{n} \right) + \sum_{\underline{B}(x) \in \underline{L}''} \left(\left| \frac{|\mathbf{C}_\infty \cap \underline{B}(x)|}{n^d} - \frac{\theta_p(d)\mathcal{L}^d(\underline{B}(x))}{n^d} \right| \right).$$

Form one last high probability event \mathcal{E}_5 using the \mathbb{Z}^d -process $\{Z_x^{(\delta)}\}_{x \in \mathbb{Z}^d}$: let \mathcal{E}_5 be the event that $Z_x^{(\delta)} = 1$ for all x with $\underline{B}(x) \in \underline{L}''$. By Corollary A.4, there are $c_1(p, d, \delta), c_2(p, d, \delta) > 0$ so that

$$(8.21) \quad \mathbb{P}(\mathcal{E}_5^c) \leq c(d)n^d c_1 \exp\left(-c_2 n^{(1-\epsilon(d))/2d}\right).$$

Working now in the intersection of \mathcal{E}_1 through \mathcal{E}_5 , bound $|\tilde{\mu}_n(Q) - \nu_n(Q)|$, continuing from (8.20):

$$(8.22) \quad |\tilde{\mu}_n(Q) - \nu_n(Q)| \leq c(p, d) \left(\frac{\ell^d}{n}\right) + |\underline{L}''| \max_{\underline{B}(x) \in \underline{L}''} \left(\left| \frac{|\mathbf{C}_\infty \cap \underline{B}(x)|}{n^d} - \frac{\theta_p(d)\mathcal{L}^d(\underline{B}(x))}{n^d} \right| \right),$$

$$(8.23) \quad \leq c(p, d) \left(\frac{\ell^d}{n}\right) + \frac{|\underline{L}''|}{n^d} (2\mathcal{L}^d(\underline{B}(x))\delta),$$

$$(8.24) \quad \leq c(p, d) \left(\frac{\ell^d}{n}\right) + c(d)\delta,$$

where we have used the bound $|\underline{L}''| \leq |\underline{L}| \leq c(d)(n/\ell)^d$ in going from the second line to the third line directly above. Take n sufficiently large to get $|\tilde{\mu}_n(Q) - \nu_n(Q)| \leq c(p, d)\delta$. The proof is completed by using bounds for the probabilities of $\mathcal{E}_1, \dots, \mathcal{E}_5$. \square

We combine the preceding result with Lemma 7.10 to establish \mathfrak{d} -closeness of μ_n and ν_n . The following is the central theorem of this section.

Theorem 8.8. *Let $d \geq 3$, $p > p_c(d)$ and let $\delta > 0$. There are positive constants $c_1(p, d, \delta), c_2(p, d, \delta)$ so that*

$$(8.25) \quad \mathbb{P}_p \left(\max_{G_n \in \mathcal{G}_n} \mathfrak{d}(\mu_n, \nu_n) \geq \delta \right) \leq c_1 \exp\left(-c_2 n^{(1-\epsilon(d))/2d}\right).$$

Proof. Let $\delta > 0$ and let $\Delta^k \equiv \Delta^{k,d}$ denote the dyadic cubes in $[-1, 1]^d$ at scale k , introduced in Section 2.2. There is no confusion between the integer k used for dyadic scales and the renormalization parameter from Sections 6 and 7, as the latter is fixed (see Remark 8.1). For $Q \in \Delta^k$, use Lemma 7.10 and Proposition 8.7 to find positive constants $c_1(p, d, \delta), c_2(p, d, \delta)$ so that

$$(8.26) \quad \mathbb{P}_p \left(\max_{G_n \in \mathcal{G}_n} |\mu_n(Q) - \nu_n(Q)| < \delta \right) \geq 1 - c_1 \exp\left(-c_2 n^{(1-\epsilon(d))/2d}\right).$$

Choose j large enough so that $2^{-j} < \delta$, and let Q_1, \dots, Q_m enumerate all dyadic cubes at scales between 0 and $j-1$ contained in $[-1, 1]^d$. The number m of these cubes depends only on δ and d . Let \mathcal{E}_i be the high probability event corresponding to (8.26) for Q_i , and work in $\mathcal{E} := \bigcap_{i=1}^m \mathcal{E}_i$, so that by definition (2.6) of the metric \mathfrak{d} ,

$$(8.27) \quad \mathfrak{d}(\mu_n, \nu_n) \leq \sum_{k=0}^{j-1} \frac{1}{2^k} \sum_{Q \in \Delta^k} \frac{1}{|\Delta^k|} |\mu_n(Q) - \nu_n(Q)| + \sum_{k=j}^{\infty} \frac{1}{2^k} \sum_{Q \in \Delta^k} \frac{1}{|\Delta^k|} |\mu_n(Q) - \nu_n(Q)|,$$

$$(8.28) \quad \leq 2\delta + \sum_{k=j}^{\infty} \frac{1}{2^k} \sum_{Q \in \Delta^k} \frac{1}{|\Delta^k|} |\mu_n(Q) - \nu_n(Q)|.$$

We control the sum directly above via crude bounds: there is $c(d) > 0$ so that for each dyadic cube Q , we have $\mu_n(Q) \leq c(d)$ and $\nu_n(Q) \leq c(d)$. Through our choice of j , the sum in (8.28) is then bounded by $c(d)\delta$. Thus, in \mathcal{E} , we have $\mathfrak{d}(\mu_n, \nu_n) \leq c(d)\delta$. As m depends only on ϵ and d , the proof is completed using (8.26) with a union bound to control the probability of \mathcal{E}^c . \square

8.3. Closeness to sets of finite perimeter. We explore consequences of Theorem 8.8 before moving to the final section. Recall from Section 2.2 that \mathcal{B}_d is the ball about the zero measure of radius 3^d in the total variation norm. For $\gamma, \xi > 0$, define the following collection of measures in \mathcal{B}_d .

$$(8.29) \quad \mathcal{P}_{\gamma, \xi} := \left\{ \nu_F : F \subset [-1, 1]^d, \text{per}(F) \leq \gamma, \mathcal{L}^d(F) \leq \mathcal{L}^d((1 + \xi)W_{p,d}) \right\},$$

where given $F \subset [-1, 1]^d$ Borel, the measure ν_F representing F is defined as in Section 2.2.

Corollary 8.9. *Let $d \geq 3$, $p > p_c(d)$ and let $\delta > 0$. There are positive constants $c_1(p, d, \delta, \xi)$, $c_2(p, d, \delta, \xi)$ and $\gamma(p, d)$ so that*

$$(8.30) \quad \mathbb{P}_p \left(\max_{G_n \in \mathcal{G}_n} \mathfrak{d}(\mu_n, \mathcal{P}_{\gamma, \xi}) \geq \delta \right) \leq c_1 \exp \left(-c_2 n^{(1-\epsilon(d))/2d} \right).$$

Proof. Let $\delta, \delta', \xi > 0$ and let $\gamma(p, d)$ be as in Corollary 8.5. We first show with high probability, the measures ν_n lie in $\mathcal{P}_{\gamma, \xi}$, and then we apply Theorem 8.8. Work in the intersection of

$$(8.31) \quad \mathcal{E}_1 := \left\{ \max_{G_n \in \mathcal{G}_n} \text{per}(nP_n) < \gamma n^{d-1} \right\}, \quad \mathcal{E}_2 := \left\{ \max_{G_n \in \mathcal{G}_n} \mathfrak{d}(\mu_n, \nu_n) < \min(\delta, \delta') \right\},$$

$$(8.32) \quad \mathcal{E}_3 := \left\{ \frac{|\mathbf{C}_n|}{(2n)^d} \in (\theta_p(d) - \delta', \theta_p(d) + \delta') \right\},$$

respectively from Corollary 8.5, Theorem 8.8 and Corollary A.4. As we are in \mathcal{E}_2 , for each nP_n corresponding to $G_n \in \mathcal{G}_n$ we have

$$(8.33) \quad \theta_p(d) \mathcal{L}^d(nP_n) < \delta' n^d + |G_n|,$$

$$(8.34) \quad < \delta' n^d + |\mathbf{C}_n|/d!.$$

From working in \mathcal{E}_3 , we further conclude

$$(8.35) \quad \mathcal{L}^d(nP_n) < n^d \left(\frac{\delta'}{\theta_p(d)} + \frac{2^d}{d!} \left(1 + \frac{\delta'}{\theta_p(d)} \right) \right),$$

$$(8.36) \quad < n^d \left(\mathcal{L}^d((1 + \xi)W_{p,d}) \right),$$

where we have taken δ' small according to p, d and ξ . As we are in \mathcal{E}_1 , we conclude $\nu_n \in \mathcal{P}_{\gamma, \xi}$ for each $G_n \in \mathcal{G}_n$. \square

The next result links \mathfrak{d} to the notion of weak convergence.

Lemma 8.10. *For $\zeta, \zeta_n \in \mathcal{P}_{\gamma, \xi}$, $\mathfrak{d}(\zeta_n, \zeta) \rightarrow 0$ if and only if ζ_n converges to ζ weakly.*

Proof. Let $\zeta, \zeta_n \in \mathcal{P}_{\gamma, \xi}$; if $\mathfrak{d}(\zeta_n, \zeta) \rightarrow 0$, it follows from (2.6) that $\zeta_n(Q) \rightarrow \zeta(Q)$ for each dyadic cube Q . As any open subset $U \subset [-1, 1]^d$ may be decomposed into a countable union of almost disjoint dyadic cubes, and as each measure in $\mathcal{P}_{\gamma, \xi}$ is absolutely continuous with respect to Lebesgue measure, we conclude $\liminf_{n \rightarrow \infty} \zeta_n(U) \geq \zeta(U)$. By the Portmanteau theorem, ζ_n converges to ζ weakly.

Conversely, if $\zeta, \zeta_n \in \mathcal{P}_{\gamma, \xi}$ are such that $\zeta_n \rightarrow \zeta$ weakly, the Portmanteau theorem also tells us $\zeta_n(A) \rightarrow \zeta(A)$ for all continuity sets $A \subset [-1, 1]^d$ of ζ , in particular whenever A is a dyadic cube (using the absolute continuity of ζ). Thus $\mathfrak{d}(\zeta_n, \zeta) \rightarrow 0$. \square

We use Lemma 8.10 to establish compactness of $\mathcal{P}_{\gamma, \xi}$.

Lemma 8.11. *The collection of measures $\mathcal{P}_{\gamma,\xi}$ is compact subset of the metric space $(\mathcal{B}_d, \mathfrak{d})$.*

Proof. By Banach-Alaoglu, the set \mathcal{B}_d is compact when equipped with the topology of weak convergence. The continuous functions on $[-1, 1]^d$ (equipped with the supremum norm topology) form a separable space, so \mathcal{B}_d is sequentially compact in the topology of weak convergence. By Lemma 8.10, it suffices to show $\mathcal{P}_{\gamma,\xi}$ is sequentially closed.

Let $\{\nu_{F_n}\}_{n=1}^\infty$ be a sequence of measures in $\mathcal{P}_{\gamma,\xi}$ converging with respect to \mathfrak{d} . Using the definition (2.6) of \mathfrak{d} , one can show (first by approximating open sets by finite unions of dyadic cubes, and then approximating Borel sets by open sets) that for any $E \subset [-1, 1]^d$ Borel, the sequence $\mathcal{L}^d(E \cap F_n)$ is Cauchy. Thus the indicator functions $\mathbf{1}_{F_n}$ converge pointwise a.e. to some $\mathbf{1}_F$, and the bounded convergence theorem converts this into L^1 -convergence.

As $\mathbf{1}_{F_n} \rightarrow \mathbf{1}_F$ in L^1 -sense, (2.6) implies $\mathfrak{d}(\nu_{F_n}, \nu_F) \rightarrow 0$ as $n \rightarrow \infty$, and it remains to check that $\nu_F \in \mathcal{P}_{\gamma,\xi}$. By Fatou's lemma and Lemma A.14,

$$(8.37) \quad \mathcal{L}^d(F) \leq \liminf_{n \rightarrow \infty} \mathcal{L}^d(F_n), \quad \text{per}(F) \leq \liminf_{n \rightarrow \infty} \text{per}(F_n),$$

and hence $\nu_F \in \mathcal{P}_{\gamma,\xi}$. □

We work with \mathfrak{d} extensively in the next section. In fact most of our effort will go towards proving the following precursor to Theorem 1.2.

Theorem 8.12. *For $d \geq 3$ and $p > p_c(d)$, let $W_{p,d}$ be the Wulff crystal from Theorem 1.2. Define the following subset of $\mathcal{M}([-1, 1]^d)$:*

$$(8.38) \quad \mathcal{W} := \left\{ \nu_E : E = W_{p,d} + x, \text{ with } W_{p,d} + x \subset [-1, 1]^d \right\}.$$

\mathbb{P}_p -almost surely,

$$(8.39) \quad \max_{G_n \in \mathcal{G}_n} \mathfrak{d}(\mu_n, \mathcal{W}) \xrightarrow{n \rightarrow \infty} 0.$$

9. LOWER BOUNDS AND MAIN RESULTS

We prove the main theorems of the paper in this section, throughout which we assume $d \geq 3$ and $p > p_c(d)$. The strategy is as follows: first use Corollary 8.9 to anchor the empirical measures μ_n near (in the sense of \mathfrak{d}) measures representing sets of finite perimeter. Whenever an empirical measure μ_n is close to such a measure ν_F , we relate the conductance of the corresponding G_n to the conductance of the continuum set F .

The challenge is to show that when $\mathfrak{d}(\mu_n, \nu_F)$ is small, $|\partial^\omega G_n|$ and $\mathcal{I}_{p,d}(nF)$ are close. This is done using a covering lemma, working locally near the boundary of F . This local perspective guides a surgery performed on $\partial^\omega G_n$ to invoke concentration estimates from Section 5.1. This strategy shares much with the argument in Section 6 of [19]. In particular, we rely on the compactness of $\mathcal{P}_{\gamma,\xi}$ established in Lemma 8.11.

9.1. Setup, the reduced boundary and a covering lemma. Let α_d denote the volume of the d -dimensional Euclidean unit ball. Given a closed Euclidean ball $B(x, r)$ centered at $x \in \mathbb{R}^d$ of radius $r > 0$ and a unit vector $v \in \mathbb{S}^{d-1}$, define the *lower half-ball* of $B(x, r)$ in the direction v :

$$(9.1) \quad B_-(x, r, v) := \left\{ y \in B(x, r) : (y - x) \cdot v \leq 0 \right\}.$$

Definition 9.1. For $F \subset \mathbb{R}^d$ Borel, let $\nabla \mathbf{1}_F$ be the distributional derivative of the indicator function $\mathbf{1}_F$. This is a vector-valued measure whose total variation $\|\nabla \mathbf{1}_F\|(\mathbb{R}^d)$ is the perimeter of F . For $F \subset \mathbb{R}^d$ a set of finite perimeter, the *reduced boundary* $\partial^* F$ of F is the set of points $x \in \mathbb{R}^d$ such that (i) and (ii) hold:

- (i) $\|\nabla \mathbf{1}_F\|(B(x, r)) > 0$ for any $r > 0$.
- (ii) If we define

$$(9.2) \quad v_r(x) := -\frac{\nabla \mathbf{1}_F(B(x, r))}{\|\nabla \mathbf{1}_F\|(B(x, r))},$$

then $v_r(x)$ tends to a unit vector $v_F(x)$, called the *exterior normal* to F at x as $r \rightarrow 0$.

The following *covering lemma* is specialized to $\mathcal{I}_{p,d}$.

Lemma 9.2. ([16], Section 14.3) *Let $F \subset \mathbb{R}^d$ be a set of finite perimeter, and let $\mathcal{I}_{p,d}$ be the surface energy defined in (2.7) for $\beta_{p,d}$. For $\delta > 0$ and $s \in (0, 1/2)$, there is a finite collection of disjoint balls $\{B(x_i, r_i)\}_{i=1}^m$ with $x_i \in \partial^* F$ and $r_i \in (0, 1)$ for all $i \in \{1, \dots, m\}$, each satisfying*

$$(9.3) \quad \mathcal{L}^d(F \cap B(x_i, r_i) \Delta B_-(x_i, r_i, v_F(x_i))) \leq \delta \alpha_d r_i^d,$$

$$(9.4) \quad \left| \mathcal{I}_{p,d}(F) - \sum_{i=1}^m \alpha_{d-1} r_i^{d-1} \beta_{p,d}(v_F(x_i)) \right| \leq \tilde{\delta}_F(s),$$

where $\tilde{\delta}_F(s) := \frac{s}{4} \mathcal{I}_{p,d}(F)$.

Remark 9.3. Given a set $F \subset [-1, 1]^d$ of finite perimeter and a ball $B(x, r)$ with $x \in \partial^* F$ arising from Lemma 9.2, we abbreviate $B_-(x, r, v_F(x))$ as $B_-(x, r)$.

We define two global parameters appearing throughout this section. Given a collection of balls $\{B(x_i, r_i)\}_{i=1}^m$ as in Lemma 9.2, define

$$(9.5) \quad \epsilon_F := \delta \min_{i=1}^m \alpha_d (r_i)^d,$$

so that ϵ_F depends on F, δ and s . Also define

$$(9.6) \quad \lambda_F(s) := (1 - 2s) \mathcal{I}_{p,d}(F).$$

Remark 9.4. Given $G_n \in \mathcal{G}_n$ and a ball $B(x_i, r_i)$ as in Lemma 9.2 for $\delta > 0$ and $s \in (0, 1/2)$, let

$$(9.7) \quad \mathcal{E}(G_n, i) := \left\{ |\partial^\omega G_n \cap nB(x_i, r_i)| \leq (1 - s)n^{d-1} \alpha_{d-1} (r_i)^{d-1} \beta_{p,d}(v_i) \right\}$$

The next lemma controls the event that $|\partial^\omega G_n|$ is too small using the events $\mathcal{E}(G_n, i)$.

Lemma 9.5. *Suppose $F \subset [-1, 1]^d$ is a set of finite perimeter. Let $\{B(x_i, r_i)\}_{i=1}^m$ be a collection of balls as in Lemma 9.2 for $\delta > 0$ and $s \in (0, 1/2)$. For each $G_n \in \mathcal{G}_n$,*

$$(9.8) \quad \left\{ |\partial^\omega G_n| \leq \lambda_F(s) n^{d-1} \right\} \subset \bigcup_{i=1}^m \mathcal{E}(G_n, i),$$

where $\lambda_F(s)$ is defined in (9.6).

Proof. Because the balls $\{B(x_i, r_i)\}_{i=1}^m$ were chosen in accordance with Lemma 9.2, we combine (9.4) with the definition of $\widetilde{\delta}_F(s)$ to obtain

$$(9.9) \quad \left| \mathcal{I}_{p,d}(F) - \sum_{i=1}^m \alpha_{d-1}(r_i)^{d-1} \beta_{p,d}(v_i) \right| \leq \frac{s}{2} \left(\sum_{i=1}^m \alpha_{d-1}(r_i)^{d-1} \beta_{p,d}(v_i) \right),$$

so that

$$(9.10) \quad \lambda_F(s) \leq (1-s) \left(\sum_{i=1}^m \alpha_{d-1}(r_i)^{d-1} \beta_{p,d}(v_i) \right).$$

Use the disjointness of the balls in $\{B(x_i, r_i)\}_{i=1}^m$, (9.10) and the definition (9.7) of $\mathcal{E}(G_n, i)$.

$$(9.11) \quad \left\{ |\partial^\omega G_n| \leq \lambda_F(s) n^{d-1} \right\} \subset \left\{ \sum_{i=1}^m |\partial^\omega G_n \cap nB(x_i, r_i)| \leq (1-s) n^{d-1} \sum_{i=1}^m \alpha_{d-1}(r_i)^{d-1} \beta_{p,d}(v_i) \right\},$$

$$(9.12) \quad \subset \bigcup_{i=1}^m \mathcal{E}(G_n, i)$$

We complete the proof using the definition (9.5) of ϵ_F . \square

9.2. Local surgery on each $\partial^\omega G_n$. In this subsection, we think of $F \subset [-1, 1]^d$ as a fixed polytope and work with a fixed $G_n \in \mathcal{G}_n$. Let $\{B(x_i, r_i)\}_{i=1}^m$ be a collection of balls as in Lemma 9.2 for F . Also fix $B(x_i, r_i) \in \{B(x_i, r_i)\}_{i=1}^m$, and denote this ball as $B(x, r)$, with $v := v_F(x) \in \mathbb{S}^{d-1}$ be the exterior normal vector associated to $x \in \partial^* F$.

Let $B_-(x, r)$ be the lower half-ball associated to $B(x, r)$ and v . Let $D(x, r)$ be the closed equatorial disc of this ball, so that $\text{hyp}(D(x, r))$ is orthogonal to v . For $h > 0$ small, define $r' := (1 - h^2)^{1/2} r$, and let $D(x, r') \subset D(x, r)$ be the closed disc of radius r' centered at x . Note that $D(x, r')$ is built so that $\text{cyl}(D(x, r'), hr') \subset B(x, r)$. These geometric objects guide a surgery we perform on $\partial^\omega G_n$.

Let $J_n = J_n(\omega)$ be the open edges intersecting $N_{5d}(nD(x, r))$. Closing each edge in J_n and each edge in $\partial^\omega G_n$ breaks $\mathbf{C}_\infty \cap nB(x, r)$ into a finite number of connected components. A component Λ is *outward* if it is contained in $G_n \cap (nB(x, r) \setminus nB_-(x, r))$ and is *inward* if it lies in $nB_-(x, r) \setminus G_n$.

We are only interested in Λ containing vertices incident to edges in J_n . Enumerate all such outward components as $\Lambda_1^+, \dots, \Lambda_{\ell^+}^+$, and all such inward components as $\Lambda_1^-, \dots, \Lambda_{\ell^-}^-$. A component (outward or inward) is *good* if it is contained in $n\text{cyl}(D(x, r), hr')$ and is *bad* otherwise. Our notation suppresses the dependence of these components on G_n , $B(x, r)$ and F .

Remark 9.6. Every outward component is a subgraph of G_n . Thus, *outward* is understood as relative to the bottom half-ball $nB_-(x, r)$. Figure 15 illustrates the objects introduced so far. We regard outward and inward components Λ_j^\pm as subgraphs of $\mathbf{C}_\infty \cap nB(x, r)$, so that the edge sets $E(\Lambda_j^\pm)$ are collections of open edges.

The next lemma efficiently truncates bad components. Let $\alpha \in [0, h/2]$, and given Λ_j^+ , define

$$(9.13) \quad \text{slice}_j^+(\alpha) := \left\{ e \in E(\Lambda_j^+) : e \cap [nD(x, r) + nar'v] \neq \emptyset \right\},$$

where in the above intersection, the edge e is regarded as a line-segment in \mathbb{R}^d . Thus $\text{slice}_j^+(\alpha)$ is the set of edges in Λ_j^+ touching a prescribed translate of $nD(x, r)$. For an inward component Λ_j^- , likewise define

$$(9.14) \quad \text{slice}_j^-(\alpha) := \left\{ e \in E(\Lambda_j^-) : e \cap [nD(x, r) - nar'v] \neq \emptyset \right\}.$$

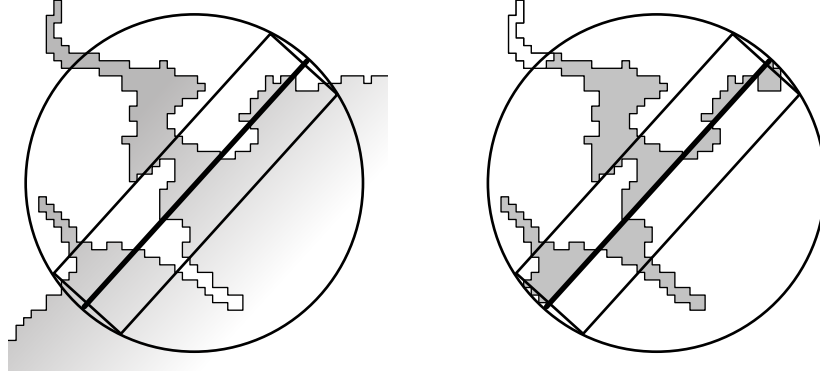

FIGURE 15. The thin cylinder $ncyl(D(x, r'), hr')$ is drawn as a rectangle, the central disc $nD(x, r)$ is the bold line. On the left is G_n viewed up close. On the right, inward and outward components are in grey (outward components point up and to the left). There are three good components and three bad components.

Lemma 9.7. *Let $G_n \in \mathcal{G}_n$ and $B(x, r)$ with $r \in (0, 1)$ be fixed, and let Λ_j^\pm denote the outward and inward components constructed above from G_n , $B(x, r)$ and F . Let $h > 0$. There is a positive constant $c(d)$ so that for each outward component Λ_j^+ , there is $h_j^+ \in [0, h/2]$ so that*

$$(9.15) \quad |\text{slice}_j^+(h_j^+)| \leq c(d) \frac{|\Lambda_j^+|}{nhr},$$

and for each inward component Λ_j^- , there is $h_j^- \in [0, h/2]$ so that

$$(9.16) \quad |\text{slice}_j^-(h_j^-)| \leq c(d) \frac{|\Lambda_j^-|}{nhr}.$$

Proof. Let Λ_j^+ be an outward component. For $k \in \{1, \dots, \lceil nh \rceil / 2\}$, define $\alpha_k := k/2n$. We have

$$(9.17) \quad \bigcup_{k=1}^{\lceil nh \rceil / 2} \text{slice}_j^+(\alpha_k) \subset E(\Lambda_j^+).$$

When k and k' satisfy $|k - k'|_2 \geq 10d$, the edge sets $\text{slice}_j^+(\alpha_k)$ and $\text{slice}_j^+(\alpha_{k'})$ are disjoint. Thus,

$$(9.18) \quad \sum_{k=1}^{\lceil nh \rceil / 2} |\text{slice}_j^+(\alpha_k)| \leq (10d)|E(\Lambda_j^+)|.$$

For at least one $k \in \{1, \dots, \lceil nh \rceil / 2\}$, we must have

$$(9.19) \quad |\text{slice}_j^+(\alpha_k)| \leq c(d) \frac{|\Lambda_j^+|}{nhr},$$

for some $c(d) > 0$, and where we have slipped r into the denominator because $r \in (0, 1)$.

Any α_k satisfying (9.19) is at most $h/2$. Pick one such α_k and relabel it h_j^+ . Analogous reasoning for inward components gives $h_j^- \in [0, h/2]$ for each inward Λ_j^- so that

$$(9.20) \quad |\text{slice}_j^-(h_j^-)| \leq c(d) \frac{|\Lambda_j^-|}{nhr},$$

completing the proof. □

Remark 9.8. We continue to use the edge sets given by Lemma 9.7 throughout this subsection, but only when working with bad components. When Λ_j^\pm is bad, define

$$(9.21) \quad \text{slice}_j^\pm := \text{slice}_j^\pm(h_j^\pm),$$

and if Λ_j^\pm is good, define slice_j^\pm to be empty. Figure 16 depicts the edge sets slice_j^\pm . As with the Λ_j^\pm , we suppress the dependence of the slice_j^\pm on G_n , $h > 0$, $B(x, r)$ and F .

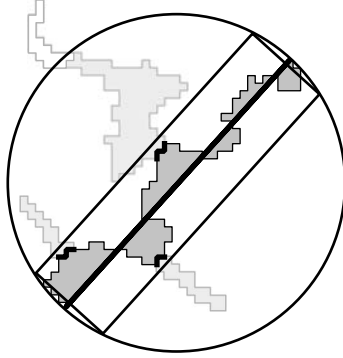

FIGURE 16. The short, bold curves are the efficiently chosen sets of open edges slice_j^\pm from Lemma 9.7. We have faded the portions of the bad components which are cut off by the slice_j^\pm .

The following is an immediate consequence of Lemma 9.7.

Corollary 9.9. *Let $G_n \in \mathcal{G}_n$, $h > 0$ and $B(x, r)$ be fixed. Let slice_j^\pm be the edge sets constructed from G_n , $h > 0$ and $B(x, r)$. There is $c(d) > 0$ so that*

$$(9.22) \quad \sum_{j=1}^{\ell^+} |\text{slice}_j^+| + \sum_{j=1}^{\ell^-} |\text{slice}_j^-| \leq \frac{c(d)}{nhr} \left(\sum_{j=1}^{\ell^+} |\Lambda_j^+| + \sum_{j=1}^{\ell^-} |\Lambda_j^-| \right).$$

Remark 9.10. Corollary 9.9 tells us that to control the total size of the slice_j^\pm , it suffices to control the total volume of the Λ_j^\pm . At the beginning of Section 8, we built a polytope P_n whose perimeter we could bound, and whose representative measure ν_n was \mathfrak{d} -close to μ_n . Proposition 9.11 shows the ℓ^1 -distance of $\mathbf{1}_{C_\infty \cap P_n}$ and $\mathbf{1}_{C_\infty \cap F}$ is small when $\mathfrak{d}(\nu_n, \nu_F)$ is. Proposition 9.12 controls the total volume of the Λ_j^\pm when these indicator functions are close.

Proposition 9.11. *Let $F \subset [-1, 1]^d$ be a polytope. Recall the metric \mathfrak{d} defined in (2.6) and the constant γ from Corollary 8.5. Given $G_n \in \mathcal{G}_n$, let $P_n \subset [-1, 1]^d$ be the polytope defined from G_n in (8.4) with representative measure ν_n . For $\delta > 0$, there is $\epsilon(d, \delta, F) > 0$ and an event \mathcal{E}_0 so that for all $G_n \in \mathcal{G}_n$*

$$(9.23) \quad \left\{ \mathfrak{d}(\nu_n, \nu_F) < \epsilon \right\} \cap \left\{ \max_{G_n \in \mathcal{G}_n} \text{per}(P_n) \leq \gamma \right\} \cap \mathcal{E}_0$$

$$(9.24) \quad \subset \left\{ \left\| \mathbf{1}_{C_\infty \cap P_n} - \mathbf{1}_{C_\infty \cap F} \right\|_{\ell^1} \leq \delta n^d \right\} \cap \left\{ \max_{G_n \in \mathcal{G}_n} \text{per}(P_n) \leq \gamma \right\} \cap \mathcal{E}_0.$$

Moreover, there are positive constants $c_1(p, d, \delta, F), c_2(p, d, \delta, F)$ so that

$$(9.25) \quad \mathbb{P}_p(\mathcal{E}_0^c) \leq c_1 \exp(-c_2 n^{d-1}).$$

Proof. Fix $G_n \in \mathcal{G}_n$ and hence P_n and v_n . Let $\Delta^k \equiv \Delta^{k,d}$ be the dyadic cubes in $[-1, 1]^d$ at scale $k \in \mathbb{N}$. Define:

$$(9.26) \quad \mathbf{Q}_0 := \{Q \in \Delta^k : Q \cap (\partial F \cup \partial P_n) \neq \emptyset\},$$

and observe

$$(9.27) \quad \|\mathbf{1}_{\mathbf{C}_\infty \cap nP_n} - \mathbf{1}_{\mathbf{C}_\infty \cap nF}\|_{\ell^1} \leq \sum_{Q \in \Delta^k} \|\mathbf{1}_{\mathbf{C}_\infty \cap nP_n \cap nQ} - \mathbf{1}_{\mathbf{C}_\infty \cap nF \cap nQ}\|_{\ell^1},$$

$$(9.28) \quad \leq \sum_{Q \in \Delta^k \setminus \mathbf{Q}_0} \|\mathbf{1}_{\mathbf{C}_\infty \cap nP_n \cap nQ} - \mathbf{1}_{\mathbf{C}_\infty \cap nF \cap nQ}\|_{\ell^1} + \sum_{Q \in \mathbf{Q}_0} \|\mathbf{1}_{\mathbf{C}_\infty \cap nP_n \cap nQ} - \mathbf{1}_{\mathbf{C}_\infty \cap nF \cap nQ}\|_{\ell^1}.$$

For n sufficiently large depending on k , there is $c(d) > 0$ so that

$$(9.29) \quad \|\mathbf{1}_{\mathbf{C}_\infty \cap nP_n} - \mathbf{1}_{\mathbf{C}_\infty \cap nF}\|_{\ell^1} \leq \sum_{Q \in \Delta^k \setminus \mathbf{Q}_0} \|\mathbf{1}_{\mathbf{C}_\infty \cap nP_n \cap nQ} - \mathbf{1}_{\mathbf{C}_\infty \cap nF \cap nQ}\|_{\ell^1} + c(d)(\gamma + \text{per}(F))n^d 2^{-dk}.$$

Define the following collections of dyadic cubes:

$$(9.30) \quad \mathbf{Q}_1 := \{Q \in \Delta^k : P_n \cap Q = Q\},$$

$$(9.31) \quad \mathbf{Q}_2 := \{Q \in \Delta^k : F \cap Q = Q\},$$

For each $Q \in \mathbf{Q}_1$, we have $\mathbf{C}_\infty \cap nP_n \cap nQ = \mathbf{C}_\infty \cap nQ$. Likewise, for each $Q \in \mathbf{Q}_2$, we have $\mathbf{C}_\infty \cap nF \cap nQ = \mathbf{C}_\infty \cap nQ$. Using these observations, we conclude

$$(9.32) \quad \|\mathbf{1}_{\mathbf{C}_\infty \cap nP_n} - \mathbf{1}_{\mathbf{C}_\infty \cap nF}\|_{\ell^1} \leq \sum_{Q \in \mathbf{Q}_1 \Delta \mathbf{Q}_2} \|\mathbf{1}_{\mathbf{C}_\infty \cap nP_n \cap nQ} - \mathbf{1}_{\mathbf{C}_\infty \cap nF \cap nQ}\|_{\ell^1} + c(d)(\gamma + \text{per}(F))n^d 2^{-dk}.$$

For $\epsilon > 0$ and for each $Q \in \Delta^k$, introduce the event

$$(9.33) \quad \mathcal{E}_Q := \left\{ \frac{\mathbf{C}_\infty \cap nQ}{\mathcal{L}^d(nQ)} \in (\theta_p(d)(1 - \epsilon), \theta_p(d)(1 + \epsilon)) \right\},$$

and let \mathcal{E}_0 be the intersection $\bigcap_{Q \in \Delta^k} \mathcal{E}_Q$. Within \mathcal{E}_0 ,

$$(9.34) \quad \|\mathbf{1}_{\mathbf{C}_\infty \cap nP_n} - \mathbf{1}_{\mathbf{C}_\infty \cap nF}\|_{\ell^1} \leq n^d 2^k |\Delta^k| (1 + \epsilon) \mathfrak{d}(v_n, v_F) + c(d)(\gamma + \text{per}(F))n^d 2^{-dk}.$$

The term $2^k |\Delta^k|$ above comes from the definition of \mathfrak{d} . Choose k sufficiently large depending on d, δ and F so that $\delta/4 \leq c(d)(\gamma + \text{per}(F))2^{-dk} \leq \delta/2$. When $\mathfrak{d}(v_n, v_F) < \epsilon$,

$$(9.35) \quad \|\mathbf{1}_{\mathbf{C}_\infty \cap nP_n} - \mathbf{1}_{\mathbf{C}_\infty \cap nF}\|_{\ell^1} \leq n^d 2^k |\Delta^k| (1 + \epsilon) \mathfrak{d}(v_n, v_F) + \frac{\delta}{2} n^d,$$

$$(9.36) \quad \leq c(d) \delta^{-(d+1)/d} (\gamma + \text{per}(F))^{(d+1)/d} (1 + \epsilon) \epsilon n^d + \frac{\delta}{2} n^d,$$

$$(9.37) \quad \leq \delta n^d,$$

where to obtain the last line, we choose ϵ small depending on d, δ and F . We complete the proof by a union bound and Corollary A.4 applied to each \mathcal{E}_Q . \square

As outlined in Remark 9.10, Proposition 9.12 below will be used with Proposition 9.11 and Corollary 9.9 to control the total size of all slice $_{\pm}^{\#}$ constructed.

Proposition 9.12. *Let $G_n \in \mathcal{G}_n$, let $F \subset [-1, 1]^d$ be a polytope and let $B(x, r)$ be a ball with $r \in (0, 1)$ and*

$$(9.38) \quad \mathcal{L}^d((B(x, r) \cap F) \Delta B_-(x, r)) \leq \delta \alpha_d r^d.$$

Within the event

$$(9.39) \quad \left\{ \|\mathbf{1}_{\mathbf{C}_\infty \cap nP_n} - \mathbf{1}_{\mathbf{C}_\infty \cap nF}\|_{\ell^1} \leq \delta n^d \alpha_d r^d \right\} \cap \left\{ \max_{G_n \in \mathcal{G}_n} |\partial^\omega G_n| \leq \eta_3 n^{d-1} \right\},$$

there is $c(d) > 0$ so that for n sufficiently large depending on d, δ, F and r ,

$$(9.40) \quad \sum_{j=1}^{\ell^+} |\Lambda_j^+| + \sum_{j=1}^{\ell^-} |\Lambda_j^-| \leq c(d) \delta n^d \alpha_d r^d,$$

where the Λ_j^\pm are the outward and inward components associated to G_n and $B(x, r)$.

Proof. Write $B(x, r)$ as B and $B_-(x, r)$ as B_- for brevity. We first handle the outward components. If Λ_j^+ is outward, it is contained in $G_n \cap n(B \setminus B_-)$. These components are pairwise disjoint, and hence by Lemma 8.4,

$$(9.41) \quad \sum_{j=1}^{\ell^+} |\Lambda_j^+| \leq |G_n \cap n(B \setminus B_-)|$$

$$(9.42) \quad \leq |\mathbf{C}_\infty \cap nP_n \cap n(B \setminus B_-)|$$

$$(9.43) \quad \leq \|\mathbf{1}_{\mathbf{C}_\infty \cap nP_n} - \mathbf{1}_{\mathbf{C}_\infty \cap nF}\|_{\ell^1} + |\mathbf{C}_\infty \cap nF \cap n(B \setminus B_-)|.$$

Take n sufficiently large depending on d, F and r , to obtain

$$(9.44) \quad \sum_{j=1}^{\ell^+} |\Lambda_j^+| \leq \|\mathbf{1}_{\mathbf{C}_\infty \cap nP_n} - \mathbf{1}_{\mathbf{C}_\infty \cap nF}\|_{\ell^1} + c(d) n^d \mathcal{L}^d((B \cap F) \Delta B_-).$$

Within the event (9.39) and using the bound (9.38), we find

$$(9.45) \quad \sum_{j=1}^{\ell^+} |\Lambda_j^+| \leq \delta n^d \alpha_d r^d + c(d) \delta n^d \alpha_d r^d.$$

The inward components are also pairwise disjoint, and each is contained within $(\mathbf{C}_\infty \setminus G_n) \cap nB_-$:

$$(9.46) \quad \sum_{j=1}^{\ell^-} |\Lambda_j^-| \leq |(\mathbf{C}_\infty \setminus G_n) \cap nB_-|$$

$$(9.47) \quad \leq |(\mathbf{C}_\infty \cap nP_n) \setminus G_n| + |(\mathbf{C}_\infty \setminus nP_n) \cap nB_-|$$

$$(9.48) \quad \leq |(\mathbf{C}_\infty \cap nP_n) \setminus G_n| + \|\mathbf{1}_{\mathbf{C}_\infty \cap nP_n} - \mathbf{1}_{\mathbf{C}_\infty \cap nF}\|_{\ell^1} + |(\mathbf{C}_\infty \setminus nF) \cap nB_-|.$$

The second line above follows from Lemma 8.4. The discrete precursor to P_n was $F_n \subset \mathbf{C}_\infty$, defined in (7.2). The polytope F in the statement of this proposition is *not related* to this F_n (this is

the only instance the letter F is overloaded with meaning). Use the definition of F_n and Lemma 8.4:

$$(9.49) \quad \sum_{j=1}^{\ell^-} |\Lambda_j^-| \leq |F_n \setminus G_n| + \|\mathbf{1}_{C_\infty \cap nP_n} - \mathbf{1}_{C_\infty \cap nF}\|_{\ell^1} + |(C_\infty \setminus nF) \cap nB_-|,$$

$$(9.50) \quad \leq |F_n \setminus G_n| + \delta n^d \alpha_d r^d + c(d) n^d \mathcal{L}^d((B \cap F) \Delta B_-),$$

when n is taken sufficiently large depending on r, F and d . Within the event (9.39), Lemma 7.10 implies $|F_n \setminus G_n| \leq n^d n^{-\epsilon(d)}$, where $\epsilon(d)$ is defined in (7.1). All that matters is that $\epsilon(d) > 0$, which is the case when $d \geq 3$, and we use this in (9.50) to deduce:

$$(9.51) \quad \sum_{j=1}^{\ell^-} |\Lambda_j^-| \leq n^d n^{-\epsilon(d)} + \delta n^d \alpha_d r^d + c(d) \delta n^d \alpha_d r^d.$$

We complete the proof taking n larger if necessary, and using (9.51) with (9.45). \square

Remark 9.13. We can now bound $|\text{slice}_j^\pm|$ by combining (9.22) of Corollary 9.9 and (9.40) of Proposition 9.12. As Figure 16 suggests, the slice_j^\pm together with the edges of $\partial^\omega G_n$ lying in the thin cylinder $\text{ncyl}(D(x, r'), hr')$ form a cutset separating the faces of this cylinder. We leverage this in the next subsection.

Motivated by Remark 9.13, introduce the following edge set depending on $G_n \in \mathcal{G}_n$, $h > 0$ and the ball $B(x, r)$.

$$(9.52) \quad E_n := \left(\partial^\omega G_n \cap nB(x, r) \right) \cup \left(\bigcup_{j=1}^{\ell^+} \text{slice}_j^+ \right) \cup \left(\bigcup_{j=1}^{\ell^-} \text{slice}_j^- \right).$$

9.3. Lower bounds on $|\partial^\omega G_n|$. Given a collection of balls $\{B(x_i, r_i)\}_{i=1}^m$ from Lemma 9.2, a polytope F , $h > 0$ and $G_n \in \mathcal{G}_n$, repeat the construction of the previous subsection within each $B(x_i, r_i)$. For $G_n \in \mathcal{G}_n$, $h > 0$ and each $B(x_i, r_i)$, define the edge set $E_n^{(i)}$ as in (9.52).

For these objects and the parameters $\delta > 0$ and $s \in (0, 1/2)$, define an event whose purpose is described in Remark 9.14:

$$(9.53) \quad \mathcal{F}(G_n, i; h) := \left\{ |E_n^{(i)}| \leq \left(1 - s + c(p, d) \frac{\delta}{h} \right) n^{d-1} \alpha_{d-1} (r_i)^{d-1} \beta_{p,d}(v_i) \right\}.$$

The constant $c(p, d) > 0$ is not specified here, as it arises naturally in the proof of Corollary 9.15 below. It comes from the constants in (9.40) and (9.22), the ratio α_{d-1}/α_d and the extreme values of $\beta_{p,d}$ over the unit sphere.

Remark 9.14. The bounds on $|\text{slice}_j^\pm|$ from the previous section also control each $|E_n^{(i)}|$. We use these bounds with concentration estimates when the $E_n^{(i)}$ form a cutset to show $\mathcal{F}(G_n, i; h)$ is rare when δ, h and s are chosen appropriately. Corollary 9.15 below relates the events $\mathcal{E}(G_n, i)$ introduced at the beginning of the section to the $\mathcal{F}(G_n, i; h)$. By Lemma 9.5, knowing each $\mathcal{F}(G_n, i; h)$ is a low-probability event tells us it is also rare for $|\partial^\omega G_n|$ to be too small.

Corollary 9.15. Let $G_n \in \mathcal{G}_n$, let $F \subset [-1, 1]^d$ be a polytope and let $\{B(x_i, r_i)\}_{i=1}^m$ be a collection of balls as in Lemma 9.2 for F and the parameters $\delta > 0, s \in (0, 1/2)$. Let $h > 0$, and form the edge sets $E_n^{(i)}$. For n sufficiently large depending on d, ϵ_F and F ,

$$(9.54) \quad \mathcal{E}(G_n, i) \cap \left\{ \|\mathbf{1}_{C_\infty \cap nP_n} - \mathbf{1}_{C_\infty \cap nF}\|_{\ell^1} \leq \epsilon_F n^d \right\} \cap \left\{ \max_{G_n \in \mathcal{G}_n} |\partial^\omega G_n| \leq \eta_3 n^{d-1} \right\} \subset \mathcal{F}(G_n, i; h),$$

where $\mathcal{E}(G_n, i)$ and $\mathcal{F}(G_n, i; h)$ are events respectively defined in (9.7) and (9.53), and where $\epsilon_F = \delta \min_{i=1}^m (r_i)^d \alpha_d$ was defined in (9.5).

Proof. For the convenience of the reader, we recall the definition of the event $\mathcal{E}(G_n, i)$:

$$(9.55) \quad \mathcal{E}(G_n, i) = \left\{ |\partial^\omega G_n \cap nB(x_i, r_i)| \leq (1-s)n^{d-1} \alpha_{d-1}(r_i)^{d-1} \beta_{p,d}(v_i) \right\}.$$

Working within the event on the left-hand side of (9.54), and as each $B(x_i, r_i)$ from Lemma 9.2 satisfies

$$(9.56) \quad \mathcal{L}^d((B(x_i, r_i) \cap F) \Delta B_-(x_i, r_i)) \leq \delta \alpha_d (r_i)^d,$$

we apply Proposition 9.12 within each ball (with n taken sufficiently large), obtaining

$$(9.57) \quad \sum_{j=1}^{\ell^+} |\Lambda_j^+(i)| + \sum_{j=1}^{\ell^-} |\Lambda_j^-(i)| \leq c(d) \delta n^d \alpha_d (r_i)^d,$$

where the $\Lambda_j^\pm(i)$ are the inward and outward components corresponding to $G_n, h > 0$ and the ball $B(x_i, r_i)$. Form the edge sets $\text{slice}_j^\pm(i)$ are defined as in (9.21) and apply Corollary 9.9:

$$(9.58) \quad \sum_{j=1}^{\ell^+} |\text{slice}_j^+(i)| + \sum_{j=1}^{\ell^-} |\text{slice}_j^-(i)| \leq \frac{c(d)}{nh r_i} (c(d) \delta n^d \alpha_d (r_i)^d),$$

$$(9.59) \quad \leq c(d) \frac{\delta}{h} n^{d-1} \alpha_{d-1}(r_i)^{d-1},$$

Use the definitions of $\mathcal{E}(G_n, i)$ and the $E_n^{(i)}$: within the event on the left-hand side of (9.54),

$$(9.60) \quad |E_n^{(i)}| \leq (1-s)n^{d-1} \alpha_{d-1}(r_i)^{d-1} \beta_{p,d}(v_i) + c(d) \frac{\delta}{h} n^{d-1} \alpha_{d-1}(r_i)^{d-1}.$$

The proof is complete upon defining $\mathcal{F}(G_n, i; h)$ appropriately in (9.53). \square

The next lemma tells us each $E_n^{(i)}$ forms an open cutset with high probability.

Lemma 9.16. *Let F be a polytope, let $h > 0$ and let $\{B(x_i, r_i)\}_{i=1}^m$ be a collection of balls as in Lemma 9.2 for F , $\delta > 0$ and $s \in (0, 1/2)$. Let \mathcal{E}_1 be the event that for each $G_n \in \mathcal{G}_n$ and all $i \in \{1, \dots, m\}$, any open path in $\text{d-cyl}(D(x, r'_i), hr'_i, n)$ joining the faces $\text{d-face}^\pm(D(x, r'_i), hr'_i, n)$ uses an edge of $E_n^{(i)}$. There are positive constants c_1, c_2 depending on p, d, F, δ, s, h so that*

$$(9.61) \quad \mathbb{P}_p(\mathcal{E}_1) \geq 1 - c_1 \exp\left(-c_2 n^{(d-1)/d}\right),$$

where we recall $r'_i := (1-h^2)r_i^2$.

Proof. Our primary tool is Theorem A.5. We drop the indexing for the sake of clarity and work with generic objects: balls $B(x, r)$, discs $D(x, r')$ and edge sets E_n .

From the careful construction of slice_j^\pm , any open path in \mathbf{C}_∞ between faces $\text{d-face}^\pm(D(x, r'), hr', n)$ in $\text{d-cyl}(D(x, r'), hr', n)$ uses an edge of E_n . In the almost sure event that there is a unique infinite cluster, $\text{d-face}^\pm(D(x, r'), hr', n)$ can only be joined by an open path in $\text{d-cyl}(D(x, r'), hr', n)$ if this path lies in a finite open cluster. Such a path uses at least $2r'hn$ edges, and the cluster containing this path must have volume at least $2r'hn$. A union bound with Theorem A.5 applied to each point in $[-n, n]^d \cap \mathbb{Z}^d$ gives the desired result. \square

Remark 9.17. Let \mathcal{E}_1 be the event from Lemma 9.16. For each $\omega \in \mathcal{E}_1$, completing each $E_n^{(i)}$ to a full cutset in $d\text{-cyl}(D(x, r'), hr', n)$ implies $|E_n^{(i)}| \geq \bar{\Xi}_{\text{face}}(D(x_i, r'_i), hr'_i, n)$ in ω . The next proposition aggregates all work done in this section.

Proposition 9.18. Let $F \subset [-1, 1]^d$ be a polytope, and for $s \in (0, 1/2)$, let $\lambda_F(s) = (1 - 2s)\mathcal{I}_{p,d}(F)$. There are positive constants $c_1(p, d, s, F)$, $c_2(p, d, s, F)$ and $\tilde{\epsilon}_F(p, d, s, F)$ so that

$$(9.62) \quad \mathbb{P}_p\left(\left\{\exists G_n \in \mathcal{G}_n \text{ such that } |\partial^\omega G_n| \leq \lambda_F(s)n^{d-1} \text{ and } \mathfrak{d}(\mu_n, \nu_F) \leq \tilde{\epsilon}_F\right\}\right) \leq c_1 \exp\left(-c_2 n^{1/2d}\right).$$

Proof. Let $\{B(x_i, r_i)\}_{i=1}^m$ be a collection of balls as in Lemma 9.2 for F , $\delta > 0$ and $s \in (0, 1/2)$. The parameter δ and a height parameter $h > 0$ will be fixed as functions of p, d and s later.

Let \mathcal{E}_0 be the event from Proposition 9.11 for parameter $\tilde{\epsilon}_F$ to be determined later. Let \mathcal{E}_1 be the event from Lemma 9.16, and for constants η_3 and γ from Lemma A.10 and Corollary 8.5, define

$$(9.63) \quad \mathcal{E}_2 := \left\{ \max_{G_n \in \mathcal{G}_n} \mathfrak{d}(\mu_n, \nu_n) \leq \tilde{\epsilon}_F \right\}, \quad \mathcal{E}_3 := \left\{ \max_{G_n \in \mathcal{G}_n} |\partial^\omega G_n| \leq \eta_3 n^{d-1} \right\},$$

$$(9.64) \quad \mathcal{E}_4 := \left\{ \max_{G_n \in \mathcal{G}_n} \text{per}(P_n) \leq \gamma \right\},$$

Let \mathcal{E}^* be the intersection of \mathcal{E}_0 through \mathcal{E}_4 . Apply Lemma 9.5 to conclude

$$(9.65) \quad \left\{ \exists G_n \in \mathcal{G}_n \text{ such that } |\partial^\omega G_n| \leq \lambda_F(s)n^{d-1} \text{ and } \mathfrak{d}(\mu_n, \nu_F) \leq \tilde{\epsilon}_F \right\} \cap \mathcal{E}^*$$

$$(9.66) \quad \subset \bigcup_{G_n \in \mathcal{G}_n} \bigcup_{i=1}^m \mathcal{E}(G_n, i) \cap \left\{ \mathfrak{d}(\mu_n, \nu_F) \leq \tilde{\epsilon}_F \right\} \cap \mathcal{E}^*,$$

$$(9.67) \quad \subset \bigcup_{G_n \in \mathcal{G}_n} \bigcup_{i=1}^m \mathcal{E}(G_n, i) \cap \left\{ \mathfrak{d}(\nu_n, \nu_F) \leq 2\tilde{\epsilon}_F \right\} \cap \mathcal{E}^*,$$

where (9.67) follows from $\mathcal{E}^* \subset \mathcal{E}_2$. Use that \mathcal{E}^* is contained in \mathcal{E}_0 and in \mathcal{E}_4 with Proposition 9.11, choosing $\tilde{\epsilon}_F$ small depending on ϵ_F, d and F so that

$$(9.68) \quad \left\{ \exists G_n \in \mathcal{G}_n \text{ such that } |\partial^\omega G_n| \leq \lambda_F(s)n^{d-1} \text{ and } \mathfrak{d}(\mu_n, \nu_F) \leq \tilde{\epsilon}_F \right\} \cap \mathcal{E}^*$$

$$(9.69) \quad \subset \bigcup_{G_n \in \mathcal{G}_n} \bigcup_{i=1}^m \mathcal{E}(G_n, i) \cap \left\{ \left\| \mathbf{1}_{\mathcal{C}_\infty \cap nP_n} - \mathbf{1}_{\mathcal{C}_\infty \cap nF} \right\|_{\ell^1} \leq \epsilon_F n^d \right\} \cap \mathcal{E}^*,$$

$$(9.70) \quad \subset \bigcup_{G_n \in \mathcal{G}_n} \bigcup_{i=1}^m \mathcal{F}(G_n, i; h) \cap \mathcal{E}^*,$$

where we have used Corollary 9.15 and taken n large depending on d, F and ϵ_F , using $\mathcal{E}^* \subset \mathcal{E}_3$.

Finally, as \mathcal{E}^* contains \mathcal{E}_1 , we use Remark 9.17 to conclude

$$(9.71) \quad \left\{ \exists G_n \in \mathcal{G}_n \text{ such that } |\partial^\omega G_n| \leq \lambda_F(s)n^{d-1} \text{ and } \mathfrak{d}(\mu_n, \nu_F) \leq \tilde{\epsilon}_F \right\} \cap \mathcal{E}^*$$

$$(9.72) \quad \subset \bigcup_{G_n \in \mathcal{G}_n} \bigcup_{i=1}^m \left\{ \Xi_{\text{face}}(D(x_i, r'_i), hr'_i, n) \leq \left(1 - s + c(p, d) \frac{\delta}{h}\right) n^{d-1} \alpha_{d-1}(r_i)^{d-1} \beta_{p,d}(v_i) \right\},$$

$$(9.73) \quad \subset \bigcup_{i=1}^m \left\{ \Xi_{\text{face}}(D(x_i, r'_i), hr'_i, n) \leq \left(1 - s + c(p, d) \frac{\delta}{h}\right) n^{d-1} \alpha_{d-1}(r_i)^{d-1} \beta_{p,d}(v_i) \right\},$$

$$(9.74) \quad \subset \bigcup_{i=1}^m \left\{ \Xi_{\text{face}}(D(x_i, r'_i), hr'_i, n) \leq \left(1 - s + c(p, d) \frac{\delta}{h}\right) \frac{1}{(1 - h^2)^{(d-1)/2}} n^{d-1} \alpha_{d-1}(r'_i)^{d-1} \beta_{p,d}(v_i) \right\}.$$

We now calibrate parameters. Choose h small depending on p, d and $s/2$ so that the concentration estimates of Proposition 5.2 are applicable when n is taken large depending on h and ϵ_F . Next, choose δ depending on $s, c(p, d)$ and h so that

$$(9.75) \quad \left\{ \exists G_n \in \mathcal{G}_n \text{ such that } |\partial^\omega G_n| \leq \lambda_F(s)n^{d-1} \text{ and } \mathfrak{d}(\mu_n, \nu_F) \leq \tilde{\epsilon}_F \right\} \cap \mathcal{E}^*$$

$$(9.76) \quad \subset \bigcup_{i=1}^m \left\{ \Xi_{\text{face}}(D(x_i, r'_i), hr'_i, n) \leq \left(1 - s/2\right) n^{d-1} \alpha_{d-1}(r'_i)^{d-1} \beta_{p,d}(v_i) \right\},$$

noting that the number m of events in the above union now depends only on p, d, s and F . By using Proposition 5.2, we find

$$(9.77) \quad \mathbb{P}_p \left(\exists G_n \in \mathcal{G}_n \text{ such that } |\partial^\omega G_n| \leq \lambda_F(s)n^{d-1} \text{ and } \mathfrak{d}(\mu_n, \nu_F) \leq \tilde{\epsilon}_F \right)$$

$$(9.78) \quad \leq \sum_{i=1}^m c_1 \exp \left(-c_2 n^{(d-1)/3} \right) + \mathbb{P}_p((\mathcal{E}^*)^c),$$

$$(9.79) \quad \leq c_1 \exp \left(-c_2 n^{(d-1)/3} \right) + \mathbb{P}_p((\mathcal{E}^*)^c),$$

where c_1 and c_2 are positive constants depending on p, d, s, h, δ and F . As $\tilde{\epsilon}_F, \delta$ and h all depend only on p, d, s and F , these constants have the correct dependencies, and $\mathbb{P}_p((\mathcal{E}^*)^c)$ is also bounded satisfactorily. Use Proposition 9.11 and Lemma 9.16 to bound $\mathbb{P}_p(\mathcal{E}_0^c)$ and $\mathbb{P}_p(\mathcal{E}_1^c)$. We further use Theorem 8.8, Lemma A.10 and Corollary 8.5 to bound $\mathbb{P}_p(\mathcal{E}_2^c), \mathbb{P}_p(\mathcal{E}_3^c)$ and $\mathbb{P}_p(\mathcal{E}_4^c)$ respectively, concluding

$$(9.80) \quad \mathbb{P}_p \left(\exists G_n \in \mathcal{G}_n \text{ such that } |\partial^\omega G_n| \leq \lambda_F(s)n^{d-1} \text{ and } \mathfrak{d}(\mu_n, \nu_F) \leq \tilde{\epsilon}_F \right) \leq \sum_{i=1}^m c_1 \exp \left(-c_2 n^{(1)/2d} \right),$$

for c_1 and c_2 positive constants depending on p, d, s, F . □

Remark 9.19. We assert that Proposition 9.18 holds also when F is a translate of the Wulff crystal $W_{p,d}$; this follows from Theorem 9.23 for instance.

Remark 9.20. Proposition 9.18 is the result we have been aiming for since the beginning of the section: when $G_n \in \mathcal{G}_n$ is such that $\mathfrak{d}(\mu_n, \nu_F)$ is small, we have high probability lower bounds on $|\partial^\omega G_n|$ in terms of $\mathcal{I}_{p,d}(F)$. We use Proposition 9.18 with a compactness argument to prove the main results of the paper.

9.4. Proof of main results. We first prove Theorem 8.12, from which we deduce Theorem 1.3 and Theorem 1.2. A quantitative version of the isoperimetric inequality for $\mathcal{I}_{p,d}$ is central. Given $F \subset \mathbb{R}^d$ a set of finite perimeter, define the *asymmetry index* of F as

$$(9.81) \quad A(F) := \inf \left\{ \frac{\mathcal{L}^d(F \Delta (x + rW_{p,d}))}{\mathcal{L}^d(F)} : x \in \mathbb{R}^d, \mathcal{L}^d(rW_{p,d}) = \mathcal{L}^d(F) \right\}.$$

For $r > 0$ chosen to make $rW_{p,d}$ and F equal in volume, define the *isoperimetric deficit* of F as

$$(9.82) \quad D(F) := \frac{\mathcal{I}_{p,d}(F) - \mathcal{I}_{p,d}(rW_{p,d})}{\mathcal{I}_{p,d}(rW_{p,d})}.$$

The isoperimetric inequality implies $D(F) \geq 0$ for all sets F of finite perimeter, while Taylor's theorem (Theorem 2.3) implies $D(F) = 0$ if and only if $A(F) = 0$. The next result quantifies this.

Theorem 9.21. (Figalli-Maggi-Pratelli [28]) *Let $F \subset \mathbb{R}^d$ be a set of finite perimeter with finite volume. There is $c(d) > 0$ so that*

$$(9.83) \quad A(F) \leq c(d)D(F)^{1/2}.$$

Remark 9.22. It follows from Theorem 9.21 that whenever $rW_{p,d}$ is a dilate of the Wulff crystal, and whenever F^r is a set of finite perimeter such that $\mathcal{L}^d(F^r) = \mathcal{L}^d(rW_{p,d})$, we have

$$(9.84) \quad \frac{\mathcal{I}_{p,d}(F^r)}{\mathcal{I}_{p,d}(rW_{p,d})} \geq 1 + c(d)(A(F^r))^2.$$

The next theorem boosts results for polytopes to results for sets of finite perimeter.

Theorem 9.23. ([16], Proposition 14.9) *Let $F \subset [-1, 1]^d$ be a set of finite perimeter. There is a sequence of polytopes $\{F_n\}_{n=1}^\infty$, each contained within $[-1, 1]^d$, so that $\mathcal{L}^d(F \Delta F_n) \rightarrow 0$ and $|\mathcal{I}_{p,d}(F_n) - \mathcal{I}_{p,d}(F)| \rightarrow 0$ as $n \rightarrow \infty$.*

Proof of Theorem 8.12 (Precursor to shape theorem). Throughout the proof, write θ for $\theta_p(d)$. Let $\xi > 0$, define $\eta = \eta(\xi)$ via the relation

$$(9.85) \quad (1 - \eta) = \frac{1}{1 + \xi},$$

and use ξ and η to define the following collection of measures:

$$(9.86) \quad \mathcal{W}_\xi := \left\{ \nu_{W+x} : \begin{array}{l} x \in \mathbb{R}^d, (W+x) \subset [-1, 1]^d \text{ and } W \text{ is a dilate of } W_{p,d} \\ \text{such that } \mathcal{L}^d((1-\eta)W_{p,d}) \leq \mathcal{L}^d(W) \leq \mathcal{L}^d((1+2\xi)W_{p,d}) \end{array} \right\}.$$

Let $\zeta > 0$, and choose $\xi = \xi(\zeta) > 0$ and $\epsilon = \epsilon(\zeta, \xi) > 0$ so that the following relations hold:

$$(9.87) \quad \frac{1}{1 + \xi} = 1 - 2\zeta \quad \frac{1 + 2\xi}{1 + c(p, d)\epsilon^2} = 1 - 2\zeta,$$

where $c(p, d)$ is specified later. We remark that ϵ is distinct from $\epsilon(d)$ defined in (7.1); this latter fixed value only appears in exponents of various upper bounds, and we always explicate the dependence on d in this case. Our principal aim is to show the probabilities

$$(9.88) \quad \mathbb{P}_p(\exists G_n \in \mathcal{G}_n \text{ such that } \mathfrak{d}(\mu_n, \mathcal{W}_\xi) \geq \epsilon)$$

decay rapidly with n . Recall that

$$(9.89) \quad \mathcal{P}_{\gamma,\xi} = \left\{ \nu_F : F \subset [-1, 1]^d, \text{per}(F) \leq \gamma, \mathcal{L}^d(F) \leq \mathcal{L}^d((1 + \xi)W_{p,d}) \right\},$$

let $\mathcal{V}_\epsilon(\mathcal{W}_\xi)$ be the open ϵ -neighborhood of \mathcal{W}_ξ in the metric \mathfrak{d} , and let $\mathcal{K}_{\gamma,\xi}(\epsilon)$ be the complement of this neighborhood in $\mathcal{P}_{\gamma,\xi}$. By Lemma 8.11, $\mathcal{K}_{\gamma,\xi}(\epsilon)$ is compact. Define

$$(9.90) \quad \mathcal{Poly}_{\gamma,\xi} := \left\{ \nu_F : F \subset [-1, 1]^d \text{ is a polytope, } \text{per}(F) \leq 2\gamma, \mathcal{L}^d(F) \leq \mathcal{L}^d((1 + 2\xi)W_{p,d}) \right\},$$

so that using the definition of \mathfrak{d} and Theorem 9.23, the \mathfrak{d} -balls

$$(9.91) \quad \left\{ \mathcal{B}(\nu_F, \tilde{\epsilon}_F/2) \right\}_{F \in \mathcal{Poly}_{\gamma,\xi}}$$

form an open cover of $\mathcal{K}_{\gamma,\xi}(\epsilon)$, where $\tilde{\epsilon}_F$ is chosen as in Proposition 9.18 for F and $s = \zeta/2$. For a parameter $\delta' > 0$ to be used shortly, we lose no generality choosing $\tilde{\epsilon}_F$ smaller if necessary so that

$$(9.92) \quad (1 + \tilde{\epsilon}_F/\theta) \leq (1 + \delta'),$$

$$(9.93) \quad \tilde{\epsilon}_F \leq \epsilon/2$$

hold for each F . Given $F \in \mathcal{Poly}_{\gamma,\xi}$, define $\lambda_F(\zeta) := (1 - \zeta)\mathcal{I}_{p,d}(F)$ and use the compactness of $\mathcal{K}_{\gamma,\xi}(\epsilon)$ to extract a finite subcover from (9.91): there are polytopes F_1, \dots, F_m such that

$$(9.94) \quad \left\{ \mathcal{B}(\nu_{F_j}, \tilde{\epsilon}_{F_j}/2) \right\}_{j=1}^m$$

covers $\mathcal{K}_{\gamma,\xi}(\epsilon)$. We now begin to estimate (9.88).

$$(9.95) \quad \mathbb{P}_p(\exists G_n \in \mathcal{G}_n \text{ such that } \mathfrak{d}(\mu_n, \mathcal{W}_\xi) \geq \epsilon)$$

$$(9.96) \quad \leq \mathbb{P}_p\left(\max_{G_n \in \mathcal{G}_n} \mathfrak{d}(\mu_n, \mathcal{W}_\xi) \geq \epsilon \text{ and } n\widehat{\Phi}_n \leq (1 + \delta')\varphi_{W_{p,d}}\right) + \mathbb{P}_p\left(n\widehat{\Phi}_n > (1 + \delta')\varphi_{W_{p,d}}\right)$$

$$(9.97) \quad \leq \mathbb{P}_p\left(\max_{G_n \in \mathcal{G}_n} \mathfrak{d}(\mu_n, \mathcal{W}_\xi) \geq \epsilon \text{ and } n\widehat{\Phi}_n \leq (1 + \delta')\varphi_{W_{p,d}}\right) + c_1 \exp(-c_2 n^{(d-1)/3})$$

Where we have used bounds from the proof of Corollary 5.5, and we recall that $\varphi_{W_{p,d}}$ is the conductance (defined at the very end of Section 3) of the Wulff crystal. Choose $\delta > 0$ so that

$$(9.98) \quad \delta \leq \min_{j=1}^m \tilde{\epsilon}_{F_j}/2,$$

and invoke Corollary 8.9 for δ to further deduce

$$(9.99) \quad \mathbb{P}_p(\exists G_n \in \mathcal{G}_n \text{ such that } \mathfrak{d}(\mu_n, \mathcal{W}_\xi) \geq \epsilon)$$

$$(9.100) \quad \leq \mathbb{P}_p\left(\max_{G_n \in \mathcal{G}_n} \mathfrak{d}(\mu_n, \mathcal{W}_\xi) \geq \epsilon \text{ and } \max_{G_n \in \mathcal{G}_n} \mathfrak{d}(\mu_n, \mathcal{P}_{\gamma,\xi}) < \delta \text{ and } n\widehat{\Phi}_n \leq (1 + \delta')\varphi_{W_{p,d}}\right)$$

$$(9.101) \quad + c_1 \exp(-c_2 n^{(1-\epsilon(d))/2d}).$$

Use the finite open cover (9.94), the choice of δ and a union bound:

$$(9.102) \quad \mathbb{P}_p(\exists G_n \in \mathcal{G}_n \text{ such that } \mathfrak{d}(\mu_n, \mathcal{W}_\xi) \geq \epsilon)$$

$$(9.103) \quad \leq \sum_{i=1}^m \mathbb{P}_p(\exists G_n \in \mathcal{G}_n \text{ such that } \mathfrak{d}(\mu_n, \nu_{F_j}) \leq \epsilon_{F_j} \text{ and } n\widehat{\Phi}_n \leq (1 + \delta')\varphi_{W_{p,d}})$$

$$(9.104) \quad + c_1 \exp(-c_2 n^{(1-\epsilon(d))/2d}).$$

We focus on bounding each summand of the form $\mathbb{P}_p(\mathcal{F}_j)$ above, where

$$(9.105) \quad \mathcal{F}_j := \left\{ \exists G_n \in \mathcal{G}_n \text{ such that } \mathfrak{d}(\mu_n, \nu_{F_j}) \leq \epsilon_{F_j} \text{ and } n\widehat{\Phi}_n \leq (1 + \delta')\varphi_{W_{p,d}} \right\}.$$

We begin by unravelling the Cheeger constant and using (9.92).

$$(9.106) \quad \mathbb{P}_p(\mathcal{F}_j) = \mathbb{P}_p \left(\begin{array}{c} \exists G_n \in \mathcal{G}_n \text{ such that } \mathfrak{d}(\mu_n, \nu_{F_j}) \leq \widetilde{\epsilon}_{F_j} \\ \text{and} \\ n|\partial^\omega G_n| \leq (1 + \delta')|G_n|\varphi_{W_{p,d}} \end{array} \right)$$

$$(9.107) \quad \leq \mathbb{P}_p \left(\begin{array}{c} \exists G_n \in \mathcal{G}_n \text{ such that } \mathfrak{d}(\mu_n, \nu_{F_j}) \leq \widetilde{\epsilon}_{F_j} \\ \text{and} \\ n|\partial^\omega G_n| \leq (1 + \delta')n^d(\theta\mathcal{L}^d(F_j) + \widetilde{\epsilon}_{F_j})\varphi_{W_{p,d}} \end{array} \right)$$

$$(9.108) \quad \leq \mathbb{P}_p \left(\begin{array}{c} \exists G_n \in \mathcal{G}_n \text{ such that } \mathfrak{d}(\mu_n, \nu_{F_j}) \leq \widetilde{\epsilon}_{F_j} \\ \text{and} \\ |\partial^\omega G_n| \leq (1 + \delta')^2 n^{d-1} \theta \mathcal{L}^d(F_j) \varphi_{W_{p,d}} \end{array} \right).$$

To obtain (9.107), we used the definition of \mathfrak{d} , and to obtain (9.108) we used (9.92). Observe that

$$(9.109) \quad \mathbb{P}_p(\mathcal{F}_j) \leq \mathbb{P}_p \left(\begin{array}{c} \exists G_n \in \mathcal{G}_n \text{ such that } \mathfrak{d}(\mu_n, \nu_{F_j}) \leq \widetilde{\epsilon}_{F_j} \\ \text{and} \\ |\partial^\omega G_n| \leq (1 + \delta')^2 n^{d-1} \mathcal{I}_{p,d}(F_j) (\varphi_{F_j})^{-1} \varphi_{W_{p,d}} \end{array} \right)$$

$$(9.110) \quad \leq \mathbb{P}_p \left(\begin{array}{c} \exists G_n \in \mathcal{G}_n \text{ such that } \mathfrak{d}(\mu_n, \nu_{F_j}) \leq \widetilde{\epsilon}_{F_j} \\ \text{and} \\ |\partial^\omega G_n| \leq (1 + \delta')^2 \frac{\mathcal{I}_{p,d}(rW_{p,d})}{\mathcal{I}_{p,d}(F_j)} r n^{d-1} \mathcal{I}_{p,d}(F_j) \end{array} \right),$$

where $r > 0$ is chosen so that $\mathcal{L}^d(F_j) = \mathcal{L}^d(rW_{p,d})$. Form two cases. In *Case (1)*, $r \leq (1 - \eta)$, and in *Case (2)*, $r \in (1 - \eta, 1 + 2\xi]$. Focusing on the first case for now, use Theorem 2.3 and the relation (9.85) between ξ and η :

$$(9.111) \quad \mathbb{P}_p(\mathcal{F}_j) \leq \mathbb{P}_p \left(\begin{array}{c} \exists G_n \in \mathcal{G}_n \text{ such that } \mathfrak{d}(\mu_n, \nu_{F_j}) \leq \widetilde{\epsilon}_{F_j} \\ \text{and} \\ |\partial^\omega G_n| \leq \frac{(1+\delta')^2}{1+\xi} n^{d-1} \mathcal{I}_{p,d}(F_j) \end{array} \right)$$

As ξ was chosen as in (9.87), we choose δ' small enough depending on ξ and ζ so that

$$(9.112) \quad \mathbb{P}_p(\mathcal{F}_j) \leq \mathbb{P}_p \left(\exists G_n \in \mathcal{G}_n \text{ such that } \mathfrak{d}(\mu_n, \nu_{F_j}) \leq \widetilde{\epsilon}_{F_j} \text{ and } |\partial^\omega G_n| \leq \lambda_{F_j}(\zeta) n^{d-1} \right)$$

holds whenever we are in *Case (1)*.

We maneuver into a similar position in *Case (2)*. From (9.110), we deduce

$$(9.113) \quad \mathbb{P}_p(\mathcal{F}_j) \leq \mathbb{P}_p \left(\begin{array}{c} \exists G_n \in \mathcal{G}_n \text{ such that } \mathfrak{d}(\mu_n, \nu_{F_j}) \leq \widetilde{\epsilon}_{F_j} \\ \text{and} \\ |\partial^\omega G_n| \leq \frac{(1+\delta')^2}{1+c(d)A(F_j)^2} (1 + 2\xi) n^{d-1} \mathcal{I}_{p,d}(F_j) \end{array} \right),$$

where $A(F_j)$ is the asymmetry index of F_j introduced in (9.81), and where we have used the observation in (9.84). In (9.93), we chose each $\widetilde{\epsilon}_{F_j}$ to be at most $\epsilon/2$. The finite open cover (9.94) may be assumed to have no redundancies, so by the construction of $\mathcal{K}_{\gamma,\xi}(\epsilon)$,

$$(9.114) \quad \mathfrak{d}(\nu_{F_j}, \mathcal{W}_\xi) \geq \epsilon/2$$

for each F_j . Using the definition (2.6) of \mathfrak{d} , we have the following lower-bound on the asymmetry index of each F_j :

$$(9.115) \quad A(F_j) \geq (\epsilon/4)\mathcal{L}^d(F_j) \geq (\epsilon/4)(1-\eta)\mathcal{L}^d(W_{p,d}).$$

As ξ and hence η will be taken to zero, we lose no generality supposing $\eta < 1/2$. Thus, (9.115) and (9.113) together yield

$$(9.116) \quad \mathbb{P}_p(\mathcal{F}_j) \leq \mathbb{P}_p \left(\begin{array}{c} \exists G_n \in \mathcal{G}_n \text{ such that } \mathfrak{d}(\mu_n, \nu_{F_j}) \leq \tilde{\epsilon}_{F_j} \\ \text{and} \\ |\partial^\omega G_n| \leq \frac{(1+\delta')^2}{1+c(p,d)\epsilon^2} (1+2\xi)n^{d-1} \mathcal{I}_{p,d}(F_j) \end{array} \right).$$

Now use our choice of ϵ in (9.87), taking δ' sufficiently small depending on ξ and ζ so that

$$(9.117) \quad \mathbb{P}_p(\mathcal{F}_j) \leq \mathbb{P}_p(\exists G_n \in \mathcal{G}_n \text{ such that } \mathfrak{d}(\mu_n, \nu_{F_j}) \leq \tilde{\epsilon}_{F_j} \text{ and } |\partial^\omega G_n| \leq \lambda_{F_j}(\zeta)n^{d-1})$$

holds in *Case (2)* also.

Return to (9.104) and apply the bounds (9.112) and (9.117) to each summand:

$$(9.118) \quad \mathbb{P}_p(\exists G_n \in \mathcal{G}_n \text{ such that } \mathfrak{d}(\mu_n, \mathcal{W}_\xi) \geq \epsilon)$$

$$(9.119) \quad \leq \sum_{i=1}^m \mathbb{P}_p(\exists G_n \in \mathcal{G}_n \text{ such that } \mathfrak{d}(\mu_n, \nu_{F_j}) \leq \tilde{\epsilon}_{F_j} \text{ and } |\partial^\omega G_n| \leq \lambda_{F_j}(\zeta)n^{d-1})$$

$$(9.120) \quad + c_1 \exp(-c_2 n^{(1-\epsilon(d))/2d}).$$

Thus,

$$(9.121) \quad \mathbb{P}_p(\exists G_n \in \mathcal{G}_n \text{ such that } \mathfrak{d}(\mu_n, \mathcal{W}_\xi) \geq \epsilon) \leq mc_1 \exp(-c_2 n^{1/2d}) + c_1 \exp(-c_2 n^{(1-\epsilon(d))/2d}).$$

We have used the hard-earned bounds from Proposition 9.18 directly above. By Borel-Cantelli,

$$(9.122) \quad \mathbb{P}_p \left(\max_{G_n \in \mathcal{G}_n} \mathfrak{d}(\mu_n, \mathcal{W}_\xi) \leq \epsilon(\zeta, \xi) \text{ for all but finitely many } n \right) = 1.$$

Observe that

$$(9.123) \quad \mathfrak{d}(\mathcal{W}_\xi, \mathcal{W}) \leq c(p, d) \max \left(\mathcal{L}^d(W_{p,d} \setminus (1-\eta)W_{p,d}), \mathcal{L}^d((1+2\xi)W_{p,d} \setminus W_{p,d}) \right),$$

$$(9.124) \quad \leq c(p, d, \xi),$$

where $c(p, d, \xi)$ tends to 0 as $\xi \rightarrow 0$. From (9.87), we have that $\xi \equiv \xi(\zeta) \rightarrow 0$ as $\zeta \rightarrow 0$ and also that $\epsilon \equiv \epsilon(\zeta, \xi) \rightarrow 0$ as $\zeta, \xi \rightarrow 0$. Thus,

$$(9.125) \quad \mathbb{P}_p \left(\max_{G_n \in \mathcal{G}_n} \mathfrak{d}(\mu_n, \mathcal{W}) \leq c(p, d, \zeta) \text{ for all but finitely many } n \right) = 1$$

where $c(p, d, \zeta) \rightarrow 0$ as $\zeta \rightarrow 0$. This completes the proof of Theorem 8.12. \square

Proof of Theorem 1.3 (Cheeger asymptotics). We first show \mathcal{W} is compact in \mathfrak{d} by appealing to the proof of Lemma 8.11. It suffices to show that whenever $\{W_n\}_{n=1}^\infty$ is a sequence with $\nu_{W_n} \in \mathcal{W}$ and $\mathbf{1}_{W_n}$ tending to some $\mathbf{1}_F$ in L^1 -sense, F is a translate of $W_{p,d}$. By dominated convergence, $\mathcal{L}^d(F) = \mathcal{L}^d(W_{p,d})$. Lemma A.14 implies $\mathcal{I}_{p,d}(F) \leq \mathcal{I}_{p,d}(W_{p,d})$, and it follows from Theorem 2.3 that F is a translate of $W_{p,d}$.

Let $\epsilon, \zeta' > 0$. For each $\nu_W \in \mathcal{W}$, choose $\tilde{\epsilon}_W$ as in Proposition 9.18 for $\zeta' = 2s$ (see Remark 9.19). The \mathfrak{d} -balls $\mathcal{B}(\nu_W, \tilde{\epsilon}_W/2)$ indexed by \mathcal{W} are an open cover of \mathcal{W} ; extract a finite collection of translates of $W_{p,d}$, enumerated W_1, \dots, W_m , so that

$$(9.126) \quad \left\{ \mathcal{B}(\nu_{W_i}, \tilde{\epsilon}_{W_i}/2) \right\}_{i=1}^m$$

covers \mathcal{W} . Choose $\zeta > 0$ small so that $c(p, d, \zeta)$ in (9.125) is at most $\min_{i=1}^m \tilde{\epsilon}_{W_i}/2$, and work in the almost sure event from (9.125). Use Proposition 9.18, Remark 9.19 and Borel-Cantelli to conclude

$$(9.127) \quad \mathbb{P}_p \left(\liminf_{n \rightarrow \infty} \min_{G_n \in \mathcal{G}_n} \frac{|\partial^\omega G_n|}{n^{d-1}} \geq (1 - \zeta') \mathcal{I}_{p,d}(W_{p,d}) \right) = 1.$$

Because we are within the event from (9.125), we take ζ smaller if necessary in a way depending on p, d and ζ' so that

$$(9.128) \quad \mathbb{P}_p \left(\limsup_{n \rightarrow \infty} \max_{G_n \in \mathcal{G}_n} \frac{|G_n|}{n^d} \leq (1 + \zeta') \theta_p(d) \mathcal{L}^d(W_{p,d}) \right) = 1.$$

Choose ζ' small depending on ϵ so that by (9.127) and (9.128),

$$(9.129) \quad \mathbb{P}_p \left(\liminf_{n \rightarrow \infty} n \widehat{\Phi}_n \geq (1 - \epsilon) \frac{\mathcal{I}_{p,d}(W_{p,d})}{\theta_p(d) \mathcal{L}^d(W_{p,d})} \right) = 1.$$

The complementary upper bound on $\widehat{\Phi}_n$ was shown in Corollary 5.5, completing the proof. \square

Proof of Theorem 1.2 (Shape theorem). In (5.54), we defined the empirical measure of a translate $W \subset [-1, 1]^d$ of the Wulff crystal as:

$$(9.130) \quad \bar{\nu}_W(n) := \frac{1}{n^d} \sum_{x \in \mathbb{C}_\infty \cap nW} \delta_{x/n}.$$

Let $\epsilon, \epsilon' > 0$. Define $M_n := n^{-1} \mathbb{Z}^d \cap [-1, 1]^d$, so that $|M_n| \leq (3n)^d$. By Corollary 5.6, there are positive constants $c_1(p, d, \epsilon')$ and $c_2(p, d, \epsilon')$ so that

$$(9.131) \quad \mathbb{P}_p \left(\max_{x \in M_n, (W_{p,d}+x) \subset [-1, 1]^d} \mathfrak{d}(\bar{\nu}_{W_{p,d}+x}(n), \nu_{W_{p,d}+x}) \leq \epsilon' \right) \geq 1 - c_1 \exp(-c_2 n^{d-1}),$$

and by Borel-Cantelli, the event

$$(9.132) \quad \mathcal{E}_1 := \left\{ \limsup_{n \rightarrow \infty} \max_{x \in M_n, (W_{p,d}+x) \subset [-1, 1]^d} \mathfrak{d}(\bar{\nu}_{W_{p,d}+x}(n), \nu_{W_{p,d}+x}) \leq \epsilon' \right\}$$

occurs almost surely.

Choose ζ in (9.125) small depending on ϵ' , so that the event

$$(9.133) \quad \mathcal{E}_2 := \left\{ \max_{G_n \in \mathcal{G}_n} \mathfrak{d}(\mu_n, \mathcal{W}) \leq \epsilon' \text{ for all but finitely many } n \right\}$$

also occurs almost surely. Take n large depending on ϵ' so that for any translate $W \subset [-1, 1]^d$ of the Wulff crystal, there is $x \in M_n$ with $\mathfrak{d}(\nu_W, \nu_{W_{p,d}+x}) \leq \epsilon'$. For any $\omega \in \mathcal{E}_1 \cap \mathcal{E}_2$, there is $N(\omega) \in \mathbb{N}$ so that $n \geq N(\omega)$ implies

$$(9.134) \quad \max_{G_n \in \mathcal{G}_n} \min_{x \in M_n} \mathfrak{d}(\mu_n, \bar{\nu}_{W_{p,d}+x}(n)) \leq 3\epsilon'.$$

Suppose the following holds for some $G_n \in \mathcal{G}_n$ and some $x \in M_n$:

$$(9.135) \quad \mathfrak{d}(\mu_n, \bar{\nu}_{W_{p,d}+x}(n)) \leq 3\epsilon'.$$

Let $k \in \mathbb{N}$, and let $\Delta^k \equiv \Delta^{k,d}$ denote the dyadic cubes at scale k contained in $[-1, 1]^d$. Define

$$(9.136) \quad \mathcal{Q} := \left\{ Q \in \Delta^k : Q \cap \partial(W_{p,d} + x) \neq \emptyset \right\},$$

and observe that

$$(9.137) \quad \left\| \mathbf{1}_{G_n} - \mathbf{1}_{n(W_{p,d}+x) \cap \mathbf{C}_n} \right\|_{\ell^1} \leq \sum_{Q \in \Delta^k} \left\| \mathbf{1}_{G_n \cap nQ} - \mathbf{1}_{n(W_{p,d}+x) \cap \mathbf{C}_n \cap nQ} \right\|_{\ell^1},$$

$$(9.138) \quad \leq \sum_{Q \in \Delta^k \setminus \mathcal{Q}} \left\| \mathbf{1}_{G_n \cap nQ} - \mathbf{1}_{n(W_{p,d}+x) \cap \mathbf{C}_n \cap nQ} \right\|_{\ell^1} + \sum_{Q \in \mathcal{Q}} \left\| \mathbf{1}_{G_n \cap nQ} - \mathbf{1}_{n(W_{p,d}+x) \cap \mathbf{C}_n \cap nQ} \right\|_{\ell^1},$$

$$(9.139) \quad \leq \sum_{Q \in \Delta^k \setminus \mathcal{Q}} \left\| \mathbf{1}_{G_n \cap nQ} - \mathbf{1}_{n(W_{p,d}+x) \cap \mathbf{C}_n \cap nQ} \right\|_{\ell^1} + c(p, d)2^{-dk}n^d,$$

where $c(p, d) > 0$ accounts for the perimeter of $W_{p,d}$. For each $Q \in \Delta^k \setminus \mathcal{Q}$, either $n(W_{p,d}+x) \cap nQ = nQ$ or $n(W_{p,d}+x) \cap nQ = \emptyset$. From the definition (2.6) of \mathfrak{d} ,

$$(9.140) \quad \left\| \mathbf{1}_{G_n} - \mathbf{1}_{n(W_{p,d}+x) \cap \mathbf{C}_n} \right\|_{\ell^1} \leq 2^k |\Delta^k| n^d \mathfrak{d}(\mu_n, \bar{\nu}_{W_{p,d}+x}(n)) + c(p, d)2^{-dk}n^d.$$

Choose k large depending on ϵ , and then ϵ' small depending on ϵ and k , using (9.135), to conclude

$$(9.141) \quad n^{-d} \left\| \mathbf{1}_{G_n} - \mathbf{1}_{n(W_{p,d}+x) \cap \mathbf{C}_n} \right\|_{\ell^1} \leq \epsilon.$$

The choice of k and ϵ' do not depend on $G_n \in \mathcal{G}_n$, on $x \in M_n$ or on $\omega \in \mathcal{E}_1 \cap \mathcal{E}_2$. For ϵ' chosen this way according to k and ϵ , for any $\omega \in \mathcal{E}_1 \cap \mathcal{E}_2$, and $n \geq N(\omega)$,

$$(9.142) \quad \max_{G_n \in \mathcal{G}_n} \min_{x \in M_n} \left(n^{-d} \left\| \mathbf{1}_{G_n} - \mathbf{1}_{n(W_{p,d}+x) \cap \mathbf{C}_n} \right\|_{\ell^1} \right) \leq \epsilon.$$

We conclude that for any $\epsilon > 0$,

$$(9.143) \quad \mathbb{P}_p \left(\limsup_{n \rightarrow \infty} \max_{G_n \in \mathcal{G}_n} \inf_{x \in \mathbb{R}^d} n^{-d} \left\| \mathbf{1}_{G_n} - \mathbf{1}_{\mathbf{C}_n \cap (x+nW_{p,d})} \right\|_{\ell^1} \leq \epsilon \right) = 1,$$

completing the proof. □

APPENDIX A. TOOLS FROM PERCOLATION, GRAPH THEORY AND GEOMETRY

A.1. Tools from percolation. We present tools from percolation used throughout the paper, introducing the notation $\Lambda(n) := [-n, n]^d \cap \mathbb{Z}^d$. Proposition A.1 and its corollary control the size of open edge boundaries of large subgraphs of \mathbf{C}_n .

Proposition A.1. (Berger-Biskup-Hoffman-Kozma [6], Proposition A.2) *Let $d \geq 2$ and $p > p_c(d)$. There are positive constants $c_1(p, d)$, $c_2(p, d)$ and $c_3(p, d)$ so that for all $t > 0$,*

$$(A.1) \quad \mathbb{P}_p \left(\exists \Lambda \ni 0, \omega\text{-connected}, |\Lambda| \geq t^{d/(d-1)}, |\partial^\omega \Lambda| < c_3 |\Lambda|^{(d-1)/d} \right) \leq c_1 \exp(-c_2 t).$$

The next corollary is similar to Proposition A.1 in [6]; we include the proof because it is short.

Corollary A.2. *Let $d \geq 2$, $p > p_c(d)$ and $\alpha \in (0, 1)$. There are positive constants $c_1(p, d)$, $c_2(p, d)$, $c_3(p, d)$ and an almost surely finite random variable $R = R(\omega)$ such that whenever $n \geq R$, we have the following lower bound on $|\partial^\omega \Lambda|$ for each ω -connected Λ satisfying $\Lambda \subset \mathbf{C}_{2n}$ and $|\Lambda| \geq n^\alpha$:*

$$(A.2) \quad |\partial^\omega \Lambda| \geq c_3 |\Lambda|^{(d-1)/d}.$$

Moreover, we have the following tail bounds on R :

$$(A.3) \quad \mathbb{P}_p(R > n) \leq c_1 n^d \exp\left(-c_2 n^{\alpha(d-1)/d}\right).$$

Proof. Let c_3 be as in Proposition A.1, and for $\alpha \in (0, 1)$ let \mathcal{E}_n be the following event:

$$(A.4) \quad \left\{ \exists \Lambda, \omega\text{-connected with } \Lambda \subset \mathbf{C}_{2n}, |\Lambda| \geq n^\alpha \text{ but } |\partial^\omega \Lambda| < c_3 |\Lambda|^{(d-1)/d} \right\}.$$

Apply Proposition A.1 to every point in the box $\Lambda(2n)$ with $t = n^{\alpha(d-1)/d}$ to obtain

$$(A.5) \quad \mathbb{P}_p(\mathcal{E}_n) \leq c_1 n^d \exp\left(-c_2 n^{\alpha(d-1)/d}\right).$$

These probabilities are summable in n . Let R be the (random) smallest natural number such that that $n \geq R$ implies \mathcal{E}_n^c occurs. As $\{R > n\} \subset \mathcal{E}_n$, the proof is complete. \square

We now introduce a tool for controlling the density of the infinite cluster within a large box.

Proposition A.3. (Durrett-Schonmann [27], Gandolfi [29]) *Let $d \geq 2$ and $p > p_c(d)$. Recall that $\theta_p(d) = \mathbb{P}_p(0 \in \mathbf{C}_\infty)$ is the density of the infinite cluster. For any $\epsilon > 0$, there are positive constants $c_1(p, d, \epsilon)$ and $c_2(p, d, \epsilon)$ so that*

$$(A.6) \quad \mathbb{P}_p\left(\frac{|\mathbf{C}_n|}{|\Lambda(n)|} \notin (\theta_p(d) - \epsilon, \theta_p(d) + \epsilon)\right) \leq c_1 \exp\left(-c_2 n^{d-1}\right).$$

Proposition A.3 was later refined by Pisztora [50]; the following is an immediate corollary.

Corollary A.4. *Let $d \geq 2$ and $p > p_c(d)$. Let $r > 0$, let $Q \subset \mathbb{R}^d$ be a translate of the cube $[-r, r]^d$ and let $\epsilon > 0$. There are positive constants $c_1(p, d, \epsilon)$, $c_2(p, d, \epsilon)$ so that*

$$(A.7) \quad \mathbb{P}\left(\frac{|\mathbf{C}_\infty \cap Q|}{\mathcal{L}^d(Q)} \notin (\theta_p(d) - \epsilon, \theta_p(d) + \epsilon)\right) \leq c_1 \exp\left(-c_2 r^{d-1}\right).$$

The next result is fundamental, it is used in Section 9.

Theorem A.5. (Grimmett-Marstrand [36]) *Let $d \geq 2$ and $p > p_c(d)$, and let $\mathbf{C}(0)$ denote the open cluster containing the origin. There is a positive constant $c(p)$ so that*

$$(A.8) \quad \mathbb{P}_p(|\mathbf{C}(0)| = n) \leq \exp\left(-cn^{(d-1)/d}\right).$$

We now apply these tools to the $G_n \in \mathcal{G}_n$, and begin with a basic observation.

Lemma A.6. *For all n , if $G_n \in \mathcal{G}_n$ is disconnected, then G_n is a finite disjoint union of connected optimal subgraphs.*

Proof. The proof follows from the identity that for $a, b, c, d > 0$,

$$(A.9) \quad \frac{a+b}{c+d} \geq \min\left(\frac{a}{c}, \frac{b}{d}\right).$$

Remark 2.2 implies the connected components of any $G_n \in \mathcal{G}_n$ have disjoint open edge boundaries. If G_n is optimal and disconnected, decompose G into two disjoint subgraphs G'_n and G''_n and we must have $\varphi_{G_n} = \varphi_{G'_n} = \varphi_{G''_n}$. \square

We now use Corollary A.4 to obtain a high probability upper bound on $\widehat{\Phi}_n$.

Lemma A.7. *Let $d \geq 2$ and $p > p_c(d)$. There are positive constants $c_1(p, d)$, $c_2(p, d)$ and $c'_3(p, d)$ so that*

$$(A.10) \quad \mathbb{P}_p(\widehat{\Phi}_n > c'_3 n^{-1}) \leq c_1 \exp(-c_2 n^{d-1}).$$

Proof. Abbreviate $\theta_p(d)$ as θ and work in the high probability event from Corollary A.4 for the box $[-r, r]^d$ with $r := n/2(d!)^{1/d}$ for some $\epsilon > 0$. Also work in the corresponding high probability event for the box $[-n, n]^d$ with the same ϵ . Write $\epsilon' \equiv \epsilon/\theta$ and let H_n be $\mathbf{C}_\infty \cap [-r, r]^d$, so that

$$(A.11) \quad (1 - \epsilon')\theta(2r)^d \leq |H_n| \leq (1 - \epsilon')\theta(2n)^d$$

holds when ϵ is taken small depending on d . Thus, H_n is valid with volume on the order of n^d . The size of $\partial^\omega H_n$ is at most the \mathcal{H}^{d-1} -measure of $\partial[-r, r]^d$, which completes the proof. \square

We use Lemma A.7 with Corollary A.2 to bound the volume of any $G_n \in \mathcal{G}_n$ from below.

Lemma A.8. *Let $d \geq 2$ and $p > p_c(d)$. There are positive constants $c_1(p, d)$, $c_2(p, d)$ and $\eta_1(p, d)$ so that,*

$$(A.12) \quad \mathbb{P}_p(\exists G_n \in \mathcal{G}_n \text{ such that } |G_n| < \eta_1 n^d) \leq c_1 \exp(-c_2 n^{(d-1)/2d}).$$

Proof. Set $\alpha = 1/2$, and work in the intersection of the high probability events

$$(A.13) \quad \{\widehat{\Phi}_n \leq c'_3 n^{-1}\} \cap \{R \leq n\}$$

respectively from Lemma A.7 and Corollary A.2. For $G_n \in \mathcal{G}_n$, use Lemma A.6 to extract from G_n a connected subgraph $H_n \subset G_n$ with $H_n \in \mathcal{G}_n$. If $|H_n| \leq n^{1/2}$, that $H_n \subset \mathbf{C}_n$ implies $\partial^\omega H_n$ is non-empty, and hence that $\varphi_{H_n} > n^{-1/2}$. This is impossible when $\widehat{\Phi}_n \leq c'_3 n^{-1}$ and n is large.

Suppose $|H_n| \geq n^{1/2}$, and use the event from Corollary A.2:

$$(A.14) \quad |\partial^\omega H_n| \geq c_3 |H_n|^{(d-1)/d}.$$

Thus,

$$(A.15) \quad c_3 |H_n|^{-1/d} \leq \varphi_{H_n} \leq c'_3 n^{-1},$$

and the claim holds with $\eta_1 = (c_3/c'_3)^d$. \square

Using Lemma A.8 with Lemma A.6 and the bound $|\Lambda(n)| \leq (3n)^d$, we deduce the following.

Corollary A.9. *Let $d \geq 2$ and $p > p_c(d)$. There are positive constants $c_1(p, d)$, $c_2(p, d)$ and $\eta_4(p, d)$ so that*

$$(A.16) \quad \mathbb{P}_p \left(\exists G_n \in \mathcal{G}_n \text{ such that the number of connected components of } G_n \text{ exceeds } \eta_4 \right) \leq c_1 \exp \left(-c_2 n^{(d-1)/2d} \right).$$

Having established that Cheeger optimizers are usually volume order, we now exhibit control on the open edge boundary of each Cheeger optimizer.

Lemma A.10. *Let $d \geq 2$ and $p > p_c(d)$. There are positive constants $c_1(p, d)$, $c_2(p, d)$ and $\eta_2(p, d)$, $\eta_3(p, d)$ so that*

$$(A.17) \quad \mathbb{P}_p \left(\exists G_n \in \mathcal{G}_n \text{ so that } |\partial^\omega G_n| < \eta_2 n^{d-1} \text{ or } |\partial^\omega G_n| > \eta_3 n^{d-1} \right) \leq c_1 \exp \left(-c_2 n^{(d-1)/2d} \right).$$

Proof. Work in the high probability event $\{\widehat{\Phi}_n \leq c'_3 n^{-1}\}$ from Lemma A.7 and consider $G_n \in \mathcal{G}_n$. Set $\eta_3 = (c'_3)3^d$. As $\varphi_{G_n} \leq c'_3 n^{-1}$ and $|G_n| \leq (3n)^d$,

$$(A.18) \quad |\partial^\omega G_n| \leq \eta_3 n^{d-1}.$$

To prove the second half of this lemma, set $\alpha = 1/2$ and work in the intersection of the events

$$(A.19) \quad \{R \leq n\} \cap \{\forall G_n \in \mathcal{G}_n, \text{ we have } |G_n| \geq \eta_1 n^d\}$$

from Corollary A.2 and Lemma A.8. Given $G_n \in \mathcal{G}_n$, extract through Lemma A.6 a subgraph $H_n \subset G_n$ which is connected and optimal. Within $\{R \leq n\}$,

$$(A.20) \quad |\partial^\omega G_n| \geq |\partial^\omega H_n| \geq c_3 \left(\eta_1 n^d \right)^{(d-1)/d},$$

and we set $\eta_2 = c_3(\eta_1)^{(d-1)/d}$. □

A.2. Tools from graph theory, approximation, miscellany. We begin by stating Turán's theorem, used in the proof of Proposition 7.7. For a graph (V, E) , an *independent* set of vertices $A \subset V$ is a collection of vertices such that no two elements of A are joined by an edge in E . For a finite graph (V, E) , the *independence number* of (V, E) is

$$(A.21) \quad \alpha(V, E) := \max \{ |A| : A \text{ is an independent subset of } V \}.$$

Theorem A.11. ([55], Lemma 6) *For (V, E) a finite graph with maximal degree δ ,*

$$(A.22) \quad \alpha(V, E) \geq \frac{|V|}{\delta + 1}.$$

The next tool is standard, it gives bounds on the number of $*$ -connected subsets of \mathbb{Z}^d containing the origin.

Proposition A.12. ([34], Equation (4.24)) *There is a positive constant $c(d)$ so that the number of $*$ -connected subsets of \mathbb{Z}^d of size s containing the origin is at most $[c(d)]^s$.*

Moving back to the continuum, we make a short remark.

Remark A.13. We use the phrase isometric image throughout the paper. An isometry $i : \mathbb{R}^{d-1} \rightarrow \mathbb{R}^d$ is a function preserving Euclidean distances. Given $F \subset \mathbb{R}^d$, say F is the *isometric image* of a set $E \subset \mathbb{R}^{d-1}$ if there is an isometry $i : \mathbb{R}^{d-1} \rightarrow \mathbb{R}^d$ so that $i(E) = F$.

We now discuss the surface energy functional defined in (2.7).

Lemma A.14. ([16], Section 14.2) *Let τ be a norm on \mathbb{R}^d . The associated surface energy functional \mathcal{I}_τ is lower semicontinuous: if E_n is a sequence of Borel sets in \mathbb{R}^d such that $\mathbf{1}_{E_n} \rightarrow \mathbf{1}_E$ in L^1 -sense, then*

$$(A.23) \quad \mathcal{I}_\tau(E) \leq \liminf_{n \rightarrow \infty} \mathcal{I}_\tau(E_n)$$

A consequence of lower semicontinuity is the following approximation result.

Proposition A.15. *Consider the Wulff crystal $W_{p,d}$ of Theorem 1.2. Given $\epsilon > 0$, there is a polytope $P_\epsilon \subset W_{p,d}$ so that*

- (i) $|\mathcal{I}_{p,d}(P_\epsilon) - \mathcal{I}_{p,d}(W_{p,d})| \leq \epsilon$
- (ii) $\mathcal{L}^d(W_{p,d} \setminus P_\epsilon) \leq \epsilon$

The last object we deal with is \mathbf{S} from Section 3, specifically the nicely varying property defined in Section 3.4. Let \mathbb{S}_+^{d-1} denote the closed, upper hemisphere of the unit $(d-1)$ -sphere \mathbb{S}^{d-1} . Write $T\mathbb{S}^{d-1}$ for the tangent bundle of \mathbb{S}^{d-1} , and let $T\mathbb{S}_+^{d-1}$ be the restriction of this bundle to the upper hemisphere. An *orthonormal k -frame* on \mathbb{S}_+^{d-1} is an assignment taking each $x \in \mathbb{S}_+^{d-1}$ to an ordered collection of k orthonormal vectors in $T_x\mathbb{S}_+^{d-1}$, the tangent plane to \mathbb{S}_+^{d-1} at x . This may be written in Euclidean coordinates due to natural embeddings of the sphere and tangent spaces into \mathbb{R}^d , and may thus be written as a function

$$(A.24) \quad f : x \mapsto (v_1(x), \dots, v_k(x)),$$

with $x \in \mathbb{S}_+^{d-1} \subset \mathbb{R}^d$, and with each $v_i(x) \in T_x\mathbb{S}_+^{d-1} \subset \mathbb{R}^d$.

Proposition A.16. *There is an orthonormal $(d-1)$ -frame f and a constant $C > 0$ so that for $\epsilon > 0$, whenever $x, y \in \mathbb{S}_+^{d-1}$ satisfy $|x - y|_2 \leq \epsilon$, we have*

$$(A.25) \quad |(f(x))_i - (f(y))_i|_2 \leq C\epsilon$$

for all $i \in \{1, \dots, d-1\}$.

Proof. Let $s \in \mathbb{S}^{d-1}$ denote the south pole, with coordinate representation $(0, \dots, 0, -1)$ in \mathbb{R}^d . Consider the standard stereographic projection $\pi : \mathbb{S}^{d-1} \setminus \{s\} \rightarrow \mathbb{R}^{d-1}$. The image of \mathbb{S}_+^{d-1} under π is a closed disc $D \subset \mathbb{R}^{d-1}$ centered at the origin. The disc D is *parallelizable*, that is, we may construct a smooth $(d-1)$ -frame g on D . Indeed, one can take the standard basis for \mathbb{R}^{d-1} at each tangent space $T_y D$. Define f as the pullback $\pi^* g$. As f varies smoothly over a compact domain, each of its coordinate functions is Lipschitz, which completes the proof. \square

REFERENCES

- [1] G. Alberti, G. Bellettini, M. Cassandro, and E. Presutti. Surface tension in Ising systems with Kac potentials. *J. Statist. Phys.*, 82(3-4):743–796, 1996.
- [2] K. Alexander, J. Chayes, and L. Chayes. The Wulff construction and asymptotics of the finite cluster distribution for two-dimensional Bernoulli percolation. *Comm. Math. Phys.*, 131(1):1–50, 1990.
- [3] N. Alon. Eigenvalues and expanders. *Combinatorica*, 6(2):83–96, 1986.
- [4] P. Antal and Á. Pisztorá. On the chemical distance for supercritical Bernoulli percolation. *Ann. Probab.*, 24(2):1036–1048, 1996.
- [5] I. Benjamini and E. Mossel. On the mixing time of a simple random walk on the supercritical percolation cluster. *Probability Theory and Related Fields*, 125(3):408–420, 2003.

- [6] N. Berger, M. Biskup, C. Hoffman, and G. Kozma. Anomalous heat-kernel decay for random walk among bounded random conductances. *Annales de l'IHP Probabilités et statistiques*, 44(2):374–392, 2008.
- [7] M. Biskup, O. Louidor, E. B. Procaccia, and R. Rosenthal. Isoperimetry in two-dimensional percolation. *Comm. Pure Appl. Math.*, 68(9):1483–1531, 2015.
- [8] T. Bodineau. The Wulff construction in three and more dimensions. *Comm. Math. Phys.*, 207(1):197–229, 1999.
- [9] T. Bodineau. On the van der Waals theory of surface tension. *Markov Process. Related Fields*, 8(2):319–338, 2002.
- [10] T. Bodineau, D. Ioffe, and Y. Velenik. Rigorous probabilistic analysis of equilibrium crystal shapes. *J. Math. Phys.*, 41(3):1033–1098, 2000.
- [11] T. Bodineau, D. Ioffe, and Y. Velenik. Winterbottom construction for finite range ferromagnetic models: an \mathbb{L}_1 -approach. *J. Statist. Phys.*, 105(1-2):93–131, 2001.
- [12] A. Braides and A. Piatnitski. Variational problems with percolation: dilute spin systems at zero temperature. *J. Statist. Phys.*, 149(5):846–864, 2012.
- [13] A. Braides and A. Piatnitski. Homogenization of surface and length energies for spin systems. *J. Funct. Anal.*, 264(6):1296–1328, 2013.
- [14] R. M. Burton and M. Keane. Density and uniqueness in percolation. *Comm. Math. Phys.*, 121(3):501–505, 1989.
- [15] R. Cerf. Large deviations for three dimensional supercritical percolation. *Astérisque*, (267):vi+177, 2000.
- [16] R. Cerf. *The Wulff crystal in Ising and percolation models*. Lecture Notes in Mathematics, vol. 1878, Springer-Verlag, Berlin, 2006.
- [17] R. Cerf and Á. Pisztora. On the Wulff crystal in the Ising model. *Ann. Probab.*, 28(3):947–1017, 2000.
- [18] R. Cerf and Á. Pisztora. Phase coexistence in Ising, Potts and percolation models. *Ann. Inst. H. Poincaré Probab. Statist.*, 37(6):643–724, 2001.
- [19] R. Cerf and M. Théret. Lower large deviations for the maximal flow through a domain of \mathbb{R}^d in first passage percolation. *Probab. Theory Related Fields*, 150(3-4):635–661, 2011.
- [20] R. Cerf and M. Théret. Maximal stream and minimal cutset for first passage percolation through a domain of \mathbb{R}^d . *Ann. Probab.*, 42(3):1054–1120, 2012.
- [21] J. Cheeger. A lower bound for the smallest eigenvalue of the Laplacian. In *Proceedings of the Princeton conference in honor of Professor S. Bochner*, pages 195–199. Princeton Univ. Press, Princeton, N. J., 1970.
- [22] F. R. K. Chung. *Spectral graph theory*, volume 92 of *CBMS Regional Conference Series in Mathematics*. Conference Board of the Mathematical Sciences, Washington, DC, 1997.
- [23] J. T. Cox and R. Durrett. Some limit theorems for percolation processes with necessary and sufficient conditions. *Ann. Probab.*, 9(4):583–603, 1981.
- [24] J.-D. Deuschel and Á. Pisztora. Surface order large deviations for high-density percolation. *Probab. Theory Related Fields*, 104(4):467–482, 1996.
- [25] R. L. Dobrushin, R. Kotecký, and S. Shlosman. *Wulff construction: a global shape from local interaction*, volume 104. American Mathematical Society Providence, Rhode Island, 1992.
- [26] R. L. Dobrushin, R. Kotecký, and S. Shlosman. A microscopic justification of the Wulff construction. *J. Statist. Phys.*, 72(1-2):1–14, 1993.
- [27] R. Durrett and R. H. Schonmann. Large deviations for the contact process and two-dimensional percolation. *Probab. Theory Related Fields*, 77(4):583–603, 1988.
- [28] A. Figalli, F. Maggi, and A. Pratelli. A mass transportation approach to quantitative isoperimetric inequalities. *Inventiones mathematicae*, 182(1):167–211, 2010.
- [29] A. Gandolfi. *Clustering and uniqueness in mathematical models of percolation phenomena*. PhD thesis, Technische Universiteit Delft, 1989.
- [30] O. Garet. Capacitive flows on a 2d random net. *Ann. Appl. Probab.*, 19(2):641–660, 2009.
- [31] O. Garet, R. Marchand, E. B. Procaccia, and M. Théret. Continuity of the time and isoperimetric constants in supercritical percolation. *arXiv:1512.00742*.
- [32] J. W. Gibbs. On the equilibrium of heterogeneous substances. *American Journal of Science*, (96):441–458, 1878.
- [33] J. Gold. Intrinsic isoperimetry of the giant component of supercritical bond percolation in dimension two. *arXiv:1611.00351*.
- [34] G. Grimmett. *Percolation*, volume 321 of *Grundlehren der Mathematischen Wissenschaften [Fundamental Principles of Mathematical Sciences]*. Springer-Verlag, Berlin, second edition, 1999.

- [35] G. Grimmett and H. Kesten. First-passage percolation, network flows and electrical resistances. *Zeitschrift für Wahrscheinlichkeitstheorie und verwandte Gebiete*, 66(3):335–366, 1984.
- [36] G. R. Grimmett and J. M. Marstrand. The supercritical phase of percolation is well behaved. *Proc. Roy. Soc. London Ser. A*, 430(1879):439–457, 1990.
- [37] D. Ioffe. Exact large deviation bounds up to T_c for the Ising model in two dimensions. *Probab. Theory Related Fields*, 102(3):313–330, 1995.
- [38] D. Ioffe and R. H. Schonmann. Dobrushin–Kotecký–Shlosman theorem up to the critical temperature. *Comm. Math. Phys.*, 199(1):117–167, 1998.
- [39] H. Kesten. *Aspects of first passage percolation*. Lecture Notes in Mathematics, vol. 1180, Springer-Verlag, Berlin, 1986.
- [40] H. Kesten. Surfaces with minimal random weights and maximal flows: a higher-dimensional version of first-passage percolation. *Illinois J. Math.*, 31(1):99–166, 1987.
- [41] H. Kesten and Y. Zhang. The probability of a large finite cluster in supercritical Bernoulli percolation. *Ann. Probab.*, 18(2):537–555, 1990.
- [42] T. M. Liggett, R. H. Schonmann, and A. M. Stacey. Domination by product measures. *Ann. Probab.*, 25(1):71–95, 1997.
- [43] P. Mathieu and E. Remy. Isoperimetry and heat kernel decay on percolation clusters. *Ann. Probab.*, 32(1A):100–128, 2004.
- [44] R. A. Minlos and J. G. Sinaĭ. The phenomenon of “separation of phases” at low temperatures in certain lattice models of a gas. I. *Mat. Sb.*, 73(115):375–448, 1967.
- [45] R. A. Minlos and J. G. Sinaĭ. The phenomenon of “separation of phases” at low temperatures in certain lattice models of a gas. II. *Tr. Mosk. Mat. Obs.*, 19:113–178, 1968.
- [46] B. Morris and Y. Peres. Evolving sets, mixing and heat kernel bounds. *Probab. Theory Related Fields*, 133(2):245–266, 2005.
- [47] G. Pete. A note on percolation on \mathbb{Z}^d : isoperimetric profile via exponential cluster repulsion. *Electron. Commun. Probab.*, 13:377–392, 2008.
- [48] C.-E. Pfister and Y. Velenik. Large deviations and continuum limit in the 2d Ising model. *Probab. Theory Related Fields*, 109(4):435–506, 1997.
- [49] C.-E. Pfister and Y. A. Velenik. Mathematical theory of the wetting phenomenon in the 2d Ising model. *Helv. Phys. Acta*, 69:949–973, 1996.
- [50] A. Pisztor. Surface order large deviations for Ising, Potts and percolation models. *Probab. Theory Related Fields*, 104(4):427–466, 1996.
- [51] E. B. Procaccia and R. Rosenthal. Concentration estimates for the isoperimetric constant of the supercritical percolation cluster. *Electron. Commun. Probab.*, 17(30):1–11, 2012.
- [52] C. Rau. Sur le nombre de points visités par une marche aléatoire sur un amas infini de percolation. *Bull. Soc. Math. France*, 135(1):135–169, 2007.
- [53] R. Rossignol and M. Théret. Law of large numbers for the maximal flow through tilted cylinders in two-dimensional first passage percolation. *Stochastic Process. Appl.*, 120(6):873–900, 2010.
- [54] R. Rossignol and M. Théret. Lower large deviations and laws of large numbers for maximal flows through a box in first passage percolation. *Ann. Inst. Henri Poincaré Probab. Stat.*, 46(4):1093–1131, 2010.
- [55] J. M. Steele and Y. Zhang. Nondifferentiability of the time constants of first-passage percolation. *Ann. Probab.*, 31(2):1028–1051, 2003.
- [56] M. Talagrand. Concentration of measure and isoperimetric inequalities in product spaces. *Inst. Hautes Études Sci. Publ. Math.*, 81(1):73–205, 1995.
- [57] J. E. Taylor. Existence and structure of solutions to a class of nonelliptic variational problems. *Sympos. Math.*, 14(4):499–508, 1974.
- [58] J. E. Taylor. Unique structure of solutions to a class of nonelliptic variational problems. *Proc. Sympos. Pure Math.*, 27:419–427, 1975.
- [59] J. E. Taylor. Crystalline variational problems. *Bull. Amer. Math. Soc.*, 84(4):568–588, 1978.
- [60] M. Theret. Upper large deviations for maximal flows through a tilted cylinder. *ESAIM Probab. Statist.*, 18:117–129, 2014.
- [61] Á. Timár. Boundary-connectivity via graph theory. *Proc. Amer. Math. Soc.*, 141(2):475–480, 2013.

- [62] W. Winterbottom. Equilibrium shape of a small particle in contact with a foreign substrate. *Acta Metallurgica*, 15(2):303–310, 1967.
- [63] G. Wulff. Zur frage der geschwindigkeit des wachstums und der auflösung der kristallflächen. *Z. Kryst. Miner*, 34:449–530, 1901.
- [64] Y. Zhang. Limit theorems for maximum flows on a lattice. *arXiv: 0710.4589*.