

## FINITE ORDER CORKS

MOTOO TANGE

ABSTRACT. We show that for any positive integer  $m$ , there exist order  $n$  Stein corks  $(C_{n,m}, \tau_{n,m}^C)$ . The boundaries are cyclic branched covers of slice knots embedded in the boundary of a cork. By applying these corks to generalized forms, we give a method producing examples of many finite order corks, which are possibly not Stein cork. The examples of the Stein corks give  $n$  homotopic and contactomorphic but non-isotopic Stein filling contact structures for any  $n$ .

## 1. INTRODUCTION

1.1. **4-manifold and cork.** If two smooth manifolds  $X_1$  and  $X_2$  are homeomorphic but non-diffeomorphic, then we say that  $X_1$  and  $X_2$  are *exotic*. Let  $X$  be a smooth manifold and  $Y$  a codimension 0 submanifold in  $X$ . We denote the cut-and-paste  $(X - Y) \cup_\phi Z$  by  $X(Y, \phi, Z)$ . In the case of  $Y = Z$ , we denote such a surgery by  $X(Y, \phi)$  and say it a *twist*. For simply-connected closed exotic 4-manifolds the following theorem is well-known.

**Theorem 1.1** ([5],[10],[2]). *For any simply-connected closed exotic 4-manifolds  $X_1, X_2$ , there exist a contractible Stein manifold  $\mathcal{C}$ , an embedding  $\mathcal{C} \hookrightarrow X_1$ , and a self-diffeomorphism  $t : \partial\mathcal{C} \rightarrow \partial\mathcal{C}$  with  $t^2 = id$  such that*

$$X_1(\mathcal{C}, t) = X_2.$$

This theorem says that a pair of a contractible Stein manifold and a self-diffeomorphism of the boundary causes “exoticity” of simply-connected closed smooth 4-manifolds. Studying corks is important for understanding the exotic phenomenon of 4-manifolds. We give a definition of cork in a generalized form.

**Definition 1.2** (Cork). *Let  $\mathcal{C}$  be a contractible 4-manifold and  $t$  a self-diffeomorphism  $\partial\mathcal{C} \rightarrow \partial\mathcal{C}$  on the boundary. If  $t$  cannot extend to a map  $\mathcal{C} \rightarrow \mathcal{C}$  as a diffeomorphism, then  $(\mathcal{C}, t)$  is called a cork.*

*For a pair of exotic two 4-manifolds  $X_1, X_2$  and a smooth embedding  $\mathcal{C} \hookrightarrow X_1$ , if  $X_1(\mathcal{C}, t) = X_2$ , then  $(\mathcal{C}, t)$  is called a cork for  $X_1, X_2$ . We call the deformation  $X_1 \rightarrow X_1(\mathcal{C}, t)$  a cork twist.*

---

*Date:* November 27, 2024.

*1991 Mathematics Subject Classification.* 57R55, 57R65.

*Key words and phrases.* Stein manifold, finite order cork, exotic 4-manifold.

The author was partially supported by JSPS KAKENHI Grant Number 26800031.

Note that this definition of cork are weaker than that of the usual one in terms of the following two points. The definition here does not assume that  $\mathcal{C}$  is Stein and  $t$  satisfies  $t^2 = \text{id}$ . If the 4-manifold  $\mathcal{C}$  of a cork  $(\mathcal{C}, t)$  is Stein, then  $(\mathcal{C}, t)$  is called a *Stein cork*.

1.2. **Order  $n$  cork.** We define order  $n$  cork.

**Definition 1.3** (Order  $n$  cork). *Let  $(\mathcal{C}, t)$  be a cork. If the following conditions are satisfied, then we call  $(\mathcal{C}, t)$  an order  $n$  cork:*

- (1) *the composition  $t \circ t \circ \cdots \circ t = t^i$  ( $0 < i < n$ ) cannot extend to any diffeomorphism  $\mathcal{C} \rightarrow \mathcal{C}$ .*
- (2)  *$t^n$  can extend to a diffeomorphism  $\mathcal{C} \rightarrow \mathcal{C}$ .*

*This number  $n$  is called the order of the cork  $(\mathcal{C}, t)$ .*

*Let  $\mathbb{X}$  be a pair of  $n$  mutually exotic 4-manifolds  $\{X = X_0, \dots, X_{n-1}\}$ . If there exists an embedding  $\mathcal{C} \hookrightarrow X$  such that  $X_i = X(\mathcal{C}, t^i)$ , then  $(\mathcal{C}, t)$  is called a cork for this collection  $\mathbb{X}$ .*

The existence of finite order corks has been not known except for order 2.

1.3. **Aims.** Let  $\mathcal{C}$  be a contractible 4-manifold. One of our aims of this article is to construct infinite families of order  $n$  corks for each  $n > 1$ . Another aim is to give a technique to show that the map  $t$  for a twist  $(\mathcal{C}, t)$  cannot extend to inside  $\mathcal{C}$  as a diffeomorphism, i.e,  $(\mathcal{C}, t)$  is a cork.

Freedman's result [6] says that the diffeomorphism on  $\partial\mathcal{C}$  extend to a *self-homeomorphism* on  $\mathcal{C}$ .

Infinite order corks are not known so far.

1.4. **Results.** Let  $(C(m), \tau(m))$  be a pair defined as the handle diagram as in FIGURE 1 and the diffeomorphism  $\tau(m)$  is order 2. In the case of

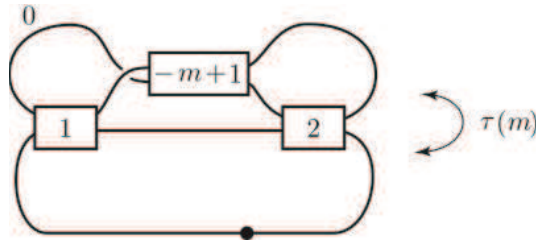
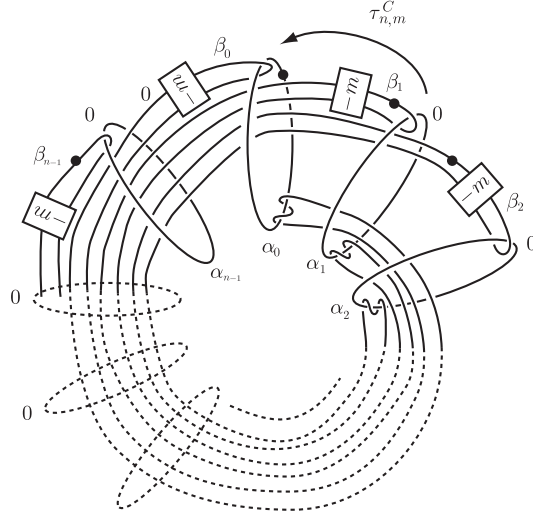
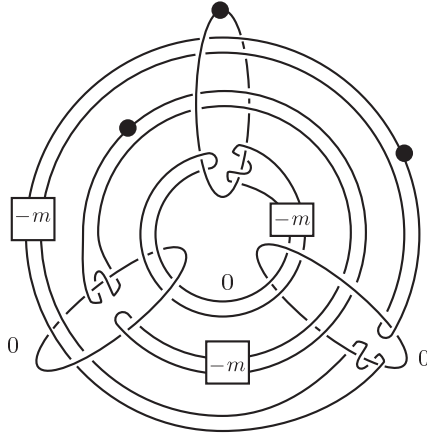

FIGURE 1. Corks  $(C(m), \tau(m))$ .

$m = 1$ ,  $(C(1), \tau(1))$  is the Akbulut cork in [4].  $(C(m), \tau(m))$  is an example of an order 2 Stein cork (Proposition 3.1). By positioning several copies of the attaching spheres of this cork on the boundary of the 0-handle, we give examples of finite corks. One of the main theorems is the following.

**Theorem 1.4.** *Let  $n, m$  be integers with  $n > 1$  and  $m > 0$ . There exists an order  $n$  cork  $(C_{n,m}, \tau_{n,m}^C)$ . The handle decomposition and the map  $\tau_{n,m}^C$  are described in FIGURE 2. Furthermore,  $C_{n,m}$  is an order  $n$  Stein cork.*

FIGURE 2. The handle decomposition of  $C_{n,m}$ .FIGURE 3. The handle decomposition of  $C_{3,m}$  after an isotopy.

The number  $-m$  in any box stands for a  $-m$  full twist.

We will define other variations  $D_{n,m}$  and  $E_{n,m}$  in Section 2.5. Here we give rough definitions of them.  $D_{n,m}$  is obtained by the exchange of all dots and 0s of  $C_{n,m}$ .  $E_{n,m}$  is a 4-manifold modified as in FIGURE 5 of  $C_{n,m}$ . The case of  $n = 3$  is described as in FIGURE 6. The diffeomorphisms  $\tau_{n,m}^D$  and  $\tau_{n,m}^E$  are the rotations by angle  $2\pi/n$  in the same way as  $\tau_{n,m}^C$ .

The reason why we treat these examples is to show the existence of many corks *without the direct aid of Stein structure*. In other words, even when we do not know whether  $D_{n,m}$  and  $E_{n,m}$  are Stein manifolds, our technique can show that  $\tau_{n,m}^D$  and  $\tau_{n,m}^E$  cannot extend to inside  $D_{n,m}$  and  $E_{n,m}$  as diffeomorphisms respectively. Here, as examples, we state the second and

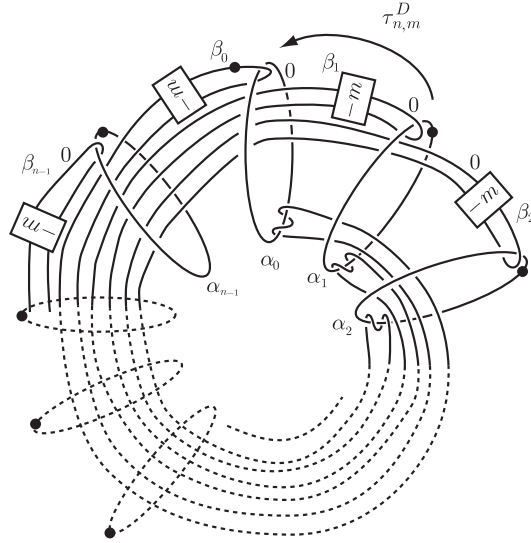
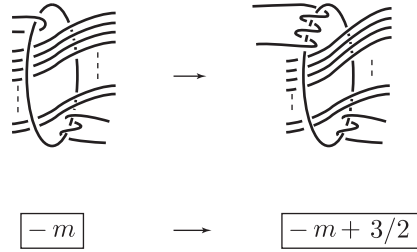
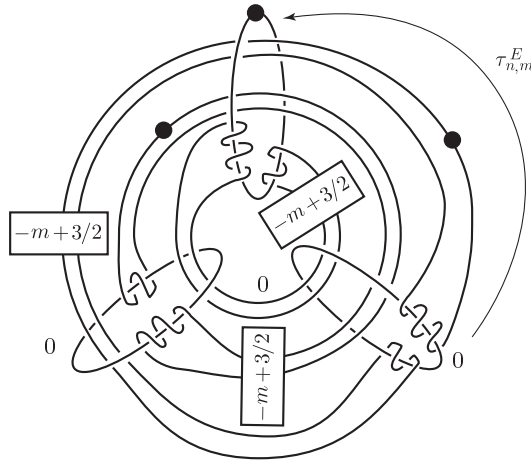
FIGURE 4. The handle decomposition of  $D_{n,m}$ .FIGURE 5. A modification of  $C_{n,m}$  into  $E_{n,m}$ .FIGURE 6. Handle decomposition of  $E_{3,m}$  and a diffeomorphism  $\tau_{n,m}^E$ .

third main theorems in the form including technical statements.

**Theorem 1.5** (Cork-ness of  $(D_{n,m}, \tau_{n,m}^D)$ ). *Let  $n$  be an integer with  $n > 2$ . Then there exists an embedding  $D_{n,m} \subset D_{2,m}$  such that for the embedding, there exists a diffeomorphism  $\psi : D_{2,m} \rightarrow D_{2,m}(D_{n,m}, \tau_{n,m}^D)$  such that the diffeomorphism induces  $\tau_{2,m}^D$  on the boundaries.*

*In particular,  $(D_{n,m}, \tau_{n,m}^D)$  is an order  $n$  cork.*

Note that the first statement does not mean the induced diffeomorphism  $\partial D_{2,m} \rightarrow \partial D_{2,m}$  can extend to inside a diffeomorphism. The induced map is the restriction of a rotation of  $D_{2,m} - D_{n,m}$  of  $\psi$  to the one component of the boundary.

**Theorem 1.6** (Cork-ness of  $(E_{n,m}, \tau_{n,m}^E)$ ). *For a positive integers  $n, m$  there exists a sufficient large integer  $l$  and an embedding  $E_{n,m} \hookrightarrow V_{l,n} := E(l) \# n \overline{\mathbb{C}P^2}$  such that for any  $0 < i < n$  the twist  $V_{l,n}(E_{n,m}, (\tau_{n,m}^E)^i)$  is diffeomorphic to  $(2l - 1)\mathbb{C}P^2 \# (10l + n - 1)\overline{\mathbb{C}P^2}$ .*

*In particular,  $E_{n,m}$  is an order  $n$  cork.*

The integer  $l$  in this theorem is independent of  $m$ . The point is that all the nontrivial twists  $(E_{n,m}, (\tau_{n,m}^E)^i)$  for an embedding  $E_{n,m} \hookrightarrow V_{l,n}$  produces exotic structures. Whether there exists a finite order cork for the collection of mutually exotic 4-manifolds is not known yet.

**1.5. More exotic 4-manifolds.** In Section 3.3, we give a 4-manifold  $W_{n,m}$  and embedding  $C_{n,m} \hookrightarrow W_{n,m}$ . The cork twist is a candidate of the collection of mutually exotic 4-manifolds.

**Proposition 1.7.** *Let  $i$  be an integer with  $0 < i \leq n - 1$ . There exists a simply-connected non-spin 4-manifold  $W_{n,m,i}$  with  $b_2 = b^- = n(n - 1)/2$  and a homology sphere boundary. The manifold  $W_{n,m,i}$  is obtained by an order  $n$  cork twist of a Stein manifold  $W_{n,m}$ . Each  $W_{n,m,i}$  is the  $i$  times blow-ups of a 4-manifold  $W'_{n,m,i}$  and is exotic to  $W_{n,m}$ .*

We do not know whether  $W'_{n,m,i}$  is a minimal 4-manifold.

**Remark 1.8.** *In the definition of order  $n$  cork in [12], we imposed the condition that the order of  $t$  is  $n$ . Here we slightly change it to the weaker condition (2) in Definition 1.3.*

This remark says that the order of  $t$  as a map is “not” necessary to be the same as the order of cork. In the last section we will illustrate an example having the difference.

**Proposition 1.9.** *Let  $(F, \kappa)$  be a pair of a 4-manifold and diffeomorphism as in FIGURE 21. The map  $\kappa$  on  $\partial F$  has order 2 as a cork, however it is an order 4 as a diffeomorphism.*

**1.6. An action on Heegaard Floer homology.** S. Akbulut and C. Karakurt in [1] showed that the twist map  $t$  of an order 2 Stein cork  $(\mathcal{C}, t)$  consisting of a symmetric diagram consisting of a dotted 1-handle and a 0-framed 2-handle induces an action on the Heegaard Floer homology  $HF^+(\partial\mathcal{C})$  non-trivially as an involution. We show that an order  $n$  Stein cork  $(C_{n,m}, \tau_{n,m}^C)$  also induces an order  $n$  map on Heegaard Floer homology  $HF^+(\partial C_{n,m})$ .

**Theorem 1.10.** *Let  $n, m$  be positive integers with  $n > 1$ . The maps  $\{(\tau_{n,m}^C)^i \mid i = 0, \dots, n-1\}$ , which is isomorphic to  $\mathbb{Z}/n\mathbb{Z}$ , act effectively on the Heegaard Floer homology  $HF^+(\partial C_{n,m})$ .*

An action of a group  $G$  on a set  $S$  is called *effective*, if for any  $e \neq g \in G$  there exists an element  $x \in S$  such that  $g \cdot x \neq x$ . From this theorem, we immediately the following proposition.

**Proposition 1.11.** *There exist  $n$  Stein filling contact structures on  $\partial C_{n,m}$  such that they are homotopic and contactomorphic but non-isotopic each other.*

#### ACKNOWLEDGEMENTS

This topic was come upon by the author while speaking with Masatsuna Tsuchiya on November in 2014. I thank him for arguing with me. I gave a talk about finite order corks in the Handle friendship seminar in Tokyo Institute of Technology and also thank the audience for giving the helpful comments. I also thank Kouichi Yasui and Tetsuya Abe for giving me useful comments in the earlier version.

#### 2. A 4-MANIFOLD $X_{n,m}(\mathbf{x})$ FOR A $\{*, 0\}$ -SEQUENCE.

**2.1. Extendability of a composite boundary diffeomorphism.** We defined the order of cork in Section 1. The definition is slightly different from that defined in [12] as mentioned in Section 1.5. To note the well-definedness of the order of cork, we show the following fundamental lemma.

**Lemma 2.1.** *Let  $X$  be a manifold and  $\varphi, \psi$  boundary self-diffeomorphisms  $\partial X \rightarrow \partial X$ . If  $\varphi, \psi$  extend to inside  $X \rightarrow X$  as a diffeomorphism, then so does  $\varphi \circ \psi$ .*

**Proof.** We attach the cylinder  $\partial X \times I$  to  $X$  by using  $\varphi : \partial X \times \{1\} \rightarrow \partial X$ . The extendability problem of  $(X, \varphi \circ \psi)$  is equivalent to that for a pair  $(X \cup_\varphi (\partial X \times I), \psi)$ , where  $\psi$  induces a map  $\psi : \partial X \times \{1\} \rightarrow \partial X \times \{1\}$ . Since  $\varphi : \partial X \rightarrow \partial X$  extends to inside, by an identification  $X \rightarrow \varphi(X)$ ,  $X \cup_\varphi (\partial X \times I)$  is diffeomorphic to  $X$  with the boundary point-wise fixed. The problem is reduced to the extendability problem of  $\psi : \partial X \rightarrow \partial X$ . From the assumption, therefore,  $\psi \circ \varphi$  extends to inside.  $\square$

From this lemma if a self-diffeomorphism  $\varphi$  on the boundary of a manifold extends to inside as a diffeomorphism, then so does  $\varphi^n$ .

**2.2. Constructions of  $X_{n,m}(\mathbf{x})$ .** Let  $m$  be a positive integer and  $n$  an integer with  $n > 0$ . Let  $L_{n,m}$  denote  $2n$  components link (located like a wheel) as in the diagram in FIGURE 2. We denote the components by

$$L_{n,m} = \{\alpha_0, \alpha_1, \dots, \alpha_{n-1}, \beta_0, \beta_1, \dots, \beta_{n-1}\},$$

where the number  $-m$  in any box stands for a  $-m$  full twists. The  $n$ -components  $\{\alpha_i | i = 0, 1, \dots, n-1\}$  (here called them radial components) of them lie in the radial direction about the center of the rotation. The rest  $n$ -components  $\{\beta_i | i = 0, 1, \dots, n-1\}$  in  $L_{n,m}$  (here we call them circular components) are put in the form that makes a circuit from a radial component to the same component. The linking number between  $\alpha_i$  and  $\beta_i$  is one and other linking numbers between  $\alpha_i$  and  $\beta_j$  ( $i \neq j$ ) are all zero.

Let  $\mathbf{x} = (x_0, x_1, \dots, x_{n-1})$  be a  $\{*, 0\}$ -sequence with  $x_i = *$  or  $0$ . If  $x_i = *$ , then we describe a dot on the circle  $\alpha_i$  and  $0$  near the circle  $\beta_i$ . If  $x_i = 0$ , then we describe  $0$  near the circle  $\alpha_i$  and a dot on the circle  $\beta_i$ . According to this process, we get a framed link diagram.  $X_{n,m}(\mathbf{x})$  is defined to be a 4-manifold obtained by this framed link diagram.

From the construction, we have  $H_*(X_{n,m}(\mathbf{x}), \mathbb{Z}) \cong H_*(B^4, \mathbb{Z})$ , where  $B^4$  is the 4-ball. We note that  $X_{1,m}(\mathbf{x}) = X_{1,m}(0) = C(m)$  holds.

We can also construct  $X_{n,m}(\mathbf{x})$  in terms of branched cover of  $C(m)$ . The  $n$ -fold branched cover of  $C(m)$  along the slice disk of  $K_{n,m}$  as in FIGURE 7 is  $X_{n,m}(0, \dots, 0)$ . Doing several times cork twists  $(C(m), \tau(m))$  for  $\{\alpha_i, \beta_i\}$  with  $x_i = *$  in the sequence  $\mathbf{x}$ , we get  $X_{n,m}(\mathbf{x})$ .

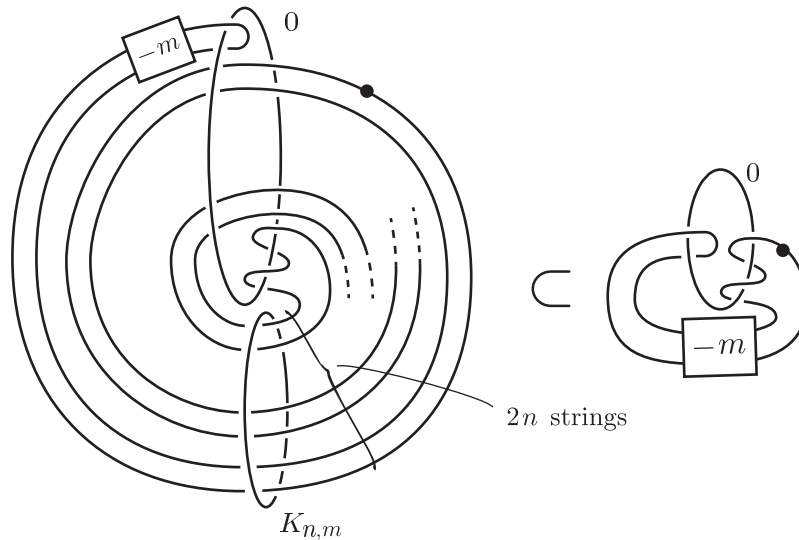

FIGURE 7. A slice knot  $K_{n,m}$  on  $\partial C(m)$ .

**Lemma 2.2.** *Let  $\mathbf{x}$  be any  $\{*, 0\}$ -sequence.  $X_{n,m}(\mathbf{x})$  is a contractible 4-manifold.*

**Proof.** We show  $X_{n,m}(\mathbf{x})$  is simply-connected. For  $0 \leq i \leq n-1$  exchanging  $x_i$  as  $* \rightarrow 0$  corresponds to a cork twist of  $C(m) = 0\text{-handle} \cup \{\alpha_i, \beta_i\}$ . Thus, this exchange does not change the fundamental group, i.e.,  $\pi_1(X_{n,m}(\cdots, *, \cdots)) \cong \pi_1(X_{n,m}(\cdots, 0, \cdots))$ .

We may show  $\pi_1(X_{n,m}(0, \cdots, 0))$  is trivial. Dotted circles in the diagram of  $X_{n,m}(0, \cdots, 0)$  have a separated position with each dotted circles. Since any  $\alpha_i$  does not link with  $\beta_j$  with  $i \neq j$ . The presentation of the fundamental group is the same as  $\pi_1(\natural C(m))$ . Thus, this group is the trivial group. This means  $\pi_1(X_{n,m}(\mathbf{x})) = e$  for any  $\{*, 0\}$ -sequence.

Thus  $X_{n,m}(\mathbf{x})$  is a contractible 4-manifold.  $\square$

**Definition 2.3** ( $C_{n,m}$ ,  $D_{n,m}$ , and  $F_{n,m}$ ). We define  $C_{n,m}$ ,  $D_{n,m}$  and  $F_{n,m}$  to be

$$C_{n,m} = X_{n,m}(*, 0, \cdots, 0),$$

$$D_{n,m} = X_{n,m}(0, *, \cdots, *),$$

and

$$F_{n,m} = X_{2n,m}(0, *, 0 * \cdots, 0, *).$$

See FIGURE 2 and 4 for  $C_{n,m}$  and  $D_{n,m}$  and see FIGURE 21 for  $F_{2,m}$ .

We show the following proposition.

**Proposition 2.4.** (1)  $C_{2,m} = D_{2,m}$  holds.

(2)  $C_{n,m}$ ,  $D_{n,m}$ ,  $E_{n,m}$  and  $F_{n,m}$  are contractible 4-manifolds.

**Proof.** (1) The handle decompositions of  $C_{2,m}$  and  $D_{2,m}$  are the same and the diffeomorphisms  $\tau_{2,m}^C$  and  $\tau_{2,m}^D$  are the exchange of dots and 0s.

(2) Lemma 2.2 says that  $C_{n,m}$ ,  $D_{n,m}$  and  $F_{n,m}$  are contractible. We can also show that  $E_{n,m}$  is contractible in the same way as Lemma 2.2.

**2.3. A diffeomorphism  $\tau_{n,m}^X$ .** Moving each component of  $L_{n,m}$  as

$$\alpha_i \rightarrow \alpha_{i-1}$$

and

$$\beta_i \rightarrow \beta_{i-1},$$

we get a diffeomorphism  $\tau_{n,m}^X : \partial X_{n,m}(\mathbf{x}) \rightarrow \partial X_{n,m}(\mathbf{x})$ . Here we consider the suffices as elements in  $\mathbb{Z}/n\mathbb{Z}$ . The diffeomorphism  $\tau_{n,m}^X$  when  $X = C, D$  is a rotation by angle  $2\pi/n$  as defined in Section 1.4.

**2.4. An isotopy.** We give an isotopy of  $L_{n,m}$  as described in FIGURE 8. First, we move  $\beta_0$  to the innermost position. Next, we move  $\beta_1$  to the second innermost position. In the same way as above we move all  $\beta_i$ . By using the isotopy, we can get a handle diagram presentation of  $X_{n,m}(\mathbf{x})$ . As a diagram after isotopy, see FIGURE 3.

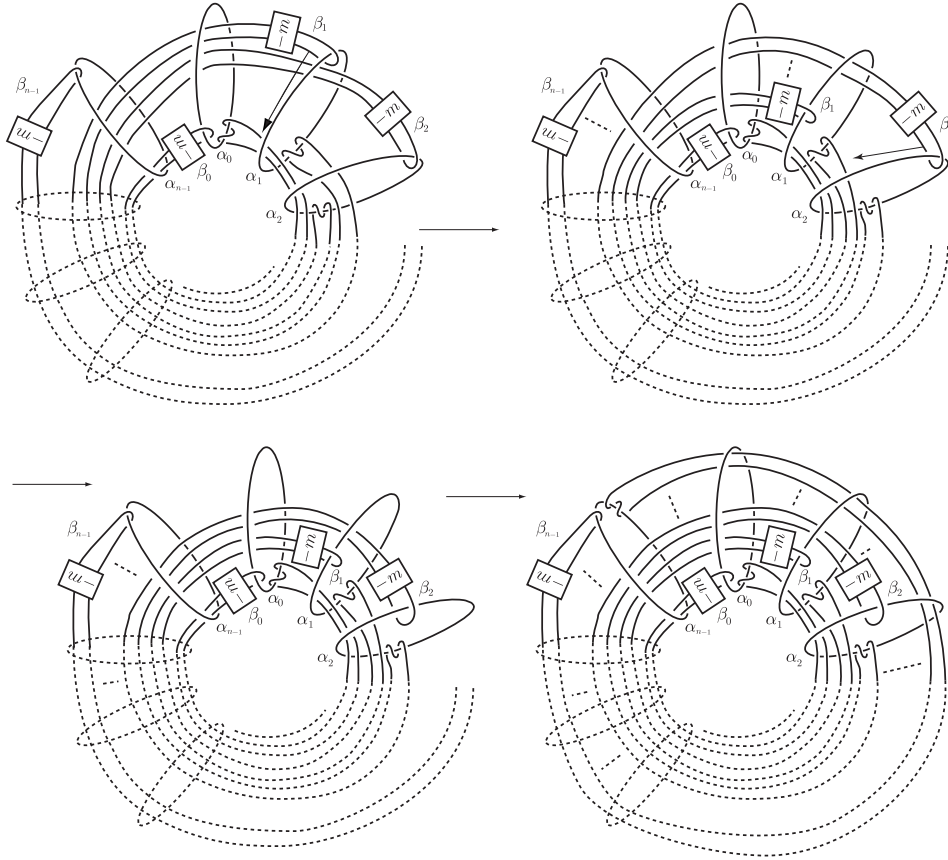

FIGURE 8. An isotopy of a handle diagram of  $C_{n,m}$ .

### 2.5. Another variation $E_{n,m}$ .

**Definition 2.5.** We define  $E_{n,m}$  to be the manifold obtained by the modification of  $C_{n,m}$  as in FIGURE 5.

The handle diagram for  $E_{3,m}$  after the same isotopy as above is FIGURE 6. In the same way as  $C_{n,m}$  or  $D_{n,m}$  each pair of a dotted 1-handle and 0-framed 2-handle with linking number 1 in  $E_{n,m}$  consists of the cork  $C(m)$  (see FIGURE 9).

## 3. PROOFS OF MAIN RESULTS

**3.1. The cork-ness of  $C_{n,m}$ .** Due to Gompf's result [7] in order to see that  $C(m)$  and  $C_{n,m}$  admit Stein structure, we may deform the handle diagrams of  $C(m)$  and  $C_{n,m}$  into Legendrian links with some Thurston-Bennequin condition. On the standard position of  $\#nS^2 \times S^1$  in [7], which is the boundary of the end sum  $\natural nD^3 \times S^1$ , we put Legendrian links with all framings  $tb - 1$ , where  $tb$  is the Thurston-Bennequin number of each Legendrian knot.

Here we show the following.

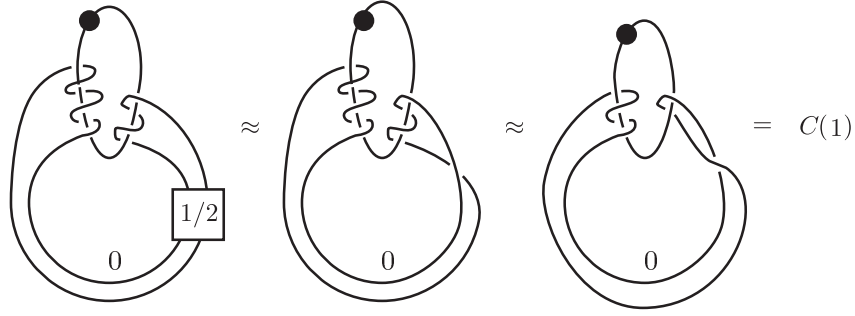

FIGURE 9. The Akbulut cork  $C(1)$  embedded in  $E_{n,1}$ .

**Proposition 3.1.**  $(C(m), \tau(m))$  is an order 2 Stein cork.

**Proof.** The Stein structure on  $C(m)$  is due to FIGURE 10. Here, the box with number  $-m + 1$  stands for a  $(-m + 1)$ -full twist with a Legendrian position as the second equation in FIGURE 11.  $\square$

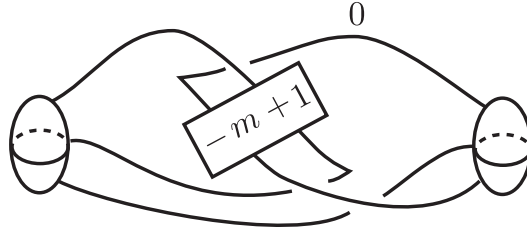

FIGURE 10. Stein structure on  $C(m)$ .

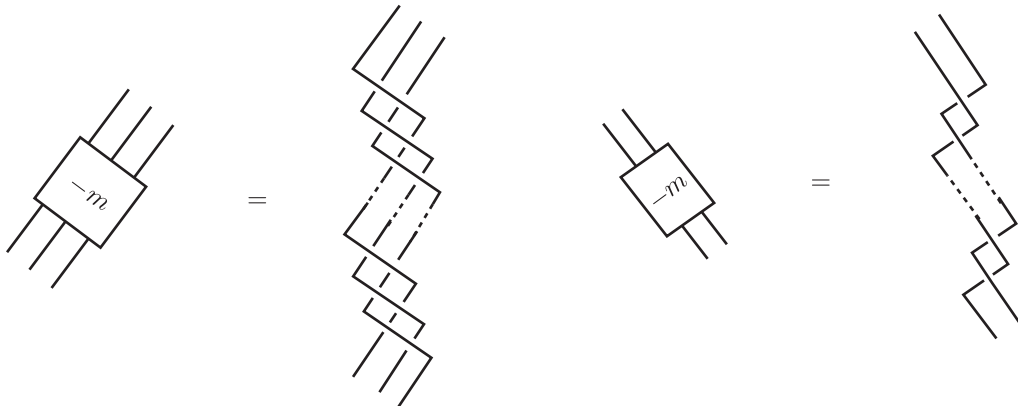

FIGURE 11. Legendrian positions of strings with negative twists.

We prove Theorem 1.4.

**Proof of Theorem 1.4.** We deform the handle diagram in FIGURE 3 as in

FIGURE 12. The last picture in FIGURE 12 can be easily changed by isotopy into a Legendrian link in the standard position of a connected sum of several copies of  $S^2 \times S^1$  as in FIGURE 13. For the case of  $n = 4$ , the handle diagram is FIGURE 14.

We show that for any integer  $i$  with  $1 \leq i \leq n - 1$ ,  $(\tau_{n,m}^C)^i$  cannot extend to inside  $C_{n,m}$ . One attaches a  $-1$ -framed 2-handle  $h$  to the meridian of  $\beta_{n-i}$  in  $C_{n,m}$ . The resulting 4-manifold

$$Z_{n-i} = C_{n,m} \cup_{\beta_{n-i}} h$$

is a Stein 4-manifold. However the attaching sphere of the corresponding  $\beta_{n-i}$  in  $Z_{n-i}(C_{n,m}, (\tau_{n,m}^C)^i)$  is a meridian of the 0-framed 2-handle. Thus we can construct an embedded sphere with self-intersection number  $-1$  by taking the union of the core disk of  $h$  and compressing disk of the meridian in  $\partial C_{n,m}$ . On the other hand, in any Stein 4-manifold, there never exist any embedded  $-1$ -sphere, for example see [3]. Thus  $Z_{n-i}(C_{n,m}, (\tau_{n,m}^C)^i)$  never admit any Stein structure, hence  $Z_{n-i}$  and  $Z_{n-i}(C_{n,m}, (\tau_{n,m}^C)^i)$  are exotic 4-manifolds. This implies  $(\tau_{n,m}^C)^i$  cannot extend to inside  $C_{n,m}$ . Since  $(\tau_{n,m}^C)^n = \text{id}$ , clearly  $(\tau_{n,m}^C)^n$  can extend to a diffeomorphism on  $C_{n,m}$ . Therefore  $(C_{n,m}, \tau_{n,m}^C)$  is an order  $n$  cork.  $\square$

The following Lemma 3.2 and Corollary 3.5 are key lemma and corollary for the results on cork in this article.

**Lemma 3.2.** *Let  $\mathbf{x}$  be a  $\{*, 0\}$ -sequence with  $\mathbf{x} \neq (*, *, \dots, *)$ ,  $(0, 0, \dots, 0)$ . Then the twist  $(X_{n,m}(\mathbf{x}), \tau_{n,m}^X)$  is a cork twist.*

**Proof.** By permuting  $\mathbf{x}$  as  $(x_0, x_1, \dots, x_{n-1}) \mapsto (x_1, \dots, x_{n-1}, x_0)$  in several times, we may assume that the sequence is  $\mathbf{x} = (*, 0, x_2, \dots, x_{n-1})$ .

For  $2 \leq i \leq n - 1$  if  $x_i = *$ , then attaching a 0-framed 2-handle to the meridian of  $\alpha_i$  in  $X_{n,m}(\mathbf{x})$  and canceling with  $\alpha_i$ , we can make a separated 0-framed 2-handle in the diagram of  $X_{n,m}(\mathbf{x}) \cup 2$ -handle. Canceling the 0-framed 2-handle with a 3-handle, we get  $X_{n,m}(\mathbf{x}) \cup 2$ -handle  $\cup$  3-handle =  $X_{n-1,m}(\mathbf{x}')$ , where  $\mathbf{x}'$  is  $(*, 0, x_2, \dots, \hat{x}_i, \dots, x_{n-1})$ . The hat means deleting of the component. This handle attachment means  $X_{n,m}(\mathbf{x}) \subset X_{n-1,m}(\mathbf{x}')$ . The cobordism between  $\partial X_{n,m}(\mathbf{x})$  and  $\partial X_{n-1,m}(\mathbf{x}')$  is a homology cobordism. Iterating this process, we have  $X_{n,m}(\mathbf{x}) \subset X_{n',m}(*, 0, 0, \dots, 0)$ .

For  $2 \leq i \leq n' - 1$  if  $x_i = 0$ , then attaching a 2-handle to the meridian of  $\alpha_i$  in  $X_{n',m}(*, 0, \dots, 0)$ , we can move  $\alpha_i$  to the position in the first picture in FIGURE 15. By doing the handle slide along the arrow in the picture, we get the second picture. By sliding some components to the meridional 0-framed 2-handle, the components  $\{\alpha_i, \beta_i\}$  with the 0-framed 2-handle is separated as in FIGURE 15. Canceling the 0-framed 2-handle with a 3-handle, we get  $X_{n'-1,m}(*, 0, \dots, 0)$ . Iterating such a canceling, we get  $X_{2,m}(*, 0)$ . Thus, we get an embedding

$$X_{n,m}(\mathbf{x}) \subset X_{2,m}(*, 0) \subset X_{1,m}(*, 0) = C(m).$$

Let  $\tau_{n,m}^X$  be the  $2\pi/n$  rotation as in FIGURE 2. The twist  $C(m)(X_{n,m}(\mathbf{x}), \tau_{n,m}^X)$  is diffeomorphic to  $C(m)$ , and by the twist, the diffeomorphism on the

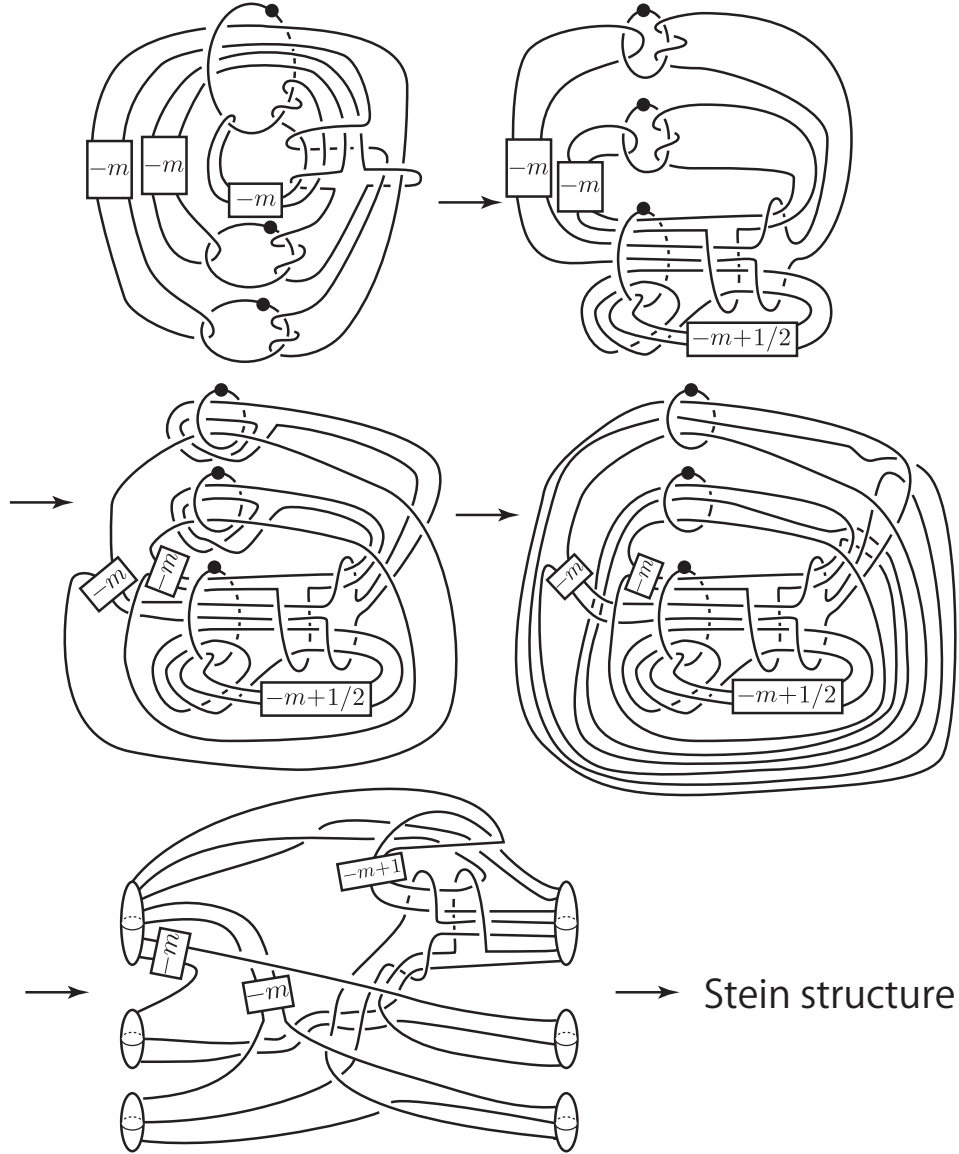
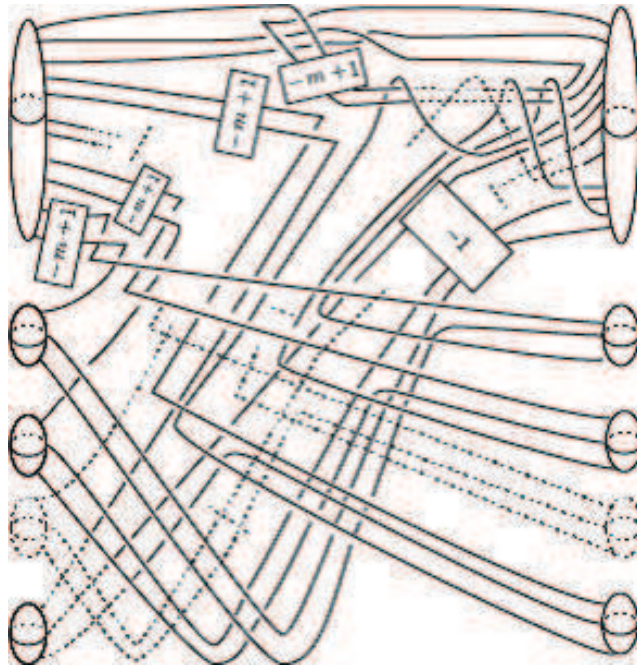
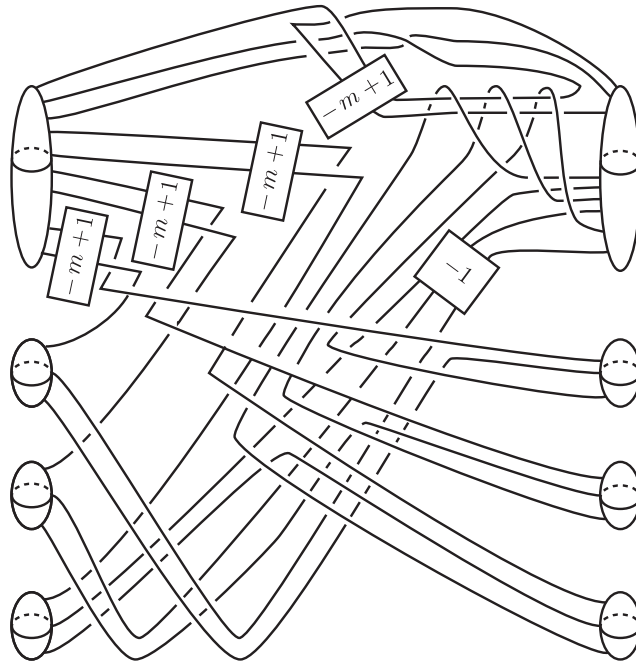

FIGURE 12. The isotopy of  $C_{3,1}$  to the Stein structure.

boundary is mapped in the same way as  $\tau(m)$ . If  $\tau_{n,m}^X$  extends to a self-diffeomorphism on inside  $X_{n,m}$ , then  $\tau(m)$  can extend to inside  $C(m)$ . This is a contradiction to Proposition 3.1. Therefore,  $(X_{n,m}(\mathbf{x}), \tau_{n,m}^X)$  is a cork.  $\square$

Note that these cobordisms give homology cobordisms.

**Definition 3.3** (Shifting). *Let  $\mathbf{x}$  be a  $\{*, 0\}$ -sequence. If  $S_i$  is a cyclic map acting on  $\{*, 0\}$ -sequences as  $\mathbf{x} = (x_0, x_1, \dots, x_{n-1}) \mapsto (x_{-i}, x_{-i+1}, \dots, x_{-i-1})$ ,*

FIGURE 13. A Stein structure of  $C_{n,m}$ .FIGURE 14. A Stein structure of  $C_{4,m}$ .

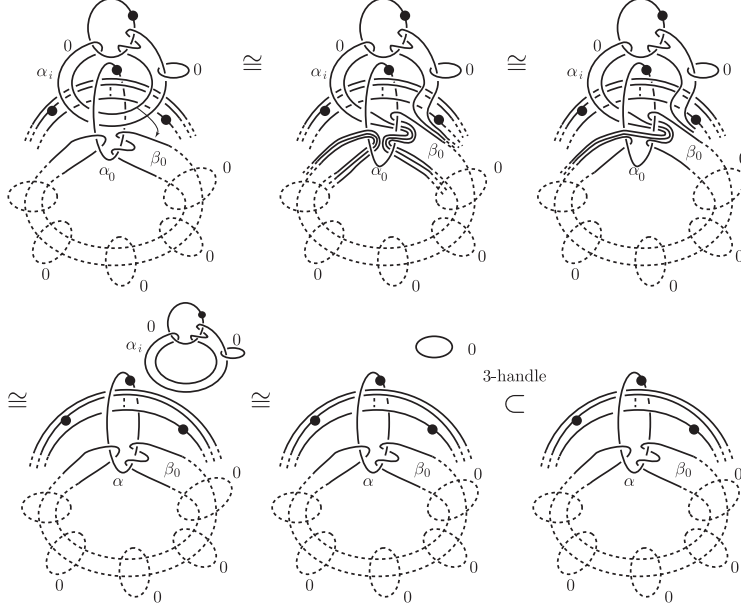
FIGURE 15.  $X_{n,m}(*, 0, \dots, 0)$  with 0-framed 2-handle.

we call  $S_i$  a shifting map on the sequence. Here we consider the suffices as  $\mathbb{Z}/n\mathbb{Z}$ .

**Definition 3.4** (Period). Let  $\mathbf{x} = (x_0, x_1, \dots, x_{n-1})$  be a  $\{*, 0\}$ -sequence. We call

$$\min\{p \mid S_p(\mathbf{x}) = \mathbf{x}, p > 0\}$$

the period of  $\mathbf{x}$ .

From the definition, the period is a divisor of  $n$ .

**Corollary 3.5.** Let  $\mathbf{x}$  be a  $\{*, 0\}$ -sequence with period  $N > 1$ . Then  $(X_{n,m}(\mathbf{x}), \tau_{n,m}^X)$  is an order  $N$  cork.

**Proof.** For any integer  $0 < i < N$ , there exists  $j$  such that  $S_i(x_j) \neq x_{j-i}$ . If there does not exist such  $j$ , then the period of  $\mathbf{x}$  is less than or equal to  $i$ . This is contradiction. Canceling all handles but  $\alpha_{j-i}$  and  $\beta_{j-i}$  as in the proof in Lemma 3.2, we have an embedding:

$$X_{n,m}(\mathbf{x}) \subset X_{1,m}(x_{j-i}) = C(1).$$

By the shifting map  $S_i$  the self-diffeomorphism  $(\tau_{n,m}^X)^i$  exchanges the dotted 1-handle and 0-framed 2-handle on  $\{\alpha_{j-i}, \beta_{j-i}\}$ , where  $\tau_{n,m}^X$  is the  $2\pi/n$  rotation, since  $S_i(x_j) \neq x_{j-i}$ .

This twist  $C(1)(X_{n,m}, (\tau_{n,m}^X)^i)$  for the embedding gives the effect  $(C(1), \tau(m))$ . By the same argument as the proof of Lemma 3.2,  $(X_{n,m}(\mathbf{x}), (\tau_{n,m}^X)^i)$  cannot extend to inside  $X_{n,m}(\mathbf{x})$  as a diffeomorphism.

Since shifting map  $S_N$  does not change  $\mathbf{x}$ , the diffeomorphism  $(\tau_{n,m}^X)^N$  can extend to  $X_{n,m}(\mathbf{x})$ . As a result,  $(X_{n,m}(\mathbf{x}), \tau_{n,m})$  is an order  $N$  cork.  $\square$

**3.2. Cork twist for embeddings relationship in  $\{C_{n,m}\}$ .** Let  $k, n, m$  be positive integers. There exist embeddings  $C_{n,m} \subset C_{n+k,m}$ , and  $C_{n+k,m} \subset C_{n,m}$  according to Lemma 3.2.

**Corollary 3.6** (Cork twist of  $C_{n,m}$ ). *Let  $n$  be a positive integer. The cork twist  $C_{n,m}(C_{2,m}, \tau_{2,m}^C)$  for the first embedding above gives a diffeomorphism  $\varphi : C_{n,m} \rightarrow C_{n,m}(C_{2,m}, \tau_{2,m}^C)$  and the boundary restriction  $\varphi|_{\partial} : \partial C_{n,m} \rightarrow \partial C_{n,m}$  coincides with  $\tau_{n,m}^C$ .*

**Proof.** This assertion follows immediately from Lemma 3.2 and the argument below.

Suppose that  $n > 2$ . The inserting map of  $\{*, 0\}$ -sequences

$$(*, 0) = (x_0, x_1) \mapsto (x_0, y, \dots, y, x_1),$$

where  $y = 0$  gives an embedding  $C_{2,m} \hookrightarrow C_{n,m}$ . Thus, the cork twist  $C_{n,m}(C_{2,m}, \tau_{2,m})$  give the effect

$$(x_0, y, \dots, y, x_1) \mapsto (x_1, y, \dots, y, x_0).$$

This deformation corresponds to the cork twist  $(C_{n,m}, \tau_{n,m}^C)$ .

Suppose that  $n = 1$ . The deleting map of  $\{*, 0\}$ -sequences

$$(*) \mapsto (0).$$

gives an embedding  $C_{2,m} \hookrightarrow C_{1,m}$ . Thus, the cork twist  $C_{1,m}(C_{2,m}, \tau_{2,m})$  give the effect  $(*, 0) \mapsto (*)$  This deformation corresponds to the cork twist  $(C(m), \tau(m))$ .

Suppose that  $n = 2$ . By taking the identity map  $C_{2,m} \rightarrow C_{2,m}$ , the statement is trivial.  $\square$

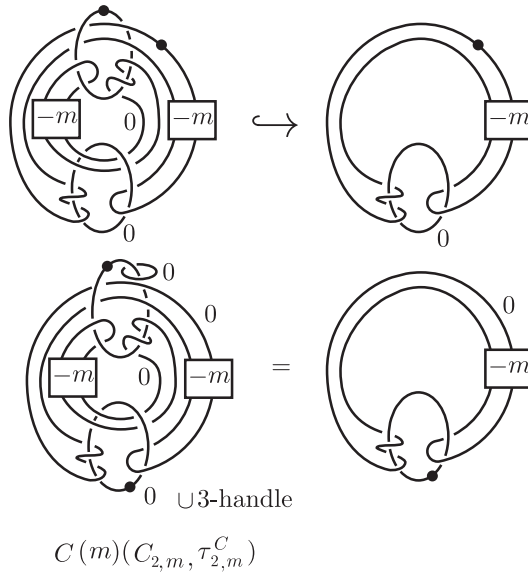

FIGURE 16. An embedding  $C_{2,m} \hookrightarrow C(m)$ .

**Remark 3.7.** For  $E_{n,m}$ , one can find the similar embeddings to those of  $C_{n,m}$ . Namely, there exist  $E_{n,m} \subset E_{n+k,m}$  and  $E_{n,m} \subset E_{n+k,m}$  such that these embeddings satisfy the same condition as that of Proposition 3.6

**Proof of Theorem 1.5.** By using the deleting map  $(0, *, \dots, *) \mapsto (0, *)$  in Lemma 3.2, the current theorem is satisfied. Therefore, as a corollary of Lemma 3.2 and Corollary 3.5 we deduce  $(D_{n,m}, \tau_{n,m})$  is an order  $n$  cork.  $\square$

**Proof of Theorem 1.6.** Attaching 2-handles as the first diagram in FIGURE 17, we obtain the last diagram in the figure. The 4-manifolds for this diagram can be embedded in  $E(l) \# n \overline{\mathbb{C}P^2}$ . This can be seen due to Figure 9.4 in [8]. Actually, if  $l \geq \lceil \frac{2n+1}{3} \rceil$ , then this embedding into  $E(l) \# n \overline{\mathbb{C}P^2}$  can be constructed.

We show that the twist by an embedding  $E_{n,m} \hookrightarrow V_{l,n}$  produces  $(2l - 1)\mathbb{C}P^2 \# (10l + n - 1)\overline{\mathbb{C}P^2}$  by using the argument in Exercise 9.3.4 in [8].  $E_{n,m} \hookrightarrow V_{l,n}(E_{n,m}, (\tau_{n,m}^E)^i)$  contains the handle diagram as in FIGURE 18. By doing the handle slide as indicated by the arrow in the right hand side in FIGURE 18, we get a  $\mathbb{C}P^2$  connected-sum component. By using a  $\mathbb{C}P^2$  formula (FIGURE 19), we get the third diagram in FIGURE 18. A separated  $\mathbb{C}P^2$  component in the third diagram can be moved to the position before separating by using the converse of the handle moves from the second picture to the third picture in FIGURE 18. For the last figure in FIGURE 18 we can use the method as Exercise 9.3.4. in [8]. As a result, for  $0 < i \leq n-1$  we have a diffeomorphism  $V_{l,n}(E_{n,m}, (\tau_{n,m}^E)^i) \cong (2l - 1)\mathbb{C}P \# (10l + n - 1)\overline{\mathbb{C}P^2} \not\cong V_{n,l}$ . This means that  $(E_{n,m}, \tau_{n,m}^E)$  is an order  $n$  cork.  $\square$

**Remark 3.8.** Proposition 3.6 and Theorem 1.5 imply that even when  $C(m)$  cannot be embedded in a 4-manifold  $X$ , if the diagram of  $C(m)$  is contained in  $X$  as a sub-diagram and  $C_{n,m} \hookrightarrow X$  or  $D_{n,m} \hookrightarrow X$  with respect to the sub-diagram, then by doing cork twist  $(C_{n,m}, \tau_{n,m}^C)$  or  $(D_{n,m}, \tau_{n,m})$  respectively, exchanging the dot and 0 in the sub-diagram of  $X$  can be realized by an cork twist  $C_{n,m}$  and  $D_{n,m}$ .

**3.3. Exotic 4-manifolds  $W_{n,m,i}$ .** If there does not exist any smoothly embedded  $-1$ -sphere in a 4-manifold, then we say the 4-manifold is minimal.

**Proof of Proposition 1.7.** Let  $W_{n,m}$  be a 4-manifold  $C_{n,m}$  with  $n(n-1)/2$  2-handles attached. For  $1 \leq i \leq n-1$ , the attaching spheres are the  $i$  parallel meridians of  $\beta_i$  in the diagram of  $C_{n,m}$  in FIGURE 2. The framings are all  $-1$ . The diagram of  $W_{3,m}$  is FIGURE 22. The manifold  $W_{n,m}$  is simply-connected and  $b_2 = n(n-1)/2$  and intersection form is the  $b_2$  direct sum of  $\langle -1 \rangle$ . Clearly  $W_{3,m}$  is a Stein manifold and in particular minimal. Performing the cork twist  $(C_{n,m}, (\tau_{n,m}^C)^i)$  for  $W_{n,m}$ , we get a 4-manifold

$$W_{n,m,i} = W_{n,m}(C_{n,m}, (\tau_{n,m}^C)^i).$$

By this cork twist, the  $i$  parallel meridians are moved to the parallel meridians of  $\beta_0$ , which is a 0-framed 2-handle. Thus the  $i$  meridians can be blow-downed. Hence, we get  $W_{n,m,i} = W'_{n,m,i} \# i \overline{\mathbb{C}P^2}$ . Thus  $W_{n,m,i}$  and  $W_{n,m}$  are exotic, because  $W_{n,m}$  is minimal.  $\square$



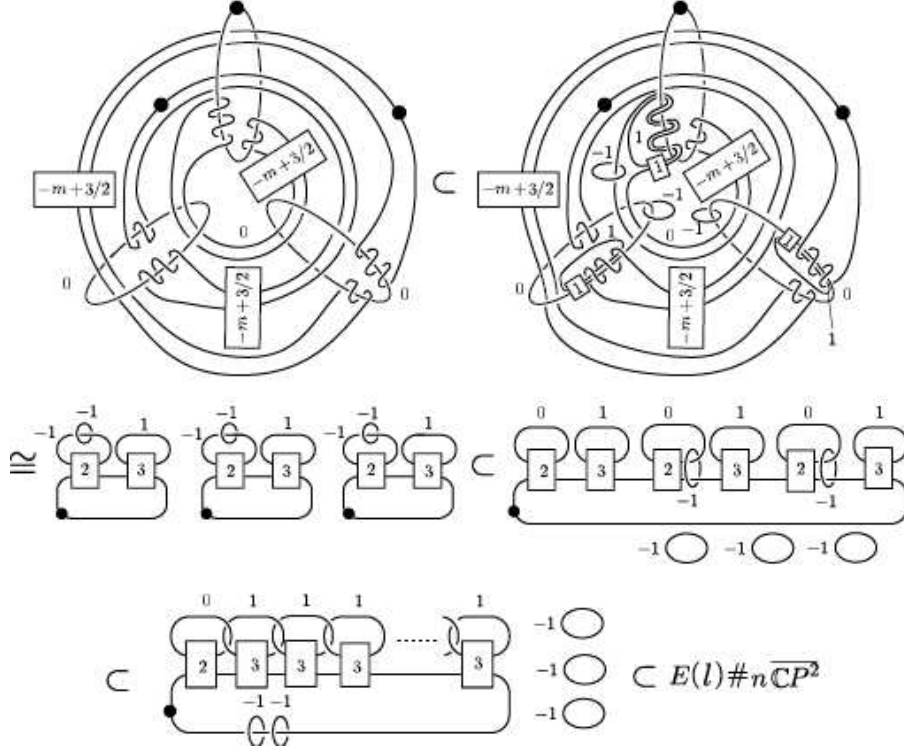

FIGURE 17. An embedding  $E_{n,m} \hookrightarrow E(l) \# n \overline{\mathbb{C}P^2}$ .

The problem of whether  $\{W_{n,m,i}\}_{i=0,\dots,n-1}$  are mutually exotic 4-manifolds is remaining. If all  $W'_{n,m,i}$  for any  $i$  are minimal, then  $W_{n,m,i}$  are mutually exotic 4-manifolds, i.e.,  $(C_{n,m}, \tau_{n,m}^C)$  is a cork for the collection  $\{W_{n,m,i}\}$ .

**Proof of Proposition 1.9.** Let  $F = F_{2,m}$  be a contractible 4-manifold defined in Definition 2.3. Let  $\kappa = \tau_{2,m}^F$  be a rotation by  $\pi/2$ . Since  $(*, 0, *, 0)$  is a period 2  $\{*, 0\}$ -sequence,  $(F, \kappa)$  is order 2 cork by Lemma 3.5.  $\square$

#### 4. A NON-TRIVIAL ACTION ON $HF^+(\partial C_{n,m})$ .

In this section, as an application of finite order corks we prove Theorem 1.10. This theorem is a generalization of the main theorem in [1]. The terms used here are the same ones as those in [1]. The argument is parallel to Theorem 4.1 in [1].

**Proof of Theorem 1.10.** We may show that the map  $(\tau_{n,m}^C)^i$  induces a non-trivial action on  $HF^+(\partial C_{n,m})$ . Let  $\tau_i$  denote  $(\tau_{n,m}^C)^i$ . Let  $\xi$  be the contact structure on  $\partial C_{n,m}$  induced from the Stein structure on  $C_{n,m}$ . As described as in FIGURE 2 in [1], we attach a 2-handle  $H$  along a trefoil linked with  $\beta_{n-i}$  with framing 1. We denote  $U_i = C_{n,m} \cup_{\beta_{n-i}} H$ . This manifold is a Stein manifold because the maximum Thurston-Bennequin number of the trefoil is 1 and the Stein structure of  $C_{n,m}$  extends to  $H$ .

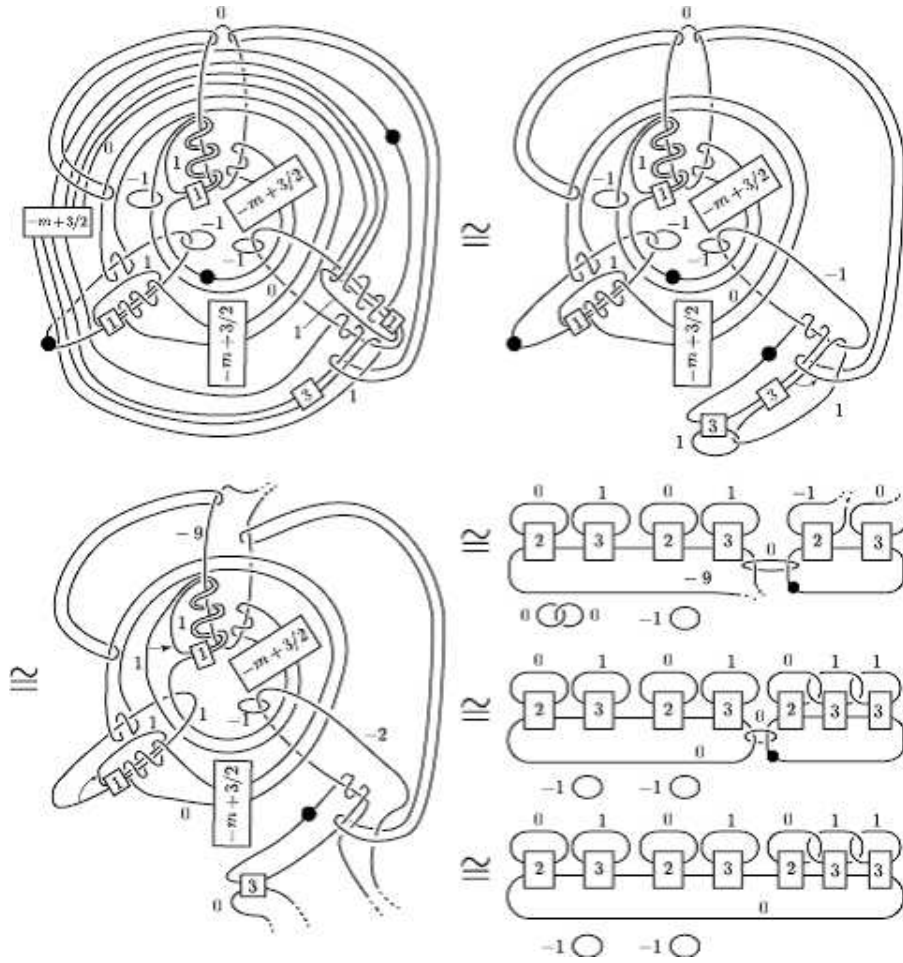

FIGURE 18. A submanifold  $E(l) \# n \overline{CP^2}(E_{n,m}, (\tau_{n,m}^E)^i)$ .

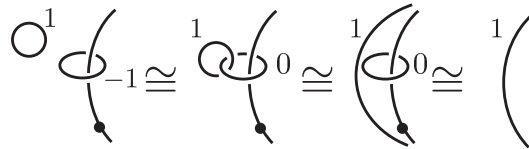

FIGURE 19. A separated  $CP^2$  formula.

Let  $V$  be a concave extension of  $(\partial C_i, \xi)$  of  $H$  due to [9]. Thus,  $X_i = C_{n,m} \cup V$  is a closed symplectic structure with  $b_2^+ > 1$ . We define the twist via  $\tau_i$  by  $X'_i = C_{n,m} \cup_{\tau_i} V$ . In this manifold, we can find an embedded self-intersection number 1 torus. Here we use the following theorem. Here  $\Phi_{X,5}$  is the Ozsváth-Szabó 4-manifold invariant.

**Theorem 4.1** (Ozsváth-Szabó [11]). *Let  $X$  be a closed 4-manifold. Let  $\Sigma \subset X$  be a homologically non-trivial embedded surface with genus  $g \geq 1$  and*

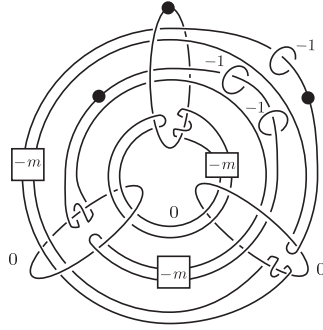

FIGURE 20. The handle decomposition of  $W_{3,m}$ .

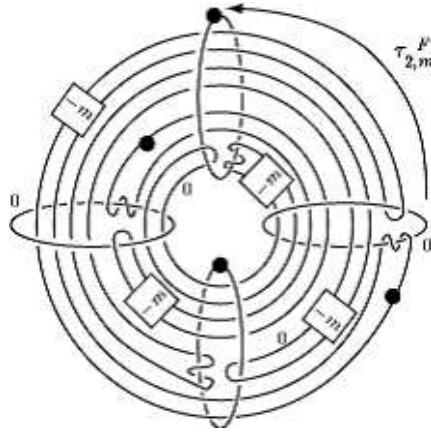

FIGURE 21. A contractible 4-manifold  $F_{2,m}$  and a diffeomorphism  $\tau_{2,m}^F$  with order 4 as a diffeomorphism.

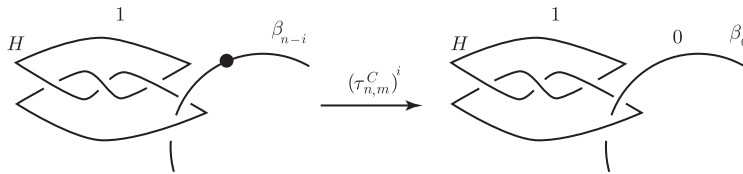

FIGURE 22. The twist of  $U_i$  via  $(\tau_{n,m}^C)^i$ .

with non-negative self-intersection number. Then for each  $\text{spin}^c$  structure  $\mathfrak{s} \in \text{Spin}^c(X)$  for which  $\Phi_{X,\mathfrak{s}} \neq 0$ , we have that

$$|\langle c_1(\mathfrak{s}), [\Sigma] \rangle| + [\Sigma] \cdot [\Sigma] \leq 2g - 2$$

The following is another version of the adjunction inequality along with a non-vanishing result of the 4-manifold invariant for Lefschetz fibrations.

Hence, the Ozsváth-Szabó 4-manifold invariant for  $X'$  has no basic class. Here we obtain the same computation as in [1]:

$$F_{C_{n,m},\mathfrak{s}_0}^+(c^+(\xi)) = \pm F_{C_{n,m},\mathfrak{s}_0}^+ \circ F_{V,\mathfrak{s}}^{\text{mix}}(\Theta_{(-2)}^-) = F_{X,\mathfrak{s}}^{\text{mix}}(\Theta_{(-2)}^-) = \pm \Theta_{(0)}^+,$$

and on the other hand,

$$F_{C_{n,m},\mathfrak{s}_0}^+(\tau_i^*(c^+(\xi))) = F_{C_{n,m},\mathfrak{s}_0}^+ \circ \tau_i^* \circ F_{V,\mathfrak{s}}^{\text{mix}}(\Theta_{(-2)}^-) = \pm F_{X',\mathfrak{s}'}^{\text{mix}}(\Theta_{(-2)}^-) = 0,$$

where  $\mathfrak{s}$  is the canonical  $\text{spin}^c$  structure on symplectic manifold  $X$  and  $\mathfrak{s}'$  is structure, the induced  $\text{spin}^c$  structure on  $X'$ , and  $\mathfrak{s}_0$  is the restriction of  $\mathfrak{s}$  and  $\mathfrak{s}'$  to  $C_{n,m}$ . Here  $c^+(\xi)$  is Ozsváth-Szabó's contact invariant for  $(\partial C_{n,m}^C, \xi)$ . We use the equality  $F_{W,\xi}^{\text{mix}}(\Theta_{(-2)}^-) = \pm c^+(\xi)$  in [?], where  $\xi$  is a contact structure on  $\partial W$  with torsion  $c_1$ .

These two inequalities above means that  $c^+(\xi)$  and  $\tau_i^*(c^+(\xi))$  are distinct elements. Thus,  $\tau_{n,m}^C$  act on  $HF^+(\partial C_{n,m})$  effectively. Namely,  $\xi, \tau_1^*(\xi), \dots, \tau_{n-1}^*(\xi)$  are distinct elements.  $\square$

**Proof of Proposition 1.11.** Let  $\xi$  be a contact structure on  $\partial C_{n,m}$  induced by the Stein structure. Let  $\xi_i$  denote  $\tau_i^*(\xi)$ . Each two structures  $\xi_i, \xi_j$  are homotopic 2-plane fields. For, there exist a trivial cobordism between these contact 3-manifolds, hence  $\xi_i, \xi_j$  are the same 3-dimensional invariants by [7]. This means that these contact structures are homotopic each other. The diffeomorphism  $\tau_{i-j}$  gives a contactomorphism from  $\xi_i$  to  $\xi_j$ . However,  $\xi_i, \xi_j$  are not isotopic because  $c^+(\xi_i)$  and  $c^+(\xi_j)$  are distinct. Furthermore,  $\xi_i$  is Stein filling.  $\square$

## 5. PROBLEMS

Here we raise the two problems.

**Problem 5.1.** Show that  $(C_{n,m}, \tau_{n,m}^C)$  is a cork for the collection  $\{W_{n,m,i}\}_{i=0,1,\dots,n-1}$ .

**Problem 5.2.** Show that  $D_{n,m}, E_{n,m}$  are also finite order Stein corks. In general for any  $\{*, 0\}$ -sequence  $\mathbf{x}$ , show that  $X_{n,m}(\mathbf{x})$  is a Stein manifold.

## REFERENCES

- [1] S. Akbulut and C. Karakurt, *Action of the cork twist on Floer homology*, Proceedings of the Gökova Geometry-Topology Conference 2011, 42-52, Int. Press, Somerville, MA, 2012
- [2] S. Akbulut and R. Matveyev, *A convex decomposition theorem for 4-manifolds*, Internat. Math. Res. Notices 1998, no. 7, 371-381.
- [3] S. Akbulut and R. Matveyev, *Exotic structures and adjunction inequality*, Turkish J. Math.21(1997)47-53
- [4] S. Akbulut, *A fake compact contractible 4-manifold*, J. Diff. Geom. 33(1991)
- [5] C. L. Curtis; M. H. Freedman; W. C.Hsiang; R. Stong, *A decomposition theorem for h-cobordant smooth simply-connected compact 4-manifolds*, Invent. Math. 123 (1996), no. 2, 343-348.
- [6] M. Freedman, *The topology of four-dimensional manifolds*, J. Differential Geom. Volume 17, Number 3 (1982), 357-453.
- [7] R. Gompf, *Handlebody construction of Stein surfaces.*, Ann. of Math. (2) 148 (1998), no. 2, 619-693.

- [8] R. Gompf and A. Stipsicz, *4-manifolds and Kirby calculus*, Graduate Studies in Mathematics, 20. American Mathematical Society, Providence, RI, 1999.
- [9] P. Lisca and Matic, *Tight contact structures and Seiberg-Witten invariants*, Invent. Math. 129(1997)509-525
- [10] R. Matveyev, *A decomposition of smooth simply-connected h-cobordant 4-manifolds*, J. Differential Geom. 44 (1996), no. 3, 571-582.
- [11] Ozsváth and Szabó, *Holomorphic triangles and invariants for smooth four-manifolds* Adv. Math. 202 (2006), no. 2, 326-400
- [12] M. Tange, *A plug with infinite order and some exotic structures*, to appear to JGGT(2015)

INSTITUTE OF MATHEMATICS, UNIVERSITY OF TSUKUBA, 1-1-1 TENNODAI, TSUKUBA,  
IBARAKI 305-8571, JAPAN

*E-mail address:* `tange@math.tsukuba.ac.jp`