

Ends of Schreier graphs and cut-points of limit spaces of self-similar groups

Ievgen Bondarenko, Daniele D'Angeli, Tatiana Nagnibeda *

September 20, 2018

Abstract

Every self-similar group acts on the space X^ω of infinite words over some alphabet X . We study the Schreier graphs Γ_w for $w \in X^\omega$ of the action of self-similar groups generated by bounded automata on the space X^ω . Using sofic subshifts we determine the number of ends for every Schreier graph Γ_w . Almost all Schreier graphs Γ_w with respect to the uniform measure on X^ω have one or two ends, and we characterize bounded automata whose Schreier graphs have two ends almost surely. The connection with (local) cut-points of limit spaces of self-similar groups is established.

Keywords: self-similar group, Schreier graph, end of graph, bounded automaton, limit space, tile, cut-point

Mathematics Subject Classification 2010: 20F65, 05C63, 05C25

Contents

1	Introduction	2
2	Preliminaries	6
2.1	Self-similar groups and automata	6
2.1.1	Self-similar groups	6
2.1.2	Automata and automaton groups	7
2.1.3	Contracting self-similar groups	7
2.2	Schreier graphs vs tile graphs of self-similar groups	8
2.3	Schreier graphs of groups generated by bounded automata	9
2.3.1	Bounded automata	9
2.3.2	Cofinality & post-critical, critical and regular sequences	9
2.3.3	Inflation of graphs	11

*The second author was supported by Austrian Science Fund project FWF P24028-N18. The third author acknowledge the support of the Swiss National Science Foundation Grant PP0022-118946.

3	Ends of tile graphs and Schreier graphs	11
3.1	Technical assumptions	12
3.2	The number of ends and infinite components in tile graphs with a vertex removed	12
3.3	Finite automaton to determine the number of components in tile graphs with a vertex removed	15
3.4	The number of ends of tile graphs	18
3.5	From ends of tile graphs to ends of Schreier graphs	19
3.6	The number of infinite components of tile graphs almost surely	20
3.7	The number of ends almost surely	21
3.8	Two ends almost surely	22
4	Cut-points of tiles and limit spaces	28
4.1	Limit spaces and tiles of self-similar groups	28
4.2	Cut-points of tiles and limit spaces	30
4.2.1	Boundary, critical and regular points	30
4.2.2	Components in the tile with a point removed	30
4.2.3	The number of components in punctured limit space and tile almost surely	33
5	Examples	34
5.1	Basilica group	34
5.2	Gupta-Fabrykowski group	38
5.3	Iterated monodromy group of $z^2 + i$	41

1 Introduction

One of the fundamental properties of fractal objects is self-similarity, which means that pieces of an object are similar to the whole object. In the last twenty years the notion of self-similarity has successfully penetrated into algebra. This led to the development of many interesting constructions such as self-similar groups and semigroups, iterated monodromy groups, self-iterating Lie algebras, permutational bimodules, etc. The first examples of self-similar groups showed that these groups enjoy many fascinating properties (torsion, intermediate growth, finite width, just-infiniteness and many others) and provide counterexamples to several open problems in group theory. Later, Nekrashevych showed that self-similar groups appear naturally in dynamical systems as iterated monodromy groups of self-coverings and provide combinatorial models for iterations of self-coverings.

Self-similar groups are defined by their action on the space X^* of all finite words over a finite alphabet X — one the most basic self-similar object. A faithful action of a group G on X^* is called self-similar if for every $x \in X$ and $g \in G$ there exist $y \in X$ and $h \in G$ such that $g(xv) = yh(v)$ for all words $v \in X^*$. The self-similarity of the action is reflected in the property that the action of any group element on a piece xX^* (all words with the

first letter x) of the space X^* can be identified with the action of another group element on the whole space X^* . We can also imagine the set X^* as the vertex set of a regular rooted tree with edges (v, vx) for $x \in X$ and $v \in X^*$. Then every self-similar group acts by automorphisms on this tree. Alternatively, self-similar groups can be defined as groups generated by the states of invertible Mealy automata which are also known as automaton groups or groups generated by automata. All these interpretations come from different applications of self-similar groups in diverse areas of mathematics: geometric group theory, holomorphic dynamics, fractal geometry, automata theory, etc. (see [25, 3, 16] and the references therein).

In this paper we consider Schreier graphs of self-similar actions of groups. Given a group G generated by a finite set S and acting on a set M , one can associate to it the (simplicial) Schreier graph $\Gamma(G, M, S)$: the vertex set of the graph is the set M , and two vertices x and y are adjacent if and only if there exists $s \in S \cup S^{-1}$ such that $s(x) = y$. Schreier graphs are generalizations of the Cayley graph of a group, which corresponds to the action of a group on itself by the multiplication from the left.

Every self-similar group G preserves the length of words in its action on the space X^* . We then have a family of natural actions of G on the sets X^n of words of length n over X . From these actions one gets a family of corresponding finite Schreier graphs $\{\Gamma_n\}_{n \geq 1}$. It was noticed in [2] that for a few self-similar groups the graphs $\{\Gamma_n\}_{n \geq 1}$ are substitution graphs (see [24]) — they can be constructed by a finite collection of vertex replacement rules — and, normalized to have diameter one, they converge in the Gromov-Hausdorff metric to certain fractal spaces. However, in general, the Schreier graphs of self-similar groups are neither substitutional nor self-similar in any studied way (see discussion in [6, Section I.4]). Nevertheless, the observation from [2] lead to the notion of the limit space of a self-similar group introduced by Nekrashevych [25], which usually have fractal structure. Although finite Schreier graphs $\{\Gamma_n\}_{n \geq 1}$ of a group do not necessary converge to the limit space, they form a sequence of combinatorial approximations to it.

Any self-similar action can be extended to the set X^ω of right-infinite words over X (boundary of the tree X^*). Therefore we can also consider the uncountable family of Schreier graphs $\{\Gamma_w\}_{w \in X^\omega}$ corresponding to the action of the group on the orbit of w . Each Schreier graph Γ_w can be obtained as a limit of the sequence $\{\Gamma_n\}_{n \geq 1}$ in the space \mathcal{G}^* of (isomorphism classes of) pointed graphs with pointed Gromov-Hausdorff topology. The map $\theta : X^\omega \rightarrow \mathcal{G}^*$ sending a point w to the isomorphism class of the pointed graph (Γ_w, w) pushes forward the uniform probability measure on the space X^ω to a probability measure on the space of Schreier graphs. This measure is the so-called Benjamini-Schramm limit of the sequence of finite graphs $\{\Gamma_n\}_{n \geq 1}$. Therefore the family of Schreier graphs Γ_w and the limit space represent two limiting constructions associated to the action and to the sequence of finite Schreier graphs $\{\Gamma_n\}_{n \geq 1}$. Structure of these Schreier graphs as well as some of their properties such as spectra, expansion, growth, random weak limits, probabilistic models on them, have been studied in various works over the last ten years, see [2, 19, 18, 6, 11, 12, 13, 7, 23, 8].

Most of the studied self-similar groups are generated by the so-called bounded automata introduced by Sidki in [29]. The structure of bounded automata is clearly understood,

which allows one to deal fairly easily with groups generated by such automata. The main property of bounded automaton groups is that their action is concentrated along a finite number of “directions” in the tree X^* . Every group generated by a bounded automaton belongs to an important class of contracting self-similar groups, which appear naturally in the study of expanding (partial) self-coverings of topological spaces and orbispaces, as their iterated monodromy groups [25, 27]. Moreover, all iterated monodromy groups of post-critically finite polynomials are generated by bounded automata. The limit space of an iterated monodromy group of an expanding (partial) self-covering f is homeomorphic to the Julia set of the map f . In the language of limit spaces, groups generated by bounded automata are precisely those finitely generated self-similar groups whose limit spaces are post-critically finite self-similar sets (see [5]). Such sets play an important role in the development of analysis on fractals (see [22]).

The main goal of this paper is to investigate the ends of the Schreier graphs $\{\Gamma_w\}_{w \in X^\omega}$ of self-similar groups generated by bounded automata and the corresponding limit spaces. The number of ends is an important asymptotic invariant of an infinite graph. Roughly speaking, each end represents a topologically distinct way to move to infinity inside the graph. The most convenient way to define an end in an infinite graph Γ is by the equivalence relation on infinite rays in Γ , where two rays are declared equivalent if their tails lie in the same connected component of $\Gamma \setminus F$ for any finite subgraph F of Γ . Any equivalence class is an *end* of the graph Γ . The number of ends is a quasi-isometric invariant. The Cayley graph of an infinite finitely generated group can have one, two or infinitely many ends. Two-ended groups are virtually infinite cyclic and the celebrated theorem of Stallings characterizes finitely generated groups with infinite number of ends.

Plan of the paper and main results

Our main results can be summarized as follows.

- Given a group generated by a bounded automaton we exhibit a constructive method that determines, for a given right-infinite word w , the number of ends of the Schreier graph Γ_w (Section 3).
- We show that the Schreier graphs Γ_w of a group generated by a bounded automaton have either one or two ends almost surely, and there are only finitely many Schreier graphs with more than two ends (Section 3.7, Proposition 13, Theorem 17).
- We classify bounded automata generating groups whose Schreier graphs Γ_w have almost surely two ends (Theorem 17). In the binary case, these groups agree with the class of groups defined by Šunić in [28] (Theorem 18).
- We exhibit a constructive method that describes cut-points of limit spaces of groups generated by bounded automata (Section 4.2.2).
- In particular, we get a constructive method that describes cut-points of Julia sets of post-critically finite polynomials (Section 4.2.2).

- We show that a punctured limit space has one or two connected components almost surely (Theorem 21).
- We classify contracting self-similar groups whose limit space is homeomorphic to an interval or a circle (Corollary 22).

The paper is organized as follows. First, we determine the number of connected components in the Schreier graph $\Gamma_n \setminus v$ with removed vertex v . The answer comes from a finite deterministic acceptor automaton over the alphabet X (Section 3.3) so that given a word $v = x_1x_2 \dots x_n$ the automaton returns the number of components in $\Gamma_n \setminus v$ (Theorem 5). Using this automaton we determine the number of finite and infinite connected components in $\Gamma_w \setminus w$ for any $w \in X^\omega$. By establishing the connection between the number of ends of the Schreier graph Γ_w and the number of infinite components in $\Gamma_w \setminus w$ (Proposition 3), we determine the number of ends of Γ_w (Theorem 8).

If a self-similar group acts transitively on X^n for all $n \in \mathbb{N}$, the action on X^ω is ergodic with respect to the uniform measure on X^ω , and therefore the Schreier graphs Γ_w for $w \in X^\omega$ have the same number of ends almost surely. For a group generated by a bounded automaton the “typical” number of ends is one or two, and we show that in most cases it is one, by characterizing completely the bounded automata generating groups whose Schreier graphs Γ_w have almost surely two ends (Theorem 17). In the binary case we show that automata giving rise to groups whose Schreier graphs have almost surely two ends correspond to the adding machine or to one of the automata defined by Šunić in [28] (Theorem 18).

In Section 4 we recall the notion of the limit space of a contracting self-similar group, and study the number of connected components in a punctured limit space for groups generated by bounded automata. We show that the number of ends in a typical Schreier graph Γ_w coincides with the number of connected components in a typical punctured neighborhood (punctured tile) of the limit space (Theorem 21). In particular, this number is equal to one or two. This fact is well-known for connected Julia sets of polynomials. While Zdunik [31] and Smirnov [30] proved that almost every point of a connected polynomial Julia set is a bisection point only when the polynomial is conjugate to a Chebyshev polynomial, we describe bounded automata whose limit spaces have this property. Moreover, we provide a constructive method to compute the number of connected components in a punctured limit space (Section 4.2). Finally, using the results about ends of Schreier graphs, we classify contracting self-similar groups whose limit space is homeomorphic to an interval or a circle (Corollary 22). This result agrees with the description of automaton groups whose limit dynamical system is conjugate to the tent map given by Nekrashevych and Šunić in [27].

In Section 2 we recall all needed definitions concerning self-similar groups, automata and their Schreier graphs. In Section 5 we illustrate our results by performing explicit computations for three concrete examples: the Basilica group, the Gupta-Fabrykowski group, and the iterated monodromy group of $z^2 + i$.

Acknowledgments. The substantial part of this work was done while the first author was visiting the Geneva University, whose support and hospitality are gratefully acknowledged.

2 Preliminaries

In this section we review the basic definitions and facts concerning self-similar groups, bounded automata and their Schreier graphs. For more detailed information and for further references, see [25].

2.1 Self-similar groups and automata

Let X be a finite set with at least two elements. Denote by $X^* = \{x_1x_2 \dots x_n \mid x_i \in X, n \geq 0\}$ the set of all finite words over X (including the empty word denoted \emptyset) and with X^n the set of words of length n . The length of a word $v = x_1x_2 \dots x_n \in X^n$ is denoted by $|v| = n$.

We shall also consider the sets X^ω and $X^{-\omega}$ of all right-infinite sequences $x_1x_2 \dots$, $x_i \in X$, and left-infinite sequences $\dots x_2x_1$, $x_i \in X$, respectively with the product topology of discrete sets X . For an infinite sequence $w = x_1x_2 \dots$ (or $w = \dots x_2x_1$) we use notation $w_n = x_1x_2 \dots x_n$ (respectively, $w_n = x_n \dots x_2x_1$). For a word v we use notations $v^\omega = vv \dots$ and $v^{-\omega} = \dots vv$. The *uniform Bernoulli measure* on each space X^ω and $X^{-\omega}$ is the product measure of uniform distributions on X . The *shift* σ on the space X^ω (respectively, on $X^{-\omega}$) is the map which deletes the first (respectively, the last) letter of a right-infinite (respectively, left-infinite) sequence.

2.1.1 Self-similar groups

Definition 1. A faithful action of a group G on the set $X^* \cup X^\omega$ is called *self-similar* if for every $g \in G$ and $x \in X$ there exist $h \in G$ and $y \in X$ such that

$$g(xw) = yh(w)$$

for all $w \in X^* \cup X^\omega$. The element h is called the *restriction* of g at x and is denoted by $h = g|_x$.

Inductively one defines the restriction $g|_{x_1x_2 \dots x_n} = g|_{x_1}|_{x_2} \dots |_{x_n}$ for every word $x_1x_2 \dots x_n \in X^*$. Restrictions have the following properties

$$g(vu) = g(v)g|_v(u), \quad g|_{vu} = g|_v|_u, \quad (g \cdot h)|_v = g|_{h(v)} \cdot h|_v$$

for all $g, h \in G$ and $v, u \in X^*$ (we are using left actions so that $(gh)(v) = g(h(v))$). If $X = \{1, 2, \dots, d\}$ then every element $g \in G$ can be uniquely represented by the tuple $(g|_1, g|_2, \dots, g|_d)\pi_g$, where π_g is the permutation induced by g on the set X .

It follows from the definition that every self-similar group G preserves the length of words under its action on the space X^* , so that we have an action of the group G on the set X^n for every n .

The set X^* can be naturally identified with a rooted regular tree where the root is labeled by the empty word \emptyset , the first level is labeled by the elements in X and the n -th level corresponds to X^n . The set X^ω can be identified with the boundary of the tree. Every self-similar group acts by automorphisms on this rooted tree and by homeomorphisms on its boundary.

2.1.2 Automata and automaton groups

Another way to introduce self-similar groups is through input-output automata and automaton groups. A transducer *automaton* is a quadruple (S, X, t, o) , where S is the set of states of automaton; X is an alphabet; $t : S \times X \rightarrow S$ is the transition map; and $o : S \times X \rightarrow X$ is the output map. We will use notation S for both the set of states and the automaton itself. An automaton is *finite* if it has finitely many states and it is *invertible* if, for all $s \in S$, the transformation $o(s, \cdot) : X \rightarrow X$ is a permutation of X . An automaton can be represented by a directed labeled graph whose vertices are identified with the states and for every state $s \in S$ and every letter $x \in X$ it has an arrow from s to $t(s, x)$ labeled by $x|o(s, x)$. This graph contains complete information about the automaton and we will identify them. When talking about paths and cycles in automata we always mean directed paths and cycles in corresponding graph representations.

Every state $s \in S$ of an automaton defines a transformation on the set $X^* \cup X^\omega$, which is again denoted by s by abuse of notation, as follows. Given a word $x_1x_2\dots$ over X , there exists a unique path in S starting at the state s and labeled by $x_1|y_1, x_2|y_2, \dots$ for some $y_i \in X$. Then $s(x_1x_2\dots) = y_1y_2\dots$. We always assume that our automata are minimal, i.e., different states define different transformations. The state of automata that defines the identity transformation is denoted by 1.

An automaton S is invertible when all transformations defined by its states are invertible. In this case one can consider the group generated by these transformations under composition of functions, which is called the *automaton group* generated by S and is denoted by $G(S)$. The natural action of every automaton group on the space X^ω is self-similar, and vice versa, every self-similar action of a group G can be given by the automaton with the set of states G and arrows $g \rightarrow g|_x$ labeled by $x|g(x)$ for all $g \in G$ and $x \in X$.

2.1.3 Contracting self-similar groups

A self-similar group G is called *contracting* if there exists a finite set $\mathcal{N} \subset G$ with the property that for every $g \in G$ there exists $n \in \mathbb{N}$ such that $g|_v \in \mathcal{N}$ for all words v of length greater or equal to n . The smallest set \mathcal{N} with this property is called the *nucleus* of the group. It is clear from definition that $h|_x \in \mathcal{N}$ for every $h \in \mathcal{N}$ and $x \in X$, and therefore the nucleus \mathcal{N} can be considered as an automaton. Moreover, every state of \mathcal{N} has an incoming arrow, because otherwise minimality of the nucleus would be violated. Also, the nucleus is symmetric, i.e., $h^{-1} \in \mathcal{N}$ for every $h \in \mathcal{N}$.

A self-similar group G is called *self-replicating* (or recurrent) if it acts transitively on X , and the map $g \mapsto g|_x$ from the stabilizer $Stab_G(x)$ to the group G is surjective for some (every) letter $x \in X$. It can be shown that a self-replicating group acts transitively on X^n for every $n \geq 1$. It is also easy to see ([25, Proposition 2.11.3]) that if a finitely generated contracting group is self-replicating then its nucleus \mathcal{N} is a generating set.

2.2 Schreier graphs vs tile graphs of self-similar groups

Let G be a group generated by a finite set S and let H be a subgroup of G . The (*simplicial*) *Schreier coset graph* $\Gamma(G, S, H)$ of the group G is the graph whose vertices are the left cosets $G/H = \{gH : g \in G\}$, and two vertices g_1H and g_2H are adjacent if there exists $s \in S$ such that $g_2H = sg_1H$ or $g_1H = sg_2H$.

Definition 2. Let G be a group acting on a set M , then the corresponding (simplicial) *Schreier graph* $\Gamma(G, S, M)$ is the graph with the set of vertices M , and two vertices v and u are adjacent if there exists $s \in S$ such that $s(v) = u$ or $s(u) = v$.

If the action (G, M) is transitive, then the Schreier coset graph $\Gamma(G, S, M)$ is isomorphic to the Schreier graph $\Gamma(G, S, \text{Stab}_G(m))$ of the group with respect to the stabilizer $\text{Stab}_G(m)$ for any $m \in M$.

Let G be a self-similar group generated by a finite set S . The sets X^n are invariant under the action of G , and we denote the associated Schreier graphs by $\Gamma_n = \Gamma_n(G, S)$. For a point $w \in X^\omega$ we consider the action of the group G on the G -orbit of w , and the associated Schreier graph is called the *orbital Schreier graph* denoted $\Gamma_w = \Gamma_w(G, S)$. For every $w \in X^\omega$ we have $\text{Stab}_G(w) = \bigcap_{n \geq 1} \text{Stab}_G(w_n)$, where w_n denotes the prefix of length n of the infinite word w . The connected component of the rooted graph (Γ_n, w_n) around the root w_n is exactly the Schreier graph of G with respect to the stabilizer of w_n . It follows immediately that the graphs (Γ_n, w_n) converge to the graph (Γ_w, w) in the pointed Gromov-Hausdorff topology [21].

Besides the Schreier graphs, we will also work with their subgraphs called tile graphs.

Definition 3. The *tile graph* $T_n = T_n(G, S)$ is the graph with the set of vertices X^n , where two vertices v and u are adjacent if there exists $s \in S$ such that $s(v) = u$ and $s|_v = 1$.

The tile graph T_n is thus a subgraph of the Schreier graph Γ_n . To define a tile graph for the action on the space X^ω , consider the same set of vertices as in Γ_w and connect vertices v and u by an edge if there exists $s \in S$ such that $s(v) = u$ and $s|_{v'} = 1$ for some finite beginning $v' \in X^*$ of the sequence v . The connected component of this graph containing the vertex w is called the *orbital tile graph* T_w . It is clear from the construction that we also have the convergence $(T_n, w_n) \rightarrow (T_w, w)$ in the pointed Gromov-Hausdorff topology.

The study of orbital tile graphs T_w is based on the approximation by finite tile graphs T_n . Namely, we will frequently use the following observation. Every tile graph T_n can be considered as a subgraph of T_w under the inclusion $v \mapsto v\sigma^n(w)$. Indeed, if v and u are adjacent in T_n then $v\sigma^n(w)$ and $u\sigma^n(w)$ are adjacent in T_w . Moreover, every edge of T_w appears in the graph T_n for all large enough n . Hence the graphs T_n viewed as subgraphs of T_w form a cover of T_w .

2.3 Schreier graphs of groups generated by bounded automata

2.3.1 Bounded automata

Definition 4. (Sidki [29]) A finite invertible automaton S is called *bounded* if one of the following equivalent conditions holds:

- 1) the number of paths of length n in $S \setminus \{1\}$ is bounded independently on n ;
- 2) the number of left- (equivalently, right-) infinite paths in $S \setminus \{1\}$ is finite;
- 3) any two nontrivial cycles in the automaton are disjoint and not connected by a path, where a cycle is called trivial if it is a loop at the trivial state;
- 4) the number of left- (equivalently, right-) infinite sequences, which are read along left- (respectively, right-) infinite paths in $S \setminus \{1\}$, is finite.

The states of a bounded automaton S can be classified as follows:

- a state s is *finitary* if there exists $n \in \mathbb{N}$ such that $s|_v = 1$ for all $v \in X^n$;
- a state s is *circuit* if there exists a nonempty word $v \in X^n$ such that $s|_v = s$, i.e., s belongs to a cycle in S ; in this case $s|_u$ is finitary for every $u \in X^n$, $u \neq v$;
- for every state s there exists $n \in \mathbb{N}$ such that for every $v \in X^n$ the state $s|_v$ is either finitary or circuit.

By passing to a power X^m of the alphabet X every bounded automaton can be brought to the *basic form* (see [25, Proposition 3.9.11]) in which the above items hold with $n = 1$; in particular, all cycles are loops, and $s|_x = 1$ for every finitary state s and every $x \in X$ (here for m we can take an integer number which is greater than the diameter of the automaton and is a multiple of the length of every simple cycle).

Every self-similar group G generated by a bounded automaton is contracting (see [25, Theorem 3.9.12]). Its nucleus is a bounded automaton, which contains only finitary and circuit states (because every state of a nucleus should have an incoming arrow).

2.3.2 Cofinality & post-critical, critical and regular sequences

In this section we introduce the notion of critical and post-critical sequences that is fundamental for our analysis.

Let G be a contracting self-similar group generated by an automaton S and we assume $S = S^{-1}$. Let us describe the vertex sets of the orbital tile graphs $T_w = T_w(G, S)$. Two right- (or left-) infinite sequences are called *cofinal* if they differ only in finitely many letters. Cofinality is an equivalence relation on X^ω and $X^{-\omega}$. The respective equivalence classes are called the cofinality classes and they are denoted by $Cof(\cdot)$. The following statement characterizes vertices of tile graphs in terms of the cofinal sequences.

Lemma 1. *Suppose that the tile graphs $T_n(G, S)$ are connected for all $n \in \mathbb{N}$. Then for every $w \in X^\omega$ the cofinality class $Cof(w)$ is the set of vertices of the orbital tile graph $T_w(G, S)$.*

Proof. If $g(v) = u$ for $v, u \in X^\omega$ and $g|_{v'} = 1$ for a finite beginning v' of v then v and u are cofinal. Conversely, since every graph T_n is connected, for every $v, u \in X^n$ there exists $g \in G$ such that $g(v) = u$ and $g|_v = 1$. Hence $g(vw) = uw$ for all $w \in X^\omega$ and every two cofinal sequences belong to the same orbital tile graph. \square

We classify infinite sequences over X as follows. A left-infinite sequence $\dots x_2x_1 \in X^{-\omega}$ is called *post-critical* if there exists a left-infinite path $\dots e_2e_1$ in the automaton $S \setminus \{1\}$ labeled by $\dots x_2x_1 | \dots y_2y_1$ for some $y_i \in X$. The set \mathcal{P} of all post-critical sequences is called *post-critical*. A right-infinite sequence $w = x_1x_2\dots \in X^\omega$ is called *critical* if there exists a right-infinite path $e_1e_2\dots$ in the automaton $S \setminus \{1\}$ labeled by $x_1x_2\dots | y_1y_2\dots$ for some $y_i \in X$. It follows that every shift $\sigma^n(w)$ of a critical sequence w is again critical, and for every $n \in \mathbb{N}$ there exists $v \in X^n$ such that vw is critical (here we use the assumption that every path in S can be continued to the left). It is proved in [6, Proposition IV.18] (see also [25, Proposition 3.2.7]) that the set of post-critical sequences coincides with the set of sequences that can be read along left-infinite paths in the nucleus of the group with removed trivial state. The same proof works for critical sequences. Therefore the sets of critical and post-critical sequences do not depend on the chosen generating set (as soon as it satisfies assumption that every state of the automaton S has an incoming arrow, and $S^{-1} = S$). Finally, a sequence $w \in X^\omega$ is called *regular* if the cofinality class of w does not contain critical sequences, or, equivalently, if the shifted sequence $\sigma^n(w)$ is not critical for every $n \geq 0$. Notice that the cofinality class of a critical sequence contains sequences which are neither regular nor critical.

Proposition 1. *Suppose that the automaton S is bounded. Then the sets of critical and post-critical sequences are finite. Every post-critical sequence is pre-periodic. Every cofinality class contains not more than one critical sequence. The cofinality class of a regular sequence contains only regular sequences. If w is regular, then there exists a finite beginning v of w such that $s|_v = 1$ for every $s \in S$.*

Proof. The number of right- and left-infinite paths avoiding the trivial state is finite in every bounded automaton. Thus the number of critical and post-critical sequences is finite.

The pre-periodicity of post-critical sequences and the periodicity of critical sequences follow from the cyclic structure of bounded automata. The statement about the cofinality class of a critical sequence follows immediately, because different periodic sequences can not differ only in finitely many letters.

Finally, if $w = x_1x_2\dots \in X^\omega$ is regular, then starting from any state $s \in S$ and following the edges labeled by $x_1|*, x_2|*, \dots$ we will end at the trivial state. Hence there exists n such that $s|_{x_1x_2\dots x_n} = 1$ for all $s \in S$. \square

Note that if the automaton S is in the basic form, then every post-critical sequence is of the form $y^{-\omega}$ or $y^{-\omega}x$ for some letters $x, y \in X$, and every critical sequence is of the form x^ω for some $x \in X$.

2.3.3 Inflation of graphs

Let G be a group generated by a bounded automaton S . We assume $S = S^{-1}$ and every state of S has an incoming arrow. In what follows we describe an inductive method (called *inflation of graphs*) to construct the tile graphs $T_n = T_n(G, S)$ developed in [6, Chapter V].

Let $p = \dots x_2 x_1 \in \mathcal{P}$ be a post-critical sequence. The vertex $p_n = x_n \dots x_2 x_1$ of the graphs Γ_n and T_n will be called *post-critical*. Since the post-critical set \mathcal{P} is finite, for all large enough n , the post-critical vertices of Γ_n and T_n are in one-to-one correspondence with the elements of \mathcal{P} (just take n large enough so that $p_n \neq q_n$ whenever $p \neq q$). Hence, with a slight abuse of notations, we will consider the elements of the set \mathcal{P} as the vertices of the graphs Γ_n and T_n .

Let E be the set of all pairs $\{(p, x), (q, y)\}$ for $p, q \in \mathcal{P}$ and $x, y \in X$ such that there exists a left-infinite path in the automaton S , which ends in the trivial state and is labeled by the pair $px|qy$.

Theorem 2. [6, Theorem V.8] *To construct the tile graph T_{n+1} take $|X|$ copies of the tile graph T_n , identify their sets of vertices with $X^n x$ for $x \in X$, and connect two vertices vx and uy by an edge if and only if $v, u \in \mathcal{P}$ and $\{(v, x), (u, y)\} \in E$.*

The procedure of inflation of graphs given in Theorem 2 can be described using the graph M with the vertex set $\mathcal{P} \times X$ and the edge set E , which we call the *model graph* associated to the automaton S . The vertex (p, x) of M is called *post-critical*, if the sequence px is post-critical. Note that the post-critical vertices of M are in one-to-one correspondence with elements of the post-critical set \mathcal{P} . Now if we “place” the graph T_n in the model graph instead of the vertices $\mathcal{P} \times x$ for each $x \in X$ such that the post-critical vertices of T_n fit with the set $\mathcal{P} \times x$, we get the graph T_{n+1} . Moreover, the post-critical vertices of M will correspond to the post-critical vertices of T_{n+1} .

In order to construct the Schreier graph Γ_n we can take the tile graph T_n and add an edge between post-critical vertices p and q if $s(p) = q$ for some $s \in S$. Indeed, if $s(v) = u$ and $s|_v \neq 1$ (the edge that does not appear in T_n) then v and u are post-critical vertices, and they should be adjacent in Γ_n . Notice that there are only finitely many added edges (independently on n) and they can be described directly through the generating set S . Namely, define the set $E(\Gamma \setminus T)$ as the set of all pairs $\{p, q\}$ for $p, q \in \mathcal{P}$ such that there exists a left-infinite path in S labeled by the pair $p|q$ or $q|p$. Then if we take the tile graph T_n and add an edge between p_n and q_n for every $\{p, q\} \in E(\Gamma \setminus T)$, we get the Schreier graph Γ_n .

3 Ends of tile graphs and Schreier graphs

In this section we present the main results about the number of ends of Schreier graphs Γ_w of groups generated by bounded automata. Our method passes through the study of the same problem for the tile graphs T_w . First, we show that the number of ends of graphs T_w can be deduced from the number of connected components in tile graphs with a vertex removed

(see Proposition 3). We use the inflation procedure to construct a finite deterministic automaton A_{ic} , which given a sequence $w \in X^\omega$ determines the number of infinite connected components in the graph T_w with the vertex w removed (see Proposition 7). Then we describe all sequences $w \in X^\omega$ such that T_w has a given number of ends in terms of sofic subshifts associated to strongly connected components of the automaton A_{ic} . Further we deduce the number of ends of Schreier graph Γ_w (see Corollary 10). After this, we pass to the study of the number of ends for a random Schreier graph Γ_w . We show that picking randomly an element w in X^ω , the graph Γ_w has one or two ends (see Corollary 15). The latter case is completely described (see Theorem 17).

3.1 Technical assumptions

In what follows, except for a few special cases directly indicated, we make the following assumptions about the studied self-similar groups G and their generating sets S :

1. *The group G is generated by a bounded automaton S .*
2. *The tile graphs $T_n = T_n(G, S)$ are connected.*
3. *Every state of the automaton S has an incoming arrow, and $S^{-1} = S$.*

Instead of the assumption 2 it is enough to require that the group acts transitively on X^n for every $n \geq 1$, i.e., the Schreier graphs $\Gamma_n(G, S)$ are connected. Then, even if the tile graphs $T_n(G, S)$ are not connected, there is a uniform bound on the number of connected components in $T_n(G, S)$ (see how the Schreier graphs are constructed from the tile graphs after Theorem 2), and one can apply the developed methods to each component. The assumption 3 is technical, it guaranties that every directed path in the automaton S can be continued to the left. If the generating set S contains a state s' , which does not contain incoming edges, then $s|_x \in S \setminus \{s'\}$ for every $s \in S$ and $x \in X$, and hence the state s' does not interplay on the asymptotic properties of the tile or Schreier graphs. Moreover, if the group is self-replicating, then the property 3 is always satisfied, when we take its nucleus \mathcal{N} as the generating set S .

3.2 The number of ends and infinite components in tile graphs with a vertex removed

For a graph Γ and its vertex v we denote by $\Gamma \setminus v$ the graph obtained from Γ by removing the vertex v together with all edges adjacent to v .

Let Γ be an infinite, locally finite graph. A *ray* in Γ is an infinite sequence of adjacent vertices v_1, v_2, \dots in Γ such that $v_i \neq v_j$ for $i \neq j$. Two rays r and r' are equivalent if for every finite subset $F \subset \Gamma$ infinitely many vertices of r and r' belong to the same connected component of $\Gamma \setminus F$. An *end* of Γ is an equivalence class of rays.

In what follows we use the notation:

- $\#Ends(\Gamma)$ is the number of ends of Γ ;
- $c(\Gamma)$ is the number of connected components in the graph Γ ;
- $ic(\Gamma)$ is the number of infinite connected components in Γ .

We will show later that the number $ic(\Gamma)$ can be computed for $\Gamma = T_w \setminus w$. The following proposition relates this value to the number of ends of T_w .

Proposition 3. *Every tile graph T_w for $w \in X^\omega$ has finitely many ends, which is equal to*

$$\#Ends(T_w) = \lim_{n \rightarrow \infty} ic(T_{\sigma^n(w)} \setminus \sigma^n(w)),$$

where σ is the shift map on the space X^ω .

Proof. Let us show that the number of infinite connected components of the graphs $T_{\sigma^n(w)} \setminus \sigma^n(w)$ and $T_w \setminus X^n \sigma^n(w)$ is the same for every n . Consider the natural partition of the set of vertices of T_w given by

$$Cof(w) = \bigsqcup_{w' \in Cof(\sigma^n(w))} X^n w'.$$

Using the graph T_w we construct a new graph \mathcal{G} with the set of vertices $Cof(\sigma^n(w))$, where two vertices v and u are adjacent if there exist $v', u' \in X^n$ such that $v'v$ and $u'u$ are adjacent in T_w . The graph \mathcal{G} is isomorphic to the tile graph $T_{\sigma^n(w)}$ under the identity map on $Cof(\sigma^n(w))$. Indeed, let v and u be adjacent in \mathcal{G} . Then there exist $v', u' \in X^n$ and $s \in S$ such that $s(v'v) = u'u$ and $s|_{v'v''} = 1$ for a finite beginning v'' of v . It follows that $s|_{v'}(v) = u$, $s|_{v'}|_{v''} = 1$, and $s|_{v'} \in S$, because of self-similarity. Therefore v and u are adjacent in $T_{\sigma^n(w)}$. Conversely, suppose $s(v) = u$ and $s|_{v''} = 1$ for some $s \in S$ and a finite beginning v'' of v . Since each element of S has an incoming edge, there exist $s' \in S$ and $v', u' \in X^n$ such that $s'(v'v) = u'u$ and $s'|_{v'v''} = 1$. Hence v and u are adjacent in the graph \mathcal{G} .

The subgraph of T_w spanned by every set of vertices $X^n w'$ for $w' \in Cof(\sigma^n(w))$ is connected, because, by assumption, the tile graphs T_n are connected. Hence, the number of infinite connected components in $T_w \setminus X^n \sigma^n(w)$ is equal to the number of infinite connected components in $T_{\sigma^n(w)} \setminus \sigma^n(w)$. In particular, this number is bounded by the size of the generating set S .

Every infinite component of $T_w \setminus X^n \sigma^n(w)$ contains at least one end. Hence the estimate

$$\#Ends(T_w) \geq ic(T_w \setminus X^n \sigma^n(w)) = ic(T_{\sigma^n(w)} \setminus \sigma^n(w))$$

holds for all n . In particular

$$\#Ends(T_w) \geq \lim_{n \rightarrow \infty} ic(T_{\sigma^n(w)} \setminus \sigma^n(w))$$

For the converse consider the ends $\gamma_1, \dots, \gamma_k$ of the graph T_w . They can be made disconnected by removing finitely many vertices. Take n large enough so that the set $X^n \sigma^n(w)$ disconnects the ends γ_i . Since every end belongs to an infinite component, we get at least k infinite components of $T_{\sigma^n(w)} \setminus \sigma^n(w)$. In particular, the number of ends is finite and the statement follows. \square

In particular, the number of ends of every tile graph T_w is not greater than the maximal degree of vertices, i.e., $\#Ends(T_w) \leq |S|$. Now let us show how to compute the number $ic(T_w \setminus w)$ in terms of the components that contain post-critical vertices. In other terms, only components of $T_n \setminus w_n$ with post-critical vertices give a positive contribution, in the limit, to the number of infinite components. In order to do that, we denote by $pc(T_n \setminus w_n)$ the number of connected components of $T_n \setminus w_n$ that contain a post-critical vertex.

Proposition 4. *Let $w = x_1x_2 \dots \in X^\omega$ be a regular or a critical sequence, then $pc(T_n \setminus w_n)$ is an eventually non-increasing sequence and*

$$ic(T_w \setminus w) = \lim_{n \rightarrow \infty} pc(T_n \setminus w_n).$$

Proof. Choose n large enough so that the subgraph T_n of T_w contains all edges of T_w adjacent to the vertex w . Notice that if a vertex v of T_n is adjacent to some vertex $s(v)$ in $T_w \setminus T_n$, then $s|_v \neq 1$ and thus v is post-critical. It follows that if C is a connected component of $T_n \setminus w_n$ without post-critical vertices, then all the edges of the graph $T_w \setminus w$ adjacent to the component C are contained in the graph $T_n \setminus w_n$. Hence C is a finite component of $T_w \setminus w$. Therefore the number of infinite components of $T_w \setminus w$ is not greater than the number of components of $T_n \setminus w_n$ that contain a post-critical vertex. It follows $ic(T_w \setminus w) \leq pc(T_{n+k} \setminus w_{n+k}) \leq pc(T_n \setminus w_n)$ for all $k \geq 1$. In fact, if v, v' are post-critical and belong to the same connected component of $T_n \setminus w_n$, then there exists a path $\{s_1, \dots, s_m\}$ connecting them such that $s_i|_{s_1 \dots s_{i-1}(v_n)} = 1$, in particular the same holds for $s_i|_{s_1 \dots s_{i-1}(v_{n+k})} = 1$, $k \geq 1$. This implies the monotonicity of $pc(T_{n+k} \setminus w_{n+k})$ for $k \geq 1$.

Suppose now that w is regular. Let C be a finite component of $T_w \setminus w$. Since C is finite, every edge inside C appears in the graph T_n for all large enough n , and thus C is a connected component of $T_n \setminus w_n$. Since C contains only regular sequences, the last statement in Proposition 1 implies that for all $s \in S$ and every vertex v in C we have $s|_{v_n} = 1$ for all large enough n . In other words, the vertex v_n of T_n is not post-critical for every vertex v in C . Therefore the component C is not counted in the number $pc(T_n \setminus w_n)$. Hence $ic(T_w \setminus w) = pc(T_n \setminus w_n)$ for all large enough n .

The same arguments work if w is critical, because every cofinality class contains not more than one critical sequence, and hence the graph $T_w \setminus w$ has no critical sequences. \square

Remark 1. With a slight modification the last proposition also works for a sequence w , which is not critical but is cofinal to some critical sequence u . In this case, we can count the number of connected components of $T_n \setminus w_n$ that contain post-critical vertices other than u_n , and then pass to the limit to get the number of infinite components in $T_w \setminus w$. Indeed, it is enough to notice that if the graph $T_n \setminus w_n$ contains a connected component C with precisely one post-critical vertex u_n for large enough n , then C is a finite component in the graph $T_w \setminus w$. Under this modification the proposition may be applied to any sequence.

Also to find the number of ends it is enough to know that the limit in Proposition 4 is valid for regular and critical sequences. For any sequence w cofinal to a critical sequence u we just consider the graph $T_w = T_u$ centered at the vertex u and apply the proposition.

Remark 2. It is not difficult to observe that one can use the same method to obtain the number $c(T_w \setminus w)$ of all connected components of $T_w \setminus w$. In particular, one has

$$c(T_w \setminus w) = \lim_{n \rightarrow \infty} c(T_n \setminus w_n).$$

3.3 Finite automaton to determine the number of components in tile graphs with a vertex removed

Using the iterative construction of tile graphs given in Theorem 2 we can provide a recursive procedure to compute the numbers $pc(T_n \setminus w_n)$. We will construct a finite deterministic (acceptor) automaton A_{ic} with the following structure: it has a unique initial state, each arrow in A_{ic} is labeled by a letter $x \in X$, each state of A_{ic} is labeled by a partition of a subset of the post-critical set \mathcal{P} . The automaton A_{ic} will have the property that, given a word $v \in X^n$, the final state of A_{ic} after reading v corresponds to the partition of the post-critical vertices of the graph T_n induced by the connected components of $T_n \setminus v$. Then $pc(T_n \setminus v)$ is just the number of parts in this partition.

We start with the following crucial consideration for the construction of the automaton A_{ic} . Let v be a vertex of the tile graph T_n . The components of $T_n \setminus v$ partition the set of post-critical vertices of T_n . Let us consider only those components that contain at least one post-critical vertex. Let $\mathcal{P}_i \subset \mathcal{P}$ be the set of all post-critical sequences, which represent post-critical vertices in i -th component. If the vertex v is not post-critical, then $\sqcup_i \mathcal{P}_i = \mathcal{P}$. Otherwise, $\sqcup_i \mathcal{P}_i$ is a proper subset of \mathcal{P} ; every sequence p in $\mathcal{P} \setminus \sqcup_i \mathcal{P}_i$ represents v , i.e., $v = p_n$ (for all large enough n the set $\mathcal{P} \setminus \sqcup_i \mathcal{P}_i$ consists of just one post-critical sequence, while for small values of n the same vertex may be represented by several post-critical sequences). In any case, we say that $\{\mathcal{P}_i\}_i$ is the *partition* (of a subset of \mathcal{P}) *induced by the vertex v* . If $T_n \setminus v$ does not contain post-critical vertices (this happens when $v = p_n$ for every $p \in \mathcal{P}$), then we say that v induce the empty partition $\{\emptyset\}$.

The set of all partitions induced by the vertices of tile graphs is denoted by Π . The set Π can be computed algorithmically. To see this, let us show how, given the partition $P = \{\mathcal{P}_i\}_i$ induced by a vertex v and a letter $x \in X$, one can find the partition $F = \{\mathcal{F}_j\}_j$ induced by the vertex vx . We will use the model graph M associated to the automaton S in Section 2.3.3, which has the vertex set $\mathcal{P} \times X$ and edges E . Recall that the set \mathcal{P} is identified with the set of post-critical vertices of M . Let us construct the auxiliary graph $M_{P,x}$ as follows: take the model graph M , add an edge between (p, x) and (q, x) for $p, q \in \mathcal{P}_i$ and every i , and add an edge between (p, y) and (q, y) for every $p, q \in \mathcal{P}$ and $y \in X, y \neq x$. Put $K = \{(p, x) : p \in \mathcal{P} \setminus \sqcup_i \mathcal{P}_i\}$. If the graph $M_{P,x} \setminus K$ contains no post-critical vertices, then we define $\{\mathcal{F}_j\}_j$ as the empty partition $\{\emptyset\}$. Otherwise, we consider the components of $M_{P,x} \setminus K$ with at least one post-critical vertex, and let $\mathcal{F}_j \subset \mathcal{P}$ be the set of all post-critical vertices/sequences in j -th component.

Lemma 2. $\{\mathcal{F}_j\}_j$ is exactly the partition induced by the vertex vx .

Proof. Let us consider the map $\varphi : M_{P,x} \rightarrow T_{n+1}$ given by $\varphi((p, y)) = p_n y$, $p \in \mathcal{P}$ and $y \in X$. This map is neither surjective, nor injective in general, nor a graph homomorphism.

However, it preserves the inflation construction of the graph T_{n+1} from the graph T_n . Namely, φ maps each subset $\mathcal{P} \times \{y\}$ into the subset $X^n y$, and the edges in E onto the edges of T_{n+1} obtained under construction (see Theorem 2). Also, by definition of post-critical vertices, the map φ sends the post-critical vertices of $M_{P,x}$ onto the post-critical vertices of T_{n+1} .

Note that the set K is exactly the preimage of the vertex vx under φ . Therefore we can consider the restriction $\varphi : M_{P,x} \setminus K \rightarrow T_{n+1} \setminus vx$.

For every $y \in X$, $y \neq x$ all vertices in $\mathcal{P} \times \{y\}$ belong to the same component of $M_{P,x} \setminus K$, and φ maps these vertices to the same component of $T_{n+1} \setminus vx$, because the subgraph of T_{n+1} induced by the set of vertices $X^n y$ contains the graph T_n , which is connected. For each i the vertices in $\mathcal{P}_i \times \{x\}$ are mapped to the same component of the graph $T_{n+1} \setminus vx$, because its subgraph induced by the vertices $X^n x \setminus vx$ contains the graph $T_n \setminus v$ and \mathcal{P}_i is its connected component. It follows that, if two post-critical vertices p and q can be connected by a path $p = v_0, v_1, \dots, v_m = q$ in $M_{P,x} \setminus K$, then for every i the vertices $\varphi(v_i)$ and $\varphi(v_{i+1})$ belong to the same component of $T_{n+1} \setminus vx$, and therefore the post-critical vertices $\varphi(p)$ and $\varphi(q)$ lie in the same component. Conversely, suppose $\varphi(p)$ and $\varphi(q)$ can be connected by a path γ in $T_{n+1} \setminus vx$. We can subdivide γ as $\gamma_1 e_1 \gamma_2 e_2 \dots e_m \gamma_{m+1}$, where $e_i \in \varphi(E)$ and each subpath γ_i is a path in a copy of T_n inside T_{n+1} . The preimages of the end points of each e_i belong to the same component in $M_{P,x} \setminus K$. Therefore p and q lie in the same component in $M_{P,x} \setminus K$. The statement follows. \square

It follows that we can find the set Π algorithmically as follows. Note that the empty partition $\{\emptyset\}$ is always an element of Π (it is induced by the unique vertex of the tile T_0 of zero level). We start with $\{\emptyset\}$ and for each letter $x \in X$ construct new partition $\{\mathcal{F}_j\}_j$ as above. We repeat this process for each new partition until no new partition is obtained. Since the set \mathcal{P} is finite, the process stops in finite time. Then Π is exactly the set of all obtained partitions.

We construct the (acceptor) automaton A_{ic} over the alphabet X on the set of states Π with the the unique initial state $\{\emptyset\} \in \Pi$. The transition function is given by the rule: for $\{\mathcal{P}_i\}_i \in \Pi$ and $x \in X$ we put $\{\mathcal{P}_i\}_i \xrightarrow{x} \{\mathcal{F}_j\}_j$, where $\{\mathcal{F}_j\}_j$ is defined as above. The automaton A_{ic} has all the properties we described at the beginning of this subsection: given a word $v \in X^*$, the final state of A_{ic} after accepting v is exactly the partition induced by the vertex v . Since we are interested in the number $pc(T_n \setminus v)$ of components in $T_n \setminus v$ containing post-critical vertices, we can label every state of A_{ic} by the number of components in the corresponding partition. We get the following statement.

Theorem 5. *The graph $T_{|v|} \setminus v$ has k components containing a post-critical vertex if and only if the final state of the automaton A_{ic} after accepting the word v is labeled by the number k . In particular, for every k the set $C(k)$ of all words $v \in X^*$ such that the graph $T_{|v|} \setminus v$ has k connected components containing a post-critical vertex is a regular language recognized by the automaton A_{ic} .*

Similarly, we construct a finite deterministic acceptor automaton A_c for computing the number of all components in tile graphs with a vertex removed. The states of the

automaton A_c will be pairs of the form $(\{\mathcal{P}_i\}_i, m)$, where $\{\mathcal{P}_i\}_i \in \Pi$ and m is a non-negative integer number, which will count the number of connected components without post-critical vertices. We start with the state $(\{\emptyset\}, 0)$, which is the unique initial state of A_c , and consequently construct new states and arrows as follows. Let $(P = \{\mathcal{P}_i\}_i, m)$ be a state already constructed. For each $x \in X$ we take the graph $M_{P,x} \setminus K$ constructed above, define $\{\mathcal{F}_j\}_j$ as above, and put m_x to be equal to the number of connected components in $M_{P,x} \setminus K$ without post-critical vertices. If $(\{\mathcal{F}_j\}_j, m + m_x)$ is already a state of A_c , then we put an arrow labeled by x from the state $(\{\mathcal{P}_i\}_i, m)$ to the state $(\{\mathcal{F}_j\}_j, m + m_x)$. Otherwise, we introduce $(\{\mathcal{F}_j\}_j, m + m_x)$ as a new state and put this arrow. We repeat this process for each new state until no new state is obtained. Since the number of all components in $T_n \setminus v$ is not greater than $|S|$, the number m cannot exceed $|S|$, and the construction stops in finite time.

The automaton A_c has the following property: given a word $v \in X^*$, the final state of A_c after accepting the word v is exactly the pair $(\{\mathcal{P}_i\}_i, m)$, where $\{\mathcal{P}_i\}_i$ is the partition induced by v and m is the number of components in $T_{|v|} \setminus v$ without post-critical vertices. Since we are interested only in the number $c(T_n \setminus v)$ of all components of $T_n \setminus v$, we label every state $(\{\mathcal{P}_i\}_i, m)$ of the automaton A_c by the number $k + m$, where k is the number of sets in the partition $\{\mathcal{P}_i\}_i$. We get the following statement.

Proposition 6. *The graph $T_{|v|} \setminus v$ has k components if and only if the final state of the automaton A_c after accepting the word v is labeled by the number k . In particular, for every k the set $C(k)$ of all words $v \in X^*$ such that the graph $T_{|v|} \setminus v$ has k connected components is a regular language recognized by the automaton A_c .*

We need the following properties of vertex labels in the automata A_{ic} and A_c .

Lemma 3. *1. In every strongly connected component of the automata A_{ic} and A_c all states are labeled by the same number.*

2. All strongly connected components of the automaton A_{ic} without outgoing arrows are labeled by the same number.

Proof. 1. Suppose that there is a strongly connected component with two states labeled by different numbers. It would imply that there exists an infinite word such that the corresponding path in the automaton passes through each of these states infinite number of times. We get a contradiction with Proposition 4, because the sequences $pc(T_n \setminus w_n)$ and $c(T_n \setminus w_n)$ are eventually monotonic (for the last one the proof is the same).

2. Suppose there are two strongly connected components in the automaton A_{ic} without outgoing arrows which are labeled by different numbers. Let v and u be finite words such that starting at the initial state of A_{ic} we end at the first and the second components respectively. Then for the infinite sequence $vuvu \dots$ the limit in Proposition 3 does not exist, and we get a contradiction. \square

Proposition 4 together with Theorem 5 imply the following method to find the number of infinite components in $T_w \setminus w$ for $w \in X^\omega$.

Proposition 7. *Let $w = x_1x_2\dots \in X^\omega$ be a regular or critical sequence. The number of infinite connected components in $T_w \setminus w$ is equal to the label of a strongly connected component of A_{ic} that is visited infinitely often, when the automaton reads the sequence w .*

3.4 The number of ends of tile graphs

The characterization of the number of infinite components in the graph $T_w \setminus w$ together with Proposition 3 allows us to describe the number of ends of T_w .

Since every critical sequence w is periodic, we can algorithmically find the number of ends of the graph T_w using Proposition 3 and the automaton A_{ic} . Now we introduce some notations. Fix $k \geq 1$ and let $EC_{=k}$ be the union of cofinality classes of critical sequences w whose tile graph T_w has k ends. Similarly we define the sets $EC_{>k}$ and $EC_{<k}$. Let

- $A_{ic}(k)$ be the subgraph of A_{ic} spanned by the strongly connected components labeled by numbers $\geq k$;
- $\mathcal{R}_{\geq k}$ be the one-sided sofic subshift given by the graph $A_{ic}(k)$, i.e., $\mathcal{R}_{\geq k}$ is the set of all sequences that can be read along right-infinite paths in $A_{ic}(k)$ starting at any state;
- $E_{\geq k}$ be the set of all sequences which are cofinal to some sequence from $\mathcal{R}_{\geq k}$. Since the set $\mathcal{R}_{\geq k}$ is shift-invariant, the set $E_{\geq k}$ coincides with $X^*\mathcal{R}_{\geq k} = \{vw \mid v \in X^*, w \in \mathcal{R}_{\geq k}\}$.

Theorem 8. *The tile graph T_w has $\geq k$ ends if and only if $w \in E_{\geq k} \setminus EC_{<k}$. Hence, the tile graph T_w has k ends if and only if $w \in E_{\geq k} \setminus (E_{\geq k+1} \cup EC_{>k} \cup EC_{<k})$.*

Proof. We need to prove that for a regular sequence w the graph T_w has at least k ends if and only if $w \in E_{\geq k}$. First, suppose $w \in E_{\geq k}$. Then w is cofinal to a sequence $w' \in \mathcal{R}_{\geq k}$, which is also regular. The sequences w and w' belong to the same tile graph $T_w = T_{w'}$. There exists a finite word v such that for the sequence vw' the corresponding path in A_{ic} starting at the initial state eventually lies in the subgraph $A_{ic}(k)$. Then the graph $T_{vw'} \setminus vw'$ has $\geq k$ infinite components by Proposition 4. Using the correspondence between infinite components of $T_{w'} \setminus w'$ and of $T_{vw'} \setminus X^{|v|}w'$ shown in the proof of Proposition 3 we get that the graph $T_{w'} \setminus w'$ has $\geq k$ infinite components, and hence $T_{w'} = T_w$ has $\geq k$ ends.

For the converse, suppose the graph T_w has $\geq k$ ends and the sequence w is regular. Then $ic(T_{\sigma^n(w)} \setminus \sigma^n(w)) \geq k$ for some n by Propositions 3 and 4. Hence some shift $\sigma^n(w)$ of the sequence w is in $\mathcal{R}_{\geq k}$ and thus $w \in E_{\geq k}$. \square

Example with $IMG(z^2+i)$ in Section 5 shows that we cannot expect to get a description using subshifts of finite type, and indeed the description using sofic subshifts is the best possible in these settings.

3.5 From ends of tile graphs to ends of Schreier graphs

Now we can describe how to derive the number of ends of Schreier graphs from the number of ends of tile graphs.

Proposition 9. 1. *The Schreier graph Γ_w coincides with the tile graph T_w for every regular sequence $w \in X^\omega$.*

2. *Let $w \in X^\omega$ be a critical sequence, and let $O(w)$ be the set of all critical sequences $v \in X^\omega$ such that $g(w) = v$ for some $g \in G$. The Schreier graph Γ_w is constructed by taking the disjoint union of the orbital tile graphs T_v for $v \in O(w)$ and connecting two critical sequences $v_1, v_2 \in O(w)$ by an edge whenever $s(v_1) = v_2$ for some $s \in S$.*

Proof. 1. If the point w is regular, then the set of vertices of Γ_w is the cofinality class $Cof(w)$, which is the set of vertices of T_w by Proposition 1. Suppose there is an edge between v and u in the graph Γ_w . Then $s(v) = u$ for some $s \in S$. Since the sequence w is regular, all the sequences in $Cof(w)$ are regular, and hence there exists a finite beginning v' of v such that $s|_{v'} = 1$. Hence there is an edge between v and u in the tile graph T_w .

2. If the point w is critical, then the set of vertices of Γ_w is the union of cofinality classes $Cof(v)$ for $v \in O(w)$. Consider an edge $s(v_1) = v_2$ in Γ_w . If this is not an edge of T_v for $v \in O(w)$, then the restriction of s on every beginning of v_1 is not trivial. Hence v_1, v_2 are critical, and this edge was added under construction. \square

The following corollary summarizes the relation between the number of ends of the Schreier graphs Γ_w with the number of ends of the tile graphs T_w . It justifies the fact that, for our aims, it was enough to study the number of ends and connected components in the tile graphs.

Corollary 10. 1. *If w is a regular sequence, then $\#Ends(\Gamma_w) = \#Ends(T_w)$.*

2. *If w is critical, then*

$$\#Ends(\Gamma_w) = \sum_{w' \in O(w)} \#Ends(T_{w'}),$$

where the set $O(w)$ is from Proposition 9.

Using the automata \mathbf{A}_c and \mathbf{A}_{ic} one can construct similar automata for the number of components in the Schreier graphs Γ_n with a vertex removed. For every state of \mathbf{A}_c or \mathbf{A}_{ic} take the corresponding partition of the post-critical set and combine components according to the edges $E(\Gamma \setminus T)$ described in the last paragraph in Section 2.3. For example, if $\{\mathcal{P}_i\}_i$ is a state of \mathbf{A}_{ic} , then we glue every two components \mathcal{P}_s and \mathcal{P}_t if $\{p, q\} \in E(\Gamma \setminus T)$ for some $p \in \mathcal{P}_s$ and $q \in \mathcal{P}_t$. We get a new partition, and we label the state by the number of components in this partition. Basically, we get the same automata, but vertices may be labeled in a different way.

A case of special interest is when all Schreier graphs have one end. In our settings of groups generated by bounded automata, our construction enables us to find a necessary and sufficient condition when all Schreier graphs Γ_w have one end.

Theorem 11. *All orbital Schreier graphs Γ_w for $w \in X^\omega$ have one end if and only if the following two conditions hold:*

1. *all arrows along directed cycles in the automaton S are labeled by $x|x$ for some $x \in X$ (depending on an arrow);*
2. *all strongly connected components of the automaton A_{ic} are labeled by 1 (partitions consisting of one part).*

Proof. Let us show that the first condition is equivalent to the property that for every $w \in X^\omega$ the Schreier graph Γ_w and tile graph T_w coincide. If there exists a directed cycle that does not satisfy condition 1, then there exist two different critical sequences w, w' that are connected in the Schreier graph, i.e., $s(w) = w'$ for some $s \in S$. In this case $\Gamma_w \neq T_w$, because by Proposition 1 different critical sequences are non-cofinal, and therefore belong to different tile graphs. And vice versa, the existence of such critical sequences contradicts condition 1. Therefore condition 1 implies $O(w) = \{w\}$ for every critical sequence w , and thus $\Gamma_w = T_w$ by Proposition 9.

Theorem 8 implies that condition 2 is equivalent to the statement that every tile graph T_w has one end. Therefore, if the conditions 1 and 2 hold, then any Schreier graph coincides with the corresponding tile graph which has one end.

Conversely, Proposition 9 implies that if the Schreier graph Γ_w for a critical sequence w does not coincide with the corresponding tile graph T_w , then the number of ends of Γ_w is greater than one. (The graph Γ_w is a disjoint union of more than one infinite tile graphs T_v , $v \in O(w)$ connected by a finite number of edges.) Therefore, if all Schreier graphs Γ_w have one end, then they should coincide with tile graphs (condition 1 holds) and tile graphs have one end (condition 2 holds). \square

Remark 3. The Hanoi Towers group $H^{(3)}$ [18] is an example of a group generated by a bounded automaton for which all orbital Schreier graphs Γ_w have one end. On the other hand, this group is not indicable (since its abelianization is finite) but can be projected onto the infinite dihedral group [14]. This implies that it contains a normal subgroup N such that the Schreier coset graph associated with N has two ends. Clearly, for what said above, N does not coincide with the stabilizer of w for any $w \in X^\omega$.

3.6 The number of infinite components of tile graphs almost surely

The structure of the automaton A_{ic} allows to get results about the measure of infinite sequences $w \in X^\omega$ for which the tile graphs $T_w \setminus w$ have a given number of infinite components. We recall that the space X^ω is endowed with the uniform measure.

Remark 4. It is useful to notice that we can construct a finite word $u \in X^*$ such that starting at any state of the automaton A_{ic} and following the word u we end in some strongly connected component without outgoing edges. If these strongly connected components

correspond to the partition of the post-critical set on k parts, then it follows that $pc(T_n \setminus v_1uv_2) = k$ for all words $v_1, v_2 \in X^*$ with $|v_1uv_2| = n$. In other words, $pc(T_n \setminus v) = k$ for every v that contains u as a subword.

By Proposition 4 we get the description of sequences which correspond to infinite components using the automaton A_{ic} (but only for regular and critical sequences).

Corollary 12. *The number of infinite connected components of the graph $T_w \setminus w$ is almost surely the same for all sequences $w \in X^\omega$. This number coincides with the label of the strongly connected components of the automaton A_{ic} without outgoing arrows.*

Proof. The measure of non-regular sequences is zero. For regular sequences $w \in X^\omega$ we can use the automaton A_{ic} to find the number $ic(T_w \setminus w)$. Then the corollary follows from Lemma 3 item 2 and the standard fact that the measure of all sequences that are read along paths in a strongly connected component with an outgoing arrow is zero (for example, this fact follows from the observation that the adjacency matrix of such a component has spectral radius less than $|X|$). Another explanation comes from Remark 4 and the fact that the set of all sequences $w \in X^\omega$ that contain a fixed word as a subword is of full measure. \square

The corollary does not hold for the number of all connected components of $T_w \setminus w$, see examples in Section 5. However, given any number k we can use the automaton A_c to compute the measure of the set $C(k)$ of all sequences $w \in X^\omega$ such that the graph $T_w \setminus w$ has k components. As shown in the previous proof only strongly connected components without outgoing arrows contribute the set of sequences with a non-zero measure. Let Λ_k be the collection of all strongly connected components of A_c without outgoing arrows and labeled by the number k . Let V_k be the set of finite words $v \in X^*$ with the property that starting at the initial state and following arrows labeled by v we end at a component from Λ_k , and any prefix of v does not satisfy this property. Then the measure of $C(k)$ is equal to the sum $\sum_{v \in V_k} |X|^{-|v|}$. Since the automaton A_c is finite, this measure is always a rational number and can be computed algorithmically.

3.7 The number of ends almost surely

Corollary 12 together with Proposition 3 imply that the tile graphs T_w (and thus the Schreier graphs Γ_w) have almost surely the same number of ends, and that this number is equal to the label of the strongly connected components of A_{ic} without outgoing arrows. As was mentioned in introduction, this fact actually holds for any finitely generated self-similar group, which acts transitively on the levels X^n for all $n \in \mathbb{N}$ (see Proposition 6.10 in [1]). In our setting of bounded automata we get a stronger description of the sequences w for which the tile graph T_w has non-typical number of ends.

Proposition 13. *There are only finitely many Schreier graphs Γ_w and tile graphs T_w with more than two ends.*

Proof. Let us prove that the graph $T_w \setminus w$ can have more than two infinite components only for finitely many sequences $w \in X^\omega$. Suppose not and choose sequences $w^{(1)}, \dots, w^{(m)}$ such that $ic(T_{w^{(i)}} \setminus w^{(i)}) \geq 3$, where we take m larger than the number of partitions of the post-critical set \mathcal{P} . Choose level n large enough so that all words $w_n^{(1)}, \dots, w_n^{(m)}$ are different and $pc(T_n \setminus w_n^{(i)}) \geq 3$ for all i (it is possible by Proposition 4). Notice that since the graph T_n is connected, the deletion of different vertices $w^{(i)}$ produces different partitions of \mathcal{P} . Indeed, if $\mathcal{P} = \sqcup_{i=1}^k \mathcal{P}_i$ with $k \geq 3$ is the partition we got after removing some vertex v , then some $k - 1$ sets \mathcal{P}_i will be in the same component of the graph $T_n \setminus u$ for any other vertex u (these $k - 1$ sets will be connected through the vertex v). We get a contradiction with the choice of number m .

It follows that there are only finitely many tile graphs with more than two ends. This also holds for Schreier graphs by Proposition 9. \square

Corollary 14. *The Schreier graphs Γ_w and tile graphs T_w can have more than two ends only for pre-periodic sequences w .*

Proof. Since the graph $T_w \setminus w$ can have more than two infinite components only for finitely many sequences w , we get that, in the limit in Proposition 3, the sequence $\sigma^n(w)$ attains a finite number of values. Hence w is pre-periodic. \square

Example with $IMG(z^2 + i)$ in Section 5 shows that the Schreier graph Γ_w and the tile graph T_w may have more than two ends even for regular sequences w .

Corollary 15. *The tile graphs T_w and Schreier graphs Γ_w have the same number of ends for almost all sequences $w \in X^\omega$, and this number is equal to one or two.*

3.8 Two ends almost surely

In this section we describe bounded automata for which Schreier graphs Γ_w and tile graphs T_w have almost surely two ends. Notice that in this case the post-critical set \mathcal{P} cannot consist of one element (actually, every finitely generated self-similar group with $|\mathcal{P}| = 1$ is finite and cannot act transitively on X^n for all n).

Lemma 4. *If the Schreier graphs Γ_w (equivalently, the tile graphs T_w) have two ends for almost all $w \in X^\omega$, then $|\mathcal{P}| = 2$.*

Proof. We pass to a power of the alphabet so that every post-critical sequence is of the form $y^{-\omega}$ or $y^{-\omega}x$ for some letters $x, y \in X$ and different post-critical sequences end with different letters. In particular, every subset $\mathcal{P} \times \{x\}$ for $x \in X$ of the model graph M contains at most one post-critical vertex of M .

We again pass to a power of the alphabet so that for every nontrivial element $s \in S$ there exists a letter $x \in X$ such that $s(x) \neq x$ and $s|_x = 1$. Then every post-critical sequence $p \in \mathcal{P}$ appears in some edge $\{(p, *), (*, *)\}$ of the model graph. Indeed, if the pair $p|q$ is read along a left-infinite path in the automaton $S \setminus \{1\}$ that ends in a nontrivial state s , then the pair $\{(p, x), (q, s(x))\}$ belongs to the edge set E of the graph M .

Now suppose that tile graphs have almost surely two ends. Then the strongly connected components without outgoing arrows in the automaton A_{ic} correspond to the partitions of the post-critical set \mathcal{P} on two parts (see Corollary 12). In particular, there is no state corresponding to the partition of \mathcal{P} with one part, because such a partition would form a strongly connected component without outgoing arrows (see the construction of A_{ic}). We will use the fact that all paths in the automaton A_{ic} starting at any partition $\mathcal{P} = \mathcal{P}_1 \sqcup \mathcal{P}_2$ end in partitions of \mathcal{P} on two parts (we cannot get more parts).

Let us construct an auxiliary graph \overline{M} as follows: take the model graph M and for each $x \in X$ add edges between all vertices in the subset $\mathcal{P} \times \{x\}$. We will prove that the graph \overline{M} is an “interval”, i.e., there are two vertices of degree one and the other vertices have degree two, and that two end vertices of \overline{M} are the only post-critical vertices. First, let us show that there are only two subsets $\mathcal{P} \times \{x\}$ for $x \in X$ such that the graph $\overline{M} \setminus \mathcal{P} \times \{x\}$ is connected. Suppose that there are three such subsets $\mathcal{P} \times \{x\}$, $\mathcal{P} \times \{y\}$, $\mathcal{P} \times \{z\}$.

Fix any partition $\mathcal{P} = \mathcal{P}_1 \sqcup \mathcal{P}_2$ that corresponds to some state of the automaton A_{ic} . Consider the arrow in the automaton A_{ic} starting at $\mathcal{P}_1 \sqcup \mathcal{P}_2$ and labeled by x . This arrow ends in the partition $\mathcal{P} = \mathcal{P}_1^{(x)} \sqcup \mathcal{P}_2^{(x)}$ with two parts. Recall how we construct the partition $\mathcal{P}_1^{(x)} \sqcup \mathcal{P}_2^{(x)}$ using the graph $M_{\mathcal{P}_1 \sqcup \mathcal{P}_2, x}$, and notice that $M_{\mathcal{P}_1 \sqcup \mathcal{P}_2, x} \setminus \mathcal{P} \times \{x\}$ coincides with $\overline{M} \setminus \mathcal{P} \times \{x\}$. Using the assumption that the graph $\overline{M} \setminus \mathcal{P} \times \{x\}$ is connected, we get that one of the sets $\mathcal{P}_i^{(x)}$ is a subset of $\mathcal{P} \times \{x\}$. Since $\mathcal{P} \times \{x\}$ contains at most one post-critical vertex, the part $\mathcal{P}_i^{(x)}$ consists of precisely one element (post-critical vertex), which we denote by $a \in \mathcal{P}$, i.e., here $\mathcal{P}_i^{(x)} = \{a\}$. By the same reason the subsets $\mathcal{P} \times \{y\}$ and $\mathcal{P} \times \{z\}$ also contain some post-critical vertices b and c . Notice that the last letters of the sequences a, b, c are x, y, z respectively. We can suppose that the sequences az and bz are different from the sequence c (over three post-critical sequences there are always two with this property). Consider the arrow in the automaton A_{ic} starting at the partition $\mathcal{P}_1^{(x)} \sqcup \mathcal{P}_2^{(x)} = \{a\} \sqcup \mathcal{P} \setminus \{a\}$ and labeled by z . This arrow should end in the partition of \mathcal{P} on two parts. Since az and c are different, the post-critical vertex c of $M_{\mathcal{P}_1 \sqcup \mathcal{P}_2, x}$ belongs to the subset $(\mathcal{P} \setminus \{a\}) \times \{z\}$. Further, since c is the unique post-critical vertex in $\mathcal{P} \times \{z\}$, there should be no edges connecting the subset $(\mathcal{P} \setminus \{a\}) \times \{z\}$ with its outside in the graph $M_{\mathcal{P}_1 \sqcup \mathcal{P}_2, x}$ (otherwise all post-critical vertices will be in the same component). Hence the only edges of the graph \overline{M} going outside the subset $\mathcal{P} \times \{z\}$ should be at the vertex (a, z) . Applying the same arguments to the partition $\{b\} \sqcup \mathcal{P} \setminus \{b\}$, we get that this unique vertex should be (b, z) . Hence $a = b$ and we get a contradiction.

So let $\mathcal{P} \times \{x\}$ and $\mathcal{P} \times \{y\}$ be the two subsets such that their complements in the graph \overline{M} are connected. Let a and b be the post-critical vertices in $\mathcal{P} \times \{x\}$ and $\mathcal{P} \times \{y\}$ respectively. By the same arguments as above, the subset $\mathcal{P} \times \{x\}$ has a unique vertex which is adjacent to a vertex from $\overline{M} \setminus \mathcal{P} \times \{x\}$, and this vertex is of the form (a, x) or (b, x) . The same holds for the subset $\mathcal{P} \times \{y\}$. Every other component $\mathcal{P} \times \{z\}$ contains precisely two vertices (a, z) and (b, z) , which have edges going outside the component $\mathcal{P} \times \{z\}$. However every post-critical sequence appears in one of such edges (see our assumption in the second paragraph of the proof). Hence the post-critical set contains precisely two elements and the structure of the graph \overline{M} follows. \square

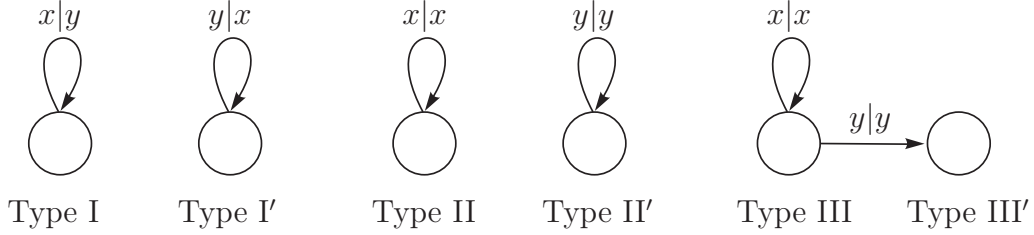

Figure 1: Bounded automata with $|\mathcal{P}| = 2$

Corollary 16. *If the post-critical set \mathcal{P} contains at least three sequences, then the Schreier graphs Γ_w and tile graphs T_w have almost surely one end.*

The following example shows that almost all Schreier graphs may have two ends for a contracting group generated by a non-bounded automaton, i.e., by an automaton with infinite post-critical set.

Example 1. Consider the self-similar group G over $X = \{0, 1, 2\}$ generated by the transformation a , which is given by the recursion $a = (a^2, 1, a^{-1})(0, 1, 2)$ (see Example 7.6 in [4]). The group G is self-replicating and contracting with nucleus $\mathcal{N} = \{1, a^{\pm 1}, a^{\pm 2}\}$, but the generating automaton is not bounded and the post-critical set is infinite. Every Schreier graph Γ_w with respect to the generating set $\{a, a^{-1}\}$ is a line and has two ends.

Theorem 17. *Almost all Schreier graphs Γ_w (equivalently, tile graphs T_w) have two ends if and only if the automaton S brought to the basic form (see Section 2.3) is one of the following.*

1. *The automaton S consists of the adding machine, its inverse, and the trivial element, where the adding machine is an element of type I with a transitive action on X (see Figure 1, where all edges not shown in the figure go to the identity state, and the letters x and y are different).*
2. *There exists an order on the alphabet $X = \{x = x_1, x_2, \dots, x_m = y\}$ such that one of the following cases holds.*
 - (a) *The automaton S consists of elements of types II and II' (see Figure 1); every pair $\{x_{2i}, x_{2i+1}\}$ is an orbit of the action of some element of type II and all nontrivial orbits of such elements on X are of this form; also every pair $\{x_{2i-1}, x_{2i}\}$ is an orbit of the action of some element of type II' and all nontrivial orbits of such elements on X are of this form (in particular, $|X|$ is an odd number).*
 - (b) *The automaton S consists of elements of types II, III, and III'; every pair $\{x_{2i}, x_{2i+1}\}$ is an orbit of the action of some element of type II or III and all nontrivial orbits of such elements on X are of this form; also every pair $\{x_{2i-1}, x_{2i}\}$ is an orbit of the action of some element of type III' and all nontrivial orbits of such elements on X are of this form (in particular, $|X|$ is an even number).*

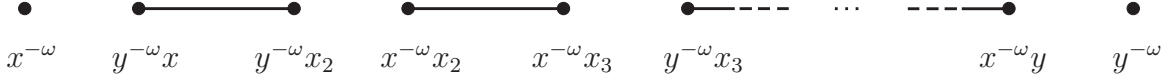

Figure 2: Case 2 (a)

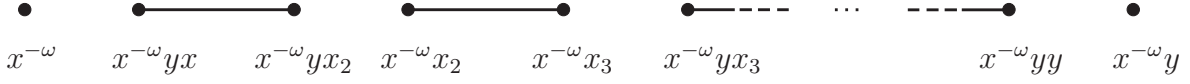

Figure 3: Case 2 (b)

Moreover, in this case, all Schreier graphs Γ_w are lines except for two Schreier graphs Γ_{x^ω} and Γ_{y^ω} in Case 2 (a), and one Schreier graph Γ_{x^ω} in Case 2 (b), which are rays.

Proof. Recall the definition of the basic form of a bounded automaton from Section 2.3. If a bounded automaton is in the basic form, its post-critical set has size two, and every state has an incoming arrow, then it is not hard to see that the automaton can contain only the states of six types shown in Figure 1.

We will be using the fact proved in Lemma 4 that the modified model graph \overline{M} is an interval. There are two cases that we need to treat a little bit differently depending on whether both post-critical sequences are periodic or not.

Consider the case when both post-critical sequences are periodic, here $\mathcal{P} = \{x^{-\omega}, y^{-\omega}\}$. In this case the automaton S can contain only the states of types I, I', II, and II'. Suppose there is a state a of type I. It contributes the edges $\{(x^{-\omega}, z), (y^{-\omega}, a(z))\}$ to the graph \overline{M} for every $z \in X$. If there exists a nontrivial orbit of the action of a on X , which does not contain x , then it contributes a cycle to the graph \overline{M} . If there exists a fixed point $a(z) = z$, then under construction of the automaton A_{ic} starting at the partition $\mathcal{P} = \{x^{-\omega}\} \sqcup \{y^{-\omega}\}$ and following the arrow labeled by z we get a partition with one part. Hence the element a should act transitively on X (it is the adding machine). Every other element of type I should have the same action on X , and hence coincide with a , otherwise we would get a vertex in the graph \overline{M} of degree ≥ 3 . Every element b of type I' contributes the edges $\{(x^{-\omega}, b(z)), (y^{-\omega}, z)\}$ to the graph \overline{M} . It follows that the action of b on X is the inverse of the action of a (otherwise we would get a vertex of \overline{M} of degree ≥ 3), and hence b is the inverse of a . If the automaton S additionally contains a state of type II or II', then there is an edge $\{(x^{-\omega}, z_1), (x^{-\omega}, z_2)\}$ or $\{(y^{-\omega}, z_1), (y^{-\omega}, z_2)\}$ in the graph \overline{M} for some different letters $z_1, z_2 \in X$. We get a vertex of degree ≥ 3 , contradiction. Hence, in this case, the automaton S consists of the adding machine, its inverse, and the identity state.

Suppose S does not contain states of types I and I'. Since the post-critical set is equal to $\mathcal{P} = \{x^{-\omega}, y^{-\omega}\}$ the automaton S contains states a and b of types II and II' respectively. These elements contribute edges $\{(x^{-\omega}, z), (x^{-\omega}, a(z))\}$ and $\{(y^{-\omega}, z), (y^{-\omega}, b(z))\}$ to the graph \overline{M} . Since the graph \overline{M} should be an interval, these edges should consequently connect all components $\mathcal{P} \times z$ for $z \in X$ (see Figure 2). It follows that there exists an order on the alphabet such that item (a) holds.

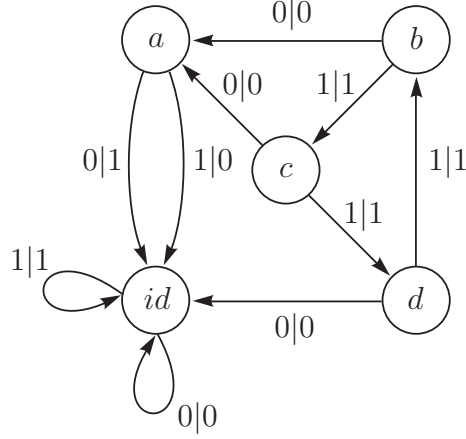

Figure 4: The generating automaton of the Grigorchuk group

Consider the case $\mathcal{P} = \{x^{-\omega}, x^{-\omega}y\}$. In this case the automaton S can consist only of states of types II, III and III'. Each state of type II or III contributes edges $\{(x^{-\omega}, z), (x^{-\omega}, a(z))\}$ to the graph \overline{M} . Each state of type III' contributes edges $\{(x^{-\omega}y, z), (x^{-\omega}y, b(z))\}$. These edges should consequently connect all components $\mathcal{P} \times z$ for $z \in X$ (see Figure 3). It follows that there exists an order on the alphabet such that item (b) holds.

For the converse, one can directly check the following facts. In item 1, every Schreier graph $\Gamma_w(G, S)$ is a line. In Case 2 (a), the Schreier graphs Γ_{x^ω} and Γ_{y^ω} are rays, while all the other Schreier graphs are lines. In Case 2 (b), the Schreier graph Γ_{x^ω} is a ray, while all the other Schreier graphs are lines. \square

Example 2. Dihedral group

Example 3. The Grigorchuk group is a nontrivial example satisfying the conditions of the theorem. It is generated by the automaton S shown in Figure 4. After passing to the alphabet $\{0, 1\}^3 \leftrightarrow X = \{0, 1, 2, 3, 4, 5, 6, 7\}$, the automaton S consists of the trivial state and the elements a, b, c, d , which are given by the following recursions:

$$\begin{aligned}
 a &= (1, 1, 1, 1, 1, 1, 1, 1)(0, 4)(1, 5)(2, 6)(3, 7) \\
 b &= (1, 1, 1, 1, 1, 1, 1, b)(0, 2)(1, 3)(4, 5) \\
 c &= (1, 1, 1, 1, 1, 1, a, c)(0, 2)(1, 3) \\
 d &= (1, 1, 1, 1, 1, 1, a, d)(4, 5)
 \end{aligned}$$

We see that this automaton satisfies Case 2 (b) of the theorem when we choose the order 6, 2, 0, 4, 5, 1, 3, 7 on X . The Schreier graph Γ_{7^ω} is a ray, while the other orbital Schreier graphs are lines.

In what follows below, we give an algebraic characterization of the automaton groups acting on the binary tree, whose orbital Schreier graphs have two ends. It turns out that

such groups are those whose nuclei are given by the automata defined by Šunić in [28]. In order to show this correspondence we sketch the construction of the groups $G_{\omega,\rho}$ as in [28].

Let A and B be the abelian groups $\mathbb{Z}/2\mathbb{Z}$ and $(\mathbb{Z}/2\mathbb{Z})^k$ respectively. We think of A as the field of 2 elements and of B as the k -dimensional vector space over this field. Let $\rho : B \rightarrow B$ be an automorphism of B and $\omega : B \rightarrow A$ a surjective homomorphism. We define the action of elements of A and B on the binary tree $\{0, 1\}^*$ as follows: the nontrivial element $a \in A$ only changes the first letter of input words, i.e., $a = (1, 1)(0, 1)$; the action of $b \in B$ is given by the recursive rule $b = (\omega(b), \rho(b))$. The automorphism group generated by the action of A and B is denoted by $G_{\omega,\rho}$. Notice that the group $G_{\omega,\rho}$ is generated by a bounded automaton over the binary alphabet $X = \{0, 1\}$, which we denote by $A_{\omega,\rho}$. If the action of B is faithful, the group $G_{\omega,\rho}$ can be given by an invertible polynomial over the field with two elements, which corresponds to the action of ρ on B . Examples include the infinite dihedral group D_∞ given by polynomial $x + 1$ and the Gigorchuk group given by polynomial $x^2 + x + 1$.

The following result puts in relation the groups $G_{\omega,\rho}$ and the groups whose Schreier graphs have almost surely two ends.

Theorem 18. *Let G be a group generated by a bounded automaton over the binary alphabet $X = \{0, 1\}$. Almost all Schreier graphs $\Gamma_w(G)$ have two ends if and only if the nucleus of G either consists of the adding machine, its inverse and the identity element, or is equal to one of the automata $A_{\omega,\rho}$ up to switching the letters $0 \leftrightarrow 1$ of the alphabet.*

Proof. Suppose that the Schreier graphs $\Gamma_w(G)$ have two ends for almost all sequences $w \in X^\omega$ and let \mathcal{N} be the nucleus of the group G . By Lemma 4 the post-critical set \mathcal{P} of the group contains exactly two elements. If both post-critical elements are periodic, then the nucleus \mathcal{N} consists of the adding machine, its inverse and the identity element (see the proof of Theorem 17).

Let us consider the case $\mathcal{P} = \{x^{-\omega}, x^{-\omega}y\}$. We can assume that $x = 1$ and $y = 0$ so that $\mathcal{P} = \{1^{-\omega}, 1^{-\omega}0\}$. It follows that every arrow along a cycle in \mathcal{N} is labeled by $1|1$ except for a loop at the trivial state labeled by $0|0$. The nucleus \mathcal{N} contains only one nontrivial finitary element, namely $a = (1, 1)(0, 1)$, since otherwise there would be a post-critical sequence with preperiod of length two.

Put $A = \{1, a\}$ and $B = \mathcal{N} \setminus \{a\}$. The set B consists exactly of those elements from G that belong to cycles. For every $b \in B$ we have $b(1) = 1$ and $b|_1 \in B$, $b|_0 \in A$. It follows that all nontrivial elements of B have order two. Let us show that B is a subgroup of G . For any $b_1, b_2 \in B$ there exists k such that $b_i|_{1^k} = b_i$ for $i = 1, 2$. Hence $b_1b_2|_{1^k} = b_1b_2$. Therefore b_1b_2 belongs to the nucleus \mathcal{N} and thus $b_1b_2 \in B$. It follows that B is a group, which is isomorphic to $(\mathbb{Z}/2\mathbb{Z})^m$ for certain m . The map $\rho : b \mapsto b|_1$ is a homomorphism from B to B and is bijective, because elements of B form cycles in the nucleus. The map $\omega : b \mapsto b|_0$ is a surjective homomorphism from B to A . We have proved that the nucleus \mathcal{N} is exactly the automaton $A_{\omega,\rho}$.

On the other hand, let us consider one of the groups $G_{\omega,\rho}$. Each element $b \in B$ has a cyclic ρ -orbit. In the language of automata this means that b belongs to a cycle in the automaton $A_{\omega,\rho}$. We have $b|_1 \in B$ and $b|_0 \in A$ for every $b \in B$. It follows that if $b(u) = v$

and $u \neq v$ then u and v are of the form $u = 1^l 00w$, $v = 1^l 01w$ or $u = 1^l 01w$, $v = 1^l 00w$, $l \in \mathbb{N} \cup \{0\}$. Therefore the Schreier graphs $\Gamma_n(G)$ are intervals and the orbital Schreier graphs $\Gamma_w(G)$ have two ends for almost all sequences $w \in X^\omega$. \square

4 Cut-points of tiles and limit spaces

In this section we first recall the construction of the limit space and tiles of a self-similar group (see [25, 26] for more details). Then we show how to describe the cut-points of limit spaces and tiles of self-similar groups generated by bounded automata.

4.1 Limit spaces and tiles of self-similar groups

Let G be a contracting self-similar group with nucleus \mathcal{N} .

Definition 5. The *limit space* \mathcal{J} of the group G is the quotient of the space $X^{-\omega}$ by the equivalence relation, where two sequences $\dots x_2 x_1$ and $\dots y_2 y_1$ are equivalent if there exists a left-infinite path in the nucleus \mathcal{N} labeled by the pair $\dots x_2 x_1 | \dots y_2 y_1$.

The limit space \mathcal{J} is compact, metrizable, finite-dimensional space. If the group G is finitely generated and self-replicating, then the space \mathcal{J} is path-connected and locally path-connected (see [25, Corollary 3.5.3]). The shift map on the space $X^{-\omega}$ induces a continuous surjective map $\mathfrak{s} : \mathcal{J} \rightarrow \mathcal{J}$. The limit space \mathcal{J} comes together with a natural Borel measure μ defined as the push-forward of the uniform Bernoulli measure on $X^{-\omega}$. The dynamical system $(\mathcal{J}, \mathfrak{s}, \mu)$ is conjugate to the one-sided Bernoulli $|X|$ -shift (see [9]).

Definition 6. The *limit G -space* \mathcal{X} of the group G is the quotient of the space $X^{-\omega} \times G$ equipped with the product topology of discrete sets by the equivalence relation, where two sequences $\dots x_2 x_1 \cdot g$ and $\dots y_2 y_1 \cdot h$ of $X^{-\omega} \times G$ are equivalent if there exists a left-infinite path in the nucleus \mathcal{N} that ends in the state hg^{-1} and is labeled by the pair $\dots x_2 x_1 | \dots y_2 y_1$.

The space \mathcal{X} is metrizable and locally compact. The group G acts properly and cocompactly on the space \mathcal{X} by multiplication from the right. The quotient of \mathcal{X} by the action of G is the space \mathcal{J} .

Definition 7. The image of $X^{-\omega} \times \{1\}$ in the space \mathcal{X} is called the *tile* \mathcal{T} of the group G . The image of $X^{-\omega} v \times \{1\}$ for $v \in X^n$ is called the *tile* \mathcal{T}_v of n -th level.

Alternatively, the tile \mathcal{T} can be described as the quotient of $X^{-\omega}$ by the equivalence relation, where two sequences $\dots x_2 x_1$ and $\dots y_2 y_1$ are equivalent if and only if there exists a path in the nucleus \mathcal{N} that ends in the trivial state and is labeled by the pair $\dots x_2 x_1 | \dots y_2 y_1$. The push-forward of the uniform measure on $X^{-\omega}$ defines a measure on \mathcal{T} . The tile \mathcal{T} covers the limit G -space \mathcal{X} under the action of G .

The tile \mathcal{T} decomposes in the union $\cup_{v \in X^n} \mathcal{T}_v$ of the tiles of n -th level for every n . All tiles \mathcal{T}_v are compact and homeomorphic to \mathcal{T} . Two tiles \mathcal{T}_v and \mathcal{T}_u of the same level

$v, u \in X^n$ have nonempty intersection if and only if there exists $h \in \mathcal{N}$ such that $h(v) = u$ and $h|_v = 1$ (see [25, Proposition 3.3.5]). This is precisely how we connect vertices in the tile graph $T_n(G, \mathcal{N})$ with respect to the nucleus. Hence the graphs $T_n(G, \mathcal{N})$ can be used to approximate the tile \mathcal{T} , which justifies the term “tile” graph. The tile \mathcal{T} is connected if and only if all the tile graphs $T_n = T_n(G, \mathcal{N})$ are connected (see [25, Proposition 3.3.10]); in this case also \mathcal{T} is path-connected and locally path-connected.

Definition 8. A contracting self-similar group G satisfies the *open set condition* if for any element g of the nucleus \mathcal{N} there exists a word $v \in X^*$ such that $g|_v = 1$, i.e., in the nucleus \mathcal{N} there is a path from any state to the trivial state.

If a group satisfies the open set condition, then the tile \mathcal{T} is the closure of its interior, and any two different tiles of the same level have disjoint interiors; otherwise for large enough n there exists a tile \mathcal{T}_v for $v \in X^n$ which is covered by other tiles of n -th level (see [25, Proposition 3.3.7]).

Recall that the post-critical set \mathcal{P} of the group is defined as the set of all sequences that can be read along left-infinite paths in $\mathcal{N} \setminus \{1\}$. Therefore, under the open set condition, the boundary $\partial\mathcal{T}$ of the tile \mathcal{T} consists precisely of points represented by the post-critical sequences. Under the open set condition, the limit space \mathcal{J} can be obtained from the tile \mathcal{T} by gluing some of its boundary points. Namely, we need to glue two points represented by (post-critical) sequences $\dots x_2x_1$ and $\dots y_2y_1$ for every path in $\mathcal{N} \setminus \{1\}$ labeled by $\dots x_2x_1 | \dots y_2y_1$.

Every self-similar group generated by a bounded automaton is contracting as shown in [5], and we can consider the associated limit spaces and tiles. Note that every bounded automaton satisfies the open set condition. The limit spaces of groups generated by bounded automata are related to important classes of fractals: post-critically finite and finitely-ramified self-similar sets (see [6, Chapter IV]). Namely, for a contracting self-similar group G with nucleus \mathcal{N} the following statements are equivalent: every two tiles of the same level have finite intersection (the limit space \mathcal{J} is finitely-ramified); the post-critical set \mathcal{P} is finite (the limit space \mathcal{J} is post-critically finite); the nucleus \mathcal{N} is a bounded automaton (or the generating automaton of the group is bounded). Under the open set condition, the above statements are also equivalent to the finiteness of the tile boundary $\partial\mathcal{T}$.

Iterated monodromy groups. Let $f \in \mathbb{C}(z)$ be a complex rational function of degree $d \geq 2$ with finite post-critical set P_f . Then f defines a d -fold partial self-covering $f : f^{-1}(\mathcal{M}) \rightarrow \mathcal{M}$ of the space $\mathcal{M} = \hat{\mathbb{C}} \setminus P_f$. Take a base point $t \in \mathcal{M}$ and let T_t be the tree of preimages $f^{-n}(t)$, $n \geq 0$, where every vertex $z \in f^{-n}(t)$ is connected by an edge to $f(z) \in f^{-n+1}(t)$. The fundamental group $\pi_1(\mathcal{M}, t)$ acts by automorphisms on T_t through the monodromy action on every level $f^{-n}(t)$. The quotient of $\pi_1(\mathcal{M}, t)$ by the kernel of its action on T_t is called the *iterated monodromy group* $IMG(f)$ of the map f . The group $IMG(f)$ is contracting self-similar group and the limit space \mathcal{J} of the group $IMG(f)$ is homeomorphic to the Julia set $J(f)$ of the function f (see [25, Section 6.4] for more details). Moreover, the limit dynamical system $(\mathcal{J}_{IMG(f)}, \mathbf{s}, \mathbf{m})$ is conjugated to the dynamical system $(J(f), f, \mu_f)$, where μ_f is the unique f -invariant probability measure of maximal entropy

on the Julia set $J(f)$ (see [9]).

4.2 Cut-points of tiles and limit spaces

In this section we show how the number of connected components in the orbital Schreier and tile graphs with a vertex removed is related to the number of connected components in the limit space and tile with a point removed. This allows us to get a description of cut-points using a finite acceptor automata as in Proposition 7.

Let G be a self-similar group generated by a bounded automaton. We assume that the tile \mathcal{T} is connected. Then the nucleus \mathcal{N} of the group is a bounded automaton, every state of \mathcal{N} has an incoming arrow, and all the tile graphs $T_n = T_n(G, \mathcal{N})$ are connected. Hence we are in the settings of Section 3, and we can apply its results to the tile graphs T_n . Since the limit space \mathcal{J} is obtained from the tile \mathcal{T} by gluing finitely many specific boundary points (the post-critical set \mathcal{P} is finite), it is sufficient to consider the problem for the tile \mathcal{T} , in analogy to what we made before for the Schreier and tile graphs.

4.2.1 Boundary, critical and regular points

The tile \mathcal{T} decomposes into the union $\cup_{x \in X} \mathcal{T}_x$, where each tile \mathcal{T}_x is homeomorphic to \mathcal{T} under the shift map. It follows that, if we take a copy (\mathcal{T}, x) of the tile \mathcal{T} for each $x \in X$ and glue every two points (t_1, x) and (t_2, y) with the property that there exists a path in the nucleus \mathcal{N} that ends in the trivial state and is labeled by $\dots x_2 x_1 x | \dots y_2 y_1 y$, and the sequences $\dots x_2 x_1$ and $\dots y_2 y_1$ represent the points t_1 and t_2 respectively, then we get a space homeomorphic to the tile \mathcal{T} . This is an analog of the construction of tile graphs T_n given in Theorem 2. The edges of the model graph M now indicate which points of the copies (\mathcal{T}, x) should be glued.

We consider the tile \mathcal{T} as its own topological space (with the induced topology from the space \mathcal{X}), and every tile \mathcal{T}_v for $v \in X^*$ as a subset of \mathcal{T} with induced topology. Hence the boundary of \mathcal{T} is empty, but the points represented by post-critical sequences we still call the *boundary points* of the tile. Every point in the intersection of different tiles $\mathcal{T}_v \cap \mathcal{T}_u$ of the same level $|v| = |u|$ we call *critical*. These points are precisely the boundary points of the tiles \mathcal{T}_v for $v \in X^*$, and they are represented by sequences of the form pv for $p \in \mathcal{P}$ and $v \in X^*$. In particular, the number of critical points is countable, and hence they are of measure zero. All other points of \mathcal{T} we call *regular*. Note that if a regular point t is represented by a sequence $\dots x_2 x_1$, then t is an interior point of $\mathcal{T}_{x_n \dots x_2 x_1}$ for all n . Since each tile $\mathcal{T}_{x_n \dots x_2 x_1}$ is homeomorphic to \mathcal{T} , the cut-points of \mathcal{T} also provide information about its local cut-points.

4.2.2 Components in the tile with a point removed

In what follows, let $c(\mathcal{T} \setminus t)$ denote the number of connected components in $\mathcal{T} \setminus t$ for a point $t \in \mathcal{T}$ and $bc(\mathcal{T} \setminus t)$ be the number of components in $\mathcal{T} \setminus t$ that contain a boundary point of \mathcal{T} . We will show that the numbers $c(\mathcal{T} \setminus t)$ and $bc(\mathcal{T} \setminus t)$ can be computed using a

method similar to the one developed in Section 3 to find the number of components in the tile graphs with a vertex removed.

We start with the following result which is an analog of Propositions 4.

Proposition 19. *Let $t \in \mathcal{T}$ be a regular point represented by a sequence $\dots x_2 x_1 \in X^{-\omega}$. Then*

$$bc(\mathcal{T} \setminus t) = \lim_{n \rightarrow \infty} bc(\mathcal{T} \setminus \text{int}(\mathcal{T}_{x_n \dots x_2 x_1})) = \lim_{n \rightarrow \infty} pc(T_n \setminus x_n \dots x_2 x_1).$$

Proof. The interior $\text{int}(\mathcal{T}_v)$ of the tile \mathcal{T}_v is the complement to the subset of finitely many points that also belong to other tiles of the same level. Therefore $\mathcal{T} \setminus \text{int}(\mathcal{T}_v)$ is the union of all tiles \mathcal{T}_u for $u \in X^{|v|}, u \neq v$.

Since the point t is regular, we can choose n large enough so that the tile $\mathcal{T}_{x_n \dots x_2 x_1}$ does not contain the boundary points of \mathcal{T} contained in $\mathcal{T} \setminus t$, and every tile \mathcal{T}_v for $v \in X^n$ contains at most one boundary point of \mathcal{T} . Since t belongs to the interior $\text{int}(\mathcal{T}_{x_n \dots x_2 x_1})$ of the tile $\mathcal{T}_{x_n \dots x_2 x_1}$, if two boundary points of \mathcal{T} lie in the same connected component of $\mathcal{T} \setminus \text{int}(\mathcal{T}_{x_n \dots x_2 x_1})$, they lie in the same connected component of $\mathcal{T} \setminus t$. Therefore the value of the first limit is not less than $bc(\mathcal{T} \setminus t)$. Conversely, if two boundary points of \mathcal{T} lie in the same component of $\mathcal{T} \setminus t$, then for sufficiently large n these two points lie in the same components of $\mathcal{T} \setminus \text{int}(\mathcal{T}_{x_n \dots x_2 x_1})$. Since the number of boundary points is finite, the first equality follows.

For the second equality recall that two tiles \mathcal{T}_v and \mathcal{T}_u for $v, u \in X^n$ have nonempty intersection if and only if the vertices v and u are connected by an edge in the graph T_n . It follows that if two vertices v and u belong to the same component in $T_n \setminus x_n \dots x_2 x_1$, then the tiles \mathcal{T}_v and \mathcal{T}_u belong to the same component in $\mathcal{T} \setminus t$. Therefore the value of the second limit is not less than $bc(\mathcal{T} \setminus t)$. Conversely, since the point t is regular, one can choose n large enough so that for any pair of boundary points of \mathcal{T} that belong to the same connected component in $\mathcal{T} \setminus t$, these points also belong to the same component in $\mathcal{T} \setminus \mathcal{T}_{x_n \dots x_2 x_1}$. The second equality follows. \square

Propositions 4 and 19 establish the connection between the number of components in a punctured tile and the number of infinite components in a punctured tile graph. To describe the limit in Proposition 4 we constructed the automaton \mathbf{A}_{ic} , which returns the number $pc(T_n \setminus x_n \dots x_2 x_1)$ by reading the word $x_n \dots x_2 x_1$ from left to right, so that we can apply it to right-infinite sequences. Similarly one can construct a finite automaton \mathbf{B}_{bc} , which returns $pc(T_n \setminus x_n \dots x_2 x_1)$ by reading the word $x_n \dots x_2 x_1$ from right to left (the reversion of a regular language is a regular language) so that we can apply it to left-infinite sequences. Then we can describe the limit in Proposition 19 in the same way as Proposition 7 describes the limit in Proposition 4.

Also we can construct a finite deterministic (acceptor) automaton \mathbf{B}_{ic} with the following property. The states of \mathbf{B}_{ic} are labeled by tuples of the form

$$(\{\mathcal{P}_i\}_i, \{\mathcal{F}_j\}_j, \varphi : \{\mathcal{P}_i\}_i \rightarrow \{\mathcal{F}_j\}_j, n).$$

This tuple indicates the following. For any word $v \in X^*$ let us consider the partition of the set of boundary points of \mathcal{T} induced by the components of $\mathcal{T} \setminus \text{int}(\mathcal{T}_v)$ and let \mathcal{P}_i be

the set of all post-critical sequences representing the points from the same component. Let n be the number of component in $\mathcal{T} \setminus \text{int}(\mathcal{T}_v)$ without a boundary point of \mathcal{T} . Similarly, we consider the boundary points of \mathcal{T}_v and let \mathcal{F}_j be the set of all post-critical sequences p_i such that the points represents by p_iv belong to the same component in $\mathcal{T} \setminus \text{int}(\mathcal{T}_v)$. Further, we define $\varphi(\mathcal{P}_i) = \mathcal{F}_i$ if the points represented by sequences from \mathcal{P}_i and \mathcal{F}_i belong to the same connected component. Then the final state of \mathbf{B}_{ic} after accepting v is labeled exactly by the constructed tuple. If we are interested just in the number of all components in $\mathcal{T} \setminus \text{int}(\mathcal{T}_v)$, we replace the label of each state by the number of components \mathcal{P}_i plus n . The following statement follows.

Proposition 20. *For every integer k the set of all words $v \in X^*$ with the property that $\mathcal{T} \setminus \text{int}(\mathcal{T}_v)$ has k connected components is a regular language recognized by the automaton \mathbf{B}_{ic} .*

This result enables us to provide, in analogy to Theorem 8, a constructive method which, given a representation $\dots x_2x_1$ of a point $t \in \mathcal{T}$, determines the number of components in $\mathcal{T} \setminus t$. In particular, we get a description of cut-points of \mathcal{T} . We distinguish two cases.

Regular points. If a sequence $\dots x_2x_1 \in X^{-\omega}$ represents a regular point $t \in \mathcal{T}$, then t is an interior point of the tile $\mathcal{T}_{x_n\dots x_2x_1}$ for all $n \geq 1$. Hence, for a regular point t , every connected component of $\mathcal{T} \setminus t$ intersects the tile $\mathcal{T}_{x_n\dots x_2x_1}$. Since the number of boundary points of each tile \mathcal{T}_v is not greater than $|\mathcal{P}|$, it follows that $c(\mathcal{T} \setminus t)$ coincides with the number of components in the partition of the boundary of the tile $\mathcal{T}_{x_n\dots x_2x_1}$ in $\mathcal{T} \setminus t$ for large enough n (in particular, $c(\mathcal{T} \setminus t) \leq |\mathcal{P}|$). The last problem can be subdivided on two subproblems. First, “outside” subproblem: find how the boundary of the tile $\mathcal{T}_{x_n\dots x_2x_1}$ decomposes in $\mathcal{T} \setminus \text{int}(\mathcal{T}_{x_n\dots x_2x_1})$. The automaton \mathbf{B}_{ic} provides an answer to this problem when we trace the second label $\{\mathcal{F}_j\}_j$ of states. Second, “inside” subproblem: find how the boundary $\partial\mathcal{T}_{x_n\dots x_2x_1}$ decomposes in $\mathcal{T}_{x_n\dots x_2x_1} \setminus t$. Since each tile \mathcal{T}_v is homeomorphic to the tile \mathcal{T} under the shift map, the automaton \mathbf{B}_{ic} provides an answer to this problem when we trace the first label $\{\mathcal{P}_i\}_i$ of states (as well as the automaton \mathbf{B}_{bc}). By combining the two partitions of $\partial\mathcal{T}_{x_n\dots x_2x_1}$ given by the two subproblems, we get the number of connected components in $\mathcal{T} \setminus t$.

Critical points. Let t be a critical point. Suppose t is represented by a post-critical sequence $p_1x_1 \in \mathcal{P}$ with periodic $p_1 \in \mathcal{P}$ and $x_1 \in X$. Note that the structure of bounded automata implies that periodic post-critical sequences represent regular points of the tile. Therefore we can apply the previous case to find the number $c(\mathcal{T} \setminus \overline{p_1})$ and the partition of the boundary of \mathcal{T} in $\mathcal{T} \setminus \overline{p_1}$, where $\overline{p_1}$ stands for the point represented by p_1 .

Now consider the components of $\mathcal{T} \setminus t$. The only difference with the regular case is that t may be not an interior point of \mathcal{T}_v for all sufficiently long words v . However, it is an interior point of a union of finitely many tiles, and we will be able to apply the same arguments as above. Consider vertices $(p_i, x_i), i = 2, \dots, k$ of the model graph M adjacent to the vertex (p_1, x_1) . Notice that since p_1 is periodic, all p_i are periodic. The sequences p_ix_i are precisely all sequences that represent the point t . Hence the point t is an interior point of the set $U = \cup_{i=1}^k \mathcal{T}_{x_i}$. We can find how the boundary of the set U decomposes in $\mathcal{T} \setminus \text{int} U$. Since every tile \mathcal{T}_{x_i} is homeomorphic to the tile \mathcal{T} via the shift map, we can

find $c(\mathcal{T}_{x_i} \setminus t) = c(\mathcal{T} \setminus \overline{p_i})$, and deduce the decomposition of the boundary of \mathcal{T}_{x_i} in $\mathcal{T}_{x_i} \setminus t$. Combining these partitions, we can find $c(\mathcal{T} \setminus t)$ and the corresponding decomposition of $\partial\mathcal{T}$ (in particular, $c(\mathcal{T} \setminus t) \leq k|\mathcal{P}|$). In this way we can find $c(\mathcal{T} \setminus t)$ for every point t represented by a post-critical sequence.

Now let t be a critical point represented by a sequence pyu with $p \in \mathcal{P}$, $y \in X$, $u \in X^*$, and $py \notin \mathcal{P}$. Recall that there is a finite automaton, which reads the word u and returns the decomposition of the boundary of \mathcal{T}_u in $\mathcal{T} \setminus \text{int } \mathcal{T}_u$. Using the fact that $\mathcal{T}_u \setminus t$ and $\mathcal{T} \setminus \overline{py}$ are homeomorphic, we can find the number $c(\mathcal{T}_u \setminus t)$ in the same way as we did above for the sequence p_1x_1 . Since the post-critical set is finite, one can construct a finite automaton, which given a finite word v and a post-critical sequence $p \in \mathcal{P}$ returns the number $c(\mathcal{T} \setminus \overline{pv})$.

4.2.3 The number of components in punctured limit space and tile almost surely

We can use the results from Sections 3.7 and 3.8 to get information about cut-points of the limit space and tile up to measure zero.

Theorem 21. *1. The number of connected components in $\mathcal{T} \setminus t$ is the same for almost all points t , and is equal to one or two. Moreover, $c(\mathcal{T} \setminus t) = 2$ almost surely if and only if the Schreier graphs Γ_w (equivalently, the tile graphs T_w) have two ends for almost all $w \in X^\omega$, and in this case the tile \mathcal{T} is homeomorphic to an interval.*

2. The number of connected components in $\mathcal{J} \setminus t$ is the same for almost all points t , and is equal to one or two. Moreover, $c(\mathcal{J} \setminus t) = 2$ almost surely if and only if the nucleus \mathcal{N} of the group satisfies Case 2 of Theorem 17.

Proof. By Corollary 15 we have to consider only two cases.

If the tile graphs T_w have one end for almost all $w \in X^\omega$, then by Remark 4 there exists a word $v \in X^*$ such that $pc(T_n \setminus u_1vu_2) = 1$ for all $u_1, u_2 \in X^*$ with $n = |u_1vu_2|$. The set of all sequences of the form u_1vu_2 for $u_1 \in X^{-\omega}$ and $u_2 \in X^*$ is of full measure. Then by Proposition 19 we get that all boundary points of the tile \mathcal{T} belong to the same component in $\mathcal{T} \setminus t$ for almost all points t . Since every tile \mathcal{T}_v is homeomorphic to \mathcal{T} , we get that the boundary of every tile \mathcal{T}_v belongs to the same component in $\mathcal{T}_v \setminus t$ for almost all points t . It follows that $c(\mathcal{T} \setminus t) = 1$ almost surely. Since the limit space \mathcal{J} can be constructed from \mathcal{T} by gluing finitely many of its points, in this case we get $c(\mathcal{J} \setminus t) = 1$ almost surely.

If the tile graphs T_w have two ends almost surely, then we are in the settings of Theorem 17. It is direct to check that in both cases of this theorem the tile \mathcal{T} is homeomorphic to an interval (because the tile graphs T_n are intervals), and hence $c(\mathcal{T} \setminus t) = 2$ for almost all points t . In Case 1 the limit space is homeomorphic to a circle and therefore $c(\mathcal{J} \setminus t) = 1$ almost surely. In Case 2 the limit space is homeomorphic to an interval and therefore $c(\mathcal{J} \setminus t) = 2$ almost surely. \square

Corollary 22. *1. The tile \mathcal{T} of a contracting self-similar group with open set condition is homeomorphic to an interval if and only if the nucleus of the group satisfies Theorem 17.*

2. The limit space \mathcal{J} of a contracting self-similar group with connected tiles and open set condition is homeomorphic to a circle if and only if the nucleus of the group satisfies Case 1 of Theorem 17, i.e., it consists of the adding machine, its inverse, and the identity state.
3. The limit space \mathcal{J} of a contracting self-similar group with connected tiles and open set condition is homeomorphic to an interval if and only if the nucleus of the group satisfies Case 2 of Theorem 17.

Proof. Let G be a contracting self-similar groups with open set condition, and let the tile \mathcal{T} of the group G be homeomorphic to an interval. Then the group G has connected tiles and all tiles \mathcal{T}_v are homeomorphic to an interval. The boundary of tiles is finite, hence the group G is generated by a bounded automaton (here we use the open set condition), and we are under the settings of this section. Since $c(\mathcal{T} \setminus t) = 2$ almost surely, the Schreier graphs Γ_w with respect to the nucleus \mathcal{N} have almost surely two ends, and hence \mathcal{N} satisfies Theorem 17.

It is left to prove the statements about limit spaces. A small connected neighborhood of any point of a circle or of an interval is homeomorphic to an interval. Hence, if the limit space \mathcal{J} is a circle or an interval, the tile \mathcal{T} is homeomorphic to an interval. Therefore we are in the settings of Theorem 17. As was mentioned above, in Case 1 of Theorem 17 the limit space \mathcal{J} is homeomorphic to a circle, and in Case 2 it is homeomorphic to an interval. \square

The last corollary together with Theorem 18 agree with the following result of Nekrashevych and Šunić:

Theorem 23 ([27, Theorem 5.5]). *The limit dynamical system $(\mathcal{J}, \mathfrak{s})$ of a contracting self-similar group G is topologically conjugate to the tent map if and only if G is equivalent as a self-similar group to one of the automata $A_{\omega, \rho}$.*

5 Examples

5.1 Basilica group

The Basilica group G is generated by the automaton shown in Figure 5. This group is the iterated monodromy group of $z^2 - 1$. It is torsion-free, has exponential growth, and is the first example of amenable but not subexponentially amenable group (see [20]). The orbital Schreier graphs Γ_w of this group have polynomial growth of degree 2 (see [6, Chapter VI]). The structure of Schreier graphs Γ_w was investigated in [11]. In particular, it was shown that there are uncountably many pairwise non-isomorphic graphs Γ_w and the number of ends was described. Let us show how to get the result about ends using the developed method.

The alphabet is $X = \{0, 1\}$ and the post-critical set \mathcal{P} consists of three elements $a = 0^{-\omega}$, $b = (01)^{-\omega}$, $c = (10)^{-\omega}$. The model graph is shown in Figure 5. The automata A_c and A_{i_c} are shown in Figure 6. We get that each tile graph T_w has one or two ends, and

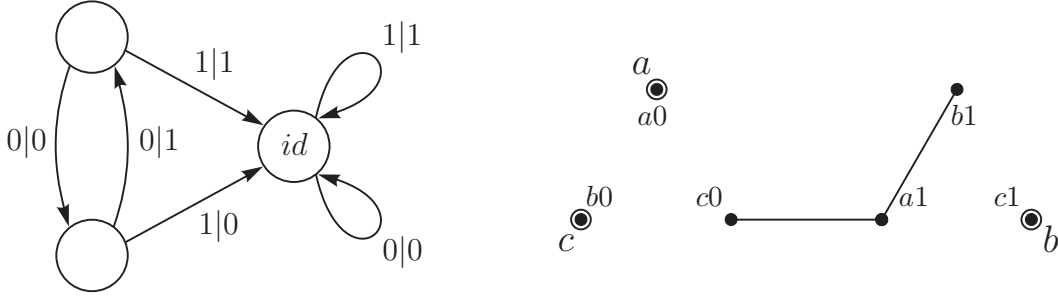

Figure 5: Basilica automaton and its model graph

we denote by E_1 and E_2 the corresponding sets of sequences w . For the critical sequences $w = 0^\omega$ the tile graph T_w has two ends, while for the other critical sequences $(01)^\omega$ and $(10)^\omega$ the tile graph T_w has one end. Using the automaton A_{ic} the sets E_1 and E_2 can be described by Theorem 8 as follows:

$$\begin{aligned} E_2 &= X^*(0X)^\omega \setminus (Cof((01)^\omega \cup (10)^\omega)), \\ E_1 &= X^\omega \setminus E_2. \end{aligned}$$

Almost every tile graph T_w has one end, the set E_2 is uncountable but of measure zero.

Every graph $T_w \setminus w$ has one, two, or three connected components, and we denote by C_1 , C_2 , and C_3 the corresponding sets of sequences. Using the automaton A_c these sets can be described precisely as follows:

$$\begin{aligned} C_3 &= \bigcup_{k \geq 0} (010(10)^k 0(0X)^\omega \cup 000^k 1(0X)^\omega), \\ C_2 &= \bigcup_{k \geq 1} (10)^k 0(0X)^\omega \bigcup (00X^\omega \cup 01X^\omega) \setminus C_3, \\ C_1 &= X^\omega \setminus (C_2 \cup C_3). \end{aligned}$$

The set C_3 is uncountable but of measure zero, while the sets C_1 and C_2 are of measure $1/2$.

Each graph $T_w \setminus w$ has one or two infinite components. The corresponding sets IC_1 and IC_2 can be described using the automaton A_{ic} as follows:

$$\begin{aligned} IC_2 &= \bigcup_{k \geq 1} ((10)^k 0(0X)^\omega \cup 0(10)^k 0(0X)^\omega \cup 00^k 1(0X)^\omega) \setminus (Cof((01)^\omega \cup (10)^\omega)), \\ IC_1 &= X^\omega \setminus IC_2. \end{aligned}$$

The set IC_2 is uncountable but of measure zero.

The finite Schreier graph Γ_n differs from the finite tile graph T_n by two edges $\{a_n, b_n\}$ and $\{a_n, c_n\}$. Assuming these edges one can relabel the states of the automaton A_c so that it returns the number of components in $\Gamma_n \setminus v$. In this way we get that $c(\Gamma_n \setminus v) = 1$ if the

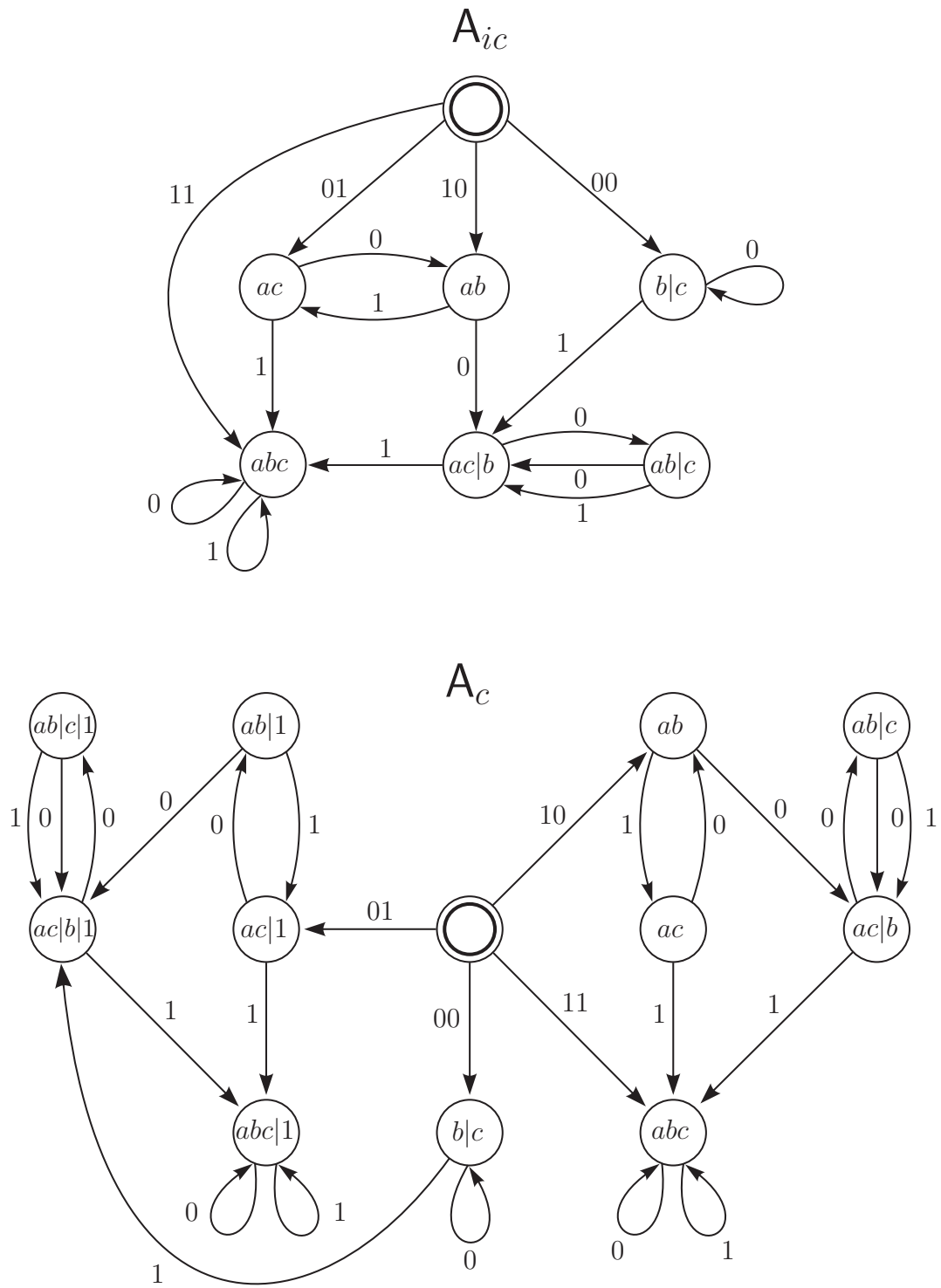

Figure 6: The automata A_{ic} and A_c for Basilica group

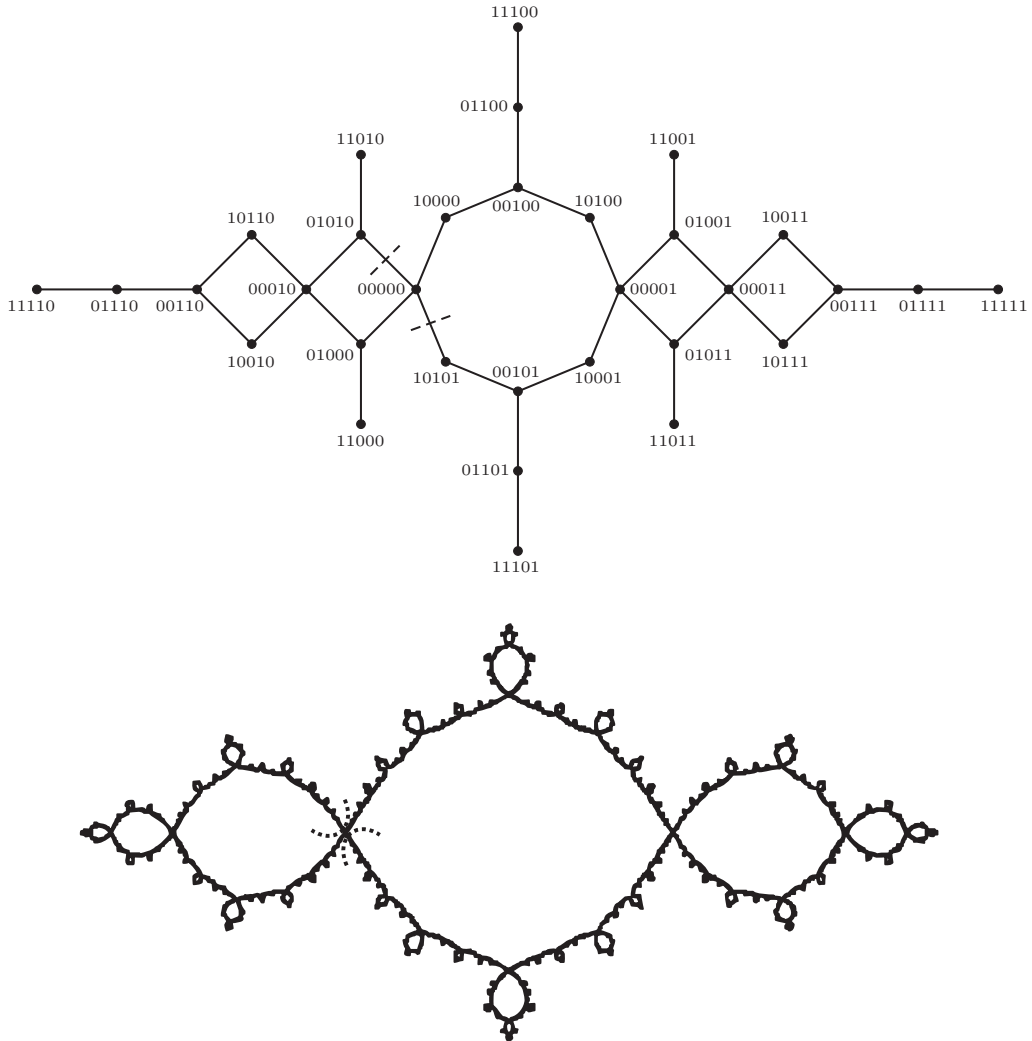

Figure 7: The Schreier graph Γ_5 of the Basilica group and its limit space

word v starts with 10 or 11; in the other cases $c(\Gamma_n \setminus v) = 2$. In particular, the Schreier graph Γ_n has 2^{n-1} cut-vertices.

The orbital Schreier graph Γ_w coincides with the tile graph T_w except when w is critical. The critical sequences 0^ω , $(01)^\omega$, and $(10)^\omega$ lie in the same orbit and the corresponding Schreier graph consists of three tile graphs T_{0^ω} , $T_{(01)^\omega}$, $T_{(10)^\omega}$ with two new edges $(0^\omega, (01)^\omega)$ and $(0^\omega, (10)^\omega)$. It follows that this graph has four ends.

The limit space \mathcal{J} of the group G is homeomorphic to the Julia set of $z^2 - 1$ shown in Figure 7. The tile \mathcal{T} can be obtained from the limit space by cutting the limit space in the way shown in the figure, or, vice versa, the limit space can be obtained from the tile by gluing points represented by post-critical sequences $0^{-\omega}$, $(01)^{-\omega}$, $(10)^{-\omega}$. Every point $t \in \mathcal{T}$ divides the tile \mathcal{T} into one, two, or three connected components. Put $\mathcal{C} = \{0^{-\omega}1, (01)^{-\omega}1, (10)^{-\omega}0\}$. Then the sets \mathcal{C}_1 , \mathcal{C}_2 , and \mathcal{C}_3 of sequences from $X^{-\omega}$, which represent the corresponding cut-points, can be described as follows:

$$\begin{aligned}\mathcal{C}_3 &= \bigcup_{n \geq 0} \mathcal{C}(0X)^n \cup \mathcal{C}(0X)^n 0, \\ \mathcal{C}_2 &= \bigcup_{n \geq 0} (\mathcal{C}(X0)^n \cup \mathcal{C}(X0)^n X) \bigcup ((0X)^{-\omega} \cup (X0)^{-\omega}) \setminus (\mathcal{C}_3 \cup \{(10)^{-\omega}, (01)^{-\omega}\}), \\ \mathcal{C}_1 &= X^{-\omega} \setminus (\mathcal{C}_2 \cup \mathcal{C}_3).\end{aligned}$$

The set \mathcal{C}_3 of three-section points is countable, the set \mathcal{C}_2 of bisection points is uncountable and of measure zero, and the tile $\mathcal{T} \setminus t$ is connected for almost all points t .

Every point $t \in \mathcal{J}$ divides the limit space \mathcal{J} into one or two connected components. The corresponding sets \mathcal{C}'_1 and \mathcal{C}'_2 can be described as follows:

$$\begin{aligned}\mathcal{C}'_2 &= \bigcup_{n \geq 0} (\mathcal{C}(X0)^n \cup \mathcal{C}(0X)^n \cup \mathcal{C}(0X)^n 0 \cup \mathcal{C}(X0)^n X) \bigcup \\ &\quad \bigcup ((0X)^{-\omega} \cup (X0)^{-\omega}) \setminus \{(10)^{-\omega}, (01)^{-\omega}\}, \\ \mathcal{C}'_1 &= X^{-\omega} \setminus \mathcal{C}'_2.\end{aligned}$$

The set \mathcal{C}'_2 of bisection points is uncountable and of measure zero, and the limit space $\mathcal{J} \setminus t$ is connected for almost all points t .

5.2 Gupta-Fabrykowski group

The Gupta-Fabrykowski group G is generated by the automaton shown in Figure 8. It was constructed in [15] as an example of a group of intermediate growth. Also this group is the iterated monodromy group of $z^3(-\frac{3}{2} + i\frac{\sqrt{3}}{2}) + 1$ (see [25, Example 6.12.4]). The Schreier graphs Γ_w of this group were studied in [2], where their spectrum and growth were computed (they have polynomial growth of degree $\frac{\log 3}{\log 2}$).

The alphabet is $X = \{0, 1, 2\}$ and the post-critical set \mathcal{P} consists of two elements $a = 2^{-\omega}$ and $b = 2^{-\omega}0$. The model graph is shown in Figure 8. The automata A_c and A_{ic}

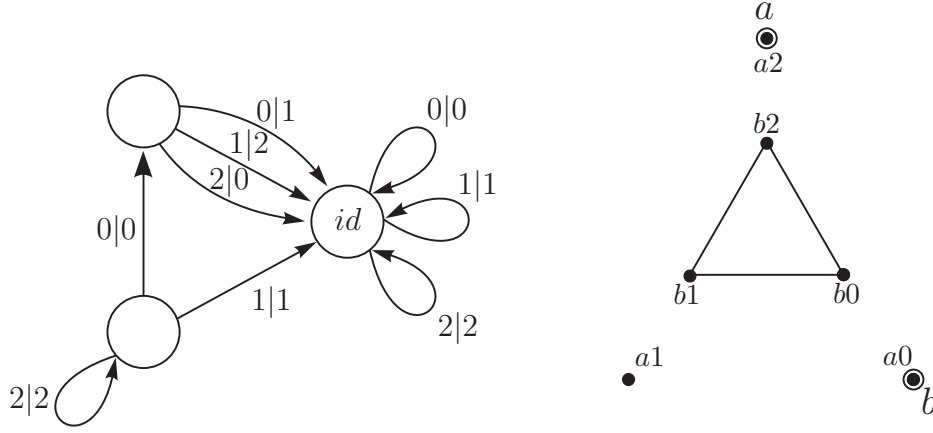

Figure 8: Gupta-Fabrykowski automaton and its model graph

are shown in Figure 9. Every Schreier graph Γ_w coincides with the tile graph T_w . We get that every tile graph T_w has one or two ends, and we denote by E_1 and E_2 the corresponding sets of sequences. For the only critical sequence 2^ω the tile graph T_w has one end. Using the automaton A_{ic} the sets E_1 and E_2 can be described by Theorem 8 as follows:

$$E_2 = X^* \{0, 2\}^\omega \setminus \text{Cof}(2^\omega), \quad E_1 = X^\omega \setminus E_2.$$

Almost every tile graph has one end, the set E_2 is uncountable but of measure zero.

Every graph $T_w \setminus w$ has one or two connected components, and we denote by C_1 and C_2 the corresponding sets of sequences. Using the automaton A_c these sets can be described precisely as follows:

$$C_2 = \bigcup_{k \geq 0} (2^k 0 1 X^\omega \cup 2^k 0 \{0, 2\}^\omega), \quad C_1 = X^\omega \setminus C_2.$$

The sets C_1 and C_2 have measure $\frac{5}{6}$ and $\frac{1}{6}$ respectively.

Every graph $T_w \setminus w$ has one or two infinite components. The corresponding sets IC_1 and IC_2 can be described using the automaton A_{ic} as follows:

$$IC_2 = \bigcup_{k \geq 0} 2^k 0 \{0, 2\}^\omega \setminus \text{Cof}(2^\omega), \quad IC_1 = X^\omega \setminus IC_2.$$

The set IC_2 is uncountable but of measure zero.

The limit space \mathcal{J} and the tile \mathcal{T} of the group G are homeomorphic to the Julia set of the map $z^3(-\frac{3}{2} + i\frac{\sqrt{3}}{2}) + 1$ shown in Figure 10. Every point $t \in \mathcal{J}$ divides the limit space into one, two, or three connected components. The sets \mathcal{C}_1 , \mathcal{C}_2 , and \mathcal{C}_3 of sequences from $X^{-\omega}$, which represent the corresponding points, can be described as follows:

$$\begin{aligned} \mathcal{C}_3 &= 2^{-\omega} 0 X^* \setminus \{2^{-\omega} 0\}, \\ \mathcal{C}_2 &= \{0, 2\}^{-\omega} \setminus (\mathcal{C}_3 \cup \{2^{-\omega}, 2^{-\omega} 0\}), \\ \mathcal{C}_1 &= X^{-\omega} \setminus (\mathcal{C}_2 \cup \mathcal{C}_3). \end{aligned}$$

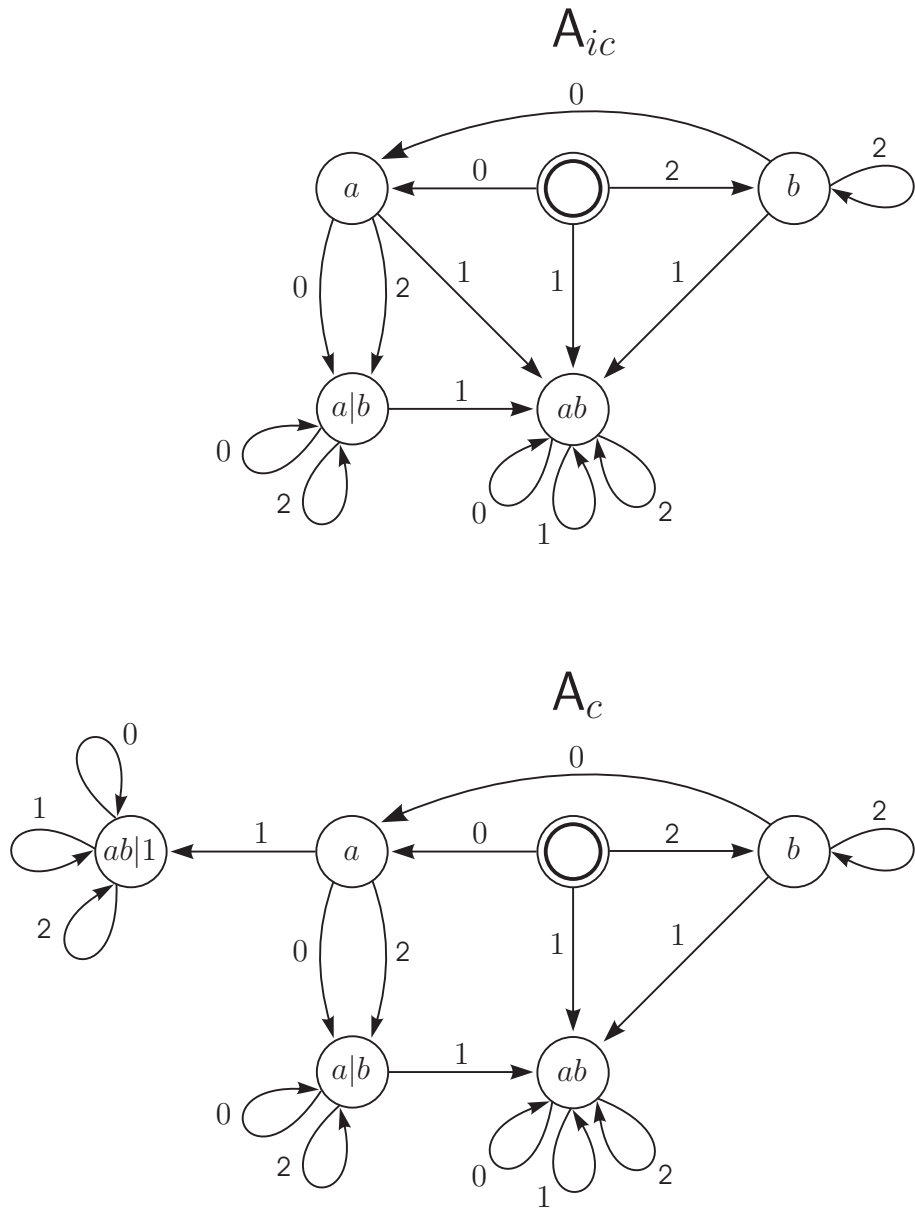

Figure 9: The automata A_{ic} and A_c for Gupta-Fabrykowski group

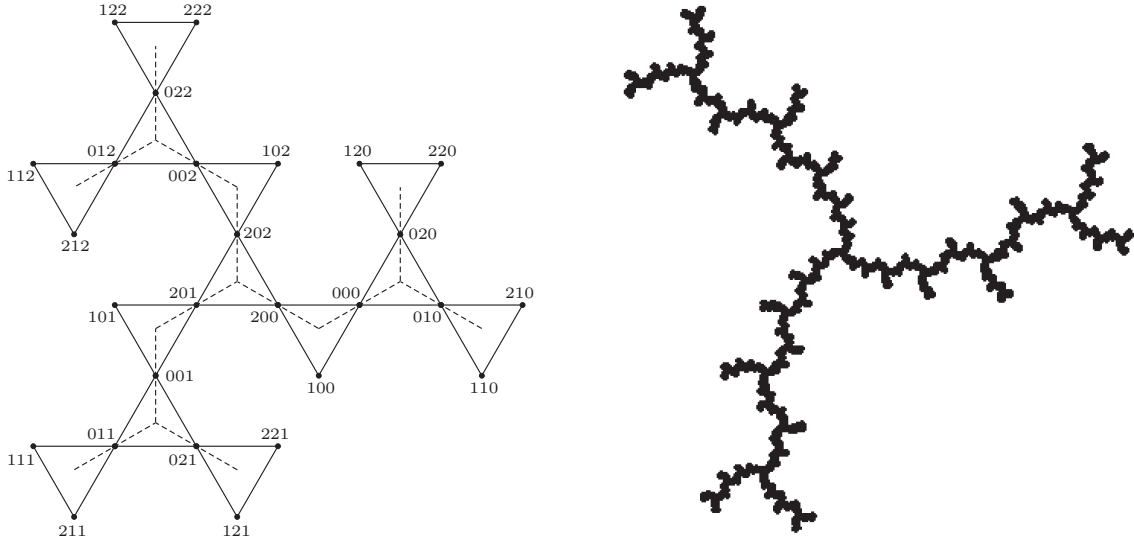

Figure 10: The Schreier graph Γ_3 of the Gupta-Fabrykowski group and its limit space

The set \mathcal{C}_3 of three-section points is countable, the set \mathcal{C}_2 of bisection points is uncountable and of measure zero, and the limit space $\mathcal{J} \setminus t$ is connected for almost all points t .

5.3 Iterated monodromy group of $z^2 + i$

The iterated monodromy group of $z^2 + i$ is generated by the automaton shown in Figure 11. This group is one more example of a group of intermediate growth (see [10]). The algebraic properties of $IMG(z^2 + i)$ were studied in [17]. The Schreier graphs Γ_w of this group have polynomial growth of degree $\frac{\log 2}{\log \lambda}$, where λ is the real root of $x^3 - x - 2$ (see [6, Chapter VI]).

The alphabet is $X = \{0, 1\}$ and the post-critical set \mathcal{P} consists of three elements $a = (10)^{-\omega}0$, $b = (10)^{-\omega}$, and $c = (01)^{-\omega}$. The model graph is shown in Figure 11. The automata A_c and A_{ic} are shown in Figure 12. Every Schreier graph Γ_w coincides with the tile graph T_w and it is a tree. We get that every tile graph T_w has one, two, or three ends, and we denote by E_1 , E_2 , and E_3 the corresponding sets of sequences. Using the automaton A_{ic} the sets E_1 , E_2 , E_3 can be described by Theorem 8 as follows. For the both critical sequences $(10)^\omega$ and $(01)^\omega$ the tile graph T_w has one end. Denote by \mathcal{R} the right one-sided sofic subshift given by the subgraph emphasized in Figure 12. Then

$$E_3 = \text{Cof}(0^\omega), \quad E_2 = X^* \mathcal{R} \setminus \text{Cof}(0^\omega \cup (10)^\omega \cup (01)^\omega), \quad E_1 = X^\omega \setminus E_2.$$

(We cannot describe these sets in the way we did with the previous examples, because the subshift \mathcal{R} is not of finite type). Almost every tile graph has one end, the set E_2 is uncountable but of measure zero, and there is one graph, namely T_{0^ω} , with three ends. This example shows that Corollary 14 may hold for regular sequences (here 0^ω is regular).

Every graph $T_w \setminus w$ has one, two, or three connected components, and we denote by C_1 , C_2 , and C_3 the corresponding sets of sequences. Using the automaton A_c these sets can

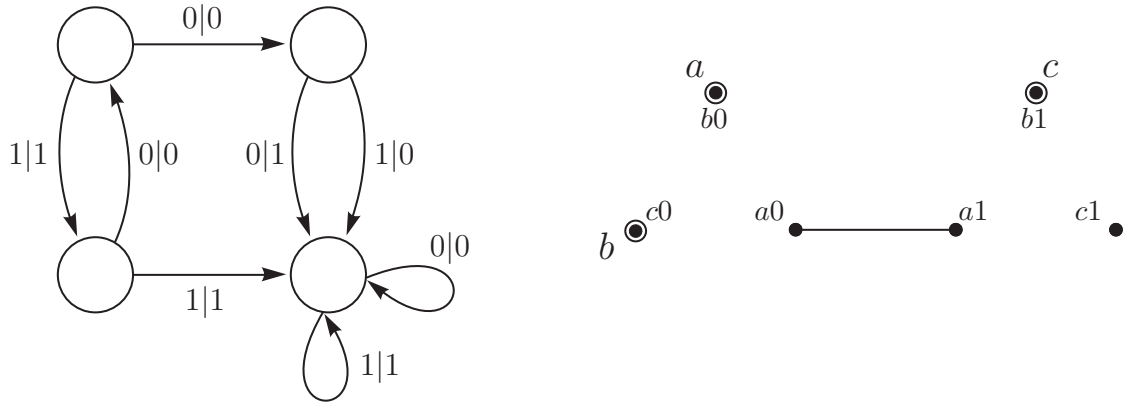

Figure 11: $IMG(z^2 + i)$ automaton and its model graph

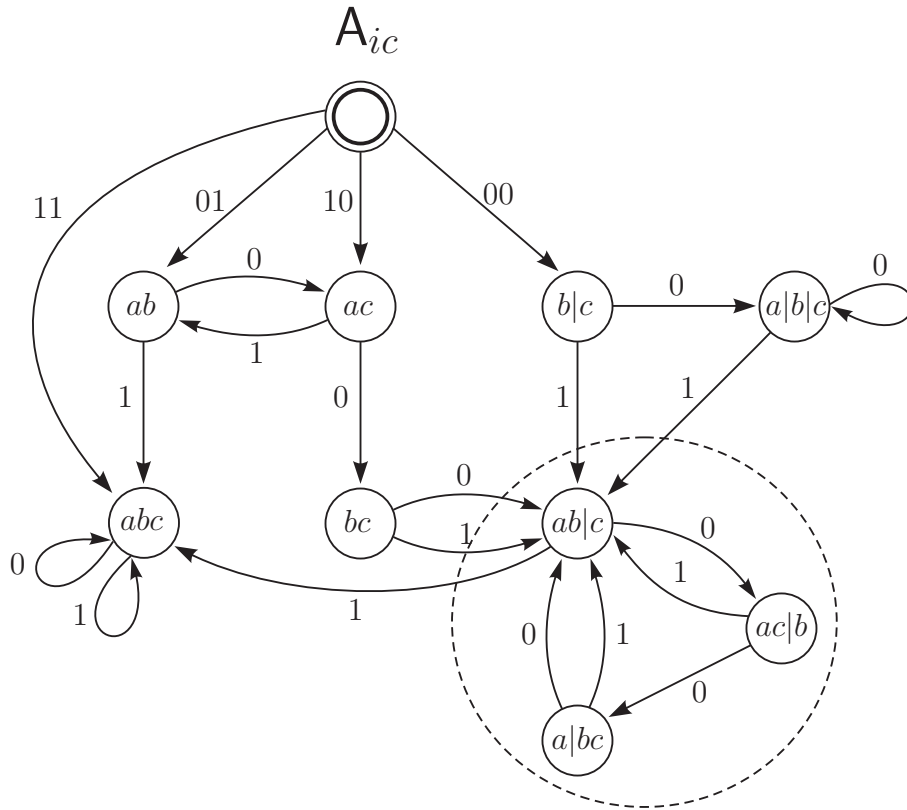

Figure 12: The automaton A_{ic} for $IMG(z^2 + i)$

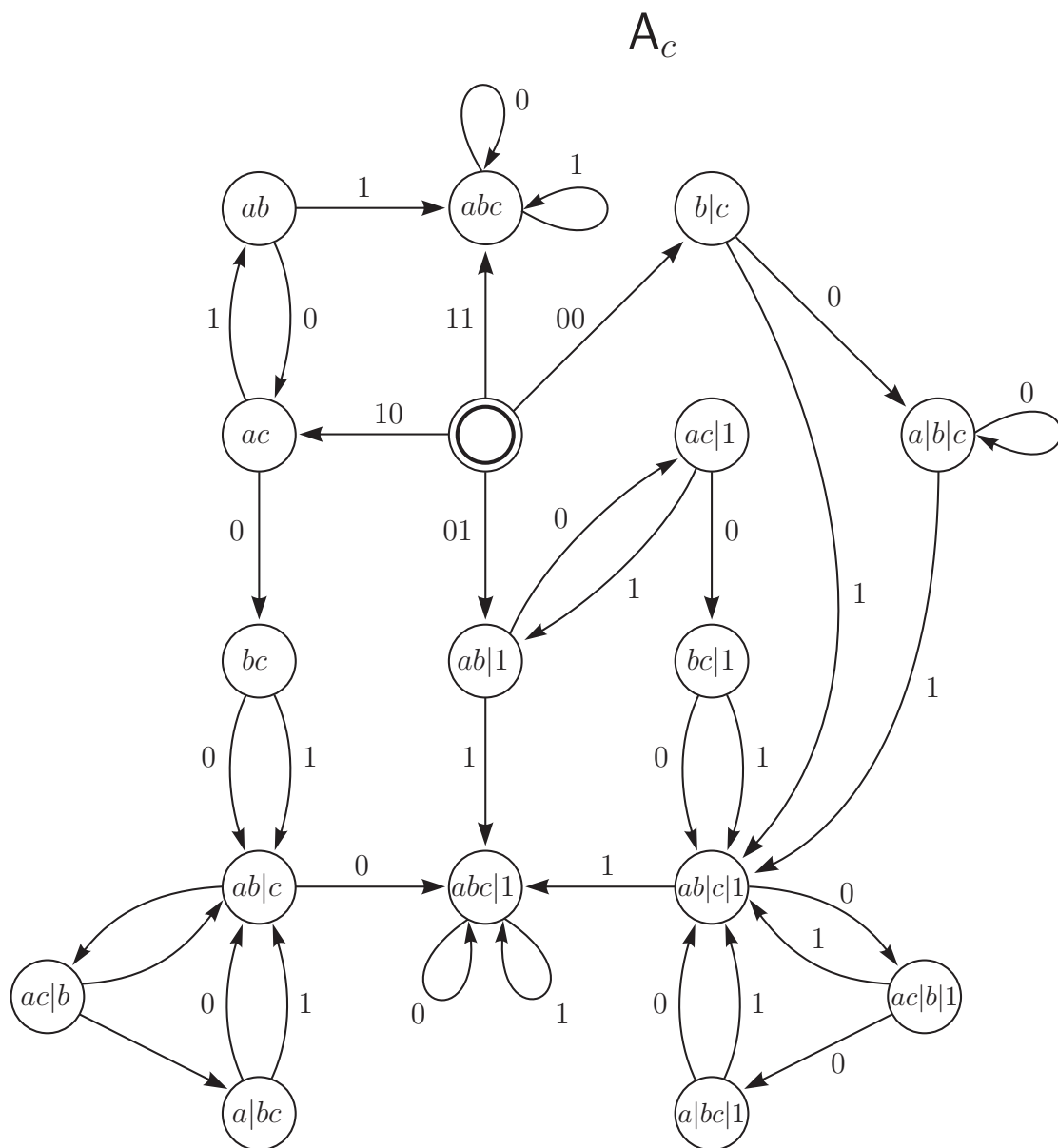

Figure 13: The automaton A_c for $IMG(z^2 + i)$

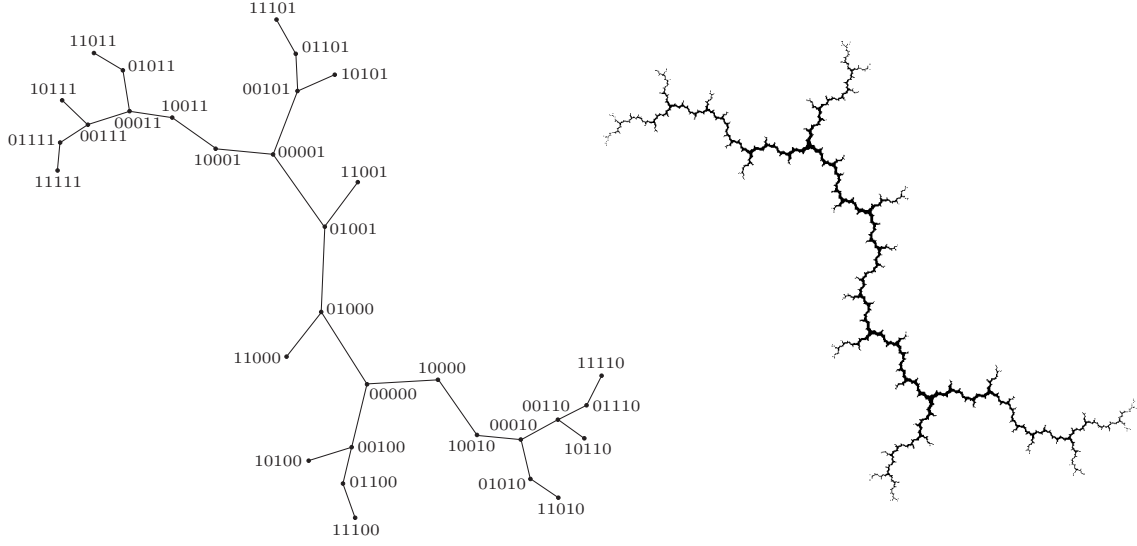

Figure 14: The Schreier graph Γ_5 of the $IMG(z^2 + i)$ and its limit space

be described precisely as follows:

$$C_3 = \bigcup_{k \geq 0} 0(10)^k 0X\mathcal{R} \bigcup_{k \geq 2} 0^k 1\mathcal{R} \bigcup \{0^\omega\}, \quad C_2 = X^\omega \setminus (C_3 \cup C_1), \quad C_1 = \bigcup_{k \geq 0} 1(01)^k 1X^\omega.$$

The set C_3 is of measure zero, and the sets C_1 and C_2 have measure $\frac{1}{3}$ and $\frac{2}{3}$ respectively.

Every graph $T_w \setminus w$ has one, two, or three infinite components. The corresponding sets IC_1 and IC_2 can be described using the automaton A_{ic} as follows:

$$IC_2 = \bigcup_{k \geq 1} (0^k 01\mathcal{R} \cup (10)^k 0X\mathcal{R} \cup 0(10)^k 0X\mathcal{R}),$$

$$IC_3 = \{0^\omega\}, \quad IC_1 = X^\omega \setminus (IC_2 \cup IC_3).$$

The set IC_2 is uncountable but of measure zero.

The limit space \mathcal{J} and the tile \mathcal{T} of the group $IMG(z^2 + i)$ are homeomorphic to the Julia set of the map $z^2 + i$ shown in Figure 14. Every point $t \in \mathcal{J}$ divides the limit space into one, two, or three connected components. The sets \mathcal{C}_1 , \mathcal{C}_2 , and \mathcal{C}_3 of sequences from $X^{-\omega}$, which represent the corresponding points, can be described as follows:

$$\mathcal{C}_3 = \text{Cof}(0^{-\omega}), \quad \mathcal{C}_2 = \mathcal{L}X^* \setminus \mathcal{C}_3, \quad \mathcal{C}_1 = X^{-\omega} \setminus (\mathcal{C}_2 \cup \mathcal{C}_3),$$

where \mathcal{L} is the left one-sided sofic subshift given by the subgraph emphasized in Figure 12. The set \mathcal{C}_3 of three-section points is countable, the set \mathcal{C}_2 of bisection points is uncountable and of measure zero, and the limit space $\mathcal{J} \setminus t$ is connected for almost all points t .

References

- [1] D. Aldous and R. Lyons, Processes on unimodular random networks, *Electr. J. Probab.* **12** (2007), 1454–1508.
- [2] L. Bartholdi and R. Grigorchuk, On the spectrum of Hecke type operators related to some fractal groups, *Tr. Mat. Inst. Steklova* **231** (2000), 5–45.
- [3] L. Bartholdi, R. Grigorchuk, and V. Nekrashevych, From fractal groups to fractal sets, in *Fractals in Graz 2001*, Trends Math., Birkhäuser, Basel, 2003, 25–118.
- [4] L. Bartholdi, A. G. Henriques, and V. Nekrashevych, Automata, groups, limit spaces, and tilings, *J. Algebra* **305** (2006), 629–663.
- [5] I. Bondarenko and V. Nekrashevych, Post-critically finite self-similar groups, *Algebra Discrete Math.* **4** (2003), 21–32.
- [6] I. Bondarenko, Groups generated by bounded automata and their Schreier graphs. Ph.D. Dissertation, Texas A&M University, 2007.
- [7] I. Bondarenko, Growth of Schreier graphs of automaton groups, *Math. Ann.* **354** (2012), 765–785.
- [8] I. Bondarenko, Self-similar groups and the zig-zag and replacement products of graphs, *Journal of Algebra* **434** (2015), 1–11.
- [9] I. Bondarenko and R. Kravchenko, Graph-directed systems and self-similar measures on limit spaces of self-similar groups, *Adv. Math.* **226** (2011), 2169–2191.
- [10] K.-U. Bux and R. Pérez, On the growth of iterated monodromy groups, in: *Topological and asymptotic aspects of group theory*, vol. 394, Contemp. Math., Amer. Math. Soc., Providence, RI, 2006, 61–76.
- [11] D. D’Angeli, A. Donno, M. Matter, and T. Nagnibeda, Schreier graphs of the Basilica group, *J. Mod. Dyn.* **4** (2010), 167–205.
- [12] D. D’Angeli, A. Donno, and T. Nagnibeda, Partition functions of the Ising model on some self-similar Schreier graphs, in: *Random Walks, Boundaries and Spectra* (D. Lenz, F. Sobieczky and W. Woess Eds.), Progress in Prob. Vol. 64, Birkhäuser, Springer, Basel, 2011, 277–304.
- [13] D. D’Angeli, A. Donno, and T. Nagnibeda, Counting dimer coverings on self-similar Schreier graphs, *European Journal of Combinatorics* **33** (2012), 1484–1513.
- [14] T. Delzant and R. Grigorchuk, Homomorphic images of branch groups, and Serre’s property (FA), in: *Geometry and dynamics of groups and spaces*, Progr. Math., 265, Birkhäuser, Basel, 2008, 353–375.

- [15] J. Fabrykowski and N. Gupta, On groups with sub-exponential growth functions II, *J. Indian Math. Soc. (N.S.)* **56** (1991), 217–228.
- [16] R. Grigorchuk, V. Nekrashevych, and V. Sushchanskii, Automata, dynamical systems and groups, *Tr. Mat. Inst. Steklova* **231** (2000), 134–214.
- [17] R. Grigorchuk, D. Savchuk, and Z. Šunić, The spectral problem, substitutions and iterated monodromy, *CRM Proceedings and Lecture Notes* **42** (2007), 225–248.
- [18] R. Grigorchuk and Z. Šunić, Asymptotic aspects of Schreier graphs and Hanoi Towers groups, *C. R. Math. Acad. Sci. Paris* **342** (2006), 545–550.
- [19] R. Grigorchuk and A. Żuk, The lamplighter group as a group generated by a 2-state automaton, and its spectrum, *Geom. Dedicata* **87** (2001), 209–244.
- [20] R. Grigorchuk and A. Żuk, Spectral properties of a torsion-free weakly branch group defined by a three state automaton, in: *Computational and statistical group theory (Las Vegas, NV/Hoboken, NJ, 2001)*, vol. 298, Contemp. Math., Amer. Math. Soc., Providence, RI, 2002, 57–82.
- [21] M. Gromov, Structures métriques pour les variétés riemanniennes, Textes Mathématiques, J. La-fontaine and P. Pansu (Eds.), 1. CEDIC, Paris, 1981. iv+152 pp. ISBN: 2-7124-0714-8.
- [22] J. Kigami, *Analysis on fractals*, Volume 143 of Cambridge Tracts in Mathematics, University Press, Cambridge, 2001.
- [23] M. Matter and T. Nagnibeda, Abelian sandpile model on randomly rooted graphs and self-similar groups, *Israel J. Math.* **199** (2014), 363–420.
- [24] J. P. Previte, Graph substitutions, *Ergodic Theory Dynam. Systems* **18** (1998), 661–685.
- [25] V. Nekrashevych, *Self-similar groups*, Volume 117 of *Mathematical Surveys and Monographs*, Amer. Math. Soc., Providence, RI, 2005.
- [26] V. Nekrashevych, Self-similar groups and their geometry, *Saõ Paulo Journal of Mathematical Sciences* **1** (2007), 41–96.
- [27] V. Nekrashevych, Iterated monodromy groups, in: *Groups St Andrews 2009 in Bath*, vol. 1, London Math. Soc. Lecture Note Ser. 387, Cambridge University Press, Cambridge, 2011, 41–93.
- [28] Z. Šunić, Hausdorff dimension in a family of self-similar groups, *Geometriae Dedicata* **124** (2007), 213–236.
- [29] S. Sidki, Automorphisms of one-rooted trees: growth, circuit structure, and acyclicity, *J. Math. Sci. (New York)* **100** (2000), 1925–1943.

- [30] S. K. Smirnov, On supports of dynamical laminations and biaccessible points in polynomial Julia sets, *Colloq. Math.* **87** (2001), 287–295.
- [31] A. Zdunik, On biaccessible points in Julia sets of polynomials, *Fund. Math.* **163** (2000), 277–286.