

HIGHER SPIN SIX VERTEX MODEL AND SYMMETRIC RATIONAL FUNCTIONS

ALEXEI BORODIN AND LEONID PETROV

ABSTRACT. We consider a fully inhomogeneous stochastic higher spin six vertex model in a quadrant. For this model we derive concise integral representations for multi-point q -moments of the height function and for the q -correlation functions. At least in the case of the step initial condition, our formulas degenerate in appropriate limits to many known formulas of such type for integrable probabilistic systems in the (1+1)d KPZ universality class, including the stochastic six vertex model, ASEP, various q -TASEPs, and associated zero range processes.

Our arguments are largely based on properties of a family of symmetric rational functions that can be defined as partition functions of the inhomogeneous higher spin six vertex model for suitable domains. In the homogeneous case, such functions were previously studied in [Bor14]; they also generalize classical Hall–Littlewood and Schur polynomials. A key role is played by Cauchy-like summation identities for these functions, which are obtained as a direct corollary of the Yang–Baxter equation for the higher spin six vertex model.

CONTENTS

1. Introduction	1
2. Vertex weights	7
3. The Yang–Baxter equation	10
4. Symmetric rational functions	14
5. Stochastic weights and fusion	27
6. Markov kernels and stochastic dynamics	32
7. Orthogonality relations	47
8. q -correlation functions	62
9. q -moments of the height function	74
10. Degenerations of moment formulas	84
References	88

1. INTRODUCTION

1.1. **Preface.** The last two decades have seen remarkable progress in understanding the so-called KPZ universality class in (1+1) dimensions. This is a rather broad and somewhat vaguely defined class of probabilistic systems describing random interface growth, named after a seminal physics paper of Kardar–Parisi–Zhang of 1986 [KPZ86]. A key conjectural property of the systems in this class is that the large time fluctuations of the interfaces should be the same for all of them. See Corwin [Cor12] for an extensive survey.

While proving such a universality principle remains largely out of reach, by now many concrete systems have been found, for which the needed asymptotics was actually computed (the universality principle appears to hold so far).

The first wave of these solved systems started in late 1990’s with the papers of Johansson [Joh01] and Baik–Deift–Johansson [BDJ99], and the key to their solvability, or *integrability*, was in (highly non-obvious) reductions to what physicists would call *free-fermion models* — probabilistic systems, many of

whose observables are expressed in terms of determinants and Pfaffians. Another domain where free-fermion models are extremely important is Random Matrix Theory. Perhaps not surprisingly, the large time fluctuations of the (1+1)d KPZ models are very similar to those arising in (largest eigenvalues of) random matrices with real spectra.

The second wave of integrable (1+1)d KPZ systems started in late 2000's. The reasons for their solvability are harder to see, but one way or another they can be traced to quantum integrable systems. For example, looking at the earlier papers of the second wave we see that: (a) The pioneering work of Tracy–Widom [TW08], [TW09a], [TW09b] on the Asymmetric Simple Exclusion Process (ASEP) was based on the famous idea of Bethe [Bet31] of looking for eigenfunctions of a quantum many-body system in the form of superposition of those for noninteracting bodies (coordinate Bethe ansatz); (b) The work of O'Connell [O'C12] and Borodin–Corwin [BC14] on semi-discrete Brownian polymers utilized properties of eigenfunctions of the Macdonald–Ruijsenaars quantum integrable system — the celebrated Macdonald polynomials and their degenerations; (c) The physics papers of Dotsenko [Dot10] and Calabrese–Le Doussal–Rosso [CLDR10], and a later work of Borodin–Corwin–Sasamoto [BCS14] used a duality trick to show that certain observables of infinite-dimensional models solve finite-dimensional quantum many-body systems that are, in their turn, solvable by the coordinate Bethe ansatz; etc.

In fact, most currently known integrable (1+1)d KPZ models of the second wave come from *one and the same* quantum integrable system: Corwin–Petrov [CP15] recently showed that they can be realized as suitable limits of what they called a *stochastic higher spin vertex model*, see the introduction to their paper for a description of degenerations.¹ They used duality and coordinate Bethe ansatz to show the integrability of their model; the Bethe ansatz part relied on previous works of Borodin–Corwin–Petrov–Sasamoto [BCPS15b], [BCPS15a], and Borodin [Bor14].

The main subject of the present paper is the *inhomogeneous* higher spin six vertex model in infinite volume; one homogeneous version of it is the model of [CP15]. Our main result is an integral representation for certain multi-point q -moments of this model. Such formulas are well known to be a source of meaningful asymptotic results, but we leave asymptotic questions outside of the scope of this paper. Several of those are forthcoming, and they will be presented as separate publications.

At least for the simplest *step initial condition*, our formula for q -moments degenerates, in appropriate limits, to most known formulas of this type, which includes all the models mentioned above. It also generalizes those quite a bit.

We introduce two (infinite) sets of inhomogeneities (space inhomogeneities and spins). Together with another set of time inhomogeneities (spectral parameters) that were already present in [CP15], they supply a large amount of freedom in the model, which can be used to induce unusual phase transitions (that work is also forthcoming). Remarkably, all the parameters enter the expressions for q -moments in a rather benign way, still allowing those to be used for the purpose of accessing the asymptotics. In a way, this is similar to parameters of the Schur and Macdonald processes, cf. Okounkov–Reshetikhin [OR03] and Borodin–Corwin [BC14], but at the moment this is no more than a vague comparison.

Our methods are also new. The core of our proofs consists of the so-called (skew) Cauchy identities for certain rational symmetric functions. They also depend on two families of parameters (the third family — spectral parameters — are their arguments). Homogeneous versions of these functions were introduced in [Bor14]. For special parameter values, these functions turn into (skew) Hall–Littlewood and Schur symmetric functions, and the name “Cauchy identities” is borrowed from the theory of those, cf. Macdonald [Mac95].

Our symmetric rational functions can be defined as partition functions of the higher spin six vertex model for domains with special boundary conditions. Following [Bor14], we use the *Yang–Baxter equation*, or rather its infinite-volume limit, to derive the Cauchy identities. A similar approach to

¹The integrable (1+1)d KPZ models that have not yet been shown to arise as limits of the stochastic vertex models are various versions of PushTASEP, cf. [CP13], [MP15]. This appears to be simply an oversight as those models are diagonalized by the same wavefunctions, which means that needed reductions should also exist.

Cauchy-like identities for the Hall–Littlewood polynomials was also realized by Wheeler–Zinn–Justin in [WZJ15].

Remarkably, the Cauchy identities themselves are essentially sufficient to define our probabilistic models, show their connection to KPZ interfaces, prove orthogonality and completeness of our symmetric rational functions in appropriate functional spaces, and evaluate averages of a large family of observables with respect to our measures. The last bit can be derived from comparing Cauchy identities with different sets of parameters.

While the Cauchy identities also played an important role in the theory of Schur and Macdonald processes, they were never the main heroes there. In the present work they really take the central stage. Given their direct relation to the Yang–Baxter equation, one could thus say that the *integrability of the $(1+1)d$ KPZ models takes its origin in the Yang–Baxter integrability of the six vertex model.*

Our present approach circumvents the duality trick that has been so powerful in treating the integrable $(1+1)d$ KPZ models (including that of [CP15]). We do explain how the duality can be discovered from our results, but we do not prove or rely on it. Unfortunately, for the moment the use and success of the duality approach remains somewhat mysterious and ad hoc; the form of the duality functional needs to be guessed from previously known examples (some of which have better explanations, cf. Schütz [Sch97], Borodin–Corwin [BC13]). We hope that the path that we present here is more straightforward, and that it can be used to shed further light on the existence of nontrivial dualities.

Let us now describe our results in more detail.

1.2. The inhomogeneous model in a quadrant. Consider an ensemble \mathcal{P} of infinite oriented up-right paths drawn in the first quadrant $\mathbb{Z}_{\geq 1}^2$ of the square lattice, with all the paths starting from a left-to-right arrow entering at each of the points $\{(1, m) : m \in \mathbb{Z}_{\geq 1}\}$ on the left boundary (no path enters through the bottom boundary). Assume that no two paths share any horizontal piece (but common vertices and vertical pieces are allowed). See Fig. 1.

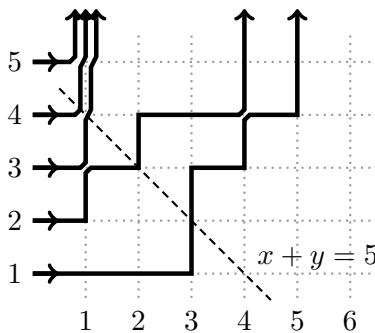

FIGURE 1. A path collection \mathcal{P} .

Define a probability measure on the set of such path ensembles in the following Markovian way. For any $n \geq 2$, assume that we already have a probability distribution on the intersections \mathcal{P}_n of \mathcal{P} with the triangle $T_n = \{(x, y) \in \mathbb{Z}_{\geq 1}^2 : x + y \leq n\}$. We are going to increase n by 1. For each point (x, y) on the upper boundary of T_n , i.e., for $x + y = n$, every \mathcal{P}_n supplies us with two inputs: (1) The number of paths that enter (x, y) from the bottom — denote it by $i_1 \in \mathbb{Z}_{\geq 0}$; (2) The number of paths $j_1 \in \{0, 1\}$ that enter (x, y) from the left. Now choose, independently for all (x, y) on the upper boundary of T_n , the number of paths i_2 that leave (x, y) in the upward direction, and the number of paths j_2 that leave (x, y) in the rightward direction, using the probability distribution with weights of the transitions $(i_1, j_1) \rightarrow (i_2, j_2)$

given by (throughout the text $\mathbf{1}_A$ stands for the indicator function of the event A)

$$\begin{aligned}
\text{Prob}((i_1, 0) \rightarrow (i_2, 0)) &= \frac{1 - q^{i_1} \mathfrak{s}_x \xi_x u_y}{1 - \mathfrak{s}_x \xi_x u_y} \mathbf{1}_{i_1=i_2}, \\
\text{Prob}((i_1, 0) \rightarrow (i_2, 1)) &= \frac{(q^{i_1} - 1) \mathfrak{s}_x \xi_x u_y}{1 - \mathfrak{s}_x \xi_x u_y} \mathbf{1}_{i_1=i_2+1}, \\
\text{Prob}((i_1, 1) \rightarrow (i_2, 1)) &= \frac{q^{i_1} \mathfrak{s}_x^2 - \mathfrak{s}_x \xi_x u_y}{1 - \mathfrak{s}_x \xi_x u_y} \mathbf{1}_{i_1=i_2}, \\
\text{Prob}((i_1, 1) \rightarrow (i_2, 0)) &= \frac{1 - q^{i_1} \mathfrak{s}_x^2}{1 - \mathfrak{s}_x \xi_x u_y} \mathbf{1}_{i_1=i_2-1}.
\end{aligned} \tag{1.1}$$

Assuming that all above expressions are nonnegative, which happens e.g. if $q \in (0, 1)$, $\xi_x, u_y > 0$, $\mathfrak{s}_x \in (-1, 0)$ for all $x, y \in \mathbb{Z}_{\geq 1}$, this procedure defines a probability measure on the set of all \mathcal{P} 's because we always have $\sum_{i_2, j_2} \text{Prob}((i_1, j_1) \rightarrow (i_2, j_2)) = 1$, and $\text{Prob}((i_1, j_1) \rightarrow (i_2, j_2))$ vanishes unless $i_1 + j_1 = i_2 + j_2$.

The right-hand sides in (1.1) are closely related to matrix elements of the R-matrix for $U_q(\widehat{\mathfrak{sl}}_2)$, with one representation being an arbitrary Verma module and the other one being tautological.

Let us briefly discuss the parameters of the model. The parameter q is fixed throughout the paper. Two sets of parameters $\{\xi_x\}$ and $\{u_y\}$ play symmetric roles in (1.1), and they can indeed be mapped to each other by a suitably defined transposition of the quadrant. In our exposition they will play different roles though, with the u_y 's considered *spectral parameters* and the ξ_x 's considered *spatial inhomogeneities*.

The parameters $\{\mathfrak{s}_x\}$ are related to *spins*. If $\mathfrak{s}_x^2 = q^{-I}$ for a positive integer I , then we have $\text{Prob}((I, 1) \rightarrow (I + 1, 0)) = 0$, which means that no more than I paths can share the same vertical piece located at the horizontal coordinate x . This corresponds to replacing the arbitrary Verma module in the R-matrix with its $(I + 1)$ -dimensional irreducible quotient. The spin $\frac{1}{2}$ situation $\mathfrak{s}_x \equiv q^{-\frac{1}{2}}$ gives rise to the stochastic six vertex introduced over 20 years ago by Gwa–Spohn [GS92] (see [BCG14] for its detailed treatment).

The spin parameters $\{\mathfrak{s}_x\}$ are related to columns, and there are no similar row parameters: recall that no two paths can share the same horizontal piece. This restriction can be repaired using the procedure of *fusion* that goes back to [KRS81]. In plain words, fusion means grouping the spectral parameters $\{u_y\}$ into subsequences of the form $\{u, qu, \dots, q^{J-1}u\}$, and collapsing the corresponding J rows onto a single one. Here the positive integer J plays the same role as I in the previous paragraph. The reason we did not use the second set of spin parameters in (1.1) is that the transition probabilities then become rather cumbersome, and one needs to specialize other parameters to achieve simpler expressions. A detailed exposition of the fusion is contained in §5 below.

Let us also note that there are several substantially different possibilities of making the weights (1.1) nonnegative; some of those we consider in detail. Since our techniques are algebraic, our results actually apply to any generic parameter values, with typically only minor modifications needed in case of some denominators vanishing.

1.3. The main result. Encode each path ensemble \mathcal{P} by a *height function* $\mathfrak{h} : \mathbb{Z}_{\geq 1}^2 \rightarrow \mathbb{Z}_{\geq 0}$ which assigns to each vertex (x, y) the number $\mathfrak{h}(x, y)$ of paths in \mathcal{P} that pass through or to the right of this vertex.

Theorem (Theorem 9.8 in the text). *Assume that $q \in (0, 1)$, $\xi_x, u_y > 0$, $\mathfrak{s}_x \in (-1, 0)$ for all $x, y \in \mathbb{Z}_{\geq 1}$, $u_i \neq qu_j$ for any $i, j \geq 1$, and*

$$\inf_{i \geq 1} (\xi_i^{-1} |\mathfrak{s}_i|) > q \cdot \sup_{i \geq 1} (\xi_i^{-1} |\mathfrak{s}_i|), \quad \inf_{i \geq 1} (\xi_i^{-1} |\mathfrak{s}_i|^{-1}) > \sup_{i \geq 1} (\xi_i^{-1} |\mathfrak{s}_i|).$$

Then for any integers $x_1 \geq \dots \geq x_\ell \geq 1$ and $y \geq 1$,

$$\mathbb{E} \prod_{i=1}^{\ell} q^{h(x_i, y)} = q^{\frac{\ell(\ell-1)}{2}} \oint_{\gamma[\bar{u}|1]} \frac{dw_1}{2\pi i} \cdots \oint_{\gamma[\bar{u}|\ell]} \frac{dw_{\ell}}{2\pi i} \prod_{1 \leq \alpha < \beta \leq \ell} \frac{w_{\alpha} - w_{\beta}}{w_{\alpha} - qw_{\beta}} \times \prod_{i=1}^{\ell} \left(w_i^{-1} \prod_{j=1}^{x_i-1} \frac{\xi_j - s_j w_i}{\xi_j - s_j^{-1} w_i} \prod_{j=1}^y \frac{1 - qu_j w_i}{1 - u_j w_i} \right), \quad (1.2)$$

where the expectation is taken with respect to the probability measure defined in §1.2 above, and the integration contours are described in Definitions 8.12 and 9.4 and pictured in Fig. 28 below.

Let us emphasize that the inequalities on the parameters here are exceedingly restrictive; the statement can be analytically continued with suitable modifications of the contours and the integrand. Examples of such analytic continuation can be found in §10, where they are used to degenerate the above result to various q -versions of the T(otally)ASEP.

We also prove integral formulas similar to (1.2) for another set of observables of our model that we call q -correlation functions. The two are related, but in a rather nontrivial way, and one set of formulas does not immediately imply the other.

While at the moment averages (1.2) seem more useful for asymptotic analysis (and that is the reason we list them as our main result), it is entirely possible that the q -correlation functions will become useful for other asymptotic regimes. The definition and the expressions for the q -correlation functions can be found in §8 below.

1.4. Symmetric rational functions. One consequence of the Yang–Baxter integrability of our model is that one can explicitly compute the distribution of intersection points of the paths in \mathcal{P} with any horizontal line. More exactly, let $X_1 \geq \dots \geq X_n \geq 1$ be the x -coordinates of the points where our paths intersect the line $y = \text{const}$ with $n < \text{const} < n + 1$; there are exactly n of those, counting the multiplicities. Then

$$\text{Prob}\{X_1 = \nu_1 + 1, \dots, X_n = \nu_n + 1\} = \prod_{i=1}^n \prod_{j=1}^{\nu_i} (-s_j) \cdot \prod_{k \geq 0} \frac{(s_{k+1}; q)_{n_k}}{(q; q)_{n_k}} \cdot F_{\nu}(u_1, \dots, u_n \mid \{\xi_x\}_{x \geq 1}, \{s_x\}_{x \geq 1}), \quad (1.3)$$

where $(a; q)_m = (1 - a)(1 - aq) \dots (1 - aq^{m-1})$ are the q -Pochhammer symbols, n_k is the multiplicity of k in the sequence $\nu = (\nu_1 \geq \dots \geq \nu_n) = 0^{n_0} 1^{n_1} \dots$, and for any $\mu = (\mu_1 \geq \dots \geq \mu_M \geq 0)$ we define

$$F_{\mu}(u_1, \dots, u_M \mid \{\xi_x\}_{x \geq 0}, \{s_x\}_{x \geq 0}) = \sum_{\sigma \in \mathfrak{S}_M} \sigma \left(\prod_{1 \leq \alpha < \beta \leq M} \frac{u_{\alpha} - qu_{\beta}}{u_{\alpha} - u_{\beta}} \prod_{i=1}^M \varphi_{\mu_i}(u_i \mid \{\xi_x\}_{x \geq 0}, \{s_x\}_{x \geq 0}) \right) \quad (1.4)$$

with $\varphi_k(u \mid \{\xi_x\}_{x \geq 0}, \{s_x\}_{x \geq 0}) = \frac{1 - q}{1 - s_k \xi_k u} \prod_{j=0}^{k-1} \frac{\xi_j u - s_j}{1 - s_j \xi_j u}$, $k \geq 0$. Here \mathfrak{S}_M is the symmetric group of degree M , and its elements σ permute the variables $\{u_i\}_{i=1}^M$ in the right-hand side of (1.4). Note that in the definition (1.4) we shifted the lower limit of the index x in $\{\xi_x\}$ and $\{s_x\}$ from 1 to 0 to conform with the rest of the paper.

The symmetric rational functions $\{F_{\mu}\}$ play a central role in our work (we view spectral variables $\{u_y\}$ as their arguments, and $q, \{\xi_x\}, \{s_x\}$ as parameters). The right-hand side of (1.4) can be viewed as a coordinate Bethe ansatz expression for the eigenfunctions of the transfer-matrix of the higher spin six vertex model. Note that one would need to additionally impose Bethe equations on the u 's for periodic in the x -direction boundary conditions.

The probabilistic interpretation of F_{ν} given above is equivalent to saying that F_{ν} is the partition function for ensembles of n up-right lattice paths that enter the semi-infinite strip $\mathbb{Z}_{\geq 0} \times \{1, \dots, n\}$ at the left boundary at $(0, 1), \dots, (0, n)$ and exit at the top of the strip at locations $(\nu_1, n), \dots, (\nu_n, n)$. The weight of such an ensemble is equal to the product of weights over all vertices of the strip. The vertex

weights for F_ν itself are slightly modified right-hand sides of (1.1) given by (2.1) below. Allowing some paths to enter at the bottom boundary gives a definition of the skew functions $F_{\mu/\lambda}$; removing the paths entering from the left gives a definition of the skew functions $G_{\mu/\lambda}$ and non-skew $G_\mu := G_{\mu/0^M}$, cf. Fig. 9 below. A symmetrization formula for G_μ which is similar to (1.4) is given in Theorem 4.14 below.

Homogeneous versions of the functions F and G were introduced in [Bor14]. As explained there, further degenerations turn them into skew and non-skew Hall–Littlewood and Schur symmetric polynomials.

1.5. Cauchy identities. A basic fact about functions F and G that we heavily use is the following skew Cauchy identity. Let $u, v \in \mathbb{C}$ satisfy

$$\lim_{L \rightarrow +\infty} \prod_{j=0}^L \left| \frac{\xi_j u - s_j}{1 - s_j \xi_j u} \cdot \frac{\xi_j^{-1} v - s_j}{1 - s_j \xi_j^{-1} v} \right| = 0.$$

Then for any nonincreasing integer sequences λ and ν as above, with notation $\Xi = \{\xi_x\}_{x \geq 0}$, $\bar{\Xi} = \{\xi_x^{-1}\}_{x \geq 0}$, and $S = \{s_x\}_{x \geq 0}$, we have

$$\sum_{\kappa} \frac{c_S(\kappa)}{c_S(\lambda)} G_{\kappa/\lambda}(v | \bar{\Xi}, S) F_{\kappa/\nu}(u | \Xi, S) = \frac{1 - quv}{1 - uv} \sum_{\mu} F_{\lambda/\mu}(u | \Xi, S) \frac{c_S(\nu)}{c_S(\mu)} G_{\nu/\mu}(v | \bar{\Xi}, S), \quad (1.5)$$

where $c_S(\alpha) = \prod_{i \geq 0} \frac{(s_i^2; q)_{a_i}}{(q; q)_{a_i}}$ for $\alpha = 0^{a_0} 1^{a_1} \dots$. This identity is a direct consequence of the Yang–Baxter equation for the R-matrix of the higher spin six vertex model. It involves only two spectral parameters u and v and corresponds to permuting two single-row transfer matrices. Identity (1.5) can be immediately iterated to include any finite number of u 's and v 's, and also to involve non-skew functions (by setting ν to \emptyset and/or λ to 0^L).

We put different versions of Cauchy identities to multiple uses:

1. The fact that probabilities (1.3) add up to 1 is a limiting instance of a Cauchy identity. Thus, we can think of the weights of the probability measures we are interested in as of (normalized) terms in a Cauchy identity. Such an interpretation (for other Cauchy identities) lies at the basis of the theory of Schur and Macdonald measures and processes [Oko01], [OR03], [BC14].
2. Markov chains that connect measures of the form (1.3) with different values of n are instances of skew Cauchy identities. Such an interpretation was also previously used in the Schur/Macdonald setting, cf. [BF14], [Bor11], [BC14].
3. Comparing two Cauchy identities which differ by adding a few extra variables leads to the average of an observable with respect to the measure whose weights are given by the terms of the other identity. This fact by itself is a triviality, but we show that it can be used to extract nontrivial consequences. To our knowledge, such use of Cauchy identities is new.
4. In extracting those consequences, a key role is played by a Plancherel theory for the functions $\{F_\mu\}$, and Cauchy identities can be employed to establish certain orthogonality properties of the F_μ 's. This link goes back to [Bor14].

1.6. Plancherel theory. Let us give more details regarding the Plancherel theory for the F_μ 's. The (obvious from (1.4)) shift property

$$F_{\mu+r^M}(u_1, \dots, u_M | \{\xi_x\}_{x \geq 0}, \{s_x\}_{x \geq 0}) = \left(\prod_{i=1}^M \prod_{j=0}^{r-1} \frac{\xi_j u_i - s_j}{1 - s_j \xi_j u_i} \right) F_\mu(u_1, \dots, u_M | \{\xi_x\}_{x \geq r}, \{s_x\}_{x \geq r})$$

allows to extend the definition of the F_μ 's to arbitrary $\mu = (\mu_1 \geq \dots \geq \mu_M) \in \mathbb{Z}^M$. It turns out that these extended F_μ 's form a nice Fourier-like basis in the space of functions $\{f(\mu)\}$. More exactly, we prove that two maps \mathcal{F} and \mathcal{J} which map functions $f(\mu)$ to symmetric rational functions and backwards

defined via

$$\begin{aligned}
(\mathcal{F}f)(u_1, \dots, u_n) &= \sum_{\lambda=(\lambda_1 \geq \dots \geq \lambda_n) \in \mathbb{Z}^n} f(\lambda) F_\lambda(u_1, \dots, u_n | \Xi, \mathbf{S}), \\
(\mathcal{J}R)(\lambda_1, \dots, \lambda_n) &= \frac{c_{\mathbf{S}}(\lambda)}{(1-q)^n} \oint_{\gamma_1^+(\Xi \mathbf{S})} \frac{du_1}{2\pi i} \dots \oint_{\gamma_n^+(\Xi \mathbf{S})} \frac{du_n}{2\pi i} \prod_{1 \leq \alpha < \beta \leq n} \frac{u_\alpha - u_\beta}{u_\alpha - qu_\beta} \frac{R(u_1, \dots, u_n)}{u_1 \dots u_n} \prod_{i=1}^n \varphi_{\lambda_i}(u_i^{-1} | \Xi, \mathbf{S}),
\end{aligned}$$

(with integration contours as in Definition 7.2 and Fig. 23 below), are inverses to each other on appropriately defined functional spaces. In the homogeneous case, those were the main results of Borodin–Corwin–Petrov–Sasamoto [BCPS15a], see also [BCPS15b]. In the case of the inhomogeneous q -Boson model which is slightly lower in the hierarchy than the model we consider here, a very recent work of Wang–Waugh [WW15] shows that for appropriate limits of the above transforms one has $\mathcal{J} \circ \mathcal{F} = \text{Id}$.

The two identities $\mathcal{F} \circ \mathcal{J} = \text{Id}$ and $\mathcal{J} \circ \mathcal{F} = \text{Id}$ can be equivalently stated in terms of orthogonality relations for the basis $\{F_\mu\}$. The latter relation corresponds to the *spatial* orthogonality, where the product of two F 's integrated over their common arguments results in a delta-function in their indices. The former relation corresponds to the *spectral* orthogonality, where the product of two F 's summed over their common index results in a delta-function in the arguments. Our proofs for both types of orthogonality use ideas from existing results in the homogeneous case, that of [BCPS15a] for the spatial one and of [Bor14] for the spectral one (this is where a Cauchy identity is heavily used).

The orthogonality relations play an important role in simplifying the form of the observables extracted from comparisons of Cauchy identities, which eventually results in concise integral formulas for the observables in (1.2) and for the q -correlation functions.

1.7. Organization of the paper. In §2 we define the higher spin six vertex model in the language which is used throughout the paper. The Yang–Baxter integrability of our model is discussed in §3. In §4 we take the infinite volume limit of the Yang–Baxter equation, introduce functions F and G , and derive Cauchy identities and symmetrization type formulas for them. Fusion — a procedure of collapsing several horizontal rows with suitable spectral parameters onto a single one — is discussed in §5. In §6 we use skew Cauchy identities to define various Markov dynamics for our model, and also show how known integrable (1+1)d KPZ models can be obtained from those. In §7 we prove the Plancherel isomorphisms (equivalently, two types of orthogonality relations for the F_μ 's). In §8 we derive integral representations for the q -correlation functions. In §9 we prove our main result — the integral formula (1.2) for the q -moments of the height function. The final §10 demonstrates how our main result degenerates to various similar known results for the models which are hierarchically lower: stochastic six vertex model, ASEP, various q -TASEPs, and associated zero range processes.

Acknowledgments. We are grateful to Ivan Corwin and Vadim Gorin for valuable discussions. We also gratefully acknowledge hospitality and support from the Galileo Galilei Institute for Theoretical Physics during the program “Statistical Mechanics, Integrability and Combinatorics” where parts of this work were completed. A. B. was partially supported by the NSF grant DMS-1056390.

2. VERTEX WEIGHTS

2.1. Higher spin six vertex model. The higher spin six vertex model can be viewed as a way of assigning weights to collections of up-right paths in a finite region of \mathbb{Z}^2 , subject to certain boundary conditions. An example of such a collection of paths is given in Fig. 2. The *weight* of a path collection is equal to the product of weights of all the vertices that belong to the paths. We will always assume that the weight of the empty vertex $\begin{smallmatrix} \circ \\ \vdots \\ \circ \end{smallmatrix}$ is equal to 1. Thus, the weight of a path collection can be equivalently defined as the product of weights of all vertices in \mathbb{Z}^2 .

Note that the weight of a collection of paths is in general not equal to the product of weights of individual paths (defined in an obvious way). But if the paths in a collection have no vertices in

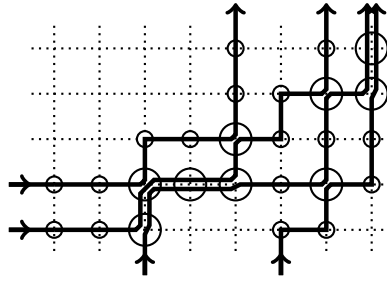

FIGURE 2. An example of a collection of up-right paths in a region in \mathbb{Z}^2 . Note that several paths are allowed to pass along the same edge. At each vertex the total number of incoming arrows (= coming from the left or from below) must be equal to the total number of outgoing ones (= pointing to the right or upwards), cf. Fig. 3. The circles indicate nonempty vertices which contribute to the weight of the path collection.

common, then the weight of this collection will in fact be equal to the product of weights of individual paths.

2.2. **Vertex weights.** We choose the weights of vertices in a special way. First, we postulate that the number of incoming arrows $i_1 + j_1$ into any vertex must be the same as the number of outgoing arrows $i_2 + j_2$, see Fig. 3.

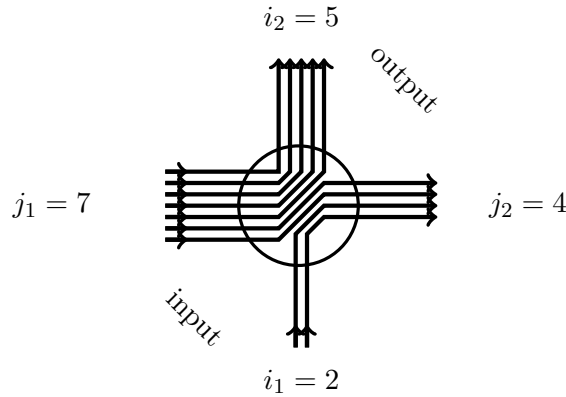

FIGURE 3. Incoming and outgoing vertical and horizontal arrows at a vertex which we will denote by $(i_1, j_1; i_2, j_2) = (2, 7; 5, 4)$.

Remark 2.1. This *arrow preservation* condition obviously fails at the boundaries, so one should either fix boundary conditions in some way, or specify weights on the boundary independently.

The vertex weights will depend on two (generally speaking, complex) parameters that we denote by q and s , and on an additional *spectral parameter* $u \in \mathbb{C}$. All these parameters are assumed to be *generic*². The vertex weights are explicitly given by (see also Fig. 4)

$$\begin{aligned}
 w_{u,s}(g, 0; g, 0) &:= \frac{1 - sq^g u}{1 - su}, & w_{u,s}(g + 1, 0; g, 1) &:= \frac{(1 - s^2 q^g)u}{1 - su}, \\
 w_{u,s}(g, 1; g, 1) &:= \frac{u - sq^g}{1 - su}, & w_{u,s}(g, 1; g + 1, 0) &:= \frac{1 - q^{g+1}}{1 - su},
 \end{aligned}
 \tag{2.1}$$

²That is, vanishing of certain algebraic expressions in the parameters may make some of our statements meaningless. We will not focus on these special cases.

where g is any nonnegative integer. All other weights are assumed to be zero. Note that the weight of the empty vertex \cdots (that is, $(0, 0; 0, 0)$) is indeed equal to 1. Throughout the text, the parameter q is assumed fixed, and u will be regarded as an indeterminate. The dependence on \mathbf{s} will also be reflected in the notation.

Observe that the weights $w_{u,\mathbf{s}}$ (2.1) are nonzero only for $j_1, j_2 \in \{0, 1\}$, that is, the multiplicities of horizontal edges are bounded by 1. This restriction will be removed later (in §5).

$w_{u,\mathbf{s}}$	$\frac{1 - sq^g u}{1 - su}$	$\frac{(1 - s^2 q^{g-1})u}{1 - su}$	$\frac{u - sq^g}{1 - su}$	$\frac{1 - q^{g+1}}{1 - su}$

FIGURE 4. Vertex weights (2.1). Here $g \in \mathbb{Z}_{\geq 0}$ and by agreement, $w_{u,\mathbf{s}}(0, 0; -1, 1) = 0$.

2.3. Motivation. Weights defined in (2.1) are closely related to matrix elements of the higher spin R-matrix associated with $U_q(\widehat{\mathfrak{sl}}_2)$ (e.g., see [Man14] and also [Bax07], [Res10] for a general introduction). Because of this, they satisfy a version of the Yang–Baxter equation which we discuss in §3 below. The exact connection of weights (2.1) with R-matrices is written down in [Bor14, §2], and here we follow the notation of that paper.

For the weights (2.1), the R-matrix in question corresponds to one of the highest weight representations (the “vertical” one) being a generic Verma module (associated with the parameter \mathbf{s}), while the other representation (“horizontal”) is two-dimensional. This choice of the “horizontal” representation dictates the restriction on the horizontal multiplicities $j_1, j_2 \in \{0, 1\}$. Vertex weights associated with other “horizontal” representations (finite-dimensional of dimension $J + 1$, or generic Verma modules) are discussed in §5 below.

If we set $\mathbf{s}^2 = q^{-I}$ with I a positive integer, then matrix elements of the generic Verma module turn into those of the $(I + 1)$ -dimensional highest weight representation (of weight I), and thus the multiplicities of vertical edges will be bounded by I . In particular, setting $I = 1$ leads to the well-known six vertex model (we discuss it in §6.5). Throughout most of the text we will assume, however, that the parameter \mathbf{s} is generic, and so there is no restriction on the vertical multiplicity.

2.4. Conjugated weights and stochastic weights. Here we write down two related versions of the vertex weights which will be later useful for probabilistic applications.

Throughout the text we will employ the q -Pochhammer symbols

$$(z; q)_n := \begin{cases} \prod_{k=0}^{n-1} (1 - zq^k), & n > 0, \\ 1, & n = 0, \\ \prod_{k=0}^{-n-1} (1 - zq^{n+k})^{-1}, & n < 0. \end{cases}$$

If $|q| < 1$ and $n = +\infty$, then the q -Pochhammer symbol $(z; q)_\infty$ also makes sense. We will also use the q -binomial coefficients

$$\binom{n}{k}_q := \frac{(q; q)_n}{(q; q)_k (q; q)_{n-k}}.$$

Define the following *conjugated vertex weights*:

$$w_{u,s}^c(i_1, j_1; i_2, j_2) := \frac{(s^2; q)_{i_2}}{(q; q)_{i_2}} \frac{(q; q)_{i_1}}{(s^2; q)_{i_1}} w_{u,s}(i_1, j_1; i_2, j_2). \quad (2.2)$$

Also define

$$L_{u,s}(i_1, j_1; i_2, j_2) := (-s)^{j_2} w_{u,s}^c(i_1, j_1; i_2, j_2). \quad (2.3)$$

The above quantities are given in Fig. 5. Note that for any $i_1 \in \mathbb{Z}_{\geq 0}$, $j_1 \in \{0, 1\}$ we have

$$\sum_{i_2, j_2 \in \mathbb{Z}_{\geq 0}: i_2 + j_2 = i_1 + j_1} L_{u,s}(i_1, j_1; i_2, j_2) = 1. \quad (2.4)$$

Therefore, if the $L_{u,s}$'s are nonnegative, they can be interpreted as defining a *probability distribution* on all possible output configurations $\{(i_2, j_2): i_2 + j_2 = i_1 + j_1\}$ given the input configuration (i_1, j_1) , cf. Fig. 3. We will discuss values of parameters leading to nonnegative $L_{u,s}$'s in §5.1 below.

A motivation for introducing the conjugated weights $w_{u,s}^c$ can be found in §4.3 below.

				
$w_{u,s}^c$	$\frac{1 - sq^g u}{1 - su}$	$\frac{(1 - q^g)u}{1 - su}$	$\frac{u - sq^g}{1 - su}$	$\frac{1 - s^2 q^g}{1 - su}$
$L_{u,s}$	$\frac{1 - sq^g u}{1 - su}$	$\frac{-su + sq^g u}{1 - su}$	$\frac{-su + s^2 q^g}{1 - su}$	$\frac{1 - s^2 q^g}{1 - su}$

FIGURE 5. Vertex weights (2.2) and (2.3). Note that they automatically vanish at the forbidden configuration $(0, 0; -1, 1)$.

3. THE YANG–BAXTER EQUATION

3.1. The Yang–Baxter equation in coordinate language. The Yang–Baxter equation deals with vertex weights at two vertices connected by a vertical edge, with spectral parameters u_1, u_2 . Define the two-vertex weights by

$$w_{u_1, u_2; s}^{(m, n)}(k_1, k_2; k'_1, k'_2) := \sum_{l \geq 0} w_{u_1, s}(m, k_1; l, k'_1) w_{u_2, s}(l, k_2; n, k'_2), \quad k_1, k_2, k'_1, k'_2 \in \{0, 1\}. \quad (3.1)$$

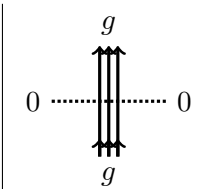
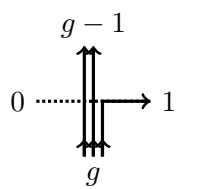
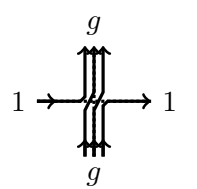
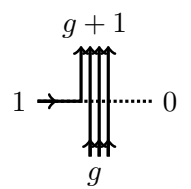
The expression (3.1) is the weight of the two-vertex configuration as in Fig. 6, left, with numbers of incoming and outgoing arrows $m, n, k_{1,2}, k'_{1,2}$ fixed. The number of arrows $l \geq 0$ along the inside edge is arbitrary, but due to the arrow preservation, no more than one value of l contributes to the sum.

Also define

$$\tilde{w}_{u_1, u_2; s}^{(m, n)}(k_1, k_2; k'_1, k'_2) := w_{u_1, u_2; s}^{(m, n)}(k_2, k_1; k'_2, k'_1); \quad (3.2)$$

this is the weight of the configuration as in Fig. 6, right.

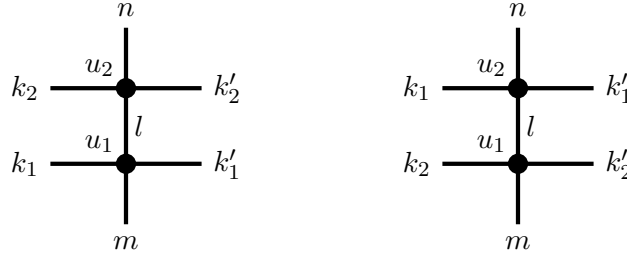

FIGURE 6. Two-vertex configurations corresponding to (3.1) and (3.2), respectively.

Let us organize the weights (3.1) into 4×4 matrices

$$w_{u_1, u_2; \mathbf{s}}^{(m, n)} = \begin{bmatrix} w_{u_1, u_2; \mathbf{s}}^{(m, n)}(0, 0; 0, 0) & w_{u_1, u_2; \mathbf{s}}^{(m, n)}(0, 0; 0, 1) & w_{u_1, u_2; \mathbf{s}}^{(m, n)}(0, 0; 1, 0) & w_{u_1, u_2; \mathbf{s}}^{(m, n)}(0, 0; 1, 1) \\ w_{u_1, u_2; \mathbf{s}}^{(m, n)}(0, 1; 0, 0) & w_{u_1, u_2; \mathbf{s}}^{(m, n)}(0, 1; 0, 1) & w_{u_1, u_2; \mathbf{s}}^{(m, n)}(0, 1; 1, 0) & w_{u_1, u_2; \mathbf{s}}^{(m, n)}(0, 1; 1, 1) \\ w_{u_1, u_2; \mathbf{s}}^{(m, n)}(1, 0; 0, 0) & w_{u_1, u_2; \mathbf{s}}^{(m, n)}(1, 0; 0, 1) & w_{u_1, u_2; \mathbf{s}}^{(m, n)}(1, 0; 1, 0) & w_{u_1, u_2; \mathbf{s}}^{(m, n)}(1, 0; 1, 1) \\ w_{u_1, u_2; \mathbf{s}}^{(m, n)}(1, 1; 0, 0) & w_{u_1, u_2; \mathbf{s}}^{(m, n)}(1, 1; 0, 1) & w_{u_1, u_2; \mathbf{s}}^{(m, n)}(1, 1; 1, 0) & w_{u_1, u_2; \mathbf{s}}^{(m, n)}(1, 1; 1, 1) \end{bmatrix},$$

and similarly for $\tilde{w}_{u_1, u_2; \mathbf{s}}^{(m, n)}$.

Proposition 3.1 (The Yang–Baxter equation). *We have*

$$\tilde{w}_{u_2, u_1; \mathbf{s}}^{(m, n)} = X w_{u_1, u_2; \mathbf{s}}^{(m, n)} X^{-1}, \quad (3.3)$$

where the matrix X depending on u_1 and u_2 is given by

$$X = \begin{bmatrix} u_1 - qu_2 & 0 & 0 & 0 \\ 0 & q(u_1 - u_2) & (1 - q)u_1 & 0 \\ 0 & (1 - q)u_2 & u_1 - u_2 & 0 \\ 0 & 0 & 0 & u_1 - qu_2 \end{bmatrix}. \quad (3.4)$$

Note that X is independent of m and n , and it is this fact that makes the weights $w_{u, \mathbf{s}}$ (2.1) very special. Note also that X matters only up to an overall factor (which can depend on u_1 and u_2). Therefore, X in fact depends only on the ratio of spectral parameters u_1 and u_2 . Finally, observe that X is independent of the parameter \mathbf{s} .

Proof. This equation can be checked directly. Alternatively, as shown in [Bor14, Prop. 2.5], it can be derived from the Yang–Baxter equation for the R-matrices. \square

The conjugated and the stochastic weights ((2.2) and (2.3), respectively), also satisfy certain versions of the Yang–Baxter equation, see, e.g. [CP15, Appendix C].

Remark 3.2. The matrix X (3.4) itself can be viewed as a version of the R-matrix corresponding to both representations being two-dimensional (details may be found in the proof of Proposition 2.5 in [Bor14]).

3.2. The Yang–Baxter equation in operator language. Before drawing corollaries from the Yang–Baxter equation, let us restate it in a different language which is sometimes more convenient.

Consider a vector space $V = \text{span}\{e_i : i = 0, 1, 2, \dots\}$, and linear operators $A(u)$, $B(u)$, $C(u)$, $D(u)$ on this space which depend on a spectral parameter $u \in \mathbb{C}$ and act in this basis as follows (cf. §2.2):

$$\begin{aligned} A(u) e_g &:= w_{u,s} \left(\begin{array}{c} g \\ \text{---} \\ \text{---} \\ \text{---} \\ \text{---} \\ \text{---} \\ \text{---} \\ \text{---} \\ \text{---} \\ \text{---} \\ \text{---} \\ 0 \end{array} \right) e_g = \frac{1 - sq^g u}{1 - su} e_g, & D(u) e_g &:= w_{u,s} \left(\begin{array}{c} g \\ \text{---} \\ \text{---} \\ \text{---} \\ \text{---} \\ \text{---} \\ \text{---} \\ \text{---} \\ \text{---} \\ \text{---} \\ \text{---} \\ 1 \end{array} \right) e_g = \frac{u - sq^g}{1 - su} e_g, \\ B(u) e_g &:= w_{u,s} \left(\begin{array}{c} g+1 \\ \text{---} \\ \text{---} \\ \text{---} \\ \text{---} \\ \text{---} \\ \text{---} \\ \text{---} \\ \text{---} \\ \text{---} \\ \text{---} \\ 0 \end{array} \right) e_{g+1} = \frac{1 - q^{g+1}}{1 - su} e_{g+1}, & C(u) e_g &:= w_{u,s} \left(\begin{array}{c} g-1 \\ \text{---} \\ \text{---} \\ \text{---} \\ \text{---} \\ \text{---} \\ \text{---} \\ \text{---} \\ \text{---} \\ \text{---} \\ \text{---} \\ 1 \end{array} \right) e_{g-1} = \frac{(1 - s^2 q^{g-1})u}{1 - su} e_{g-1}, \end{aligned} \quad (3.5)$$

where $g \in \mathbb{Z}_{\geq 0}$, and, by agreement, $w_{u,s}(0, 0; -1, 1) = 0$. Note that in every vertex $(i_1, j_1; i_2, j_2)$ above, i_1 corresponds to the index of the vector that the operator is applied to, and i_2 corresponds to the index of the image vector. The four possibilities for $j_1, j_2 \in \{0, 1\}$ correspond to the four operators.

These four operators are conveniently united into a 2×2 matrix with operator entries

$$\mathsf{T}(u) := \begin{bmatrix} A(u) & B(u) \\ C(u) & D(u) \end{bmatrix},$$

known as the *monodromy matrix*. It can be viewed as an operator $\mathsf{T}(u): \mathbb{C}^2 \otimes V \rightarrow \mathbb{C}^2 \otimes V$. The space \mathbb{C}^2 is often called the *auxiliary space*, and V is referred to as the *physical*, or *quantum space*.

In terms of the monodromy matrices, the Yang–Baxter equation (Proposition 3.1) takes the form

$$(\mathsf{T}(u_1) \otimes \mathsf{T}(u_2)) = Y(\mathsf{T}(u_2) \otimes \mathsf{T}(u_1))Y^{-1}, \quad (3.6)$$

where

$$Y := (X^{-1})^{\text{transpose}} = \frac{1}{(u_1 - qu_2)(u_2 - qu_1)} \begin{bmatrix} u_2 - qu_1 & 0 & 0 & 0 \\ 0 & u_2 - u_1 & (1 - q)u_2 & 0 \\ 0 & (1 - q)u_1 & q(u_2 - u_1) & 0 \\ 0 & 0 & 0 & u_2 - qu_1 \end{bmatrix},$$

with X given by (3.4).

The tensor product in both sides of (3.6) is taken with respect to the two different auxiliary spaces corresponding to (k_1, k_2) in Fig. 6. Namely, we have

$$\mathsf{T}(u_1) \otimes \mathsf{T}(u_2) = \begin{bmatrix} A(u_1)A(u_2) & A(u_1)B(u_2) & B(u_1)A(u_2) & B(u_1)B(u_2) \\ A(u_1)C(u_2) & A(u_1)D(u_2) & B(u_1)C(u_2) & B(u_1)D(u_2) \\ C(u_1)A(u_2) & C(u_1)B(u_2) & D(u_1)A(u_2) & D(u_1)B(u_2) \\ C(u_1)C(u_2) & C(u_1)D(u_2) & D(u_1)C(u_2) & D(u_1)D(u_2) \end{bmatrix}, \quad (3.7)$$

and similarly,

$$\mathsf{T}(u_2) \otimes \mathsf{T}(u_1) = \begin{bmatrix} A(u_2)A(u_1) & B(u_2)A(u_1) & A(u_2)B(u_1) & B(u_2)B(u_1) \\ C(u_2)A(u_1) & D(u_2)A(u_1) & C(u_2)B(u_1) & D(u_2)B(u_1) \\ A(u_2)C(u_1) & B(u_2)C(u_1) & A(u_2)D(u_1) & B(u_2)D(u_1) \\ C(u_2)C(u_1) & D(u_2)C(u_1) & C(u_2)D(u_1) & D(u_2)D(u_1) \end{bmatrix}. \quad (3.8)$$

See also Fig. 7 for an example.

The Yang–Baxter equation (3.6) in the matrix form allows to extract individual commutation relations between the operators A , B , C , and D . Let us write down relations which will be useful in what follows. Comparing matrix elements $(1, 1)$ on both sides of (3.6) implies

$$A(u_1)A(u_2) = A(u_2)A(u_1). \quad (3.9)$$

Similarly, looking at matrix elements $(1, 4)$ and $(4, 4)$ gives rise to

$$B(u_1)B(u_2) = B(u_2)B(u_1), \quad (3.10)$$

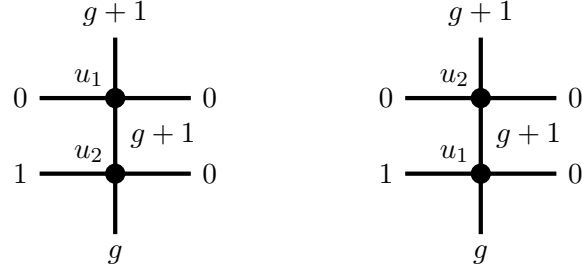

FIGURE 7. The operator $A(u_1)B(u_2)$ applied to the basis vector \mathbf{e}_g corresponds to the configuration on the left, and $A(u_1)B(u_2)\mathbf{e}_g = \tilde{w}_{u_2, u_1; \mathbf{s}}^{(g, g+1)}(0, 1; 0, 0)\mathbf{e}_{g+1}$. Similarly, we have $A(u_2)B(u_1)\mathbf{e}_g = w_{u_1, u_2; \mathbf{s}}^{(g, g+1)}(1, 0; 0, 0)\mathbf{e}_{g+1}$, which corresponds to the configuration on the right.

$$D(u_1)D(u_2) = D(u_2)D(u_1), \quad (3.11)$$

respectively. Looking at matrix elements (2, 4) leads to

$$B(u_1)D(u_2) = \frac{u_1 - u_2}{qu_1 - u_2}D(u_2)B(u_1) + \frac{(1-q)u_2}{u_2 - qu_1}B(u_2)D(u_1). \quad (3.12)$$

Finally, considering matrix elements (2, 1) and (1, 3) implies, respectively,

$$A(u_1)C(u_2) = \frac{u_1 - u_2}{qu_1 - u_2}C(u_2)A(u_1) + \frac{(1-q)u_2}{u_2 - qu_1}A(u_2)C(u_1), \quad (3.13)$$

$$B(u_1)A(u_2) = \frac{u_1 - u_2}{u_1 - qu_2}A(u_2)B(u_1) + \frac{(1-q)u_2}{u_1 - qu_2}B(u_2)A(u_1). \quad (3.14)$$

Remark 3.3. All operators entering the matrices (3.7) and (3.8) and the relations (3.9)–(3.14) correspond to one and the same physical space, and contain the same parameter \mathbf{s} .

3.3. Attaching vertical columns. A very important property of the Yang–Baxter equation is that it survives when one attaches several vertical columns on the side, with the requirement that the conjugating matrix is the same across the vertical columns. Let us consider the situation of two vertical columns (cf. Fig. 8), with different \mathbf{s} -parameters \mathbf{s}_1 and \mathbf{s}_2 , and spectral parameters $\xi_1 u_1$ and $\xi_1 u_2$ in one column and $\xi_2 u_1$ and $\xi_2 u_2$ in the other column, respectively. Here the parameters u_1 and u_2 are as usual constant along horizontal rows, and ξ_1 and ξ_2 are the inhomogeneity parameters which are constant along vertical columns. The spectral parameter at a vertex is the product of the corresponding “ u ” and “ ξ ” parameters. Recall that the conjugating matrix X of Proposition 3.1 depends only on the ratio of spectral parameters in a column and does not depend on \mathbf{s} , so it is the same for our two vertical columns.

Attaching two vertical columns on the side involves summing over all possible intermediate numbers of arrows k'_1 and k'_2 , i.e., this corresponds to taking the product of two 4×4 matrices $w_{\xi_1 u_1, \xi_1 u_2; \mathbf{s}_1}^{(m_1, n_1)}$ and $w_{\xi_2 u_1, \xi_2 u_2; \mathbf{s}_2}^{(m_2, n_2)}$. Clearly, for this product the Yang–Baxter equation (3.3) is not going to change. One can similarly attach an arbitrary finite number of vertical columns with \mathbf{s} -parameters \mathbf{s}_j and spectral parameters $\xi_j u_1$ and $\xi_j u_2$ in the j -th column, and the Yang–Baxter equation will continue to hold.

In the operator language attaching two vertical columns is equivalent to taking a tensor product $V = V_1 \otimes V_2$ of two different physical spaces V_1 and V_2 with the same conjugating matrix X . The monodromy matrix in the space V has the form

$$T = \begin{bmatrix} A & B \\ C & D \end{bmatrix} = \begin{bmatrix} A_2 & B_2 \\ C_2 & D_2 \end{bmatrix} \begin{bmatrix} A_1 & B_1 \\ C_1 & D_1 \end{bmatrix} = \begin{bmatrix} A_2 A_1 + B_2 C_1 & A_2 B_1 + B_2 D_1 \\ C_2 A_1 + D_2 C_1 & C_2 B_1 + D_2 D_1 \end{bmatrix}. \quad (3.15)$$

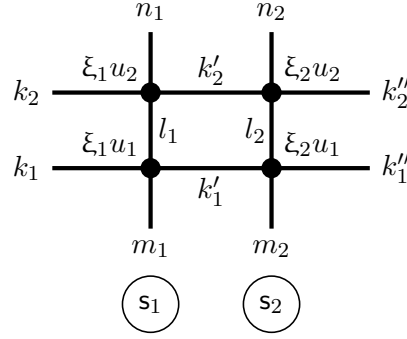

FIGURE 8. Attaching two vertical columns with s -parameters s_j and spectral parameters $\xi_j u_1$ and $\xi_j u_2$ in the j -th column, $j = 1, 2$. The corresponding Yang–Baxter equation continues to hold.

Here the lower index 1 or 2 in the operators above corresponds to the vertical (= physical) space in which they act, i.e., $A_2 = A_2(\xi_2 u | s_2)$ acts in the second vertical column corresponding to the parameter s_2 , and $A_1 = A_1(\xi_1 u | s_1)$ acts in the same way in the first vertical column corresponding to s_1 , and similarly for $B_{1,2}$, $C_{1,2}$, and $D_{1,2}$ (we have omitted spectral parameters in the notation in (3.15)). Note that any two operators with different lower indices commute.

The monodromy matrix $T = T(u | \Xi, S)$ in (3.15), where $\Xi = (\xi_1, \xi_2)$ and $S = (s_1, s_2)$, corresponds to one horizontal row of vertices, and u is the spectral parameter that is constant along this horizontal row. That is, the four matrix elements of $T(u | \Xi, S)$ correspond to the following four configurations:

$$\left[\begin{array}{cc} \begin{array}{c} \xi_1 u \quad | \quad \xi_2 u \\ \bullet \quad \cdots \quad \bullet \\ k' \end{array} & \begin{array}{c} \xi_1 u \quad | \quad \xi_2 u \\ \bullet \quad \cdots \quad \bullet \\ k' \end{array} \\ \begin{array}{c} \xi_1 u \quad | \quad \xi_2 u \\ \bullet \quad \cdots \quad \bullet \\ k' \end{array} & \begin{array}{c} \xi_1 u \quad | \quad \xi_2 u \\ \bullet \quad \cdots \quad \bullet \\ k' \end{array} \end{array} \right],$$

and the two summands in each matrix element in (3.15) correspond to k' being 0 or 1.

Furthermore, tensor products of two monodromy matrices like (3.7) and (3.8) correspond to configurations as in Fig. 8. As follows from the above discussion, these tensor products satisfy the same Yang–Baxter equation (3.6).

4. SYMMETRIC RATIONAL FUNCTIONS

We will now discuss how the setup of §3 can be applied to the physical space corresponding to the semi-infinite horizontal strip. This will lead to an introduction of certain symmetric rational functions which are one of our main objects.

4.1. Signatures. Let us first introduce some necessary notation. By a *signature* of length N we mean a sequence $\lambda = (\lambda_1 \geq \lambda_2 \geq \dots \geq \lambda_N)$, $\lambda_i \in \mathbb{Z}$. The set of all signatures of length N will be denoted by \mathbf{Sign}_N , and \mathbf{Sign}_N^+ will stand for the set of signatures with $\lambda_N \geq 0$. By agreement, by $\mathbf{Sign}_0 = \mathbf{Sign}_0^+$ we will denote the set consisting of the single empty signature \emptyset of length 0. Also let $\mathbf{Sign}^+ := \bigsqcup_{N \geq 0} \mathbf{Sign}_N^+$ denote the set of all possible nonnegative signatures (including the empty one). We will also use the multiplicative notation $\mu = 0^{m_0} 1^{m_1} 2^{m_2} \dots \in \mathbf{Sign}^+$ for signatures, which means that $m_j := |\{i: \mu_i = j\}|$ is the number of parts in μ that are equal to j (m_j is called the *multiplicity* of j).

4.2. Semi-infinite operators A and B and definition of symmetric rational functions. Let us consider the physical space $V = V_0 \otimes V_1 \otimes V_2 \otimes \dots$, i.e., a tensor product of countably many “elementary” physical spaces (each of the latter has basis $\{e_j\}_{j \geq 0}$ marked by $\mathbb{Z}_{\geq 0}$). We will think that V corresponds to the semi-infinite (to the right) row of vertices attached to one another on the side. We will make sense of the infinite tensor product V by requiring that we only consider *finitary* vectors $V^{\text{fin}} \subset V$, i.e., those in which almost all tensor factors are equal to e_0 . Therefore, a natural basis in the space V^{fin} is indexed by nonnegative signatures:

$$e_\mu = e_{m_0} \otimes e_{m_1} \otimes e_{m_2} \otimes \dots, \quad \mu = 0^{m_0} 1^{m_1} 2^{m_2} \dots \in \text{Sign}^+$$

($m_0 + m_1 + \dots$ is the length of the signature μ which is finite). We will work in the space \bar{V}^{fin} of all possible linear combinations of e_μ with complex coefficients.

Definition 4.1. Let us fix (generic complex nonzero) inhomogeneity parameters $\Xi = \{\xi_j\}_{j=0,1,2,\dots}$ and \mathfrak{s} -parameters $\mathfrak{S} = \{s_j\}_{j=0,1,2,\dots}$, similarly to what was done in §3.3 before. Parameters ξ_j and s_j correspond to the “elementary” physical space V_j representing the j -th column in our semi-infinite horizontal row of vertices, $j = 0, 1, \dots$. Also by $\bar{\Xi} = \{\xi_j^{-1}\}_{j=0,1,2,\dots}$ we will denote the inverses of the parameters Ξ (and similarly for $\bar{\mathfrak{S}}$).

Defining the operators A and B acting in \bar{V}^{fin} causes no problems. Indeed, we have for any $N \in \mathbb{Z}_{\geq 0}$ and $\lambda \in \text{Sign}_N^+$:

$$A(u | \Xi, \mathfrak{S}) e_\lambda = \sum_{\mu \in \text{Sign}_N^+} \text{weight}_{\mathfrak{S}} \left(\begin{array}{c} \xi_0 u \downarrow \quad \xi_1 u \downarrow \quad \xi_2 u \uparrow \quad \xi_3 u \downarrow \quad \xi_4 u \downarrow \quad \xi_5 u \uparrow \uparrow \quad \xi_6 u \uparrow \\ \hline 0 \quad \lambda_N \quad \lambda_3 \quad \lambda_2 = \lambda_1 \end{array} \right) e_\mu, \quad (4.1)$$

and

$$B(u | \Xi, \mathfrak{S}) e_\lambda = \sum_{\mu \in \text{Sign}_{N+1}^+} \text{weight}_{\mathfrak{S}} \left(\begin{array}{c} \xi_0 u \downarrow \quad \xi_1 u \uparrow \quad \xi_2 u \uparrow \quad \xi_3 u \downarrow \quad \xi_4 u \downarrow \quad \xi_5 u \uparrow \uparrow \quad \xi_6 u \uparrow \\ \hline 0 \quad \lambda_N \quad \lambda_3 \quad \lambda_2 = \lambda_1 \end{array} \right) e_\mu. \quad (4.2)$$

That is, in (4.1) and (4.2) we sum over all possible signatures μ , and for each fixed μ the coefficient is equal to the weight of the unique path collection connecting the arrow configuration λ to the configuration μ , as shown pictorially (the coefficient is 0 if no admissible path collection exists).³ The subscript \mathfrak{S} in the weights corresponds to taking parameter s_j in the j -th vertex, $j = 0, 1, \dots$. The difference between the action of the operators (4.1) and (4.2) is that in (4.1) the path collection contains N paths connecting λ_j to μ_j , $j = 1, \dots, N$, and in (4.2) there is one additional path starting horizontally at the left boundary, and ending at μ_{N+1} .

Let us denote the coefficients in the sums in (4.1) and (4.2) by $G_{\mu/\lambda}(u | \Xi, \mathfrak{S})$ and $F_{\mu/\lambda}(u | \Xi, \mathfrak{S})$, respectively. Here u is the spectral parameter, and we also explicitly indicate the dependence on the parameters Ξ and \mathfrak{S} (like in the operators $A(u | \Xi, \mathfrak{S})$ and $B(u | \Xi, \mathfrak{S})$).

Remark 4.2. Each coefficient $G_{\mu/\lambda}(u | \Xi, \mathfrak{S})$ and $F_{\mu/\lambda}(u | \Xi, \mathfrak{S})$ in the semi-infinite setting is the same as if we took it in a finite tensor product, with the number of factors $\geq \mu_1 + 1$. It follows that the semi-infinite operators (4.1) and (4.2) satisfy the commutation relations

$$A(u_1 | \Xi, \mathfrak{S}) A(u_2 | \Xi, \mathfrak{S}) = A(u_2 | \Xi, \mathfrak{S}) A(u_1 | \Xi, \mathfrak{S}), \quad B(u_1 | \Xi, \mathfrak{S}) B(u_2 | \Xi, \mathfrak{S}) = B(u_2 | \Xi, \mathfrak{S}) B(u_1 | \Xi, \mathfrak{S}) \quad (4.3)$$

³Recall that the weight of a path collection is defined as the product of weights of all (nonempty) vertices in the corresponding region of \mathbb{Z}^2 , and that the weight of the empty vertex \dashv is 1.

(cf. (3.9) and (3.10)). Indeed, to check the commutation relations, apply them to e_λ and read off the coefficient by each e_μ . One readily sees that each such coefficient by e_μ involves only finite summation.

Similarly, we define the coefficients $G_{\mu/\lambda}(u_1, \dots, u_n | \Xi, S)$ and $F_{\mu/\lambda}(u_1, \dots, u_n | \Xi, S)$ arising from products of our operators in the following way:

$$A(u_1 | \Xi, S) \dots A(u_n | \Xi, S) e_\lambda = \sum_{\mu \in \text{Sign}_N^+} G_{\mu/\lambda}(u_1, \dots, u_n | \Xi, S) e_\mu, \quad (4.4)$$

$$B(u_1 | \Xi, S) \dots B(u_n | \Xi, S) e_\lambda = \sum_{\mu \in \text{Sign}_{N+n}^+} F_{\mu/\lambda}(u_1, \dots, u_n | \Xi, S) e_\mu, \quad (4.5)$$

where $N \in \mathbb{Z}_{\geq 0}$ and $\lambda \in \text{Sign}_N^+$ are arbitrary.

Equivalently, the quantities $G_{\mu/\lambda}(u_1, \dots, u_n | \Xi, S)$ and $F_{\mu/\lambda}(u_1, \dots, u_n | \Xi, S)$ can be defined as certain partition functions in the higher spin six vertex model:

Definition 4.3. Let $N, n \in \mathbb{Z}_{\geq 0}$, $\lambda, \mu \in \text{Sign}_N^+$. Assign to each vertex $(x, y) \in \mathbb{Z} \times \{1, 2, \dots, n\}$ the spectral parameter $\xi_x u_y$ and the s -parameter s_x . Define $G_{\mu/\lambda}(u_1, \dots, u_n | \Xi, S)$ to be the sum of weights of all possible collections of N up-right paths such that they

- start with N vertical edges $(\lambda_i, 0) \rightarrow (\lambda_i, 1)$, $i = 1, \dots, N$,
- end with N vertical edges $(\mu_i, n) \rightarrow (\mu_i, n+1)$, $i = 1, \dots, N$.

See Fig. 9, left. We will also use the abbreviation $G_\mu := G_{\mu/(0,0,\dots,0)}$, which corresponds to the decomposition of $A(u_1 | \Xi, S) \dots A(u_n | \Xi, S)(e_N \otimes e_0 \otimes e_0 \otimes \dots)$.

Definition 4.4. Let $N, n \in \mathbb{Z}_{\geq 0}$, $\lambda \in \text{Sign}_N^+$, $\mu \in \text{Sign}_{N+n}^+$. As before, assign to each vertex $(x, y) \in \mathbb{Z} \times \{1, 2, \dots, n\}$ the spectral parameter $\xi_x u_y$ and the s -parameter s_x . Define $F_{\mu/\lambda}(u_1, \dots, u_n | \Xi, S)$ to be the sum of weights of all possible collections of $N+n$ up-right paths such that they

- start with N vertical edges $(\lambda_i, 0) \rightarrow (\lambda_i, 1)$, $i = 1, \dots, N$, and with n horizontal edges $(-1, y) \rightarrow (0, y)$, $y = 1, \dots, n$,
- end with $N+n$ vertical edges $(\mu_i, n) \rightarrow (\mu_i, n+1)$, $i = 1, \dots, N+n$.

See Fig. 9, right. We will also use the abbreviation $F_\mu := F_{\mu/\emptyset}$, which corresponds to the decomposition of $B(u_1 | \Xi, S) \dots B(u_n | \Xi, S)(e_0 \otimes e_0 \otimes \dots)$.

In both definitions above, if a collection of paths has no interior vertices, we define its weight to be 1. Also, the weight of an empty collection of paths is 0.

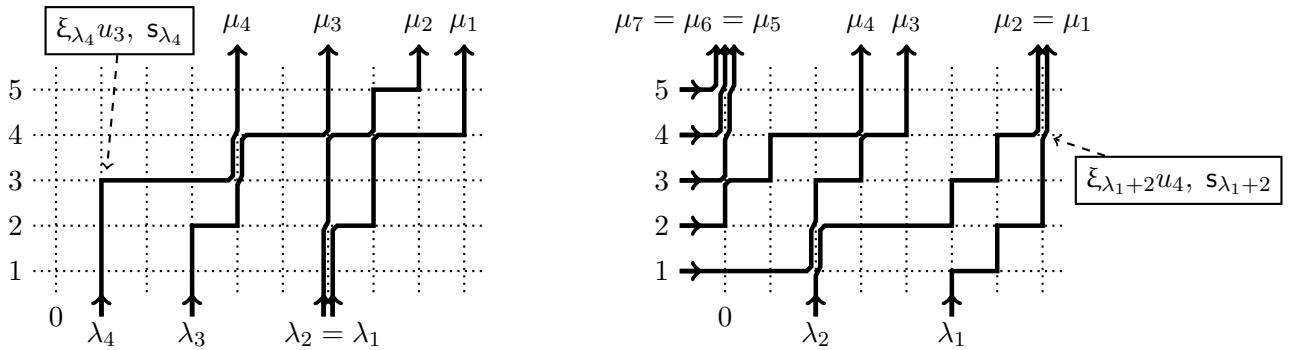

FIGURE 9. Path collections used in the definitions of $G_{\mu/\lambda}$ (left) and $F_{\mu/\lambda}$ (right). The weight of a path collection is the product of weights of all nonempty vertices (cf. Fig. 2). Labels in boxes show examples of spectral parameters $\xi_x u_y$ and parameters s_x at the corresponding vertex (x, y) .

Clearly, both quantities $G_{\mu/\lambda}(u_1, \dots, u_n | \Xi, \mathbf{S})$ and $F_{\mu/\lambda}(u_1, \dots, u_n | \Xi, \mathbf{S})$ depend on the spectral parameters u_1, \dots, u_n in a *rational* way. When the parameters $\xi_j \equiv 1$ and $\mathbf{s}_j \equiv \mathbf{s}$ are constant, the functions $G_{\mu/\lambda}$ and $F_{\mu/\lambda}$ reduce to the ones defined in [Bor14, §3]. Therefore, here we consider *inhomogeneous* versions of the functions from [Bor14].

Proposition 4.5. *The rational functions $F_{\mu/\lambda}(u_1, \dots, u_n | \Xi, \mathbf{S})$ and $G_{\mu/\lambda}(u_1, \dots, u_n | \Xi, \mathbf{S})$ defined above are symmetric with respect to permutations of the u_j 's.*

Proof. This immediately follows from the commutation relations (4.3). \square

The functions $F_{\mu/\lambda}$ and $G_{\mu/\lambda}$ satisfy the following branching rules:

Proposition 4.6. 1. *For any $N, n_1, n_2 \in \mathbb{Z}_{\geq 0}$, $\lambda \in \text{Sign}_N^+$, and $\mu \in \text{Sign}_{N+n_1+n_2}^+$, one has*

$$F_{\mu/\lambda}(u_1, \dots, u_{n_1+n_2} | \Xi, \mathbf{S}) = \sum_{\kappa \in \text{Sign}_{N+n_1}^+} F_{\mu/\kappa}(u_{n_1+1}, \dots, u_{n_1+n_2} | \Xi, \mathbf{S}) F_{\kappa/\lambda}(u_1, \dots, u_{n_1} | \Xi, \mathbf{S}). \quad (4.6)$$

2. *For any $N, n_1, n_2 \in \mathbb{Z}_{\geq 0}$, and $\lambda, \mu \in \text{Sign}_N^+$, one has*

$$G_{\mu/\lambda}(u_1, \dots, u_{n_1+n_2} | \Xi, \mathbf{S}) = \sum_{\kappa \in \text{Sign}_N^+} G_{\mu/\kappa}(u_{n_1+1}, \dots, u_{n_1+n_2} | \Xi, \mathbf{S}) G_{\kappa/\lambda}(u_1, \dots, u_{n_1} | \Xi, \mathbf{S}). \quad (4.7)$$

Proof. Follows from the definitions (4.4) and (4.5) in a straightforward way. In other words, identities (4.6) and (4.7) simply mean the splitting of summation over path collections in $F_{\mu/\lambda}$ and $G_{\mu/\lambda}$, such that the signature κ keeps track of the cross-section of the path collection at height n_1 . \square

Along with Proposition 4.5, one can also establish the following partial symmetry property of the functions $F_{\mu/\lambda}$ and $G_{\mu/\lambda}$ with respect to the inhomogeneity parameters:

Proposition 4.7. *For any interval of consecutive integers $\{i, i+1, \dots, j\} \subset \mathbb{Z} \setminus (\lambda \cup \mu)$, the functions $G_{\mu/\lambda}(u_1, \dots, u_n | \Xi, \mathbf{S})$ and $F_{\mu/\lambda}(u_1, \dots, u_n | \Xi, \mathbf{S})$ from Definitions 4.3 and 4.4 are symmetric with respect to any permutation of the inhomogeneity parameters $\xi_i, \xi_{i+1}, \dots, \xi_j$ and the same (simultaneous) permutation of the \mathbf{s} -parameters $\mathbf{s}_i, \mathbf{s}_{i+1}, \dots, \mathbf{s}_j$.*

Proof. This is a straightforward corollary of a ‘‘horizontal’’ version of the Yang–Baxter equation which is similar to Proposition 3.1, but with a more complicated conjugating matrix related to the general J vertex weights (about those see §5 below). We will not discuss details of this Yang–Baxter equation here, but will note that for $\lambda = \emptyset$ the claim would alternatively follow from the explicit formulas for our symmetric functions, see Theorem 4.14 below. \square

4.3. Semi-infinite operator D. It is slightly more difficult to define the action of the other two operators, C and D, in the semi-infinite context. We will not need the operator C, so let us focus on $D = D(u | \Xi, \mathbf{S})$. The action of D (in a finite tensor product) corresponds to the following configuration (cf. (4.1) and (4.2)):

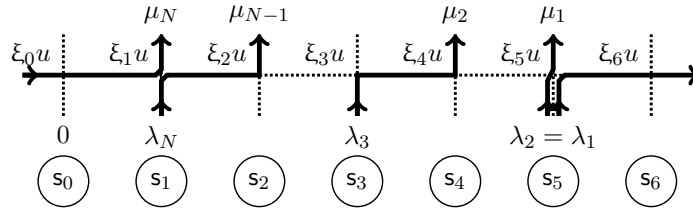

For the semi-infinite horizontal strip, the weight of this configuration would involve an infinite product of the form

$$\prod_{j \geq \lambda_1 + 1} w_{\xi_j u, \mathbf{s}_j}(0, 1; 0, 1) = \prod_{j \geq \lambda_1 + 1} \frac{\xi_j u - \mathbf{s}_j}{1 - \mathbf{s}_j \xi_j u},$$

which means that one cannot define the operator $D(u | \Xi, S)$ in the semi-infinite setting directly.

However, the definition of D can be easily corrected, by considering strips of finite length $L + 1$ and the operators $D(u | \Xi, S)$ in $V_0 \otimes \dots \otimes V_L$. For a fixed L denote such an operator by $D_L = D_L(u | \Xi, S)$. Dividing D_L by $\prod_{j=0}^L w_{\xi_j u, s_j}(0, 1; 0, 1)$, and sending $L \rightarrow +\infty$, we would arrive at a meaningful object. Indeed, under this transformations the weights of individual vertices will turn into

$$\begin{aligned}
\frac{1}{w_{u,s}(0, 1; 0, 1)} w_{u,s} \left(\begin{array}{c} g \\ \vdots \\ 0 \cdots \vdots \cdots 0 \\ \vdots \\ g \end{array} \right) &= \frac{1 - sq^g u}{u - s} = w_{u^{-1}, s} \left(\begin{array}{c} g \\ \vdots \\ 1 \rightarrow \vdots \rightarrow 1 \\ \vdots \\ g \end{array} \right) = w_{u^{-1}, s}^c \left(\begin{array}{c} g \\ \vdots \\ 1 \rightarrow \vdots \rightarrow 1 \\ \vdots \\ g \end{array} \right), \\
\frac{1}{w_{u,s}(0, 1; 0, 1)} w_{u,s} \left(\begin{array}{c} g \\ \vdots \\ 0 \cdots \vdots \rightarrow 1 \\ \vdots \\ g+1 \end{array} \right) &= \frac{(1 - s^2 q^g) u}{u - s} = w_{u^{-1}, s} \left(\begin{array}{c} g+1 \\ \vdots \\ 1 \rightarrow \vdots \rightarrow 0 \\ \vdots \\ g \end{array} \right) \frac{1 - s^2 q^g}{1 - q^{g+1}} = w_{u^{-1}, s}^c \left(\begin{array}{c} g+1 \\ \vdots \\ 1 \rightarrow \vdots \rightarrow 0 \\ \vdots \\ g \end{array} \right), \\
\frac{1}{w_{u,s}(0, 1; 0, 1)} w_{u,s} \left(\begin{array}{c} g \\ \vdots \\ 1 \rightarrow \vdots \rightarrow 1 \\ \vdots \\ g \end{array} \right) &= \frac{u - sq^g}{u - s} = w_{u^{-1}, s} \left(\begin{array}{c} g \\ \vdots \\ 0 \cdots \vdots \rightarrow 0 \\ \vdots \\ g \end{array} \right) = w_{u^{-1}, s}^c \left(\begin{array}{c} g \\ \vdots \\ 0 \cdots \vdots \rightarrow 0 \\ \vdots \\ g \end{array} \right), \\
\frac{1}{w_{u,s}(0, 1; 0, 1)} w_{u,s} \left(\begin{array}{c} g+1 \\ \vdots \\ 1 \rightarrow \vdots \rightarrow 0 \\ \vdots \\ g \end{array} \right) &= \frac{1 - q^{g+1}}{u - s} = w_{u^{-1}, s} \left(\begin{array}{c} g \\ \vdots \\ 0 \cdots \vdots \rightarrow 1 \\ \vdots \\ g+1 \end{array} \right) \frac{1 - q^{g+1}}{1 - s^2 q^g} = w_{u^{-1}, s}^c \left(\begin{array}{c} g \\ \vdots \\ 0 \cdots \vdots \rightarrow 1 \\ \vdots \\ g+1 \end{array} \right),
\end{aligned} \tag{4.8}$$

where we have used the conjugated weights (2.2). Note that the numbers of vertical incoming and outgoing arrows at a vertex were *swapped* under the above transformations. Therefore, for any $L \geq \lambda_1 + 1$ we have

$$\frac{[\text{coefficient of } \mathbf{e}_\mu \text{ in } D_L(u | \Xi, S) \mathbf{e}_\lambda]}{\prod_{j=0}^L w_{\xi_j u, s_j}(0, 1; 0, 1)} = [\text{coefficient of } \mathbf{e}_\lambda \text{ in } A(u^{-1} | \bar{\Xi}, S) \mathbf{e}_\mu] \cdot \frac{c_S(\lambda)}{c_S(\mu)},$$

where for any signature $\nu \in \text{Sign}^+$ we have denoted

$$c_S(\nu) := \prod_{k=0}^{\infty} \frac{(s_k^2; q)_{n_k}}{(q; q)_{n_k}}, \quad \nu = 0^{n_0} 1^{n_1} 2^{n_2} \dots \tag{4.9}$$

(this product has finitely many factors not equal to 1). Recall that $\bar{\Xi}$ means inverting the inhomogeneity parameters, as dictated by the transformations (4.8). The operator $A(u^{-1} | \bar{\Xi}, S)$ above can be regarded as acting either in a finite tensor product, or in the semi-infinite space \bar{V}^{fin} , since matrix elements corresponding to $(\mathbf{e}_\mu, \mathbf{e}_\lambda)$ of these two versions of $A(u^{-1} | \Xi, S)$ coincide for fixed μ, λ and large enough L (cf. Remark 4.2).

We see that it is natural to define the normalized operator

$$\bar{D}(u | \Xi, S) := \lim_{L \rightarrow +\infty} \frac{D_L(u | \Xi, S)}{\prod_{j=0}^L w_{\xi_j u, s_j}(0, 1; 0, 1)}, \tag{4.10}$$

where the limit is taken in the sense of matrix elements corresponding to the basis vectors $\{\mathbf{e}_\lambda\}_{\lambda \in \text{Sign}^+}$. The matrix elements of $\bar{D}(u | \Xi, S)$ are (cf. (4.1))

$$\bar{D}(u | \Xi, S) \mathbf{e}_\lambda = \sum_{\mu \in \text{Sign}_N^+} \frac{c_S(\lambda)}{c_S(\mu)} G_{\lambda/\mu}(u^{-1} | \bar{\Xi}, S) \mathbf{e}_\mu.$$

Observe that the above sum over μ is *finite*, in contrast with the operators (4.1) and (4.2). From (4.10) and (3.11) it follows that the operators $\bar{D}(u | \Xi, S)$ commute for different u .

In what follows we will use the notation

$$F_{\lambda/\mu}^c := \frac{c_S(\lambda)}{c_S(\mu)} F_{\lambda/\mu}, \quad G_{\lambda/\mu}^c := \frac{c_S(\lambda)}{c_S(\mu)} G_{\lambda/\mu}.$$

4.4. Cauchy-type identities from the Yang–Baxter commutation relations. Let us consider the semi-infinite limit as $L \rightarrow +\infty$ (similar to what was done in §4.3 above) of the Yang–Baxter commutation relation (3.12). Looking at (3.12), we immediately face the question of what we need to normalize the two sides by: $\prod_{j=0}^L w_{\xi_j u_1, s_j}(0, 1; 0, 1)$ or $\prod_{j=0}^L w_{\xi_j u_2, s_j}(0, 1; 0, 1)$? Since out of the three terms in (3.12) two require the normalization involving u_2 , let us use that one. To be able to take the limit as $L \rightarrow +\infty$, we will also require that

$$\lim_{L \rightarrow +\infty} \prod_{j=0}^L \left| \frac{w_{\xi_j u_1, s_j}(0, 1; 0, 1)}{w_{\xi_j u_2, s_j}(0, 1; 0, 1)} \right| = \lim_{L \rightarrow +\infty} \prod_{j=0}^L \left| \frac{\xi_j u_1 - s_j}{1 - s_j \xi_j u_1} \cdot \frac{1 - s_j \xi_j u_2}{\xi_j u_2 - s_j} \right| = 0. \quad (4.11)$$

Under (4.11), we can take the normalized (by $\prod_{j=0}^L w_{\xi_j u_2, s_j}(0, 1; 0, 1)$) limit of the relation (3.12), and, using (4.10), conclude that

$$\mathbf{B}(u_1 | \Xi, \mathbf{S}) \bar{\mathbf{D}}(u_2 | \Xi, \mathbf{S}) = \frac{u_1 - u_2}{qu_1 - u_2} \bar{\mathbf{D}}(u_2 | \Xi, \mathbf{S}) \mathbf{B}(u_1 | \Xi, \mathbf{S}). \quad (4.12)$$

Indeed, before the limit the normalized second term of (3.12) contains

$$\frac{\mathbf{D}_L(u_1 | \Xi, \mathbf{S})}{\prod_{j=0}^L w_{\xi_j u_2, s_j}(0, 1; 0, 1)} = \frac{\mathbf{D}_L(u_1 | \Xi, \mathbf{S})}{\prod_{j=0}^L w_{\xi_j u_1, s_j}(0, 1; 0, 1)} \cdot \prod_{j=0}^L \frac{w_{\xi_j u_1, s_j}(0, 1; 0, 1)}{w_{\xi_j u_2, s_j}(0, 1; 0, 1)},$$

which converges to zero by (4.11).

Using the notation $\mathbf{F}_{\mu/\lambda}$ and $\mathbf{G}_{\mu/\lambda}$ introduced in §4.2, relation (4.12) becomes

$$\sum_{\mu \in \text{Sign}^+} \mathbf{F}_{\lambda/\mu}(u_1 | \Xi, \mathbf{S}) \mathbf{G}_{\nu/\mu}^c(u_2^{-1} | \bar{\Xi}, \mathbf{S}) = \frac{u_1 - u_2}{qu_1 - u_2} \sum_{\kappa \in \text{Sign}^+} \mathbf{G}_{\kappa/\lambda}^c(u_2^{-1} | \bar{\Xi}, \mathbf{S}) \mathbf{F}_{\kappa/\nu}(u_1 | \Xi, \mathbf{S}). \quad (4.13)$$

Therefore, we have established the following fact:

Proposition 4.8. *Let $u, v \in \mathbb{C}$ satisfy*

$$\lim_{L \rightarrow +\infty} \prod_{j=0}^L \left| \frac{\xi_j u - s_j}{1 - s_j \xi_j u} \cdot \frac{\xi_j^{-1} v - s_j}{1 - s_j \xi_j^{-1} v} \right| = 0. \quad (4.14)$$

Then for any $\lambda, \nu \in \text{Sign}^+$ we have

$$\sum_{\kappa \in \text{Sign}^+} \mathbf{G}_{\kappa/\lambda}^c(v | \bar{\Xi}, \mathbf{S}) \mathbf{F}_{\kappa/\nu}(u | \Xi, \mathbf{S}) = \frac{1 - quv}{1 - uv} \sum_{\mu \in \text{Sign}^+} \mathbf{F}_{\lambda/\mu}(u | \Xi, \mathbf{S}) \mathbf{G}_{\nu/\mu}^c(v | \bar{\Xi}, \mathbf{S}). \quad (4.15)$$

Proof. Indeed, this is just (4.13) under the replacement of (u_1, u_2) by (u, v^{-1}) . \square

Identity (4.15) is nontrivial only if $\nu \in \text{Sign}_N^+$ and $\lambda \in \text{Sign}_{N+1}^+$. In this case the sum in the right-hand side of (4.15) is over $\mu \in \text{Sign}_N^+$ and is finite, while in the left-hand side it is over $\kappa \in \text{Sign}_{N+1}^+$ and is infinite (but converges due to (4.14)).

We will call (4.15) the *skew Cauchy identity* for the symmetric functions $\mathbf{F}_{\mu/\lambda}$ and $\mathbf{G}_{\mu/\lambda}$ because of its similarity with the skew Cauchy identities for the Schur, Hall–Littlewood, or Macdonald symmetric functions [Mac95, Ch. I.5, Ex. 26, and Ch. VI.7, Ex. 6]. In fact, if $\xi_j \equiv 1$ and $s_j \equiv 0$, our identity (4.15) becomes the skew Cauchy identity for the Hall–Littlewood symmetric functions. Further letting $q \rightarrow 0$, we recover the Schur case.

When the parameters $\xi_j \equiv 1$ and $s_j \equiv s$ are constant, identity (4.15) (and its corollaries below in this subsection) appeared in [Bor14].

Definition 4.9. Let us say that two complex numbers $u, v \in \mathbb{C}$ are *admissible* with respect to the parameters Ξ and \mathbf{S} , denoted $(u, v) \in \text{Adm}_{\Xi, \mathbf{S}}$, if (4.14) holds. A sufficient condition which implies (4.14) is if for some $\epsilon \in (0, 1)$,

$$\left| \frac{\xi_j u - \mathbf{s}_j}{1 - \mathbf{s}_j \xi_j u} \cdot \frac{\xi_j^{-1} v - \mathbf{s}_j}{1 - \mathbf{s}_j \xi_j^{-1} v} \right| < 1 - \epsilon \quad \text{for all } j = 0, 1, 2, \dots \quad (4.16)$$

Note that the relation $(u, v) \in \text{Adm}_{\Xi, \mathbf{S}}$ is *not* symmetric in u and v : $(u, v) \in \text{Adm}_{\Xi, \mathbf{S}} \Leftrightarrow (v, u) \in \text{Adm}_{\bar{\Xi}, \mathbf{S}}$.

The skew Cauchy identity can obviously be iterated with the following result:

Corollary 4.10. *Let u_1, \dots, u_M and v_1, \dots, v_N be complex numbers such that $(u_i, v_j) \in \text{Adm}_{\Xi, \mathbf{S}}$ for all $i = 1, \dots, M$ and $j = 1, \dots, N$. Then for any $\lambda, \nu \in \text{Sign}^+$ one has*

$$\begin{aligned} & \sum_{\kappa \in \text{Sign}^+} \mathbf{G}_{\kappa/\lambda}^c(v_1, \dots, v_N | \bar{\Xi}, \mathbf{S}) \mathbf{F}_{\kappa/\nu}(u_1, \dots, u_M | \Xi, \mathbf{S}) \\ &= \prod_{i=1}^M \prod_{j=1}^N \frac{1 - qu_i v_j}{1 - u_i v_j} \sum_{\mu \in \text{Sign}^+} \mathbf{F}_{\lambda/\mu}(u_1, \dots, u_M | \Xi, \mathbf{S}) \mathbf{G}_{\nu/\mu}^c(v_1, \dots, v_N | \bar{\Xi}, \mathbf{S}). \end{aligned} \quad (4.17)$$

Furthermore, the skew Cauchy identity (4.17) can be simplified by specializing some of the indices. Recall the abbreviations \mathbf{G}_μ and \mathbf{F}_μ from Definitions 4.3 and 4.4. The identity of Corollary 4.10 readily implies the following facts:

Corollary 4.11. 1. *For any $N \in \mathbb{Z}_{\geq 0}$, $\lambda \in \text{Sign}_N^+$, and any complex u_1, \dots, u_N and v such that $(u_i, v) \in \text{Adm}_{\Xi, \mathbf{S}}$ for all i , we have*

$$\sum_{\kappa \in \text{Sign}_N^+} \mathbf{G}_{\kappa/\lambda}^c(v | \bar{\Xi}, \mathbf{S}) \mathbf{F}_\kappa(u_1, \dots, u_N | \Xi, \mathbf{S}) = \prod_{i=1}^N \frac{1 - qu_i v}{1 - u_i v} \mathbf{F}_\lambda(u_1, \dots, u_N | \Xi, \mathbf{S}). \quad (4.18)$$

2. *For any $N, n \in \mathbb{Z}_{\geq 0}$ any $\nu \in \text{Sign}_N^+$, and any complex u and v_1, \dots, v_n such that $(u, v_j) \in \text{Adm}_{\Xi, \mathbf{S}}$ for all j , we have*

$$\sum_{\kappa \in \text{Sign}_{N+1}^+} \mathbf{G}_\kappa^c(v_1, \dots, v_n | \bar{\Xi}, \mathbf{S}) \mathbf{F}_{\kappa/\nu}(u | \Xi, \mathbf{S}) = \frac{1 - q^{N+1}}{1 - \mathbf{s}_0 \xi_0 u} \prod_{j=1}^n \frac{1 - qu v_j}{1 - u v_j} \mathbf{G}_\nu^c(v_1, \dots, v_n | \bar{\Xi}, \mathbf{S}). \quad (4.19)$$

Proof. Identity (4.18) follows from (4.17) by taking $\nu = \emptyset$ and a single v -variable. Then the sum over μ in the right-hand side of (4.17) reduces to just $\mu = \emptyset$.

Identity (4.19) follows by taking $\lambda = 0^{N+1}$ and a single u -variable in (4.17), and observing that $\mathbf{F}_{0^{N+1}/\mu}(u | \Xi, \mathbf{S}) = \frac{1 - q^{N+1}}{1 - \mathbf{s}_0 \xi_0 u} \mathbf{1}_{\mu=0^N}$ by the very definition of \mathbf{F} . \square

Identities (4.18) and (4.19) are analogous to the *Pieri rules* for Schur, Hall–Littlewood, or Macdonald symmetric functions [Mac95, Ch. I.5, formula (5.16), and Ch. VI.6].

Remark 4.12. Identity (4.18) shows that the functions $\{\mathbf{F}_\lambda(u_1, \dots, u_N | \Xi, \mathbf{S})\}_{\lambda \in \text{Sign}_N^+}$ for each set of the u 's form an eigenvector of the transfer matrix $\{\mathbf{G}_{\nu/\lambda}^c(v | \bar{\Xi}, \mathbf{S})\}_{\lambda, \nu \in \text{Sign}_N^+}$ viewed as acting in the spatial variables corresponding to signatures (i.e., with rows indexed by λ and columns indexed by ν). Equivalently, $\{\mathbf{F}_\lambda^c(u_1, \dots, u_N | \Xi, \mathbf{S})\}_{\lambda \in \text{Sign}_N^+}$ is an eigenvector of the transfer matrix $\{\mathbf{G}_{\nu/\lambda}(v | \bar{\Xi}, \mathbf{S})\}_{\lambda, \nu \in \text{Sign}_N^+}$ (i.e., the conjugation “c” can be moved). This statement is parallel (and simpler) to the fact that on a finite lattice, the vector $\mathbf{B}(u_1 | \Xi, \mathbf{S}) \dots \mathbf{B}(u_n | \Xi, \mathbf{S})(\mathbf{e}_0 \otimes \dots \otimes \mathbf{e}_0)$ is an eigenvector of the operator $\mathbf{A}(v | \Xi, \mathbf{S}) + \mathbf{D}(v | \Xi, \mathbf{S})$ given certain nonlinear *Bethe equations* on u_1, \dots, u_N . In our case the Bethe equations disappeared, and only one of the terms in $\mathbf{A}(v | \Xi, \mathbf{S}) + \mathbf{D}(v | \Xi, \mathbf{S})$ has survived.

One can also obtain analogous statements when the number of v -variables in (4.18) is greater than one — this would correspond to applying a sequence of transfer matrices with varying spectral parameters.

Taking $\nu = \emptyset$ and $\lambda = 0^M$ in (4.17) and noting that

$$F_{0^M}(u_1, \dots, u_M | \Xi, \mathbf{S}) = \frac{(q; q)_M}{\prod_{i=1}^M (1 - s_0 \xi_0 u_i)}, \quad (4.20)$$

we arrive at the following analogue of the *usual (non-skew) Cauchy identity* (see [Mac95, Ch. I.4, formula (4.3), and Ch. VI.4, formula (4.13)] for the corresponding Schur and Macdonald Cauchy identities):

Corollary 4.13. *For $M, N \geq 0$ and complex numbers u_1, \dots, u_M and v_1, \dots, v_N such that $(u_i, v_j) \in \text{Adm}_{\Xi, \mathbf{S}}$ for all i and j , one has*

$$\sum_{\mu \in \text{Sign}_M^+} F_\mu(u_1, \dots, u_M | \Xi, \mathbf{S}) G_\mu^c(v_1, \dots, v_N | \bar{\Xi}, \mathbf{S}) = \frac{(q; q)_M}{\prod_{i=1}^M (1 - s_0 \xi_0 u_i)} \prod_{i=1}^M \prod_{j=1}^N \frac{1 - qu_i v_j}{1 - u_i v_j}. \quad (4.21)$$

4.5. Symmetrization formulas. So far, our definition of the symmetric functions $F_{\mu/\lambda}$ and $G_{\nu/\lambda}$ was not too explicit — they were defined as large sums over all possible path collections with certain boundary conditions (see Definitions 4.3 and 4.4). However, it turns out that the non-skew symmetric functions F_μ and G_ν can be evaluated more explicitly.

We will need some notation. Set

$$\varphi_k(u) = \varphi_k(u | \Xi, \mathbf{S}) := \frac{1 - q}{1 - s_k \xi_k u} \prod_{j=0}^{k-1} \frac{\xi_j u - s_j}{1 - s_j \xi_j u}, \quad k \geq 0. \quad (4.22)$$

By agreement, for $k = 0$ the empty product in (4.22) is equal to 1. Note that $\varphi_k(u)$ is equal to $F_{(k)}(u | \Xi, \mathbf{S})$, where (k) is the signature with a single part equal to k . Indeed, for such a signature the path collection of Definition 4.4 consists of a single path whose weight is (4.22), cf. (2.1).

Theorem 4.14. 1. *For any $M \geq 0$, any $\mu \in \text{Sign}_M^+$, and any $u_1, \dots, u_M \in \mathbb{C}$ we have⁴*

$$F_\mu(u_1, \dots, u_M | \Xi, \mathbf{S}) = \sum_{\sigma \in \mathfrak{S}_M} \sigma \left(\prod_{1 \leq \alpha < \beta \leq M} \frac{u_\alpha - qu_\beta}{u_\alpha - u_\beta} \prod_{i=1}^M \varphi_{\mu_i}(u_i | \Xi, \mathbf{S}) \right). \quad (4.23)$$

2. *For any $n \geq 0$, $\nu \in \text{Sign}_n^+$, let k be the number of zero coordinates in ν , i.e., $\nu_{n-k+1} = \dots = \nu_n = 0$. Then for any $N \geq n - k$ and any $v_1, \dots, v_N \in \mathbb{C}$ we have*

$$G_\nu(v_1, \dots, v_N | \Xi, \mathbf{S}) = \frac{(s_0^2; q)_n}{(q; q)_{N-n+k} (s_0^2; q)_k} \times \sum_{\sigma \in \mathfrak{S}_N} \sigma \left(\prod_{1 \leq \alpha < \beta \leq N} \frac{v_\alpha - qv_\beta}{v_\alpha - v_\beta} \prod_{j=1}^N \varphi_{\nu_j}(v_j | \Xi, \mathbf{S}) \prod_{i=1}^{n-k} \frac{\xi_0 v_i}{\xi_0 v_i - s_0} \prod_{j=n-k+1}^N (1 - s_0 q^k \xi_0 v_j) \right). \quad (4.24)$$

By agreement, if needed to make sense of the expressions $\varphi_{\nu_j}(v_j)$ for $j > n$, the signature ν is appended by zeros. If $N < n - k$, the function $G_\nu(v_1, \dots, v_N | \Xi, \mathbf{S})$ vanishes for trivial reasons.

When $\xi_j \equiv 1$ and $s_j \equiv s$, this theorem was established in [Bor14]. Here we present a different proof which involves the operators A, B, C, D from §3.2, and closely follows the algebraic Bethe ansatz framework [FV96], [KBI93]. Let us first discuss certain straightforward corollaries of Theorem 4.14. We will denote by τ_r , $r \in \mathbb{Z}_{\geq 0}$, the *shift operation* applied to the sequence Ξ or \mathbf{S} :

$$(\tau_r \Xi)_j := \xi_{j+r}, \quad (\tau_r \mathbf{S})_j := s_{j+r}. \quad (4.25)$$

⁴In both formulas (4.23) and (4.24) the permutation σ (belonging, respectively, to \mathfrak{S}_M or \mathfrak{S}_N) acts by permuting the indeterminates u_i or v_j , respectively. The same convention is used throughout the text.

Also, for $\mu \in \text{Sign}_M^+$, let $\mu + r^M$ denote the shifted signature $(\mu_1 + r, \mu_2 + r, \dots, \mu_M + r)$.

Corollary 4.15. 1. *For any $\mu \in \text{Sign}_M^+$ and any $r \in \mathbb{Z}_{\geq 0}$ one has*

$$F_{\mu+r^M}(u_1, \dots, u_M \mid \Xi, \mathbf{S}) = \left(\prod_{i=1}^M \prod_{j=0}^{r-1} \frac{\xi_j u_i - s_j}{1 - s_j \xi_j u_i} \right) F_{\mu}(u_1, \dots, u_M \mid \tau_r \Xi, \tau_r \mathbf{S}). \quad (4.26)$$

2. *For any $\nu \in \text{Sign}_N^+$ with $\nu_N \geq 1$ one has*

$$G_{\nu}(v_1, \dots, v_N \mid \Xi, \mathbf{S}) = (s_0^2; q)_N \left(\prod_{i=1}^N \frac{\xi_0 v_i}{\xi_0 v_i - s_0} \right) F_{\nu}(v_1, \dots, v_N \mid \Xi, \mathbf{S}). \quad (4.27)$$

That is, when $k = 0$ and $N = n$ in (4.24), the function $G_{\nu}(v_1, \dots, v_N \mid \Xi, \mathbf{S})$ almost coincides with F_{ν} .

Proof. A straightforward verification using (4.23) and (4.24). Alternatively, the claims immediately follow from the definitions of the functions F and G as partition functions of path collections (Definitions 4.4 and 4.3). \square

The next corollary utilizes the explicit formulas (4.23) and (4.24) in an essential way:

Corollary 4.16. 1. *For any $M \geq 0$, $\mu \in \text{Sign}_M^+$, and $u \in \mathbb{C}$ we have*

$$F_{\mu}(u, qu, \dots, q^{M-1}u \mid \Xi, \mathbf{S}) = (q; q)_M \prod_{i=1}^M \left(\frac{1}{1 - s_{\mu_i} \xi_{\mu_i} q^{i-1} u} \prod_{j=0}^{\mu_i-1} \frac{\xi_j q^{i-1} u - s_j}{1 - s_j \xi_j q^{i-1} u} \right). \quad (4.28)$$

2. *For any $n \geq 0$ and $\nu \in \text{Sign}_n^+$ with k zero coordinates, any $N \geq n - k$, and any $v \in \mathbb{C}$ we have*

$$G_{\nu}(v, qv, \dots, q^{N-1}v \mid \Xi, \mathbf{S}) = \frac{(q; q)_N}{(q; q)_{N-n+k}} \frac{(s_0 \xi_0 v; q)_{N+k}}{(s_0 \xi_0 v; q)_n} \frac{(s_0^2; q)_n}{(s_0^2; q)_k} \frac{1}{(s_0 / (\xi_0 v); q^{-1})_{n-k}} \\ \times \prod_{j=1}^N \left(\frac{1}{1 - s_{\nu_j} \xi_{\nu_j} q^{j-1} v} \prod_{\ell=0}^{\nu_j-1} \frac{\xi_{\ell} q^{j-1} v - s_{\ell}}{1 - s_{\ell} \xi_{\ell} q^{j-1} v} \right). \quad (4.29)$$

Substituting a geometric sequence with ratio q into a function F or G will be referred to as the *principal specialization* of these symmetric functions.

Proof. The substitutions of geometric sequences into F or G make all terms except the one with $\sigma = \text{id}$ vanish due to the presence of the cross term $\sigma \left(\prod_{1 \leq \alpha < \beta \leq M} \frac{u_{\alpha} - q u_{\beta}}{u_{\alpha} - u_{\beta}} \right)$. For $\sigma = \text{id}$ this cross term is equal to $(q; q)_M / (1 - q)^M$. The rest is obtained in a straightforward way by evaluating the remaining parts of the formulas. \square

The proof of Theorem 4.14 occupies the rest of this subsection.

Proof of (4.23). Step 1. To obtain an explicit formula for $F_{\mu}(u_1, \dots, u_M \mid \Xi, \mathbf{S})$, we need to understand how the operator $B(u_1 \mid \Xi, \mathbf{S}) \dots B(u_M \mid \Xi, \mathbf{S})$ acts on the vector $(\mathbf{e}_0 \otimes \mathbf{e}_0 \otimes \dots)$. Let us first consider what happens in the physical space containing just two tensor factors, which puts us into the setting described in §3.3. Let the inhomogeneity parameters in this setting be denoted by (ξ_1, ξ_2) , and the \mathbf{s} -parameters be $(\mathbf{s}_1, \mathbf{s}_2)$, as usual. We have from (3.15):

$$B(u \mid \Xi, \mathbf{S}) = B_1(\xi_1 u \mid \mathbf{s}_1) A_2(\xi_2 u \mid \mathbf{s}_2) + D_1(\xi_1 u \mid \mathbf{s}_1) B_2(\xi_2 u \mid \mathbf{s}_2), \quad (4.30)$$

where the lower indices in the operators in the right-hand side stand for the spaces in which they act (and also determine which of the parameters \mathbf{s}_1 or \mathbf{s}_2 we take). The operators in the right-hand side act as in (3.5). Recall that any two operators with different lower indices commute.

When we multiply together a number of operators $\mathbf{B}(u | \Xi, \mathbf{S})$ (with different spectral u -parameters) and open the parentheses, we collect several factors \mathbf{B}_1 and \mathbf{D}_1 , and several other factors \mathbf{A}_2 and \mathbf{B}_2 . Using the Yang–Baxter commutation relations (3.12) and (3.14), we can swap these operators at the expense of picking certain prefactors, and also this swapping of operators could lead to an exchange of their spectral parameters. Therefore, we can write $\mathbf{B}(u_1 | \Xi, \mathbf{S}) \dots \mathbf{B}(u_M | \Xi, \mathbf{S})(\mathbf{e}_0 \otimes \mathbf{e}_0)$ as a linear combination of vectors of the form

$$\begin{aligned} & \mathbf{B}_1(\xi_1 u_{k_1} | \mathbf{s}_1) \dots \mathbf{B}_1(\xi_1 u_{k_{M-s}} | \mathbf{s}_1) \mathbf{D}_1(\xi_1 u_{\ell_1} | \mathbf{s}_1) \dots \mathbf{D}_1(\xi_1 u_{\ell_s} | \mathbf{s}_1) \mathbf{e}_0 \\ & \quad \otimes \mathbf{B}_2(\xi_2 u_{i_1} | \mathbf{s}_2) \dots \mathbf{B}_2(\xi_2 u_{i_s} | \mathbf{s}_2) \mathbf{A}_2(\xi_2 u_{j_1} | \mathbf{s}_2) \dots \mathbf{A}_2(\xi_2 u_{j_{M-s}} | \mathbf{s}_2) \mathbf{e}_0, \end{aligned} \quad (4.31)$$

with

$$\begin{aligned} \mathcal{I} &= \{i_1 < \dots < i_s\}, & \mathcal{J} &= \{j_1 < \dots < j_{M-s}\}, & \mathcal{I} \sqcup \mathcal{J} &= \{1, \dots, M\}, \\ \mathcal{K} &= \{k_1 < \dots < k_{M-s}\}, & \mathcal{L} &= \{\ell_1 < \dots < \ell_s\}, & \mathcal{K} \sqcup \mathcal{L} &= \{1, \dots, M\}. \end{aligned}$$

Step 2. The coefficients of the vectors (4.31) are computed using only the commutation relations (3.12) and (3.14), and we argue that these coefficients *do not depend* on how exactly we apply the commutation relations to reach the result. This property is based on the fact that for generic spectral parameters, there exists a representation of $\begin{bmatrix} \mathbf{A}(u) & \mathbf{B}(u) \\ \mathbf{C}(u) & \mathbf{D}(u) \end{bmatrix}$ subject to the same commutation relations, and a *highest weight vector* \mathbf{v}_0 in that representation,⁵ such that vectors $\left(\prod_{j \in \mathcal{J}} \mathbf{B}(u_j)\right) \mathbf{v}_0$, with \mathcal{J} ranging over all subsets of $\{1, 2, \dots, M\}$, are linearly independent. This is shown in [FV96, Lemma 14], and we will not repeat the argument here.

Knowing this fact, if we have two ways of applying the commutation relations which yield different coefficients of the vectors (4.31), then we can apply these commutation relations in the above highest weight representation, which leads to a contradiction with the linear independence property.⁶

Step 3. Our next goal is to show that the coefficient of each vector of the form (4.31) vanishes unless $\mathcal{I} \cap \mathcal{K} = \emptyset$. We argue by induction on M . For $M = 1$, the application of the operator (4.30) (with $u = u_1$) to $\mathbf{e}_0 \otimes \mathbf{e}_0$ obviously has this property. When we apply the next operator $\mathbf{B}(u_2 | \Xi, \mathbf{S})$, we see that the sets \mathcal{I} and \mathcal{K} could grow by the element 2, and that they can also lose the element 1 in the process of commuting the \mathbf{D} 's and the \mathbf{A} 's to the right. However, the sets \mathcal{I} and \mathcal{K} cannot gain the element 1. This means that $1 \notin \mathcal{I} \cap \mathcal{K}$. However, we could have applied $\mathbf{B}(u_1 | \Xi, \mathbf{S})\mathbf{B}(u_2 | \Xi, \mathbf{S}) = \mathbf{B}(u_2 | \Xi, \mathbf{S})\mathbf{B}(u_1 | \Xi, \mathbf{S})$ in the opposite order, which implies (by the uniqueness of the coefficients) that $2 \notin \mathcal{I} \cap \mathcal{K}$. Therefore, $\mathcal{I} \cap \mathcal{K} = \emptyset$ for $M = 2$. Clearly, we can continue this argument with more factors in the same way, and conclude that $\mathcal{I} \cap \mathcal{K} = \emptyset$ for any M .

Step 4. Since $\mathcal{I} \sqcup \mathcal{J} = \mathcal{K} \sqcup \mathcal{L} = \{1, \dots, M\}$, we see that $\mathcal{I} = \mathcal{L}$ and $\mathcal{K} = \mathcal{J}$. This implies that the desired action of a product of the \mathbf{B} operators takes the form

$$\begin{aligned} & \mathbf{B}(u_1 | \Xi, \mathbf{S}) \dots \mathbf{B}(u_M | \Xi, \mathbf{S})(\mathbf{e}_0 \otimes \mathbf{e}_0) \\ &= \sum_{\mathcal{K} \subseteq \{1, 2, \dots, M\}} C_{\mathcal{K}} \left(\prod_{k \in \mathcal{K}} \mathbf{B}_1(\xi_1 u_k | \mathbf{s}_1) \prod_{\ell \notin \mathcal{K}} \mathbf{D}_1(\xi_1 u_{\ell} | \mathbf{s}_1) \right) \mathbf{e}_0 \otimes \left(\prod_{\ell \notin \mathcal{K}} \mathbf{B}_2(\xi_2 u_{\ell} | \mathbf{s}_2) \prod_{k \in \mathcal{K}} \mathbf{A}_2(\xi_2 u_k | \mathbf{s}_2) \right) \mathbf{e}_0, \end{aligned} \quad (4.32)$$

with some uniquely defined coefficients $C_{\mathcal{K}}(u_1, \dots, u_M)$, where $\mathcal{K} \subseteq \{1, \dots, M\}$.

Now, since we obviously can permute the spectral parameters u_j without changing the desired action (4.32), by uniqueness of the coefficients we must have

$$C_{\mathcal{K}}(u_{\sigma(1)}, \dots, u_{\sigma(M)}) = C_{\sigma(\mathcal{K})}(u_1, \dots, u_M) \quad \text{for all } \sigma \in \mathfrak{S}_M.$$

⁵Meaning that \mathbf{v}_0 is annihilated by $\mathbf{C}(u)$ and is an eigenvector for $\mathbf{A}(u)$ and $\mathbf{D}(u)$.

⁶Note that we perform the commutations in each of the two tensor factors separately, and thus the statement that the coefficients are uniquely determined is not affected by the presence of the parameters Ξ and \mathbf{S} .

Thus, it suffices to compute these coefficients for $\mathcal{K} = \{1, 2, \dots, r\}$ for each $r = 1, 2, \dots, M$. This can be done by simply opening the parentheses in

$$\begin{aligned} & (\mathbf{B}_1(\xi_1 u_1 | \mathbf{s}_1) \mathbf{A}_2(\xi_2 u_1 | \mathbf{s}_2) + \mathbf{D}_1(\xi_1 u_1 | \mathbf{s}_1) \mathbf{B}_2(\xi_2 u_1 | \mathbf{s}_2)) \dots \\ & \dots (\mathbf{B}_1(\xi_1 u_M | \mathbf{s}_1) \mathbf{A}_2(\xi_2 u_M | \mathbf{s}_2) + \mathbf{D}_1(\xi_1 u_M | \mathbf{s}_1) \mathbf{B}_2(\xi_2 u_M | \mathbf{s}_2)), \end{aligned} \quad (4.33)$$

because the only way to end up with the vector

$$\begin{aligned} & \mathbf{B}_1(\xi_1 u_1 | \mathbf{s}_1) \dots \mathbf{B}_1(\xi_1 u_r | \mathbf{s}_1) \mathbf{D}_1(\xi_1 u_{r+1} | \mathbf{s}_1) \dots \mathbf{D}_1(\xi_1 u_M | \mathbf{s}_1) \mathbf{e}_0 \\ & \otimes \mathbf{B}_2(\xi_2 u_{r+1} | \mathbf{s}_2) \dots \mathbf{B}_2(\xi_2 u_M | \mathbf{s}_2) \mathbf{A}_2(\xi_2 u_1 | \mathbf{s}_2) \dots \mathbf{A}_2(\xi_2 u_r | \mathbf{s}_2) \mathbf{e}_0 \end{aligned}$$

is to use the first summand in (4.33) for $j = 1, \dots, r$, the second summand for $j = r + 1, \dots, M$, and commute all the \mathbf{A}_2 's through the \mathbf{B}_2 's without swapping the spectral parameters. From (3.14) we readily have

$$\mathbf{A}(w_1) \mathbf{B}(w_2) = \frac{w_2 - qw_1}{w_2 - w_1} \mathbf{B}(w_2) \mathbf{A}(w_1) - \frac{(1-q)w_1}{w_2 - w_1} \mathbf{B}(w_1) \mathbf{A}(w_2), \quad (4.34)$$

and we are only interested in the first summand above. Our commutations thus give the coefficient

$$C_{\{1,2,\dots,r\}}(u_1, \dots, u_M) = \prod_{\alpha=1}^r \prod_{\beta=r+1}^M \frac{\xi_2 u_\beta - q \xi_2 u_\alpha}{\xi_2 u_\beta - \xi_2 u_\alpha} = \prod_{\alpha=1}^r \prod_{\beta=r+1}^M \frac{u_\beta - qu_\alpha}{u_\beta - u_\alpha},$$

and so we have

$$\begin{aligned} & \mathbf{B}(u_1 | \Xi, \mathbf{S}) \dots \mathbf{B}(u_M | \Xi, \mathbf{S}) (\mathbf{e}_0 \otimes \mathbf{e}_0) \\ & = \sum_{\mathcal{K} \subseteq \{1, \dots, M\}} \prod_{\substack{\alpha \in \mathcal{K} \\ \beta \notin \mathcal{K}}} \frac{u_\beta - qu_\alpha}{u_\beta - u_\alpha} \left(\prod_{k \in \mathcal{K}} \mathbf{B}_1(\xi_1 u_k | \mathbf{s}_1) \prod_{\ell \notin \mathcal{K}} \mathbf{D}_1(\xi_1 u_\ell | \mathbf{s}_1) \right) \mathbf{e}_0 \\ & \quad \otimes \left(\prod_{\ell \notin \mathcal{K}} \mathbf{B}_2(\xi_2 u_\ell | \mathbf{s}_2) \prod_{k \in \mathcal{K}} \mathbf{A}_2(\xi_2 u_k | \mathbf{s}_2) \right) \mathbf{e}_0. \end{aligned} \quad (4.35)$$

Recall that \mathbf{e}_0 is an eigenvector for \mathbf{D}_1 and \mathbf{A}_2 , and introduce the notation $\mathbf{a}_{1,2}$ and $\mathbf{d}_{1,2}$ by

$$\mathbf{D}_j(\xi_j u | \mathbf{s}_j) \mathbf{e}_0 = \mathbf{d}_j(\xi_j u | \mathbf{s}_j) \mathbf{e}_0, \quad \mathbf{A}_j(\xi_j u | \mathbf{s}_j) \mathbf{e}_0 = \mathbf{a}_j(\xi_j u | \mathbf{s}_j) \mathbf{e}_0, \quad j = 1, 2. \quad (4.36)$$

Thus, $\mathbf{a}_{1,2}$ and $\mathbf{d}_{1,2}$ are eigenvalues (scalars).⁷ Hence our final result (4.35) for two tensor factors can be rewritten in the following form:

$$\mathbf{B}(u_1 | \Xi, \mathbf{S}) \dots \mathbf{B}(u_M | \Xi, \mathbf{S}) (\mathbf{e}_0 \otimes \mathbf{e}_0) = \sum_{\mathcal{K} \subseteq \{1, \dots, M\}} \mathbf{d}_1(\mathcal{K}^c) \mathbf{a}_2(\mathcal{K}) \prod_{\substack{\alpha \in \mathcal{K} \\ \beta \notin \mathcal{K}}} \frac{u_\beta - qu_\alpha}{u_\beta - u_\alpha} (\mathbf{B}_1(\mathcal{K}) \mathbf{e}_0) \otimes (\mathbf{B}_2(\mathcal{K}^c) \mathbf{e}_0), \quad (4.37)$$

where we have abbreviated

$$\mathcal{K}^c := \{1, \dots, M\} \setminus \mathcal{K}, \quad f_j(\mathcal{K}) := \prod_{k \in \mathcal{K}} f_j(\xi_j u_k | \mathbf{s}_j), \quad j = 1, 2, \quad (4.38)$$

so \mathbf{d}_1 and \mathbf{B}_1 include the parameters ξ_1 and \mathbf{s}_1 , and \mathbf{a}_2 and \mathbf{B}_2 contain ξ_2 and \mathbf{s}_2 .

Step 5. In this form the formula (4.37) for two tensor factors can be immediately extended to arbitrarily many tensor factors. Indeed, let us think of the second vector \mathbf{e}_0 as $\tilde{\mathbf{e}}_0 \otimes \tilde{\mathbf{e}}_0$. Then we can use (4.37) to evaluate $\mathbf{B}_2(\mathcal{K}^c) \mathbf{e}_0 = \mathbf{B}_2(\mathcal{K}^c)(\tilde{\mathbf{e}}_0 \otimes \tilde{\mathbf{e}}_0)$, split the second $\tilde{\mathbf{e}}_0$ again, and so on.

⁷ When \mathbf{e}_0 is the highest weight vector in the representation V of §3.2, these eigenvalues can be read off (3.5). However, in Step 5 below we will use notation (4.36) for highest weight vectors of representations obtained by tensoring several such V 's.

Therefore, we obtain the final formula for the action of $B(u_1 | \Xi, S) \dots B(u_M | \Xi, S)$ on the vector $(\mathbf{e}_0 \otimes \mathbf{e}_0 \otimes \dots)$:

$$\begin{aligned} & B(u_1 | \Xi, S) \dots B(u_M | \Xi, S) (\mathbf{e}_0 \otimes \mathbf{e}_0 \otimes \dots) \\ &= \sum_{\substack{\mathcal{K}_0, \mathcal{K}_1, \dots \subseteq \{1, \dots, M\} \\ \mathcal{K}_0 \sqcup \mathcal{K}_1 \sqcup \dots = \{1, 2, \dots, M\}}} \prod_{0 \leq i < j} d_i(\mathcal{K}_j) a_j(\mathcal{K}_i) \prod_{\substack{\alpha \in \mathcal{K}_i \\ \beta \in \mathcal{K}_j}} \frac{u_\beta - qu_\alpha}{u_\beta - u_\alpha} \left(B_0(\mathcal{K}_0) \mathbf{e}_0 \otimes B_1(\mathcal{K}_1) \mathbf{e}_0 \otimes \dots \right), \end{aligned} \quad (4.39)$$

where from now on we denote the inhomogeneity parameters and the s -parameters by $\xi_0, \xi_1, \xi_2, \dots$ and $\mathbf{s}_0, \mathbf{s}_1, \mathbf{s}_2, \dots$, respectively (as in (4.23)).

To finish the derivation of (4.23), we need to recall the action (3.5) of the operators A, B , and D in the ‘‘elementary’’ physical space $\text{span}\{\mathbf{e}_i : i = 0, 1, 2, \dots\}$. We have

$$\begin{aligned} a_j(\mathcal{K}) &= 1, & d_j(\mathcal{K}) &= \prod_{k \in \mathcal{K}} \frac{\xi_j u_k - \mathbf{s}_j}{1 - \mathbf{s}_j \xi_j u_k}, \\ B_j(\mathcal{K}) \mathbf{e}_0 &= \frac{(q; q)_{|\mathcal{K}|}}{\prod_{k \in \mathcal{K}} (1 - \mathbf{s}_j \xi_j u_k)} \mathbf{e}_{|\mathcal{K}|} = \frac{(1 - q)^{|\mathcal{K}|}}{\prod_{k \in \mathcal{K}} (1 - \mathbf{s}_j \xi_j u_k)} \left(\sum_{\sigma \in \mathfrak{S}(\mathcal{K})} \sigma \left(\prod_{\substack{\alpha < \beta \\ \alpha, \beta \in \mathcal{K}}} \frac{u_\alpha - qu_\beta}{u_\alpha - u_\beta} \right) \right) \mathbf{e}_{|\mathcal{K}|}, \end{aligned} \quad (4.40)$$

where for $B_j(\mathcal{K})$ we have used the symmetrization formula [Mac95, Ch. III.1, formula (1.4)]⁸ to insert an additional sum over permutations of \mathcal{K} (here $\mathfrak{S}(\mathcal{K})$ denotes the group of permutations of \mathcal{K} , and σ acts by permuting the corresponding variables).

To read off the coefficient of $\mathbf{e}_\mu = \mathbf{e}_{m_0} \otimes \mathbf{e}_{m_1} \otimes \mathbf{e}_{m_2} \otimes \dots$, $\mu \in \text{Sign}_M^+$, in (4.39), we must have $|\mathcal{K}_i| = m_i$ for all $i \geq 0$. Let us fix one such partition $\mathcal{K}_0 \sqcup \mathcal{K}_1 \sqcup \dots = \{1, \dots, M\}$. For each $\alpha \in \{1, \dots, M\}$, let $k(\alpha) \in \mathbb{Z}_{\geq 0}$ denote the number j such that $\alpha \in \mathcal{K}_j$. Then we can write

$$\prod_{0 \leq i < j} d_i(\mathcal{K}_j) = \prod_{r=1}^M \prod_{\ell=0}^{k(r)-1} \frac{\xi_\ell u_r - \mathbf{s}_\ell}{1 - \mathbf{s}_\ell \xi_\ell u_r},$$

which, combined with the factors $\frac{(1 - q)^{|\mathcal{K}_j|}}{\prod_{k \in \mathcal{K}_j} (1 - \mathbf{s}_j \xi_j u_k)}$ coming from $B_j(\mathcal{K}_j) \mathbf{e}_0$, produces $\prod_{i=1}^M \varphi_{k(i)}(u_i)$.

Note that this product does not change if we permute the u_i ’s within the sets \mathcal{K}_j . Furthermore, we can also write

$$\prod_{0 \leq i < j} \prod_{\substack{\alpha \in \mathcal{K}_i \\ \beta \in \mathcal{K}_j}} \frac{u_\beta - qu_\alpha}{u_\beta - u_\alpha} = \prod_{\substack{1 \leq \alpha, \beta \leq M \\ k(\alpha) < k(\beta)}} \frac{u_\beta - qu_\alpha}{u_\beta - u_\alpha}. \quad (4.41)$$

We then combine this with the remaining coefficients coming from $B_j(\mathcal{K}_j) \mathbf{e}_0$ which involve summations over permutations within the sets \mathcal{K}_j , and compare the result with the desired formula (4.23).

Clearly, fixing a partition into the \mathcal{K}_j ’s corresponds to considering only permutations $\sigma \in \mathfrak{S}_M$ in (4.23) which place each $i \in \{1, \dots, M\}$ into $\mathcal{K}_{k(i)}$. This is the mechanism which gives rise to the summations over permutations within the sets \mathcal{K}_j as in (4.40). One can readily check that the summands agree, and thus (4.23) is established. \square

Remark 4.17. Formula (4.23) that we just established links the algebraic and the coordinate Bethe ansatz. Its proof given above closely follows the proof of Theorem 5 in Section 8 of [FV96]. The key relation (4.39) without proof can be found in [KBI93, Appendix VII.2].

⁸That is, for any $r \in \mathbb{Z}_{\geq 1}$, we have $\sum_{\omega \in \mathfrak{S}_r} \prod_{1 \leq \alpha < \beta \leq r} \frac{u_{\omega(\alpha)} - qu_{\omega(\beta)}}{u_{\omega(\alpha)} - u_{\omega(\beta)}} = \frac{(q; q)_r}{(1 - q)^r}$.

Proof of (4.24). Step 1. We will use the same approach as in the proof of (4.23) to get an explicit formula for $\mathbf{G}_\nu(v_1, \dots, v_N | \Xi, \mathbf{S})$. That is, we need to compute $\mathbf{A}(v_1 | \Xi, \mathbf{S}) \dots \mathbf{A}(v_N | \Xi, \mathbf{S})(\mathbf{e}_n \otimes \mathbf{e}_0 \otimes \mathbf{e}_0 \otimes \dots)$. We start with just two tensor factors, and consider the application of this operator to $\mathbf{e}_n \otimes \mathbf{e}_0$. After that we will use (4.23) to turn the second \mathbf{e}_0 into $\mathbf{e}_0 \otimes \mathbf{e}_0 \otimes \dots$

For two tensor factors we have from (3.15):

$$\mathbf{A}(v | \Xi, \mathbf{S}) = \mathbf{A}_1(\xi_1 v | \mathbf{s}_1) \mathbf{A}_2(\xi_2 v | \mathbf{s}_2) + \mathbf{C}_1(\xi_1 v | \mathbf{s}_1) \mathbf{B}_2(\xi_2 v | \mathbf{s}_2). \quad (4.42)$$

Taking the product $\mathbf{A}(v_1 | \Xi, \mathbf{S}) \dots \mathbf{A}(v_N | \Xi, \mathbf{S})$ and opening the parentheses, we can use the commutation relations (3.13) and (3.14) to express the result as a linear combination of vectors of the form

$$\begin{aligned} & \mathbf{A}_1(\xi_1 v_{k_1} | \mathbf{s}_1) \dots \mathbf{A}_1(\xi_1 v_{k_{N-s}} | \mathbf{s}_1) \mathbf{C}_1(\xi_1 v_{\ell_1} | \mathbf{s}_1) \dots \mathbf{C}_1(\xi_1 v_{\ell_s} | \mathbf{s}_1) \mathbf{e}_n \\ & \otimes \mathbf{B}_2(\xi_2 v_{i_1} | \mathbf{s}_2) \dots \mathbf{B}_2(\xi_2 v_{i_s} | \mathbf{s}_2) \mathbf{A}_2(\xi_2 v_{j_1} | \mathbf{s}_2) \dots \mathbf{A}_2(\xi_2 v_{j_{N-s}} | \mathbf{s}_2) \mathbf{e}_0, \end{aligned} \quad (4.43)$$

with

$$\begin{aligned} \mathcal{I} &= \{i_1 < \dots < i_s\}, & \mathcal{J} &= \{j_1 < \dots < j_{N-s}\}, & \mathcal{I} \sqcup \mathcal{J} &= \{1, \dots, N\}, \\ \mathcal{K} &= \{k_1 < \dots < k_{N-s}\}, & \mathcal{L} &= \{\ell_1 < \dots < \ell_s\}, & \mathcal{K} \sqcup \mathcal{L} &= \{1, \dots, N\}. \end{aligned}$$

Step 2. Again, the key point is that the coefficients by vectors of the form (4.43) are uniquely determined by the commutation relations, and do not depend on the order of commuting. The uniqueness argument here is very similar to the one in Step 2 of the proof of (4.23), and we will not repeat it.

Step 3. We now observe that we must have $\mathcal{I} = \mathcal{L}$ and $\mathcal{J} = \mathcal{K}$. Indeed, let us show that $\mathcal{I} \cap \mathcal{K} = \emptyset$, which would imply the claim. We argue by induction. The case of $N = 1$ is obvious. When we then apply the next operator $\mathbf{A}(v_2 | \Xi, \mathbf{S})$ to (4.42) (with $v = v_1$) and use the commutation relations to write all vectors in the required form (4.43), neither \mathcal{I} nor \mathcal{K} can gain index 1, exactly in the same way as in Step 3 of the proof of (4.23). The fact that $1 \notin \mathcal{I} \cap \mathcal{K}$ does not change after we apply all other operators $\mathbf{A}(v_j | \Xi, \mathbf{S})$, $j = 3, \dots, N$. Since the order of factors in $\mathbf{A}(v_1 | \Xi, \mathbf{S}) \dots \mathbf{A}(v_N | \Xi, \mathbf{S})$ does not matter, we conclude that $\mathcal{I} \cap \mathcal{K} = \emptyset$ for any N .

Step 4. We thus conclude that

$$\mathbf{A}(v_1 | \Xi, \mathbf{S}) \dots \mathbf{A}(v_N | \Xi, \mathbf{S})(\mathbf{e}_n \otimes \mathbf{e}_0) = \sum_{\mathcal{K} \subseteq \{1, 2, \dots, N\}} C_{\mathcal{K}}(\mathbf{A}_1(\mathcal{K}) \mathbf{C}_1(\mathcal{K}^c)) \mathbf{e}_n \otimes (\mathbf{B}_2(\mathcal{K}^c) \mathbf{A}_2(\mathcal{K})) \mathbf{e}_0, \quad (4.44)$$

where we are using the abbreviation (4.38). Here the coefficients $C_{\mathcal{K}}$ are uniquely determined, and satisfy

$$C_{\mathcal{K}}(v_{\sigma(1)}, \dots, v_{\sigma(N)}) = C_{\sigma(\mathcal{K})}(v_1, \dots, v_N) \quad \text{for all } \sigma \in \mathfrak{S}_N.$$

Thus, we need to compute only the coefficients $C_{\mathcal{K}}$ for $\mathcal{K} = \{r+1, \dots, N\}$, where $r = 1, 2, \dots, N$. Since $\nu \in \text{Sign}_n^+$ has exactly k zero coordinates (see (4.24)), we must have $|\mathcal{K}^c| = r = n - k$. Indeed, this is because $\mathbf{C}_1(\mathcal{K}^c)$ is responsible for moving some of n arrows to the right from the location 0.

The coefficients $C_{\{r+1, \dots, N\}}$ can thus be computed by simply opening the parentheses in

$$\begin{aligned} & (\mathbf{A}_1(\xi_1 v_N | \mathbf{s}_1) \mathbf{A}_2(\xi_2 v_N | \mathbf{s}_2) + \mathbf{C}_1(\xi_1 v_N | \mathbf{s}_1) \mathbf{B}_2(\xi_2 v_N | \mathbf{s}_2)) \dots \\ & \dots (\mathbf{A}_1(\xi_1 v_1 | \mathbf{s}_1) \mathbf{A}_2(\xi_2 v_1 | \mathbf{s}_2) + \mathbf{C}_1(\xi_1 v_1 | \mathbf{s}_1) \mathbf{B}_2(\xi_2 v_1 | \mathbf{s}_2)), \end{aligned}$$

and noting that there is a unique way of reaching $\mathcal{K} = \{r+1, \dots, N\}$: pick the first summands in the first $N - r = N - n + k$ factors, the second summands in the last $r = n - k$ factors, and after that move $\mathbf{A}_2(\mathcal{K})$ to the right of $\mathbf{B}_2(\mathcal{K}^c)$ without swapping the spectral parameters in the process of commuting. Using (4.34) (where we are interested only in the first term in the right-hand side), we thus get the product

$$C_{\{n-k+1, \dots, N\}}(v_1, \dots, v_N) = \prod_{\alpha=1}^{n-k} \prod_{\beta=n-k+1}^N \frac{\xi_2 v_\alpha - q \xi_2 v_\beta}{\xi_2 v_\alpha - \xi_2 v_\beta} = \prod_{\alpha=1}^{n-k} \prod_{\beta=n-k+1}^N \frac{v_\alpha - q v_\beta}{v_\alpha - v_\beta}.$$

Next, we note that $A_2(\mathcal{K})\mathbf{e}_0 = \mathbf{e}_0$ and that (from (3.5))

$$A_1(\mathcal{K})C_1(\mathcal{K}^c)\mathbf{e}_n = \frac{(1 - s_1^2 q^{n-1}) \dots (1 - s_1^2 q^k) \xi_1^{n-k} v_1 \dots v_{n-k}}{(1 - s_1 \xi_1 v_1) \dots (1 - s_1 \xi_1 v_{n-k})} \prod_{j=n-k+1}^N \frac{1 - s_1 q^k \xi_1 v_j}{1 - s_1 \xi_1 v_j} \cdot \mathbf{e}_k.$$

Step 5. What remains unaccounted for in (4.44) is $B_2(\mathcal{K})\mathbf{e}_0 = B_2(v_1 | \Xi, \mathbf{S}) \dots B_2(v_{n-k} | \Xi, \mathbf{S})\mathbf{e}_0$. But this was computed earlier in the proof of (4.23), and we can also immediately take the second vector to be $\mathbf{e}_0 \otimes \mathbf{e}_0 \otimes \dots$ instead of just \mathbf{e}_0 . Let now the parameters be denoted by $\xi_0, \xi_1, \xi_2, \dots$ and s_0, s_1, s_2, \dots , as in (4.24), and note that in the part corresponding to $B_2(\mathcal{K})$ we need to take the shifted parameters $\tau_1 \Xi$ and $\tau_1 \mathbf{S}$ (cf. (4.25)). Thus, by (4.5), we have

$$B(v_1 | \tau_1 \Xi, \tau_1 \mathbf{S}) \dots B(v_{n-k} | \tau_1 \Xi, \tau_1 \mathbf{S})(\mathbf{e}_0 \otimes \mathbf{e}_0 \otimes \dots) = \sum_{\kappa \in \text{Sign}_{n-k}^+} F_\kappa(v_1, \dots, v_{n-k} | \tau_1 \Xi, \tau_1 \mathbf{S}) \mathbf{e}_\kappa, \quad (4.45)$$

and so the coefficient of \mathbf{e}_ν (with $\nu \in \text{Sign}_n^+$ having exactly k zero coordinates) in

$$A(v_1 | \Xi, \mathbf{S}) \dots A(v_N | \Xi, \mathbf{S})(\mathbf{e}_n \otimes \mathbf{e}_0 \otimes \mathbf{e}_0 \otimes \dots)$$

is equal to

$$\frac{(s_0^2; q)_n}{(s_0^2; q)_k} \sum_{\substack{\mathcal{K}^c \subseteq \{1, \dots, N\} \\ |\mathcal{K}^c| = n-k}} \prod_{i \in \mathcal{K}^c} \frac{\xi_0 v_i}{1 - s_0 \xi_0 v_i} \prod_{j \in \mathcal{K}} \frac{1 - s_0 q^k \xi_0 v_j}{1 - s_0 \xi_0 v_j} \prod_{\substack{\alpha \in \mathcal{K}^c \\ \beta \in \mathcal{K}}} \frac{v_\alpha - q v_\beta}{v_\alpha - v_\beta} F_{(\nu_1-1, \dots, \nu_{n-k}-1)}(\{v_i\}_{i \in \mathcal{K}^c} | \tau_1 \Xi, \tau_1 \mathbf{S}). \quad (4.46)$$

Indeed, the signature κ in (4.45) corresponds to nonzero parts in ν , and coordinates in κ are counted starting from location 1 (hence the shifts $\nu_i - 1$).

To match (4.46) to (4.24), we use formula (4.23) to write $F_{(\nu_1-1, \dots, \nu_{n-k}-1)}$ as a sum over permutations of \mathcal{K}^c , and insert an additional symmetrization over \mathcal{K} (see footnote⁸):

$$1 = \frac{(1-q)^{N-n+k}}{(q; q)_{N-n+k}} \sum_{\substack{\sigma: \mathcal{K} \rightarrow \mathcal{K} \\ \sigma \text{ is a bijection}}} \sigma \left(\prod_{\substack{\alpha, \beta \in \mathcal{K} \\ \alpha < \beta}} \frac{v_\alpha - q v_\beta}{v_\alpha - v_\beta} \right).$$

After that one readily checks that (4.46) coincides with the desired expression. This concludes the proof of Theorem 4.14. \square

5. STOCHASTIC WEIGHTS AND FUSION

One key object we will consider is the set of probability measures afforded by the Cauchy identities of §4.4. We will describe and study them in §6 below. The present section is devoted to a preliminary discussion of the *fusion procedure* on which some of the constructions of §6 are based.

5.1. Stochastic weights $L_{u,s}$. If we assume that

- $0 < q < 1$;
 - all inhomogeneity parameters ξ_j are positive and are uniformly (in j) bounded away from 0 and $+\infty$;
 - all s -parameters s_j belong to $(-1, 0)$ and are uniformly (in j) bounded away from -1 and 0,
- (5.1)

and, moreover, that

- all spectral parameters u_i are nonnegative,
- (5.2)

then all the vertex weights $w_{u,s}$, $w_{u,s}^c$, and $L_{u,s}$ (see Fig. 4 and 5) are nonnegative. Under these assumptions, (2.4) implies that the stochastic weights $L_{u,s}(i_1, j_1; i_2, j_2)$, where $i_1, i_2 \in \mathbb{Z}_{\geq 0}$ and $j_1, j_2 \in \{0, 1\}$, define a *probability distribution* on all possible output arrow configurations $\{(i_2, j_2) \in \mathbb{Z}_{\geq 0} \times \{0, 1\} : i_2 + j_2 =$

$i_1 + j_1\}$ given the input arrow configuration (i_1, j_1) . We will use conditions (5.1)–(5.2) to define Markov dynamics in §6 below.

The conditions (5.1)–(5.2) are sufficient but not necessary for the nonnegativity of the L_u 's; for other conditions see [CP15, Prop. 2.3] and also §6.5 and §6.6 below.

Remark 5.1. We will always assume that the parameters q and s_j are nonzero. In fact, without this assumption the weights $L_{u,s}$ may still define probability distributions. If q or the s_j 's vanish, then some of our statements remain valid and simplify, but we will not focus on the necessary modifications.

Remark 5.2. Since the stochastic weights $L_{u,s}$ depend on s and u only through su and s^2 , they are invariant under the simultaneous change of sign of both s and u . We have chosen s to be negative, and u will be nonnegative.

5.2. Fusion of stochastic weights. For each $J \in \mathbb{Z}_{\geq 1}$, we will now define certain more general stochastic vertex weights $L_{u,s}^{(J)}(i_1, j_1; i_2, j_2)$, where $(i_1, j_1), (i_2, j_2) \in \mathbb{Z}_{\geq 0} \times \{0, 1, \dots, J\}$. That is, we want to relax the restriction that the horizontal arrow multiplicities are bounded by 1, and consider multiplicities bounded by any fixed $J \geq 1$. When $J = 1$, the vertex weights $L_{u,s}^{(J)}$ will coincide with $L_{u,s}$. Of course, we want the new weights $L_{u,s}^{(J)}$ to share some of the nice properties of the $L_{u,s}$'s; most importantly, the $L_{u,s}^{(J)}$'s should satisfy a version of the Yang–Baxter equation. The construction of the weights $L_{u,s}^{(J)}$ follows the so-called *fusion procedure*, which was invented in a representation-theoretic context [KRS81] (see also [KR87]) to produce higher-dimensional solutions of the Yang–Baxter equation from lower-dimensional ones. Following [CP15], here we describe the fusion procedure in purely combinatorial/probabilistic terms.

We will need the following definition.

Definition 5.3. A probability distribution P on $\{0, 1\}^J$ is called *q-exchangeable* if the probability weights $P(\vec{h})$, $\vec{h} = (h^{(1)}, \dots, h^{(J)}) \in \{0, 1\}^J$, depend on \vec{h} in the following way:

$$P(\vec{h}) = \tilde{P}(j) \cdot \frac{q^{\sum_{r=1}^J (r-1)h^{(r)}}}{Z_j(J)}, \quad j := \sum_{r=1}^J h^{(r)}, \quad (5.3)$$

where \tilde{P} is a probability distribution on $\{0, 1, \dots, J\}$. In words, for a fixed sum of coordinates j , the weights of the conditional distribution of \vec{h} are proportional to the product of the factors q^{r-1} for each coordinate “1” at location $r \in \{1, \dots, J\}$. The normalization constant $Z_j(J)$ is given by the following expression involving the q -binomial coefficient:⁹

$$Z_j(J) = q^{\frac{j(j-1)}{2}} \binom{J}{j}_q = q^{\frac{j(j-1)}{2}} \frac{(q; q)_J}{(q; q)_j (q; q)_{J-j}}. \quad (5.4)$$

The name “ q -exchangeable” refers to the fact that any exchange in \vec{h} of the form $10 \rightarrow 01$ multiplies the weight of \vec{h} by q . See [GO09], [GO10] for a detailed treatment of q -exchangeable distributions.

Returning to vertex weights, a key probabilistic feature observed in [CP15] which triggers the fusion procedure is the following. Attach vertically J vertices with spectral parameters $u, qu, \dots, q^{J-1}u$ (see Fig. 10), and assign to them the corresponding weights $L_{q^i u, s}$ given by (2.3). Fixing the numbers i_1 and i_2 of arrows at the bottom and at the top, we see that this vertex configuration maps probability distributions P_1 on incoming arrows $h_1^{(1)}, \dots, h_1^{(J)}$ to probability distributions P_2 on outgoing arrows $h_2^{(1)}, \dots, h_2^{(J)}$.

Proposition 5.4. *The mapping $P_1 \mapsto P_2$ described above preserves the class of q -exchangeable distributions.*

⁹Indeed, $Z_j(J)$ is the sum of $q^{\sum_{r=1}^J (r-1)h^{(r)}}$ over all $\vec{h} \in \{0, 1\}^J$ with $\sum_{r=1}^J h^{(r)} = j$. Considering two cases $h^{(J)} = 1$ or $h^{(J)} = 0$, we see that it satisfies the recursion $Z_j(J) = q^{J-1}Z_{j-1}(J-1) + Z_j(J-1)$, with $Z_0(J) = 1$. This recursion is solved by (5.4).

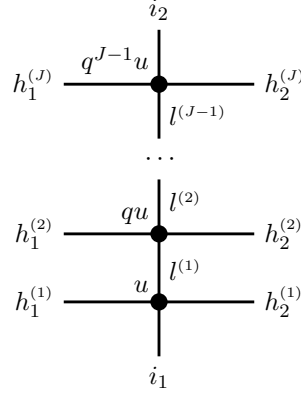

FIGURE 10. Attaching J vertices with spectral parameters $u, qu, \dots, q^{J-1}u$ vertically.

Proof. Let us fix the numbers $i_1, i_2 \in \mathbb{Z}_{\geq 0}$ of bottom and top arrows, as well as the total number $j_1 = \sum_{\ell=1}^J h_1^{(\ell)} \in \{0, 1, \dots, J\}$ of incoming arrows from the left. Under these conditions, the incoming q -exchangeable distribution P_1 is unique (its partition function is $Z_{j_1}(J)$). It suffices to show that for any $\vec{h}_2 \in \{0, 1\}^J$ with $h_2^{(r)} = 0$, $h_2^{(r+1)} = 1$ for some r , we have

$$P_2(h_2^{(1)}, \dots, h_2^{(r)}, h_2^{(r+1)}, \dots, h_2^{(J)}) = q \cdot P_2(h_2^{(1)}, \dots, h_2^{(r+1)}, h_2^{(r)}, \dots, h_2^{(J)}).$$

Since this property involves only two neighboring vertices, it suffices to consider the case $J = 2$. The desired statement now follows from the relations (here g is arbitrary):

$$\begin{aligned} \text{weight} \left(\begin{array}{c} g-1 \\ \begin{array}{ccc} 0 & \cdots & 1 \\ \vdots & & \vdots \\ 0 & \cdots & 0 \end{array} \\ g \end{array} \right) &= q \cdot \text{weight} \left(\begin{array}{c} g-1 \\ \begin{array}{ccc} 0 & \cdots & 0 \\ \vdots & & \vdots \\ 0 & \cdots & 1 \end{array} \\ g \end{array} \right), \\ \text{weight} \left(\begin{array}{c} g+1 \\ \begin{array}{ccc} 1 & \cdots & 1 \\ \vdots & & \vdots \\ 1 & \cdots & 0 \end{array} \\ g \end{array} \right) &= q \cdot \text{weight} \left(\begin{array}{c} g+1 \\ \begin{array}{ccc} 1 & \cdots & 0 \\ \vdots & & \vdots \\ 1 & \cdots & 1 \end{array} \\ g \end{array} \right), \\ q \cdot \text{weight} \left(\begin{array}{c} g \\ \begin{array}{ccc} 1 & \cdots & 1 \\ \vdots & & \vdots \\ 0 & \cdots & 0 \end{array} \\ g \end{array} \right) + \text{weight} \left(\begin{array}{c} g \\ \begin{array}{ccc} 0 & \cdots & 1 \\ \vdots & & \vdots \\ 1 & \cdots & 0 \end{array} \\ g \end{array} \right) &= q \cdot \left(q \cdot \text{weight} \left(\begin{array}{c} g \\ \begin{array}{ccc} 1 & \cdots & 0 \\ \vdots & & \vdots \\ 0 & \cdots & 1 \end{array} \\ g \end{array} \right) + \text{weight} \left(\begin{array}{c} g \\ \begin{array}{ccc} 0 & \cdots & 0 \\ \vdots & & \vdots \\ 1 & \cdots & 1 \end{array} \\ g \end{array} \right) \right). \end{aligned}$$

In each of the relations the right-hand side differs by moving the outgoing arrow down, and “weight” means the product of the weights $L_{u,s}$ at the bottom and $L_{qu,s}$ at the top vertex. The above relations are readily verified from the definition of $L_{u,s}$ (2.3) (see also Fig. 5). \square

This proposition implies that for any fixed $i_1, i_2 \in \mathbb{Z}_{\geq 0}$, the Markov operator mapping P_1 to P_2 (where P_1, P_2 are probability distributions on $\{0, 1\}^J$), can be projected to another Markov operator which maps \tilde{P}_1 to \tilde{P}_2 (cf. (5.3)), i.e., acts on probability distributions on the smaller space $\{0, 1, \dots, J\}$. We will denote the matrix elements of this “collapsed” Markov operator by $L_{u,s}^{(J)}(i_1, j_1; i_2, j_2)$, where $(i_1, j_1), (i_2, j_2) \in \mathbb{Z}_{\geq 0} \times \{0, 1, \dots, J\}$.

The definition of $L_{u,s}^{(J)}$ implies that these matrix elements satisfy a certain recursion relation in J . This relation is obtained by considering two cases, whether there is a left-to-right arrow at the very bottom,

or not (i.e., $h_1^{(1)} = 0$ or $h_1^{(1)} = 1$). Therefore, we obtain the following recursion:

$$\mathbf{L}_{u,s}^{(J)}(i_1, j_1; i_2, j_2) = \sum_{a,b \in \{0,1\}} \sum_{l \geq 0} P(h_1^{(1)} = a) \mathbf{L}_{u,s}(i_1, a; l, b) \mathbf{L}_{qu,s}^{(J-1)}(l, j_1 - a; i_2, j_2 - b). \quad (5.5)$$

Here the probability $P(h_1^{(1)} = a)$ corresponds to our division into two cases. It can be readily computed using Definition 5.3:

$$P(h_1^{(1)} = 0) = \frac{q^{j_1} Z_{j_1}(J-1)}{Z_{j_1}(J)} = \frac{q^{j_1} - q^J}{1 - q^J}, \quad P(h_1^{(1)} = 1) = \frac{q^{j_1-1} Z_{j_1-1}(J-1)}{Z_{j_1}(J)} = \frac{1 - q^{j_1}}{1 - q^J}.$$

The recursion relation (5.5) has a solution expressible in terms of terminating q -hypergeometric functions (here we follow the notation of [Man14], [Bor14]):

$$\begin{aligned} {}_{r+1}\bar{\phi}_r \left(\begin{matrix} q^{-n}; a_1, \dots, a_r \\ b_1, \dots, b_r \end{matrix} \middle| q, z \right) &:= \sum_{k=0}^n z^k \frac{(q^{-n}; q)_k}{(q; q)_k} \prod_{i=1}^r (a_i; q)_k (b_i q^k; q)_{n-k} \\ &= \prod_{i=1}^r (b_i; q)_n \cdot {}_{r+1}\bar{\phi}_r \left(\begin{matrix} q^{-n}; a_1, \dots, a_r \\ b_1, \dots, b_r \end{matrix} \middle| q, z \right), \end{aligned}$$

where here $n \in \mathbb{Z}_{\geq 0}$. The solution $\mathbf{L}_{u,s}^{(J)}$ looks as follows:

$$\begin{aligned} \mathbf{L}_{u,s}^{(J)}(i_1, j_1; i_2, j_2) &= \mathbf{1}_{i_1+j_1=i_2+j_2} \frac{(-1)^{i_1} q^{\frac{1}{2}i_1(i_1+2j_1-1)} u^{i_1} \mathbf{s}^{j_1+j_2-i_2} (us^{-1}; q)_{j_2-i_1}}{(q; q)_{i_2} (\mathbf{s}u; q)_{i_2+j_2} (q^{J+1-j_1}; q)_{j_1-j_2}} \\ &\quad \times {}_4\bar{\phi}_3 \left(\begin{matrix} q^{-i_2}; q^{-i_1}, \mathbf{s}uq^J, q\mathbf{s}/u \\ \mathbf{s}^2, q^{1+j_2-i_1}, q^{J+1-i_2-j_2} \end{matrix} \middle| q, q \right). \end{aligned} \quad (5.6)$$

Formula (5.6) for fused vertex weights is essentially due to [Man14]. In the present form (5.6) it was obtained in [CP15, Thm. 3.15] by matching the recursion (5.5) to the recursion relation for the classical q -Racah orthogonal polynomials.¹⁰ About the latter see [KS96, Ch. 3.2].

5.3. Principal specializations of skew functions. The fused stochastic vertex weights discussed in §5.2 can be used to describe principal specializations of the skew functions $\mathbf{F}_{\mu/\lambda}$ and $\mathbf{G}_{\mu/\lambda}$, in analogy to the non-skew principal specializations of Corollary 4.16.

Mimicking (2.2)–(2.3), we will use the general J stochastic weights $\mathbf{L}_{u,s}^{(J)}$ (5.6) to define the weights which are general J versions of the w_u 's (2.1):

$$w_{u,s}^{(J)}(i_1, j_1; i_2, j_2) := \frac{1}{(-\mathbf{s})^{j_2}} \frac{(q; q)_{i_2} (\mathbf{s}^2; q)_{i_1}}{(\mathbf{s}^2; q)_{i_2} (q; q)_{i_1}} \mathbf{L}_{u,s}^{(J)}(i_1, j_1; i_2, j_2), \quad (5.7)$$

where $i_1, i_2 \in \mathbb{Z}_{\geq 0}$ and $j_1, j_2 \in \{0, 1, \dots, J\}$ are such that $i_1 + j_1 = i_2 + j_2$ (otherwise the above weight is set to zero). These weights are expressed via the q -hypergeometric function as follows:

$$\begin{aligned} w_{u,s}^{(J)}(i_1, j_1; i_2, j_2) &= \frac{(-1)^{i_1+j_2} q^{\frac{1}{2}i_1(i_1+2j_1-1)} \mathbf{s}^{j_2-i_1} u^{i_1} (q; q)_{j_1} (us^{-1}; q)_{j_1-i_2}}{(q; q)_{i_1} (q; q)_{j_2} (u\mathbf{s}; q)_{i_1+j_1}} \\ &\quad \times {}_4\bar{\phi}_3 \left(\begin{matrix} q^{-i_1}; q^{-i_2}, q^J \mathbf{s}u, q\mathbf{s}u^{-1} \\ \mathbf{s}^2, q^{1+j_1-i_2}, q^{1+J-i_1-j_1} \end{matrix} \middle| q, q \right). \end{aligned} \quad (5.8)$$

We see that the weights $w_{u,s}^{(J)}$ depend on the spectral parameter u in a rational manner. One can also check that for $J = 1$, the weights $w_{u,s}^{(J)}$ turn into (2.1).

¹⁰The parameters in (5.6) match those in [CP15, Thm. 3.15] as $\beta = \alpha q^J$, $\alpha = -\mathbf{s}u$, and $\nu = \mathbf{s}^2$.

Proposition 5.5. 1. For any $J \in \mathbb{Z}_{\geq 1}$, $N \in \mathbb{Z}_{\geq 0}$, $\lambda \in \text{Sign}_N^+$, $\mu \in \text{Sign}_{N+J}^+$, and $u \in \mathbb{C}$, the principal specialization of the skew function

$$F_{\mu/\lambda}(u, qu, \dots, q^{J-1}u \mid \Xi, S)$$

is equal to the weight of the unique collection of $N+J$ up-right paths in the semi-infinite horizontal strip of height 1, where the weight at each vertex $x \in \mathbb{Z}_{\geq 0}$ is equal to $w_{\xi_x u, s_x}^{(J)}$ (so that at most J horizontal arrows per edge are allowed). The paths in the collection start with N vertical edges $(\lambda_i, 0) \rightarrow (\lambda_i, 1)$ and with J horizontal edges $(-1, 1) \rightarrow (0, 1)$, and end with $N+J$ vertical edges $(\mu_j, 1) \rightarrow (\mu_j, 2)$, see Fig. 11, top.

2. For any $J \in \mathbb{Z}_{\geq 1}$, any $\lambda, \mu \in \text{Sign}_N$, and any $v \in \mathbb{C}$, the principal specialization of the skew function

$$G_{\mu/\lambda}(v, qv, \dots, q^{J-1}v \mid \Xi, S)$$

is equal to the weight of the unique collection of N up-right paths in the semi-infinite horizontal strip of height 1, where the weight at each vertex $x \in \mathbb{Z}_{\geq 0}$ is equal to $w_{\xi_x v, s_x}^{(J)}$ (so that at most J horizontal arrows per edge are allowed). The paths in the collection start with N vertical edges $(\lambda_i, 0) \rightarrow (\lambda_i, 1)$ and end with N vertical edges $(\mu_i, 1) \rightarrow (\mu_i, 2)$, see Fig. 11, bottom.

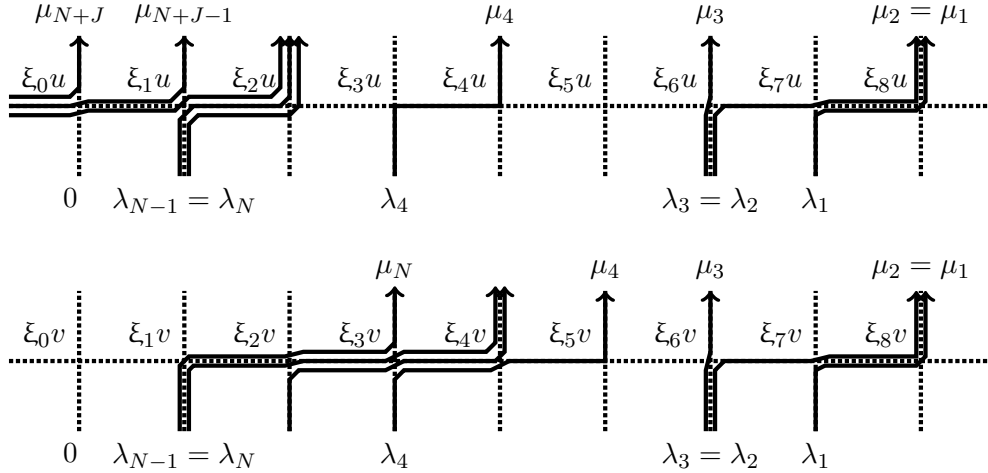

FIGURE 11. A unique path collection with horizontal multiplicities bounded by $J = 3$ corresponding to the function $F_{\mu/\lambda}(u, qu, \dots, q^{J-1}u \mid \Xi, S)$ (top) or $G_{\mu/\lambda}(v, qv, \dots, q^{J-1}v \mid \Xi, S)$ (bottom). Each j -th vertex having the spectral parameter $\xi_j u$ or $\xi_j v$, respectively, contains the s -parameter s_j .

Proof. For $\lambda \in \text{Sign}_N^+$ and our s -parameters $S = \{s_j\}$, denote

$$(-S)^\lambda := \prod_{i=1}^N \prod_{j=0}^{\lambda_i-1} (-s_j). \quad (5.9)$$

Let us focus on the second claim. Relation (2.2)–(2.3) between the $J = 1$ weights $w_{u,s}$ and $L_{u,s}$ readily implies that for any $z \in \mathbb{C}$, any $L \in \mathbb{Z}_{\geq 0}$ and $\nu, \kappa \in \text{Sign}_L^+$, the quantity

$$\frac{(-S)^\kappa c_S(\kappa)}{(-S)^\nu c_S(\nu)} G_{\kappa/\nu}(z \mid \Xi, S) = \frac{(-S)^\kappa}{(-S)^\nu} G_{\kappa/\nu}^c(z \mid \Xi, S)$$

is equal to the weight of the unique collection of L paths in the semi-infinite horizontal strip of height 1 connecting ν to κ , but with horizontal arrow multiplicities bounded by 1. The weight at a vertex $x \in \mathbb{Z}_{\geq 0}$ in this path collection is the stochastic weight $L_{\xi_x z, s_x}$.

Therefore, by Proposition 4.6, the quantity

$$\frac{(-S)^\mu}{(-S)^\lambda} \mathbf{G}_{\mu/\lambda}^c(v, qv, \dots, q^{J-1}v \mid \Xi, S) \quad (5.10)$$

is equal to the sum of weights of collections of N paths in $\{1, 2, \dots, J\} \times \mathbb{Z}_{\geq 0}$ connecting λ to μ (as in Definition 4.3), in which the weight at each vertex $(j, x) \in \{1, 2, \dots, J\} \times \mathbb{Z}_{\geq 0}$ is $L_{\xi_x, q^{j-1}v, s_x}$ (hence the horizontal arrow multiplicities are bounded by 1). In (5.10), the configuration of input horizontal arrows at location 0 is empty, and hence its distribution is q -exchangeable. Thus, we may use the fusion of stochastic weights from §5.2 to collapse the J horizontals into one, with horizontal arrow multiplicities bounded by J , and with fused vertex weights $L_{\xi_x v, s_x}^{(J)}$. In this way all path collections in $\{1, 2, \dots, J\} \times \mathbb{Z}_{\geq 0}$ connecting λ to μ map to the unique collection in $\{1\} \times \mathbb{Z}_{\geq 0}$ with horizontal edge multiplicities bounded by J . Using (5.7), we conclude that the second claim holds.

The first claim about $\mathbf{F}_{\mu/\lambda}(u, qu, \dots, q^{J-1}u \mid \Xi, S)$ is analogous, because the corresponding configuration of input arrows in $\{1, 2, \dots, J\} \times \mathbb{Z}_{\geq 0}$ is the fully packed one, whose distribution is also q -exchangeable. This completes the proof. \square

Remark 5.6. Since the general J vertex weights $w_{u,s}^{(J)}(i_1, j_1; i_2, j_2)$ (5.8) depend on q^J in a rational manner, they make sense for q^J being an arbitrary (generic) complex parameter. Thus, we can consider the principal specializations $\mathbf{G}_{\mu/\lambda}(v, qv, \dots, q^{J-1}v \mid \Xi, S)$ for a generic $q^J \in \mathbb{C}$. In other words, this quantity admits an analytic continuation in q^J . The second part of Proposition 5.5 thus states that when $J \in \mathbb{Z}_{>1}$, the function $\mathbf{G}_{\mu/\lambda}(v, qv, \dots, q^{J-1}v \mid \Xi, S)$ can be expressed as a substitution of the values $(v, qv, \dots, q^{J-1}v)$ into the symmetric function $\mathbf{G}_{\mu/\lambda}(v_1, v_2, \dots, v_J \mid \Xi, S)$.

In contrast with the functions $\mathbf{G}_{\mu/\lambda}$ in which the number of indeterminates does not depend on λ and μ , the number of arguments in the functions $\mathbf{F}_{\mu/\lambda}$ is completely determined by the signatures λ and μ . Therefore, the parameter J in $\mathbf{F}_{\mu/\lambda}(u, qu, \dots, q^{J-1}u \mid \Xi, S)$ has to remain a positive integer.

Remark 5.7. The weights (5.7) are related to the weights $\tilde{w}_v^{(J)}(i_1, j_1; i_2, j_2)$ of [Bor14, (6.8)] via

$$w_{v,s}^{(J)}(i_1, j_1; i_2, j_2) = q^{\frac{1}{4}(j_2^2 - j_1^2)} (-s)^{j_2 - j_1} \frac{(q; q)_{j_1}}{(q; q)_{j_2}} \tilde{w}_v^{(J)}(i_1, j_1; i_2, j_2).$$

The structure of the path collection for $\mathbf{G}_{\mu/\lambda}$ implies that for the purposes of computing $\mathbf{G}_{\mu/\lambda}$, any prefactors in the vertex weights of the form $f(j_1)/f(j_2)$ are irrelevant. Therefore, the principal specializations $\mathbf{G}_{\mu/\lambda}(v, qv, \dots, q^{J-1}v \mid \Xi, S)$ for $\xi_j \equiv 1$ and $s_j \equiv s$ coincide with those in [Bor14, §6]. Note that, however, factors of the form $f(j_1)/f(j_2)$ in the vertex weights do make a difference for the functions $\mathbf{F}_{\mu/\lambda}(u, qu, \dots, q^{J-1}u \mid \Xi, S)$.

6. MARKOV KERNELS AND STOCHASTIC DYNAMICS

In this section we describe probability distributions on signatures arising from the Cauchy identity (Corollary 4.13), as well as discrete time stochastic systems (i.e., discrete time Markov chains) which act nicely on these measures. Some of the stochastic systems we consider are inhomogeneous generalizations of the ones from [CP15].

6.1. Probability measures associated with the Cauchy identity. The idea that summation identities for symmetric functions lead to interesting probability measures dates back at least to [Ful97], [Oko01], and it was further developed in [OR03], [Vul07], [Bor11], [BC14], [BCGS15]. Similar ideas in our context lead to the definition of the following probability measures which are analogous to the Schur or Macdonald measures:

Definition 6.1. Let $M, N \in \mathbb{Z}_{\geq 0}$,¹¹ and the parameters q, Ξ, \mathbf{S} , and $\mathbf{u} = (u_1, \dots, u_M)$, $\mathbf{v} = (v_1, \dots, v_N)$ satisfy (5.1)–(5.2).¹² Moreover, assume that $(u_i, v_j) \in \text{Adm}_{\Xi, \mathbf{S}}$ for all i, j (for the admissibility it is enough to require that all u_i and v_j are sufficiently small, cf. Definition 4.9). Define the probability measure on Sign_M^+ via

$$\mathcal{M}_{\mathbf{u}; \mathbf{v}}(\nu | \Xi, \mathbf{S}) = \mathcal{M}_{\mathbf{u}; \mathbf{v}}(\nu) := \frac{1}{Z(\mathbf{u}; \mathbf{v} | \Xi, \mathbf{S})} F_\nu(u_1, \dots, u_M | \Xi, \mathbf{S}) G_\nu^c(v_1, \dots, v_N | \bar{\Xi}, \mathbf{S}), \quad \nu \in \text{Sign}_M^+, \quad (6.1)$$

where the normalization constant is given by

$$Z(\mathbf{u}; \mathbf{v} | \Xi, \mathbf{S}) := (q; q)_M \prod_{i=1}^M \left(\frac{1}{1 - s_0 \xi_0 u_i} \prod_{j=1}^N \frac{1 - q u_i v_j}{1 - u_i v_j} \right). \quad (6.2)$$

The fact that the unnormalized weights $Z(\mathbf{u}; \mathbf{v} | \Xi, \mathbf{S}) \mathcal{M}_{\mathbf{u}; \mathbf{v}}(\nu | \Xi, \mathbf{S})$ are nonnegative follows from (5.1)–(5.2). Indeed, these conditions imply that the vertex weights $w_{u, \mathbf{s}}$ and $w_{u, \mathbf{s}}^c$ are nonnegative, and hence so are the functions F_ν and G_ν^c . The form (6.2) of the normalization constant follows from the Cauchy identity (4.21).¹³ Note that the length of the tuple \mathbf{u} determines the length of the signatures on which the measure $\mathcal{M}_{\mathbf{u}; \mathbf{v}}$ lives. In contrast, the length of the tuple \mathbf{v} may be arbitrary.

In two degenerate cases, $\mathcal{M}_{\emptyset; \mathbf{v}}$ is the delta measure at the empty configuration (for any \mathbf{v}), and $\mathcal{M}_{(u_1, \dots, u_M); \emptyset}$ is the delta measure at the configuration 0^M (that is, all M particles are at zero).

The measures $\mathcal{M}_{\mathbf{u}; \mathbf{v}}$ can be represented pictorially, see Fig. 12. Let us look at the bottom part of the path collection as in Fig. 12, and let us denote the positions of the vertical edges at the k -th horizontal by $\nu_i^{(k)}$, $1 \leq i \leq k \leq M$ see Fig. 13, bottom. In the top part of the path collection, let us denote the coordinates of the vertical edges by $\tilde{\nu}_j^{(\ell)}$, $1 \leq \ell \leq N$, $1 \leq j \leq M$ (see Fig. 13, top). We have $\nu_i^{(M)} = \tilde{\nu}_i^{(N)} = \nu_i$, $i = 1, \dots, M$. By construction, these coordinates satisfy *interlacing constraints*:

$$\nu_i^{(k)} \leq \nu_{i-1}^{(k-1)} \leq \nu_{i-1}^{(k)}, \quad \tilde{\nu}_j^{(\ell)} \leq \tilde{\nu}_{j-1}^{(\ell-1)} \leq \tilde{\nu}_{j-1}^{(\ell)} \quad (6.3)$$

for all meaningful values of k, i and ℓ, j . Arrays of the form $\{\nu_i^{(k)}\}_{1 \leq i \leq k \leq M}$ satisfying the above interlacing properties are also sometimes called *Gelfand–Tsetlin schemes/patterns*. By the very definition of the skew F and G functions, the distribution of the sequence of signatures $(\nu^{(1)}, \dots, \nu^{(M)} = \tilde{\nu}^{(N)}, \dots, \tilde{\nu}^{(1)})$ has the form

$$\begin{aligned} \mathcal{M}_{\mathbf{u}; \mathbf{v}}(\nu^{(1)}, \dots, \nu^{(M)} = \tilde{\nu}^{(N)}, \dots, \tilde{\nu}^{(1)} | \Xi, \mathbf{S}) \\ = \frac{1}{Z(\mathbf{u}; \mathbf{v} | \Xi, \mathbf{S})} F_{\nu^{(1)}}(u_1 | \Xi, \mathbf{S}) F_{\nu^{(2)}/\nu^{(1)}}(u_2 | \Xi, \mathbf{S}) \dots F_{\nu^{(M)}/\nu^{(M-1)}}(u_M | \Xi, \mathbf{S}) \\ \times G_{\tilde{\nu}^{(1)}}^c(v_1 | \bar{\Xi}, \mathbf{S}) G_{\tilde{\nu}^{(2)}/\tilde{\nu}^{(1)}}^c(v_2 | \bar{\Xi}, \mathbf{S}) \dots G_{\tilde{\nu}^{(N)}/\tilde{\nu}^{(N-1)}}^c(v_N | \bar{\Xi}, \mathbf{S}). \end{aligned} \quad (6.4)$$

The probability distribution (6.4) on interlacing arrays is an analogue of Schur or Macdonald processes of [OR03], [BC14]. It readily follows from the Pieri rules (Corollary 4.11) that under (6.4), the marginal distribution of $\nu^{(k)}$ for any $k = 1, \dots, M$ is $\mathcal{M}_{(u_1, \dots, u_k); (v_1, \dots, v_N)}$, and similarly the marginal distribution of $\tilde{\nu}^{(\ell)}$, $\ell = 1, \dots, N$, is $\mathcal{M}_{(u_1, \dots, u_M); (v_1, \dots, v_\ell)}$.

¹¹Here and below if $M = 0$, then Sign_M^+ consists of the single empty signature \emptyset , and thus all probability measures and Markov operators on this space are trivial.

¹²These conditions are assumed throughout §6 except §6.5 and §6.6.

¹³The sum of the unnormalized weights converges due to the admissibility conditions, and hence the normalization constant $Z(\mathbf{u}; \mathbf{v} | \Xi, \mathbf{S})$ is nonnegative. This constant is positive whenever the measure $\mathcal{M}_{\mathbf{u}; \mathbf{v}}$ is nontrivial.

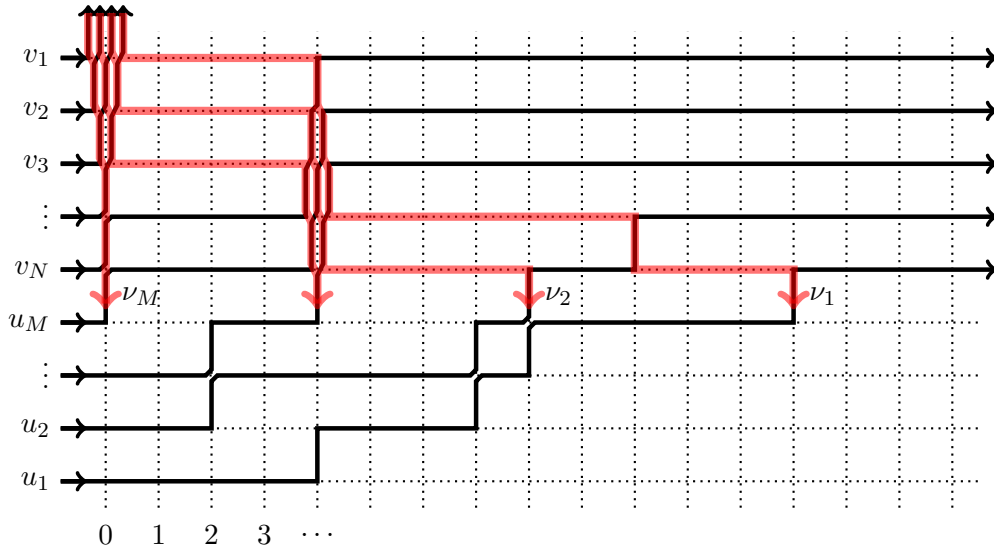

FIGURE 12. Probability weights $\mathcal{M}_{\mathbf{u},\mathbf{v}}(\nu|\Xi, \mathbf{S})$ as partition functions. The bottom part of height M corresponds to $\mathbf{B}(u_1|\Xi, \mathbf{S}) \dots \mathbf{B}(u_M|\Xi, \mathbf{S})$, and the top half of height N — to $\mathbf{D}(v_1^{-1}|\Xi, \mathbf{S}) \dots \mathbf{D}(v_N^{-1}|\Xi, \mathbf{S})$. The initial configuration at the bottom is empty, and the final configuration of the solid (black) paths at the top is $\mathbf{e}_{(0M)} = \mathbf{e}_M \otimes \mathbf{e}_0 \otimes \mathbf{e}_0 \dots$. The locations where the solid paths cross the horizontal division line correspond to the signature $\nu = (\nu_1, \dots, \nu_M)$. The opaque (red) paths complement the solid (black) paths in the top part, this corresponds to the renormalization (4.8) employed in the passage from the operators $\mathbf{D}(v_j^{-1}|\Xi, \mathbf{S})$ to $\overline{\mathbf{D}}(v_j^{-1}|\overline{\Xi}, \mathbf{S})$ (the latter involves coefficients $\mathbf{G}_{\lambda/\mu}^c(v_j|\overline{\Xi}, \mathbf{S})$). After the renormalization, we let the width of the grid go to infinity.

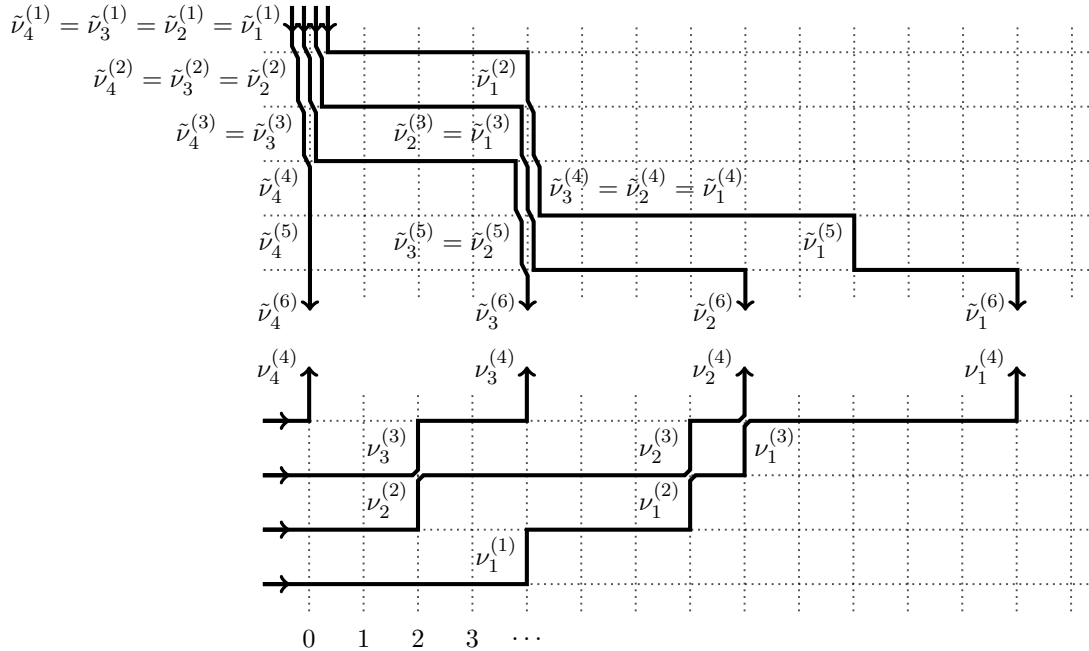

FIGURE 13. A pair of interlacing arrays from path collections. Horizontal parts of the paths are for illustration.

6.2. Four Markov kernels. Let us now define four Markov kernels which map the measure $\mathcal{M}_{\mathbf{u},\mathbf{v}}$ to a measure of the same form, but with modified parameters \mathbf{u} or \mathbf{v} .

The first two Markov kernels, Λ^- and Λ° , correspond to taking conditional distributions given $\nu^{(M)} = \tilde{\nu}^{(N)}$ of $\nu^{(k)}$ or $\tilde{\nu}^{(\ell)}$, respectively, in the ensemble (6.4). Namely, let us define for any m :

$$\Lambda_{\mathbf{u}|\mathbf{u}}^-(\nu \rightarrow \mu) := \frac{F_\mu(u_1, \dots, u_m | \Xi, \mathbf{S})}{F_\nu(u_1, \dots, u_m, u | \Xi, \mathbf{S})} F_{\nu/\mu}(u | \Xi, \mathbf{S}), \quad (6.5)$$

where $\mathbf{u} = (u_1, \dots, u_m)$, and $\nu \in \text{Sign}_{m+1}^+$, $\mu \in \text{Sign}_m^+$. Also, let us define for any n :

$$\Lambda_{\mathbf{v}|\mathbf{v}}^\circ(\lambda \rightarrow \mu) := \frac{G_\mu^c(v_1, \dots, v_n | \bar{\Xi}, \mathbf{S})}{G_\lambda^c(v_1, \dots, v_n, v | \bar{\Xi}, \mathbf{S})} G_{\lambda/\mu}^c(v | \bar{\Xi}, \mathbf{S}), \quad (6.6)$$

where $\mathbf{v} = (v_1, \dots, v_n)$, and $\lambda, \mu \in \text{Sign}_m^+$ for some m . The facts that the quantities (6.5) and (6.6) sum to 1 (over all $\mu \in \text{Sign}_m^+$; note that these sums are finite) follow from the branching rules (Proposition 4.6). Hence, $\Lambda_{\mathbf{u}|\mathbf{u}}^-: \text{Sign}_{m+1}^+ \dashrightarrow \text{Sign}_m^+$ and $\Lambda_{\mathbf{v}|\mathbf{v}}^\circ: \text{Sign}_m^+ \dashrightarrow \text{Sign}_m^+$ define Markov kernels.¹⁴ Note that in (6.5) and (6.6) one can replace all functions by F^c or G , respectively, and get the same kernels.

The kernels Λ^- and Λ° act on the measures (6.1) as

$$\mathcal{M}_{\mathbf{u}\cup\mathbf{u};\mathbf{v}}\Lambda_{\mathbf{u}|\mathbf{u}}^- = \mathcal{M}_{\mathbf{u};\mathbf{v}}, \quad \mathcal{M}_{\mathbf{u};\mathbf{v}\cup\mathbf{v}}\Lambda_{\mathbf{v}|\mathbf{v}}^\circ = \mathcal{M}_{\mathbf{u};\mathbf{v}}, \quad (6.7)$$

this follows from the Pieri rules (Corollary 4.11). The matrix products above are understood in a natural way, for example, $(\mathcal{M}_{\mathbf{u}\cup\mathbf{u};\mathbf{v}}\Lambda_{\mathbf{u}|\mathbf{u}}^-)(\mu) = \sum_\nu \mathcal{M}_{\mathbf{u}\cup\mathbf{u};\mathbf{v}}(\nu)\Lambda_{\mathbf{u}|\mathbf{u}}^-(\nu \rightarrow \mu)$.

Remark 6.2 (Gibbs measures). Conditioned on any $\nu^{(k)}$ (where $k = 1, \dots, M$), the distribution of the lower levels $\nu^{(1)}, \dots, \nu^{(k-1)}$ under (6.4) is independent of \mathbf{v} and is given by

$$\Lambda_{u_k| (u_1, \dots, u_{k-1})}^-(\nu^{(k)} \rightarrow \nu^{(k-1)}) \dots \Lambda_{u_3| (u_1, u_2)}^-(\nu^{(3)} \rightarrow \nu^{(2)}) \Lambda_{u_2| (u_1)}^-(\nu^{(2)} \rightarrow \nu^{(1)}), \quad (6.8)$$

and a similar expression can be written for conditioning on $\tilde{\nu}^{(\ell)}$, yielding a distribution which is independent of \mathbf{u} and involves the kernels Λ° .

It is natural to call a measure on a sequence of interlacing signatures $(\nu^{(1)}, \dots, \nu^{(M)})$ whose conditional distributions are given by (6.8) a *Gibbs measure* (with respect to the \mathbf{u} parameters). In fact, when $q = 0$, $s_j \equiv 0$, $\xi_j \equiv 1$, and $u_i \equiv 1$, this Gibbs property turns into the following: conditioned on any $\nu^{(k)}$, the distribution of the lower levels $\nu^{(1)}, \dots, \nu^{(k-1)}$ is *uniform* among all sequences of signatures satisfying the interlacing constraints (6.3).

This Gibbs property (as well as commutation relations discussed below in this subsection) can be used to construct “multivariate” Markov kernels on arrays of interlacing signatures which act nicely on distributions of the form (6.4), but we will not address this construction here (about similar constructions see references given in Remark 6.9 below). For details of such constructions in the case of Macdonald processes see [BP13], [MP15].

The other two Markov kernels, \mathcal{Q}^+ and \mathcal{Q}° , increase the number of parameters in the measures $\mathcal{M}_{\mathbf{u};\mathbf{v}}$, as opposed to (6.7), where the number of parameters is decreased. These kernels are defined as follows. For any $n, m \in \mathbb{Z}_{\geq 0}$, define

$$\mathcal{Q}_{\mathbf{u};\mathbf{v}}^+(\lambda \rightarrow \nu) := \frac{1 - s_0 \xi_0 u}{1 - q^{m+1}} \left(\prod_{j=1}^n \frac{1 - uv_j}{1 - quv_j} \right) \frac{G_\nu^c(v_1, \dots, v_n | \bar{\Xi}, \mathbf{S})}{G_\lambda^c(v_1, \dots, v_n | \bar{\Xi}, \mathbf{S})} F_{\nu/\lambda}(u | \Xi, \mathbf{S}), \quad (6.9)$$

¹⁴We use the notation “ \dashrightarrow ” to indicate that $\Lambda_{\mathbf{u}|\mathbf{u}}^-$ and $\Lambda_{\mathbf{v}|\mathbf{v}}^\circ$ are Markov kernels, i.e., they are functions in the first variable (belonging to the space on the left of “ \dashrightarrow ”) and probability distributions in the second variable (belonging to the space on the right of “ \dashrightarrow ”).

where $\mathbf{v} = (v_1, \dots, v_n)$ such that $(u, v_j) \in \text{Adm}_{\Xi, S}$ for all j , with $\lambda \in \text{Sign}_m^+$ and $\nu \in \text{Sign}_{m+1}^+$. Also, for any $m \in \mathbb{Z}_{\geq 0}$, define

$$\mathcal{Q}_{\mathbf{u};v}^\circ(\mu \rightarrow \nu) := \left(\prod_{i=1}^m \frac{1 - u_i v}{1 - q u_i v} \right) \frac{F_\nu(u_1, \dots, u_m | \Xi, S)}{F_\mu(u_1, \dots, u_m | \Xi, S)} G_{\nu/\mu}^c(v | \Xi, S), \quad (6.10)$$

where $\mathbf{u} = (u_1, \dots, u_m)$ such that $(u_i, v) \in \text{Adm}_{\Xi, S}$ for all i , with $\mu, \nu \in \text{Sign}_m^+$. By the Pieri rules of Corollary 4.11, $\mathcal{Q}_{\mathbf{u};v}^+ : \text{Sign}_m^+ \dashrightarrow \text{Sign}_{m+1}^+$ and $\mathcal{Q}_{\mathbf{u};v}^\circ : \text{Sign}_m^+ \dashrightarrow \text{Sign}_m^+$ define Markov kernels (i.e., they sum to one in the second argument).

Remark 6.3. In $\mathcal{Q}_{\mathbf{u};v}^\circ$ (6.10), moving the conjugation from the function G to both functions F does not change the kernel. However, doing so in $\mathcal{Q}_{\mathbf{u};v}^+$ (6.9) requires modifying the prefactor:

$$\mathcal{Q}_{\mathbf{u};v}^+(\lambda \rightarrow \nu) = \frac{1 - s_0 \xi_0 u}{1 - s_0^2 q^m} \left(\prod_{j=1}^n \frac{1 - u v_j}{1 - q u v_j} \right) \frac{G_\nu(v_1, \dots, v_n | \Xi, S)}{G_\lambda(v_1, \dots, v_n | \Xi, S)} F_{\nu/\lambda}^c(u | \Xi, S).$$

From the branching rules (Proposition 4.6) it readily follows that the kernels \mathcal{Q}^+ and \mathcal{Q}° act on the measures (6.1) as

$$\mathcal{M}_{\mathbf{u};v} \mathcal{Q}_{\mathbf{u};v}^+ = \mathcal{M}_{\mathbf{u} \cup \mathbf{u};v}, \quad \mathcal{M}_{\mathbf{u};v} \mathcal{Q}_{\mathbf{u};v}^\circ = \mathcal{M}_{\mathbf{u};v \cup v}. \quad (6.11)$$

The Markov kernels defined above enter the following commutation relations:

Proposition 6.4. 1. *For any $\mathbf{u} = (u_1, \dots, u_m)$ and $u, v \in \mathbb{C}$ such that $(u, v) \in \text{Adm}_{\Xi, S}$, we have $\mathcal{Q}_{\mathbf{u} \cup \mathbf{u};v}^- \Lambda_{\mathbf{u}|\mathbf{u}}^- = \Lambda_{\mathbf{u}|\mathbf{u}}^- \mathcal{Q}_{\mathbf{u};v}^\circ$ (as Markov kernels $\text{Sign}_{m+1}^+ \dashrightarrow \text{Sign}_m^+$), or, in more detail,*

$$\sum_{\lambda \in \text{Sign}_{m+1}^+} \mathcal{Q}_{\mathbf{u} \cup \mathbf{u};v}^\circ(\nu \rightarrow \lambda) \Lambda_{\mathbf{u}|\mathbf{u}}^-(\lambda \rightarrow \mu) = \sum_{\kappa \in \text{Sign}_m^+} \Lambda_{\mathbf{u}|\mathbf{u}}^-(\nu \rightarrow \kappa) \mathcal{Q}_{\mathbf{u};v}^\circ(\kappa \rightarrow \mu),$$

where $\nu \in \text{Sign}_{m+1}^+$ and $\mu \in \text{Sign}_m^+$.

2. *For any $\mathbf{v} = (v_1, \dots, v_n)$ and $u, v \in \mathbb{C}$ such that $(u, v) \in \text{Adm}_{\Xi, S}$, we have $\mathcal{Q}_{\mathbf{u};v \cup v}^+ \Lambda_{v|\mathbf{v}}^\circ = \Lambda_{v|\mathbf{v}}^\circ \mathcal{Q}_{\mathbf{u};v}^+$ (as Markov kernels $\text{Sign}_m^+ \dashrightarrow \text{Sign}_{m+1}^+$), which is unabbreviated in the same way as the first relation.*

Proof. A straightforward corollary of the skew Cauchy identity (Proposition 4.8). \square

Remark 6.5. In the context of Schur functions, the Markov kernels \mathcal{Q}^+ and Λ^- are often referred to as *transition* and *cotransition probabilities*. In [Bor11, §9] and [BC14, §2.3.3] similar kernels are denoted by p^\uparrow and p^\downarrow , respectively. The kernels \mathcal{Q}^+ and Λ^- involve the skew functions F in the \mathbf{u} parameters, and similarly \mathcal{Q}° and Λ° correspond to the G 's in the \mathbf{v} parameters. The latter operators differ from the former ones because (unlike in the Schur or Macdonald setting) the functions F and G are not proportional to each other.

We will treat the Markov kernels $\mathcal{Q}_{\mathbf{u};v}^\circ$ and $\mathcal{Q}_{\mathbf{u};v}^+$ as one-step transition operators of certain discrete time Markov chains.

Remark 6.6. One can readily write down eigenfunctions of $\mathcal{Q}_{\mathbf{u};v}^\circ$ viewed as an operator on functions on Sign_m^+ . Here we mean algebraic (or formal) eigenfunctions, i.e., we do not address the question of how they decay at infinity. We have for any $\mu \in \text{Sign}_m^+$:

$$\begin{aligned} (\mathcal{Q}_{\mathbf{u};v}^\circ \Psi_\bullet^{\mathbf{u}}(z_1, \dots, z_m))(\mu) &= \sum_{\nu \in \text{Sign}_m^+} \mathcal{Q}_{\mathbf{u};v}^\circ(\mu \rightarrow \nu) \Psi_\nu^{\mathbf{u}}(z_1, \dots, z_m) \\ &= \left(\prod_{i=1}^m \frac{1 - q z_i v}{1 - z_i v} \frac{1 - u_i v}{1 - q u_i v} \right) \Psi_\mu^{\mathbf{u}}(z_1, \dots, z_m), \end{aligned} \quad (6.12)$$

where the eigenfunction $\Psi_\lambda^{\mathbf{u}}(\mathbf{z})$ depends on the spectral variables $\mathbf{z} = (z_1, \dots, z_m)$ satisfying the admissibility conditions $(z_i, v) \in \text{Adm}_{\Xi, \mathcal{S}}$ for all i , and is defined as follows:

$$\Psi_\lambda^{\mathbf{u}}(z_1, \dots, z_m) := \frac{1}{F_\lambda(u_1, \dots, u_m | \Xi, \mathcal{S})} F_\lambda(z_1, \dots, z_m | \Xi, \mathcal{S}). \quad (6.13)$$

Relation (6.12) readily follows from the Pieri rules (Corollary 4.11). This eigenrelation can be employed to write down a spectral decomposition of the operator \mathcal{Q}° , see Remark 7.13 below.

6.3. Specializations. Let us now discuss special choices of parameters \mathbf{u} and \mathbf{v} which greatly simplify the Markov kernels $\mathcal{Q}_{\mathbf{u}; \mathbf{v}}^\circ$ and $\mathcal{Q}_{\mathbf{u}; \mathbf{v}}^+$, respectively. First, observe that for any $m \in \mathbb{Z}_{\geq 0}$ and any $\mu \in \text{Sign}_m^+$ we have

$$F_\mu(0^m | \Xi, \mathcal{S}) = F_\mu(\underbrace{0, 0, \dots, 0}_{m \text{ times}} | \Xi, \mathcal{S}) = (-S)^\mu(q; q)_m,$$

where the last equality is due to (4.28) because we can take $u = 0$ in that formula (note that by (4.23), the function $F_\mu(u_1, \dots, u_m)$ is continuous at $\mathbf{u} = 0^m$). We have also used the notation (5.9).

A similar limit for the functions G_μ is given in the next proposition:

Proposition 6.7. *For any $n \in \mathbb{Z}_{\geq 0}$ and $\nu \in \text{Sign}_n^+$, we have*

$$G_\nu(\boldsymbol{\rho} | \Xi, \mathcal{S}) := \lim_{\epsilon \rightarrow 0} \left(G_\nu(\epsilon, q\epsilon, \dots, q^{J-1}\epsilon | \Xi, \mathcal{S}) \Big|_{q^J = \xi_0 / (s_0 \epsilon)} \right) = \begin{cases} (-S)^\nu(s_0^2; q)_n s_0^{-2n}, & \text{if } \nu_n > 0; \\ 0, & \text{if } \nu_n = 0. \end{cases} \quad (6.14)$$

Note that (6.14) does not depend on the inhomogeneity parameters Ξ .

Proof. Let k be the number of zero coordinates in ν . From (4.29) we have for $J \geq n - k$:

$$\begin{aligned} G_\nu(\epsilon, q\epsilon, \dots, q^{J-1}\epsilon | \Xi, \mathcal{S}) &= \frac{(q; q)_J (s_0 \xi_0^{-1} \epsilon; q)_{J+k} (s_0^2; q)_n}{(q; q)_{J-n+k} (s_0 \xi_0^{-1} \epsilon; q)_n (s_0^2; q)_k (\xi_0 s_0 / \epsilon; q^{-1})_{n-k}} \\ &\quad \times \frac{1}{(s_0 \xi_0^{-1} q^{n-k} \epsilon; q)_{J-n+k}} \prod_{j=1}^{n-k} \left(\frac{1}{1 - s_{\nu_j} \xi_{\nu_j}^{-1} q^{j-1} \epsilon} \prod_{\ell=0}^{\nu_j-1} \frac{\xi_\ell^{-1} q^{j-1} \epsilon - s_\ell}{1 - s_\ell \xi_\ell^{-1} q^{j-1} \epsilon} \right). \end{aligned}$$

The $\epsilon \rightarrow 0$ limit of the product over j above (which is independent of q^J) gives $(-S)^\nu$. We can rewrite the prefactor as follows:

$$\begin{aligned} &\frac{(q; q)_J (s_0^2; q)_n (s_0 \epsilon / \xi_0; q)_{J+k}}{(q; q)_{J-n+k} (s_0^2; q)_k (s_0 \epsilon / \xi_0; q)_n (s_0 \xi_0 / \epsilon; q^{-1})_{n-k} (s_0 \epsilon q^{n-k} / \xi_0; q)_{J-n+k}} \\ &= \frac{(s_0^2 q^k; q)_{n-k}}{(s_0 \xi_0 / \epsilon; q^{-1})_{n-k} (s_0 \epsilon / \xi_0; q)_n} (q^{J+1+k-n}; q)_{n-k} (s_0 \epsilon / \xi_0; q)_{n-k} (s_0 \epsilon q^J / \xi_0; q)_k. \end{aligned}$$

One readily sees that the above quantity depends on q^J in a rational manner.¹⁵ This allows to analytically continue in q^J , and set $q^J = \xi_0 / (s_0 \epsilon)$. Observe that the result involves $(1; q)_k$, which vanishes unless $k = 0$. For $k = 0$ we obtain:

$$\frac{(s_0^2; q)_n}{(s_0 \xi_0 / \epsilon; q^{-1})_n (s_0 \epsilon / \xi_0; q)_n} (\xi_0 (s_0 \epsilon)^{-1} q^{1-n}; q)_n (s_0 \epsilon / \xi_0; q)_n = \frac{(s_0^2; q)_n}{(s_0 \xi_0 / \epsilon; q^{-1})_n} (\xi_0 (s_0 \epsilon)^{-1} q^{1-n}; q)_n,$$

and in the $\epsilon \rightarrow 0$ limit this turns into $(s_0^2; q)_n s_0^{-2n}$, which completes the proof. \square

Remark 6.8. An alternative proof of Proposition 6.7 (and in fact a computation of a more general specialization) using the integral formula of Corollary 7.16 below is discussed in §8.2.

¹⁵This can also be thought of as a consequence of the fusion procedure (§5.3), but the statement of the proposition does not require fusion.

Let us substitute the above specializations 0^m and \mathbf{g} into the Markov kernels. The kernel $\mathcal{Q}_{0^m;v}^\circ$ looks as follows:

$$\mathcal{Q}_{0^m;v}^\circ(\mu \rightarrow \nu) = \frac{(-S)^\nu}{(-S)^\mu} \mathbf{G}_{\nu/\mu}^c(v | \bar{\Xi}, S), \quad \mu, \nu \in \mathbf{Sign}_m^+. \quad (6.15)$$

Similarly, the kernel $\mathcal{Q}_{u;\mathbf{g}}^+$ has the form

$$\mathcal{Q}_{u;\mathbf{g}}^+(\lambda \rightarrow \nu) = \frac{1 - s_0 \xi_0 u}{s_0(s_0 - u \xi_0)} \frac{(-S)^\nu}{(-S)^\lambda} \mathbf{F}_{\nu/\lambda}^c(u | \Xi, S),$$

where $\lambda \in \mathbf{Sign}_m^+$, $\nu \in \mathbf{Sign}_{m+1}^+$ are such that $\lambda_m, \nu_{m+1} > 0$. Because of this latter condition, we can subtract 1 from all parts of λ and ν , and rewrite $\mathcal{Q}_{u;\mathbf{g}}^+$ as follows:

$$\mathcal{Q}_{u;\mathbf{g}}^+(\lambda \rightarrow \nu) = \frac{(-S)^\nu}{(-S)^\lambda} \frac{1}{\mathbf{L}_{\xi_0 u, s_0}(0, 1; 0, 1)} \mathbf{F}_{\nu/\lambda}^c(u | \Xi, S) = \frac{(-\tau_1 S)^{\nu-1^{m+1}}}{(-\tau_1 S)^{\lambda-1^m}} \mathbf{F}_{(\nu-1^{m+1})/(\lambda-1^m)}^c(u | \tau_1 \Xi, \tau_1 S), \quad (6.16)$$

where τ_1 is the shift (4.25).

6.4. Interacting particle systems. Fix $M \in \mathbb{Z}_{\geq 0}$. Let us interpret \mathbf{Sign}_M^+ as the space of M -particle configurations on $\mathbb{Z}_{\geq 0}$, in which putting an arbitrary number of particles per site is allowed (particles are assumed to be identical). That is, each $\lambda = 0^{\ell_0} 1^{\ell_1} 2^{\ell_2} \dots \in \mathbf{Sign}_M^+$ corresponds to having ℓ_0 particles at site 0, ℓ_1 particles at site 1, and so on.

We can interpret the Markov kernels $\mathcal{Q}_{\mathbf{u};v}^\circ$ and $\mathcal{Q}_{\mathbf{u};\mathbf{v}}^+$ (for any \mathbf{u} or \mathbf{v}) as one-step transition operators of two discrete time Markov chains. Denote these Markov chains by $\mathcal{X}_{\mathbf{u};\{v_t\}}^\circ$ and $\mathcal{X}_{\{u_t\};\mathbf{v}}^+$, respectively. Here $\{v_t\}_{t \in \mathbb{Z}_{\geq 0}}$ and $\{u_t\}_{t \in \mathbb{Z}_{\geq 0}}$ are time-dependent parameters which are added during one step of \mathcal{X}° or \mathcal{X}^+ , respectively (we tacitly assume that all parameters u_i and v_j satisfy the necessary admissibility conditions as in §6.2).

For generic \mathbf{u} and \mathbf{v} parameters, the Markov chains $\mathcal{X}_{\mathbf{u};\{v_t\}}^\circ$ and $\mathcal{X}_{\{u_t\};\mathbf{v}}^+$, respectively, are *nonlocal*, i.e., transitions at a given location depend on the whole particle configuration. However, taking $\mathbf{u} = 0^m$ or $\mathbf{v} = \mathbf{g}$ in the corresponding chain makes them *local* (in fact, we will get certain *sequential update* rules).

Remark 6.9. The origin of nonlocality in the above Markov chains is the conjugation of the skew functions that is necessary for the transition probabilities to add up to 1 (cf. (6.9) and (6.10)). This conjugation may be viewed as an instance of the classical Doob's h -transform (we refer to, e.g., [KOR02], [Kön05] for details).

Another way of introducing locality to Markov chains $\mathcal{X}_{\mathbf{u};\{v_t\}}^\circ$ and $\mathcal{X}_{\{u_t\};\mathbf{v}}^+$ that works for generic \mathbf{u} and \mathbf{v} , respectively, could be to consider ‘‘multivariate’’ chains on whole interlacing arrays (similarly to, e.g., [O’C03a], [O’C03b], [BF14], [BP13], [MP15], with [BB15] providing an application to the six vertex model on the torus), but we will not discuss this here.

Let us discuss update rules of the dynamics $\mathcal{X}_{0^M;\{v_t\}}^\circ$ and $\mathcal{X}_{\{u_t\};\mathbf{g}}^+$ in detail. They follow from (6.15) and (6.16) combined with the interpretation of functions \mathbf{F} and \mathbf{G} as partition functions of path collections with stochastic vertex weights (2.3).

6.4.1. Dynamics $\mathcal{X}_{0^M;\{v_t\}}^\circ$. Fix $M \in \mathbb{Z}_{\geq 0}$. During each time step $t \rightarrow t+1$ of the chain $\mathcal{X}_{0^M;\{v_t\}}^\circ$, the current configuration $\mu = 0^{m_0} 1^{m_1} 2^{m_2} \dots \in \mathbf{Sign}_M^+$ is randomly changed to $\nu = 0^{n_0} 1^{n_1} 2^{n_2} \dots \in \mathbf{Sign}_M^+$ according to the following sequential (left to right) update. First, choose $n_0 \in \{0, 1, \dots, m_0\}$ from the probability distribution

$$\mathbf{L}_{\xi_0^{-1} v_{t+1}, s_0}(m_0, 0; n_0, m_0 - n_0),$$

and set $h_1 := m_0 - n_0 \in \{0, 1\}$. Then, having h_1 and m_1 , choose $n_1 \in \{0, 1, \dots, m_1 + h_1\}$ from the probability distribution

$$\mathbf{L}_{\xi_1^{-1} v_{t+1}, s_1}(m_1, h_1; n_1, m_1 + h_1 - n_1),$$

and set $h_2 := m_1 + h_1 - n_1 \in \{0, 1\}$. Continue in the same manner for $x = 2, 3, \dots$ by choosing $n_x \in \{0, 1, \dots, m_x + h_x\}$ from the distribution

$$\mathbb{L}_{\xi_x^{-1}v_{t+1}, s_x}(m_x, h_x; n_x, m_x + h_x - n_x),$$

and setting $h_{x+1} := m_x + h_x - n_x \in \{0, 1\}$. Since at each step the probability that $h_{x+1} = 1$ is strictly less than 1, eventually for some $x > \mu_1$ we will have $h_{x+1} = 0$, which means that the update will terminate (all the above choices are independent). See Fig. 14, left, for an example.

6.4.2. *Dynamics* $\mathcal{X}_{\{u_t\}; \mathbf{e}}^+$. During each time step $t \rightarrow t+1$ of the chain $\mathcal{X}_{\{u_t\}; \mathbf{e}}^+$, the current configuration $\mu = 1^{m_1}2^{m_2} \dots \in \text{Sign}_M^+$ is randomly changed to $\nu = 1^{n_1}2^{n_2} \dots \in \text{Sign}_{M+1}^+$ according to the following sequential (left to right) update (note that here M is increased with time, and also that there cannot be any particles at location 0).

First, choose $n_1 \in \{0, 1, \dots, m_1 + 1\}$ from the probability distribution

$$\mathbb{L}_{\xi_1 u_{t+1}, s_1}(m_1, 1; n_1, m_1 + 1 - n_1),$$

and set $h_2 := m_1 + 1 - n_1 \in \{0, 1\}$. The fact that $j_1 = 1$ in this stochastic vertex weight accounts for the incoming arrow from 0. For $x = 2, 3, \dots$ continue in the same way, for each x choosing $n_x \in \{0, 1, \dots, m_x + h_x\}$ from the probability distribution

$$\mathbb{L}_{\xi_x u_{t+1}, s_x}(m_x, h_x; n_x, m_x + h_x - n_x),$$

and setting $h_{x+1} = m_x + h_x - n_x \in \{0, 1\}$. The update will eventually terminate when $h_{x+1} = 0$ for some $x > \mu_1$. See Fig. 14, right, for an example.

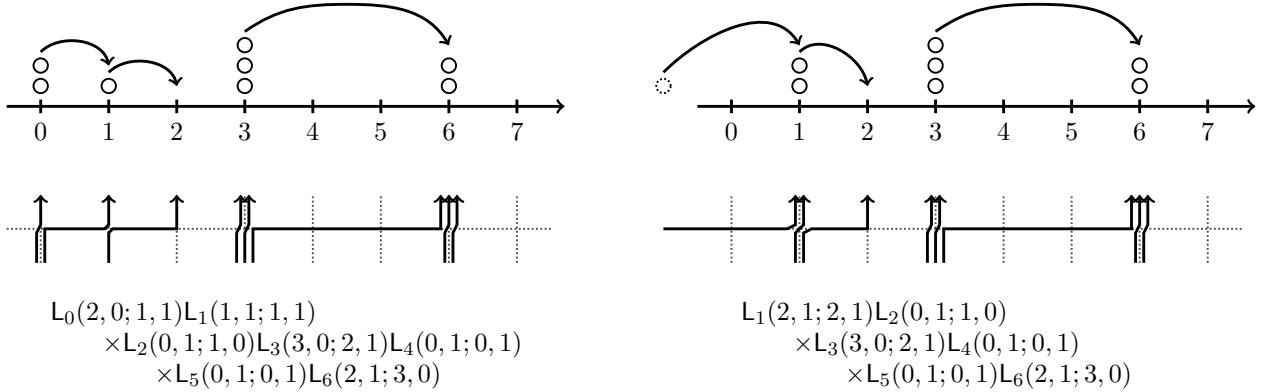

FIGURE 14. Left: a possible move under the chain $\mathcal{X}_{0M; \{v_t\}}^o$ with $M = 8$ (depicted in terms of particle and path configurations). The probability of this move is also given, where $\mathbb{L}_j = \mathbb{L}_{\xi_j^{-1}v_{t+1}, s_j}$. Right: a possible move under the chain $\mathcal{X}_{\{u_t\}; \mathbf{e}}^+$ with $M = 7$ (so that the resulting configuration has 8 particles). The probability of this move is also given, with $\mathbb{L}_j = \mathbb{L}_{\xi_j u_{t+1}, s_j}$.

6.4.3. *Properties of dynamics*. We will now list a number of immediate properties of the Markov chains $\mathcal{X}_{0M; \{v_t\}}^o$ and $\mathcal{X}_{\{u_t\}; \mathbf{e}}^+$ described above.

- Under both dynamics, particles move only to the right. Moreover, at most one particle can leave any given stack of particles and it can move only as far as the next nonempty stack of particles.
- The property that at most one particle can leave any given stack of particles is a $J = 1$ feature. One can readily define *fused dynamics* involving stochastic vertex weights $\mathbb{L}_{z, s}^{(J)}$ for any $J \in \mathbb{Z}_{\geq 1}$ (see §5.2). In these general J dynamics, at most J particles can leave any given stack. One step of a general J dynamics (say, an analogue of \mathcal{X}^+) can be thought of as simply combining J steps of the $J = 1$ dynamics with parameters $u_t, qu_t, \dots, q^{J-1}u_t$. Results of §5.2 show that one can then forget about the

intermediate configurations during these J steps, and still obtain a Markov chain. We will utilize these general J Markov chains in §6.6 below.

- If the dynamics $\mathcal{X}_{\mathbf{u};\{v_t\}}^\circ$ is started from the initial configuration 0^M (that is, all M particles are at zero), then at any time t the distribution of the particle configuration is given by $\mathcal{M}_{\mathbf{u};(v_1,\dots,v_t)}$. Similarly, if $\mathcal{X}_{\{u_t\};\mathbf{v}}^+$ starts from the empty initial configuration, then at any time t the distribution of the particle configuration is given by $\mathcal{M}_{(u_1,\dots,u_t);\mathbf{v}}$. This follows from (6.11).
- Let us return to local dynamics. As follows from (6.12)–(6.13), the eigenfunctions of the transition operator $\mathcal{Q}_{0^M,v}^\circ$ corresponding to the dynamics \mathcal{X}° (on M -particle configurations) are

$$\Psi_\lambda(z_1, \dots, z_M) = \frac{1}{(q; q)_M (-S)^\lambda} F_\lambda(z_1, \dots, z_M | \Xi, S), \quad \mathcal{Q}_{0^M,v}^\circ \Psi_\lambda(\mathbf{z}) = \left(\prod_{j=1}^M \frac{1 - qz_j v}{1 - z_j v} \right) \Psi_\lambda(\mathbf{z})$$

(here and below for $\mathbf{u} = 0^M$ we write Ψ_λ instead of $\Psi_\lambda^\mathbf{u}$).

- In the homogeneous case $\xi_j \equiv 1$ and $\mathbf{s}_j \equiv \mathbf{s}$, the dynamics $\mathcal{X}_{0^M;\{v_t\}}^\circ$ on M -particle configurations appeared in [CP15] (under the name $J = 1$ *higher spin zero range process*). In this homogeneous setting, [CP15] established certain duality relations for this dynamics.¹⁶ Some of the results in [CP15] also deal with infinite-particle process like $\mathcal{X}_{0^M;\{v_t\}}^\circ$, which starts from the initial configuration $0^\infty 1^0 2^0 \dots$ (interpreting the zero range process as an exclusion process, this would correspond to the most well-studied *step initial data*). In this case, during each time step $t \rightarrow t+1$, one particle can escape the location 0 with probability $\mathbb{L}_{\xi_0^{-1}v_{t+1}, \mathbf{s}_0}^{-1}(\infty, 0; \infty, 1) = (-\mathbf{s}_0 \xi_0^{-1} v_{t+1}) / (1 - \mathbf{s}_0 \xi_0^{-1} v_{t+1})$ (note that under (5.1)–(5.2) this number is between 0 and 1). In §6.6 below we will discuss how this initial condition can be obtained by a straightforward limit transition from the dynamics $\mathcal{X}_{\{u_t\};\mathbf{g}}^+$. Thus, considering the latter dynamics without this limit transition adds a new boundary condition, under which during each time step, a new particle is *always* added at the leftmost location.

6.5. Degeneration to the six vertex model and the ASEP. In this subsection we do not assume that our parameters satisfy (5.1)–(5.2). However, all algebraic statements discussed above in this section (e.g., Proposition 6.4) continue to hold without this assumption — they just become statements about linear operators. Moreover, one can say that these are statements about *formal* Markov operators, i.e., in which the matrix elements sum up to one along each row, but are not necessarily nonnegative.

Observe that taking $\mathbf{s}^2 = q^{-I}$ for $I \in \mathbb{Z}_{\geq 1}$ makes the weight

$$\mathbb{L}_{u,\mathbf{s}}(I, 1; I+1, 0) = \frac{1 - \mathbf{s}^2 q^I}{1 - \mathbf{s}u}$$

vanish, regardless of u . If, moreover, all other weights $\mathbb{L}_{u,\mathbf{s}}(i_1, j_1; i_2, j_2)$ with $i_{1,2} \in \{0, 1, \dots, I\}$ and $j_{1,2} \in \{0, 1\}$ are nonnegative, then we can restrict our attention to path ensembles in which the multiplicities of all vertical edges are bounded by I , and still talk about interacting particle systems as in §6.4 above.

Let us consider the simplest case and take $I = 1$, so $\mathbf{s} = q^{-\frac{1}{2}}$. For this choice of \mathbf{s} , there are six possible arrow configurations at a vertex, and their weights are given in Fig. 15. These weights are nonnegative if either $0 < q < 1$ and $u \geq q^{-\frac{1}{2}}$, or $q > 1$ and $0 \leq u \leq q^{-\frac{1}{2}}$ (these are the new nonnegativity conditions replacing (5.1)–(5.2) for $\mathbf{s} = q^{-\frac{1}{2}}$). Observe the following symmetry of the vertex weights:

$$\mathbb{L}_{u,q^{-\frac{1}{2}}}(i_1, j_1; i_2, j_2) = \mathbb{L}_{u^{-1},q^{-\frac{1}{2}}}(1 - i_1, 1 - j_1; 1 - i_2, 1 - j_2) \Big|_{q \rightarrow q^{-1}}, \quad i_1, j_1, i_2, j_2 \in \{0, 1\}. \quad (6.17)$$

In the semi-infinite horizontal strip one must set $\mathbf{s}_x \equiv q^{-\frac{1}{2}}$ for all $x \in \mathbb{Z}_{\geq 0}$. While this eliminates the inhomogeneity in the \mathbf{s} -parameters, one can still take inhomogeneous spectral parameters, so that at the intersection of the i -th horizontal and the j -th vertical lines the parameter is equal to $\xi_j u_i$

¹⁶Similar duality results also appeared earlier in [BCS14], [BC13], [Cor14] for q -TASEP and q -Hahn degenerations of the general higher spin six vertex model. They also hold in an inhomogeneous setting, cf. §8.5 below.

$L_{u, q^{-\frac{1}{2}}}$	1	b_1	$1 - b_1$	b_2	$1 - b_2$	1

FIGURE 15. All six stochastic vertex weights corresponding to $\mathbf{s} = q^{-\frac{1}{2}}$. The weights $b_{1,2}$ are expressed through u and q as $b_1 = \frac{1 - uq^{\frac{1}{2}}}{1 - uq^{-\frac{1}{2}}}$ and $b_2 = \frac{-uq^{-\frac{1}{2}} + q^{-1}}{1 - uq^{-\frac{1}{2}}}$.

(cf. Fig. 9). This leads to the *inhomogeneous stochastic six vertex model*. A homogeneous version of the model (corresponding to $u_i \equiv u$ and $\xi_j \equiv 1$) was introduced in [GS92] and studied recently in [BCG14]. Simulations of the stochastic six vertex model (both homogeneous and inhomogeneous) are given in Fig. 16.

The paper [BCG14] deals with the homogeneous stochastic six vertex model in which the vertical arrows are entering from below, and no arrows enter from the left (cf. Fig. 16, left). Moreover, to get a nontrivial limit shape, one should take $q > 1$. However, with the help of the symmetry (6.17) (leading to the swapping of arrows with empty edges), these boundary conditions are equivalent to considering the process $\mathcal{X}_{\{u_i\}; \mathbf{e}}^+$ with $0 < q < 1$, which is our usual assumption throughout the text. Simulations of the latter dynamics can be obtained from the pictures in Fig. 16 by reflecting them with respect to the diagonal of the first quadrant.

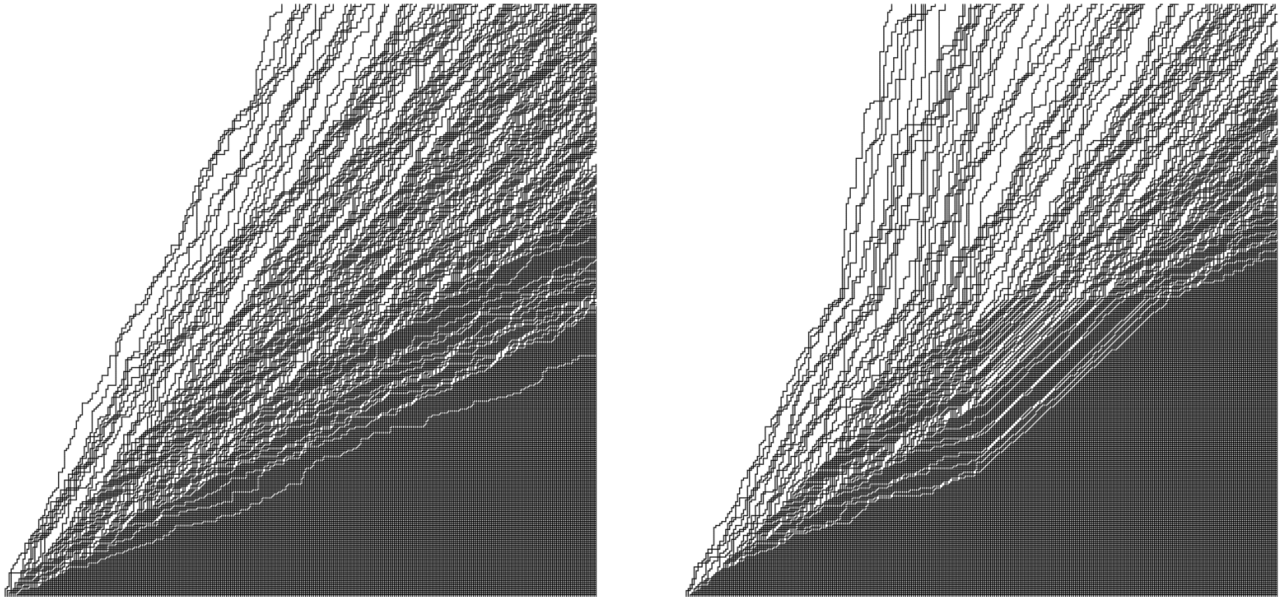

FIGURE 16. Left: A simulation of the homogeneous stochastic six vertex model of size 300 with boundary conditions as in [BCG14] and parameters $L(0, 1; 0, 1) = 0.3$, $L(1, 0; 1, 0) = 0.7$. Right: A simulation of the inhomogeneous stochastic six vertex model of size 300 with the same boundary conditions. The parameters $(L(0, 1; 0, 1), L(1, 0; 1, 0))$ are $(0.3, 0.7)$ in the lower left and the upper right quarters, $\approx (0.38, 0.88)$ in the upper left quarter, and $\approx (0.041, 0.096)$ in the lower right quarter (note that the ratio q of the parameters must be the same).

The stochastic six vertex model which is inhomogeneous in both the vertical and the horizontal directions can be studied (in the sense of computing certain observables) using the technique developed here, see §10.1 below. In fact, the tools of [BCG14] also allow to study the stochastic six vertex model which is inhomogeneous in one direction (varying spectral parameters).

Let us briefly discuss two continuous time limits of the stochastic six vertex model. Here we restrict our attention to systems of the type $\mathcal{X}_{0^M; \{v_t\}}^\circ$, i.e., with a fixed finite number of particles (about other boundary and initial conditions see also §10.1 below). The first of the limits is the well-known ASEP (Asymmetric Simple Exclusion Process) introduced in [Spi70] (see Fig. 17), which is obtained as follows. Observe that for $u = q^{-\frac{1}{2}} + (1 - q)q^{-\frac{1}{2}}\epsilon$, we have as $\epsilon \searrow 0$:

$$L_{u, q^{-\frac{1}{2}}}(0, 1; 0, 1) = \epsilon + O(\epsilon^2), \quad L_{u, q^{-\frac{1}{2}}}(1, 0; 1, 0) = q\epsilon + O(\epsilon^2).$$

Therefore, taking $\xi_j \equiv 1$ and ϵ small, the particles in the stochastic six vertex model will mostly travel to the right by 1 at every step. If we subtract this deterministic shift and look at times of order ϵ^{-1} , then the rescaled discrete time process will converge to the continuous time ASEP with $r = 1$ and $\ell = q$, see Fig. 18 (note that multiplying both r and ℓ by a constant is the same as a deterministic rescaling of the continuous time in the ASEP, and thus is a harmless operation).

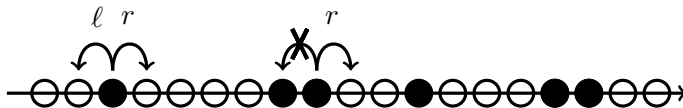

FIGURE 17. The ASEP is a continuous time Markov chain on particle configurations on \mathbb{Z} (in which there is at most one particle per site). Each particle has two exponential clocks of rates r and ℓ , respectively (all exponential clocks in the process are assumed independent). When the “ r ” clock of a particle rings, it immediately tries to jump to the right by one, and similarly for the “ ℓ ” clock and left jumps. If the destination of a jump is already occupied, then the jump is blocked. (This describes the ASEP with finitely many particles, but one can also construct the infinite-particle ASEP following, e.g., the graphical method of [Har78].)

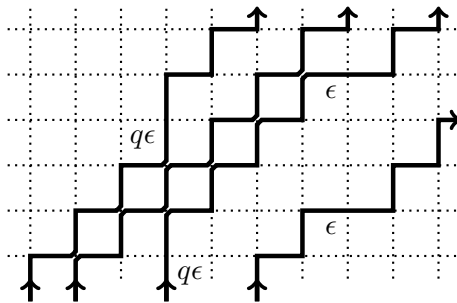

FIGURE 18. Limit of the six vertex model to the ASEP.

Remark 6.10. Because we are subtracting the deterministic shift, it seems unlikely that one can utilize the inhomogeneous stochastic six vertex model to produce an inhomogeneous extension of the ASEP as a continuous time limit.

It is worth noting that duality for the ASEP with bond-dependent jump rates exists (cf. [BCS14, Rmk. 4.4]; such a duality was essentially established in [Sch97]), but moment formulas (similar to the ones in §9 below) for that inhomogeneous ASEP do not seem to be known.

Another continuous time limit is obtained by setting:

$$q = \frac{1 - \epsilon}{\alpha}, \quad u = \frac{\epsilon \alpha^{\frac{1}{2}}}{1 - \alpha},$$

where $0 < \alpha < 1$, so that as $\epsilon \rightarrow 0$ we have

$$\mathbb{L}_{\xi_j u, q^{-\frac{1}{2}}}(0, 1; 0, 1) = \alpha + \alpha(1 - \xi_j)\epsilon + O(\epsilon^2), \quad \mathbb{L}_{\xi_j u, q^{-\frac{1}{2}}}(1, 0; 1, 0) = 1 - \xi_j\epsilon + O(\epsilon^2).$$

At times of order ϵ^{-1} , the system behaves as follows. Each particle at a location j has an exponential clock with rate ξ_j . When the clock rings, the particle wakes up and performs a jump to the right having the geometric distribution with parameter α . However, if in the process of the jump this particle runs into another particle (i.e., its first neighbor on the right), then the moving particle stops at this neighbor's location, and the neighbor wakes up (and subsequently performs a geometrically distributed jump). See Fig. 19.

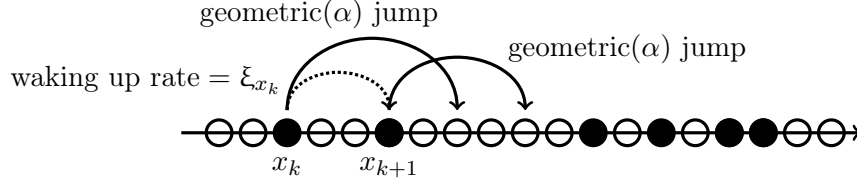

FIGURE 19. A possible jump in the second limit of the (inhomogeneous) stochastic six vertex model. The particle at x_k wakes up at rate ξ_{x_k} and decides to jump by 5 with probability $(1 - \alpha)\alpha^4$ (waking up means that the particle will jump by at least one). However, x_{k+1} is closer than the intended jump of x_k , and so x_k stops at the location of x_{k+1} , and the latter particle wakes up. Then x_{k+1} decides to jump by 4 with probability $(1 - \alpha)\alpha^3$.

6.6. Degeneration to q -Hahn and q -Boson systems. In this subsection we will consider another family of degenerations of the higher spin six vertex model which puts no restrictions on the vertical multiplicities. For these degenerations we will need to employ the general J stochastic vertex weights $\mathbb{L}_{u,s}^{(J)}(i_1, j_1; i_2, j_2)$ described in §5.2.

Proposition 6.11. *When $u = s$, formula (5.6) for the weights $\mathbb{L}_{u,s}^{(J)}$ simplifies to the following product form:*

$$\mathbb{L}_{s,s}^{(J)}(i_1, j_1; i_2, j_2) = \mathbf{1}_{i_1+j_1=i_2+j_2} \cdot \mathbf{1}_{j_2 \leq i_1} \cdot (s^2 q^J)^{j_2} \frac{(q^{-J}; q)_{j_2} (s^2 q^J; q)_{i_1-j_2}}{(s^2; q)_{i_1}} \frac{(q; q)_{i_1}}{(q; q)_{j_2} (q; q)_{i_1-j_2}}. \quad (6.18)$$

Proof. To show this, one can directly check that (6.18) satisfies the corresponding recursion relation for $u = s$ (5.5). Alternatively, one can transform the ${}_4\phi_3$ q -hypergeometric function to the desired form. We refer to [Bor14, Prop. 6.7] for the complete proof following the second approach. \square

We see that this degeneration turns the higher spin interacting particle systems described in §6.4 with sequential update into simpler systems with parallel update.

6.6.1. Distribution $\varphi_{q,\mu,\nu}$. Before discussing interacting particle systems arising from the vertex weights (6.18), let us focus on the q -deformed Beta-binomial distribution appearing in the right-hand side of that formula:

$$\varphi_{q,\mu,\nu}(j | m) := \mu^j \frac{(\nu/\mu; q)_j (\mu; q)_{m-j}}{(\nu; q)_m} \frac{(q; q)_m}{(q; q)_j (q; q)_{m-j}}, \quad j \in \{0, 1, \dots, m\}. \quad (6.19)$$

Here $m \in \mathbb{Z}_{\geq 0} \cup \{+\infty\}$, and the case $m = +\infty$ corresponds to a straightforward limit of (6.19), see (6.23) below. If the parameters belong to one of the following families:

- (1) $0 < q < 1$, $0 \leq \mu \leq 1$, and $\nu \leq \mu$;
- (2) $0 < q < 1$, $\mu = q^J \nu$ for some $J \in \mathbb{Z}_{\geq 0}$, and $\nu \leq 0$;
- (3) m is finite, $q > 1$, $\mu = q^{-J} \nu$ for some $J \in \mathbb{Z}_{\geq 0}$, and $\nu \leq 0$;
- (4) m is finite, $q > 0$, $\mu = q^{\tilde{\mu}}$, and $\nu = q^{\tilde{\nu}}$ with $\tilde{\mu}, \tilde{\nu} \in \mathbb{Z}$, such that
 - either $\tilde{\mu}, \tilde{\nu} \geq 0$, and $\tilde{\nu} \geq \tilde{\mu}$,
 - or $\tilde{\mu}, \tilde{\nu} \leq 0$, $\tilde{\nu} \leq -m$, and $\tilde{\nu} \leq \tilde{\mu}$,

then the weights (6.19) are nonnegative.¹⁷ The above conditions (6.20) replace the nonnegativity conditions (5.1)–(5.2) for this subsection.

We will now discuss several interpretations of the distribution (6.19) which, in particular, will justify its name. The significance of the probability distribution $\varphi_{q,\mu,\nu}$ for interacting particle systems was first realized by Povolotsky [Pov13], who showed that it corresponds to the most general “chipping model” (i.e., a particle system as in Fig. 14 with possibly multiple particles leaving a given stack at a time) having parallel update, product-form steady state, and such that the system is solvable by the coordinate Bethe ansatz. He also provided an algebraic interpretation of this distribution:

Proposition 6.12 ([Pov13, Thm. 1]). *Let A and B be two letters satisfying the following quadratic commutation relation:*

$$BA = \alpha A^2 + \beta AB + \gamma B^2, \quad \alpha + \beta + \gamma = 1.$$

Then

$$(pA + (1-p)B)^m = \sum_{j=0}^m \varphi_{q,\mu,\nu}(j | m) A^j B^{m-j}, \quad (6.21)$$

where

$$\alpha = \frac{\nu(1-q)}{1-q\nu}, \quad \beta = \frac{q-\nu}{1-q\nu}, \quad \gamma = \frac{1-q}{1-q\nu}, \quad \mu = p + \nu(1-p).$$

In particular, taking $A = B = 1$ in (6.21) implies that the weights (6.19) sum to 1 over $j = 0, 1, \dots, m$. The proof of the above statement is nontrivial, and we will not reproduce it here.

Another interpretation of the q -deformed Beta-binomial distribution can be given via a q -version of the Pólya’s urn process due to Gnedin and Olshanski [GO09]. Consider the Markov chain on the Pascal triangle

$$\bigsqcup_{m=0}^{\infty} \{(k, \ell) \in \mathbb{Z}_{\geq 0}^2 : k + \ell = m\}$$

with the following transition probabilities (here $m = k + \ell$ is the time in this chain)

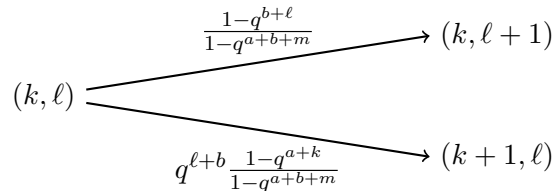

¹⁷These are sufficient conditions for nonnegativity, and in fact some of these families intersect nontrivially. We do not attempt to list all the necessary conditions (as, for example, for $q < 0$ there also exist values of μ and ν leading to nonnegative weights).

Then the distribution of this Markov chain (started from the initial vertex $(0, 0)$) at time m is

$$\text{Prob}((k, \ell)) = \varphi_{q, q^b, q^{a+b}}(k | m), \quad k = 0, 1, \dots, m.$$

More general Markov chains (on the space of interlacing arrays) based on the distributions $\varphi_{q, q^b, q^{a+b}}$ with negative a and b which have a combinatorial significance (they are q -deformations of the classical Robinson–Schensted–Knuth insertion algorithm) were constructed recently in [MP15].

Another feature of the distribution $\varphi_{q, \mu, \nu}$ is that it is the weight function for the so-called q -Hahn orthogonal polynomials. See [KS96, §3.6] about the polynomials, and [BCPS15a, §5.2] for the exact matching between $\varphi_{q, \mu, \nu}$ and the notation related to the q -Hahn polynomials.

6.6.2. q -Hahn particle system. We will now discuss what the dynamics $\mathcal{X}_{0^M; \{v_t\}}^\circ$ and $\mathcal{X}_{\{u_t\}; \mathfrak{q}}^+$ look like under the degeneration described in Proposition 6.11. We will first consider the dynamics $\mathcal{X}_{0^M; \{v_t\}}^\circ$ which lives on particle configurations with a fixed number of particles (say, $M \in \mathbb{Z}_{\geq 0}$), and then will deal with $\mathcal{X}_{\{u_t\}; \mathfrak{q}}^+$. The resulting dynamics will be commonly referred to as the q -Hahn particle system with different initial or boundary conditions.

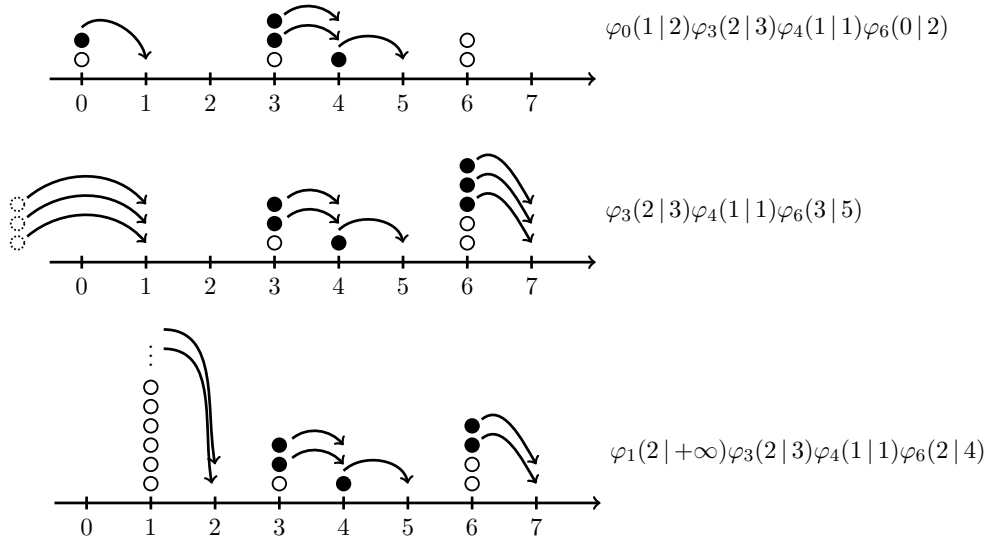

FIGURE 20. Possible transitions of the q -Hahn particle system, with probabilities given on the right (here $\varphi_x \equiv \varphi_{q, q^J s_x^2, s_x^2}$). Top: dynamics $\mathcal{X}_{q\text{-Hahn}}^\circ$ living on configurations with a fixed number of particles. Middle: dynamics $\mathcal{X}_{q\text{-Hahn}}^+$, in which at each time step J new particles are added at location 1 ($J = 3$ on the picture). Bottom: dynamics $\mathcal{X}_{q\text{-Hahn}}^\infty$ with the initial condition $1^\infty 2^0 3^0 \dots$.

In order to perform the desired degeneration of \mathcal{X}° , let us fix the \mathfrak{s} -parameters $\{s_j\}_{j \in \mathbb{Z}_{\geq 0}}$ indexed by the semi-infinite lattice, and set $\xi_j = s_j^{-1}$ for all j . Also fix $J \in \mathbb{Z}_{\geq 1}$, and take the time-dependent parameters $\{v_t\}$ to be

$$(v_1, v_2, \dots) = (1, q, \dots, q^{J-1}, 1, q, \dots, q^{J-1}, \dots).$$

We will consider the *fused dynamics* in which one time step corresponds to J steps of the original dynamics. The fused dynamics is Markovian due to the results of §5.2. As follows from §6.4.1, each time step $\mu = 0^{m_0} 1^{m_1} 2^{m_2} \dots \rightarrow \nu = 0^{n_0} 1^{n_1} 2^{n_2} \dots$ ($\mu, \nu \in \text{Sign}_M^+$) of the fused dynamics looks as follows. For each location $x \in \mathbb{Z}_{\geq 0}$, sample $j_x \in \{0, 1, \dots, m_x\}$ independently of other locations according to the probability distribution $\varphi_{q, q^J s_x^2, s_x^2}(j_x | m_x)$ (clearly, $j_x = m_x = 0$ for all large enough x). Then, in parallel,

move j_x particles from location x to location $x + 1$ for each $x \in \mathbb{Z}_{\geq 0}$, that is, set $n_x = m_x - j_x + j_{x+1}$. Denote this dynamics by $\mathcal{X}_{q\text{-Hahn}}^\circ$ (see Fig. 20, top).

Note that the weights $\varphi_{q,q^J s_x^2, s_x^2}$ are nonnegative for $J \in \mathbb{Z}_{\geq 1}$ if $s_x^2 \leq 0$ (case 2 in (6.20)), and we are assuming this in our construction.

Remark 6.13. For $J \in \mathbb{Z}_{\geq 1}$, at most J particles can leave any given location during one time step. However, since the weights of the distribution $\varphi_{q,q^J s_x^2, s_x^2}$ depend on q^J in a rational way, we may analytically continue $\mathcal{X}_{q\text{-Hahn}}^\circ$ from the case $q^J \in q^{\mathbb{Z}_{\geq 1}}$ and $s_x^2 \leq 0$, and let the parameters $\mu_x = q^J \nu_x$ and $\nu_x = s_x^2$ belong to one of the other families in (6.20). If $\mu_x/\nu_x \notin q^{\mathbb{Z}_{\geq 1}}$, then an arbitrary number of particles can leave any given location during one time step.

Let us now discuss the degeneration of the dynamics $\mathcal{X}_{\{u_t\};\mathfrak{g}}^+$. Fix $J \in \mathbb{Z}_{\geq 1}$, take $\xi_j = s_j$ for all $j \in \mathbb{Z}_{\geq 0}$, and let the time-dependent parameters $\{u_t\}$ be

$$(u_1, u_2, \dots) = (1, q, \dots, q^{J-1}, 1, q, \dots, q^{J-1}, \dots). \quad (6.22)$$

From §6.4.2 we see that the corresponding fused dynamics is very similar to $\mathcal{X}_{q\text{-Hahn}}^\circ$, and the only difference is in the behavior at locations 0 and 1. Namely, location 0 cannot be occupied, and at each time step, exactly J new particles are added at location 1. Denote this degeneration of $\mathcal{X}_{\{u_t\};\mathfrak{g}}^+$ by $\mathcal{X}_{q\text{-Hahn}}^+$ (see Fig. 20, middle).

Because $J \in \mathbb{Z}_{\geq 1}$ particles are added to the configuration at each time step, dynamics $\mathcal{X}_{q\text{-Hahn}}^+$ cannot be analytically continued in J similarly to Remark 6.13. However, we can simplify this dynamics, by generalizing (6.22) to

$$(u_1, u_2, \dots) = (1, q, \dots, q^{K-1}, 1, q, \dots, q^{J-1}, 1, q, \dots, q^{J-1}, \dots),$$

where $K \in \mathbb{Z}_{\geq 1}$ is a new parameter. If we start the corresponding fused dynamics from the empty initial configuration $1^0 2^0 \dots$, then after the first step of this dynamics the configuration will be simply $1^K 2^0 3^0 \dots$. Moreover, during the evolution, the number of particles at location 1 will always be $\geq K$. Assume that $|q| < 1$, and take $K \rightarrow +\infty$. Under the limiting dynamics, at all subsequent times the number of particles leaving location 1 has the distribution

$$\lim_{i_1 \rightarrow +\infty} \mathbf{L}_{s_1, s_1}^{(J)}(i_1, j_1; i_2, j_2) = \mathbf{1}_{i_2 = +\infty} \cdot \varphi_{q, q^J s_1^2, s_1^2}(j_2 | +\infty), \quad \varphi_{q, \mu, \nu}(j | +\infty) = \mu^j \frac{(\nu/\mu; q)_j}{(q; q)_j} \frac{(\mu; q)_\infty}{(\nu; q)_\infty}. \quad (6.23)$$

The limit as $K \rightarrow +\infty$ clearly does not affect probabilities of particle jumps at all other locations. We will denote the limiting dynamics by $\mathcal{X}_{q\text{-Hahn}}^\infty$ (see Fig. 6.19, bottom). When the parameters $s_j \equiv s$ are homogeneous, this particle system was introduced in [Pov13]. The system $\mathcal{X}_{q\text{-Hahn}}^\infty$ readily admits an analytic continuation from $q^J \in q^{\mathbb{Z}_{\geq 1}}$ and $s_x^2 \leq 0$ as in Remark 6.13.

Remark 6.14. It is possible to start any dynamics $\mathcal{X}_{\{u_t\};\mathfrak{g}}^+$ (i.e., with arbitrary admissible parameters Ξ, S , and $\{u_t\}$) from the initial configuration $1^\infty 2^0 3^0 \dots$. Indeed, for that one simply must take $\xi_1 = s_1$, and take $K \rightarrow +\infty$ as above. Under the resulting (non-fused, $J = 1$) dynamics, the number of particles leaving location 1 during time step $t \rightarrow t + 1$ has the distribution

$$\lim_{i_1 \rightarrow +\infty} \mathbf{L}_{s_1 u_{t+1}, s_1}(i_1, j_1; i_2, j_2) = \mathbf{1}_{i_2 = +\infty} \cdot \begin{cases} \frac{1}{1 - s_1^2 u_{t+1}}, & j_2 = 0; \\ \frac{-s_1^2 u_{t+1}}{1 - s_1^2 u_{t+1}}, & j_2 = 1. \end{cases}$$

Note that these probabilities are between 0 and 1 if $s_1^2 \leq 0$ and $u_{t+1} \geq 0$, as in the above discussion. We will denote this dynamics started from the infinite number of particles at location 1 by $\mathcal{X}_{\{u_t\}}^\infty$. We analyze its observables in §10.2 below.

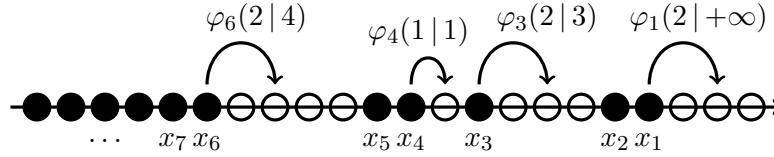

FIGURE 21. The transition of the q -Hahn system $\mathcal{X}_{q\text{-Hahn}}^\infty$ from Fig. 20, bottom, interpreted in terms of the q -Hahn TASEP (here $\varphi_i \equiv \varphi_{q,q^J s_i^2, s_i^2}$).

Thanks to infinitely many particles at location 1, the system $\mathcal{X}_{q\text{-Hahn}}^\infty$ admits another nice particle interpretation. Namely, consider right-finite particle configurations $\{x_1 > x_2 > x_3 > \dots\}$ in \mathbb{Z} , in which there can be at most one particle at a given location. For a configuration $\lambda = 1^\infty 2^{\ell_2} 3^{\ell_3} \dots$ of $\mathcal{X}_{q\text{-Hahn}}^\infty$, let $\ell_j = x_{j-1} - x_j - 1$ (with $x_0 = +\infty$) be the number of empty spaces between consecutive particles. Let the process start from the *step initial configuration* $x_i(0) = -i$ for all i (corresponding to $\lambda = 1^\infty 2^0 3^0 \dots$). Then during each time step, each particle x_i jumps to the right according to the distribution $\varphi_{q,q^J s_i^2, s_i^2}(\cdot | \text{gap}_i)$, where $\text{gap}_i = \ell_i$ is the distance to the nearest right neighbor of x_i (the first particle uses the distribution with $\text{gap}_1 = +\infty$). This system is called the *q-Hahn TASEP*, it was also introduced in [Pov13] (in the homogeneous case $s_j \equiv s$). See Fig. 21.

Remark 6.15. In all the above q -Hahn systems, one can clearly let the parameter J to depend on time.

6.6.3. *q-TASEP and q-Boson.* Let us now perform a further degeneration of the q -Hahn TASEP corresponding to the parameters q and $\{\mu_i\}, \{\nu_i\}$, by setting $\mu_i = q\nu_i$ for all i (that is, we take $J = 1$, and thus must consider $\nu \leq 0$). Then (6.19) implies that $\varphi_{q,\mu,\nu}(j | m)$ vanishes unless $j \leq 1$, and

$$\begin{aligned} \varphi_{q,\mu,\nu}(0 | m) &= \frac{1 - q^m \nu}{1 - \nu}, & \varphi_{q,\mu,\nu}(1 | m) &= \frac{-\nu(1 - q^m)}{1 - \nu}, \\ \varphi_{q,\mu,\nu}(0 | +\infty) &= \frac{1}{1 - \nu}, & \varphi_{q,\mu,\nu}(1 | +\infty) &= \frac{-\nu}{1 - \nu}. \end{aligned}$$

Taking $\nu_i = -\epsilon a_i$ (with $a_i > 0$) and speeding up the time by ϵ^{-1} , we arrive at the *q-TASEP* — a continuous time particle system on configurations $\{x_1 > x_2 > x_3 > \dots\}$ on \mathbb{Z} (with no more than one particle per location) in which each particle x_i jumps to the right by one at rate $a_i(1 - q^{\text{gap}_i})$, where, as before, $\text{gap}_i = x_{i-1} - x_i - 1$ is the distance to the right neighbor of x_i .

The *q-TASEP* was introduced in [BC14] (see also [BCS14]), and an “arrow” interpretation of the *q-TASEP* (on configurations $\lambda = 1^\infty 2^{\text{gap}_2} 3^{\text{gap}_3} \dots$) had been considered much earlier [BBT94], [BIK98], [SW98] under the name of the (*stochastic*) *q-Boson system*.

It is worth noting that the q -Hahn system has a variety of other degenerations, see [Pov13] and [BC15] for examples.

7. ORTHOGONALITY RELATIONS

In this section we describe two types of (bi)orthogonality relations for the symmetric rational functions F_λ from §4. These relations imply certain Plancherel isomorphism theorems. We also apply biorthogonality to get an integral representation for the functions G_μ . The results of this section provide us with tools which will eventually allow to explicitly evaluate averages of certain observables of the interacting particle systems described in §6 above.

7.1. **Spatial biorthogonality.** First, we will need the following general statement:

Lemma 7.1. *Let $\{f_m(u)\}, \{g_\ell(u)\}$ be two families of rational functions in $u \in \mathbb{C}$ such that there exist two disjoint sets $P_1, P_2 \subset \mathbb{C} \cup \{\infty\}$ ¹⁸ and positively oriented pairwise nonintersecting closed contours c_1, \dots, c_k with the following properties:*

- *All singularities of all the functions $f_m(u), g_\ell(u)$ lie inside $P_1 \cup P_2$.*
- *The product $f_m(u)g_\ell(u)$ does not have singularities in P_1 if $m < \ell$, and the same product does not have singularities in P_2 if $m > \ell$.*
- *For any $i > j$ the contour c_i can be shrunk to P_1 without intersecting the contour¹⁹ $q^{-1}c_j$ (equivalently, for any $j < i$ the contour c_j can be shrunk to P_2 without intersecting $q \cdot c_i$). Shrinking takes place on the Riemann sphere $\mathbb{C} \cup \{\infty\}$.*

Fix $k \in \mathbb{Z}_{\geq 1}$ and two signatures $\mu, \lambda \in \text{Sign}_k^+$. If $\mu \neq \lambda$, then for any permutation $\sigma \in \mathfrak{S}_k$ we have

$$\oint_{c_1} du_1 \dots \oint_{c_k} du_k \prod_{1 \leq \alpha < \beta \leq k} \left(\frac{u_\alpha - u_\beta}{u_\alpha - qu_\beta} \cdot \frac{u_{\sigma(\alpha)} - qu_{\sigma(\beta)}}{u_{\sigma(\alpha)} - u_{\sigma(\beta)}} \right) \prod_{j=1}^k f_{\mu_j}(u_j) g_{\lambda_{\sigma^{-1}(j)}}(u_j) = 0. \quad (7.1)$$

Proof. This is a straightforward generalization of Lemma 3.5 in [BCPS15a]. Let us outline the steps of the proof.

We will assume that the integral (7.1) is nonzero, and will show that then it must be that $\lambda = \mu$. First, we observe that, by our assumed structure of the poles,

- If it is possible to shrink the contour c_i to P_1 , then for the integral to be nonzero we must have $\mu_i \geq \lambda_{\sigma^{-1}(i)}$.
- If it is possible to shrink the contour c_i to P_2 , then for the integral to be nonzero we must have $\mu_i \leq \lambda_{\sigma^{-1}(i)}$.

Next, using

$$\prod_{1 \leq \alpha < \beta \leq k} \frac{u_\alpha - u_\beta}{u_\alpha - qu_\beta} \cdot \frac{u_{\sigma(\alpha)} - qu_{\sigma(\beta)}}{u_{\sigma(\alpha)} - u_{\sigma(\beta)}} = \text{sgn}(\sigma) \prod_{\alpha < \beta: \sigma(\alpha) > \sigma(\beta)} \frac{u_{\sigma(\alpha)} - qu_{\sigma(\beta)}}{u_\alpha - qu_\beta} \quad (7.2)$$

and the properties of the integration contours, we see that

- If for some $i \in \{1, \dots, k\}$ one has $\sigma(i) > \max(\sigma(1), \dots, \sigma(i-1))$, then the numerator in the left-hand side of (7.2) contains all terms of the form $(u_{\sigma(i)} - qu_{\sigma(i)+1}), (u_{\sigma(i)} - qu_{\sigma(i)+2}), \dots, (u_{\sigma(i)} - qu_k)$, and thus the expression in the right-hand side of (7.2) does not have poles at $u_{\sigma(i)} = qu_j$ for all $j > \sigma(i)$. This means that we can shrink the contour $c_{\sigma(i)}$ to P_1 without picking any residues. This implies that for the integral (7.1) to be nonzero, we must have $\mu_{\sigma(i)} \geq \lambda_i$.
- Similarly, if for some $i \in \{1, \dots, k\}$ one has $\sigma(i) < \min(\sigma(i+1), \dots, \sigma(k))$, then the contour $c_{\sigma(i)}$ can be shrunk to P_2 , and so the integral (7.1) can be nonzero only if $\mu_{\sigma(i)} \leq \lambda_i$.

This completes the argument analogous to Step I of the proof of [BCPS15a, Lemma 3.5]. Further steps of the proof have a purely combinatorial nature and can be repeated without change. We will not reproduce the full combinatorial argument here, but will illustrate it on a concrete example.

Take $\sigma = (3, 2, 4, 5, 1, 8, 6, 7)$, and consider an arrow diagram as in Fig. 22. That is, think of the bottom row as $\lambda_1 \geq \lambda_2 \geq \dots \geq \lambda_8$ and of the top row as $\mu_1 \geq \mu_2 \geq \dots \geq \mu_8$, and draw the corresponding horizontal arrows from larger to smaller integers. Labels in the nodes correspond to the permutation σ itself. As we read this permutation from left to right, we see running maxima $\sigma(1), \sigma(3) > \max(\sigma(1), \sigma(2)), \sigma(4) > \max(\sigma(1), \sigma(2), \sigma(3))$, and $\sigma(6) > \max(\sigma(1), \sigma(2), \sigma(3), \sigma(4), \sigma(5))$, and correspondingly we add (red dashed) arrows $\mu_{\sigma(i)} \rightarrow \lambda_i$. Similarly, reading the permutation from right to left, we see running minima $\sigma(8), \sigma(7) < \sigma(8)$, and $\sigma(5) < \min(\sigma(6), \sigma(7), \sigma(8))$, and we add (blue

¹⁸For the applications below, these sets should be countable. However, since our integrands are rational functions, only finitely many of the points of P_1 or P_2 can serve as singularities of the integrand, and so there are no issues with accumulation points of $P_{1,2}$.

¹⁹Here and below $R\gamma$ denotes the image of the contour γ under the multiplication by the constant R .

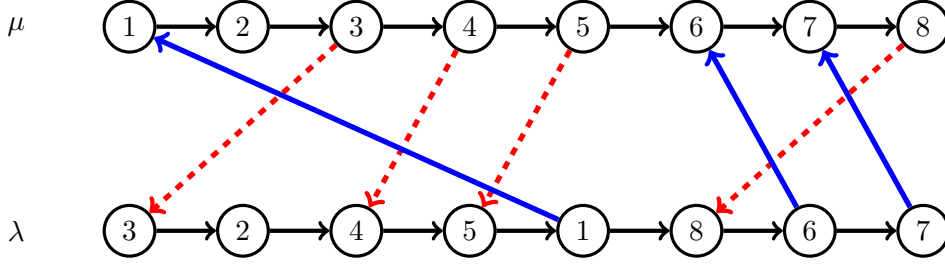
 FIGURE 22. Arrow diagram for $\sigma = (3, 2, 4, 5, 1, 8, 6, 7)$.

solid) arrows $\lambda_i \rightarrow \mu_{\sigma(i)}$. As one examines the arrow diagram, it becomes obvious that for the integral to be nonzero, we must have

$$\lambda_1 = \dots = \lambda_5 = \mu_1 = \dots = \mu_5, \quad \lambda_6 = \lambda_7 = \lambda_8 = \mu_6 = \mu_7 = \mu_8.$$

We also see that any permutation σ yielding a nonzero integral (7.1) splits into two blocks permuting $\{1, 2, 3, 4, 5\}$ and $\{5, 6, 7\}$, which are the clusters of equal parts in λ and μ . A similar clustering occurs in the general situation, too.

This implies that for the integral (7.1) to be nonzero, we must have $\lambda = \mu$, as desired. \square

Before discussing the first of the orthogonality statements, we will introduce some notation and assumptions. For any set $\mathbf{a} = \{a_i\}_{i \in \mathbb{Z}_{\geq 0}}$, denote

$$M_{\mathbf{a}} := \sup_{i \in \mathbb{Z}_{\geq 0}} a_i, \quad m_{\mathbf{a}} := \inf_{i \in \mathbb{Z}_{\geq 0}} a_i. \quad (7.3)$$

Throughout the text, we will use this notation in expressions like $m_{\bar{\Xi}|\mathcal{S}} = \inf_{i \in \mathbb{Z}_{\geq 0}} (\xi_i^{-1} |s_i|)$ (here and below $\bar{\Xi}|\mathcal{S}$ stands for the set of products of elements of $\bar{\Xi}$ and \mathcal{S} with the *same indices*, i.e., we *do not include all possible pairwise products*; and similarly for other sets of products).

For the orthogonality statements below in this subsection we need to make certain assumptions about our parameters. Namely, we assume that q , \mathcal{S} , and Ξ satisfy (5.1), and, moreover,

$$m_{\bar{\Xi}|\mathcal{S}} > qM_{\bar{\Xi}|\mathcal{S}}, \quad m_{\bar{\Xi}|\mathcal{S}} > M_{\bar{\Xi}|\mathcal{S}}, \quad (7.4)$$

which is needed for the existence of the contours in the following definition.

Definition 7.2. Let q , \mathcal{S} , and Ξ satisfy (5.1) and (7.4). For any $k \geq 1$, let $\gamma_1^+[\bar{\Xi}\mathcal{S}], \dots, \gamma_k^+[\bar{\Xi}\mathcal{S}]$ be positively oriented closed contours such that (see Fig. 23)

- Each contour $\gamma_{\alpha}^+[\bar{\Xi}\mathcal{S}]$ encircles all the points of the set $P_1 := \bar{\Xi}\mathcal{S} = \{\xi_i^{-1} s_i\}_{i \in \mathbb{Z}_{\geq 0}}$, while leaving outside all the points of $P_2 := \bar{\Xi}\bar{\mathcal{S}} = \{\xi_i^{-1} s_i^{-1}\}_{i \in \mathbb{Z}_{\geq 0}}$. This is possible because $m_{\bar{\Xi}|\mathcal{S}} > M_{\bar{\Xi}|\mathcal{S}}$.
- For any $\beta > \alpha$, the interior of $\gamma_{\alpha}^+[\bar{\Xi}\mathcal{S}]$ contains the contour $q\gamma_{\beta}^+[\bar{\Xi}\mathcal{S}]$. Note that this is possible because $m_{\bar{\Xi}|\mathcal{S}} > qM_{\bar{\Xi}|\mathcal{S}}$.
- The contour $\gamma_k^+[\bar{\Xi}\mathcal{S}]$ is sufficiently small so that it does not intersect with $q\gamma_k^+[\bar{\Xi}\mathcal{S}]$.

Also, let $\gamma[\bar{\Xi}\mathcal{S}; 0]$ be a positively oriented closed contour encircling all points of $\bar{\Xi}\mathcal{S} \cup q\bar{\Xi}\mathcal{S} \cup \dots \cup q^{k-1}\bar{\Xi}\mathcal{S}$, which also contains $q\gamma[\bar{\Xi}\mathcal{S}; 0]$, and leaves outside the points of $\bar{\Xi}\bar{\mathcal{S}}$. Note that 0 must be inside this contour.

Remark 7.3. The superscript “+” in the contours of Definition 7.2 refers to the property that they are q -nested, as opposed to q^{-1} -nested contours $\gamma_j^-[\bullet]$ which we will consider later in §8. Throughout the text the set of points encircled by a contour is explicitly indicated in the square brackets.

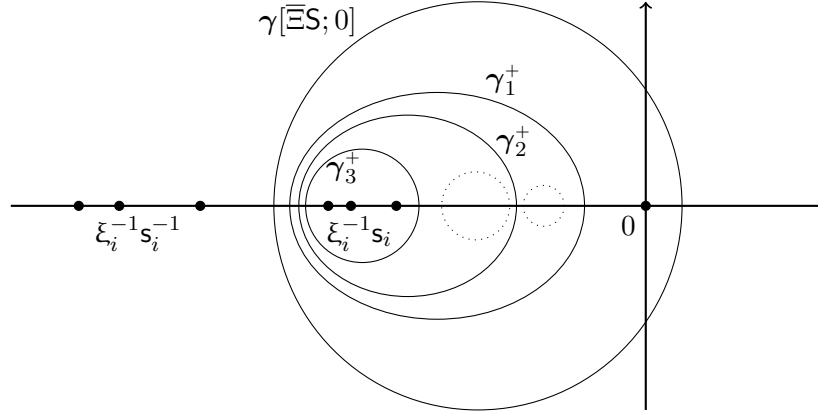

FIGURE 23. A possible choice of nested integration contours $\gamma_i^+ = \gamma_i^+[\Xi S]$, $i = 1, 2, 3$ (Definition 7.2). Contours $q\gamma_3^+[\Xi S]$ and $q^2\gamma_3^+[\Xi S]$ are shown dotted. The large contour $\gamma[\Xi S; 0]$ is also shown.

Theorem 7.4. *Under assumptions (5.1) and (7.4) on q , S , and Ξ , for any $k \in \mathbb{Z}_{\geq 1}$ and $\lambda, \mu \in \text{Sign}_k^+$, we have*

$$(1-q)^{-k} \oint_{\gamma_1^+[\Xi S]} \frac{du_1}{2\pi i} \cdots \oint_{\gamma_k^+[\Xi S]} \frac{du_k}{2\pi i} \prod_{1 \leq \alpha < \beta \leq k} \frac{u_\alpha - u_\beta}{u_\alpha - qu_\beta} F_\lambda^c(u_1, \dots, u_k | \Xi, S) \prod_{i=1}^k u_i^{-1} \varphi_{\mu_i}(u_i^{-1} | \Xi, S) = \mathbf{1}_{\lambda=\mu}, \quad (7.5)$$

where the φ_{μ_i} 's and F_λ are as in §4.5.

An immediate corollary of Theorem 7.4 is the following “spatial” biorthogonality property of the functions F_μ :

Corollary 7.5. *Under assumptions (5.1) and (7.4) on q , S , and Ξ , for any $k \in \mathbb{Z}_{\geq 1}$ and $\lambda, \mu \in \text{Sign}_k^+$, we have*

$$\frac{c_S(\lambda)}{(1-q)^k k!} \oint_{\gamma[\Xi S; 0]} \frac{du_1}{2\pi i u_1} \cdots \oint_{\gamma[\Xi S; 0]} \frac{du_k}{2\pi i u_k} \prod_{\alpha \neq \beta} \frac{u_\alpha - u_\beta}{u_\alpha - qu_\beta} F_\lambda(u_1, \dots, u_k | \Xi, S) F_\mu(u_1^{-1}, \dots, u_k^{-1} | \Xi, S) = \mathbf{1}_{\lambda=\mu}, \quad (7.6)$$

with $c_S(\cdot)$ as in (4.9).

We call this property *spatial biorthogonality* because for, say, fixed λ and varying μ , the right-hand side is the delta function in the *spatial* variables μ . This should be compared to the *spectral biorthogonality* of Theorem 7.7 with delta functions in spectral variables in the right-hand side.

When the parameters $\xi_j \equiv 1$ and $s_j \equiv s$ are homogeneous, Theorem 7.4 and Corollary 7.5 were conjectured in [Pov13] and proved in [BCPS15a, §3]. See also [Bor14, Thm. 7.2].

Proof of Corollary 7.5. Assuming Theorem 7.4, deform the integration contours $\gamma_1^+[\Xi S], \dots, \gamma_k^+[\Xi S]$ (in this order) to $\gamma[\Xi S; 0]$. One readily sees that this does not lead to any additional residues. Next, observe that the integral over all $u_j \in \gamma[\Xi S; 0]$ is invariant under permutations of the u_j 's, and thus one can perform the symmetrization and divide by $k!$. This leads to

$$\mathbf{1}_{\lambda=\mu} = \frac{(1-q)^{-k}}{k!} \oint_{\gamma[\Xi S; 0]} \frac{du_1}{2\pi i u_1} \cdots \oint_{\gamma[\Xi S; 0]} \frac{du_k}{2\pi i u_k} \prod_{1 \leq \alpha \neq \beta \leq k} \frac{u_\alpha - u_\beta}{u_\alpha - qu_\beta} F_\lambda^c(u_1, \dots, u_k | \Xi, S)$$

$$\times \underbrace{\sum_{\sigma \in \mathfrak{S}_k} \prod_{1 \leq \beta < \alpha \leq k} \frac{u_{\sigma(\alpha)} - qu_{\sigma(\beta)}}{u_{\sigma(\alpha)} - u_{\sigma(\beta)}} \prod_{i=1}^k \varphi_{\mu_i}(u_{\sigma(i)}^{-1} | \bar{\Xi}, \mathbf{S})}_{\mathbf{F}_\mu(u_1^{-1}, \dots, u_k^{-1} | \bar{\Xi}, \mathbf{S}) \text{ by (4.23)}}$$

as desired. \square

Proof of Theorem 7.4. Fix k and signatures λ and μ . In order to apply Lemma 7.1, set

$$f_m(u) := \frac{\varphi_m(u^{-1} | \bar{\Xi}, \mathbf{S})}{u} = \frac{\xi_m(1-q)}{\xi_m u - s_m} \prod_{j=0}^{m-1} \frac{1 - s_j \xi_j u}{\xi_j u - s_j}, \quad g_\ell(u) := \varphi_\ell(u | \Xi, \mathbf{S}) = \frac{1-q}{1 - s_\ell \xi_\ell u} \prod_{j=0}^{\ell-1} \frac{\xi_j u - s_j}{1 - s_j \xi_j u},$$

and use the sets P_1, P_2 described in Definition 7.2. If $m > \ell$, then all singularities of

$$f_m(u)g_\ell(u) = \frac{\xi_m(1-q)}{\xi_m u - s_m} \frac{1-q}{1 - s_\ell \xi_\ell u} \prod_{j=0}^{m-1} \frac{1 - s_j \xi_j u}{\xi_j u - s_j} \prod_{j=0}^{\ell-1} \frac{\xi_j u - s_j}{1 - s_j \xi_j u}$$

are in P_1 , and if $m < \ell$, then all singularities of this product are in P_2 . By virtue of the symmetrization formula for \mathbf{F}_λ (4.23), we see that the integrand in (7.5) is (up to a multiplicative constant) the same as the one in Lemma 7.1 (with the above specialization of f_m and g_ℓ). The structure of our integration contours $\gamma_j^+[\bar{\Xi}\mathbf{S}]$ and the fact that $\infty \notin P_1 \cup P_2$ (so the contours can be dragged through infinity without picking the residues) implies that the third condition of Lemma 7.1 is also satisfied. Thus, we conclude that the integral in (7.5) vanishes unless $\mu = \lambda$.

Example. To better illustrate the application of Lemma 7.1 here, consider contours $\gamma_1^+[\bar{\Xi}\mathbf{S}], \gamma_2^+[\bar{\Xi}\mathbf{S}]$, and $\gamma_3^+[\bar{\Xi}\mathbf{S}]$ as in Fig. 23. Depending on σ , the denominator in the integrand in (7.1) contains some of the factors $u_1 - qu_2, u_1 - qu_3$, and $u_2 - qu_3$. The contour $\gamma_3^+[\bar{\Xi}\mathbf{S}]$ can always be shrunk to P_1 without picking residues at $u_3 = q^{-1}u_1$ and $u_3 = q^{-1}u_2$ (this is the assumption on the contours in Lemma 7.1). Moreover, if, for example, the permutation σ provides a cancellation of the factor $u_2 - qu_3$ in the denominator, then the contour $\gamma_2^+[\bar{\Xi}\mathbf{S}]$ can also be shrunk to P_1 without picking the residue at $u_2 = qu_3$. Similarly, the contour $\gamma_1^+[\bar{\Xi}\mathbf{S}]$ can always be expanded (“shrunk” on the Riemann sphere) to P_2 (recall that infinity does not supply any residues), and if the factor $u_1 - qu_2$ in the denominator is canceled for a certain σ , then $\gamma_2^+[\bar{\Xi}\mathbf{S}]$ can also be expanded to P_2 without picking the residue at $u_2 = q^{-1}u_1$.

Now we must consider the case when $\mu = \lambda$, that is, evaluate the “squared norm” of \mathbf{F}_μ . Arguing similarly to the example in the proof of Lemma 7.1 (see [BCPS15a, Lemma 3.5] for more detail), we see that the integral

$$\sum_{\sigma \in \mathfrak{S}_k} \oint_{\gamma_1^+[\bar{\Xi}\mathbf{S}]} \frac{du_1}{2\pi\mathbf{i}} \cdots \oint_{\gamma_k^+[\bar{\Xi}\mathbf{S}]} \frac{du_k}{2\pi\mathbf{i}} \prod_{1 \leq \alpha < \beta \leq k} \left(\frac{u_\alpha - u_\beta}{u_\alpha - qu_\beta} \frac{u_{\sigma(\alpha)} - qu_{\sigma(\beta)}}{u_{\sigma(\alpha)} - u_{\sigma(\beta)}} \right) \times \prod_{i=1}^k u_i^{-1} \varphi_{\lambda_i}(u_i^{-1} | \bar{\Xi}, \mathbf{S}) \varphi_{\lambda_{\sigma^{-1}(i)}}(u_i | \Xi, \mathbf{S}) \quad (7.7)$$

(this is the same as the left-hand side of (7.5) with $\mu = \lambda$, up to the constant $(1-q)^{-k} c_\mathbf{S}(\lambda)$) vanishes unless $\sigma \in \mathfrak{S}_k$ permutes within clusters of the signature λ , that is, σ must preserve each maximal set of indices $\{a, a+1, \dots, b\} \subseteq \{1, \dots, k\}$ for which $\lambda_a = \lambda_{a+1} = \dots = \lambda_b$. Let c_λ be the number of such clusters in λ . Denote the set of all permutations permuting within clusters of λ by $\mathfrak{S}_k^{(\lambda)}$. Any permutation $\sigma \in \mathfrak{S}_k^{(\lambda)}$ can be represented as a product of c_λ permutations $\sigma_1, \dots, \sigma_{c_\lambda}$, with each σ_i fixing all elements of $\{1, \dots, k\}$ except those belonging to the i -th cluster of λ . We will denote the set of indices within the i -th cluster by $C_i(\lambda)$, and write $\sigma_i \in \mathfrak{S}_k^{(\lambda, i)}$.

Therefore, the sum in (7.7) is only over $\sigma \in \mathfrak{S}_k^{(\lambda)}$. Let us now compute it. We have

$$\begin{aligned} & \sum_{\sigma \in \mathfrak{S}_k^{(\lambda)}} \prod_{1 \leq \alpha < \beta \leq k} \frac{u_{\sigma(\alpha)} - qu_{\sigma(\beta)}}{u_{\sigma(\alpha)} - u_{\sigma(\beta)}} \prod_{i=1}^k u_i^{-1} \varphi_{\lambda_i}(u_i^{-1} | \bar{\Xi}, \mathbf{S}) \varphi_{\lambda_{\sigma^{-1}(i)}}(u_i | \Xi, \mathbf{S}) \\ &= \prod_{r=1}^k \frac{\xi_{\lambda_r} (1-q)^2}{(\xi_{\lambda_r} u_r - s_{\lambda_r})(1 - s_{\lambda_r} \xi_{\lambda_r} u_r)} \cdot \prod_{1 \leq i < j \leq c_\lambda} \prod_{\substack{\alpha \in C_i(\lambda) \\ \beta \in C_j(\lambda)}} \frac{u_\alpha - qu_\beta}{u_\alpha - u_\beta} \cdot \prod_{i=1}^{c_\lambda} \sum_{\sigma_i \in \mathfrak{S}_k^{(\lambda, i)}} \prod_{\substack{1 \leq \alpha < \beta \leq k \\ \alpha, \beta \in C_i(\lambda)}} \frac{u_{\sigma_i(\alpha)} - qu_{\sigma_i(\beta)}}{u_{\sigma_i(\alpha)} - u_{\sigma_i(\beta)}}. \end{aligned}$$

For each sum over $\sigma_i \in \mathfrak{S}_k^{(\lambda, i)}$ we can use the symmetrization identity (footnote⁸). Thus, (7.7) becomes

$$\begin{aligned} & \sum_{\sigma \in \mathfrak{S}_k} \oint_{\gamma_1^+[\bar{\Xi}\mathbf{S}]} \frac{du_1}{2\pi\mathbf{i}} \cdots \oint_{\gamma_k^+[\bar{\Xi}\mathbf{S}]} \frac{du_k}{2\pi\mathbf{i}} \prod_{\alpha < \beta} \left(\frac{u_\alpha - u_\beta}{u_\alpha - qu_\beta} \frac{u_{\sigma(\alpha)} - qu_{\sigma(\beta)}}{u_{\sigma(\alpha)} - u_{\sigma(\beta)}} \right) \prod_{i=1}^k u_i^{-1} \varphi_{\lambda_i}(u_i^{-1} | \bar{\Xi}, \mathbf{S}) \varphi_{\lambda_{\sigma^{-1}(i)}}(u_i | \Xi, \mathbf{S}) \\ &= (1-q)^k \prod_{i \geq 0} (q; q)_{\ell_i} \oint_{\gamma_1^+[\bar{\Xi}\mathbf{S}]} \frac{du_1}{2\pi\mathbf{i}} \cdots \oint_{\gamma_k^+[\bar{\Xi}\mathbf{S}]} \frac{du_k}{2\pi\mathbf{i}} \prod_{i=1}^{c_\lambda} \prod_{\substack{1 \leq \alpha < \beta \leq k \\ \alpha, \beta \in C_i(\lambda)}} \frac{u_\alpha - u_\beta}{u_\alpha - qu_\beta} \prod_{r=1}^k \frac{\xi_{\lambda_r}}{(\xi_{\lambda_r} u_r - s_{\lambda_r})(1 - s_{\lambda_r} \xi_{\lambda_r} u_r)}, \end{aligned}$$

where we have used the usual multiplicative notation $\lambda = 0^{\ell_0} 1^{\ell_1} 2^{\ell_2} \dots$. The integration variables above corresponding to each cluster are now independent, and thus the integral reduces to a product of c_λ smaller nested contour integrals of similar form. In each such separate contour integral the inhomogeneity parameters ξ_{λ_r} and s_{λ_r} are the same because the λ_r 's belong to the same cluster. Thus, each of these integrals can be computed as follows (here we denote $\xi = \xi_{\lambda_r}$ and $\mathbf{s} = s_{\lambda_r}$ to shorten the notation):²⁰

$$\begin{aligned} & \oint_{\gamma_1^+[\bar{\Xi}\mathbf{S}]} \frac{du_1}{2\pi\mathbf{i}} \oint_{\gamma_2^+[\bar{\Xi}\mathbf{S}]} \frac{du_2}{2\pi\mathbf{i}} \cdots \oint_{\gamma_\ell^+[\bar{\Xi}\mathbf{S}]} \frac{du_\ell}{2\pi\mathbf{i}} \prod_{1 \leq \alpha < \beta \leq \ell} \frac{u_\alpha - u_\beta}{u_\alpha - qu_\beta} \prod_{i=1}^{\ell} \frac{\xi}{(\xi u_i - \mathbf{s})(1 - \mathbf{s} \xi u_i)} \\ &= \frac{1}{1 - \mathbf{s}^2} \oint_{\gamma_2^+[\bar{\Xi}\mathbf{S}]} \frac{du_2}{2\pi\mathbf{i}} \cdots \oint_{\gamma_\ell^+[\bar{\Xi}\mathbf{S}]} \frac{du_\ell}{2\pi\mathbf{i}} \prod_{j=2}^{\ell} \frac{1 - \mathbf{s} \xi u_j}{1 - q \mathbf{s} \xi u_j} \prod_{2 \leq \alpha < \beta \leq \ell} \frac{u_\alpha - u_\beta}{u_\alpha - qu_\beta} \prod_{i=2}^{\ell} \frac{\xi}{(\xi u_i - \mathbf{s})(1 - \mathbf{s} \xi u_i)} \\ &= \frac{1}{1 - \mathbf{s}^2} \oint_{\gamma_2^+[\bar{\Xi}\mathbf{S}]} \frac{du_2}{2\pi\mathbf{i}} \cdots \oint_{\gamma_\ell^+[\bar{\Xi}\mathbf{S}]} \frac{du_\ell}{2\pi\mathbf{i}} \prod_{2 \leq \alpha < \beta \leq \ell} \frac{u_\alpha - u_\beta}{u_\alpha - qu_\beta} \prod_{i=2}^{\ell} \frac{\xi}{(\xi u_i - \mathbf{s})(1 - q \mathbf{s} \xi u_i)} \\ &= \text{etc.} \\ &= \frac{1}{(\mathbf{s}^2; q)_\ell}. \end{aligned}$$

Indeed, there is only one u_1 -pole outside the contour $\gamma_1^+[\bar{\Xi}\mathbf{S}]$, namely, $u_1 = (\mathbf{s}\xi)^{-1}$. Evaluating the integral over u_1 by taking the minus residue at $u_1 = (\mathbf{s}\xi)^{-1}$ leads to a smaller similar integral with the outside pole $(\mathbf{s}\xi)^{-1}$ replaced by $(q\mathbf{s}\xi)^{-1}$. Continuing in the same way with integration over u_2, \dots, u_ℓ , we obtain $1/(\mathbf{s}^2; q)_\ell$. Putting together all of the above components, we see that we have established the desired claim. \square

7.2. Plancherel isomorphisms and completeness. Here we discuss Plancherel isomorphism results related to the functions F_λ . Similar results were obtained in [BCPS15b], [BCPS15a], and [Bor14] in the homogeneous case $\xi_j \equiv 1$, $\mathbf{s}_j \equiv \mathbf{s}$. Detailed discussion of Plancherel-type results for other integrable interacting particle systems can also be found in the first two of these references.

²⁰In fact, a more general integral of this sort can also be computed, see [BCPS15a, Prop. 3.7].

Let us fix the number of variables $n \in \mathbb{Z}_{\geq 1}$. Let the parameters $\Xi = \{\xi_x\}_{x \in \mathbb{Z}}$ and $\mathbf{S} = \{\mathbf{s}_x\}_{x \in \mathbb{Z}}$ be indexed by all integers, and assume that $\xi_x^{-1} \mathbf{s}_x^{\pm 1}$ for all $x \in \mathbb{Z}$ are pairwise distinct.²¹ We will assume that conditions (5.1) and (7.4) hold for these \mathbb{Z} -indexed families of parameters, which implies that the nested integration contours $\gamma_j^+[\Xi, \mathbf{S}]$ of Definition 7.2 exist.

Extend the definition of the functions $F_\lambda(u_1, \dots, u_n | \Xi, \mathbf{S})$ to all $\lambda \in \text{Sign}_n$ (i.e., with possibly negative parts) using the shifting property (4.26). In other words, define F_λ for all $\lambda \in \text{Sign}_n$ by the same symmetrization formula (4.23), but extend $\varphi_k(u | \Xi, \mathbf{S})$ (4.22) to negative integers as

$$\varphi_{-k}(u | \Xi, \mathbf{S}) = \frac{1-q}{1-\xi_{-k} \mathbf{s}_{-k} u} \prod_{j=-k}^{-1} \frac{1-\xi_j \mathbf{s}_j u}{\xi_j u - \mathbf{s}_j}, \quad k \in \mathbb{Z}_{\geq 1},$$

so that $\{\varphi_k\}_{k \in \mathbb{Z}}$ also satisfy (4.26) with $M = 1$.

Definition 7.6 (Function spaces). Denote the space of functions $f(\lambda)$ on Sign_n with finite support by \mathcal{W}^n . Also, denote by \mathcal{C}^n the space of symmetric rational functions $R(u_1, \dots, u_n)$ which can have poles only at $u_i = \xi_x^{-1} \mathbf{s}_x^{-1}$, $x \in \mathbb{Z}_{\geq 0}$ and $u_i = \xi_x^{-1} \mathbf{s}_x$, $x \in \mathbb{Z}_{< 0}$, $i = 1, \dots, n$, and all the poles are simple. In other words,

$$R(u_1, \dots, u_n) \cdot \prod_{i=1}^n \left(\prod_{x=0}^M (u_i - \xi_x^{-1} \mathbf{s}_x^{-1}) \prod_{x=-M}^{-1} (u_i - \xi_x^{-1} \mathbf{s}_x) \right)$$

is a polynomial in the u_i 's for large enough M . Moreover, we require that the functions from \mathcal{C}^n converge to zero as $|u_i| \rightarrow \infty$ for any i .

Note that as functions in λ , the $F_\lambda(u_1, \dots, u_n | \Xi, \mathbf{S})$'s clearly do not belong to \mathcal{W}^n . However, as functions in the u_i 's, they belong to \mathcal{C}^n . Indeed, to verify the latter statement, use (4.23) and bring all summands to the common denominator. This denominator is a product of factors of the form $u_i - \xi_x \mathbf{s}_x^{\pm 1}$ times the Vandermonde $\prod_{1 \leq \alpha < \beta \leq n} (u_\alpha - u_\beta)$. Observe that the numerator is an antisymmetric polynomial in u_1, \dots, u_n , so it can be divided by the Vandermonde, thus removing it from the denominator. Finally, $F_\lambda(u_1, \dots, u_n | \Xi, \mathbf{S})$ clearly goes to zero as $|u_i| \rightarrow \infty$.

Let us first formulate two main statements (Theorems 7.7 and 7.11) which we prove in this subsection.

Theorem 7.7. *The functions F_λ satisfy the spectral biorthogonality relation²²*

$$\begin{aligned} \sum_{\lambda \in \text{Sign}_n} \oint \dots \oint \frac{d\mathbf{u}}{(2\pi\mathbf{i})^n} \oint \dots \oint \frac{d\mathbf{v}}{(2\pi\mathbf{i})^n} \phi(\mathbf{u}) \psi(\mathbf{v}) F_\lambda(\mathbf{u} | \Xi, \mathbf{S}) F_\lambda^c(\mathbf{v} | \Xi, \mathbf{S}) \prod_{1 \leq \alpha < \beta \leq n} (u_\alpha - u_\beta)(v_\alpha - v_\beta) \\ = (-1)^{\frac{n(n-1)}{2}} \oint \dots \oint \frac{d\mathbf{u}}{(2\pi\mathbf{i})^n} \prod_{1 \leq \alpha, \beta \leq n} (u_\alpha - q u_\beta) \cdot \phi(\mathbf{u}) \sum_{\sigma \in \mathfrak{S}_n} \text{sgn}(\sigma) \psi(\sigma \mathbf{u}), \end{aligned} \quad (7.8)$$

where ϕ and ψ are arbitrary test functions satisfying (see also Remark 7.14 below for a discussion of these conditions)

- The function $\phi(\mathbf{u}) \prod_{\alpha < \beta} (u_\alpha - u_\beta)$ is a rational function in $\{u_i\}$ and all parameters q, Ξ , and \mathbf{S} , which can have at most simple poles at $u_i = \xi_x^{-1} \mathbf{s}_x^{\pm 1}$, $x \in \mathbb{Z}$, $i = 1, \dots, n$, and is regular at infinity, $u_i = \xi_x^{-1} \mathbf{s}_x^{-1}$, $x \geq 0$, and $u_i = \xi_x^{-1} \mathbf{s}_x$, $x < 0$;
- The function $\psi(\mathbf{v}) \prod_{\alpha, \beta} (v_\alpha - q v_\beta)$ is rational in $\{v_j\}$ and all parameters q, Ξ , and \mathbf{S} , and can have at most simple poles at $v_j = \xi_x^{-1} \mathbf{s}_x^{\pm 1}$, $x \in \mathbb{Z}$, $j = 1, \dots, n$,

²¹Most definitions and statements below in this subsection are still valid (with suitable modifications) when some of these points coincide, and follow by a simple limit transition. However, we will not focus on these details.

²² Throughout the text we will use the abbreviated notation $\bar{\mathbf{v}} = (v_1^{-1}, \dots, v_n^{-1})$, and $d\mathbf{v}$ stands for $dv_1 \dots dv_n$. Similarly for $\bar{\mathbf{u}}$ and $d\mathbf{u}$. Also, $\sigma \mathbf{u}$ stands for the permutation σ of the variables \mathbf{u} .

and each integration in (7.8) is performed over one and the same positively oriented closed contour which encircles all of the points $\xi_x^{-1}\mathbf{s}_x$, $x \in \mathbb{Z}$, and leaves all $\xi_x^{-1}\mathbf{s}_x^{-1}$ outside.

Remark 7.8. Informally, the spectral biorthogonality can be written as

$$\prod_{1 \leq \alpha < \beta \leq n} (u_\alpha - u_\beta)(v_\alpha - v_\beta) \sum_{\lambda \in \text{Sign}_n} F_\lambda(\mathbf{u} | \Xi, \mathbf{S}) F_\lambda^c(\bar{\mathbf{v}} | \bar{\Xi}, \mathbf{S}) \\ = (-1)^{\frac{n(n-1)}{2}} \prod_{1 \leq \alpha, \beta \leq n} (u_\alpha - qu_\beta) \cdot \det[\delta(v_i - u_j)]_{i,j=1}^n.$$

This identity should be understood in the integrated sense with suitable test functions as above.

Definition 7.9 (Plancherel transforms). The direct transform \mathcal{F} maps a function f from \mathcal{W}^n to $\mathcal{F}f \in \mathcal{C}^n$ and acts as

$$(\mathcal{F}f)(u_1, \dots, u_n) := \sum_{\lambda \in \text{Sign}_n} f(\lambda) F_\lambda(u_1, \dots, u_n | \Xi, \mathbf{S}).$$

The inverse transform \mathcal{J} takes $R \in \mathcal{C}^n$ to $\mathcal{J}R \in \mathcal{W}^n$ and acts as

$$(\mathcal{J}R)(\lambda) := \frac{c_S(\lambda)}{(1-q)^n} \oint_{\gamma_1^+[\bar{\Xi}\mathbf{S}]} \frac{du_1}{2\pi\mathbf{i}} \cdots \oint_{\gamma_n^+[\bar{\Xi}\mathbf{S}]} \frac{du_n}{2\pi\mathbf{i}} \prod_{1 \leq \alpha < \beta \leq n} \frac{u_\alpha - u_\beta}{u_\alpha - qu_\beta} \frac{R(u_1, \dots, u_n)}{u_1 \cdots u_n} \prod_{i=1}^n \varphi_{\lambda_i}(u_i^{-1} | \bar{\Xi}, \mathbf{S}),$$

where $c_S(\lambda)$ is defined by (4.9). Let us explain why $\mathcal{J}R$ has finite support in λ . If $\lambda_1 \geq M$ for sufficiently large $M > 0$, then the integrand has no poles $\xi_x^{-1}\mathbf{s}_x^{-1}$ outside $\gamma_1^+[\bar{\Xi}\mathbf{S}]$, and thus vanishes. (It is crucial that R vanishes at $u_1 = \infty$, so that the integrand has no residue at $u_1 = \infty$.) Similarly, if $\lambda_n \leq -M$, then there are no u_n -poles $\xi_x^{-1}\mathbf{s}_x$ inside $\gamma_n^+[\bar{\Xi}\mathbf{S}]$, and so the integral also vanishes. Clearly, the bound M depends on the function R .

Remark 7.10. Similarly to [BCPS15a, Proposition 3.2], the nested contours in the inverse Plancherel transform \mathcal{J} can be replaced by two different families of identical contours, which allows to symmetrize under the integral and interpret $\mathcal{J}R$ as a bilinear pairing between R and $F_\lambda^c(u_1^{-1}, \dots, u_n^{-1} | \bar{\Xi}, \mathbf{S})$. One of the choices of these identical contours is $\gamma[\bar{\Xi}\mathbf{S}; 0]$, cf. Corollary 7.5. Another one is the small contour $\gamma_1^+[\bar{\Xi}\mathbf{S}]$ around $\bar{\Xi}\mathbf{S}$, but the formula for \mathcal{J} would then involve string specializations of the u_i 's. We refer to [BCPS15b] and [BCPS15a] for details.

Theorem 7.11 (Plancherel isomorphisms). *The operator $f \mapsto \mathcal{J}(\mathcal{F}f)$ acts as the identity on \mathcal{W}^n . The operator $R \mapsto \mathcal{F}(\mathcal{J}R)$ acts as the identity on \mathcal{C}^n .*

The first statement of this theorem is clearly equivalent to Theorem 7.4 established above (note that by (4.26), identities (7.5) and (7.6) are invariant under simultaneous shifts in λ and μ , and thus also hold for all $\lambda, \mu \in \text{Sign}_n$). The proof of the second statement relies on Theorem 7.7 and is given below in this subsection.

Example ($n = 1$). To illustrate our strategy of the proofs (and relate Theorems 7.7 and 7.11 to the results of §7.1 and the Cauchy identities of §4.4), let us consider the simplest one-variable homogeneous case. For that, let us consider the following variant of the Cauchy identity:

$$\sum_{n=0}^{\infty} \frac{z^n}{w^{n+1}} = \frac{1}{w-z}, \quad \left| \frac{z}{w} \right| < 1.$$

By shifting the summation index towards $-\infty$, we can write

$$\sum_{n=-M}^{\infty} \frac{z^n}{w^{n+1}} = \frac{w^M}{z^M} \frac{1}{w-z}, \quad \left| \frac{z}{w} \right| < 1.$$

Now take contour integrals in z and w (over positively oriented circles with $|z| < |w|$) of both sides of this relation multiplied by $P(z)Q(w)$, where P and Q are Laurent polynomials. Then in the left-hand side we obtain the same sum for any $M \gg 1$, and in the right-hand side the w contour can be shrunk to zero, thus picking the residue at $w = z$. Therefore, we have an analogue of Theorem 7.7:

$$\sum_{n=-\infty}^{\infty} \oint \oint \frac{z^n}{w^{n+1}} P(z)Q(w) \frac{dz}{2\pi i} \frac{dw}{2\pi i} = \oint P(z)Q(z) \frac{dz}{2\pi i}.$$

The convergence condition $|z| < |w|$ is irrelevant for the left-hand side because the sum over n now contains only finitely many terms. The resulting spectral biorthogonality can be informally written as

$$\sum_{n=-\infty}^{\infty} \frac{z^n}{w^{n+1}} = \delta(w - z),$$

cf. Remark 7.8.

To get the other biorthogonality relation, integrate both sides of the above identity against $w^m \frac{dw}{2\pi i}$, $m \in \mathbb{Z}$. Since $\{z^n\}_{n \in \mathbb{Z}}$ are linearly independent, we obtain

$$\oint_{|w|=\text{const}} w^m \frac{1}{w^{n+1}} \frac{dw}{2\pi i} = \mathbf{1}_{m=n}.$$

This is the spatial biorthogonality relation (an analogue of Theorem 7.4 and Corollary 7.5). This identity also readily follows from the Cauchy's integral formula.

Similar considerations work for Cauchy identities in several variables. The second type of biorthogonality relations can often be verified independently in a simpler fashion (as in the proof of Theorem 7.4).

Proof of Theorem 7.7. The proof is similar to the one given in [Bor14], with suitable modifications required in the inhomogeneous case. The starting point is the Cauchy identity of Corollary 4.13 written for parameters $\tau_{-M}\Xi, \tau_{-M}\mathbf{S}$, where $M > 0$ is a large integer:

$$\frac{\prod_{i=1}^n (1 - s_{-M} \xi_{-M} u_i)}{(q; q)_n} \sum_{\mu \in \text{Sign}_+^n} \mathbf{F}_\mu(\mathbf{u} | \tau_{-M}\Xi, \tau_{-M}\mathbf{S}) \mathbf{G}_\mu^c(\bar{\mathbf{v}} | \tau_{-M}\Xi, \tau_{-M}\mathbf{S}) = \prod_{i=1}^n \prod_{j=1}^n \frac{v_j - q u_i}{v_j - u_i}. \quad (7.10)$$

Recall that the convergence of this sum requires $(u_i, v_j^{-1}) \in \text{Adm}_{\Xi, \mathbf{S}}$ for all i, j (Definition 4.9), and so we must explain how to achieve these conditions on deformations $C_{\mathbf{u}} \ni u_i$ and $C_{\bar{\mathbf{v}}} \ni v_j$ of our original integration contour in (7.8). First, observe that due to the restrictions (7.9) on $\phi(\mathbf{u})$, the sum over λ in (7.8) is finite for fixed test functions (the argument is similar to the part of Definition 7.9 explaining why the support in λ is finite). Thus, (7.8) is an identity of rational functions in the parameters q, Ξ, \mathbf{S} , and it is enough to verify it on an open subset of the space of parameters.²³

We will deform the contours to achieve the following inequalities which imply admissibility:

$$\left| \frac{u_i - \xi_x^{-1} \mathbf{s}_x}{u_i - \xi_x^{-1} \mathbf{s}_x^{-1}} \right| < r, \quad \left| \frac{v_j - \xi_x^{-1} \mathbf{s}_x^{-1}}{v_j - \xi_x^{-1} \mathbf{s}_x} \right| < R, \quad \text{for some } R > 1, 0 < r < 1, \text{ with } rR < 1, \text{ and all } x. \quad (7.11)$$

That is, the points u_i have to be closer to $\xi_x^{-1} \mathbf{s}_x$ than to $\xi_x^{-1} \mathbf{s}_x^{-1}$, and the opposite for the v_j 's. Consider the discs

$$B_x^{(r)} := \{z \in \mathbb{C} : |z - \xi_x^{-1} \mathbf{s}_x| < r |z - \xi_x^{-1} \mathbf{s}_x^{-1}|\},$$

²³Note that a deformation of contours passing through a singularity of the integrand may change the rational function represented by the contour integral. Thus, verifying an identity of rational functions involving contour integrals on an open subset in the space of parameters allows to then analytically continue this identity as long as the contour integrals represent the same rational functions. We will employ this understanding throughout the text.

and note that each u_i must be inside $\bigcap_{x \in \mathbb{Z}} B_x^{(r)}$, while each v_j must be outside $\bigcup_{x \in \mathbb{Z}} B_x^{(1/R)}$. Thus, for the deformed contours $C_{\mathbf{u}}$ and $C_{\mathbf{v}}$ to exist, it must be that $\bigcap_{x \in \mathbb{Z}} B_x^{(r)}$ is nonempty and contains all $\xi_x^{-1} s_x$, while $\bigcup_{x \in \mathbb{Z}} B_x^{(1/R)}$ must not contain any of the points $\xi_x^{-1} s_x^{-1}$. Moreover, the deformation of the contour in (7.8) to $C_{\mathbf{v}}$ must not cross the possible singularities at $v_\alpha = q^{\pm 1} v_\beta$, cf. (7.9). The latter conditions can be ensured by requiring that $q \in (0, \delta)$ for a sufficiently small $\delta > 0$.

Assume that the other parameters are restricted for all x as follows (with a, b, c, d to be determined):

$$\xi_x \in (a, b), \quad 0 < a < b < \infty; \quad s_x \in (-d, -c), \quad 0 < c < d < 1. \quad (7.12)$$

The diameter of each $B_x^{(r)}$ (i.e., $B_x^{(r)} \cap \mathbb{R}$) is

$$\left(\frac{r + s_x^2}{(r+1)s_x \xi_x}, \frac{r - s_x^2}{(r-1)s_x \xi_x} \right),$$

and similarly for $B_x^{(1/R)}$. Under (7.12) we can estimate for $r > d^2$ and $1 < R < d^{-2}$:

$$\frac{1/R + d^2}{-ac(1+1/R)} < \frac{1/R + s_x^2}{(1/R+1)s_x \xi_x}, \quad \frac{r + s_x^2}{(r+1)s_x \xi_x} < \frac{r + c^2}{-bd(1+r)}, \quad \frac{r - d^2}{-bd(r-1)} < \frac{r - s_x^2}{(r-1)s_x \xi_x},$$

and $-d/a < \xi_x^{-1} s_x < -c/b$, $\xi_x^{-1} s_x^{-1} < -1/(bd)$.

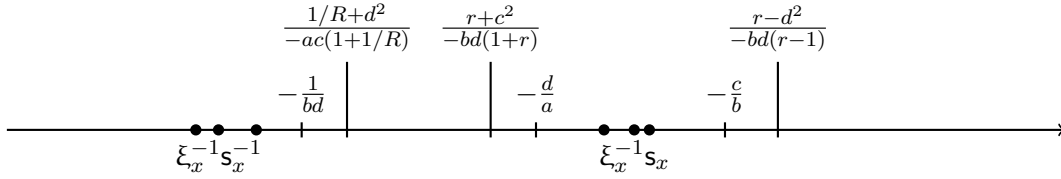

FIGURE 24. Inequalities (7.13) guarantee this configuration of points, and thus the existence of the integration contours $C_{\mathbf{u}}$ and $C_{\mathbf{v}}$.

The existence of the contours $C_{\mathbf{u}}$ and $C_{\mathbf{v}}$ is thus implied by the following inequalities (see Fig. 24):

$$-\frac{1}{bd} < \frac{1/R + d^2}{-ac(1+1/R)} < \frac{r + c^2}{-bd(1+r)} < -\frac{d}{a} < -\frac{c}{b} < \frac{r - d^2}{-bd(r-1)}. \quad (7.13)$$

One can check that these inequalities hold for, e.g.,

$$a = \frac{5}{6}, \quad b = 1, \quad c = \frac{1}{6}, \quad d = \frac{1}{4}, \quad 1 < R < 16, \quad \frac{1}{16} < r < R^{-1}. \quad (7.14)$$

Thus, for sufficiently small q and for other parameters satisfying (7.12) and (7.14), there exist deformations of contours in (7.8) to $C_{\mathbf{u}}$ and $C_{\mathbf{v}}$ not changing the integral, such that on the deformed contours one has $(u_i, v_j^{-1}) \in \text{Adm}_{\Xi, \mathcal{S}}$, and so (7.10) holds.

Let us now rewrite the left-hand side of (7.10) using (4.27) as follows:

$$\begin{aligned} & \frac{\prod_{i=1}^n (1 - s_{-M} \xi_{-M} u_i)}{(q; q)_n} \sum_{\lambda \in \text{Sign}_n^+ : \lambda_n = 0} F_\lambda(\mathbf{u} | \tau_{-M} \Xi, \tau_{-M} \mathcal{S}) G_\lambda^c(\bar{\mathbf{v}} | \tau_{-M} \bar{\Xi}, \tau_{-M} \mathcal{S}) \\ & + \prod_{i=1}^n \frac{1 - s_{-M} \xi_{-M} u_i}{1 - s_{-M} \xi_{-M} v_i} \sum_{\lambda \in \text{Sign}_n^+ : \lambda_n \geq 1} F_\lambda(\mathbf{u} | \tau_{-M} \Xi, \tau_{-M} \mathcal{S}) F_\lambda^c(\bar{\mathbf{v}} | \tau_{-M} \bar{\Xi}, \tau_{-M} \mathcal{S}). \end{aligned} \quad (7.15)$$

Multiply (7.15) by

$$\prod_{i=1}^n \prod_{j=-M}^{-1} \frac{1 - \xi_j s_j u_i}{\xi_j u_i - s_j} \frac{\xi_j v_i - s_j}{1 - \xi_j s_j v_i} \prod_{1 \leq \alpha < \beta \leq n} (u_\alpha - u_\beta)(v_\alpha - v_\beta) \cdot \phi(u_1, \dots, u_n) \psi(v_1, \dots, v_n), \quad (7.16)$$

where ϕ and ψ are test functions as in (7.9). We will integrate (7.15) multiplied by (7.16) over the contours $C_{\mathbf{u}}$ and $C_{\mathbf{v}}$ described above, and observe the following:

1. The first summand in (7.15) multiplied by (7.16) vanishes after the integration for large enough M . Indeed, each summand coming from $\prod_{i=1}^n (1 - \mathbf{s}_{-M} \xi_{-M} u_i) F_{\lambda}(\mathbf{u} | \tau_{-M} \Xi, \tau_{-M} \mathbf{S})$ with $\lambda_n = 0$ is regular outside $C_{\mathbf{u}}$, because there are no poles at $\xi_x^{-1} \mathbf{s}_x^{-1}$ for $x \in \mathbb{Z}$.

2. In the second summand we write, using (4.26) and shifting the summation index:

$$\begin{aligned} \prod_{i=1}^n \prod_{j=-M}^{-1} \frac{1 - \xi_j \mathbf{s}_j u_i}{\xi_j u_i - \mathbf{s}_j} \frac{\xi_j v_i - \mathbf{s}_j}{1 - \xi_j \mathbf{s}_j v_i} \sum_{\lambda \in \text{Sign}_n^+ : \lambda_n \geq 1} F_{\lambda}(\mathbf{u} | \tau_{-M} \Xi, \tau_{-M} \mathbf{S}) F_{\lambda}^c(\bar{\mathbf{v}} | \tau_{-M} \bar{\Xi}, \tau_{-M} \mathbf{S}) \\ = \sum_{\lambda \in \text{Sign}_n : \lambda_n \geq -M+1} F_{\lambda}(\mathbf{u} | \Xi, \mathbf{S}) F_{\lambda}^c(\bar{\mathbf{v}} | \bar{\Xi}, \mathbf{S}). \end{aligned}$$

Therefore, as $M \rightarrow +\infty$, we obtain the sum over all $\lambda \in \text{Sign}_n$. Since with our test functions the above sum over λ is actually finite, this limit procedure is a stabilization.

3. Consider the integral of the right-hand side of (7.10) multiplied by (7.16), and compute it by evaluating the residues in the \mathbf{v} -integration variables. Because $C_{\mathbf{u}}$ is inside $C_{\mathbf{v}}$, for large enough M the integrand has no v_i -poles inside $C_{\mathbf{v}}$ except $v_i = u_{\sigma(i)}$ for some permutation $\sigma \in \mathfrak{S}_n$. Indeed, the same u_j cannot be utilized twice because of the prefactor $\prod_{\alpha < \beta} (v_{\alpha} - v_{\beta})$. The sum over all $\sigma \in \mathfrak{S}_n$ yields the desired right-hand side of (7.8).

We have thus established (7.8) for small q and other parameters Ξ and \mathbf{S} satisfying (7.12) and (7.14), and with integration contours $C_{\mathbf{u}}$ and $C_{\mathbf{v}}$. However, since the sum in the left-hand side of (7.8) is finite, we can deform the contours back to one and the same contour as described in the claim. Next, since both sides of (7.8) are rational functions in q , Ξ , and \mathbf{S} , we can analytically continue this identity to the full range of parameters. This completes the proof. \square

Proof of Theorem 7.11. Let us show how the second statement follows from the spectral biorthogonality of Theorem 7.7. To prove $\mathcal{F}(\mathcal{J}R) = R$, rewrite the integration in $\mathcal{J}R$ using the contours $\gamma[\bar{\Xi}\mathbf{S}; 0]$ (cf. Remark 7.10). Thus, we must show that

$$R(\mathbf{u}) = \sum_{\lambda \in \text{Sign}_n} F_{\lambda}(\mathbf{u} | \Xi, \mathbf{S}) \frac{1}{(1-q)^n n!} \oint_{(\gamma[\bar{\Xi}\mathbf{S}; 0])^n} \dots \oint \frac{d\mathbf{v}}{2\pi\mathbf{i}} \prod_{i=1}^n v_i^{-1} \prod_{1 \leq \alpha \neq \beta \leq n} \frac{v_{\alpha} - v_{\beta}}{v_{\alpha} - qv_{\beta}} R(\mathbf{v}) F_{\lambda}^c(\bar{\mathbf{v}} | \bar{\Xi}, \mathbf{S}).$$

It suffices to establish the following integrated version of the above identity (we have interchanged summation and integration in \mathbf{u} because of the finitely many nonzero terms in the sum):

$$\begin{aligned} \oint_{(\gamma[\bar{\Xi}\mathbf{S}; 0])^n} \dots \oint R(\mathbf{u}) Q(\mathbf{u}) \frac{d\mathbf{u}}{(2\pi\mathbf{i})^n} &= \sum_{\lambda \in \text{Sign}_n} \frac{1}{n!} \oint_{(\gamma[\bar{\Xi}\mathbf{S}; 0])^n} \dots \oint \frac{d\mathbf{u}}{(2\pi\mathbf{i})^n} \oint_{(\gamma[\bar{\Xi}\mathbf{S}; 0])^n} \dots \oint \frac{d\mathbf{v}}{(2\pi\mathbf{i})^n} \\ &\times \prod_{1 \leq \alpha \neq \beta \leq n} (v_{\alpha} - v_{\beta}) \prod_{1 \leq \alpha, \beta \leq n} \frac{1}{v_{\alpha} - qv_{\beta}} F_{\lambda}(\mathbf{u} | \Xi, \mathbf{S}) F_{\lambda}^c(\bar{\mathbf{v}} | \bar{\Xi}, \mathbf{S}) R(\mathbf{v}) Q(\mathbf{u}). \end{aligned}$$

Indeed, consider the partial fraction expansion $R(\mathbf{u}) = \sum_{j,p} r_{j,p} (u_j - p)^{-1}$, where $j = 1, \dots, n$, and p runs over a subset of possible poles described in Definition 7.6. To extract a single $r_{j,p}$, choose $Q(\mathbf{u}) = \prod_{\tilde{p}} (u_j - \tilde{p}) \prod_{i \neq j} (u_i - \xi_x^{-1} \mathbf{s}_x)^{-1}$, where \tilde{p} runs over all other u_j -poles of $R(\mathbf{u})$, and $x \in \mathbb{Z}_{\geq 0}$ is arbitrary. The factors $(u_i - \xi_x^{-1} \mathbf{s}_x)^{-1}$ are needed to ensure that the integrals over all other u_i 's are nontrivial. Thus, it suffices to let $Q(\mathbf{u})$ be an arbitrary (not necessarily symmetric) rational function with possibly simple poles at $\xi_x^{-1} \mathbf{s}_x$, $x \geq 0$.

Apply the spectral biorthogonality (7.8) with functions (which clearly satisfy (7.9)):

$$\phi(\mathbf{u}) = Q(\mathbf{u}) \prod_{1 \leq \alpha < \beta \leq n} \frac{1}{u_\alpha - u_\beta} \quad \text{and} \quad \psi(\mathbf{v}) = R(\mathbf{v}) \prod_{1 \leq \beta < \alpha \leq n} (v_\alpha - v_\beta) \prod_{1 \leq \alpha, \beta \leq n} \frac{1}{v_\alpha - qv_\beta}$$

to rewrite the above sum as

$$\frac{1}{n!} \oint \dots \oint_{(\gamma[\overline{\Xi}\mathbf{S}; 0])^n} \frac{d\mathbf{u}}{(2\pi\mathbf{i})^n} Q(\mathbf{u}) \sum_{\sigma \in \mathfrak{S}_k} \text{sgn}(\sigma) R(\sigma\mathbf{u}) \prod_{1 \leq \alpha < \beta \leq n} \frac{u_{\sigma(\alpha)} - u_{\sigma(\beta)}}{u_\alpha - u_\beta}.$$

The cancellation in the last product yields another $\text{sgn}(\sigma)$, and so we see that the desired identity is established. This concludes the proof of the theorem. \square

We conclude this subsection with a number of remarks.

Remark 7.12 (Completeness of the Bethe ansatz). Plancherel isomorphism results (Theorem 7.11) imply that the (coordinate) Bethe ansatz yielding the eigenfunctions F_λ of the transfer matrices is *complete*. That is, any function $f \in \mathcal{W}^n$ can be mapped into the spectral space, and then reconstructed back from its image. One of the ways to write down this completeness statement (using the orthogonality relation (7.6)) is the following:

$$f(\lambda) = \frac{1}{(1-q)^n n!} \oint_{\gamma[\overline{\Xi}\mathbf{S}; 0]} \frac{du_1}{2\pi\mathbf{i}u_1} \dots \oint_{\gamma[\overline{\Xi}\mathbf{S}; 0]} \frac{du_n}{2\pi\mathbf{i}u_n} \prod_{1 \leq \alpha \neq \beta \leq n} \frac{u_\alpha - u_\beta}{u_\alpha - qu_\beta} \times (\mathcal{F}f)(u_1, \dots, u_n) F_\lambda^c(u_1^{-1}, \dots, u_n^{-1} | \overline{\Xi}, \mathbf{S}).$$

Remark 7.13 (Spectral decomposition of $\mathcal{Q}_{0^m, v}^\circ$). Similarly, (7.6) implies a spectral decomposition of the operator $\mathcal{Q}_{0^m, v}^\circ$ acting on functions on Sign_m^+ , cf. Remark 6.6:

$$\mathcal{Q}_{0^m, v}^\circ(\mu \rightarrow \nu) = \frac{1}{(1-q)^m m!} \frac{(-\mathbf{S})^\nu}{(-\mathbf{S})^\mu} \oint_{\gamma[\overline{\Xi}\mathbf{S}; 0]} \frac{dz_1}{2\pi\mathbf{i}z_1} \dots \oint_{\gamma[\overline{\Xi}\mathbf{S}; 0]} \frac{dz_m}{2\pi\mathbf{i}z_m} \prod_{1 \leq \alpha \neq \beta \leq m} \frac{z_\alpha - z_\beta}{z_\alpha - qz_\beta} \times \left(\prod_{i=1}^m \frac{1 - qz_i v}{1 - z_i v} \right) F_\mu(z_1, \dots, z_m | \Xi, \mathbf{S}) F_\nu^c(z_1^{-1}, \dots, z_m^{-1} | \overline{\Xi}, \mathbf{S}). \quad (7.17)$$

Indeed, by (6.12) this operator has eigenfunctions $\Psi_\lambda(z_1, \dots, z_m) = F_\lambda(z_1, \dots, z_m | \Xi, \mathbf{S}) / (-\mathbf{S})^\lambda$ with eigenvalues $\prod_{i=1}^m \frac{1 - qz_i v}{1 - z_i v}$ (the constant $(q; q)_m$ can be ignored). Thus, (7.17) follows by multiplying the eigenrelation (6.12) by $(-\mathbf{S})^\nu F_\nu^c(z_1^{-1}, \dots, z_m^{-1} | \overline{\Xi}, \mathbf{S})$ and integrating as in (7.6). Since the identity (6.12) requires the admissibility $(z_i, v) \in \text{Adm}_{\Xi, \mathbf{S}}$ (Definition 4.9) before the integration, in (7.17) the point v^{-1} should be outside the integration contour $\gamma[\overline{\Xi}\mathbf{S}; 0]$ (the argument for this is similar to the proof of Proposition 7.15 below).

Remark 7.14 (Extensions). Function spaces \mathcal{W}^n and \mathcal{C}^n , as well as test functions in Theorem 7.7, are far from being optimal. This is because we only address algebraic aspects of Plancherel isomorphisms.

The concrete form of restrictions on the functions $\varphi(\mathbf{u})$ and $\psi(\mathbf{v})$ in Theorem 7.7 is motivated by the application of this theorem in the proof of Theorem 7.11. However, as can be seen from the proof, these restrictions can be relaxed. For example, for $\psi(\mathbf{v})$ it is enough that there exists an open subset Ω in the space of parameters q, Ξ , and \mathbf{S} , such that for the parameters in Ω the function $\psi(\mathbf{v})$ is holomorphic in the interior of the deformed contour $C_\mathbf{v}$ (constructed in the proof of Theorem 7.7) minus the points $\xi_x^{-1} \mathbf{s}_x$ where $\psi(\mathbf{v})$ can have at most finitely many simple poles.

An extension of the first Plancherel isomorphism to larger spaces is described in [CP15, Appendix A] in the homogeneous case; the inhomogeneous situation is completely analogous.

7.3. An integral representation for \mathbf{G}_μ . Using the orthogonality result of Theorem 7.4 and the Cauchy identity, we can obtain relatively simple nested contour integral formulas for the skew functions $\mathbf{G}_{\mu/\kappa}$ (and, in particular, for \mathbf{G}_μ), which will be useful later in §8 and §9.

Proposition 7.15. *Assume that the parameters q, \mathbf{S} , and Ξ satisfy (5.1) and (7.4). For any $k, N \in \mathbb{Z}_{\geq 1}$, $\mu, \kappa \in \mathbf{Sign}_k^+$, and v_1, \dots, v_N such that the v_i^{-1} 's are outside of all the integration contours $\gamma_j^+[\Xi\mathbf{S}]$ of Definition 7.2, we have*

$$\begin{aligned} \mathbf{G}_{\mu/\kappa}(v_1, \dots, v_N | \Xi, \mathbf{S}) &= \frac{1}{(1-q)^k} \oint_{\gamma_1^+[\Xi\mathbf{S}]} \frac{du_1}{2\pi\mathbf{i}} \cdots \oint_{\gamma_k^+[\Xi\mathbf{S}]} \frac{du_k}{2\pi\mathbf{i}} \prod_{1 \leq \alpha < \beta \leq k} \frac{u_\alpha - u_\beta}{u_\alpha - qu_\beta} \\ &\quad \times \mathbf{F}_\kappa^c(u_1, \dots, u_k | \Xi, \mathbf{S}) \prod_{i=1}^k u_i^{-1} \varphi_{\mu_i}(u_i^{-1} | \Xi, \mathbf{S}) \prod_{\substack{1 \leq i \leq k \\ 1 \leq j \leq N}} \frac{1 - qu_i v_j}{1 - u_i v_j}. \end{aligned} \quad (7.18)$$

When $\kappa = (0^k)$, with the help of (4.20), formula (7.18) reduces to

Corollary 7.16. *Under the same assumptions as in Proposition 7.15 above, we have*

$$\begin{aligned} \mathbf{G}_\mu(v_1, \dots, v_N | \Xi, \mathbf{S}) &= \frac{(s_0^2; q)_k}{(1-q)^k} \oint_{\gamma_1^+[\Xi\mathbf{S}]} \frac{du_1}{2\pi\mathbf{i}} \cdots \oint_{\gamma_k^+[\Xi\mathbf{S}]} \frac{du_k}{2\pi\mathbf{i}} \prod_{1 \leq \alpha < \beta \leq k} \frac{u_\alpha - u_\beta}{u_\alpha - qu_\beta} \\ &\quad \times \prod_{i=1}^k \frac{u_i^{-1} \varphi_{\mu_i}(u_i^{-1} | \Xi, \mathbf{S})}{1 - s_0 \xi_0 u_i} \prod_{\substack{1 \leq i \leq k \\ 1 \leq j \leq N}} \frac{1 - qu_i v_j}{1 - u_i v_j}. \end{aligned} \quad (7.19)$$

When the parameters ξ_j and s_j are j -independent, formula (7.19) appeared in [Bor14, Prop. 7.3].

Proof of Proposition 7.15. Fix $\mu, \kappa \in \mathbf{Sign}_k^+$, multiply both sides of (7.5) by $\mathbf{G}_{\lambda/\kappa}(v_1, \dots, v_N | \Xi, \mathbf{S})$, and sum over $\lambda \in \mathbf{Sign}_k^+$. The right-hand side obviously equals $\mathbf{G}_{\mu/\kappa}(v_1, \dots, v_N | \Xi, \mathbf{S})$, while in the left-hand side we have

$$\begin{aligned} (1-q)^{-k} \sum_{\lambda \in \mathbf{Sign}_k^+} \oint_{\gamma_1^+[\Xi\mathbf{S}]} \frac{du_1}{2\pi\mathbf{i}} \cdots \oint_{\gamma_k^+[\Xi\mathbf{S}]} \frac{du_k}{2\pi\mathbf{i}} \prod_{1 \leq \alpha < \beta \leq k} \frac{u_\alpha - u_\beta}{u_\alpha - qu_\beta} \\ \times \prod_{i=1}^k \frac{\varphi_{\mu_i}(u_i^{-1} | \Xi, \mathbf{S})}{u_i} \mathbf{F}_\lambda^c(u_1, \dots, u_k | \Xi, \mathbf{S}) \mathbf{G}_{\lambda/\kappa}(v_1, \dots, v_N | \Xi, \mathbf{S}). \end{aligned}$$

If one can perform the (infinite) summation over λ inside the integral, then by the (iterated) Corollary 4.11.1 (which follows from the Cauchy identity), one readily gets the desired formula for the symmetric function $\mathbf{G}_{\mu/\kappa}(v_1, \dots, v_N | \Xi, \mathbf{S})$. It remains to justify that we indeed can interchange summation and integration.

The (absolutely convergent) summation can be performed inside the integral if $(u_i, v_j) \in \mathbf{Adm}_{\Xi, \mathbf{S}}$ for u_i on the contours. The admissibility follows if

$$\left| \frac{\xi_x u_i - s_x}{1 - s_x \xi_x u_i} \cdot \frac{\xi_x^{-1} v_j - s_x}{1 - s_x \xi_x^{-1} v_j} \right| = \left| \frac{u_i - \xi_x^{-1} s_x}{u_i - \xi_x^{-1} s_x^{-1}} \cdot \frac{v_j^{-1} - \xi_x^{-1} s_x^{-1}}{v_j^{-1} - \xi_x^{-1} s_x} \right| < 1 - \epsilon \quad \text{for some } \epsilon > 0 \text{ and all } x.$$

Therefore, it would be sufficient if u_i is closer to $\xi_x^{-1} s_x$ than to $\xi_x^{-1} s_x^{-1}$ for all x , and, on the other hand, v_j^{-1} is closer to $\xi_x^{-1} s_x^{-1}$ than to $\xi_x^{-1} s_x$. Since the u -contours encircle the points $\xi_x^{-1} s_x$, we can readily

achieve the above inequality in the case when for each x , the midpoint $\frac{1}{2}\xi_x^{-1}(\mathfrak{s}_x + \mathfrak{s}_x^{-1})$ of $\xi_x^{-1}\mathfrak{s}_x^{\pm 1}$ lies to the left of the leftmost point $m_{\Xi\mathfrak{S}}$ of $\xi_x^{-1}\mathfrak{s}_x$. A sufficient condition for that is

$$\frac{1}{2}(m_{\Xi|\mathfrak{S}|} + m_{\Xi|\bar{\mathfrak{S}}|}) > M_{\Xi|\mathfrak{S}|}, \quad (7.20)$$

which is more restrictive than the second condition in (7.4) because clearly $m_{\Xi|\mathfrak{S}|} < m_{\Xi|\bar{\mathfrak{S}}|}$.

If this more restrictive condition holds, we can slightly deform the contours $\gamma_i^+[\Xi\mathfrak{S}]$ if needed, and choose the v_j^{-1} 's outside these contours with real part being negative and sufficiently large in absolute value. This ensures the admissibility, and so we can perform the summation inside the integral and establish the desired identity (7.18).

Let Ω be the set of parameters $(\{v_j\}, \Xi, \mathfrak{S})$ such that (7.20) holds and the real parts of the v_j^{-1} 's are sufficiently negative. This set is clearly nonempty and open, and, moreover, for fixed μ and κ both sides of (7.18) are represented by rational functions which depend only on finitely many of the ξ_x 's and \mathfrak{s}_x 's. Thus, we can employ analytic continuation of rational functions (cf. footnote²³) and continue identity (7.18) from Ω to a larger set of variables and parameters as in the claim of the present proposition. Indeed, the restrictions on parameters in the claim of the proposition ensure that the integration contours $\gamma_i^+[\Xi\mathfrak{S}]$ exist, and also that the points v_j^{-1} are outside these contours. Thus, for these parameters the right-hand side of (7.18) represents the same rational function as on Ω . \square

7.4. Another proof of symmetrization formula for G_μ . The nested contour integral formula for G_μ of Corollary 7.16 may be used as an alternative way to derive the symmetrization formula for G_μ of Theorem 4.14. Note that Corollary 7.16 in turn follows from the Cauchy identity plus the spatial orthogonality of the F_λ 's, and the latter is implied by the symmetrization formula for F_λ .

Remark 7.17. Another use of formula (7.19) is a straightforward alternative proof of Proposition 6.7 (computation of the specialization $G_\mu(\varrho | \Xi, \mathfrak{S})$), which can also be generalized to other specializations of G_μ . This will be a starting point for averaging of observables in §8.2 below.

To get the symmetrization formula for G_μ , we follow the approach of [Bor14, Prop. 7.3] and explicitly compute the integral in the right-hand side of (7.19). To ensure that this formula holds, we assume (5.1) and (7.4), and that $v_1, \dots, v_N \in \mathbb{C}$ are pairwise distinct and are such that the points v_i^{-1} lie outside the integration contours $\gamma_j^+[\Xi\mathfrak{S}]$ of Definition 7.2. Observe the following properties of the integrand in (7.19):

- The integrand is regular at $u_j = \infty$ and $u_j = 0$.
- If $\mu_i > 0$, then the integrand is regular at $u_i = \xi_j^{-1}\mathfrak{s}_j^{-1}$ for all $j \geq 0$ because then

$$\frac{\varphi_{\mu_i}(u_i^{-1} | \Xi, \mathfrak{S})}{1 - \mathfrak{s}_0 \xi_0 u_i} = \frac{1 - q}{1 - \mathfrak{s}_{\mu_i} u_i^{-1} / \xi_{\mu_i}} \frac{1}{\xi_0 u_i - \mathfrak{s}_0} \prod_{j=1}^{\mu_i-1} \frac{u_i^{-1} / \xi_j - \mathfrak{s}_j}{1 - \mathfrak{s}_j u_i^{-1} / \xi_j}.$$

- If $\mu_i = 0$, then the integrand is regular at $u_i = \xi_j^{-1}\mathfrak{s}_j^{-1}$ for all $j \geq 1$, because then

$$\frac{\varphi_{\mu_i}(u_i^{-1} | \Xi, \mathfrak{S})}{1 - \mathfrak{s}_0 \xi_0 u_i} = \frac{1 - q}{(1 - \mathfrak{s}_0 u_i^{-1} / \xi_0)(1 - \mathfrak{s}_0 \xi_0 u_i)}.$$

We will now evaluate the integral in (7.19) as follows. Assume that $\mu \in \mathbf{Sign}_k^+$ has exactly ℓ zeros: $\mu_k = \mu_{k-1} = \dots = \mu_{k-\ell+1} = 0$, $\mu_{k-\ell} \geq 1$. This allows to take the residues at $u_k = s/a_0$, $u_{k-1} = qs/a_0$, \dots , $u_{k-\ell+1} = q^{\ell-1}s/a_0$, (in this order), because for each variable $u_k, \dots, u_{k-\ell+1}$ the corresponding point is the only pole inside the integration contour. Rewriting (7.19) as

$$G_\mu(v_1, \dots, v_N | \Xi, \mathfrak{S}) = \frac{(s_0^2; q)_k}{(1 - q)^{k-\ell}} \oint_{\gamma_1^+[\Xi\mathfrak{S}]} \frac{du_1}{2\pi i} \cdots \oint_{\gamma_k^+[\Xi\mathfrak{S}]} \frac{du_k}{2\pi i} \prod_{1 \leq \alpha < \beta \leq k} \frac{u_\alpha - u_\beta}{u_\alpha - qu_\beta} \prod_{\substack{1 \leq i \leq k \\ 1 \leq j \leq N}} \frac{1 - qu_i v_j}{1 - u_i v_j}$$

$$\times \prod_{i=1}^{k-\ell} \frac{u_i^{-1} \varphi_{\mu_i}(u_i^{-1} | \bar{\Xi}, \mathbf{S})}{1 - s_0 \xi_0 u_i} \prod_{i=k-\ell+1}^k \frac{1}{(u_i - s_0/\xi_0)(1 - s_0 \xi_0 u_i)},$$

we consecutively obtain:

$$\begin{aligned} & \text{Res}_{u_k=s_0/\xi_0} \left(\frac{1}{(u_k - s_0/\xi_0)(1 - s_0 \xi_0 u_k)} \prod_{i=1}^{k-1} \frac{u_i - u_k}{u_i - q u_k} \prod_{j=1}^N \frac{1 - q u_k v_j}{1 - u_k v_j} \right) \\ &= \frac{1}{1 - s_0^2} \prod_{i=1}^{k-1} \frac{u_i - s_0/\xi_0}{u_i - q s_0/\xi_0} \prod_{j=1}^N \frac{1 - q s_0 v_j/\xi_0}{1 - s_0 v_j/\xi_0}, \\ & \text{Res}_{u_{k-1}=q s_0/\xi_0} \left(\frac{1}{(u_{k-1} - q s_0/\xi_0)(1 - s_0 \xi_0 u_{k-1})} \prod_{i=1}^{k-2} \frac{u_i - u_{k-1}}{u_i - q u_{k-1}} \prod_{j=1}^N \frac{1 - q u_{k-1} v_j}{1 - u_{k-1} v_j} \right) \\ &= \frac{1}{1 - q s_0^2} \prod_{i=1}^{k-2} \frac{u_i - q s_0/\xi_0}{u_i - q^2 s_0/\xi_0} \prod_{j=1}^N \frac{1 - q^2 s_0 v_j/\xi_0}{1 - q s_0 v_j/\xi_0}, \quad \text{etc.}, \end{aligned}$$

and thus the integral for $\mathbf{G}_\mu(v_1, \dots, v_N | \bar{\Xi}, \mathbf{S})$ takes the form

$$\begin{aligned} \mathbf{G}_\mu(v_1, \dots, v_N | \bar{\Xi}, \mathbf{S}) &= \frac{(q^\ell s_0^2; q)_{k-\ell}}{(1-q)^{k-\ell}} \prod_{j=1}^N \frac{1 - q^\ell s_0 v_j/\xi_0}{1 - s_0 v_j/\xi_0} \oint_{\gamma_1^+(\bar{\Xi}, \mathbf{S})} \frac{du_1}{2\pi i} \cdots \oint_{\gamma_{k-\ell}^+(\bar{\Xi}, \mathbf{S})} \frac{du_{k-\ell}}{2\pi i} \prod_{1 \leq \alpha < \beta \leq k-\ell} \frac{u_\alpha - u_\beta}{u_\alpha - q u_\beta} \\ &\times \prod_{\substack{1 \leq i \leq k-\ell \\ 1 \leq j \leq N}} \frac{1 - q u_i v_j}{1 - u_i v_j} \prod_{i=1}^{k-\ell} \left(\frac{u_i - s_0/\xi_0}{u_i - q^\ell s_0/\xi_0} \frac{u_i^{-1} \varphi_{\mu_i}(u_i^{-1} | \bar{\Xi}, \mathbf{S})}{1 - s_0 \xi_0 u_i} \right). \end{aligned}$$

Now the integral over $u_1, \dots, u_{k-\ell}$ has no poles outside the integration contours except $u_i = v_j^{-1}$ for some j . Thus, the integral can be evaluated by taking minus residues at these points. The same v_j^{-1} cannot be used twice because of the product $\prod_{1 \leq \alpha < \beta \leq k-\ell} (u_\alpha - u_\beta)$ in the numerator. Therefore, all possible ways to choose the residues at v_j^{-1} are encoded by injective maps $\sigma: \{1, \dots, k-\ell\} \rightarrow \{1, \dots, N\}$, and we would need to sum over them. We thus have

$$\begin{aligned} \mathbf{G}_\mu(v_1, \dots, v_N | \bar{\Xi}, \mathbf{S}) &= (q^\ell s_0^2; q)_{k-\ell} \prod_{j=1}^N \frac{1 - s_0 q^\ell v_j/\xi_0}{1 - s_0 v_j/\xi_0} \sum_{\sigma: \{1, \dots, k-\ell\} \rightarrow \{1, \dots, N\}} \prod_{1 \leq \alpha < \beta \leq k-\ell} \frac{v_{\sigma(\beta)} - v_{\sigma(\alpha)}}{v_{\sigma(\beta)} - q v_{\sigma(\alpha)}} \\ &\times \prod_{\substack{1 \leq i \leq k-\ell \\ 1 \leq j \leq N \\ j \neq \sigma(i)}} \frac{v_{\sigma(i)} - q v_j}{v_{\sigma(i)} - v_j} \prod_{i=1}^{k-\ell} \left(\frac{1 - s_0 v_{\sigma(i)}/\xi_0}{1 - s_0 q^\ell v_{\sigma(i)}/\xi_0} \frac{\varphi_{\mu_i}(v_{\sigma(i)} | \bar{\Xi}, \mathbf{S})}{1 - s_0 \xi_0/v_{\sigma(i)}} \right). \end{aligned}$$

Letting \mathcal{I} denote the range of the map σ , we can rewrite the above formula as

$$\begin{aligned} \mathbf{G}_\mu(v_1, \dots, v_N | \bar{\Xi}, \mathbf{S}) &= (q^\ell s_0^2; q)_{k-\ell} \sum_{\mathcal{I} \subseteq \{1, \dots, N\}} \prod_{j \notin \mathcal{I}} \frac{1 - s_0 q^\ell v_j/\xi_0}{1 - s_0 v_j/\xi_0} \prod_{\substack{i \in \mathcal{I} \\ j \notin \mathcal{I}}} \frac{v_i - q v_j}{v_i - v_j} \\ &\times \sum_{\substack{\sigma: \{1, \dots, k-\ell\} \rightarrow \mathcal{I} \\ \text{bijection}}} \prod_{1 \leq \alpha < \beta \leq k-\ell} \frac{v_{\sigma(\alpha)} - q v_{\sigma(\beta)}}{v_{\sigma(\alpha)} - v_{\sigma(\beta)}} \prod_{i=1}^{k-\ell} \frac{\varphi_{\mu_i}(v_{\sigma(i)} | \bar{\Xi}, \mathbf{S})}{1 - s_0 \xi_0/v_{\sigma(i)}}. \end{aligned}$$

If one symmetrizes the above expression over $\{v_j\}_{j \notin \mathcal{I}}$, then the result will match formula (4.24) for $G_\mu(v_1, \dots, v_N | \bar{\Xi}, \mathbf{S})$.

This completes the derivation of the expression for $G_\mu(v_1, \dots, v_N | \bar{\Xi}, \mathbf{S})$ in Theorem 4.14 for all (generic) v_1, \dots, v_N , Ξ , \mathbf{S} , and q , because both sides of that formula are a priori rational functions in all these parameters.

8. q -CORRELATION FUNCTIONS

In this section we compute q -correlation functions of the stochastic dynamics $\mathcal{X}_{\{u_t\}; \boldsymbol{\rho}}^+$ of §6.4 assuming it starts from the empty initial configuration.

8.1. Computing observables via the Cauchy identity. Let us first briefly explain main ideas behind our computations. We are interested only in single-time observables (i.e., the ones which depend on the state of $\mathcal{X}_{\{u_t\}; \boldsymbol{\rho}}^+$ at a single time moment, say, $t = n$), and getting them is equivalent to computing expectations $\mathbb{E}_{\mathbf{u}; \boldsymbol{\rho}} f(\nu)$ of certain functions $f(\nu)$ of the configuration $\nu \in \text{Sign}_n^+$ with respect to the probability measure

$$\begin{aligned} \mathcal{M}_{\mathbf{u}; \boldsymbol{\rho}}(\nu | \Xi, \mathbf{S}) &= \frac{1}{Z(\mathbf{u}; \boldsymbol{\rho} | \Xi, \mathbf{S})} F_\nu(u_1, \dots, u_n | \Xi, \mathbf{S}) G_\nu^c(\boldsymbol{\rho} | \bar{\Xi}, \mathbf{S}) \\ &= \mathbf{1}_{\nu_n \geq 1} \cdot (-\tau_1 \mathbf{S})^{\nu-1^n} \cdot F_{\nu-1^n}^c(u_1, \dots, u_n | \tau_1 \Xi, \tau_1 \mathbf{S}), \end{aligned} \quad (8.1)$$

where $\mathbf{u} = (u_1, \dots, u_n)$, and we use notation (4.25) and (5.9). The measure $\mathcal{M}_{\mathbf{u}; \mathbf{v}}$ (6.1) takes the above form for $\mathbf{v} = \boldsymbol{\rho}$ due to (6.16).

The weights (8.1) are nonnegative if the parameters satisfy (5.1)–(5.2). To ensure that (8.1) defines a probability distribution on the infinite set Sign_n^+ , we need to impose admissibility conditions (cf. Definition 6.1). The latter are implied by

$$\left| s_i \frac{\xi_i u_j - s_i}{1 - s_i \xi_i u_j} \right| < 1 - \epsilon \quad \text{for some } \epsilon > 0 \text{ and all } i \in \mathbb{Z}_{\geq 0} \text{ and } j = 1, \dots, n. \quad (8.2)$$

Indeed, these conditions ensure (4.16) for very small v (limit $v \rightarrow 0$ is a part of the specialization $\boldsymbol{\rho}$). Alternatively, interpret the probability weight $(-\tau_1 \mathbf{S})^{\nu-1^n} \cdot F_{\nu-1^n}^c(u_1, \dots, u_n | \tau_1 \Xi, \tau_1 \mathbf{S})$ in (8.1) as a partition function of path collections, and fix ν with large ν_1 (other parts can be large, too). The only vertex weight which enters the weight of a particular path collection a large number of times is $L_{\xi_x u_j, s_x}(0, 1; 0, 1) = (-s_x \xi_x u_j + s_x^2)/(1 - s_x \xi_x u_j)$, which is bounded in absolute value by (8.2). One readily sees that conditions (5.1)–(5.2) (which, in particular, require $u_i \geq 0$) automatically imply (8.2).

Cauchy identity (4.21) suggests a large family of observables of the measure $\mathcal{M}_{\mathbf{u}; \boldsymbol{\rho}}$ whose averages can be computed right away. Namely, let us fix variables w_1, \dots, w_k , and set

$$f(\nu) := \frac{G_\nu(\boldsymbol{\rho}, w_1, \dots, w_k | \bar{\Xi}, \mathbf{S})}{G_\nu(\boldsymbol{\rho} | \bar{\Xi}, \mathbf{S})}, \quad (8.3)$$

where $(\boldsymbol{\rho}, w_1, \dots, w_k)$ means that we add w_1, \dots, w_k to the specialization $(\epsilon, q\epsilon, \dots, q^{J-1}\epsilon)$, then set $q^J = \xi_0/(s_0\epsilon)$, and finally send $\epsilon \rightarrow 0$, cf. (6.14). Note that one can replace both G_ν in (8.3) by G_ν^c without changing $f(\nu)$. The $\mathbb{E}_{\mathbf{u}; \boldsymbol{\rho}}$ expectation of the function (8.3) takes the form

$$\begin{aligned} \mathbb{E}_{\mathbf{u}; \boldsymbol{\rho}} f(\nu) &= \sum_{\nu \in \text{Sign}_n^+} \frac{1}{Z(\mathbf{u}; \boldsymbol{\rho} | \Xi, \mathbf{S})} F_\nu(u_1, \dots, u_n | \Xi, \mathbf{S}) G_\nu^c(\boldsymbol{\rho} | \bar{\Xi}, \mathbf{S}) \frac{G_\nu^c(\boldsymbol{\rho}, w_1, \dots, w_k | \bar{\Xi}, \mathbf{S})}{G_\nu^c(\boldsymbol{\rho} | \bar{\Xi}, \mathbf{S})} \\ &= \frac{Z(\mathbf{u}; \boldsymbol{\rho}, w_1, \dots, w_k | \Xi, \mathbf{S})}{Z(\mathbf{u}; \boldsymbol{\rho} | \Xi, \mathbf{S})} = \prod_{\substack{1 \leq i \leq n \\ 1 \leq j \leq k}} \frac{1 - qu_i w_j}{1 - u_i w_j}, \end{aligned} \quad (8.4)$$

where the ratio of the partition functions $Z(\dots)$ is computed via the corresponding $\boldsymbol{\rho}$ limit of (6.2). We will discuss admissibility conditions (necessary for the convergence of the above sum) in §8.4 below.

One now needs to understand the dependence of (8.3) on ν . Using the integral formula (7.19) for G_ν , we can compute for $k = 1$:

$$\frac{G_\nu(\boldsymbol{\varrho}, w | \bar{\Xi}, \mathbf{S})}{G_\nu(\boldsymbol{\varrho} | \bar{\Xi}, \mathbf{S})} = q^n + \sum_{i=1}^n \frac{q^{i-1}}{(-S)^{\nu_i}} \frac{1 - s_0 \xi_0^{-1} w}{1 - s_0^{-1} \xi_0^{-1} w} \varphi_{\nu_i}(w | \bar{\Xi}, \mathbf{S}), \quad \nu_n \geq 1 \quad (8.5)$$

(here and below in this section we are using notation similar to (5.9), so $(-S)^{\nu_i} = \prod_{j=0}^{\nu_i-1} s_j$). A general result of this sort is given in Proposition 8.2 below.

Next, by a suitable contour integration in w one can extract the term in (8.5) with $\nu_i = m$ for any fixed $m \geq 1$. Therefore, the same integration of the right-hand side of (8.4) will yield a contour integral formula for

$$\mathbb{E}_{\mathbf{u}; \boldsymbol{\varrho}} \sum_{i=1}^n q^i \mathbf{1}_{\nu_i=m},$$

which can be viewed as a q -analogue of the density function of the random configuration ν . Higher q -correlation functions (defined in §8.4 below) can be computed in a similar way by working with (8.3) with general k . Therefore, for general k the right-hand side of (8.4) should be regarded as a generating function (in w_1, \dots, w_k) for the q -correlation functions, and the latter can be extracted by integrating over the w_j 's.

8.2. Computation of $G_\nu(\boldsymbol{\varrho}, w_1, \dots, w_k | \bar{\Xi}, \mathbf{S})$. In this subsection we fix $n \geq k \geq 0$ and a signature $\nu \in \text{Sign}_n^+$, and compute the specialization $G_\nu(\boldsymbol{\varrho}, w_1, \dots, w_k | \bar{\Xi}, \mathbf{S})$. The result of this computation is a general k version of (8.5), and it is given in Proposition 8.2 below.

For the computation we will assume that w_p , $p = 1, \dots, k$, are pairwise distinct and are such that the points w_p^{-1} are outside the integration contours $\gamma_j^+[\bar{\Xi}\mathbf{S}]$ of Definition 7.2. Assume in addition that the parameters q , \mathbf{S} , and $\bar{\Xi}$ satisfy (5.1) and (7.4), so the integral formula (7.19) holds. Thus, we can readily take the $\boldsymbol{\varrho}$ limit (6.14) in (7.19), and write

$$\begin{aligned} G_\nu(\boldsymbol{\varrho}, w_1, \dots, w_k | \bar{\Xi}, \mathbf{S}) &= \frac{(s_0^2; q)_n}{(1-q)^n} \oint_{\gamma_1^+[\bar{\Xi}\mathbf{S}]} \frac{du_1}{2\pi i} \cdots \oint_{\gamma_n^+[\bar{\Xi}\mathbf{S}]} \frac{du_n}{2\pi i} \prod_{1 \leq \alpha < \beta \leq n} \frac{u_\alpha - u_\beta}{u_\alpha - q u_\beta} \\ &\quad \times \prod_{i=1}^n \left(\frac{u_i^{-1} (1 - s_0^{-1} \xi_0 u_i) \varphi_{\nu_i}(u_i^{-1} | \bar{\Xi}, \mathbf{S})}{1 - s_0 \xi_0 u_i} \prod_{j=1}^k \frac{1 - q u_i w_j}{1 - u_i w_j} \right). \end{aligned} \quad (8.6)$$

We have

$$\frac{u_i^{-1} (1 - \xi_0 s_0^{-1} u_i) \varphi_{\nu_i}(u_i^{-1} | \bar{\Xi}, \mathbf{S})}{1 - s_0 \xi_0 u_i} = (-s_0)^{-1} \frac{1-q}{u_i - s_{\nu_i} \xi_{\nu_i}^{-1}} \frac{\xi_0 u_i - s_0}{1 - s_0 \xi_0 u_i} \prod_{j=0}^{\nu_i-1} \frac{1 - s_j \xi_j u_i}{\xi_j u_i - s_j}.$$

If $\nu_n = 0$, then the integral (8.6) vanishes because there are no u_n -poles inside $\gamma_n^+[\bar{\Xi}\mathbf{S}]$. We will thus assume that $\nu_n \geq 1$ (so all $\nu_i \geq 1$), and explicitly compute this integral. Denote it by $\text{Int}_{1, \dots, n}^{w_1, \dots, w_k}$.

We aim to peel off the contours $\gamma_1^+[\bar{\Xi}\mathbf{S}], \dots, \gamma_n^+[\bar{\Xi}\mathbf{S}]$ (in this order), and take minus residues at poles outside these contours. Observe that the integrand in u_1 has only two types of simple poles outside $\gamma_1^+[\bar{\Xi}\mathbf{S}]$, namely, $u_1 = \infty$ and $u_1 = w_p^{-1}$ for $p = 1, \dots, k$ (there are no singularities at $s_j^{-1} \xi_j^{-1}$). We have

$$- \text{Res}_{u_1=\infty} \left((-s_0)^{-1} \frac{1-q}{u_1 - s_{\nu_1} \xi_{\nu_1}^{-1}} \prod_{j=1}^{\nu_1-1} \frac{1 - s_j \xi_j u_1}{\xi_j u_1 - s_j} \right) = (1-q)(-s_0)^{-2} (-S)^{\nu_1}.$$

Thus, the whole minus residue of (8.6) at $u_1 = \infty$ is equal to $(1 - s_0^2 q^{n-1})(-s_0)^{-2} (-S)^{\nu_1} q^k \cdot \text{Int}_{2, \dots, n}^{w_1, \dots, w_k}$, where q^k comes from the product involving the w_p 's.

Next, for any $p = 1, \dots, k$, the pole w_p^{-1} yields

$$\begin{aligned} - \operatorname{Res}_{u_1=w_p^{-1}} &= (1 - s_0^2 q^{n-1})(-s_0)^{-2} \frac{1 - s_0 \xi_0^{-1} w_p}{1 - s_0^{-1} \xi_0^{-1} w_p} \underbrace{\frac{1 - q}{1 - s_{\nu_1} \xi_{\nu_1}^{-1} w_p} \prod_{j=0}^{\nu_1-1} \frac{\xi_j^{-1} w_p - s_j}{1 - s_j \xi_j^{-1} w_p}}_{\varphi_{\nu_1}(w_p | \bar{\Xi}, S)} \prod_{\substack{1 \leq j \leq k \\ j \neq p}} \frac{w_p - q w_j}{w_p - w_j} \\ &\quad \times \frac{(s_0^2; q)_{n-1}}{(1 - q)^{n-1}} \oint_{\gamma_2^+[\bar{\Xi}S]} \frac{du_2}{2\pi i} \cdots \oint_{\gamma_n^+[\bar{\Xi}S]} \frac{du_n}{2\pi i} \prod_{2 \leq \alpha < \beta \leq n} \frac{u_\alpha - u_\beta}{u_\alpha - q u_\beta} \\ &\quad \times \prod_{i=2}^n \left((-s_0)^{-1} \frac{1 - q}{u_i - s_{\nu_i} \xi_{\nu_i}^{-1}} \prod_{j=1}^{\nu_i-1} \frac{1 - s_j \xi_j u_i}{\xi_j u_i - s_j} \prod_{\substack{1 \leq j \leq k \\ j \neq p}} \frac{1 - q u_i w_j}{1 - u_i w_j} \right). \end{aligned}$$

Therefore, taking the minus residue at $u_1 = w_p^{-1}$ leads to

$$(1 - s_0^2 q^{n-1})(-s_0)^{-2} \frac{1 - s_0 \xi_0^{-1} w_p}{1 - s_0^{-1} \xi_0^{-1} w_p} \varphi_{\nu_1}(w_p | \bar{\Xi}, S) \prod_{\substack{1 \leq j \leq k \\ j \neq p}} \frac{w_p - q w_j}{w_p - w_j} \cdot \operatorname{Int}_{2, \dots, n}^{w_1, \dots, w_{p-1}, w_{p+1}, \dots, w_k}.$$

One can continue with similar computations for $\gamma_2^+[\bar{\Xi}S], \dots, \gamma_n^+[\bar{\Xi}S]$. Let us write down the final integral with the only remaining contour $\gamma_n^+[\bar{\Xi}S]$:

$$\begin{aligned} \operatorname{Int}_n^{w_1, \dots, w_k} &= \frac{1 - s_0^2}{1 - q} \oint_{\gamma_n^+[\bar{\Xi}S]} \frac{du_n}{2\pi i} (-s_0)^{-1} \frac{1 - q}{u_n - s_{\nu_n} \xi_{\nu_n}^{-1}} \prod_{j=1}^{\nu_n-1} \frac{1 - s_j \xi_j u_n}{\xi_j u_n - s_j} \prod_{j=1}^k \frac{1 - q u_n w_j}{1 - u_n w_j} \\ &= (1 - s_0^2)(-s_0)^{-2} q^k (-S)^{\nu_n} + (1 - s_0^2)(-s_0)^{-2} \sum_{p=1}^k \frac{1 - s_0 \xi_0^{-1} w_p}{1 - s_0^{-1} \xi_0^{-1} w_p} \varphi_{\nu_n}(w_p | \bar{\Xi}, S) \prod_{\substack{1 \leq j \leq k \\ j \neq p}} \frac{w_p - q w_j}{w_p - w_j}. \end{aligned}$$

In general, the integral in (8.6) is equal to a summation of the following sort. For every $\ell = 0, \dots, k$, choose two collections of indices $\mathcal{I} = \{i_1 < \dots < i_\ell\} \subseteq \{1, \dots, n\}$ and $\mathcal{J} = \{j_1, \dots, j_\ell\} \subseteq \{1, \dots, k\}$ (note that the order of the j_p 's in \mathcal{J} matters, while the i_p 's are assumed already ordered). We will take residues at $u_{i_p} = w_{j_p}^{-1}$, $1 \leq p \leq \ell$, and the remaining residues at $u_i = \infty$ for $i \notin \mathcal{I}$. Denote the summand corresponding to these residues by $\operatorname{Res}_{\mathcal{I}, \mathcal{J}}$. All these summands have a common prefactor $(-s_0)^{-2n} (s_0^2; q)_n$. The contribution to $\operatorname{Res}_{\mathcal{I}, \mathcal{J}}$ from residues at infinity is equal to

$$\begin{aligned} q^{k(i_1-1)+(k-1)(i_2-i_1-1)+\dots+(k-\ell+1)(i_\ell-i_{\ell-1}-1)+(k-\ell)(n-i_\ell)} \prod_{i \notin \mathcal{I}} (-S)^{\nu_i} \\ = q^{-\frac{1}{2}\ell(2k+1-\ell)+n(k-\ell)} q^{i_1+\dots+i_\ell} \prod_{i \notin \mathcal{I}} (-S)^{\nu_i}. \end{aligned} \quad (8.7)$$

The residues at $u_{i_p} = w_{j_p}^{-1}$ contribute

$$\prod_{p=1}^{\ell} \left(\frac{1 - s_0 \xi_0^{-1} w_{j_p}}{1 - s_0^{-1} \xi_0^{-1} w_{j_p}} \varphi_{\nu_{i_p}}(w_{j_p} | \bar{\Xi}, S) \prod_{j \in \{1, \dots, k\} \setminus \mathcal{J}} \frac{w_{j_p} - q w_j}{w_{j_p} - w_j} \right) \prod_{1 \leq \alpha < \beta \leq \ell} \frac{w_{j_\alpha} - q w_{j_\beta}}{w_{j_\alpha} - w_{j_\beta}}. \quad (8.8)$$

We see that (8.7) depends only on the choice of \mathcal{I} , while (8.8) depends on both \mathcal{I} and \mathcal{J} . Thus, for a fixed \mathcal{I} , one can first sum $\operatorname{Res}_{\mathcal{I}, \mathcal{J}}$ over all subsets $\mathcal{J} = \{j_1 < \dots < j_\ell\} \subseteq \{1, \dots, k\}$, and, for a fixed such \mathcal{J} , over all its permutations. This summation over \mathcal{J} is performed using the following lemma:

Lemma 8.1. *Let $f_i(\zeta)$ be arbitrary functions in $\zeta \in \mathbb{C}$. For any $m \geq 1$ and $\ell \leq m$, we have*

$$\begin{aligned} & \sum_{\sigma \in \mathfrak{S}_m} \sigma \left(\prod_{i=1}^{\ell} f_i(\zeta_i) \prod_{1 \leq \alpha < \beta \leq m} \frac{\zeta_\alpha - q\zeta_\beta}{\zeta_\alpha - \zeta_\beta} \right) \\ &= \frac{(q; q)_{m-\ell}}{(1-q)^{m-\ell}} \sum_{\mathcal{J}=\{j_1 < \dots < j_\ell\} \subseteq \{1, \dots, m\}} \left(\prod_{\substack{j \in \mathcal{J} \\ r \notin \mathcal{J}}} \frac{\zeta_j - q\zeta_r}{\zeta_j - \zeta_r} \sum_{\sigma' \in \mathfrak{S}_\ell} \prod_{i=1}^{\ell} f_i(\zeta_{j_{\sigma'(i)}}) \prod_{1 \leq \alpha < \beta \leq \ell} \frac{\zeta_{j_{\sigma'(\alpha)}} - q\zeta_{j_{\sigma'(\beta)}}}{\zeta_{j_{\sigma'(\alpha)}} - \zeta_{j_{\sigma'(\beta)}}} \right), \end{aligned}$$

where the permutation σ in the left-hand side acts on the variables ζ_j .

Proof. For each $\sigma \in \mathfrak{S}_m$, let \mathcal{J} be the ordered list of elements of the set $\{\sigma(1), \dots, \sigma(\ell)\}$. The left-hand side of the desired claim contains

$$\begin{aligned} & \prod_{i=1}^{\ell} f_i(\zeta_{\sigma(i)}) \prod_{1 \leq \alpha < \beta \leq m} \frac{\zeta_{\sigma(\alpha)} - q\zeta_{\sigma(\beta)}}{\zeta_{\sigma(\alpha)} - \zeta_{\sigma(\beta)}} \\ &= \prod_{i=1}^{\ell} f_i(\zeta_{j_i}) \prod_{1 \leq \alpha < \beta \leq \ell} \frac{\zeta_{j_\alpha} - q\zeta_{j_\beta}}{\zeta_{j_\alpha} - \zeta_{j_\beta}} \underbrace{\prod_{\substack{j \in \mathcal{J} \\ r \notin \mathcal{J}}} \frac{\zeta_j - q\zeta_r}{\zeta_j - \zeta_r}}_{\text{symmetric in } \mathcal{J} \text{ and } \mathcal{J}^c} \prod_{\ell+1 \leq \alpha < \beta \leq m} \frac{\zeta_{\sigma(\alpha)} - q\zeta_{\sigma(\beta)}}{\zeta_{\sigma(\alpha)} - \zeta_{\sigma(\beta)}}. \end{aligned}$$

Symmetrizing over $\sigma \in \mathfrak{S}_m$ can be done in two steps: first, choose a subset \mathcal{J} of $\{1, \dots, m\}$ of size ℓ , and then symmetrize over indices inside and outside \mathcal{J} . For the symmetrization outside \mathcal{J} we can use the symmetrization identity of footnote⁸. This yields the result. \square

Applying this lemma to (8.8) with $m = k$, we arrive at the following formula for our specialization, which is the first step towards q -correlation functions:

Proposition 8.2. *For $n \geq k \geq 0$ and $\nu \in \text{Sign}_n^+$, we have*

$$\begin{aligned} & G_\nu(\boldsymbol{q}, w_1, \dots, w_k \mid \overline{\Xi}, \mathbb{S}) \\ &= \underbrace{\mathbf{1}_{\nu_n \geq 1} (-\mathbb{S})^\nu \frac{(s_0^2; q)_n}{s_0^{2n}}}_{G_\nu(\boldsymbol{q} \mid \overline{\Xi}, \mathbb{S})} \sum_{\ell=0}^k \frac{q^{-\frac{1}{2}\ell(2k+1-\ell)+n(k-\ell)} (1-q)^{k-\ell}}{(q; q)_{k-\ell}} \sum_{\mathcal{I}=\{i_1 < \dots < i_\ell\} \subseteq \{1, \dots, n\}} q^{i_1 + \dots + i_\ell} \prod_{i \in \mathcal{I}} \frac{1}{(-\mathbb{S})^{\nu_i}} \\ & \quad \times \sum_{\sigma \in \mathfrak{S}_k} \sigma \left(\prod_{1 \leq \alpha < \beta \leq k} \frac{w_\alpha - qw_\beta}{w_\alpha - w_\beta} \prod_{p=1}^{\ell} \frac{1 - s_0 \xi_0^{-1} w_p}{1 - s_0^{-1} \xi_0^{-1} w_p} \varphi_{\nu_{i_p}}(w_p \mid \overline{\Xi}, \mathbb{S}) \right), \quad (8.9) \end{aligned}$$

where the permutation σ acts on w_1, \dots, w_k .

Proof. Identity (8.9) is established above in this subsection under certain restrictions on the w_p 's and the parameters q , \mathbb{S} , and $\overline{\Xi}$. Observe that both sides of the identity (8.9) are a priori rational functions in all variables and parameters (and for fixed ν the number of parameters is finite). This is clear for the right-hand side, and the left-hand side of (8.9) is also rational because using the branching rule of Proposition 4.6 one can separate the specialization \boldsymbol{q} and the variables w_p (skew \mathbb{G} -functions in the w_j 's are rational by the very definition), and then evaluate the specialization \boldsymbol{q} by Proposition 6.7. Thus, we can drop any restrictions, and so (8.9) holds for generic values of the variables and parameters. \square

Note that in the particular case $k = 0$ the above proposition reduces to Proposition 6.7.

8.3. **Extracting terms by integrating over w_i .** Observe now that when $k = \ell$, the summation over σ in (8.9) above produces $(-s_0)^k F_{(\nu_{i_1-1}, \dots, \nu_{i_\ell-1})}(w_1, \dots, w_k \mid \tau_1 \bar{\Xi}, \tau_1 \mathbf{S})$. Indeed, this is because

$$\frac{1 - s_0 \xi_0^{-1} w_p}{1 - s_0^{-1} \xi_0^{-1} w_p} \varphi_{\nu_{i_p}}(w_p \mid \bar{\Xi}, \mathbf{S}) = (-s_0) \varphi_{\nu_{i_p-1}}(w_p \mid \tau_1 \bar{\Xi}, \tau_1 \mathbf{S}),$$

since all $\nu_{i_p} \geq 1$ (here, as before, τ_1 means the shift (4.25)). The function $F_{(\nu_{i_1-1}, \dots, \nu_{i_\ell-1})}$ then arises due to (4.23).

This observation motivates our next step in computation of the q -correlation functions: we will utilize orthogonality of the functions F_μ (similar to Theorem 7.4), and integrate (8.9) over the w_i 's to extract certain terms. We will need the following nested integration contours:

Definition 8.3. For any $k \geq 1$, let $\gamma_1^-[\bar{\Xi \mathbf{S}}], \dots, \gamma_k^-[\bar{\Xi \mathbf{S}}]$ be positively oriented closed contours such that

- Each contour $\gamma_\alpha^-[\bar{\Xi \mathbf{S}}]$ encircles all the points of the set $\bar{\Xi \mathbf{S}} = \{\xi_i s_i^{-1}\}_{i \geq 0}$, while leaving outside all the points of $\Xi \mathbf{S} = \{\xi_i s_i\}_{i \geq 0}$.
- For any $\beta > \alpha$, the interior of $\gamma_\beta^-[\bar{\Xi \mathbf{S}}]$ contains the contour $q^{-1} \gamma_\alpha^-[\bar{\Xi \mathbf{S}}]$.
- The contour $\gamma_1^-[\bar{\Xi \mathbf{S}}]$ is sufficiently small so that it does not intersect with $q^{-1} \gamma_1^-[\bar{\Xi \mathbf{S}}]$.

See Fig. 25. The superscript “ $-$ ” refers to the property that the contours are q^{-1} -nested.

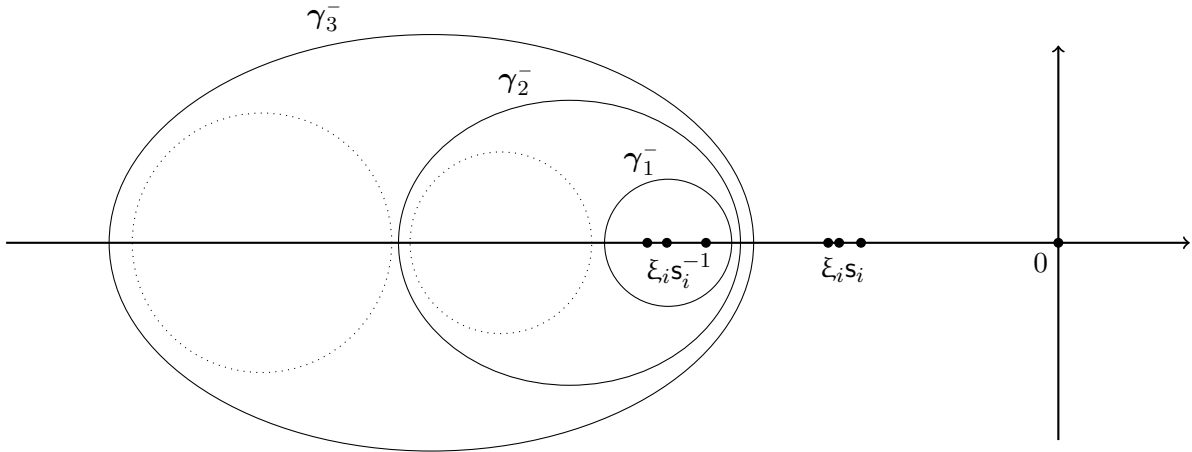

FIGURE 25. A possible choice of nested integration contours $\gamma_i^- = \gamma_i^-[\bar{\Xi \mathbf{S}}]$, $i = 1, 2, 3$ (Definition 8.3). Contours $q^{-1} \gamma_1^-[\bar{\Xi \mathbf{S}}]$ and $q^{-2} \gamma_1^-[\bar{\Xi \mathbf{S}}]$ are shown dotted.

Conditions (5.1) and (7.4) on q , \mathbf{S} , and Ξ readily imply that the contours $\gamma_j^-[\bar{\Xi \mathbf{S}}]$ exist. Throughout this subsection we will assume that these conditions hold.

Remark 8.4. The integration contours $\gamma_j^-[\bar{\Xi \mathbf{S}}]$ can be obtained from the contours $\gamma_j^+[\Xi \mathbf{S}]$ of Definition 7.2²⁴ by dragging $\gamma_1^+[\Xi \mathbf{S}], \dots, \gamma_k^+[\Xi \mathbf{S}]$ (in this order) through infinity, if this operation is allowed for a particular integrand (i.e., it must have no residues at infinity).

We will use the following integral transform:

Definition 8.5. For $k \geq 1$, let $R(w_1, \dots, w_k)$ be a symmetric rational function with singularities only occurring when some of the w_j 's belong to $\tau_1(\Xi \mathbf{S} \cup \bar{\Xi \mathbf{S}}) = \{\xi_i s_i^{\pm 1}\}_{i \in \mathbb{Z}_{\geq 1}}$. Let $\vartheta \in \text{Sign}_k^+$. Define

²⁴Note the swapping $\xi_x \leftrightarrow \xi_x^{-1}$ in $\gamma_j^+[\Xi \mathbf{S}]$ as compared to Definition 7.2. Moreover, for the existence of the latter contours we must assume that $m_{\Xi|\mathbf{S}} > qM_{\Xi|\mathbf{S}}$, which is not equivalent to the first condition in (7.4).

$$\begin{aligned}
(\mathcal{T}^{(k)}R)(\vartheta) &:= \frac{(-1)^k c_S(\vartheta)}{(1-q)^k} \oint_{\gamma_1^-[\Xi \bar{S}]} \frac{dw_1}{2\pi i} \cdots \oint_{\gamma_k^-[\Xi \bar{S}]} \frac{dw_k}{2\pi i} \prod_{1 \leq \alpha < \beta \leq k} \frac{w_\alpha - w_\beta}{w_\alpha - qw_\beta} \\
&\quad \times R(w_1, \dots, w_k) \prod_{i=1}^k w_i^{-1} \varphi_{\vartheta_i}(w_i^{-1} | \tau_1 \Xi, \tau_1 S),
\end{aligned}$$

where the integration contours are described in Definition 8.3.

Let us denote for any $\lambda \in \text{Sign}_\ell^+$:

$$R_\lambda^{(\ell)}(w_1, \dots, w_k) := \mathbf{1}_{\lambda_\ell \geq 1} \sum_{\sigma \in \mathfrak{S}_k} \sigma \left(\prod_{1 \leq \alpha < \beta \leq k} \frac{w_\alpha - qw_\beta}{w_\alpha - w_\beta} \prod_{p=1}^{\ell} \frac{1 - s_0 \xi_0^{-1} w_p}{1 - s_0^{-1} \xi_0^{-1} w_p} \varphi_{\lambda_p}(w_p | \Xi, S) \right);$$

these are the w_j -dependent summands in (8.9). As mentioned above, for $\ell = k$,

$$R_\lambda^{(k)}(w_1, \dots, w_k) = (-s_0)^k F_{\lambda-1^k}(w_1, \dots, w_k | \tau_1 \Xi, \tau_1 S).$$

Moreover, the action of the transform $\mathcal{T}^{(k)}$ on the $R_\lambda^{(\ell)}$'s for any ℓ and λ turns out to be very simple:

Lemma 8.6. *For any $\ell = 0, \dots, k$ and any $\lambda \in \text{Sign}_\ell^+$ we have*

$$(\mathcal{T}^{(k)}R_\lambda^{(\ell)})(\vartheta) = (-s_0)^k \mathbf{1}_{\ell=k} \mathbf{1}_{\vartheta=\lambda-1^k}, \quad \vartheta \in \text{Sign}_k^+.$$

Proof. We may assume that $\lambda_\ell \geq 1$. Let us complement λ by zeros, $\lambda = (\lambda_1, \dots, \lambda_\ell, 0, \dots, 0)$, so that it has length k . We have

$$\begin{aligned}
(\mathcal{T}^{(k)}R_\lambda^{(\ell)})(\vartheta) &= \frac{(-1)^k c_S(\vartheta)}{(1-q)^k} \sum_{\sigma \in \mathfrak{S}_k} \oint_{\gamma_1^-[\Xi \bar{S}]} \frac{dw_1}{2\pi i} \cdots \oint_{\gamma_k^-[\Xi \bar{S}]} \frac{dw_k}{2\pi i} \prod_{1 \leq \alpha < \beta \leq k} \frac{w_\alpha - w_\beta}{w_\alpha - qw_\beta} \frac{w_{\sigma(\alpha)} - qw_{\sigma(\beta)}}{w_{\sigma(\alpha)} - w_{\sigma(\beta)}} \\
&\quad \times (-s_0)^\ell \prod_{p=1}^{\ell} \underbrace{\varphi_{\lambda_p-1}(w_{\sigma(p)} | \tau_1 \Xi, \tau_1 S)}_{g_{\lambda_p}(w_{\sigma(p)})} \cdot \prod_{i=1}^k \underbrace{w_i^{-1} \varphi_{\vartheta_i}(w_i^{-1} | \tau_1 \Xi, \tau_1 S)}_{f_{\vartheta_i+1}(w_i)}. \quad (8.10)
\end{aligned}$$

We now wish to apply Lemma 7.1 with

$$f_m(w) = \begin{cases} w^{-1} \varphi_{m-1}(w^{-1} | \tau_1 \Xi, \tau_1 S), & m \geq 1; \\ 1, & m = 0, \end{cases} \quad g_l(w) = \begin{cases} \varphi_{l-1}(w | \tau_1 \Xi, \tau_1 S), & l \geq 1; \\ 1, & l = 0, \end{cases}$$

and $P'_1 = \tau_1(\Xi S) \cup \{\infty\}$, $P'_2 = \tau_1(\Xi \bar{S})$ (we use notation $P'_{1,2}$ to distinguish from $P_{1,2}$ in Definition 7.2). Indeed, since in our integral we always have $m \geq 1$, all singularities of $f_m(w)g_l(w)$ are in $P'_1 \cup P'_2$. Moreover, for $m < l$, all poles of this product are in P'_2 , and for $m > l$ (which may include $l = 0$) all poles are in P'_1 . Finally, observe that we can deform the integration contours as in the hypothesis of Lemma 7.1.

Therefore, since $\vartheta_i + 1 \geq 1$ for all i in our integral, we can apply Lemma 7.1, and conclude that it must be that $\lambda_i = \vartheta_i + 1$ for all $i = 1, \dots, k$, in order for the integral to be nonzero. In particular, the integral can be nonzero only for $\ell = k$.

When $\ell = k$, the desired claim for $\vartheta = \lambda - 1^k$ follows by analogy with the last computation in the proof of Theorem 7.4 (with swapped parameters $\xi_x \leftrightarrow \xi_x^{-1}$). Namely, we first sum over σ (the integral vanishes unless σ permutes within clusters of ϑ), and then compute the resulting smaller integrals by taking residues at $w_1 = \xi_{\vartheta_j-1} s_{\vartheta_j-1}^{-1}$, $w_2 = q^{-1} \xi_{\vartheta_j-1} s_{\vartheta_j-1}^{-1}$, etc. This leads to the desired result. \square

Remark 8.7. Note that if $m_{\Xi|S} > qM_{\Xi|S}$, then for $\ell = k$ in the above proof we could simply drag the integration contours $\gamma_j^-[\Xi \bar{S}]$ through infinity to the negatively oriented $\gamma_j^+[\Xi S]$ (cf. Remark 8.4). Indeed, this is because for $\ell = k$ the integrand in (8.10) is regular at $w_i = \infty$ for all i . The passage to

the contours $\gamma_j^+[\Xi\mathbb{S}]$ eliminates the sign $(-1)^k$, and the desired claim for $\vartheta = \lambda - 1^k$ directly follows from Theorem 7.4 with $\xi_x \leftrightarrow \xi_x^{-1}$. In other words, under these additional assumptions on q , Ξ , and \mathbb{S} the transform $\mathcal{T}^{(k)}$ acts essentially as the inverse Plancherel transform (Definition 7.9). It is however crucial that the former is defined using the contours $\gamma_j^-[\Xi\mathbb{S}]$ and not $\gamma_j^+[\Xi\mathbb{S}]$ because of nontrivial residues at infinity in (8.10) for $\ell < k$.

Therefore, applying the transform $\mathcal{T}^{(k)}$ to the rational function $G_\nu(\boldsymbol{\rho}, w_1, \dots, w_k | \bar{\Xi}, \mathbb{S})$ and using Proposition 8.2, we arrive at the following statement summarizing the second step of the computation of the q -correlation functions:

Proposition 8.8. *Under assumptions (5.1) and (7.4) on q , \mathbb{S} , and Ξ , for any $n \geq k \geq 0$, $\nu \in \text{Sign}_n^+$, and $\vartheta \in \text{Sign}_k^+$, we have*

$$(\mathcal{T}^{(k)} G_\nu(\boldsymbol{\rho}, \bullet | \bar{\Xi}, \mathbb{S}))(\vartheta) = G_\nu(\boldsymbol{\rho} | \bar{\Xi}, \mathbb{S}) \frac{q^{-\frac{1}{2}k(k+1)}}{(-\tau_1 \mathbb{S})^\vartheta} \sum_{\substack{\mathcal{I} = \{i_1 < \dots < i_k\} \subseteq \{1, \dots, n\} \\ \nu_{i_1} = \vartheta_1 + 1, \dots, \nu_{i_k} = \vartheta_k + 1}} q^{i_1 + \dots + i_k}, \quad (8.11)$$

where “ \bullet ” stands for the variables w_1, \dots, w_k in which the transform $\mathcal{T}^{(k)}$ is applied, and we are using the usual notation $(-\tau_1 \mathbb{S})^\vartheta = \prod_{i=1}^k (-s_1) \dots (-s_{\vartheta_i})$. Note that for (8.11) to be nontrivial one must have $\nu_n \geq 1$.

8.4. q -correlation functions. The structure of formula (8.11) suggests the following definition. For any $n \geq k \geq 0$, any $\vartheta = (\vartheta_1 \geq \vartheta_2 \geq \dots \geq \vartheta_k \geq 0) \in \text{Sign}_k^+$ and any $\nu \in \text{Sign}_n^+$, set

$$\mathcal{Q}_\vartheta(\nu) := \sum_{\substack{\mathcal{I} = \{i_1 < \dots < i_k\} \subseteq \{1, \dots, n\} \\ \nu_{i_1} = \vartheta_1 + 1, \dots, \nu_{i_k} = \vartheta_k + 1}} q^{i_1 + \dots + i_k}. \quad (8.12)$$

If $n < k$, then the above expression is zero, by agreement. In this subsection we will employ Proposition 8.8 to compute the expectations

$$\mathbb{E}_{\mathbf{u}; \boldsymbol{\rho}}(\mathcal{Q}_\vartheta) = \sum_{\nu \in \text{Sign}_n^+} \mathcal{M}_{\mathbf{u}; \boldsymbol{\rho}}(\nu | \Xi, \mathbb{S}) \mathcal{Q}_\vartheta(\nu). \quad (8.13)$$

Note that by (6.14), the above summation ranges only over $\nu \in \text{Sign}_n^+$ with $\nu_n \geq 1$. The above sum converges if the parameters u_i satisfy (8.2).

Remark 8.9. Expectations (8.13) can be viewed as q -analogues of the correlation functions of $\mathcal{M}_{\mathbf{u}; \boldsymbol{\rho}}$. Indeed, when $q = 1$ and all ϑ_i 's are distinct, (8.12) turns into

$$\mathcal{Q}_\vartheta(\nu) \Big|_{q=1} = \prod_{i=1}^k \#\{j: 1 \leq j \leq n \text{ and } \nu_j = \vartheta_i\}.$$

When all the ν_j 's are also pairwise distinct, let us interpret them as coordinates of distinct particles on $\mathbb{Z}_{\geq 0}$. In this case the above expression further simplifies to

$$\mathcal{Q}_\vartheta(\nu) \Big|_{q=1} = \mathbf{1}_{\{\text{there is a particle of the configuration } \nu \text{ at each of the locations } \vartheta_1, \dots, \vartheta_k\}}. \quad (8.14)$$

A probability distribution on configurations ν of n distinct particles on $\mathbb{Z}_{\geq 0}$ is often referred to as the (n) -point process on $\mathbb{Z}_{\geq 0}$. An expectation of (8.14) with respect to a point process on $\mathbb{Z}_{\geq 0}$ is known as the (k) -th correlation function of this point process.

For the purpose of analytic continuation in the parameter space, it is useful to establish that our q -correlation functions are a priori rational:

Lemma 8.10. *Fix $n \in \mathbb{Z}_{\geq 0}$, and let (8.2) hold. Then for any fixed $k = 0, \dots, n$ and $\vartheta \in \text{Sign}_k^+$, the expectation $\mathbb{E}_{\mathbf{u}; \boldsymbol{\rho}}(\mathcal{Q}_\vartheta)$ is a rational function in u_1, \dots, u_n and the parameters q , Ξ , and \mathbb{S} .*

Proof. Write

$$\mathbb{E}_{\mathbf{u}, \varrho}(\mathcal{Q}_\vartheta) = \sum_{\mathcal{I}=\{i_1 < \dots < i_k\} \subseteq \{1, \dots, n\}} q^{i_1 + \dots + i_k} \sum_{\substack{\nu \in \text{Sign}_n^+ \\ \nu_{i_1} = \vartheta_1, \dots, \nu_{i_k} = \vartheta_k}} \mathcal{M}_{\mathbf{u}, \varrho}(\nu | \Xi, \mathbf{S}),$$

and observe that only the second sum is infinite. Therefore, we may fix \mathcal{I} and consider only the summation over ν . By (8.1) and (6.16), the sum over ν is the same as the sum of products of stochastic vertex weights $\mathbb{L}_{\xi_x u_y, s_x}$ over certain collections of n paths in $\{0, 1, 2, \dots\} \times \{1, 2, \dots, n\}$, as in Definition 4.4. Namely, these paths start with n horizontal edges $(-1, t) \rightarrow (0, t)$, $t = 1, \dots, n$, end with n vertical edges $(\nu_i, n) \rightarrow (\nu_i, n + 1)$ (note that $\nu_n \geq 1$), and the end edges are partially fixed by the condition $\nu_{i_1} = \vartheta_1, \dots, \nu_{i_k} = \vartheta_k$. Therefore, only the coordinates $\nu_1, \dots, \nu_{i_1-1}$ belong to the infinite range $\{\vartheta_1 + 1, \vartheta_1 + 2, \dots\}$.

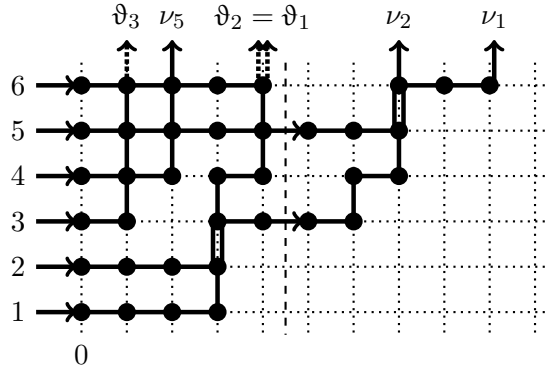

FIGURE 26. Splitting of summation over path collections in the proof of Lemma 8.10 for $n = 6$, $k = 3$, and $r = 2$. The dotted arrows on the top correspond to fixed vertical edges prescribed by ϑ , and here $\nu_3 = \vartheta_1$, $\nu_4 = \vartheta_2$, $\nu_6 = \vartheta_3$, and $\mathcal{J} = \{3, 5\}$.

Assume that $r \leq i_1 - 1$ out of our n paths go strictly to the right of ϑ_1 (i.e., we have $\nu_r > \vartheta_1$ and $\nu_{r+1} = \dots = \nu_{i_1} = \vartheta_1$). Let these paths contain edges $(\vartheta_1, j_i) \rightarrow (\vartheta_1 + 1, j_i)$ for some $\mathcal{J} = \{j_1 < \dots < j_r\} \subseteq \{1, \dots, n\}$. Fixing $r \leq i_1 - 1$ and such \mathcal{J} (there are only finitely many ways to choose this data), we may now split the summation over our n paths to paths in $\{0, 1, \dots, \vartheta_1\} \times \{1, \dots, n\}$ and in $\{\vartheta_1 + 1, \vartheta_1 + 2, \dots\} \times \{1, \dots, n\}$. The first sum over paths is also finite. See Fig. 26 for an illustration of this splitting of paths.

Since finite sums clearly produce rational functions, it now suffices to fix r and \mathcal{J} as above, and consider the corresponding sum over collections of r paths in $\{\vartheta_1 + 1, \vartheta_1 + 2, \dots\} \times \{1, \dots, n\}$ starting with horizontal edges $(\vartheta_1, j_i) \rightarrow (\vartheta_1 + 1, j_i)$ and ending with vertical edges $(\nu_i, n) \rightarrow (\nu_i, n + 1)$, $i = 1, \dots, r$. Because this final infinite sum involves stochastic vertex weights and is over all unrestricted path collections, it is simply equal to 1 (recall that the u_i 's satisfy (8.2), so this sum converges). This completes the proof of the lemma. \square

We are now in a position to compute the q -correlation functions (8.13). First, we will obtain a nested contour integration formula when the points u_i^{-1} , $i = 1, \dots, n$, are inside the integration contour $\gamma_1^-[\Xi\bar{\mathbf{S}}]$ of Definition 8.3. Note that this requires $\Re(u_i) < 0$ for all i , which is incompatible with (5.2). However, the correlation functions (8.13) are clearly well-defined as sums of possibly negative terms, and we have the following formula for them:

Proposition 8.11. *Assume that q , \mathbf{S} , and Ξ satisfy (5.1) and (7.4). Fix $n \geq k \geq 0$, and let u_1, \dots, u_n satisfy (8.2) and be such that the points u_i^{-1} are inside the integration contour $\gamma_1^-[\Xi\bar{\mathbf{S}}]$. Then for any $\vartheta = (\vartheta_1 \geq \vartheta_2 \geq \dots \geq \vartheta_k \geq 0) \in \text{Sign}_k^+$ we have*

$$\begin{aligned} \mathbb{E}_{\mathbf{u}; \varrho}(\mathcal{Q}_{\vartheta+1^k}) &= (-\tau_1 \mathbf{S})^\vartheta \mathbf{c}_{\mathbf{S}}(\vartheta) \frac{(-1)^k q^{\frac{k(k+1)}{2}}}{(1-q)^k} \oint_{\gamma_1^-[\Xi \bar{\mathbf{S}}]} \frac{dw_1}{2\pi i} \cdots \oint_{\gamma_k^-[\Xi \bar{\mathbf{S}}]} \frac{dw_k}{2\pi i} \prod_{1 \leq \alpha < \beta \leq k} \frac{w_\alpha - w_\beta}{w_\alpha - qw_\beta} \\ &\quad \times \prod_{i=1}^k \left(w_i^{-1} \varphi_{\vartheta_i}(w_i^{-1} | \tau_1 \Xi, \tau_1 \mathbf{S}) \prod_{j=1}^n \frac{1 - qu_j w_i}{1 - u_j w_i} \right), \end{aligned} \quad (8.15)$$

where $\mathbf{c}_{\mathbf{S}}(\vartheta)$ is defined by (4.9).

After proving this proposition, we will relax the conditions on the u_i 's (to include $u_i \geq 0$) by suitably deforming the integration contours.

Proof. The desired identity (8.15) formally follows from Proposition 8.8 combined with the Cauchy identity summation (8.4). However, one needs to justify that this summation can be performed inside the integral.

Observe that if (8.2) holds, then the left-hand side of (8.15) is a rational function in the u_i 's. Therefore, the desired identity would follow by analytic continuation of rational functions (cf. footnote²³) if we can show that for certain restricted values of q , \mathbf{S} , Ξ , and $\{u_i\}$ and on certain deformed contours we have $(u_i, w_j) \in \text{Adm}_{\Xi, \mathbf{S}}$ for all i, j , so that the summation can be performed inside the integral.

This can be done similarly to the proof of Theorem 7.7. Namely, it suffices to show that

$$\left| \frac{u_i^{-1} - \xi_x \mathbf{s}_x^{-1}}{u_i^{-1} - \xi_x \mathbf{s}_x} \right| < r, \quad \left| \frac{w_j - \xi_x \mathbf{s}_x}{w_j - \xi_x \mathbf{s}_x^{-1}} \right| < R, \quad \text{for some } R > 1, 0 < r < 1, \text{ with } rR < 1, \text{ and all } x,$$

which implies admissibility (4.16) (note also that the first of these inequalities implies (8.2)). That is, the points u_i^{-1} should be closer to $\xi_x \mathbf{s}_x^{-1}$ than to $\xi_x \mathbf{s}_x$, and the opposite for the w_j 's. Considering the discs $\tilde{B}_x^{(r)} := \{z \in \mathbb{C} : |z - \xi_x \mathbf{s}_x^{-1}| < r|z - \xi_x \mathbf{s}_x|\}$, one can check that for restricted values of the parameters Ξ and \mathbf{S} similarly to (7.12) and for q sufficiently small, we have

1. $\bigcap_{x=0}^{\infty} \tilde{B}_x^{(r)}$ is nonempty;
2. $\bigcup_{x=0}^{\infty} \tilde{B}_x^{(1/R)}$ does not contain any of the points $\xi_x \mathbf{s}_x$;
3. $\bigcup_{x=0}^{\infty} \tilde{B}_x^{(1/R)}$ does not intersect with $\bigcup_{x=0}^{\infty} q^{-1} \tilde{B}_x^{(1/R)}$,

and so the deformed contours $\gamma_1^-[\Xi \bar{\mathbf{S}}]', \dots, \gamma_k^-[\Xi \bar{\mathbf{S}}]'$ exist.

Therefore, for restricted values of parameters we can deform the contours $\gamma_j^-[\Xi \bar{\mathbf{S}}]$ to $\gamma_j^-[\Xi \bar{\mathbf{S}}]'$, and the points u_i^{-1} will be inside the contour $\gamma_1^-[\Xi \bar{\mathbf{S}}]'$. On the deformed contours the summation (8.4) can be performed inside the integral, yielding the identity (8.15) between rational functions for restricted values of parameters. We conclude that (8.15) then holds for all values of parameters as described in the claim, because for them the contour integral represents the same rational function. \square

To state our final result for the q -correlation functions, we need the following integration contour:

Definition 8.12. Let $u_1, \dots, u_n > 0$, and assume that $u_i \neq qu_j$ for any i, j . Define the contour $\gamma[\bar{\mathbf{u}}]$ to be a union of sufficiently small positively oriented circles around all the points $\{u_i^{-1}\}$, such that the interior of $\gamma[\bar{\mathbf{u}}]$ does not intersect with $q^{\pm 1} \gamma[\bar{\mathbf{u}}]$, and the points $\tau_1(\Xi \mathbf{S}) = \{\xi_x \mathbf{s}_x\}_{x \in \mathbb{Z}_{\geq 1}}$ are outside the contour $\gamma[\bar{\mathbf{u}}]$.

For $u_i > 0$ and $q \cdot \max_i u_i < \min_i u_i$, let the q^{-1} -nested contours $\gamma_j^-[\bar{\mathbf{u}}]$, $j = 1, \dots, k$, be defined analogously to $\gamma_j^-[\Xi \bar{\mathbf{S}}]$ of Definition 8.3 (but the $\gamma_j^-[\bar{\mathbf{u}}]$'s encircle the points u_i^{-1}). In this case the contour $\gamma_1^-[\bar{\mathbf{u}}]$ can also play the role of $\gamma[\bar{\mathbf{u}}]$ of Definition 8.12.

With these contours we can now formulate the final result of the computation in §§8.2–§8.4:

Theorem 8.13. *The nested contour integral formula (8.15) for the q -correlation functions of the dynamics $\mathcal{X}_{\{ut\}; \varrho}^+$ at time $= n$ holds in each of the following three cases:*

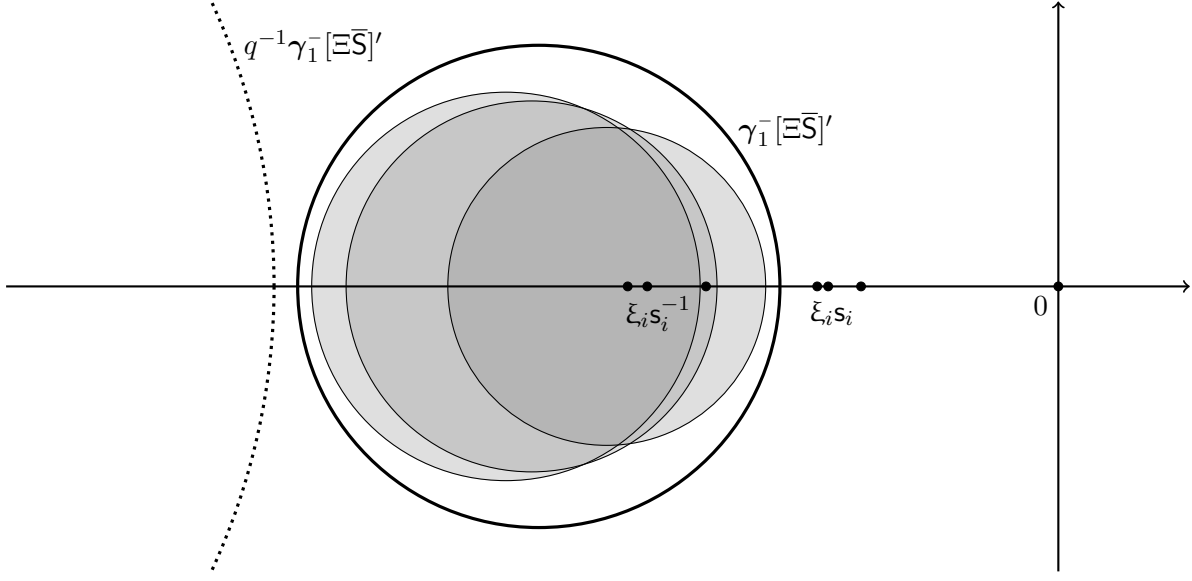

FIGURE 27. Discs $\tilde{B}_x^{(r)}$ (shaded) for the proof of Proposition 8.11, and a possible choice of the deformed contour $\gamma_1^-[\Xi\bar{S}]'$. A part of the contour $q^{-1}\gamma_1^-[\Xi\bar{S}]'$ is shown dotted, explaining why q should be small for the contours $\gamma_j^-[\Xi\bar{S}]'$ to exist.

1. Let q , S , and Ξ satisfy (5.1) and (7.4), the points u_i^{-1} be inside the integration contour $\gamma_1^-[\Xi\bar{S}]$, and the u_i 's satisfy (8.2). Then (8.15) holds with the integration contours $w_j \in \gamma_j^-[\Xi\bar{S}]$ of Definition 8.3.
2. Under (5.1) and (7.4), let $u_i > 0$ for all i and $u_i \neq qu_j$ for any i, j . Then (8.15) holds when all the integration contours are the same, $w_j \in \gamma[\bar{\mathbf{u}}]$ (described in Definition 8.12). In this case we can symmetrize the integrand similarly to the proof of Corollary 7.5, and the formula takes the form

$$\mathbb{E}_{\mathbf{u}; \mathbf{g}}(\mathcal{Q}_{\mathfrak{d}+1^k}) = \frac{(-1)^k q^{\frac{k(k+1)}{2}}}{(1-q)^k k!} \oint_{\gamma[\bar{\mathbf{u}}]} \frac{dw_1}{2\pi i} \cdots \oint_{\gamma[\bar{\mathbf{u}}]} \frac{dw_k}{2\pi i} \prod_{1 \leq \alpha \neq \beta \leq k} \frac{w_\alpha - w_\beta}{w_\alpha - qw_\beta} \\ \times (-\tau_1 S)^{\mathfrak{d}} \frac{\text{Fc}_{\mathfrak{d}}(w_1^{-1}, \dots, w_k^{-1} | \tau_1 \Xi, \tau_1 S)}{w_1 \dots w_k} \prod_{i=1}^k \prod_{j=1}^n \frac{1 - qu_j w_i}{1 - u_j w_i}. \quad (8.16)$$

3. Under (5.1)–(5.2) and (7.4), let \mathbf{u} have the form

$$\mathbf{u} = (u_1, qu_1, \dots, q^{J-1}u_1, u_2, qu_2, \dots, q^{J-1}u_2, \dots, u_{n'}, qu_{n'}, \dots, q^{J-1}u_{n'}), \\ \text{where } n = Jn' \text{ with some } J \in \mathbb{Z}_{\geq 1}, \quad u_i > 0, \quad \text{and} \quad q \cdot \max_i u_i < \min_i u_i. \quad (8.17)$$

Then (8.15) holds with the integration contours $w_j \in \gamma_j^-[\bar{\mathbf{u}}]$. In this case the double product in the integrand takes the form $\prod_{i=1}^k \prod_{j=1}^{n'} \frac{1 - q^J u_j w_i}{1 - u_j w_i}$.²⁵

Proof. 1. This is Proposition 8.11.

²⁵Since the definition of the contours $\gamma_j^-[\bar{\mathbf{u}}]$ does not depend on $J \in \mathbb{Z}_{\geq 1}$, we can analytically continue the nested contour integral formula in q^J (similarly to the discussion in §6.6). We will employ this continuation in §10.3 below.

2. To prove the second case, start with (8.15) with contours $w_j \in \gamma_j^-[\Xi\bar{S}]$ and q, S, Ξ , and $\{u_i\}$ fixed, and observe the following effect. The integrand

$$\prod_{1 \leq \alpha < \beta \leq k} \frac{w_\alpha - w_\beta}{w_\alpha - qw_\beta} \prod_{i=1}^k \left(w_i^{-1} \varphi_{\partial_i}(w_i^{-1} | \tau_1 \Xi, \tau_1 S) \prod_{j=1}^n \frac{1 - qu_j w_i}{1 - u_j w_i} \right) \quad (8.18)$$

has only the poles $w_1 = u_j^{-1}$, $j = 1, \dots, n$, inside the contour $\gamma_1^-[\Xi\bar{S}]$, because the other poles ∞ and $\{\xi_i s_i\}_{i \in \mathbb{Z}_{\geq 1}}$ are outside $\gamma_1^-[\Xi\bar{S}]$. Deform the integration contour $\gamma_2^-[\Xi\bar{S}]$ so that it becomes the same as $\gamma_1^-[\Xi\bar{S}]$, thus picking the residue at $w_2 = q^{-1}w_1$. We see that

$$\text{Res}_{w_2=q^{-1}w_1} \frac{w_1 - w_2}{w_1 - qw_2} \left(\prod_{j=1}^n \frac{1 - qu_j w_1}{1 - u_j w_1} \frac{1 - qu_j w_2}{1 - u_j w_2} \right) = (1 - q)q^{-2}w_1 \prod_{j=1}^n \frac{q(1 - qu_j w_1)}{q - u_j w_1}.$$

Hence, the residue at $w_2 = q^{-1}w_1$ is regular in w_1 on the contour $\gamma_1^-[\Xi\bar{S}]$, and thus vanishes after the w_1 integration. Continuing this argument in a similar way, we may deform all integration contours to be $\gamma_1^-[\Xi\bar{S}]$. In other words, we see that the integral (8.15) can be computed by taking only the residues at points $w_i = u_{j_i}^{-1}$, where $i = 1, \dots, k$ and $\{j_1, \dots, j_k\} \subseteq \{1, \dots, n\}$.

Next, observe that the points $\xi_x s_x^{-1}$ are not poles of the integrand (8.18), and so the requirement that the contour $\gamma_1^-[\Xi\bar{S}]$ encircles these points can be dropped. Thus, we may take $u_i > 0$, and the integration contours to be $\gamma[\bar{\mathbf{u}}]$ instead of $\gamma_1^-[\Xi\bar{S}]$. Symmetrizing the integration variables finishes the second case.

3. This case can be obtained as a limit of the second case. Namely, under assumptions of case 2 and also assuming $q \cdot \max_i u_i < \min_i u_i$, let us first pass to the q^{-1} -nested contours $\gamma_j^-[\bar{\mathbf{u}}]$, which start from $\gamma[\bar{\mathbf{u}}] = \gamma_1^-[\bar{\mathbf{u}}]$. This can be done following the above argument in case 2, because the integration in both cases $\gamma[\bar{\mathbf{u}}]$ and $\gamma_j^-[\bar{\mathbf{u}}]$ involves the same residues.

Next, if $u_2 \neq qu_1$, then the integrand in (8.15) has nonzero residues at both $(w_1, w_2) = (u_1^{-1}, u_2^{-1})$ and $(w_1, w_2) = (u_2^{-1}, u_1^{-1})$, and so both $u_{1,2}^{-1}$ must be inside $\gamma_1^-[\bar{\mathbf{u}}]$ to produce the correct rational function. However, if $u_2 = qu_1$, then the second residue vanishes due to the presence of the factor $u_2 - qu_1$. One can readily check that the same effect occurs when we first move u_2^{-1} outside the contour $\gamma_1^-[\bar{\mathbf{u}}]$ (but still inside $\gamma_2^-[\bar{\mathbf{u}}]$), and then set $u_2 = qu_1$. This agrees with the presence of the factors $\frac{1 - q^2 u_1 w_i}{1 - u_1 w_i}$ in the integrand after setting $u_2 = qu_1$, which do not have poles at $u_2^{-1} = (qu_1)^{-1}$. One also sees that after taking residue at $w_1 = u_1^{-1}$, the pole at $w_2 = u_1^{-1}$ disappears, but there is a new pole at $w_2 = (qu_1)^{-1}$.

Continuing on, we see that for the contours $\gamma_j^-[\bar{\mathbf{u}}]$ we can specialize \mathbf{u} to (8.17), and the contour integration will still yield the correct rational function (i.e., the corresponding specialization of the left-hand side of (8.15)). This establishes the third case. \square

8.5. **Remark. From observables to duality, and back.** Formula (8.16) for the q -correlation functions readily suggests a certain *self-duality* relation associated with the inhomogeneous stochastic higher spin six vertex model. Denote $H(\nu; \vartheta) := \mathcal{Q}_{\vartheta+1^k}(\nu)$. Then (8.16) implies

$$\sum_{\eta \in \text{Sign}_k^+} T(\vartheta \rightarrow \eta) \mathbb{E}_{\mathbf{u} \cup \mathbf{e}; \mathbf{e}} H(\bullet; \eta) = \mathbb{E}_{\mathbf{u}; \mathbf{e}} H(\bullet; \vartheta), \quad (8.19)$$

where $T(\vartheta \rightarrow \eta) := q^{-k} \frac{(-\tau_1 S)^\vartheta}{(-\tau_1 S)^\eta} \mathbf{G}_{\eta/\vartheta}((qu)^{-1} | \tau_1 \Xi, \tau_1 S)$. In (8.19) by “ \bullet ” we mean the variables in which the expectation is applied. To see (8.19), apply the operator T inside the integral, and note that (4.18)

is equivalent to

$$\sum_{\eta \in \text{Sign}_k^+} T(\vartheta \rightarrow \eta)(-\tau_1 \mathbf{S})^\eta \mathbb{F}_\eta^c(w_1^{-1}, \dots, w_k^{-1} | \tau_1 \Xi, \tau_1 \mathbf{S}) = \prod_{i=1}^k \frac{1 - uw_i}{1 - qw_i} (-\tau_1 \mathbf{S})^\vartheta \mathbb{F}_\vartheta^c(w_1^{-1}, \dots, w_k^{-1} | \tau_1 \Xi, \tau_1 \mathbf{S}). \quad (8.20)$$

On the other hand, adding the new parameter u to the specialization \mathbf{u} in (8.19) corresponds to time evolution, i.e., to the application of the operator $\mathcal{Q}_{u;\varrho}^+$ (6.16). That is, the left-hand side of (8.19) can be written as

$$\begin{aligned} & \sum_{\lambda \in \text{Sign}_{n+1}^+} \sum_{\eta \in \text{Sign}_k^+} T(\vartheta \rightarrow \eta) \mathcal{M}_{\mathbf{u} \cup u; \varrho}(\lambda | \Xi, \mathbf{S}) H(\lambda; \eta) \\ &= \sum_{\mu \in \text{Sign}_n^+} \mathcal{M}_{\mathbf{u}; \varrho}(\mu | \Xi, \mathbf{S}) \sum_{\eta \in \text{Sign}_k^+} T(\vartheta \rightarrow \eta) \sum_{\lambda \in \text{Sign}_{n+1}^+} \mathcal{Q}_{u; \varrho}^+(\mu \rightarrow \lambda) H(\lambda; \eta). \end{aligned}$$

Since the right-hand side of (8.19) involves the expectation with respect to the same measure $\mathcal{M}_{\mathbf{u}; \varrho}$ and since identity (8.19) holds for arbitrary u_i 's, this suggests the following *duality relation*:

$$\mathcal{Q}_{u; \varrho}^+ H T^{\text{transpose}} = H, \quad (8.21)$$

where the operators $\mathcal{Q}_{u; \varrho}^+$ and $T^{\text{transpose}}$ are applied in the first and the second variable in H , respectively. Similar duality relations can be written down by considering q -moments which are computed in Theorem 9.8 below.

It is worth noting that (self-)dualities like (8.21) can sometimes be independently proven from the very definition of the dynamics, and then utilized to produce nested contour integral formulas for the observables of these dynamics. This can be thought of as an alternative way to proving results like Theorem 8.13. Let us outline this argument. Applying $(\mathcal{Q}_{u; \varrho}^+)^n$ to (8.21) gives

$$(\mathcal{Q}_{u; \varrho}^+)^{n+1} H T^{\text{transpose}} = (\mathcal{Q}_{u; \varrho}^+)^n H.$$

Taking the expectation in both sides above, we arrive back at our starting point (8.19):

$$\mathbb{E}_{(u^{n+1}); \varrho} H T^{\text{transpose}} = \mathbb{E}_{(u^n); \varrho} H, \quad (u^m) := \underbrace{(u, \dots, u)}_{m \text{ times}}, \quad (8.22)$$

where, as before, the expectation of $H = H(\nu; \vartheta)$ is taken with respect to the probability distribution in ν , and the operator $T^{\text{transpose}}$ acts on ϑ . Thus, knowing (8.21) and passing to (8.22), one gets a closed system of linear equations for the observables $\mathbb{E}_{u^n; \varrho} H(\bullet; \vartheta)$, where n runs over $\mathbb{Z}_{\geq 0}$, and ϑ — over Sign_k^+ . This system can sometimes be reduced to a simpler system of free evolution equations subject to certain two-body boundary conditions, and the latter can be solved explicitly in terms of nested contour integrals.

This alternative route towards explicit formulas for averaging of observables was taken (for various degenerations of the higher spin six vertex model) in [BCS14], [BC13], [Cor14]. Duality for the (homogeneous) higher spin six vertex model started from infinitely many particles at the leftmost location was considered in [CP15].

Remark 8.14. An advantage of this alternative route starting from duality (8.21) is that it implies equations (8.22) for arbitrary (sufficiently nice) initial conditions, because one can take an arbitrary expectation in the last step leading to (8.22).²⁶ This argument could lead to nested contour integral formulas for arbitrary initial conditions, similarly to what is done in [BCPS15b] and [BCPS15a]. We will not discuss duality relations or formulas with arbitrary initial conditions here.

²⁶This is in contrast with (8.19) which is implied by (8.16), and thus holds only for the dynamics \mathcal{X}^+ started from the empty initial configuration.

9. q -MOMENTS OF THE HEIGHT FUNCTION

In this section we compute another type of observables of the stochastic dynamics $\mathcal{X}_{\{u_i\};\mathbf{g}}^+$ started from the empty initial configuration — the q -moments of its height function.

9.1. Height function and its q -moments. Let $\nu \in \text{Sign}_n^+$. Define the *height function* corresponding to ν as follows:

$$\mathfrak{h}_\nu(x) := \#\{j: \nu_j \geq x\}, \quad x \in \mathbb{Z}.$$

Clearly, $\mathfrak{h}_\nu(x)$ is a nonincreasing function of x , $\mathfrak{h}_\nu(0) = n$, and $\mathfrak{h}_\nu(+\infty) = 0$. In this section we will compute the (multi-point) q -moments

$$\mathbb{E}_{\mathbf{u};\mathbf{g}} \prod_{i=1}^{\ell} q^{\mathfrak{h}_\nu(x_i)} = \sum_{\nu \in \text{Sign}_n^+} \mathcal{M}_{\mathbf{u};\mathbf{g}}(\nu | \Xi, \mathbf{S}) \prod_{i=1}^{\ell} q^{\mathfrak{h}_\nu(x_i)}$$

of the height function, where $x_1 \geq \dots \geq x_\ell \geq 1$ are arbitrary. Note that the above summation ranges only over signatures with $\nu_n \geq 1$.

Lemma 9.1. *Fix $n \in \mathbb{Z}_{\geq 0}$ and u_1, \dots, u_n satisfying (8.2). Then for any ℓ and $x_1 \geq \dots \geq x_\ell \geq 1$, the q -moments $\mathbb{E}_{\mathbf{u};\mathbf{g}} \prod_{i=1}^{\ell} q^{\mathfrak{h}_\nu(x_i)}$ are rational functions in the u_i 's and the parameters q, Ξ , and \mathbf{S} .*

Proof. This is established similarly to Lemma 8.10, because if $\mathfrak{h}_\nu(x_1) \in \{0, 1, \dots, n\}$ is fixed, then there is a fixed number of the coordinates of ν belonging to an infinite range, and the summation over them produces a rational function. \square

We will first use the q -correlation functions discussed in §8 to compute one-point q -moments $\mathbb{E}_{\mathbf{u};\mathbf{g}} q^{\ell \mathfrak{h}_\nu(x)}$. The formula for these one-point q -moments allows to formulate an analogous multi-point statement, and we will then present its verification proof. Thus, the one-point formula will be proven in two different ways.

9.2. One-point q -moments from q -correlations. Let us first establish an algebraic identity connecting one-point q -moments with q -correlation functions. In fact, the identity holds even before taking the expectation:

Lemma 9.2. *For any $x \geq 1$, $\ell \geq 0$, and a signature ν , we have*

$$q^{\ell \mathfrak{h}_\nu(x)} = \sum_{k=0}^{\ell} (-q)^{-k} \binom{\ell}{k}_q (q; q)_k \sum_{\mathfrak{d}_1 \geq \dots \geq \mathfrak{d}_k \geq x} \mathcal{Q}_{(\mathfrak{d}_1, \dots, \mathfrak{d}_k)}(\nu). \quad (9.1)$$

Proof. Denote $\Delta \mathfrak{h}_\nu(x) := \mathfrak{h}_\nu(x) - \mathfrak{h}_\nu(x+1)$; this is the number of parts of ν that are equal to x . First, let us express the quantities $\mathcal{Q}_{\mathfrak{d}}(\nu)$ through the height function. We start with the case $\mathfrak{d} = (x^\ell) = (x, \dots, x)$. We have

$$\begin{aligned} \mathcal{Q}_{(x^\ell)}(\nu) &= \sum_{\substack{\mathcal{I} = \{i_1 < \dots < i_\ell\} \subseteq \{1, \dots, n\} \\ \nu_{i_1} = \dots = \nu_{i_\ell} = x}} q^{i_1 + \dots + i_\ell} \\ &= q^{\frac{\ell(\ell+1)}{2}} q^{\ell \mathfrak{h}_\nu(x+1)} \binom{\Delta \mathfrak{h}_\nu(x)}{\ell}_q \\ &= q^{\frac{\ell(\ell+1)}{2}} \frac{(q^{\Delta \mathfrak{h}_\nu(x)}; q^{-1})_\ell}{(q; q)_\ell} q^{\ell \mathfrak{h}_\nu(x+1)}, \end{aligned}$$

where the second equality follows similarly to the computation of the partition function (5.4).

For general

$$\mathfrak{d} = (x_1^{\ell_1}, \dots, x_m^{\ell_m}) := \underbrace{(x_1, \dots, x_1)}_{\ell_1 \text{ times}}, \dots, \underbrace{(x_m, \dots, x_m)}_{\ell_m \text{ times}},$$

where $x_1 > \dots > x_m \geq 0$ and $\ell = (\ell_1, \dots, \ell_m) \in \mathbb{Z}_{\geq 0}^m$, the summation over \mathcal{I} in (8.12) is clearly equal to the product of individual summations corresponding to each x_j , $j = 1, \dots, m$. Therefore,

$$\mathcal{Q}_{(x_1^{\ell_1}, \dots, x_m^{\ell_m})}(\nu) = \prod_{j=1}^m q^{\frac{\ell_j(\ell_j+1)}{2}} \frac{(q^{\Delta h_\nu(x_j)}; q^{-1})_{\ell_j}}{(q; q)_{\ell_j}} q^{\ell_j h_\nu(x_j+1)}. \quad (9.2)$$

Our next goal is to invert relation (9.2). Let us write down certain abstract inversion formulas which will lead us to the desired statement. In these formulas, we will assume that $A, B, A_0, A_1, A_2, \dots$ are indeterminates. Let us also denote

$$T_i(A) := q^{\frac{i(i+1)}{2}} \frac{(A; q^{-1})_i}{(q; q)_i}, \quad R_i := \frac{(-q)^i}{(q; q)_i}.$$

Note that by the very definition, $T_i(A) = 0$ for $i < 0$, $T_0(A) = 1$, and $T_i(1) = \mathbf{1}_{i=0}$. Moreover, $R_i = 0$ for $i < 0$, and $R_0 = 1$.

The first inversion formula is

$$A^n R_n = \sum_{k=0}^n T_k(A) R_{n-k}. \quad (9.3)$$

Indeed, multiply the above identity by B^n , and sum over $n \geq 0$. The left-hand side gives, by the q -Binomial Theorem,

$$\sum_{n=0}^{\infty} (AB)^n \frac{(-q)^n}{(q; q)_n} = \frac{1}{(-ABq; q)_\infty},$$

and in the right-hand side we first sum over $n \geq k$ and then over $k \geq 0$, which yields

$$\begin{aligned} \sum_{k=0}^{\infty} q^{\frac{k(k+1)}{2}} \frac{(A; q^{-1})_k}{(q; q)_k} B^k \sum_{n=k}^{\infty} \frac{(-q)^{n-k}}{(q; q)_{n-k}} B^{n-k} &= \frac{1}{(-Bq; q)_\infty} \sum_{k=0}^{\infty} q^{\frac{k(k+1)}{2}} \frac{(A; q^{-1})_k}{(q; q)_k} B^k \\ &= \frac{1}{(-Bq; q)_\infty} \sum_{k=0}^{\infty} \frac{(A^{-1}, q)_k}{(q; q)_k} (-q)^k A^k B^k = \frac{1}{(-Bq; q)_\infty} \frac{(-Bq; q)_\infty}{(-ABq; q)_\infty} = \frac{1}{(-ABq; q)_\infty}, \end{aligned}$$

where we have used the q -Binomial Theorem twice. This establishes (9.3), because the generating series of both its sides coincide.²⁷

Replace A by A_1 in (9.3), multiply it by $A_2 = A_2^k A_2^{n-k}$, and apply (9.3) to $A_2^{n-k} R_{n-k}$ in the right-hand side. Continuing this process with A_3, \dots, A_N , we obtain for any $\ell \geq 0$ and $N \geq 1$:

$$(A_1 \dots A_N)^\ell = \sum_{\mathbf{k} \in \mathbb{Z}_{\geq 0}^N} \frac{R_{\ell-|\mathbf{k}|}}{R_\ell} \prod_{j=1}^N T_{k_j}(A_j) (A_{j+1} A_{j+2} \dots A_N)^{k_j}, \quad (9.4)$$

where the sum is over all (unordered) nonnegative integer vectors $\mathbf{k} = (k_1, \dots, k_N)$ of length N . Here and below $|\mathbf{k}|$ stands for $k_1 + \dots + k_N$. Clearly, the sum ranges only over \mathbf{k} with $|\mathbf{k}| \leq \ell$. Note that if only finitely many of the indeterminates A_j differ from 1, then one can send $N \rightarrow +\infty$ in (9.4) and sum over integer vectors \mathbf{k} of arbitrary length.

If we set $A_j := q^{\Delta h_\nu(x+j-1)}$ and send $N \rightarrow +\infty$, the left-hand side of (9.4) becomes $q^{\ell h_\nu(x)}$, and in the right-hand side we obtain

$$T_{k_j}(A_j) (A_{j+1} A_{j+2} \dots)^{k_j} = q^{\frac{k_j(k_j+1)}{2}} \frac{(q^{\Delta h_\nu(x+j-1)}; q^{-1})_{k_j}}{(q; q)_{k_j}} q^{k_j h_\nu(x+j)}.$$

²⁷In the above manipulations with infinite series we assume that $0 \leq q < 1$ and that A and B are sufficiently small. Alternatively, it is enough to think that we are working with formal power series.

Therefore, the product of these quantities in (9.4) matches formula (9.2) for $\mathcal{Q}_\vartheta(\nu)$, where the point $x + j - 1$ enters the signature ϑ with multiplicity $k_j \geq 0$. This yields the desired formula. \square

Remark 9.3. Using a similar approach as in the above lemma, one can write down more complicated formulas expressing $\prod_{i=1}^\ell q^{\mathfrak{h}_\nu(x_i)}$ for any $x_1 \geq \dots \geq x_\ell \geq 1$ through the quantities $\mathcal{Q}_\vartheta(\nu)$. However, except for the one-point case, these expressions do not seem to be convenient for computing the q -moments. Therefore, in §9.3 below we present a verification-style proof for the multi-point q -moments.

Definition 9.4. Fix $\ell \in \mathbb{Z}_{\geq 1}$. Assume that (5.1) and (7.4) hold. Let $u_i > 0$ and $u_i \neq qu_j$ for any i, j . Then the integration contour $\gamma[\bar{\mathbf{u}}]$ encircling all u_i^{-1} is well-defined (see Definition 8.12). Let also c_0 be a positively oriented circle around zero which is sufficiently small. Let $r > q^{-1}$ be such that $q\gamma[\bar{\mathbf{u}}]$ does not intersect $r^\ell c_0$, and $r^\ell c_0$ does not encircle any of the points $\{\xi_i s_i\}_{i \in \mathbb{Z}_{\geq 1}}$. Denote $\gamma[\bar{\mathbf{u}}|j] := \gamma[\bar{\mathbf{u}}] \cup r^j c_0$, where $j = 1, \dots, \ell$. See Fig. 28.

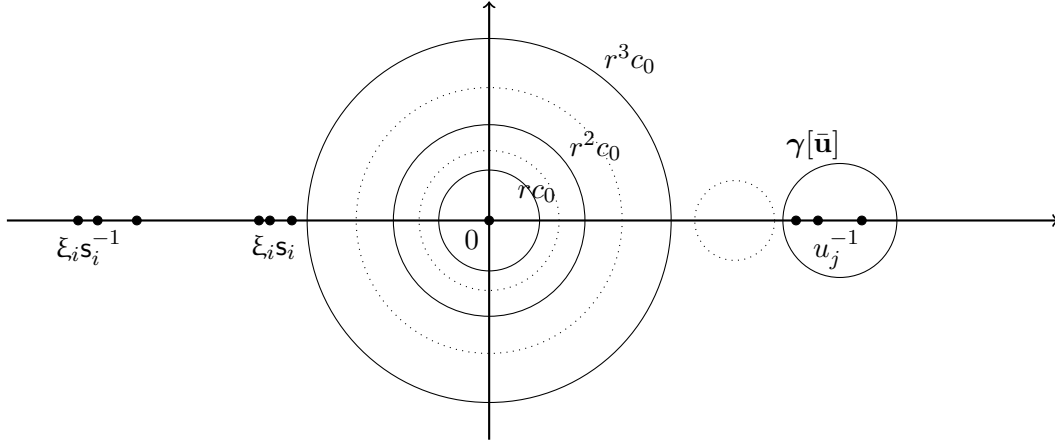

FIGURE 28. A possible choice of integration contours $\gamma[\bar{\mathbf{u}}|1] = \gamma[\bar{\mathbf{u}}] \cup r c_0$, $\gamma[\bar{\mathbf{u}}|2] = \gamma[\bar{\mathbf{u}}] \cup r^2 c_0$, and $\gamma[\bar{\mathbf{u}}|3] = \gamma[\bar{\mathbf{u}}] \cup r^3 c_0$ for $\ell = 3$ in Definition 9.4. Contours $q\gamma[\bar{\mathbf{u}}]$ and $q\gamma[\bar{\mathbf{u}}|2]$, $q\gamma[\bar{\mathbf{u}}|3]$ are shown dotted.

We are now in a position to compute the one-point q -moments:

Proposition 9.5. Assume that (5.1) and (7.4) hold. Let $u_i > 0$ and $u_i \neq qu_j$ for any i, j . Then for any $\ell \in \mathbb{Z}_{\geq 0}$ and $x \in \mathbb{Z}_{\geq 1}$ we have

$$\begin{aligned} \mathbb{E}_{\mathbf{u}; \varrho} q^{\ell \mathfrak{h}_\nu(x)} &= q^{\frac{\ell(\ell-1)}{2}} \oint_{\gamma[\bar{\mathbf{u}}|1]} \frac{dw_1}{2\pi i} \cdots \oint_{\gamma[\bar{\mathbf{u}}|\ell]} \frac{dw_\ell}{2\pi i} \prod_{1 \leq \alpha < \beta \leq \ell} \frac{w_\alpha - w_\beta}{w_\alpha - qw_\beta} \\ &\quad \times \prod_{i=1}^{\ell} \left(w_i^{-1} \prod_{j=1}^{x-1} \frac{\xi_j - s_j w_i}{\xi_j - s_j^{-1} w_i} \prod_{j=1}^n \frac{1 - qu_j w_i}{1 - u_j w_i} \right). \end{aligned} \quad (9.5)$$

Proof. Taking the expectation with respect to $\mathcal{M}_{\mathbf{u}; \varrho}$ in both sides of (9.1) and using (8.16) in the right-hand side, we obtain

$$\begin{aligned} \mathbb{E}_{\mathbf{u}; \varrho} q^{\ell \mathfrak{h}_\nu(x)} &= \sum_{k=0}^{\ell} \binom{\ell}{k}_q \frac{q^{\frac{k(k-1)}{2}} (q; q)_k}{(1-q)^k k!} \sum_{\vartheta_1 \geq \dots \geq \vartheta_k \geq x-1} \oint_{\gamma[\bar{\mathbf{u}}]} \frac{dw_1}{2\pi i} \cdots \oint_{\gamma[\bar{\mathbf{u}}]} \frac{dw_k}{2\pi i} \prod_{1 \leq \alpha \neq \beta \leq k} \frac{w_\alpha - w_\beta}{w_\alpha - qw_\beta} \\ &\quad \times (-\tau_1 S)^\vartheta \frac{F_\vartheta^\xi(w_1^{-1}, \dots, w_k^{-1} | \tau_1 \Xi, \tau_1 S)}{w_1 \dots w_k} \prod_{i=1}^k \prod_{j=1}^n \frac{1 - qu_j w_i}{1 - u_j w_i}. \end{aligned}$$

Because $\vartheta_k \geq x - 1$, we can subtract $(x - 1)$ from all parts of ϑ . We readily have

$$\begin{aligned} (-\tau_1 \mathbf{S})^\vartheta \mathbf{F}_\vartheta^c(w_1^{-1}, \dots, w_k^{-1} | \tau_1 \Xi, \tau_1 \mathbf{S}) &= (-s_1)^k \dots (-s_{x-1})^k \prod_{i=1}^k \prod_{j=1}^{x-1} \frac{\xi_j w_i^{-1} - s_j}{1 - s_j \xi_j w_i^{-1}} \\ &\quad \times \underbrace{(-\tau_x \mathbf{S})^{\vartheta - (x-1)^k} \mathbf{F}_{\vartheta - (x-1)^k}^c(w_1^{-1}, \dots, w_k^{-1} | \tau_x \Xi, \tau_x \mathbf{S})}_{\mathcal{M}_{(w_1^{-1}, \dots, w_k^{-1}); \varrho}(\vartheta - (x-2)^k | \tau_{x-1} \Xi, \tau_{x-1} \mathbf{S}) \text{ by (8.1)}}, \end{aligned}$$

where we have also used the fact that $\vartheta_k - (x - 2) \geq 1$. The probability weight $\mathcal{M}_{(w_1^{-1}, \dots, w_k^{-1}); \varrho}$ above is the only thing which now depends on ϑ , and the summation over all ϑ of these weights gives 1. This summation can be performed under the integral because on the contour $\gamma[\bar{\mathbf{u}}]$ we have $\Re(w_j) > 0$, and so conditions (8.2) with u_j replaced by w_j^{-1} hold for all our values of Ξ and \mathbf{S} . We see that this summation over ϑ yields

$$\begin{aligned} \mathbb{E}_{\mathbf{u}; \varrho} q^{\ell h_\nu(x)} &= \sum_{k=0}^{\ell} \binom{\ell}{k}_q q^{\frac{k(k-1)}{2}} \oint_{\gamma[\bar{\mathbf{u}}]} \frac{dw_1}{2\pi i} \dots \oint_{\gamma[\bar{\mathbf{u}}]} \frac{dw_k}{2\pi i} \prod_{1 \leq \alpha < \beta \leq k} \frac{w_\alpha - w_\beta}{w_\alpha - qw_\beta} \\ &\quad \times \frac{1}{w_1 \dots w_k} \prod_{i=1}^k \prod_{j=1}^{x-1} \frac{\xi_j - s_j w_i}{\xi_j - s_j^{-1} w_i} \prod_{i=1}^k \prod_{j=1}^n \frac{1 - qu_j w_i}{1 - u_j w_i}. \end{aligned}$$

Here we have applied the symmetrization formula (footnote⁸) to rewrite $(q; q)_k / (1 - q)^k$, which canceled the factor $1/k!$ and half of the product over $\alpha \neq \beta$.

Finally, the summation over k in the above formula can be eliminated by changing the integration contours with the help of [BCS14, Lemma 4.21] (which we recall as Lemma 9.6 below for convenience). This completes the proof of the desired identity (9.5). \square

Lemma 9.6 ([BCS14, Lemma 4.21]). *Let $\ell \geq 1$ and $f(w)$ with $f(0) = 1$ be a meromorphic function in \mathbb{C} having no poles in a disc around 0. Then we have*

$$\begin{aligned} \oint_{\gamma[\bullet|1]} \frac{dw_1}{2\pi i} \dots \oint_{\gamma[\bullet|\ell]} \frac{dw_\ell}{2\pi i} \prod_{1 \leq \alpha < \beta \leq \ell} \frac{w_\alpha - w_\beta}{w_\alpha - qw_\beta} \prod_{i=1}^{\ell} \frac{f(w_i)}{w_i} \\ = \sum_{k=0}^{\ell} \binom{\ell}{k}_q q^{\frac{1}{2}k(k-1) - \frac{1}{2}\ell(\ell-1)} \oint_{\gamma[\bullet]} \frac{dw_1}{2\pi i} \dots \oint_{\gamma[\bullet]} \frac{dw_k}{2\pi i} \prod_{1 \leq \alpha < \beta \leq k} \frac{w_\alpha - w_\beta}{w_\alpha - qw_\beta} \prod_{i=1}^k \frac{f(w_i)}{w_i}, \end{aligned}$$

where as $\gamma[\bullet]$ we can take an arbitrary closed contour not encircling 0, and all other contours and conditions on them are analogous to Definition 9.4.

Remark 9.7 (Fredholm determinants). Using a general approach outlined in [BCS14], the one-point q -moment formula of Proposition 9.5 (as well as its degenerations discussed in §10) can be employed to obtain Fredholm determinantal expressions for the q -Laplace transform $\mathbb{E}_{\mathbf{u}; \varrho} (1/(\zeta q^{h_\nu(x)}; q)_\infty)$ of the height function, which may be suitable for asymptotic analysis. We will not pursue this direction here.

9.3. Multi-point q -moment formula. By analogy with existing multi-point q -moment formulas for related systems²⁸ we can formulate a generalization of Proposition 9.5:

²⁸Namely, q -TASEPs [BCS14], [BC13], q -Hahn TASEP [Cor14], and the homogeneous stochastic higher spin six vertex model [CP15]. Note that however all these systems start with infinitely many particles at the leftmost location, and in our system a new particle is always added at location 1, so that the corresponding degenerations of Theorem 9.8 do not follow from those works.

Theorem 9.8. *Assume that (5.1) and (7.4) hold. Let $u_i > 0$ and $u_i \neq qu_j$ for any $i, j = 1, \dots, n$. Then for any integers $x_1 \geq \dots \geq x_\ell \geq 1$ the corresponding q -moment of the dynamics $\mathcal{X}_{\{u_t\}; \mathbf{g}}$ at time $= n$ is given by*

$$\mathbb{E}_{\mathbf{u}; \mathbf{g}} \prod_{i=1}^{\ell} q^{h_\nu(x_i)} = q^{\frac{\ell(\ell-1)}{2}} \oint_{\gamma[\bar{\mathbf{u}}|1]} \frac{dw_1}{2\pi\mathbf{i}} \cdots \oint_{\gamma[\bar{\mathbf{u}}|\ell]} \frac{dw_\ell}{2\pi\mathbf{i}} \prod_{1 \leq \alpha < \beta \leq \ell} \frac{w_\alpha - w_\beta}{w_\alpha - qw_\beta} \times \prod_{i=1}^{\ell} \left(w_i^{-1} \prod_{j=1}^{x_i-1} \frac{\xi_j - \mathfrak{s}_j w_i}{\xi_j - \mathfrak{s}_j^{-1} w_i} \prod_{j=1}^n \frac{1 - qu_j w_i}{1 - u_j w_i} \right), \quad (9.6)$$

where the integration contours are described in Definition 9.4.

Corollary 9.9. *Under (5.1)–(5.2) and (7.4), let the parameters \mathbf{u} have the form (8.17). Then the q -moments $\mathbb{E}_{\mathbf{u}; \mathbf{g}} \prod_{i=1}^{\ell} q^{h_\nu(x_i)}$ are given by the same formula as (9.6), but with integration contours $w_j \in \gamma_j^-[\bar{\mathbf{u}}|j] := \gamma_j^-[\bar{\mathbf{u}}] \cup r^j c_0$.*

Proof of Corollary 9.9. Assume that Theorem 9.8 holds. We argue as in the proof of case 3 in Theorem 8.13, by first taking \mathbf{u} with $u_i > 0$ and $q \cdot \max_i u_i < \min_i u_i$, which allows to immediately pass to the nested contours $\gamma_j^-[\bar{\mathbf{u}}|j]$ in (9.6). Then we can move u_2^{-1} outside $\gamma_1^-[\bar{\mathbf{u}}]$ but still inside $\gamma_2^-[\bar{\mathbf{u}}]$, set $u_2 = qu_1$, and continue specializing the rest of \mathbf{u} to (8.17) in a similar way. This specialization inside the integral will coincide with the same specialization of the left-hand side of (9.6), and thus the corollary is established. \square

Remark 9.10. In Theorem 9.8 (as well as in case 2 of Theorem 8.13) the conditions (5.1) and (7.4) can be partially dropped or replaced by more general ones, because the integration contour $\gamma[\bar{\mathbf{u}}]$ is defined only using the u_i 's. Here we will not discuss more general values of q , \mathfrak{S} , or Ξ .

The rest of this subsection is devoted to the proof of Theorem 9.8. The proof is of verification type: we start with the nested contour integral in the right-hand side of (9.6), and rewrite it as an expectation with respect to $\mathcal{M}_{\mathbf{u}; \mathbf{g}}$.

Lemma 9.11. *Under the assumptions of Theorem 9.8, the collection of identities (9.6) (for all $\ell \geq 1$ and all $x_1 \geq \dots \geq x_\ell \geq 1$) follows from a collection of identities of the following form:*

$$\mathbb{E}_{\mathbf{u}; \mathbf{g}} \prod_{i=1}^{\ell} (q^{i-1} - q^{h_\nu(x_i)}) = (-1)^\ell q^{\frac{\ell(\ell-1)}{2}} \oint_{\gamma[\bar{\mathbf{u}}]} \frac{dw_1}{2\pi\mathbf{i}} \cdots \oint_{\gamma[\bar{\mathbf{u}}]} \frac{dw_\ell}{2\pi\mathbf{i}} \prod_{1 \leq \alpha < \beta \leq \ell} \frac{w_\alpha - w_\beta}{w_\alpha - qw_\beta} \times \prod_{i=1}^{\ell} \left(w_i^{-1} \prod_{j=1}^{x_i-1} \frac{\xi_j - \mathfrak{s}_j w_i}{\xi_j - \mathfrak{s}_j^{-1} w_i} \prod_{j=1}^n \frac{1 - qu_j w_i}{1 - u_j w_i} \right). \quad (9.7)$$

That is, removing the parts of the contours around 0 leads to a modification of the left-hand side, as shown above.

This lemma should also hold in the opposite direction (that identities (9.6) imply (9.7)), but we do not need this statement.

Proof. The right-hand side of (9.6) can be written as

$$q^{\frac{\ell(\ell-1)}{2}} \oint_{\gamma[\bar{\mathbf{u}}|1]} \frac{dw_1}{2\pi\mathbf{i}} \cdots \oint_{\gamma[\bar{\mathbf{u}}|\ell]} \frac{dw_\ell}{2\pi\mathbf{i}} \prod_{1 \leq \alpha < \beta \leq \ell} \frac{w_\alpha - w_\beta}{w_\alpha - qw_\beta} \prod_{i=1}^{\ell} \frac{f_{x_i}(w_i)}{w_i}, \quad (9.8)$$

where each $f_x(w)$, $x \in \mathbb{Z}_{\geq 1}$, is a meromorphic (in fact, rational) function without poles in a disc around 0, and $f_x(0) = 1$.

Split the integral in (9.8) into 2^n integrals indexed by subsets $\mathcal{I} \subseteq \{1, \dots, \ell\}$ determining that w_i for $i \notin \mathcal{I}$ are integrated around 0, while other w_i 's are integrated over $\gamma[\bar{\mathbf{u}}]$. Let $|\mathcal{I}| = k$, $k = 0, \dots, \ell$, and also denote $\|\mathcal{I}\| := \sum_{i \in \mathcal{I}} i$. Let $\mathcal{I} = \{i_1 < \dots < i_k\}$ and $\{1, 2, \dots, \ell\} \setminus \mathcal{I} = \{p_1 < \dots < p_{\ell-k}\}$. The contours around 0 (corresponding to w_{p_j}) can be shrunk to 0 in the order $p_1, \dots, p_{\ell-k}$ without crossing any other poles, and each such integration produces the factor $q^{-(\ell-p_j)}$ coming from the cross-product over $\alpha < \beta$. Thus, (9.8) becomes (after renaming $w_{i_j} = z_j$)

$$\sum_{k=0}^{\ell} \sum_{\mathcal{I}=\{i_1 < \dots < i_k\} \subseteq \{1, \dots, \ell\}} q^{k\ell - \|\mathcal{I}\|} \oint_{\gamma[\bar{\mathbf{u}}]} \frac{dz_1}{2\pi i} \cdots \oint_{\gamma[\bar{\mathbf{u}}]} \frac{dz_k}{2\pi i} \prod_{1 \leq \alpha < \beta \leq k} \frac{z_\alpha - z_\beta}{z_\alpha - qz_\beta} \prod_{j=1}^k \frac{f_{x_{i_j}}(z_j)}{z_j}. \quad (9.9)$$

The above summation now involves integrals as in the right-hand side of (9.7). If the latter identity holds, then we can rewrite each such integral as a certain expectation as in the left-hand side of (9.7). Relation (9.6) now follows from a formal identity in indeterminates $\hat{q}, X_1, \dots, X_\ell$:

$$\sum_{k=0}^{\ell} \sum_{\mathcal{I}=\{i_1 < \dots < i_k\} \subseteq \{1, \dots, \ell\}} \hat{q}^{\frac{(\ell-k)(\ell-k+1)}{2}} (X_{i_1} - \hat{q}^{i_1}) (X_{i_2} - \hat{q}^{i_2-1}) \cdots (X_{i_k} - \hat{q}^{i_k-k+1}) = X_1 \cdots X_\ell, \quad (9.10)$$

where we have matched \hat{q} to q^{-1} in (9.8) and (9.9). To establish (9.10), observe that both its sides are linear in X_1 , and so it suffices to show that the identity holds at two points, say, $X_1 = \hat{q}$ and $X_1 = \infty$. Substituting each of these values into (9.10) leads to an equivalent identity with ℓ replaced by $\ell - 1$. Namely, for $X_1 = \hat{q}$ we obtain

$$\sum_{k=0}^{\ell-1} \sum_{\mathcal{I}=\{1 < i_1 < \dots < i_k\} \subseteq \{1, \dots, \ell\}} \hat{q}^{\frac{(\ell-1-k)(\ell-1-k+1)}{2}} (\hat{q}^{-1} X_{i_1} - \hat{q}^{i_1-1}) \cdots (\hat{q}^{-1} X_{i_k} - \hat{q}^{i_k-k}) = \hat{q}^{1-\ell} X_2 \cdots X_\ell,$$

which becomes (9.10) with $\ell - 1$ after setting $Y_i = \hat{q}^{-1} X_{i+1}$. Dividing (9.10) by X_1 and letting $X_1 \rightarrow \infty$, we obtain

$$\sum_{k=1}^{\ell} \sum_{\mathcal{I}=\{1=i_1 < \dots < i_k\} \subseteq \{1, \dots, \ell\}} \hat{q}^{\frac{((\ell-1)-(k-1))((\ell-1)-(k-1)+1)}{2}} (X_{i_2} - \hat{q}^{i_2-1}) \cdots (X_{i_k} - \hat{q}^{i_k-k+1}) = X_2 \cdots X_\ell,$$

which becomes (9.10) with $\ell - 1$ after setting $Y_i = X_{i+1}$. Thus, (9.10) follows by induction, which implies the lemma. \square

Below in this subsection we will assume that the u_j 's are pairwise distinct. If (9.6) and (9.7) hold for distinct u_j 's, then when some of the u_j 's coincide the same formulas can be obtained by a simple substitution. Indeed, this is because both sides of each of the identities are a priori rational functions in the u_j 's (cf. footnote²³).

Denote the right-hand side of (9.7) by $R(u_1, \dots, u_n)$. First, let us show that there exists a decomposition of $R(u_1, \dots, u_n)$ into the functions F_λ^c :

Lemma 9.12. *For certain restricted values of the parameters Ξ, S , and u_1, \dots, u_n , and for q sufficiently close to 1, the integral in the right-hand side of (9.7) can be written as*

$$R(u_1, \dots, u_n) = \sum_{\lambda \in \text{Sign}_n^+} r_\lambda F_\lambda^c(u_1, \dots, u_n | \tau_1 \Xi, \tau_1 S), \quad (9.11)$$

where the sum over λ converges uniformly in $u_j \in \gamma_j^+[\Xi S]$, $j = 1, \dots, n$.

Proof. Write the product in (9.7) as a sum over $\mu \in \text{Sign}_n^+$ using the Cauchy identity (Corollary 4.13):

$$\prod_{i=1}^{\ell} \prod_{j=1}^n \frac{1 - qu_j w_i}{1 - u_j w_i} = \frac{1}{(s_0^2; q)_n} \prod_{i=1}^n \frac{1 - \xi_0 s_0 u_i}{1 - \xi_0 s_0^{-1} u_i} \sum_{\mu \in \text{Sign}_n^+ : \mu_n \geq 1} F_\mu^c(u_1, \dots, u_n | \Xi, S) G_\mu(\boldsymbol{\rho}, w_1, \dots, w_\ell | \bar{\Xi}, S), \quad (9.12)$$

where we also used the specialization $\boldsymbol{\rho}$ (6.14) and Proposition 8.2. This is possible if $(u_i, w_j) \in \text{Adm}_{\Xi, \mathbf{S}}$ for all i, j , and the u_i 's satisfy (8.2). These conditions can be achieved by restricting the parameters u_i , Ξ , and \mathbf{S} , and deforming the contour $\gamma[\bar{\mathbf{u}}]$ similarly to the proofs of Theorem 7.7 and Proposition 8.11 (all the $\xi_j s_j^{-1}$'s should be close together, and the u_i^{-1} 's should be close to these points). The integrand in (9.7) is regular at each $\xi_x s_x^{-1}$, so the w_j -contour $\gamma[\bar{\mathbf{u}}]$ can be deformed to $\gamma[\Xi \bar{\mathbf{S}}]$. Note that we do not need to restrict the parameter q yet, because the w_j 's lie on the same contour.

Now for the restricted $\{u_i\}$, Ξ , and \mathbf{S} , the sum over μ in (9.12) converges uniformly in w_i belonging to the deformed contours $\gamma[\Xi \bar{\mathbf{S}}]$. Thus, the integration in the w_j 's can be performed for each μ separately. These integrals involving $\mathbf{G}_\mu(\boldsymbol{\rho}, w_1, \dots, w_\ell | \Xi, \mathbf{S})$ obviously do not introduce any new dependence on the u_i 's. Therefore, the right-hand side of (9.12) depends on the u_i 's only through $\mathbf{F}_{\mu-1}^c(u_1, \dots, u_n | \tau_1 \Xi, \tau_1 \mathbf{S})$ (cf. (4.26)), which yields expansion (9.11).

It remains to show the uniform convergence of (9.11) in $u_j \in \gamma_j^+[\Xi \bar{\mathbf{S}}]$. We see that the coefficients in (9.11) have the form

$$r_{\mu-1^n} = \frac{(-1)^\ell (-s_0)^n q^{\frac{\ell(\ell-1)}{2}}}{(s_0^2; q)_n} \oint_{\gamma[\Xi \bar{\mathbf{S}}]} \frac{dw_1}{2\pi i} \cdots \oint_{\gamma[\Xi \bar{\mathbf{S}}]} \frac{dw_\ell}{2\pi i} \prod_{1 \leq \alpha < \beta \leq \ell} \frac{w_\alpha - w_\beta}{w_\alpha - qw_\beta} \\ \times \mathbf{G}_\mu(\boldsymbol{\rho}, w_1, \dots, w_\ell | \Xi, \mathbf{S}) \prod_{i=1}^{\ell} \left(w_i^{-1} \prod_{j=1}^{x_i-1} \frac{\xi_j - s_j w_i}{\xi_j - s_j^{-1} w_i} \right).$$

One can see that these coefficients grow in μ not faster than of order $\exp\{c|\mu|\}$ for some constant $c > 0$. To ensure uniform convergence one thus needs estimates of the form $\left| \frac{u_i - \xi_x^{-1} s_x}{u_i - \xi_x^{-1} s_x^{-1}} \right| < c_1 < 1$, that is, the points u_i must be close to the $\xi_x^{-1} s_x$'s and on the contours $\gamma_i^+[\Xi \bar{\mathbf{S}}]$ at the same time. This can be achieved by restricting the parameters Ξ and \mathbf{S} further if necessary, and also by taking q sufficiently close to 1, so that the contours $\gamma_i^+[\Xi \bar{\mathbf{S}}]$ are sufficiently close to the $\xi_x^{-1} s_x$'s. \square

The integral formula for the coefficients r_λ in the proof of the above lemma does not seem to be convenient for their direct computation. We will instead rewrite $R(u_1, \dots, u_n)$ by integrating over the w_i 's in (9.7), and then employ orthogonality of the functions \mathbf{F}_λ to extract the r_λ 's. This will imply that $R(u_1, \dots, u_n)$ is equal to the left-hand side of (9.7), yielding Theorem 9.8.

The integral in (9.7) can be computed by taking residues at $w_i = u_{\sigma(i)}^{-1}$ for all $i = 1, \dots, \ell$, where σ runs over all maps $\{1, \dots, \ell\} \rightarrow \{1, \dots, n\}$ (we will see below that other residues do not participate). Denote the residue corresponding to σ by Res_σ , and also denote $\mathcal{J} := \sigma(\{1, \dots, \ell\})$. Because of the factors $w_\alpha - w_\beta$, the same $u_{\sigma(i)}^{-1}$ cannot participate twice, so σ must be injective. Thus, in contrast with (9.6), the integral in the right-hand side of (9.7) vanishes if $\ell > n$. Note however that since $\mathfrak{h}_\nu(x) \leq n$ for all $x \in \mathbb{Z}_{\geq 1}$, the product in the left-hand side also vanishes for $\ell > n$, as it should be. Therefore, it suffices to consider only the case $\ell \leq n$.

The integral in (9.7) can be written in the form

$$(-1)^\ell q^{\frac{\ell(\ell-1)}{2}} \oint_{\gamma[\bar{\mathbf{u}}]} \frac{dw_1}{2\pi i} \cdots \oint_{\gamma[\bar{\mathbf{u}}]} \frac{dw_\ell}{2\pi i} \prod_{1 \leq \alpha < \beta \leq \ell} \frac{w_\alpha - w_\beta}{w_\alpha - qw_\beta} \prod_{i=1}^{\ell} \left(f_{x_i}(w_i; \sigma) \prod_{j=1}^{\ell} \frac{1 - qu_{\sigma(j)} w_i}{1 - u_{\sigma(j)} w_i} \right),$$

with

$$f_x(w; \sigma) := w^{-1} \prod_{j=1}^{x-1} \frac{\xi_j - s_j w}{\xi_j - s_j^{-1} w} \prod_{j \notin \mathcal{J}} \frac{1 - qu_j w}{1 - u_j w}.$$

Taking residues at $w_1 = u_{\sigma(1)}^{-1}, \dots, w_\ell = u_{\sigma(\ell)}^{-1}$ (in this order), we see that

$$\begin{aligned}
\text{Res}_\sigma &= q^{\frac{\ell(\ell-1)}{2}} f_{x_1}(u_{\sigma(1)}^{-1}; \sigma) \frac{1-q}{u_{\sigma(1)}} (-1)^{\ell-1} \prod_{j=2}^{\ell} \frac{u_{\sigma(1)} - qu_{\sigma(j)}}{u_{\sigma(1)} - u_{\sigma(j)}} \\
&\quad \times \text{Res}_{w_\ell = u_{\sigma(\ell)}^{-1}} \dots \text{Res}_{w_2 = u_{\sigma(2)}^{-1}} \prod_{2 \leq \alpha < \beta \leq \ell} \frac{w_\alpha - w_\beta}{w_\alpha - qw_\beta} \prod_{i=2}^{\ell} \left(f_{x_i}(w_i; \sigma) \prod_{j=2}^{\ell} \frac{1 - qu_{\sigma(j)} w_i}{1 - u_{\sigma(j)} w_i} \right) \\
&= q^{\frac{\ell(\ell-1)}{2}} f_{x_1}(u_{\sigma(1)}^{-1}; \sigma) f_{x_2}(u_{\sigma(2)}^{-1}; \sigma) \frac{(1-q)^2}{u_{\sigma(1)} u_{\sigma(2)}} (-1)^{\ell-2} \prod_{j=2}^{\ell} \frac{u_{\sigma(1)} - qu_{\sigma(j)}}{u_{\sigma(1)} - u_{\sigma(j)}} \prod_{j=3}^{\ell} \frac{u_{\sigma(2)} - qu_{\sigma(j)}}{u_{\sigma(2)} - u_{\sigma(j)}} \\
&\quad \times \text{Res}_{w_\ell = u_{\sigma(\ell)}^{-1}} \dots \text{Res}_{w_3 = u_{\sigma(3)}^{-1}} \prod_{3 \leq \alpha < \beta \leq \ell} \frac{w_\alpha - w_\beta}{w_\alpha - qw_\beta} \prod_{i=3}^{\ell} \left(f_{x_i}(w_i; \sigma) \prod_{j=3}^{\ell} \frac{1 - qu_{\sigma(j)} w_i}{1 - u_{\sigma(j)} w_i} \right) \\
&= \text{etc.} \\
&= (1-q)^\ell q^{\frac{\ell(\ell-1)}{2}} \prod_{i=1}^{\ell} \frac{f_{x_i}(u_{\sigma(i)}^{-1}; \sigma)}{u_{\sigma(i)}} \prod_{1 \leq \alpha < \beta \leq \ell} \frac{u_{\sigma(\alpha)} - qu_{\sigma(\beta)}}{u_{\sigma(\alpha)} - u_{\sigma(\beta)}} \\
&= (1-q)^\ell q^{\frac{\ell(\ell-1)}{2}} \prod_{i=1}^{\ell} \prod_{j=1}^{x_i-1} \frac{\xi_j u_{\sigma(i)} - s_j}{\xi_j u_{\sigma(i)} - s_j^{-1}} \prod_{\alpha \in \mathcal{J}, \beta \notin \mathcal{J}} \frac{u_\alpha - qu_\beta}{u_\alpha - u_\beta} \prod_{1 \leq \alpha < \beta \leq \ell} \frac{u_{\sigma(\alpha)} - qu_{\sigma(\beta)}}{u_{\sigma(\alpha)} - u_{\sigma(\beta)}}.
\end{aligned}$$

In particular, we see that each step does not introduce any new poles inside the integration contours besides u_j^{-1} . Therefore,

$$R(u_1, \dots, u_n) = \sum_{\sigma: \{1, \dots, \ell\} \rightarrow \{1, \dots, n\}} \text{Res}_\sigma(u_1, \dots, u_n), \quad (9.13)$$

with Res_σ as above. This identity clearly holds for generic complex u_1, \dots, u_n (and not only for $u_i > 0$) because both sides are rational functions in the u_i 's.

Let us now apply the inverse Plancherel transform \mathcal{J} of Definition 7.9 (but without the factor $c_5(\lambda)$) and with the shifted parameters $\tau_1 \Xi, \tau_1 \mathbf{S}$ to $R(u_1, \dots, u_n)$ to recover the coefficients r_λ in (9.11). This is possible under the restrictions of Lemma 9.12 because the series in the right-hand side of (9.11) converges uniformly in the u_i 's on the contours involved in \mathcal{J} . The application of this slightly modified transform to $R(u_1, \dots, u_n)$ written as (9.13) can be performed separately for each σ , and the result is the following:

Lemma 9.13. *Under (5.1) and (7.4), for any $\sigma: \{1, \dots, \ell\} \rightarrow \{1, \dots, n\}$ and $\lambda \in \text{Sign}_n^+$, we have*

$$\begin{aligned}
(1-q)^{-n} \oint_{\gamma_1^+[\Xi \mathbf{S}]} \frac{du_1}{2\pi i} \dots \oint_{\gamma_n^+[\Xi \mathbf{S}]} \frac{du_n}{2\pi i} \prod_{1 \leq \alpha < \beta \leq n} \frac{u_\alpha - u_\beta}{u_\alpha - qu_\beta} \text{Res}_\sigma(u_1, \dots, u_n) \prod_{i=1}^n u_i^{-1} \varphi_{\lambda_i}(u_i^{-1} | \tau_1 \Xi, \tau_1 \mathbf{S}) \\
= \mathbf{1}_{\{\lambda_{\sigma(i)} \geq x_i - 1 \text{ for all } i\}} \cdot (-\tau_1 \mathbf{S})^\lambda q^{\text{inv}(\sigma)} q^{\sigma(1) + \dots + \sigma(\ell)} q^{-\ell} (1-q)^\ell. \quad (9.14)
\end{aligned}$$

Here the integration contours are described in Definition 7.2, and $\text{inv}(\sigma)$ is the number of inversions in σ , i.e., the number of pairs (i, j) with $i < j$ and $\sigma(i) > \sigma(j)$.

Proof. We need to compute

$$\oint_{\gamma_1^+[\Xi \mathbf{S}]} \frac{du_1}{2\pi i} \dots \oint_{\gamma_n^+[\Xi \mathbf{S}]} \frac{du_n}{2\pi i} \prod_{1 \leq \alpha < \beta \leq n} \frac{u_\alpha - u_\beta}{u_\alpha - qu_\beta} \prod_{\alpha \in \mathcal{J}, \beta \notin \mathcal{J}} \frac{u_\alpha - qu_\beta}{u_\alpha - u_\beta} \prod_{1 \leq \alpha < \beta \leq \ell} \frac{u_{\sigma(\alpha)} - qu_{\sigma(\beta)}}{u_{\sigma(\alpha)} - u_{\sigma(\beta)}}$$

$$\times \prod_{i=1}^{\ell} \left(u_{\sigma(i)}^{-1} \varphi_{\lambda_{\sigma(i)}}(u_{\sigma(i)}^{-1} | \tau_1 \bar{\Xi}, \tau_1 \mathbf{S}) \prod_{j=1}^{x_i-1} \frac{\xi_j u_{\sigma(i)} - s_j}{\xi_j u_{\sigma(i)} - s_j^{-1}} \right) \prod_{\beta \notin \mathcal{J}} u_{\beta}^{-1} \varphi_{\lambda_{\beta}}(u_{\beta}^{-1} | \tau_1 \bar{\Xi}, \tau_1 \mathbf{S}).$$

Observe the following:

- The product $\prod_{j=1}^{x_i-1} \frac{\xi_j u_{\sigma(i)} - s_j}{\xi_j u_{\sigma(i)} - s_j^{-1}}$, $x_i \geq 1$, has zeros at $u_{\sigma(i)} = s_j \xi_j^{-1}$ for $j = 1, \dots, x_i - 1$, and poles at $u_{\sigma(i)} = s_j^{-1} \xi_j^{-1}$ for $j = 1, \dots, x_i - 1$.
- The term $u_{\sigma(i)}^{-1} \varphi_{\lambda_{\sigma(i)}}(u_{\sigma(i)}^{-1} | \tau_1 \bar{\Xi}, \tau_1 \mathbf{S})$, $\lambda_{\sigma(i)} \geq 0$, has zeros at $u_{\sigma(i)} = s_j^{-1} \xi_j^{-1}$ for $j = 1, \dots, \lambda_{\sigma(i)}$, and poles at $u_{\sigma(i)} = s_j \xi_j^{-1}$ for $j = 1, \dots, \lambda_{\sigma(i)} + 1$.

This implies that the following cancellations of poles:

- If $x_i \geq \lambda_{\sigma(i)} + 2$, then the integrand does not have poles $s_j \xi_j^{-1}$ inside the contour $\gamma_{\sigma(i)}^+[\bar{\Xi} \mathbf{S}]$. In this case, if we can shrink this contour without picking residues at $u_{\sigma(i)} = qu_{\beta}$ for any $\beta > \sigma(i)$, then the whole integral vanishes.
- If $x_i \leq \lambda_{\sigma(i)} + 1$, then the integrand does not have poles $s_j^{-1} \xi_j^{-1}$ outside the contour $\gamma_{\sigma(i)}^+[\bar{\Xi} \mathbf{S}]$. Note also that for $\beta \notin \mathcal{J}$, the integrand also does not have poles $s_j^{-1} \xi_j^{-1}$ outside the contour $\gamma_{\beta}^+[\bar{\Xi} \mathbf{S}]$. The integrand, however, has simple poles at each $u_i = \infty$.

If $\sigma(i) > \max(\sigma(1), \dots, \sigma(i-1))$ is a running maximum, then the contour $\gamma_{\sigma(i)}^+[\bar{\Xi} \mathbf{S}]$ can be shrunk without picking residues at $u_{\sigma(i)} = qu_{\beta}$. Indeed, the factors $u_{\sigma(i)} - qu_{\beta}$ in the denominator with $\beta \notin \mathcal{J}$ are canceled out by the product over $\alpha \in \mathcal{J}$ and $\beta \notin \mathcal{J}$, and all the factors $u_{\sigma(i)} - qu_{\sigma(j)}$ with $\sigma(i) < \sigma(j)$ are present in the other product over $1 \leq \alpha < \beta \leq \ell$. Therefore, the whole integral vanishes unless $x_i \leq \lambda_{\sigma(i)} + 1$ for each such running maximum $\sigma(i)$.

Next, if the latter condition holds, then we also have $x_j \leq \lambda_{\sigma(j)} + 1$ for all $j = 1, \dots, \ell$. Indeed, if $\sigma(j)$ is not a running maximum, then there exists $i < j$ with $\sigma(i) > \sigma(j)$ (as $\sigma(i)$ we can take the previous running maximum), and it remains to recall that both the λ_p 's and the x_p 's are ordered:

$$x_j \leq x_i \leq \lambda_{\sigma(i)} + 1 \leq \lambda_{\sigma(j)} + 1.$$

Assuming now that $x_j \leq \lambda_{\sigma(j)} + 1$ for all j , we can expand the contours $\gamma_1^+[\bar{\Xi} \mathbf{S}], \dots, \gamma_n^+[\bar{\Xi} \mathbf{S}]$ (in this order) to infinity, and evaluate the integral by taking minus residues at that point. The single products over $i = 1, \dots, \ell$ and $\beta \notin \mathcal{J}$ produce the factor $(1 - q)^n (-\tau_1 \mathbf{S})^\lambda$. Let the ordered sequence of elements of \mathcal{J} be $\mathcal{J} = \{j_1 < \dots < j_\ell\}$. One can readily see that the three remaining cross-products lead to the factor

$$q^{\text{inv}(\sigma)} q^{\ell(j_1-1) + (\ell-1)(j_2-j_1-1) + \dots + (j_\ell-j_{\ell-1}-1)} = q^{\text{inv}(\sigma)} q^{j_1 + \dots + j_\ell} q^{-\frac{\ell(\ell+1)}{2}}.$$

This completes the proof. \square

The coefficient r_λ in (9.11) is thus equal to the sum of the right-hand sides of (9.14) over all $\sigma: \{1, \dots, \ell\} \rightarrow \{1, \dots, n\}$. This sum can be computed using the following lemma:

Lemma 9.14. *Let X_1, X_2, \dots be indeterminates, $k \in \mathbb{Z}_{\geq 1}$, and $n_1, \dots, n_k \in \mathbb{Z}_{\geq 1}$ be arbitrary. We have the following identity:*

$$\sum_{\substack{1 \leq i_1 \leq n_1, \dots, 1 \leq i_k \leq n_k \\ (i_1, \dots, i_k) \text{ pairwise distinct}}} X_{i_1} X_{i_2 + \text{inv}_{\leq 2}} \dots X_{i_k + \text{inv}_{\leq k}} \\ = (X_1 + \dots + X_{n_1})(X_2 + \dots + X_{n_2}) \dots (X_k + \dots + X_{n_k}),$$

where $\text{inv}_{\leq p} := \#\{j < p: i_j > i_p\}$. By agreement, the right-hand side is zero if one of the sums is empty.

Proof. It suffices to show that the map

$$(i_1, \dots, i_k) \mapsto (i_1, i_2 + \text{inv}_{\leq 2}, \dots, i_k + \text{inv}_{\leq k})$$

is a bijection between the sets

$$\{1 \leq i_1 \leq n_1, \dots, 1 \leq i_k \leq n_k, (i_1, \dots, i_k) \text{ pairwise distinct}\} \\ \text{and } \{1 \leq j_1 \leq n_1, 2 \leq j_2 \leq n_2, \dots, k \leq j_k \leq n_k\}.$$

By induction, this statement will follow if we show that for any pairwise distinct $1 \leq i_1, \dots, i_{k-1} \leq n_{k-1}$, the map $i_k \mapsto i_k + \text{inv}_{\leq k}$ is a bijection between

$$\{1 \leq j \leq n_k : j \notin \{i_1, \dots, i_{k-1}\}\} \quad \text{and} \quad \{k, k+1, \dots, n_k\}.$$

But the latter fact is evident from Fig. 29, as the map $i_k \mapsto i_k + \text{inv}_{\leq k}$ simply corresponds to stacking

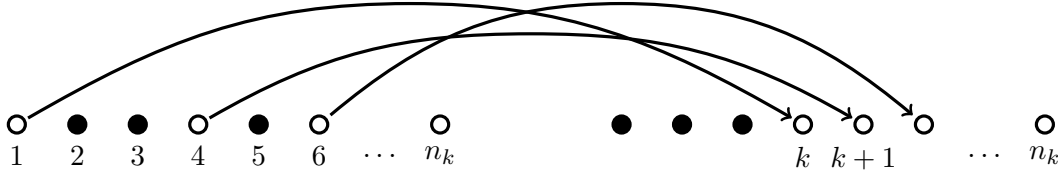

FIGURE 29. A bijection used in the proof of Lemma 9.14.

together the elements of $\{1 \leq j \leq n_k : j \notin \{i_1, \dots, i_{k-1}\}\}$. \square

By Lemma 9.13, the right-hand side of (9.14) takes the form

$$r_\lambda = q^{-\ell}(1-q)^\ell (-\tau_1 \mathbf{S})^\lambda \sum_{\substack{\sigma(1), \dots, \sigma(\ell) \in \{1, \dots, n\} \\ \text{pairwise distinct}}} q^{\sigma(1) + \dots + \sigma(\ell) + \text{inv}(\sigma)} \mathbf{1}_{\lambda_{\sigma(i)} \geq x_i - 1 \text{ for all } i} \\ = q^{-\ell}(1-q)^\ell (-\tau_1 \mathbf{S})^\lambda \sum_{\substack{1 \leq \sigma(1) \leq \mathfrak{h}_\lambda(x_1-1), \dots, 1 \leq \sigma(\ell) \leq \mathfrak{h}_\lambda(x_\ell-1) \\ \text{pairwise distinct}}} q^{\sigma(1) + \dots + \sigma(\ell) + \text{inv}(\sigma)},$$

where we have recalled that the height function is defined as $\mathfrak{h}_\lambda(x-1) = \max\{j : \lambda_j \geq x-1\}$. We can now apply Lemma 9.14 with $X_i = q^i$, and conclude that the above sum factorizes as

$$r_\lambda = q^{-\ell}(1-q)^\ell (-\tau_1 \mathbf{S})^\lambda \prod_{i=1}^{\ell} (q^i + q^2 + \dots + q^{\mathfrak{h}_\lambda(x_i-1)}) = (-\tau_1 \mathbf{S})^\lambda \prod_{i=1}^{\ell} (q^{i-1} - q^{\mathfrak{h}_\lambda(x_i-1)}). \quad (9.15)$$

Therefore, we have finally computed the right-hand side of (9.7), and it is equal to

$$\sum_{\lambda \in \text{Sign}_n^+} (-\tau_1 \mathbf{S})^\lambda \mathbf{F}_\lambda^c(u_1, \dots, u_n \mid \tau_1 \Xi, \tau_1 \mathbf{S}) \prod_{i=1}^{\ell} (q^{i-1} - q^{\mathfrak{h}_\lambda(x_i-1)}) = \sum_{\lambda \in \text{Sign}_n^+} \prod_{i=1}^{\ell} (q^{i-1} - q^{\mathfrak{h}_\lambda(x_i)}) \mathcal{M}_{\mathbf{u}; \varrho}(\lambda \mid \Xi, \mathbf{S}) \quad (9.16)$$

(because $\mathcal{M}_{\mathbf{u}; \varrho}$ is given by (8.1)), which is the same as the left-hand side of (9.7) by the very definition. Identity (9.7) is thus established under the restrictions of Lemma 9.12. However, as both sides of this identity are rational functions in all the variables and parameters (cf. Lemma 9.1 for the left-hand side and formula (9.13) for the right-hand side), we conclude that these restrictions can be dropped as long as the sum over λ in (9.16) converges. This implies Theorem 9.8.

10. DEGENERATIONS OF MOMENT FORMULAS

Here we apply q -moment formulas from §9 to rederive q -moment formulas for the stochastic six vertex model, the ASEP, q -Hahn, and q -Boson systems obtained earlier in the literature (see references below). In some cases we also present their inhomogeneous generalizations.

10.1. Moment formulas for the stochastic six vertex model and the ASEP. Recall the stochastic six vertex model described in §6.5. That is, we take the parameters $\mathfrak{s}_x \equiv q^{-\frac{1}{2}}$ for all $x \in \mathbb{Z}_{\geq 0}$, and consider the dynamics $\mathcal{X}_{\{u_t\};\mathfrak{g}}^+$ in which at each discrete time step, a new particle is born at location 1 (§6.4). For this dynamics to be an honest Markov process (i.e., with nonnegative transition probabilities), we require that all other parameters satisfy

$$0 < q < 1, \quad \xi_j > 0, \quad u_i > 0, \quad \text{and} \quad \xi_j u_i > q^{-\frac{1}{2}} \text{ for all } i, j, \quad (10.1)$$

and that the ξ_j 's are uniformly bounded away from 0 and ∞ . (Another range with $q > 1$ will lead to a trivial limit shape for the stochastic six vertex model, see the discussion in §6.5.)

Corollary 10.1. *Assume that (10.1) holds, and that the ξ_j 's satisfy $q \cdot M_{\Xi} < m_{\Xi}$ (we use notation (7.3)). Moreover, let $u_i \neq qu_j$ for any $i, j = 1, \dots, n$. Then the q -moments of the height function of the inhomogeneous stochastic six vertex model $\mathcal{X}_{\{u_t\};\mathfrak{g}}^+$ at time $= n$ are given by*

$$\begin{aligned} \mathbb{E}_{\mathfrak{u};\mathfrak{g}}^{\text{six vertex}} \prod_{i=1}^{\ell} q^{h_{\nu}(x_i)} &= q^{\frac{\ell(\ell-1)}{2}} \oint_{\gamma[\bar{\mathfrak{u}}|1]} \frac{dw_1}{2\pi\mathfrak{i}} \cdots \oint_{\gamma[\bar{\mathfrak{u}}|\ell]} \frac{dw_{\ell}}{2\pi\mathfrak{i}} \prod_{1 \leq \alpha < \beta \leq \ell} \frac{w_{\alpha} - w_{\beta}}{w_{\alpha} - qw_{\beta}} \\ &\quad \times \prod_{i=1}^{\ell} \left(w_i^{-1} \prod_{j=1}^{x_i-1} \frac{\xi_j - q^{-\frac{1}{2}}w_i}{\xi_j - q^{\frac{1}{2}}w_i} \prod_{j=1}^n \frac{1 - qu_j w_i}{1 - u_j w_i} \right) \end{aligned} \quad (10.2)$$

for any $\ell \in \mathbb{Z}_{\geq 1}$ and $x_1 \geq \dots \geq x_{\ell} \geq 1$. The integration contours above are as in Definition 9.4.

In the homogeneous case $u_i \equiv u$, $\xi_j \equiv 1$, this formula essentially reduces to [BCG14, Thm. 4.12] which was proven by a different method.

Proof. The claim follows from Theorem 9.8 because both sides of the identity (9.6) are rational functions in all parameters, and, moreover, the integrations in the right-hand sides of (9.6) and (10.2) are sums over the same sets of residues. Indeed, our conditions (10.1) imply that $u_i^{-1} < \mathfrak{s}^{-1}\xi_j < \mathfrak{s}\xi_j$ (where $\mathfrak{s} = q^{-\frac{1}{2}}$), and so the contours $\gamma[\bar{\mathfrak{u}}|j]$ exist and yield the same residues. Note also that even though now $\mathfrak{s}_j = q^{-1/2} > 1$ instead of belonging to $(-1, 0)$, conditions (8.2) (ensuring the existence of the measure $\mathcal{M}_{\mathfrak{u};\mathfrak{g}}$) readily follow from (10.1). \square

Let us now consider the continuous time limit of the stochastic six vertex model to the ASEP. In §6.5 we have described this limit in the case of a fixed number of particles, but the dynamics $\mathcal{X}_{\{u_t\};\mathfrak{g}}^+$ (in which at each time step a new particle is born at location 1) in this limit also produces a meaningful initial condition for the ASEP. Indeed, setting $\xi_j = 1$, $u_i = q^{-\frac{1}{2}} + (1-q)q^{-\frac{1}{2}}\epsilon$, we see that for $\epsilon = 0$ the configuration $\lambda \in \text{Sign}_n^+$ of the stochastic six vertex model at time $= n$ is simply $\lambda = (n, n-1, \dots, 1)$. For small $\epsilon > 0$, at times $n = \lfloor t\epsilon^{-1} \rfloor$, the configuration of the stochastic six vertex model will be a finite perturbation of $(n, n-1, \dots, 1)$ near the diagonal. Thus, shifting the lattice coordinate as $\lambda_i = n+1+y_i$ with $y_i \in \mathbb{Z}$, we see that in the limit $\epsilon \searrow 0$ the initial condition for the ASEP becomes $y_1(0) = -1$, $y_2(0) = -2, \dots$, which is known as the *step initial configuration*.

Corollary 10.2. *For $0 < q < 1$, any $\ell \in \mathbb{Z}_{\geq 1}$, and $(x_1 \geq \dots \geq x_{\ell}) \in \mathbb{Z}^{\ell}$, the q -moments of the height function of the ASEP $\mathfrak{h}_{\text{ASEP}}(x) := \#\{i : y_i \geq x\}$ started from the step initial configuration $y_i(0) = -i$ are given by*

$$\mathbb{E}^{\text{ASEP, step}} \prod_{i=1}^{\ell} q^{\text{h}_{\text{ASEP}}(x_i)} = q^{\frac{\ell(\ell-1)}{2}} \oint_{\gamma[\sqrt{q}|1]} \frac{dw_1}{2\pi\mathbf{i}} \cdots \oint_{\gamma[\sqrt{q}|\ell]} \frac{dw_\ell}{2\pi\mathbf{i}} \prod_{1 \leq \alpha < \beta \leq \ell} \frac{w_\alpha - w_\beta}{w_\alpha - qw_\beta} \\ \times \prod_{i=1}^{\ell} \left(w_i^{-1} \left(\frac{1 - q^{-\frac{1}{2}} w_i}{1 - q^{\frac{1}{2}} w_i} \right)^{x_i} \exp \left\{ - \frac{(1-q)^2}{(1 - q^{\frac{1}{2}} w_i)(1 - q^{\frac{1}{2}}/w_i)} t \right\} \right), \quad (10.3)$$

for any time $t \geq 0$. Each integration contour $\gamma[\sqrt{q}|j]$ consists of two positively oriented circles – one is a small circle around \sqrt{q} , and another one is a circle $r^j c_0$ around zero as in Definition 9.4.

Proof. Start with the moment formula (10.2) for $\xi_j = 1$, $u_i = q^{-\frac{1}{2}} + (1-q)q^{-\frac{1}{2}}\epsilon$, $x_i = n + 1 + x'_i$, and $n = \lfloor t\epsilon^{-1} \rfloor$. Here $x'_i \in \mathbb{Z}$ are the shifted labels of moments. As $\epsilon \searrow 0$, the contours $\gamma[\bar{\mathbf{u}}|j]$ will still contain the same parts around zero, and the part $\gamma[\bar{\mathbf{u}}]$ encircling the u_i^{-1} 's will turn into a small circle $\gamma[\sqrt{q}]$ around \sqrt{q} (because \sqrt{q} is the limit of u^{-1} as $\epsilon \searrow 0$). Let us now look at the integrand. We have

$$\left(\frac{1 - q^{-\frac{1}{2}} w}{1 - q^{\frac{1}{2}} w} \right)^{x_i - 1} \left(\frac{1 - qw}{1 - w} \right)^n = \left(\frac{1 - q^{-\frac{1}{2}} w}{1 - q^{\frac{1}{2}} w} \right)^{n+x'_i} \left(\frac{1 - q^{\frac{1}{2}} w}{1 - q^{-\frac{1}{2}} w} - \epsilon \frac{(1-q)^2}{(1 - q^{-\frac{1}{2}} w)(1 - q^{\frac{1}{2}}/w)} + O(\epsilon^2) \right)^n \\ = \left(\frac{1 - q^{-\frac{1}{2}} w}{1 - q^{\frac{1}{2}} w} \right)^{x'_i} \left(1 - \epsilon \frac{(1-q)^2}{(1 - q^{\frac{1}{2}} w)(1 - q^{\frac{1}{2}}/w)} + O(\epsilon^2) \right)^{\lfloor t\epsilon^{-1} \rfloor}.$$

In the limit as $\epsilon \searrow 0$, the second factor turns into the exponential. Thus, renaming x'_i back to x_i , we arrive at the desired claim. \square

When $x_1 = \dots = x_\ell$, formula (10.3) essentially coincides with the one obtained in [BCS14, Thm. 4.20] using duality. The multi-point generalization (10.3) of that formula seems to be new.

The paper [BCS14] also deals with other multi-point observables. Namely, denote

$$\tilde{Q}_x := q^{\text{h}_{\text{ASEP}}(x+1)} \mathbf{1}_{\text{there is a particle at location } x}.$$

The expectations $\mathbb{E}^{\text{ASEP}}(\tilde{Q}_{x_1} \dots \tilde{Q}_{x_k})$, $x_1 > \dots > x_k$ (for the step, and in fact also for the step-Bernoulli initial conditions), were computed in [BCS14, Cor. 4.14]. The duality statement pertaining to these observables dates back to [Sch97]. Then the expectation of $q^{\ell \text{h}_{\text{ASEP}}(x)}$ was recovered from these multi-point observables [BCS14, Thm. 4.20].

Note that for the ASEP, expectations of $\tilde{Q}_{x_1} \dots \tilde{Q}_{x_k}$ are essentially the same as the q -correlation functions (§8.4). In fact, our proof of Proposition 9.5 (recovering one-point q -moments from the q -correlation functions) somewhat mimics the ASEP approach mentioned above, but dealing with a higher spin system introduces the need for the more complicated observables (8.12).

10.2. Starting from infinitely many particles at location 1. Let us now return to generic values of \mathbf{s}_j , and consider the limit transition from $\mathcal{X}_{\{u_i\}; \mathbf{g}}^+$ to the dynamics $\mathcal{X}_{\{u_i\}}^\infty$ described in Remark 6.14. Recall that to pass to the dynamics $\mathcal{X}_{\{u_i\}}^\infty$, one should take $\xi_1 = \mathbf{s}_1$, and let the \mathbf{u} parameters be $(1, q, q^2, \dots, q^{K-1}, u_1, \dots, u_n)$. For the process to have nonnegative transition probabilities in the $K \rightarrow +\infty$ limit (and be nontrivial), we should take $\mathbf{s}_1^2 < 0$ and $u_i > 0$, while all other parameters \mathbf{s}_x , ξ_x ($x \geq 2$), and q should satisfy (5.1). Under these assumptions, in the $K \rightarrow +\infty$ limit we obtain Markov dynamics $\mathcal{X}_{\{u_i\}}^\infty$ which starts from the configuration $1^\infty 2^0 3^0 \dots$. Moreover, we also need to assume that the nested integration contours (in the corollary below) are well-defined, which requires $m_{\Xi|S} > qM_{\Xi|S}$.

Corollary 10.3. *Under the assumptions described above, the q -moments of $\mathcal{X}_{\{u_i\}}^\infty$ at time $= n$ have the form*

$$\mathbb{E}_{\mathbf{u}}^{\mathcal{X}^\infty} \prod_{i=1}^{\ell} q^{\text{h}_\nu(x_i)} = (-1)^\ell q^{\frac{\ell(\ell-1)}{2}} \oint_{\gamma_1^+[\Xi S]} \frac{dw_1}{2\pi\mathbf{i}} \cdots \oint_{\gamma_\ell^+[\Xi S]} \frac{dw_\ell}{2\pi\mathbf{i}} \prod_{1 \leq \alpha < \beta \leq \ell} \frac{w_\alpha - w_\beta}{w_\alpha - qw_\beta}$$

$$\times \prod_{i=1}^{\ell} \left(\frac{1}{w_i(1-w_i)} \prod_{j=1}^{x_i-1} \frac{\xi_j - \mathfrak{s}_j w_i}{\xi_j - \mathfrak{s}_j^{-1} w_i} \prod_{j=1}^n \frac{1 - qu_j w_i}{1 - u_j w_i} \right), \quad (10.4)$$

where $\text{time} = n$, $\ell \in \mathbb{Z}_{\geq 1}$, and $x_1 \geq \dots \geq x_\ell \geq 1$ are arbitrary. The integration contours $\gamma_j^+[\Xi\mathfrak{S}]$ are q -nested (as in Definition 7.2), encircle $\{\mathfrak{s}_1^2, \xi_2 \mathfrak{s}_2, \dots\}$, and leave outside 0, 1, and u_i^{-1} for all i . We also assume that $\xi_1 = \mathfrak{s}_1$ in (10.4).

Note that if $x_\ell = 1$, then the integrand has no w_ℓ -poles inside the smallest contour $\gamma_\ell^+[\Xi\mathfrak{S}]$, and thus vanishes, as it should be for the left-hand side of (10.4) because $\mathfrak{h}_\nu(1) = +\infty$.

Proof. Since before the limit the parameters \mathbf{u} have the form (8.17), we must use Corollary 9.9 instead of Theorem 9.8, and take the integration contours to be $\gamma_j^-[\bar{\mathbf{u}}|j]$, $j = 1, \dots, \ell$. After setting $\xi_1 = \mathfrak{s}_1$ with $\mathfrak{s}_1^2 < 0$, the integration contours $\gamma_j^-[\bar{\mathbf{u}}|j]$ are q^{-1} -nested around $\{1, u_1^{-1}, \dots, u_n^{-1}\}$, leave $\{\mathfrak{s}_1^2, \xi_2 \mathfrak{s}_2, \dots\}$ outside, and contain parts $r^j c_0$ around zero (cf. Definition 9.4). This readily implies that the substitution $\xi_1 = \mathfrak{s}_1$ is allowed because the resulting integral is the sum of the same residues as before the substitution.

Now, since the integration contours do not change in the limit as $K \rightarrow +\infty$, let us take it in the integrand. Then the product over $i = 1, \dots, \ell$ becomes

$$\prod_{i=1}^{\ell} \left(\frac{1}{w_i(1-w_i)} \prod_{j=1}^{x_i-1} \frac{\xi_j - \mathfrak{s}_j w_i}{\xi_j - \mathfrak{s}_j^{-1} w_i} \prod_{j=1}^n \frac{1 - qu_j w_i}{1 - u_j w_i} \right).$$

We see that the integrand for $K = +\infty$ is regular at infinity, so we can drag the integration contours $\gamma_\ell^-[\bar{\mathbf{u}}|\ell], \dots, \gamma_1^-[\bar{\mathbf{u}}|1]$ (in this order) through infinity, and they turn into q -nested and negatively oriented contours $\gamma_j^+[\Xi\mathfrak{S}]$ around $\{\mathfrak{s}_1^2, \xi_2 \mathfrak{s}_2, \dots\}$, which leave $\{u_1^{-1}, \dots, u_n^{-1}\}$, 0 and 1 outside. Note that the first group of points lies in the left half-plane, while $u_i^{-1} > 0$.

In the proof we have assumed (7.4), so that the contours $\gamma_j^-[\bar{\mathbf{u}}|j]$ are well-defined. However, this assumption can be dropped in (10.4) because both sides of (10.4) are a priori rational functions in all parameters. This implies the desired claim. \square

In the homogeneous case $\xi_j \equiv 1$ and $\mathfrak{s}_j \equiv \mathfrak{s}$, the result of Corollary 10.3 was obtained in [CP15, Thm. 4.1] using duality. More precisely, to obtain the system considered in that paper, one needs to take $\mathfrak{s}_1^2 = \mathfrak{s}$ and $\mathfrak{s}_j \equiv \mathfrak{s}$ for $j \geq 2$, so that the probabilities with which particles leave location 1 are in agreement with what is going on at all further locations.

10.3. Moment formulas for q -Hahn and q -Boson systems. As explained in §6.6.2, the q -Hahn particle system $\mathcal{X}_{q\text{-Hahn}}^\infty$ depending on $J \in \mathbb{Z}_{\geq 1}$ is obtained from the process $\mathcal{X}_{\{u_t\}}^\infty$ by fusion

$$\mathbf{u} = (1, q, \dots, q^{J-1}, \dots, 1, q, \dots, q^{J-1}) \quad (n \text{ groups})$$

and by setting $\mathfrak{s}_j = \xi_j$ for all $j \in \mathbb{Z}_{\geq 2}$, with $\mathfrak{s}_j^2 < 0$. The process $\mathcal{X}_{q\text{-Hahn}}^\infty$ also starts with infinitely many particles at 1.

Corollary 10.4. *Let $J \in \mathbb{Z}_{\geq 1}$ and $\mathfrak{s}_j^2 < 0$ for all j . Moreover, let us assume that $m_{|\mathfrak{S}^2|} > qM_{|\mathfrak{S}^2|}$, so the integration contours below exist. Then for any $\ell \in \mathbb{Z}_{\geq 1}$ and $x_1 \geq \dots \geq x_\ell \geq 1$, the moments of $\mathcal{X}_{q\text{-Hahn}}^\infty$ at time = n have the form:*

$$\begin{aligned} \mathbb{E}^{q\text{-Hahn}} \prod_{i=1}^{\ell} q^{\mathfrak{h}_\nu(x_i)} &= (-1)^\ell q^{\frac{\ell(\ell-1)}{2}} \oint_{\gamma_1^+[\mathfrak{S}^2]} \frac{dw_1}{2\pi\mathbf{i}} \dots \oint_{\gamma_\ell^+[\mathfrak{S}^2]} \frac{dw_\ell}{2\pi\mathbf{i}} \prod_{1 \leq \alpha < \beta \leq \ell} \frac{w_\alpha - w_\beta}{w_\alpha - qw_\beta} \\ &\times \prod_{i=1}^{\ell} \left(\left(\frac{1 - q^J w_i}{1 - w_i} \right)^n \frac{1}{w_i(1-w_i)} \prod_{j=1}^{x_i-1} \frac{1 - w_i}{1 - \mathfrak{s}_j^{-2} w_i} \right), \quad (10.5) \end{aligned}$$

where the integration contours $\gamma_j^+[\mathbb{S}^2]$ are q -nested around $\{\mathfrak{s}_j^2\}_{j \in \mathbb{Z}_{\geq 1}}$ and leave 0 and 1 outside.

Proof. Immediately follows from Corollary 10.3. \square

The q -moment formula (10.5) holds when $J \in \mathbb{Z}_{\geq 1}$ and $\mathfrak{s}_x^2 < 0$ for all x (case 2 in (6.20)), but can be also analytically continued to other values of parameters. For example, (10.5) also holds when $0 < q < 1$, q^J is regarded as an independent parameter, $\mathfrak{s}_x^2 < q^J \mathfrak{s}_x^2 < 1$ and $q^J \mathfrak{s}_x^2 > 0$ for all x (case 1 in (6.20)), and, moreover, $m_{|\mathbb{S}^2|} > qM_{|\mathbb{S}^2|}$ holds. Since $0 \neq \mathfrak{s}_x^2 < 1$, we see that the contours $\gamma_j^+[\mathbb{S}^2]$ leaving 0 and 1 outside also make sense in this case.

In the homogeneous case $\mathfrak{s}_j \equiv \mathfrak{s}$, q -moments (10.5) of the q -Hahn process were computed in [Cor14] using duality (cf. the discussion in §8.5). An inhomogeneous generalization of this duality (which differs from the inhomogeneity considered in (10.5)) was also written down in that paper. Namely, returning to the notation of Remark 6.13, consider the q -Hahn TASEP in which each particle x_j jumps according to the distribution $\varphi_{q, \mu_j, \nu_j}(\cdot | \text{gap}_j)$. When the parameters $\nu_j \equiv \nu$ are homogeneous and the μ_j 's are arbitrary, duality relations for this process were obtained in [Cor14]. However, the corresponding evolution equations were solved (yielding contour integral formulas for observables) in [Cor14] only when the parameters $\mu_j \equiv \mu$ are also homogeneous. The remaining case when the ν_j 's are homogeneous and the μ_j 's are not does not seem to fall under our framework. Corollary 10.4 provides another ‘‘solvable’’ case of the inhomogeneous q -Hahn TASEP, when both the ν_j 's and the μ_j 's are inhomogeneous, but $\mu_j/\nu_j \equiv q^J = \text{const}$.

Let us now turn to the stochastic q -Boson system which is obtained from the q -Hahn process by setting $J = 1$ and $\mathfrak{s}_j^2 = -\epsilon a_j$ with $a_j > 0$, and speeding up the time by a factor of ϵ^{-1} (see §6.6.3). For the nested contours in the corollary below to make sense, we must also require that $\min\{a_i\} < q \cdot \max\{a_i\}$.

Corollary 10.5. *Under the above assumptions, the q -moments of the height function of the q -Boson process (started with infinitely many particles at 1) have the form*

$$\mathbb{E}^{q\text{-Boson}} \prod_{i=1}^{\ell} q^{h_{\nu}(x_i)} = (-1)^{\ell} q^{\frac{\ell(\ell-1)}{2}} \oint_{\gamma_1^+[-\mathbf{a}]} \frac{dw_1}{2\pi\mathbf{i}} \cdots \oint_{\gamma_{\ell}^+[-\mathbf{a}]} \frac{dw_{\ell}}{2\pi\mathbf{i}} \prod_{1 \leq \alpha < \beta \leq \ell} \frac{w_{\alpha} - w_{\beta}}{w_{\alpha} - qw_{\beta}} \times \prod_{i=1}^{\ell} \left(\frac{e^{(1-q)tw_i}}{w_i} \prod_{j=1}^{x_i-1} \frac{a_j}{a_j + w_i} \right), \quad (10.6)$$

where $t \geq 0$ is the time and $\ell \in \mathbb{Z}_{\geq 1}$ and $x_1 \geq x_2 \geq \dots \geq x_{\ell} \geq 1$ are arbitrary. The integration contours $\gamma_j^+[-\mathbf{a}]$ are q -nested around the points $\{-a_i\}$, and do not contain 0.

Proof. Set $J = 1$, $\mathfrak{s}_j^2 = -\epsilon a_j$, and $n = \lfloor t\epsilon^{-1} \rfloor$ in (10.5), and change the variables as $w_i = \epsilon w'_i$. Then the integral in (10.5) becomes

$$\oint_{\gamma_1^+[-\mathbf{a}]} \frac{dw'_1}{2\pi\mathbf{i}} \cdots \oint_{\gamma_{\ell}^+[-\mathbf{a}]} \frac{dw'_{\ell}}{2\pi\mathbf{i}} \prod_{1 \leq \alpha < \beta \leq \ell} \frac{w'_{\alpha} - w'_{\beta}}{w'_{\alpha} - qw'_{\beta}} \prod_{i=1}^{\ell} \left(\left(\frac{1 - q\epsilon w'_i}{1 - \epsilon w'_i} \right)^{\lfloor t\epsilon^{-1} \rfloor} \frac{1}{w'_i(1 - \epsilon w'_i)} \prod_{j=1}^{x_i-1} \frac{1 - \epsilon w'_i}{1 + w'_i/a_j} \right).$$

Sending $\epsilon \searrow 0$ and renaming w'_i back to w_i , we arrive at the desired formula. \square

The continuous time moment formula (10.6) first appeared in [BC14] and [BCS14]. Analogous formulas for discrete time q -TASEPs (corresponding to discrete time q -Boson systems as in §6.6) were obtained in [BC13], and they can also be derived from the q -Hahn moment formula (10.5).

It is worth noting that a recent paper [WW15] contains a formula for transition probabilities of the inhomogeneous q -Boson system, which is essentially equivalent to the q -Boson version of the first Plancherel isomorphism of Theorem 7.11.

REFERENCES

- [Bax07] R. Baxter, *Exactly solved models in statistical mechanics*, Courier Dover Publications, 2007.
- [BB15] A. Borodin and Al. Bufetov, *An irreversible local Markov chain that preserves the six vertex model on a torus*, arXiv:1509.05070 [math-ph].
- [BBT94] N. Bogoliubov, R. Bullough, and J. Timonen, *Critical behavior for correlated strongly coupled boson systems in 1 + 1 dimensions*, Phys. Rev. Lett. **72** (1994), no. 25, 3933–3936.
- [BC13] A. Borodin and I. Corwin, *Discrete time q -TASEPs*, Intern. Math. Research Notices (2013), no. rnt206, arXiv:1305.2972 [math.PR], doi: 10.1093/imrn/rnt206.
- [BC14] ———, *Macdonald processes*, Prob. Theory Rel. Fields **158** (2014), 225–400, arXiv:1111.4408 [math.PR].
- [BC15] G. Barraquand and I. Corwin, *Random-walk in Beta-distributed random environment*, arXiv:1503.04117 [math.PR].
- [BCG14] A. Borodin, I. Corwin, and V. Gorin, *Stochastic six-vertex model*, arXiv:1407.6729 [math.PR].
- [BCGS15] A. Borodin, I. Corwin, V. Gorin, and S. Shakirov, *Observables of Macdonald processes*, Trans. Amer. Math. Soc. (2015), arXiv:1306.0659 [math.PR], doi: 10.1090/tran/6359.
- [BCPS15a] A. Borodin, I. Corwin, L. Petrov, and T. Sasamoto, *Spectral theory for interacting particle systems solvable by coordinate Bethe ansatz*, Comm. Math. Phys. **339** (2015), no. 3, 1167–1245, arXiv:1407.8534 [math-ph].
- [BCPS15b] ———, *Spectral theory for the q -Boson particle system*, Compositio Mathematica **151** (2015), no. 1, 1–67, arXiv:1308.3475 [math-ph].
- [BCS14] A. Borodin, I. Corwin, and T. Sasamoto, *From duality to determinants for q -TASEP and ASEP*, Ann. Probab. **42** (2014), no. 6, 2314–2382, arXiv:1207.5035 [math.PR].
- [BDJ99] J. Baik, P. Deift, and K. Johansson, *On the distribution of the length of the longest increasing subsequence of random permutations*, Journal of the American Mathematical Society **12** (1999), no. 4, 1119–1178, arXiv:math/9810105 [math.CO].
- [Bet31] H. Bethe, *Zur Theorie der Metalle. I. Eigenwerte und Eigenfunktionen der linearen Atomkette. (On the theory of metals. I. Eigenvalues and eigenfunctions of the linear atom chain)*, Zeitschrift fur Physik **71** (1931), 205–226.
- [BF14] A. Borodin and P. Ferrari, *Anisotropic growth of random surfaces in 2+1 dimensions*, Comm. Math. Phys. **325** (2014), 603–684, arXiv:0804.3035 [math-ph].
- [BIK98] N. Bogoliubov, A. Izergin, and N. Kitanine, *Correlation functions for a strongly correlated boson system*, Nuclear Phys. B **516** (1998), no. 3, 501–528, arXiv:solv-int/9710002.
- [Bor11] A. Borodin, *Schur dynamics of the Schur processes*, Advances in Mathematics **228** (2011), no. 4, 2268–2291, arXiv:1001.3442 [math.CO].
- [Bor14] ———, *On a family of symmetric rational functions*, arXiv:1410.0976 [math.CO].
- [BP13] A. Borodin and L. Petrov, *Nearest neighbor Markov dynamics on Macdonald processes*, arXiv:1305.5501 [math.PR], to appear in Adv. Math.
- [CLDR10] P. Calabrese, P. Le Doussal, and A. Rosso, *Free-energy distribution of the directed polymer at high temperature*, Euro. Phys. Lett. **90** (2010), no. 2, 20002.
- [Cor12] I. Corwin, *The Kardar-Parisi-Zhang equation and universality class*, Random Matrices Theory Appl. **1** (2012), arXiv:1106.1596 [math.PR].
- [Cor14] ———, *The q -Hahn Boson process and q -Hahn TASEP*, Intern. Math. Research Notices (2014), rnu094, arXiv:1401.3321 [math.PR].
- [CP13] I. Corwin and L. Petrov, *The q -PushASEP: A New Integrable Model for Traffic in 1+1 Dimension*, arXiv:1308.3124 [math.PR], to appear in Journal of Statistical Physics.
- [CP15] ———, *Stochastic higher spin vertex models on the line*, arXiv:1502.07374 [math.PR], To appear in Comm. Math. Phys.
- [Dot10] V. Dotsenko, *Replica Bethe ansatz derivation of the Tracy-Widom distribution of the free energy fluctuations in one-dimensional directed polymers*, Journal of Statistical Mechanics: Theory and Experiment (2010), no. 07, P07010, arXiv:1004.4455 [cond-mat.dis-nn].
- [Ful97] J. Fulman, *Probabilistic measures and algorithms arising from the Macdonald symmetric functions*, 1997, arXiv:math/9712237 [math.CO].
- [FV96] G. Felder and A. Varchenko, *Algebraic Bethe ansatz for the elliptic quantum group $E_{\tau,\eta}(\mathfrak{sl}_2)$* , Nuclear Phys. B **480** (1996), no. 1-2, 485–503, arXiv:q-alg/9605024.
- [GO09] A. Gnedin and G. Olshanski, *A q -analogue of de Finetti’s theorem*, The electronic journal of combinatorics **16** (2009), R16, arXiv:0905.0367 [math.PR].
- [GO10] ———, *q -exchangeability via quasi-invariance*, The Annals of Probability **38** (2010), no. 6, 2103–2135, arXiv:0907.3275 [math.PR].
- [GS92] L.-H. Gwa and H. Spohn, *Six-vertex model, roughened surfaces, and an asymmetric spin Hamiltonian*, Phys. Rev. Lett. **68** (1992), no. 6, 725–728.

- [Har78] T. E. Harris, *Additive set-valued Markov processes and graphical methods*, Ann. Probability **6** (1978), no. 3, 355–378.
- [Joh01] K. Johansson, *Discrete orthogonal polynomial ensembles and the Plancherel measure*, Annals of Mathematics **153** (2001), no. 1, 259–296, arXiv:math/9906120 [math.CO].
- [KBI93] V. Korepin, N. Bogoliubov, and A. Izergin, *Quantum inverse scattering method and correlation functions*, Cambridge University Press, Cambridge, 1993.
- [Kön05] W. König, *Orthogonal polynomial ensembles in probability theory*, Probab. Surv. **2** (2005), 385–447, arXiv:math/0403090 [math.PR].
- [KOR02] W. König, N. O’Connell, and S. Roch, *Non-colliding random walks, tandem queues, and discrete orthogonal polynomial ensembles*, Electron. J. Probab. **7** (2002), no. 5, 1–24.
- [KPZ86] M. Kardar, G. Parisi, and Y. Zhang, *Dynamic scaling of growing interfaces*, Physical Review Letters **56** (1986), no. 9, 889.
- [KR87] A.N. Kirillov and N. Reshetikhin, *Exact solution of the integrable XXZ Heisenberg model with arbitrary spin. I. The ground state and the excitation spectrum.*, J. Phys. A **20** (1987), no. 6, 1565–1585.
- [KRS81] P. Kulish, N. Reshetikhin, and E. Sklyanin, *Yang-Baxter equation and representation theory: I*, Letters in Mathematical Physics **5** (1981), no. 5, 393–403.
- [KS96] R. Koekoek and R.F. Swarttouw, *The Askey-scheme of hypergeometric orthogonal polynomials and its q -analogue*, Tech. report, Delft University of Technology and Free University of Amsterdam, 1996.
- [Mac95] I.G. Macdonald, *Symmetric functions and Hall polynomials*, 2nd ed., Oxford University Press, 1995.
- [Man14] V. Mangazeev, *On the Yang–Baxter equation for the six-vertex model*, Nuclear Physics B **882** (2014), 70–96, arXiv:1401.6494 [math-ph].
- [MP15] K. Matveev and L. Petrov, *q -randomized Robinson–Schensted–Knuth correspondences and random polymers*, arXiv:1504.00666 [math.PR].
- [O’C03a] N. O’Connell, *A path-transformation for random walks and the Robinson–Schensted correspondence*, Transactions of the American Mathematical Society **355** (2003), no. 9, 3669–3697.
- [O’C03b] ———, *Conditioned random walks and the RSK correspondence*, J. Phys. A **36** (2003), no. 12, 3049–3066.
- [O’C12] ———, *Directed polymers and the quantum Toda lattice*, Ann. Probab. **40** (2012), no. 2, 437–458, arXiv:0910.0069 [math.PR].
- [Oko01] A. Okounkov, *Infinite wedge and random partitions*, Selecta Mathematica, New Series **7** (2001), no. 1, 57–81, arXiv:math/9907127 [math.RT].
- [OR03] A. Okounkov and N. Reshetikhin, *Correlation function of Schur process with application to local geometry of a random 3-dimensional Young diagram*, Journal of the American Mathematical Society **16** (2003), no. 3, 581–603, arXiv:math/0107056 [math.CO].
- [Pov13] A. Povolotsky, *On integrability of zero-range chipping models with factorized steady state*, J. Phys. A **46** (2013), 465205.
- [Res10] N. Reshetikhin, *Lectures on the integrability of the 6-vertex model*, Exact Methods in Low-dimensional Statistical Physics and Quantum Computing, Oxford Univ. Press, 2010, arXiv:1010.5031 [math-ph], pp. 197–266.
- [Sch97] G. Schütz, *Duality relations for asymmetric exclusion processes*, Journal of statistical physics **86** (1997), no. 5-6, 1265–1287.
- [Spi70] F. Spitzer, *Interaction of Markov processes*, Adv. Math. **5** (1970), no. 2, 246–290.
- [SW98] T. Sasamoto and M. Wadati, *Exact results for one-dimensional totally asymmetric diffusion models*, J. Phys. A **31** (1998), 6057–6071.
- [TW08] C. Tracy and H. Widom, *Integral formulas for the asymmetric simple exclusion process*, Commun. Math. Phys. **279** (2008), 815–844, arXiv:0704.2633 [math.PR]. Erratum: Commun. Math. Phys., 304:875–878, 2011.
- [TW09a] ———, *Asymptotics in ASEP with step initial condition*, Comm. Math. Phys. **290** (2009), 129–154, arXiv:0807.1713 [math.PR].
- [TW09b] ———, *On ASEP with step Bernoulli initial condition*, J. Stat. Phys. **137** (2009), 825–838, arXiv:0907.5192 [math.PR].
- [Vul07] M. Vuletic, *Shifted Schur Process and Asymptotics of Large Random Strict Plane Partitions*, International Mathematics Research Notices **2007** (2007), no. rnm043, arXiv:math-ph/0702068.
- [WW15] Dong Wang and David Waugh, *The transition probability of the q -TAZRP (q -Bosons) with inhomogeneous jump rates*, arXiv:1512.01612 [math.PR].
- [WZJ15] M. Wheeler and P. Zinn-Justin, *Refined Cauchy/Littlewood identities and six-vertex model partition functions: III. Deformed bosons*, arXiv:1508.02236 [math-ph].

A. BORODIN, DEPARTMENT OF MATHEMATICS, MASSACHUSETTS INSTITUTE OF TECHNOLOGY, 77 MASSACHUSETTS AVE., CAMBRIDGE, MA 02139, USA,
AND INSTITUTE FOR INFORMATION TRANSMISSION PROBLEMS, BOLSHOY KARETNY PER. 19, MOSCOW, 127994, RUSSIA
E-mail address: borodin@math.mit.edu

L. PETROV, DEPARTMENT OF MATHEMATICS, UNIVERSITY OF VIRGINIA, 141 CABELL DRIVE, KERCHOF HALL, P.O. BOX 400137, CHARLOTTESVILLE, VA 22904, USA,
AND INSTITUTE FOR INFORMATION TRANSMISSION PROBLEMS, BOLSHOY KARETNY PER. 19, MOSCOW, 127994, RUSSIA
E-mail address: lenia.petrov@gmail.com