

$(4, -(2n + 5))$ -TORUS KNOT WITH ONLY 1 NORMAL RULING

WATCHAREEPAN ATIPONRAT

ABSTRACT. The main purpose of this paper is to provide an infinite family of counter examples of the open problem mentioned in [2]. In particular, we present an infinite family of a particular Legendrian $(4, -(2n + 5))$ -torus knot, for each $n \geq 0$, which has only 1 normal ruling, but do not satisfy the even number of clasps condition of Theorem 3 of [2]. Thus, these normal rulings cannot imply the existence of a decomposable exact Lagrangian filling.

1. INTRODUCTION

The **standard contact structure on \mathbb{R}^3** is a smooth 2-dimensional subbundle of the tangent bundle of \mathbb{R}^3 which is corresponding to $\ker(dz - ydx)$. In this work, we consider smooth links in \mathbb{R}^3 which are everywhere tangent to the standard contact structure on \mathbb{R}^3 , such links are called **Legendrian links**. If a Legendrian link has only 1 component, we may call it a Legendrian knot.

The **front projection** of a Legendrian link is the projection of the link into the xz -plane (here, we consider \mathbb{R}^3 with coordinate (x, y, z)). We will assume that the positive y -axis is pointing into the page so that every crossing of the front projection of a Legendrian link has the overpassing with less slope. Also, by small perturbation we may assume that front projection has only double points at self-intersections. It is proved in [6] that any self-intersection is transverse so the front projection has only finite number of self-intersections. In addition, a front projection of a Legendrian link has cusps instead of vertical tangencies. The front projection of some Legendrian unknots are illustrated in Figure 1.

Next, we introduce normal rulings. These are objects related to front diagram of Legendrian links. They are interesting since it has been shown in [5] that the number of normal rulings of a Legendrian link is invariant under Legendrian isotopy. We will revisit this topic in Section 2.

On the other hand, an exact Lagrangian fillings of Legendrian links are particular surfaces in \mathbb{R}^4 with Legendrian links as their boundaries. The papers [3] and [4] have suggested that there is a connection between the existence of normal rulings of Legendrian links and the existence of decomposable exact Lagrangian fillings of the links. As mentioned in the paragraph before Lemma 2 in [2], the existence of decomposable exact Lagrangian fillings is able to imply the existence of normal rulings. However, it is an open question if the occurrence of a normal ruling implies the existence of an exact (possibly non-orientable) Lagrangian filling. In this work, we would like to supply an infinite family of Legendrian links providing a negative answer to the question. In fact, we prove that there is an infinite

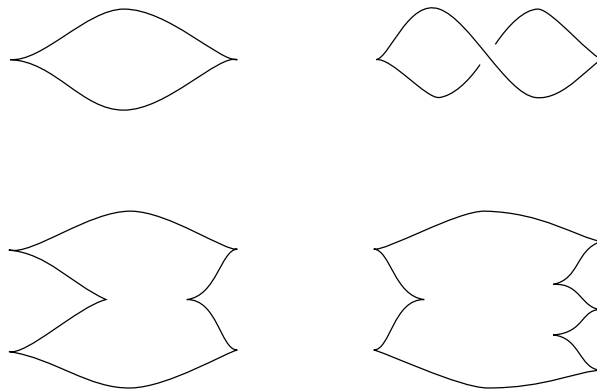

Figure 1: Front projection of some Legendrian unknots.

family of a particular type of Legendrian knots which has only 1 normal ruling. To be precise, we have the following result at the end of section 2.

Theorem 1. *For any $n \geq 0$, Legendrian $(4, -(2n + 5))$ -torus knot, as in Figure 15, has only 1 normal ruling. Furthermore, no member of this family of Legendrian knots has a decomposable exact Lagrangian filling.*

We note here that all results in this paper are coming from [1]. In addition, we will use this paper to provide an infinite family of counter examples in [2].

Acknowledgments. The author would like to thank William Menasco for his support which makes this work possible. In addition, the author would like to thank Lenhard Ng for an introduction to this topic.

2. NORMAL RULINGS

Suppose we have a front diagram K of a Legendrian link. By regular isotopy, we may assume from now on that its cusps and crossings have distinct x -coordinates. We consider a subset ρ of the set of all crossings of K . Then we perform resolution, see Figure 2, at each crossing in ρ so that we obtain a resulting front diagram K' . We call ρ a **normal ruling** if the followings hold:

- (1) each component of K' has one left cusp, one right cusp and no self-intersections;
- (2) horizontal strands at each resolution belong to different components in K' ; and
- (3) in the vertical slice (constant x -coordinate) passing through each resolution, the two eyes meeting at the resolution must be one of the three cases in Figure 3.

If ρ is a normal ruling, then all crossings in ρ are called **switches** and K' is the **resolution of ρ** while each component of K' is named an **eye**. Moreover, (3) is the **normality condition**, and we say a Legendrian link has a normal ruling if its front diagram admitting a normal ruling. Now, we give important examples of Legendrian knots with a normal ruling.

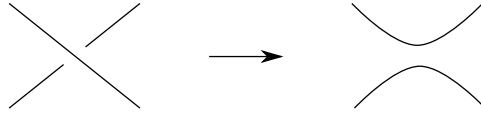

Figure 2: Resolution at a crossing.

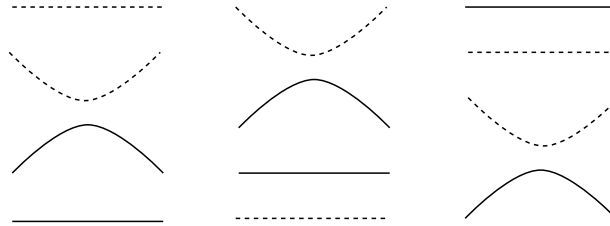

Figure 3: Possible vertical slices at resolution when considering only two resulting components involved.

Example 1. Legendrian $(4, -5)$ -torus knot from Figure 5 has only 1 normal ruling.

Proof. First, it is not hard to check that $\{3, 4, 7, 10, 14\}$ is a normal ruling as in the bottom of Figure 5. Next, we show that it is the only possible normal ruling via some observations. Suppose we have a normal ruling. Then it cannot contain any of violations V1 - V4 for being a normal as shown in Figure 4. It must satisfy the following.

(1) 1 and 2 are not switches.: Notice that we either have both 1 and 2 are switches or both are not switches. Suppose on the contrary that 1 is a switch. Then we will have its consequences and, at the end, a contradiction as illustrated in Figure 6. Also, because 1 and 2 are not switches, we have L2 and R2 live in the same eye.

(2) 3 and 4 are switches.: Since 1 and 2 are not switches, we either have both 3 and 4 are switches or both are not switches. Suppose on the contrary that 3 is not a switch. Then we will have its consequences and, at the end, a contradiction as illustrated in Figure 7.

(3) 5 and 6 are not switches.: If 5 or 6 is a switch, the normality condition fails at 3 or 4, which is impossible.

(4) 7 is a switch.: Suppose on the contrary that 7 is not a switch. Then we will have its consequences and, at the end, a contradiction as illustrated in Figure 8.

By (1) - (4), we only have 1 normal ruling possible as discussed in Figure 9.

Thus there is exactly 1 normal ruling. □

Violations

V1 : There is a component with a self-intersection.

V2 : Normality condition cannot be fulfilled at a resolution.

V3 : Two horizontal strands at a resolution belong to the same component.

V4 : There is a component containing the following.

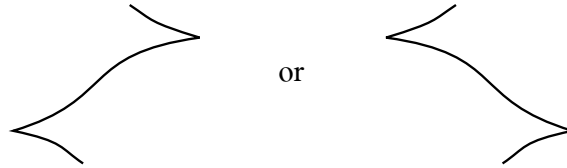

Figure 4: Violations for being a normal ruling in Figure 6 - 9, 11 - 14, 17, 19, 21, 22, 24, 26.

Example 2. *Legendrian $(4, -7)$ -torus knot from Figure 10 has only 1 normal ruling.*

Proof. First, it is not hard to check that $\{3, 4, 7, 10, 14, 17, 20\}$ is a normal ruling as in the bottom of Figure 10. Next, we show that it is the only possible normal ruling via some observations. Suppose we have a normal ruling. Then it must satisfy the following.

(1) 1 and 2 are not switches.: Notice that we either have both 1 and 2 are switches or both are not switches. Suppose on the contrary that 1 is a switch. Then we will have its consequences and, at the end, a contradiction as illustrated in Figure 11. Also, because 1 and 2 are not switches, we have L2 and R2 live in the same eye.

(2) 3 and 4 are switches.: Since 1 and 2 are not switches, we either have both 3 and 4 are switches or both are not switches. Suppose on the contrary that 3 is not a switch. Then we will have its consequences and, at the end, a contradiction as illustrated in Figure 12.

(3) 5 and 6 are not switches.: If 5 or 6 is a switch, the normality condition fails at 3 or 4, which is impossible.

(4) 7 is a switch.: Suppose on the contrary that 7 is not a switch. Then we will have its consequences and, at the end, a contradiction as illustrated in Figure 8.

By (1) - (4), we only have 1 normal ruling possible as discussed in Figure 14.

Thus there is exactly 1 normal ruling. □

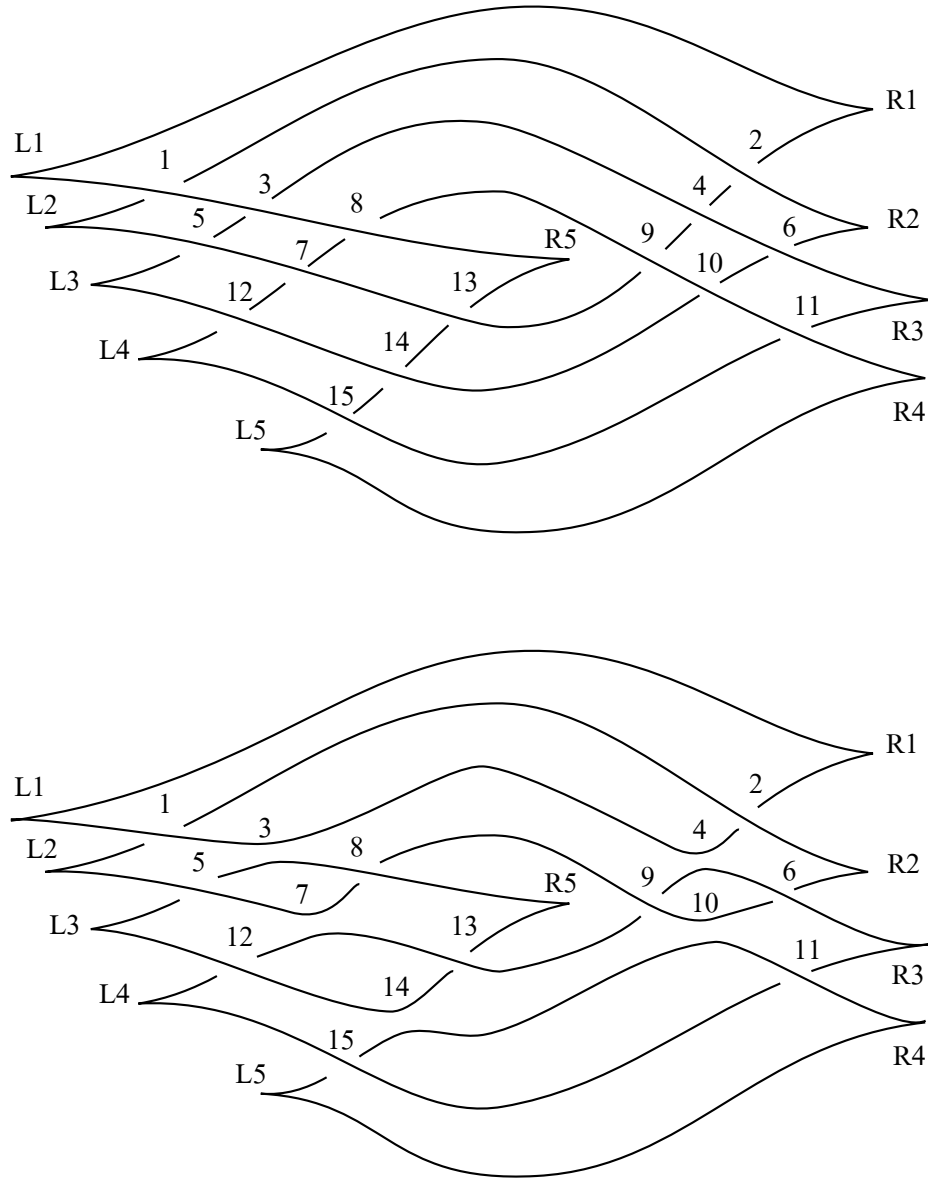

Figure 5: The Legendrian $(4, -5)$ -torus knot and the resolution of its only normal ruling.

Crossing	Switch	Reason
1	yes	By assumption.
2	yes	V1 occurs at 2.
5	no	V1 or V3 occurs at 3.
3	no	V2 occurs at 3.
7	no	V1 or V3 occurs at 8.
8	no	V2 occurs at 8.
13	yes	V1 occurs at 13.
6	no	V1 or V3 occurs at 4.
4	no	V2 occurs at 4.
10	no	V1 or V3 occurs at 9.
9	no	V2 occurs at 9.
Result	V1 occurs at 14. A contradiction.	

Figure 6: Assuming 1 is a switch will give a contradiction.

Crossing	Switch	Reason
1	no	This is proved in (1).
2	no	This is proved in (1).
3	no	By assumption.
4	no	V1 occurs at 3.
8	yes	V4 for L1 and R5.
9	yes	V1 occurs at 9.
13	no	V1 or V3 occurs at 7.
7	no	V2 occurs at 7.
14	no	V1 or V3 occurs at 12.
12	no	V4 for L3 and R5.
15	yes	V1 occurs at 15.
11	yes	V1 occurs at 11.
6	no	V1 or V3 occurs at 10.
10	no	V2 occurs at 10.
Result	V2 occurs at 9. A contradiction.	

Figure 7: Assuming 3 is not a switch will give a contradiction.

Crossing	Switch	Reason
1	no	This is proved in (1).
2	no	This is proved in (1).
3	yes	This is proved in (2).
4	yes	This is proved in (2).
5	no	This is proved in (3).
6	no	This is proved in (3).
7	no	By assumption.
13	no	L2 cannot live in the same eye with R5. (L2 has already lived with R2.)
9	no	V2 occurs at 9.
Result	V2 occurs at 4. A contradiction.	

Figure 8: Assuming 7 is not a switch will give a contradiction.

Crossing	Switch	Reason
1	no	This is proved in (1).
2	no	This is proved in (1).
3	yes	This is proved in (2).
4	yes	This is proved in (2).
5	no	This is proved in (3).
6	no	This is proved in (3).
7	yes	This is proved in (4).
8	no	V4 for L2 and R5.
9	no	V2 occurs at 4.
10	yes	V1 occurs at 10.
11	no	V2 occurs at 10.
12	no	V2 occurs at 7.
13	no	V2 occurs at 7.
14	yes	V1 occurs at 14.
15	no	V2 occurs at 14.
Result	There is only 1 normal ruling.	

Figure 9: There is only 1 normal ruling possible.

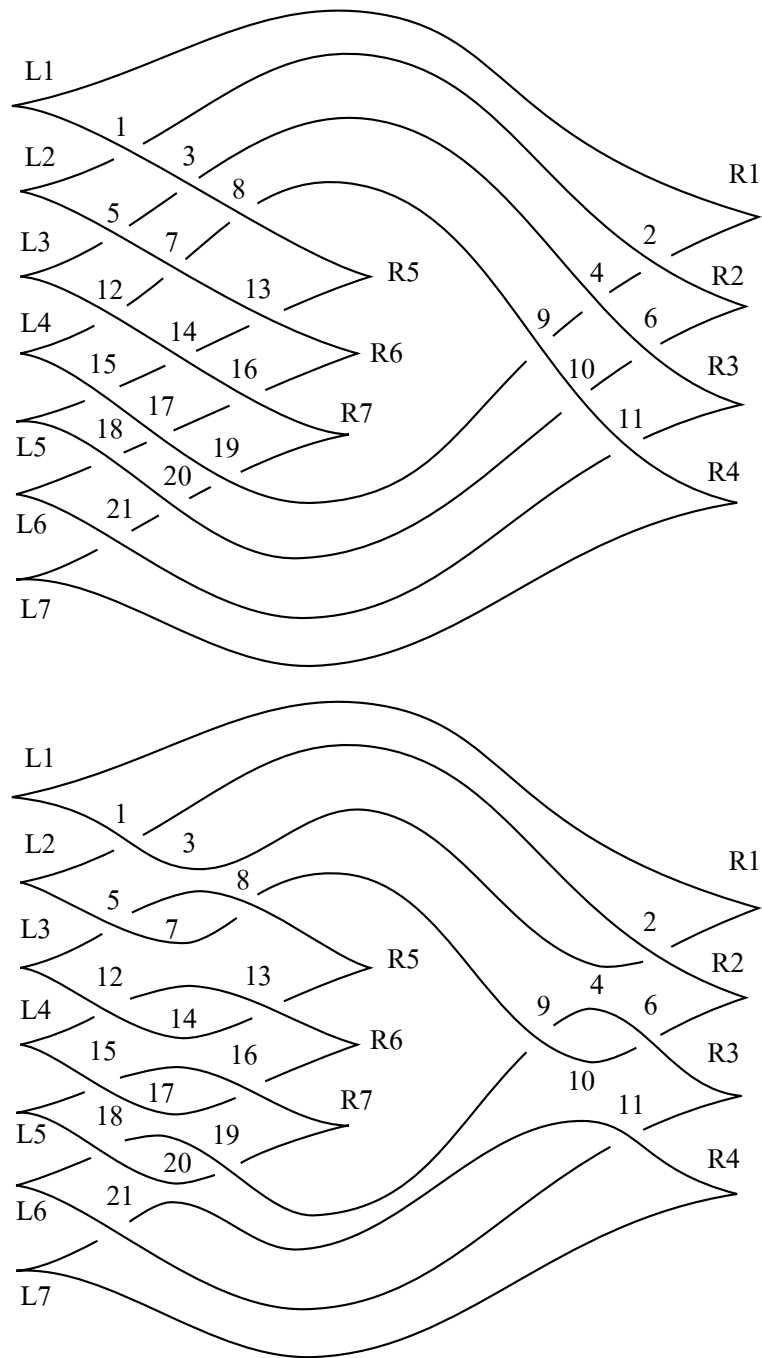

Figure 10: The Legendrian $(4, -7)$ -torus knot and the resolution of its only normal ruling.

Crossing	Switch	Reason
1	yes	By assumption.
2	yes	V1 occurs at 2.
5	no	V1 or V3 occurs at 3.
3	no	V2 occurs at 3.
7	no	V1 or V3 occurs at 8.
8	no	V2 occurs at 8.
13	yes	V1 occurs at 13.
16	no	V1 or V3 occurs at 14.
14	no	V2 occurs at 14.
17	no	V1 or V3 occurs at 15.
15	no	V4 for L4 and R6.
18	yes	V1 at 18.
21	no	V1 or V3 occurs at 20.
20	no	V2 occurs at 20.
10	no	V1 occurs at 11.
11	no	V4 for L6 and R4.
6	yes	V1 occurs at 6.
Result	V1 occurs at 4. A contradiction.	

Figure 11: Assuming 1 is a switch will give a contradiction.

Crossing	Switch	Reason
1	no	This is proved in (1).
2	no	This is proved in (1).
3	no	By assumption.
4	no	V1 occurs at 3.
8	yes	V4 for L1 and R5.
9	yes	V1 occurs at 9.
13	no	V1 or V3 occurs at 7.
7	no	V2 occurs at 7.
14	no	V1 or V3 occurs at 12.
12	no	V4 for L3 and R5.
15	yes	V1 occurs at 15.
18	no	V1 or V3 occurs at 17.
17	no	V2 occurs at 17.
20	no	V1 or V3 occurs at 19.
19	no	V2 occurs at 19.
Result	V1 occurs at 10. A contradiction.	

Figure 12: Assuming 3 is not a switch will give a contradiction.

Crossing	Switch	Reason
1	no	This is proved in (1).
2	no	This is proved in (1).
3	yes	This is proved in (2).
4	yes	This is proved in (2).
5	no	This is proved in (3).
6	no	This is proved in (3).
7	no	By assumption.
13	yes	V4 for L2 and R6.
8	no	V1 occurs at 7.
Result	V1 occurs at 5. A contradiction.	

Figure 13: Assuming 7 is not a switch will give a contradiction.

Crossing	Switch	Reason
1	no	This is proved in (1).
2	no	This is proved in (1).
3	yes	This is proved in (2).
4	yes	This is proved in (2).
5	no	This is proved in (3).
6	no	This is proved in (3).
7	yes	This is proved in (4).
8	no	V4 for L2 and R5.
9	no	V2 occurs at 4.
10	yes	V1 occurs at 10.
11	no	V2 occurs at 10.
12	no	V2 occurs at 7.
13	no	V2 occurs at 7.
14	yes	V1 occurs at 14.
15	no	V2 occurs at 14.
16	no	V2 occurs at 14.
17	yes	V1 occurs at 17.
18	no	V2 occurs at 17.
19	no	V2 occurs at 17.
20	yes	V1 occurs at 20.
21	no	V2 occurs at 20.
Result	There is only 1 normal ruling.	

Figure 14: There is only 1 normal ruling possible.

We may generalize Example 1 - 2 to obtain Theorem 1 as follows.

Proof of Theorem 1. We prove by induction on n . The case $n = 0, 1$ are shown in previous examples. Now, suppose the statement is true when $0 \leq n \leq N$ for some $N \geq 1$. We want to prove the statement is true when $n = N + 1$. First, $\{3, 4, 7, 10, 14, 14+3, 14+6, 14+9, \dots, 14+6n-3, 14+6n\}$ is a normal ruling as in Figure 16. Next, we show that it is the only possible normal ruling. We have 2 cases to consider.

$n = N + 1$ is even. Any normal ruling must satisfy the following.

(1) 1 and 2 are not switches.: Notice that we either have both 1 and 2 are switches or both are not switches. Suppose on the contrary that 1 is a switch. Then we will have its consequences and, at the end, a contradiction as illustrated in Figure 17. Also, because 1 and 2 are not switches, we have L2 and R2 live in the same eye.

(2) 3 and 4 are switches.: Since 1 and 2 are not switches, we either have both 3 and 4 are switches or both are not switches. Suppose on the contrary that 3 is not a switch. Then we will have its consequences and, at the end, a contradiction as illustrated in Figure 19.

(3) 5 and 6 are not switches.: If 5 or 6 is a switch, the normality condition fails at 3 or 4, which is impossible.

(4) 7 is a switch.: Since $n \geq 2$, we may use the prove of (4) from Example 2. Suppose on the contrary that 7 is not a switch. Then we will have its consequences and, at the end, a contradiction as illustrated in Figure 8.

By (1) - (4), we only have 1 normal ruling possible as discussed in Figure 21.

$n = N + 1$ is odd. Any normal ruling must satisfy the following.

(1) 1 and 2 are not switches.: Notice that we either have both 1 and 2 are switches or both are not switches. Suppose on the contrary that 1 is a switch. Then we will have its consequences and, at the end, a contradiction as illustrated in Figure 22. Also, because 1 and 2 are not switches, we have L2 and R2 live in the same eye.

(2) 3 and 4 are switches.: Since 1 and 2 are not switches, we either have both 3 and 4 are switches or both are not switches. Suppose on the contrary that 3 is not a switch. Then we will have its consequences and, at the end, a contradiction as illustrated in Figure 19.

(3) 5 and 6 are not switches.: If 5 or 6 is a switch, the normality condition fails at 3 or 4, which is impossible.

(4) 7 is a switch.: Since $n \geq 2$, we may use the prove of (4) from Example 2. Suppose on the contrary that 7 is not a switch. Then we will have its consequences and, at the end, a contradiction as illustrated in Figure 8.

By (1) - (4), we only have 1 normal ruling possible as discussed in Figure 26.

Thus there is exactly 1 normal ruling.

Finally, the second part of this theorem is proved in Theorem 4 of [2]. □

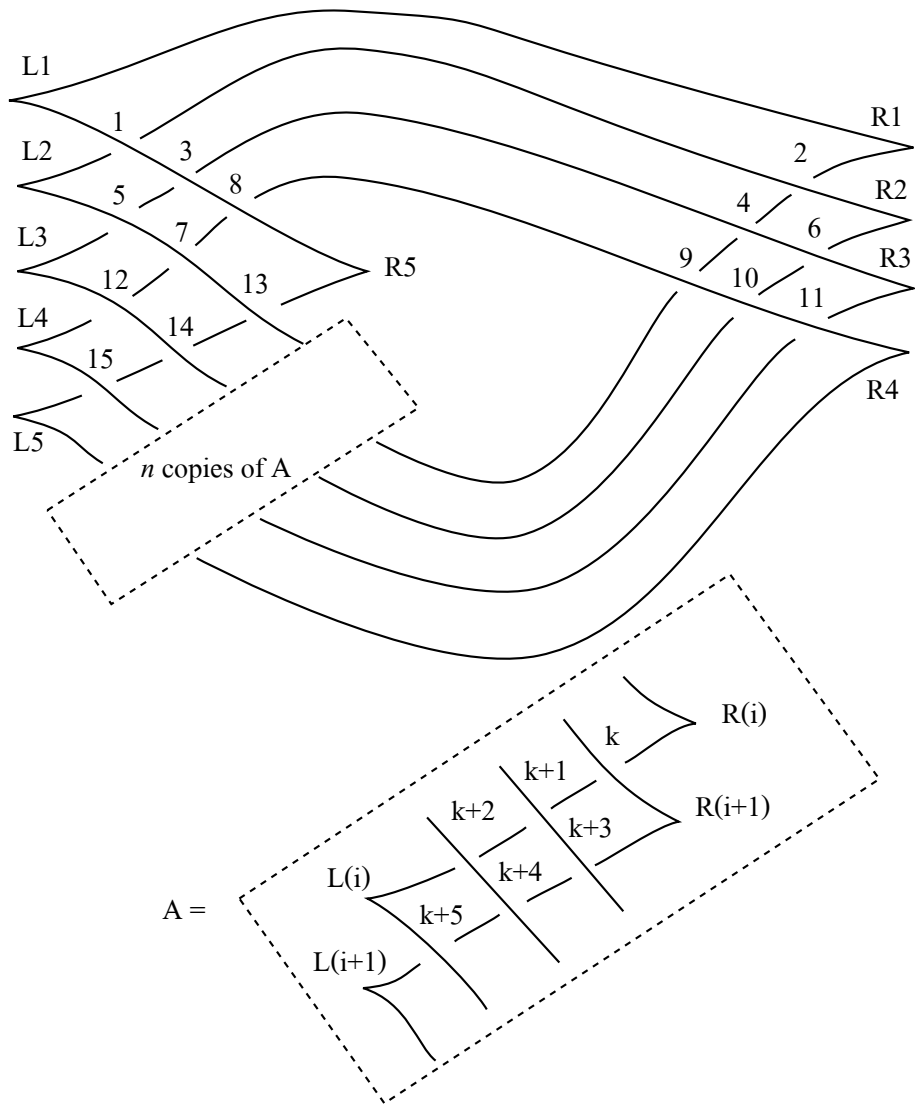

Figure 15: The Legendrian $(4, -(2n + 5))$ -torus knot, $n \geq 0$.

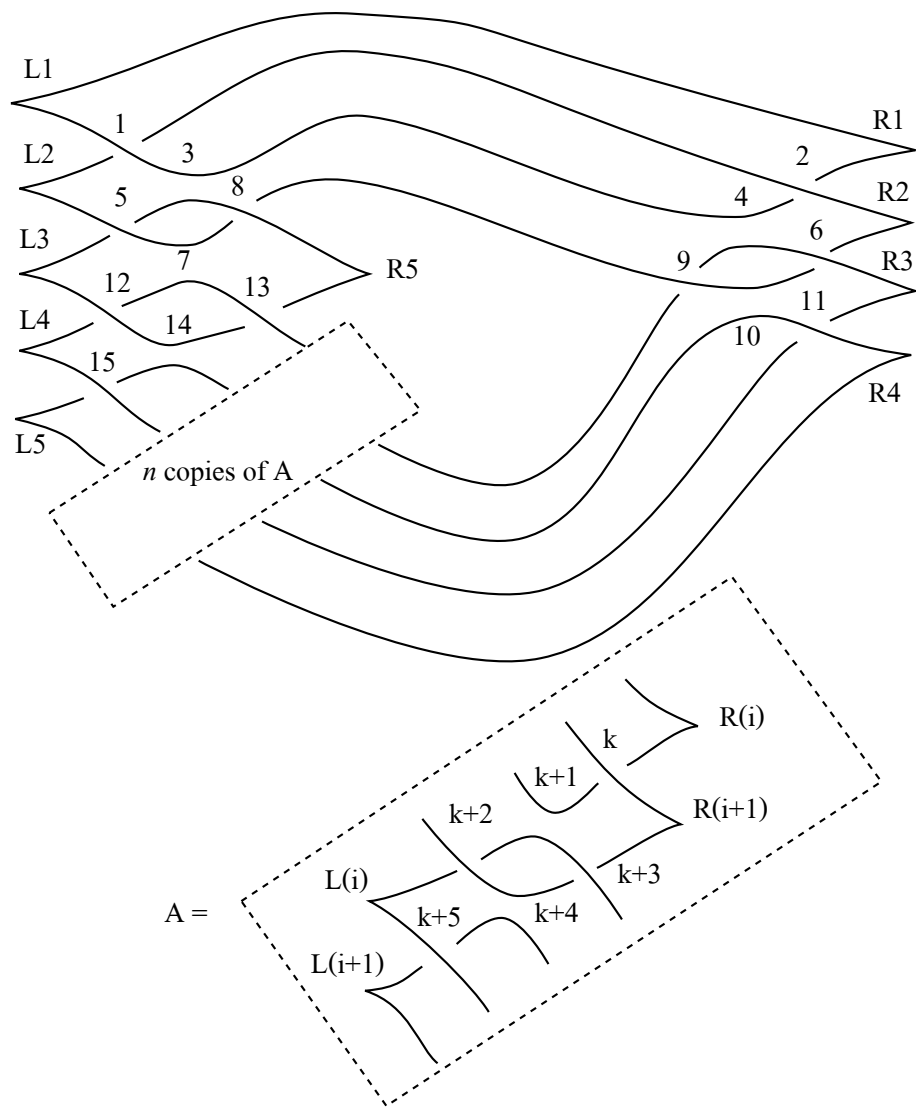

Figure 16: The resolution of the only normal ruling of the Legendrian $(4, -(2n + 5))$ -torus knot, $n \geq 0$.

Crossing	Switch	Reason
1	yes	By assumption.
2	yes	V1 occurs at 2.
5	no	V1 or V3 occurs at 3.
3	no	V2 occurs at 3.
7	no	V1 or V3 occurs at 8.
8	no	V2 occurs at 8.
13	yes	V1 occurs at 13.
6	no	V1 or V3 occurs at 4.
4	no	V2 occurs at 4.
10	no	V1 or V3 occurs at 9.
9	no	V2 occurs at 9.
<u>For $0 \leq j \leq n - 1$;</u>		
j even :		
$14 + 6j + 2$	no	V1 or V3 occurs at $14 + 6j$.
$14 + 6j$	no	V2 occurs at $14 + 6j$.
$14 + 6j + 3$	no	V1 or V3 occurs at $14 + 6j + 1$.
$14 + 6j + 1$	no	V4 for $L(4 + 2j)$ and $R(4 + 2j + 2)$.
$14 + 6j + 4$	yes	V1 occurs at $14 + 6j + 4$.
j odd :		
$14 + 6j + 1$	no	V1 or V3 occurs at $14 + 6j$.
$14 + 6j$	no	V2 occurs at $14 + 6j$.
$14 + 6j + 3$	no	V1 or V3 occurs at $14 + 6j + 2$.
$14 + 6j + 2$	no	V4 for $L(4 + 2j)$ and $R(4 + 2j + 2)$.
$14 + 6j + 5$	yes	V1 occurs at $14 + 6j + 5$.
Result	V1 occurs at $14 + 6n$. A contradiction.	

Figure 17: Assuming 1 is a switch when n is even will give a contradiction.

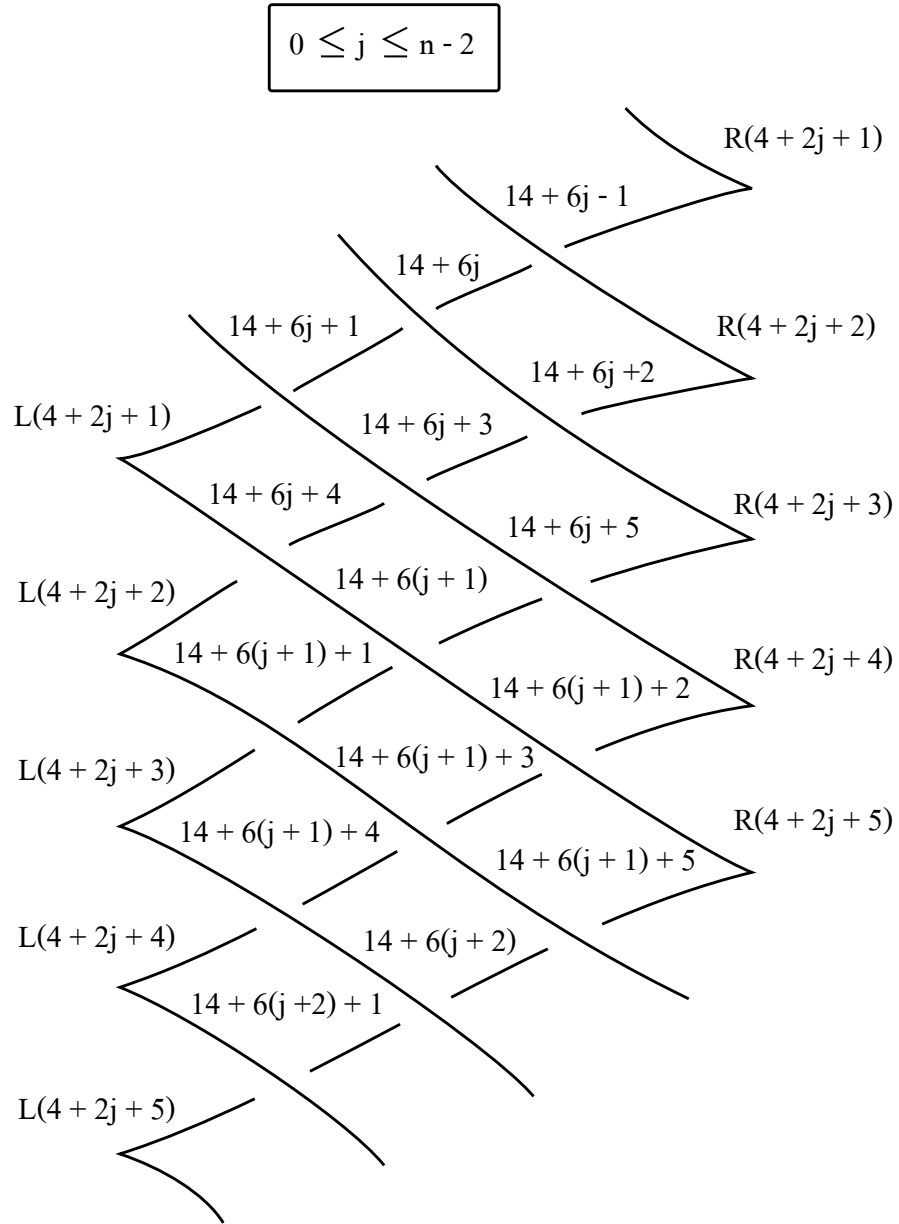

Figure 18: Labeling crossings and cusps for tables in Figure 17 and 21.

Crossing	Switch	Reason
1	no	This is proved in (1).
2	no	This is proved in (1).
3	no	By assumption.
4	no	V1 occurs at 3.
8	yes	V4 for L1 and R5.
9	yes	V1 occurs at 9.
13	no	V1 or V3 occurs at 7.
7	no	V2 occurs at 7.
14	no	V1 or V3 occurs at 12.
12	no	V4 for L3 and R5.
15	yes	V1 occurs at 15.
<u>For $0 \leq j \leq n - 1$;</u>		
j even :		
$17 + 6j + 1$	no	V1 or V3 occurs at $17 + 6j$.
$17 + 6j$	no	V2 occurs at $17 + 6j$.
$17 + 6j + 3$	no	V1 or V3 occurs at $17 + 6j + 2$.
$17 + 6j + 2$	no	V4 for $L(4 + 2j + 1)$ and $R(4 + 2j + 3)$.
$17 + 6j + 5$	yes	V1 occurs at $17 + 6j + 5$.
j odd :		
$17 + 6j + 2$	no	V1 or V3 occurs at $17 + 6j$.
$17 + 6j$	no	V2 occurs at $17 + 6j$.
$17 + 6j + 3$	no	V1 or V3 occurs at $17 + 6j + 1$.
$17 + 6j + 1$	no	V4 for $L(4 + 2j + 1)$ and $R(4 + 2j + 3)$.
$17 + 6j + 4$	yes	V1 occurs at $17 + 6j + 4$.
11	yes	V1 occurs at 11.
6	no	V1 or V3 occurs at 10.
10	no	V2 occurs at 10.
Result	V2 occurs at 9. A contradiction.	

Figure 19: Assuming 3 is not a switch when n is even will give a contradiction.

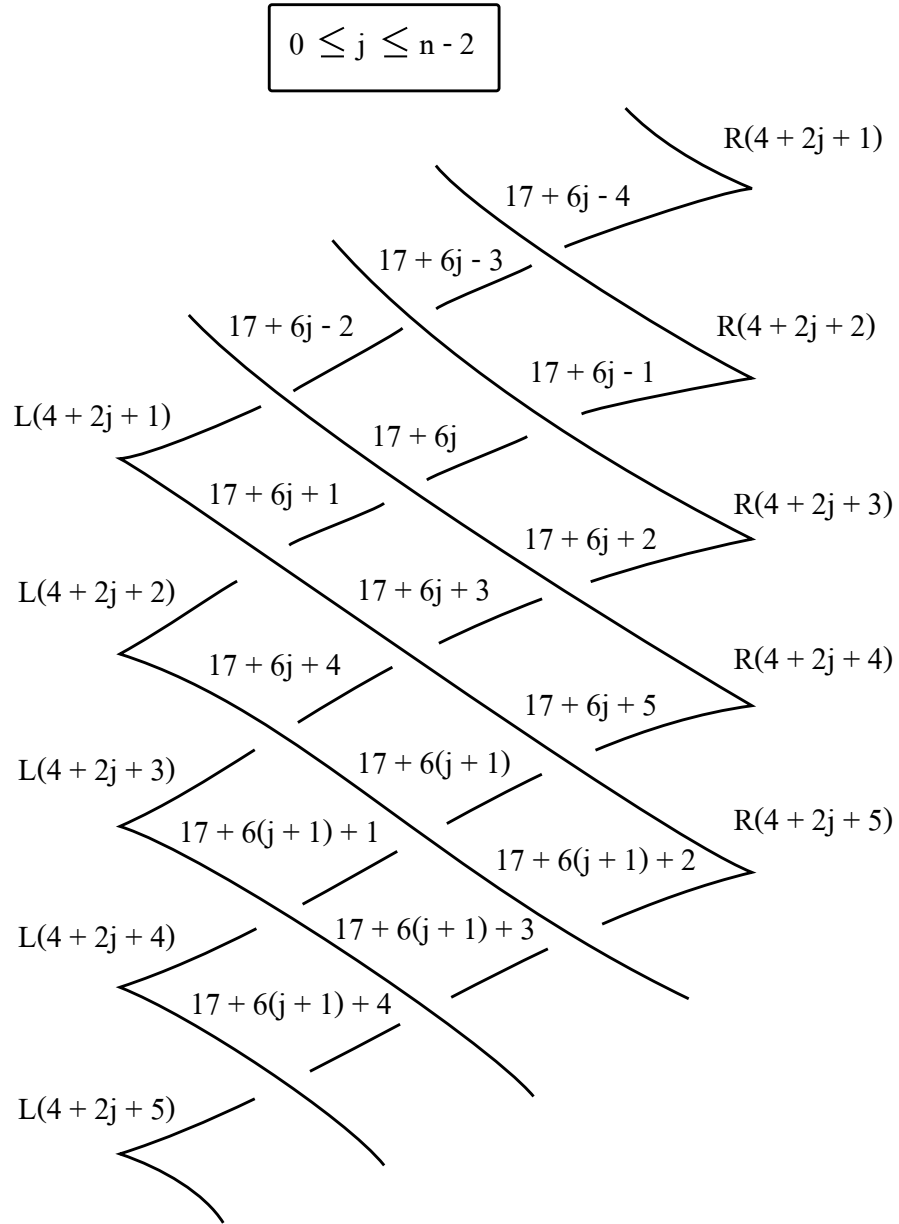

Figure 20: Labeling crossings and cusps for table in Figure 19.

Crossing	Switch	Reason
1, 2	no	This is proved in (1).
3, 4	yes	This is proved in (2).
5, 6	no	This is proved in (3).
7	yes	This is proved in (4).
8	no	V4 for L2 and R5.
9	no	V2 occurs at 4.
10	yes	V1 occurs at 10.
11	no	V2 occurs at 10.
12, 13	no	V2 occurs at 7.
For $0 \leq j \leq n - 1$;		
$14 + 6j$	yes	V1 occurs at $14 + 6j$.
$14 + 6j + 1, 14 + 6j + 2$	no	V2 occurs at $14 + 6j$.
$14 + 6j + 3$	yes	V1 occurs at $14 + 6j + 3$.
$14 + 6j + 4, 14 + 6j + 5$	no	V2 occurs at $14 + 6j + 3$.
$14 + 6n$		
$14 + 6n$	yes	V1 occurs at $14 + 6n$.
$14 + 6n + 1$	no	V2 occurs at $14 + 6n$.
Result	There is only 1 normal ruling.	

Figure 21: There is only 1 normal ruling possible when n is even.

Crossing	Switch	Reason
1	yes	By assumption.
2	yes	V1 occurs at 2.
5	no	V1 or V3 occurs at 3.
3	no	V2 occurs at 3.
7	no	V1 or V3 occurs at 8.
8	no	V2 occurs at 8.
13	yes	V1 occurs at 13.
For $0 \leq j \leq n - 1$;		
j even :		
$14 + 6j + 2$	no	V1 or V3 occurs at $14 + 6j$.
$14 + 6j$	no	V2 occurs at $14 + 6j$.
$14 + 6j + 3$	no	V1 or V3 occurs at $14 + 6j + 1$.
$14 + 6j + 1$	no	V4 for $L(4 + 2j)$ and $R(4 + 2j + 2)$.
$14 + 6j + 4$	yes	V1 occurs at $14 + 6j + 4$.
j odd :		
$14 + 6j + 1$	no	V1 or V3 occurs at $14 + 6j$.
$14 + 6j$	no	V2 occurs at $14 + 6j$.
$14 + 6j + 3$	no	V1 or V3 occurs at $14 + 6j + 2$.
$14 + 6j + 2$	no	V4 for $L(4 + 2j)$ and $R(4 + 2j + 2)$.
$14 + 6j + 5$	yes	V1 occurs at $14 + 6j + 5$.
$14 + 6n + 1$		
	no	V1 or V3 occurs at $14 + 6n$.
$14 + 6n$	no	V2 occurs at $14 + 6n$.
10	no	V1 occurs at 11.
11	no	V4 for $L(2n + 4)$ and $R4$.
6	yes	V1 occurs at 6.
Result	V1 occurs at 4. A contradiction.	

Figure 22: Assuming 1 is a switch when n is odd will give a contradiction.

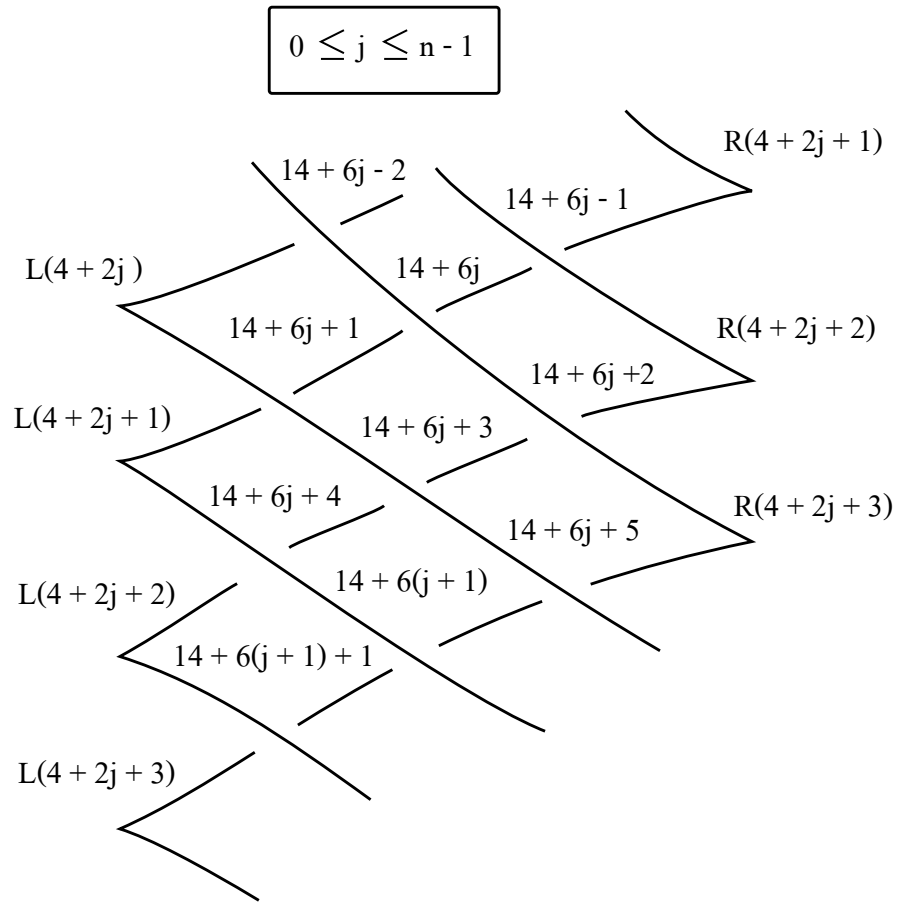

Figure 23: Labeling crossings and cusps for table in Figure 22 and 26.

Crossing	Switch	Reason
1	no	This is proved in (1).
2	no	This is proved in (1).
3	no	By assumption.
4	no	V1 occurs at 3.
8	yes	V4 for L1 and R5.
9	yes	V1 occurs at 9.
13	no	V1 or V3 occurs at 7.
7	no	V2 occurs at 7.
14	no	V1 or V3 occurs at 12.
12	no	V4 for L3 and R5.
15	yes	V1 occurs at 15.
<u>For $0 \leq j \leq n - 2$;</u>		
j even :		
$17 + 6j + 1$	no	V1 or V3 occurs at $17 + 6j$.
$17 + 6j$	no	V2 occurs at $17 + 6j$.
$17 + 6j + 3$	no	V1 or V3 occurs at $17 + 6j + 2$.
$17 + 6j + 2$	no	V4 for $L(4 + 2j + 1)$ and $R(4 + 2j + 3)$.
$17 + 6j + 5$	yes	V1 occurs at $17 + 6j + 5$.
j odd :		
$17 + 6j + 2$	no	V1 or V3 occurs at $17 + 6j$.
$17 + 6j$	no	V2 occurs at $17 + 6j$.
$17 + 6j + 3$	no	V1 or V3 occurs at $17 + 6j + 1$.
$17 + 6j + 1$	no	V4 for $L(4 + 2j + 1)$ and $R(4 + 2j + 3)$.
$17 + 6j + 4$	yes	V1 occurs at $17 + 6j + 4$.
$17 + 6(n - 1) + 1$	no	V1 or V3 occurs at $17 + 6(n - 1)$.
$17 + 6(n - 1)$	no	V2 occurs at $17 + 6(n - 1)$.
$17 + 6(n - 1) + 3$	no	V1 or V3 occurs at $17 + 6(n - 1) + 2$.
$17 + 6(n - 1) + 2$	no	V2 occurs at $17 + 6(n - 1) + 2$.
Result	V1 occurs at 10. A contradiction.	

Figure 24: Assuming 3 is not a switch when n is odd will give a contradiction.

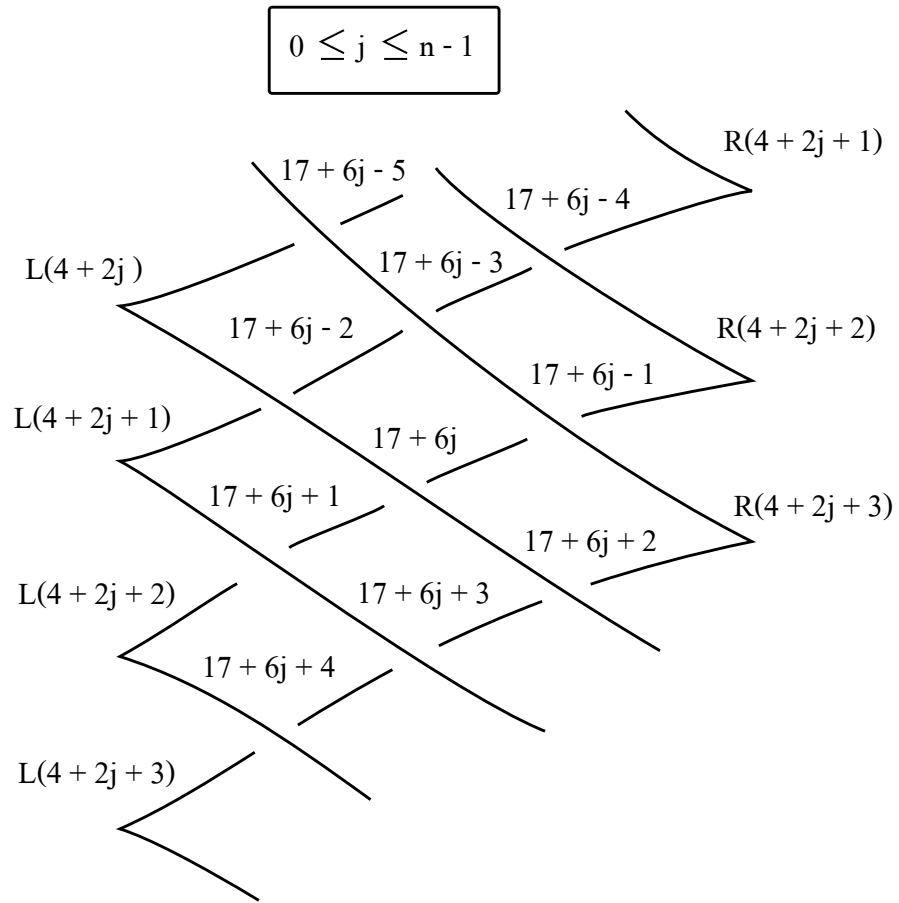

Figure 25: Labeling crossings and cusps for table in Figure 24.

Crossing	Switch	Reason
1, 2	no	This is proved in (1).
3, 4	yes	This is proved in (2).
5, 6	no	This is proved in (3).
7	yes	This is proved in (4).
8	no	V4 for L2 and R5.
9	no	V2 occurs at 4.
10	yes	V1 occurs at 10.
11	no	V2 occurs at 10.
12, 13	no	V2 occurs at 7.
For $0 \leq j \leq n - 1$;		
$14 + 6j$	yes	V1 occurs at $14 + 6j$.
$14 + 6j + 1, 14 + 6j + 2$	no	V2 occurs at $14 + 6j$.
$14 + 6j + 3$	yes	V1 occurs at $14 + 6j + 3$.
$14 + 6j + 4, 14 + 6j + 5$	no	V2 occurs at $14 + 6j + 3$.
$14 + 6n$		
$14 + 6n$	yes	V1 occurs at $14 + 6n$.
$14 + 6n + 1$	no	V2 occurs at $14 + 6n$.
Result	There is only 1 normal ruling.	

Figure 26: There is only 1 normal ruling possible when n is odd.

References

- [1] W. Atiponrat, *Obstructions to decomposable exact Lagrangian fillings*, PhD dissertation, University at Buffalo, 2015.
- [2] W. Atiponrat, *An obstruction to decomposable exact Lagrangian fillings*, In preparation.
- [3] T. Ekholm, K. Honda and T. Kálmán, *Legendrian knots and exact Lagrangian cobordisms*, arXiv:1212.1519v3
- [4] K. Hayden and J. M. Sabloff, *Positive knots and Lagrangian fillability*, Proc. Am. Math., 3143 (2015), no. 4, 1813-1821.
- [5] Yu. V. Chekanov and P. E. Pushkar', *Combinatorics of fronts of Legendrian links and the Arnol'd 4-conjectures*, Uspekhi Mat. Nauk **60** (2005), no. 1, 99-154, translation in Russian Math. Surveys **60** (2005), no. 1, 95-149.
- [6] H. Geiges, *An introduction to contact topology*, Cambridge Studies in Advanced Mathematics, vol. 109, Cambridge University Press, Cambridge, 2008.

Mathematics Department, Chiang Mai University
E-mail address: atiponrat@hotmail.com