

Characterization of photo-multiplier tubes for the Cryogenic Avalanche Detector

A.Bondar^{ab}, A.Buzulutskov^{ab}, A.Dolgov^{ab}, V.Nosov^{ab}, L.Shekhtman^{ab*}, A.Sokolov^{ab}

^a*Budker Institute of Nuclear Physics SB RAS
11 Lavrentiev Avenue, Novosibirsk 630090
Russia.*

e-mail: L.I.Shekhtman@inp.nsk.su

^b*Novosibirsk State University
2 Pirogova str., Novosibirsk 630090, Russia*

ABSTRACT: New Cryogenic Avalanche Detector (CRAD) with ultimate sensitivity, that will be able to detect one primary electron released in the cryogenic liquid, is under development in the Laboratory of Cosmology and Particle Physics of the Novosibirsk State University jointly with the Budker Institute of Nuclear Physics. The CRAD will use two sets of cryogenic PMTs in order to get trigger signal either from primary scintillations in liquid Ar or from secondary scintillations in high field gap above the liquid. Two types of cryogenic PMTs produced by Hamamatsu Photonics were tested and the results are presented in this paper. Low background 3 inch PMT R11065-10 demonstrated excellent performance according to its specifications provided by the producer. The gain measured with single electron response (SER) in liquid Ar reached 10^7 , dark count rate rate did not exceed 300 Hz and pulse height resolution of single electron signals was close to 50%(FWHM). However, two R11065-10 PMTs out of 7 tested stopped functioning after several tens minutes of operation immersed completely into liquid Ar. The remaining 5 devices and one R11065-MOD were operated successfully for several hours each with all the parameters according to the producer specifications. Compact 2 inch PMT R6041-506-MOD with metal-channel dynode structure is a candidate for side wall PMT system that will look at electroluminescence in high field region above liquid. Four of these PMTs were tested in liquid Ar and demonstrated gain up to 2×10^7 , dark count rate rate below 100 Hz and pulse height resolution of single electron signals of about 110% (FWHM).

KEYWORDS: dark matter, Cryogenic Avalanche Detector, cryogenic PMT.

*Corresponding author

Contents

1. Introduction.	1
2. Experimental set-up and procedures.	3
3. Results and discussion.	6
3.1 Results with R11065-10 and R11065-MOD PMTs.	6
3.2 Results with R6041-506MOD-ASSY PMT.	8
4. Conclusions.	11
5. Acknowledgements	12

1. Introduction.

Two-phase Cryogenic Avalanche Detector is proposed and being developed in the Laboratory of Cosmology and Particle physics of the Novosibirsk State University jointly with the Budker Institute of Nuclear Physics [1, 2, 3]. Main purpose of this detector is to search for weakly interacting massive particles (WIMP) [4] and coherent neutrino-nucleus scattering [5, 6] by detecting signals from nuclear recoils [7]. The energy of recoil nuclei from WIMP is predicted not to exceed several tens keV with the most interesting range below 8 keV that corresponds to the WIMP mass below 10 GeV. For coherent neutrino-nucleus scattering the recoil energy is even lower, below 0.5 keV. Thus the CRAD sensitivity that can allow detection of single primary electrons becomes a factor of crucial importance.

The design of proposed CRAD is shown schematically in Fig. 1. The detector consists of cryogenic vessel with vacuum thermal insulation that can hold up to 150 l of liquid Ar (200 kg). Sensitive volume is limited by the height of bottom PMT system as well as the thickness of side PMTs and is close to 50 l (50 cm height and 36 cm diameter). Primary electrons, produced by recoil nuclei after WIMP or neutrino scattering, drift in the liquid towards the surface in electric field of 2 kV/cm. At the liquid surface electrons are emitted in the gas phase where they produce signal in two stages. Firstly by electroluminescence in high electric field above the liquid, secondly by avalanche multiplication in double-THGEM cascade or in a hybrid 2THGEM/GEM cascade. Proportional scintillations in VUV region from electroluminescence (EL) gap are detected by the ring of side PMT and by the bottom PMT system. To provide sensitivity in VUV range all PMT have wavelength shifter (tetraphenyl-butadiene, TPB) deposited either directly on the PMT window or on thin transparent plastic foil in front of them. Bottom PMT are also intended for detection of primary scintillations in the liquid.

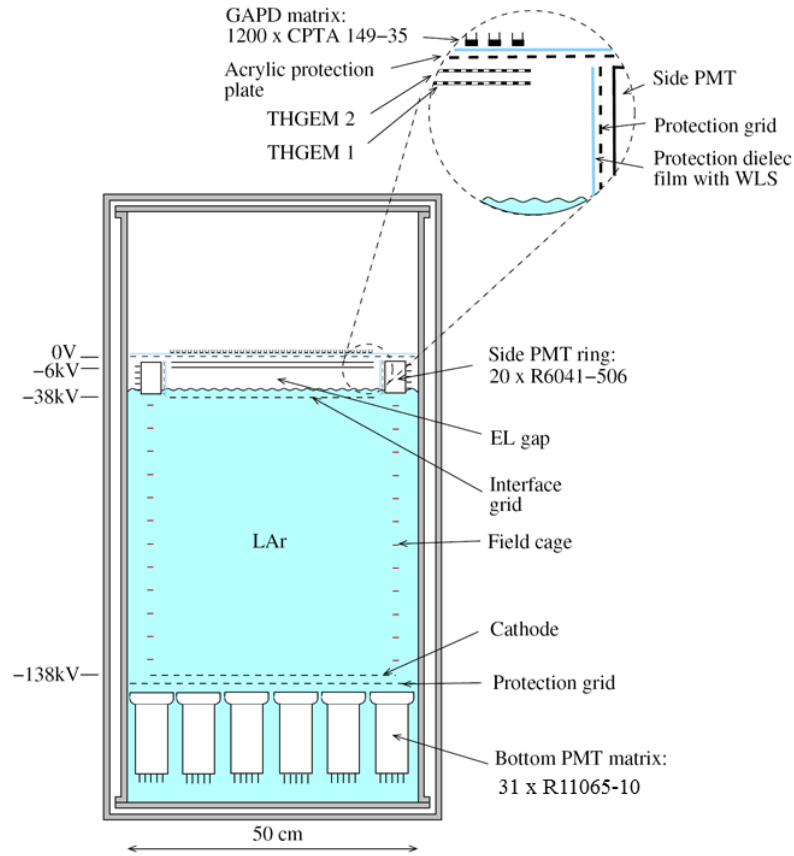

Figure 1. Design of two-phase CRAD in Ar with optical readout by combined GEM/GAPD multiplier.

Bottom and side PMT develop trigger signal for the matrix of Geiger-mode avalanche photodiodes (GAPD) that detects avalanche scintillation signals from the top THGEM in the Near Infrared (NIR) [1, 2]. GAPD matrix consists of $3 \times 3 \text{ mm}^2$ sensors placed in square or hexagonal lattice on a rigid printed circuit board (PCB) at a distance of 1 cm from the top THGEM. Such arrangement can provide spatial resolution below $\sim 2 \text{ mm}$ for single primary electrons [8] that is better than in classic cryogenic detectors with only PMT readout. Good spatial resolution together with the possibility to distinguish events with one and two primary electrons allows for effective rejection of single electron background. This is a unique feature of the proposed design that can be realized only if the PMT trigger system can separate effectively single primary electron events. Taking into account the number of secondary photons emitted in the EL gap of 4 cm with electric field of 8 kV/cm, the solid angle of all PMTs, PMT quantum efficiency and re-emission efficiency of the TPB layer we can estimate the number of photo-electrons in PMT, corresponding to a single primary electron in the liquid, as 23 [2, 3]. These photoelectrons will be distributed over more

than 50 PMT. Thus it is important that the PMT will detect single electrons with good efficiency (higher than 90%).

For the bottom PMT system R11065 Hamamatsu 3 inch PMT was chosen based on the experience of WARP collaboration [9]. This PMT has bialkali photocathode adapted for operation down to liquid Ar temperature (87 K). Quantum efficiency (QE) reported by the manufacturer is not less than 25% at 420 nm. The authors of [9] report however, the value of 33% QE at 420 nm. During 2012 and 2013 Hamamatsu Photonics undertook significant steps to reduce radioactivity of this PMT and developed R11065-10 and R11065-20 tubes. Replacement of a glass stem with a ceramic one lead to significant reduction in ^{40}K content for both modifications. In R11065-20 cobalt free alloy was used that decreased the amount of ^{60}Co . In R11065-10 the radioactivity per tube is 17 mBq compared to 75 mBq for R11065 [10]. However during 2013 and 2014 it was reported that new modifications of R11065, in particular R11065-20, have problems operating in liquid Ar (see for example [11]). Thus testing a set of PMT for the bottom system purchased from Hamamatsu, 7 R11065-10 and 1 R11065-MOD, became an urgent issue.

For the side PMT system we chose Hamamatsu R6041-506MOD device. This is a compact 2 inch PMT with metal-channel dynode structure and bialkali photocathode adapted for operation in liquid Ar (87 K) with 25% QE at 420 nm [12]. This tube has 57 mm diameter and 43.5 mm height, that allows to keep the diameter of sensitive volume not less than 36 mm. The report on its successful operation in liquid Ar can be found in [13], however, with no information on its operation parameters. Thus we needed to test these PMT to become sure that they can detect single photoelectrons with probability at least higher than 90% in liquid Ar.

2. Experimental set-up and procedures.

Schematic design of the PMT test set-up is shown in Fig. 2. For the tests of PMT we used stainless steel vessel 30 cm in diameter and 40 cm high with gas-tight top cover. The vessel can keep up to 3 atm of overpressure. The top cover contains 3 metal-glass feedthroughs that were used to provide high voltage to the PMT under test, signal from the pulse generator to the light emission diode (LED), signals from the temperature sensors to the Lake Shore 336 temperature controller and voltage to the heater from the same controller.

Cryocooler Cryodyne 350CP by CTI-Cryogenics was used for cooling and liquefaction of Ar. PMT under test was installed inside a thermal insulating cylindrical case 10 cm in diameter and 35 cm high. The case has plastic PET (polyethylene terephthalate) bottle ~ 8 cm in diameter and ~ 30 cm high firmly attached inside. At the bottom the bottle has special support containing the LED for PMT cathode illumination. The whole inner assembly is shown at the photo in Fig. 3.

At the first stage we plan to put in the bottom PMT system seven PMT. Therefore seven R11065-10 and one R11065-MOD were purchased from Hamamatsu. The photo of both tubes is shown in Fig. 4 where different stem material can be distinguished: ceramic in R11065-10 and glass in R11065-MOD. 15 contacts from PMT were connected through the metal-glass feedthrough in the top cover to the resistive divider (12 dynodes, ground, anode and grid). The circuit of the divider can be found in [14].

Four R6041-506MOD-ASSY were tested out of 21 purchased from Hamamatsu. This PMT has resistive divider on it (see Fig. 4). The circuit of this divider can be found in [12].

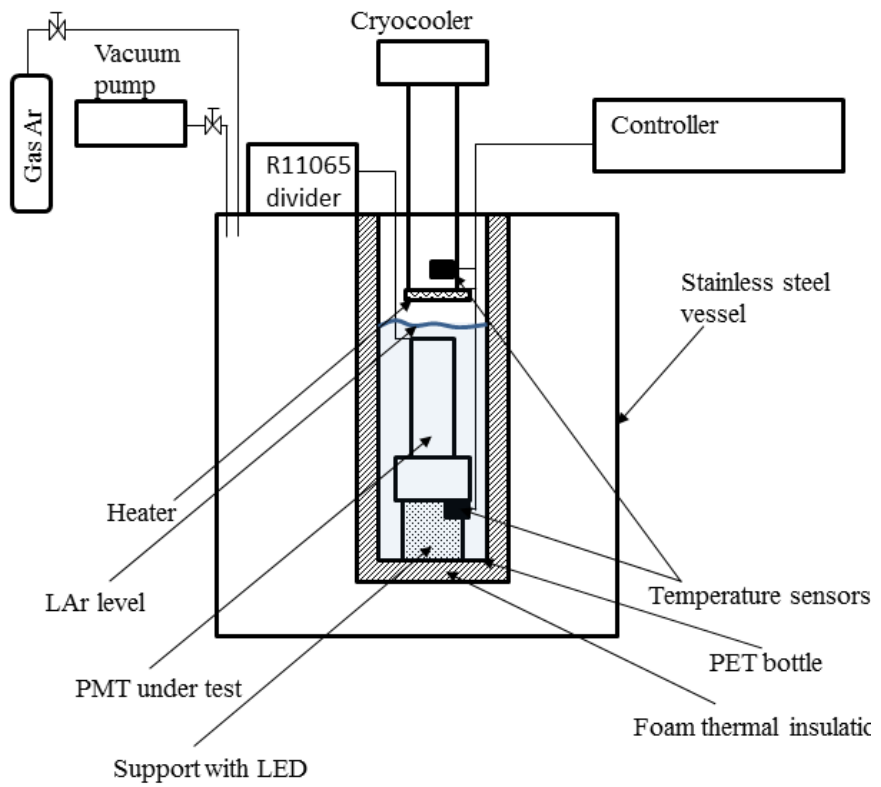

Figure 2. Schematic set-up for the PMT tests.

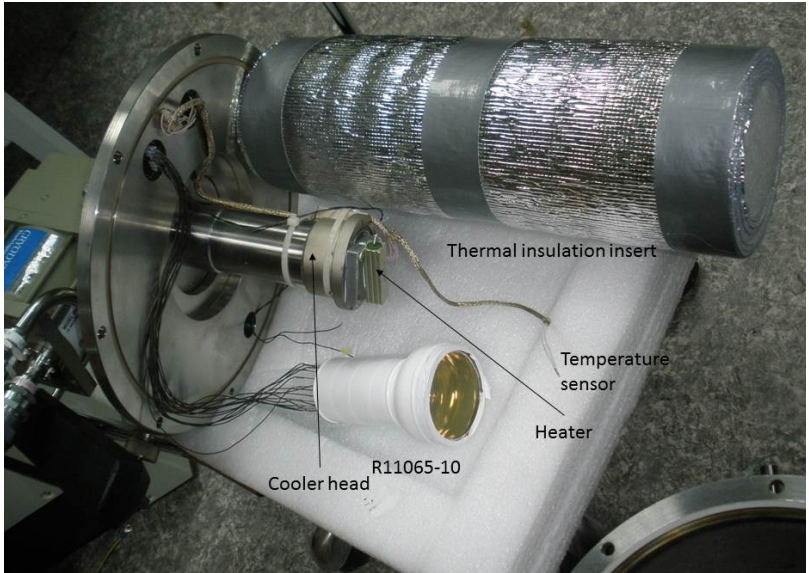

Figure 3. Inner assembly of the PMT test set-up.

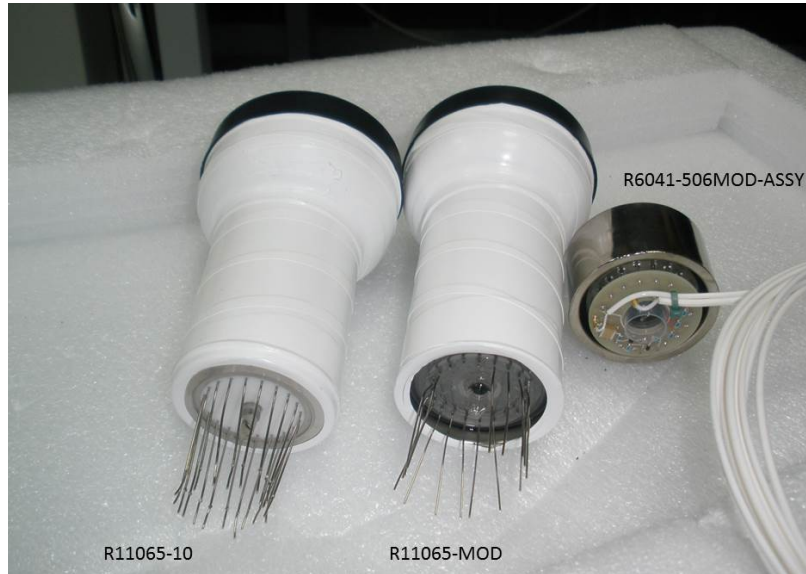

Figure 4. Photograph of R11065-10, R11065-MOD and R6041-506-ASSY PMT (from left to right).

Both R11065 and R6041-506MOD-ASSY PMTs were powered by positive voltage from N1470 CAEN high voltage power supply. Block-diagram of the electronics for PMT tests is shown in Fig. 5. Signal from PMT anode was amplified by a factor of 10 or 100 by CAEN N979 fast lin-

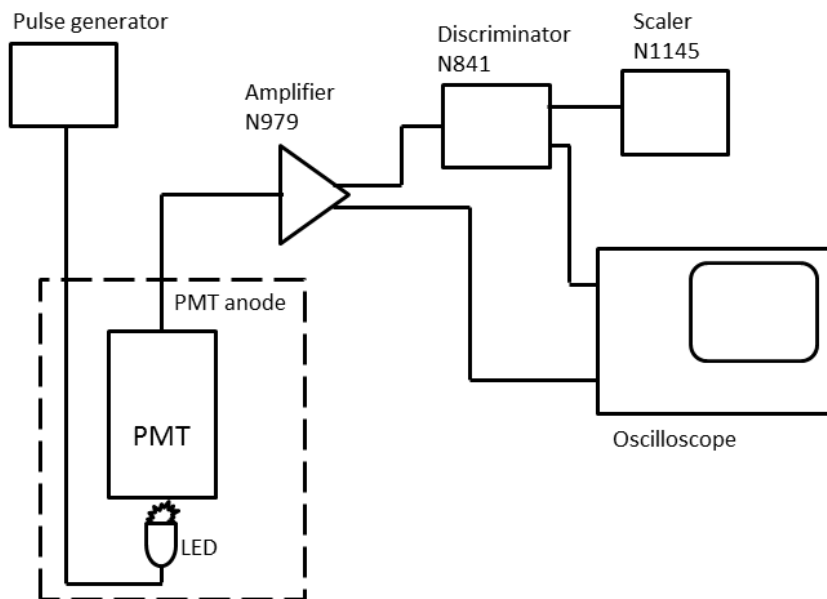

Figure 5. Block diagram of the electronics for PMT tests.

ear amplifier module. Then amplified signal was connected to oscilloscope Tektronix TDS5034B and to discriminator CAEN N841 for counting rate measurements by scaler CAEN N1145. Os-

illoscope was used for the measurements of waveforms and pulse height spectra. Signals were obtained from spontaneous emission of single electrons from photocathode or by illumination with LED. The LED was powered from pulse generator G5-78, and its light intensity could be tuned by changing pulse height and base line from the generator. The rate with LED did not exceed 5 kHz and the frequency of pulse generator was 50 kHz.

3. Results and discussion.

3.1 Results with R11065-10 and R11065-MOD PMTs.

Pulse shape of single electrons of spontaneous emission in R11065-10 is shown in Fig. 6. The signal is amplified by a factor of 100. The signal is fast with FWHM of ~ 7 ns and full width at 0.1 maximum around 12 ns. The pulse height spectrum of SER of spontaneous emission at room temperature is shown in Fig. 7 (black points). The spectrum is very well fitted by Gaussian distribution without any trace of double-electron peak.

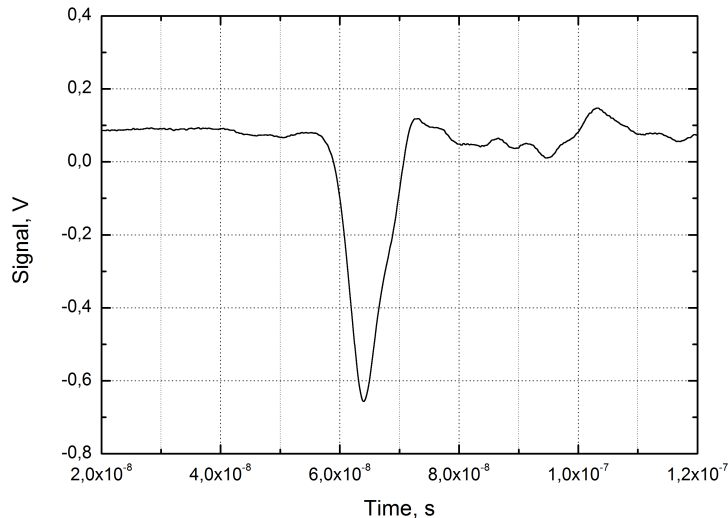

Figure 6. Single electron response from R11065-10. Anode voltage: 1500 V, gain: $\sim 10^7$. The signal is amplified by a factor of 100.

The rate of spontaneous emission is rather low at liquid Ar temperature, in particular for R6041-506MOD-ASSY tubes; therefore we used LED illumination to get single electron signals with reasonable rate (several kHz) for all further measurements. Figure 7 compares pulse height spectra from LED signals with those obtained from spontaneous emission at room temperature. We can see that both spectra are rather similar and the one corresponding to LED illumination does not contain any double-electron peak. SER spectra obtained with LED illumination at room temperature and at 87 K are also compared in Fig. 7. The spectra shapes are similar and the noise level is independent of temperature. The gain is higher at low temperature at a fixed anode voltage and this effect takes place for all tested PMTs (see below). The noise level in all the measurements was determined by radio-frequency pick-ups. The estimate of the first dynode gain, using data on

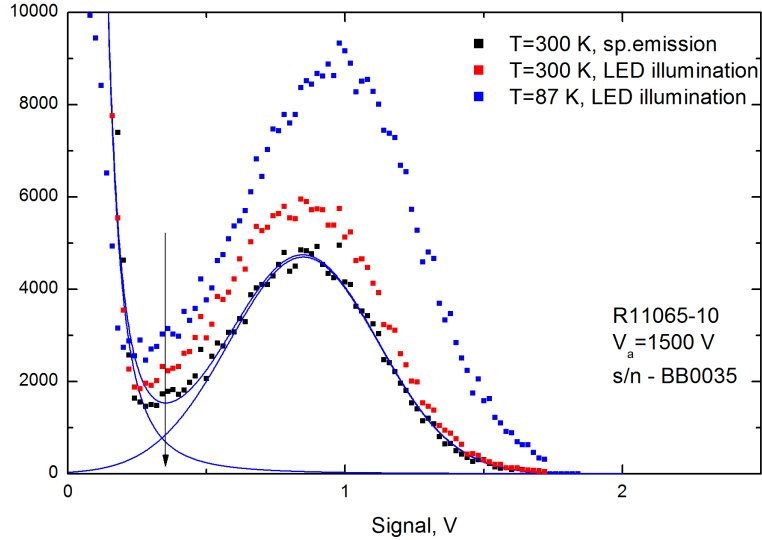

Figure 7. Pulse height spectra of SER obtained from spontaneous emission (black points) and with LED illumination at room temperature (red points) and at 87 K (blue points). Vertical arrow points to the threshold for calculation of the relative single electron efficiency. Anode voltage 1500 V, gain $\sim 10^7$.

secondary electron emission from ref. [15], gives the value of 7 to 9 at a total PMT gain of 10^6 to 10^7 correspondingly. In principle, the noise in Fig. 7 can be explained by the signals from thermal single electrons emitted from the first dynode, assuming that its amplification factor is 9. However, during the measurements the noise level did not change with the PMT gain, as it should be if single electrons from the first dynode are responsible for this.

Two of the seven tested R11065-10 tubes stopped functioning after operating for less than an hour at liquid Ar temperature. The results of dark count rate measurements for the remaining five R11065-10 tubes and one R11065-MOD tube are presented in Fig. 8. The discriminator threshold was tuned such that the counting rate with zero voltage on a PMT did not exceed 1 Hz and then kept constant during all the measurements.

The gain of the PMT was calculated from the measurements of the pulse height spectra of SER. At first the waveform was measured for each PMT: by integrating it and expressing the total charge in electrons, the relationship between the full charge and the pulse height was calculated. Then the pulse height spectra were measured and the most probable pulse height was found for each spectrum by fitting the Gaussian distribution (as in Fig. 7). The pulse height distribution of SER in PMT in the absence of external noise sources is mainly determined by multiplication statistics of the first dynode that is well described by Poisson distribution [16]. Poisson distribution with the average value of 7 to 9 is very close to that of Gaussian. Moreover, the rest dynodes and electronic noise smear the final distribution following in average the Gaussian law. Practically all measured SER spectra of R11065 PMTs had the peak to valley ratio much better than 2 (see Fig. 7) and the Gauss function was well fitted to the whole distribution but not only to the right slope.

The gain as a function of anode voltage for three R11065 PMTs is shown in Fig. 9. At the highest anode voltage of 1500 V the gain at liquid Ar temperature is within the range between

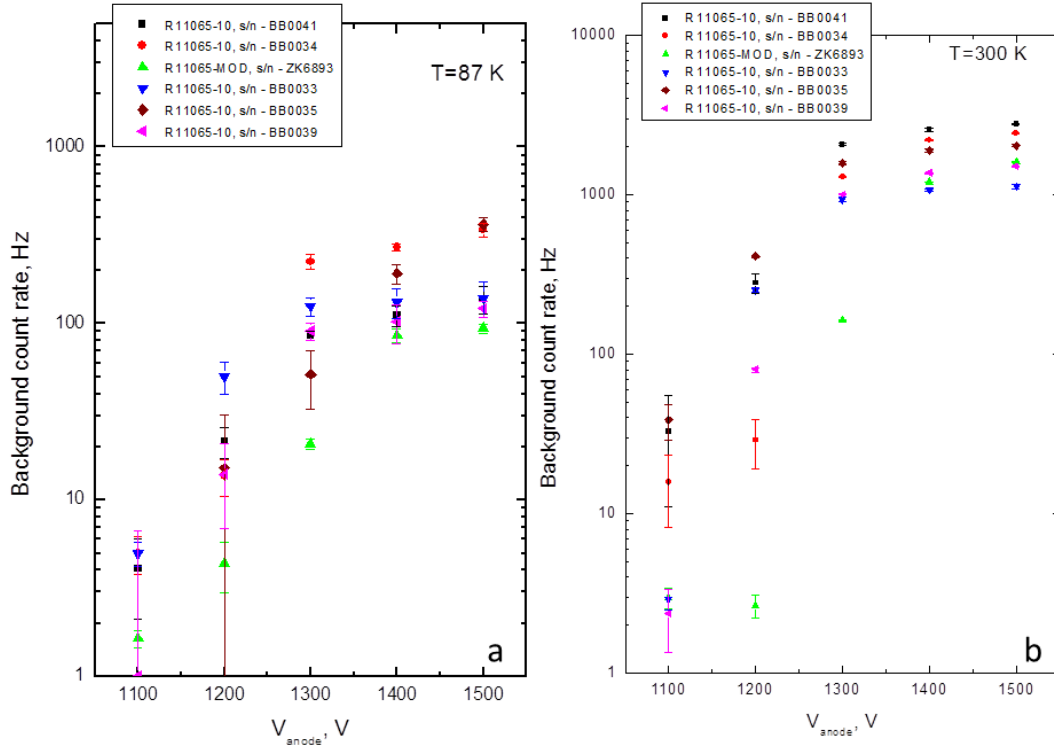

Figure 8. Dark count rate as a function of anode voltage for five R11065-10 and one R11065-MOD PMT: a - liquid Ar temperature, b - room temperature.

4×10^6 (for R11065-MOD) and 10^7 . For R11065-10 the gain at 1500 V is between 5×10^6 and 10^7 . For all the PMTs the gain at low temperature is 10-20% higher than at room temperature.

The resolution and the relative single electron detection efficiency as functions of gain are shown, for three PMTs with different maximum gains in Fig. 10. The pulse height resolution is calculated here as the ratio between FWHM of Gaussian fit and the mean value of the same fit. In the figure we can see that the resolution is improved with gain, reaching $\sim 50\%$ value. As a measure of fraction of single electron signals that can be detected above a certain threshold, the relative single electron detection efficiency is introduced. This value is calculated as a ratio between an integral of the Gaussian fit above the threshold and the full integral of the Gaussian fit. The threshold is put at the minimum of the fit to pulse height spectrum below the most probable value as shown in Fig. 7. Due to the rather good pulse height resolution the relative efficiency comes to plateau at gains above 5×10^6 and reaches the value above 99%.

3.2 Results with R6041-506MOD-ASSY PMT.

The typical signal from R6041-506MOD-ASSY is shown in Fig. 11. This PMT is about twice slower than R11065: FWHM of the waveform is ~ 14 ns and the width at 0.1 of maximum is about 20 ns. As R6041-506MOD-ASSY is slower PMT as compared to R11065, it has approximately twice lower average SE signal at the same gain. Dark count rate in this PMT is significantly lower

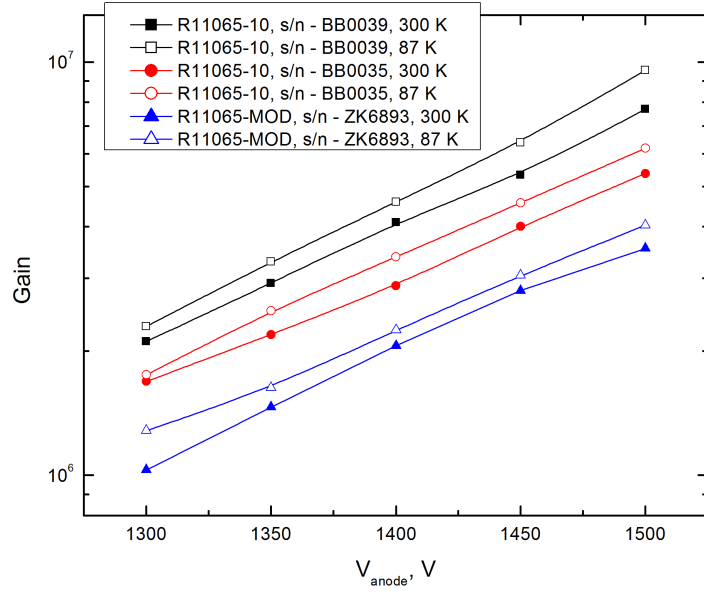

Figure 9. Gain as a function of anode voltage for two R11065-10 (one with the highest maximum gain and one with the lowest maximum gain) and one R11065-MOD PMT. Results for different PMTs are marked with different colors. Data corresponding to liquid Ar temperature are marked with open points.

than in R11065 (Fig. 13). At room temperature the dark count rate does not exceed 1 kHz at anode voltage of 900 V (the maximum recommended by the manufacturer is 1000 V). At liquid Ar temperature the dark count rate 10-30 times lower and does not exceed 50 Hz.

The gain for these PMTs was calculated from the measurements of waveforms and pulse height spectra in a similar way as for R11065 (Fig. 14). For calculation of the gain we used the average value of the fitted distribution but not the most probable value as for R11065. The estimate of the first dynode gain, using the data from ref. [15], gives the value of 4.5 to 5.5 for total gain of 10^6 to 10^7 . For fitting the SER distributions we used continuous function that follows Poisson distribution convolved with the Gaussian function:

$$y = A \frac{m^{\alpha x} e^{-m}}{\Gamma(\alpha x)} \otimes \text{Gauss}(\sigma, \alpha x) \quad (3.1)$$

where Γ is the Gamma function, Gauss is the Gaussian function and A, α and σ are the free parameters. The noise level was determined by radio frequency pick ups and was much higher than the level of SER signals from the first dynode. The gain in the range between 6×10^6 and 2×10^7 can be obtained for all tested PMTs of R6041-506MOD-ASSY at 900 V. Similarly to R11065 tubes, the gain values for R6041 at 87 K are 10-20% higher than at room temperature.

The R6041-506MOD-ASSY tube has lower the first dynode gain than in R11065 tube, that results in worse pulse height resolution of SER as well as lower relative single electron detection efficiency. The resolution was determined as the ratio of FWHM and mean value of the fitted

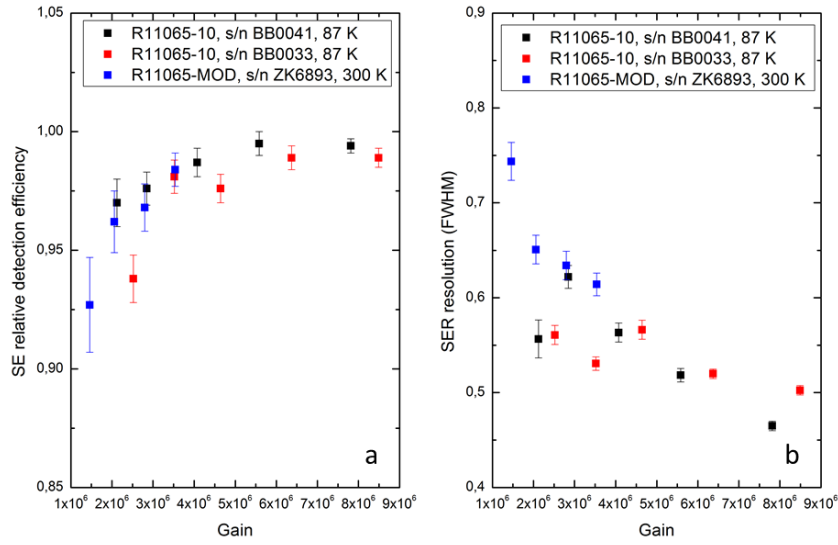

Figure 10. Relative detection efficiency of single electrons (a) and pulse height resolution of SER (b) in R11065 as a function of PMT gain. The data are shown for three PMTs with the lowest, medium and the highest maximum gain.

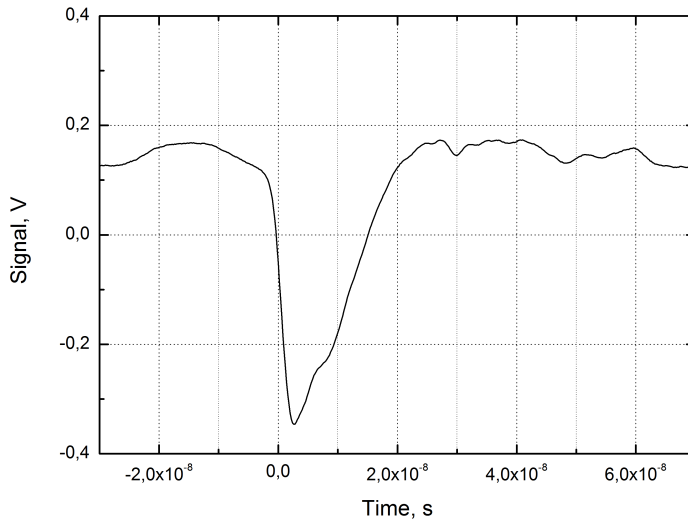

Figure 11. Typical signal from R6041-506MOD-ASSY PMT. Anode voltage 900 V, gain $\sim 10^7$. The signal is amplified by a factor of 100.

distribution. The resolution and relative single electron efficiency for two R6041-506 PMTs with the highest and the lowest maximum gains are shown in Fig. 15. We can see that the resolution is in average close to 1.1. The relative single electron detection efficiency is growing with gain and come to plateau at a gain of $\sim 6 \times 10^6$. The value of the relative SE efficiency on plateau is around

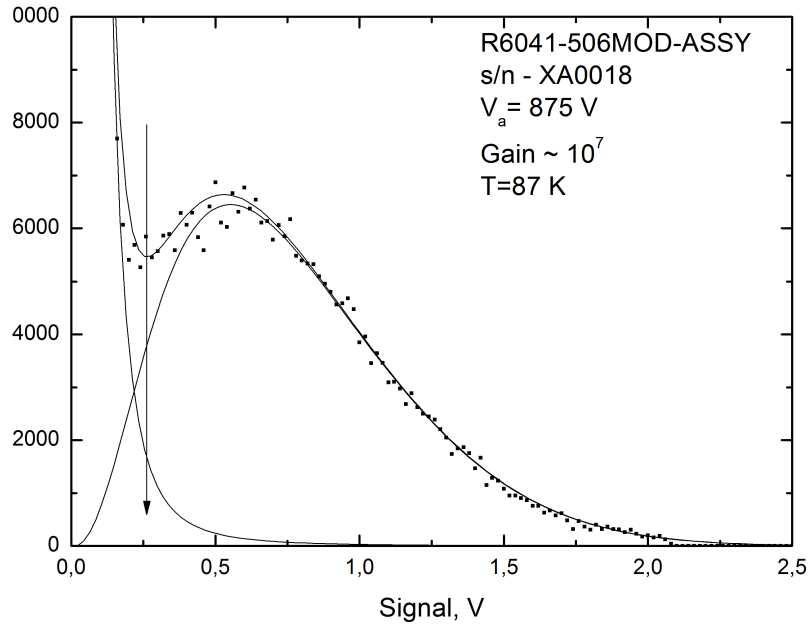

Figure 12. Pulse height spectrum of SER of R6041-506MOD-ASSY PMT. Anode voltage 875 V, gain $\sim 10^7$. Addition amplification of factor 100 is applied. Vertical arrow points to the threshold for calculation of the relative single electron detection efficiency.

95%.

4. Conclusions.

Low background cryogenic PMTs of R11065-10, R11065-MOD and R6041-506MOD-ASSY type, produced by Hamamatsu, were tested when fully immersed in liquid Ar. Devices of R11065 family demonstrated excellent performance in terms of SER resolution ($\sim 50\%$ FWHM) and relative single electron detection efficiency (99%). SER spectra and SE relative efficiency were for the first time measured for R6041-506MOD-ASSY PMTs immersed in liquid Ar. These PMTs have lower multiplication at the first dynode than R11065 and therefore they have worse pulse height resolution ($\sim 110\%$ FWHM) and relative single electron detection efficiency ($\sim 95\%$). The relative single electron detection efficiency depends on particular discriminator threshold that was set to minimize the noise. Therefore these values are specific for our particular set-up and noise sources in and around the laboratory. We consider that more than 90% of single electron detection efficiency is enough for successful operation of these devices in the two-phase CRAD and this value can be obtained for all types of investigated PMTs even in more noisy conditions. All PMTs demonstrated gain between 4×10^6 and 2×10^7 at the highest anode voltages applied. The dark count rate did not exceed 400 Hz for R11065 and 50 Hz for R6041 PMTs at liquid Ar temperature. In spite of excellent performance of R11065 devices, we observed breakdown in two R11065-10 tubes and returned them to the manufacturer for exchange. As far as we know the company is aware of this problem and considering the way to solve it [10].

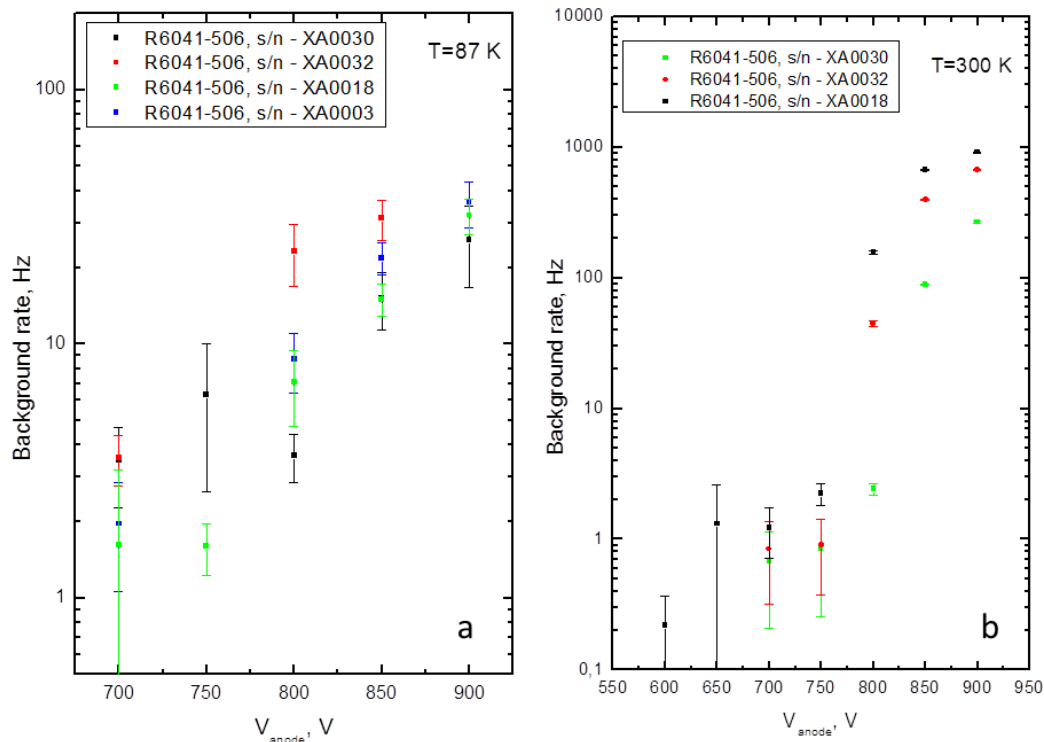

Figure 13. Dark count rate as a function of anode voltage for 4 R6041-506MOD-ASSY PMT: a - liquid Ar temperature, b - room temperature.

5. Acknowledgements

This study was supported by Russian Science Foundation (project N 14-50-00080).

References

- [1] A. Buzulutskov, Advances in Cryogenic Avalanche Detectors, 2012 JINST 7 C02025.
- [2] Bondar A. et al.. Study of infrared scintillations in gaseous and liquid argon. Part II: light yield and possible applications // J. of Instrumentation. 2012. V. 7., P06014.
- [3] A. Bondar, et al., Proposal for two-phase Cryogenic Avalanche Detector for dark matter search and low energy neutrino detection, Novosibirsk State University Bulletin, Series: Physics, V. 8, Iss. 3, P. 13 (2013) (in Russian).
- [4] D. Akimov, Detectors for Dark Matter search (Review), Nucl. Instrum. Meth. 598 (2009) 275.
- [5] C. Hagmann and A. Bernstein, Two-phase emission detector for measuring coherent neutrino-nucleus scattering, IEEE Trans. Nucl. Sci. 51 (2004) 2151 [nucl-ex/0411004].
- [6] D. Akimov et al., Detection of Reactor Antineutrino Coherent Scattering off Nuclei with a Two-Phase Noble Gas Detector, 2009 JINST 4 P06010.

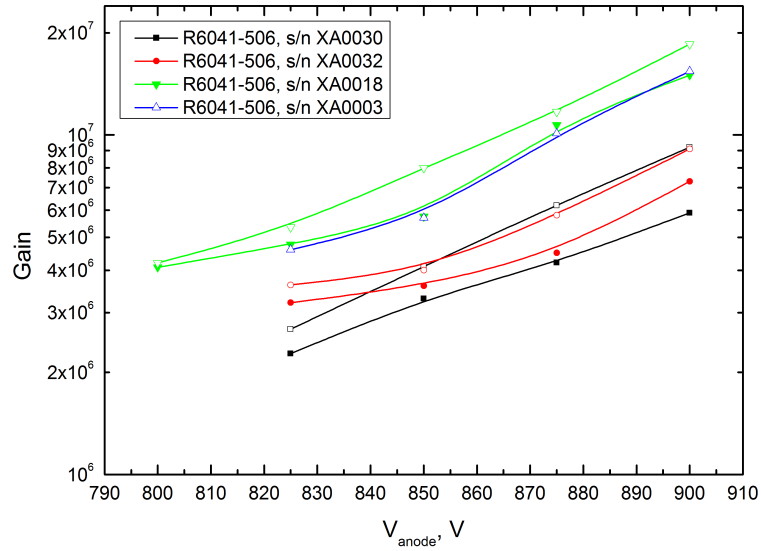

Figure 14. Gain as a function of anode voltage for 4 R6041-506MOD-ASSY PMT. Results for different PMT are marked with different colours. Data corresponding to liquid Ar temperature are marked with open points.

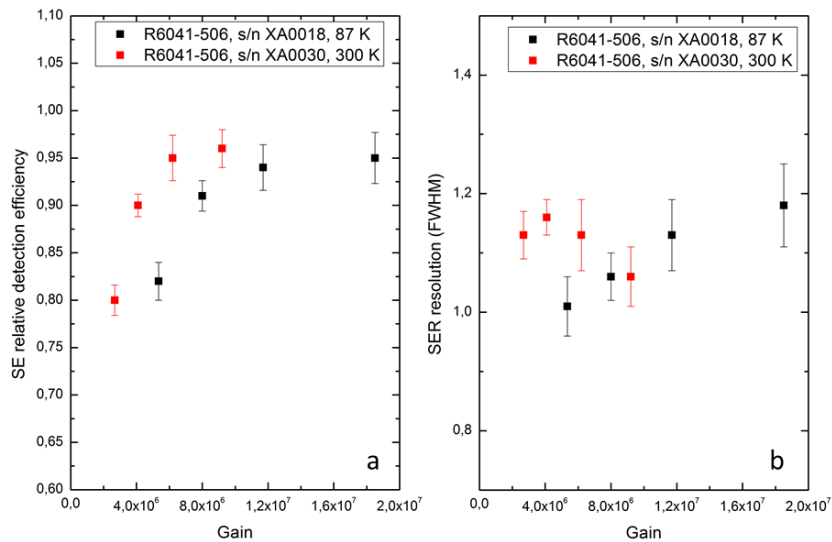

Figure 15. Relative detection efficiency of single electron (a) and pulse height resolution of SER (b) in R6041-506MOD-ASSY as a function of PMT gain for two PMTs with the lowest and the highest maximum gains.

- [7] A. Bondar et al., Measurement of the ionization yield of nuclear recoils in liquid argon at 80 and 233 keV, *Europhys. Lett.* 108 (2014) 12001.
- [8] A. Bondar et al., First demonstration of THGEM/GAPD-matrix optical readout in two-phase Cryogenic Avalanche Detector in Ar, *Nucl. Instrum. Meth. A* 732 (2013) 213 [arXiv:1303.4817].
- [9] R. Acciarri et al., Demonstration and comparison of photomultiplier tubes at liquid Argon temperature, *JINST* 7 (2012) P01016.
- [10] Y.Yoshizawa, Recent progress in vacuum photon detectors from Hamamatsu, report at the International Workshop on New Photon-detectors (PhotoDET 2012), 13-15 June 2012, Orsay, France.
- [11] G.Fiorillo, Catching the light from LAr, report at the 15th International Workshop on Next generation Nucleon Decay and Neutrino Detectors (NNN2014), 4-6 November 2014, Paris, France.
- [12] Hamamatsu Photonics, R6041-506MOD-ASSY Preliminary Data Sheet (2012)
- [13] O. Araoka, et.al., A tagged low-momentum kaon test-beam exposure with a 250L LAr TPC (J-PARC T32), arXiv:1105.5818v1 [physics.ins-det] 29 May 2011
- [14] <http://lartpc-docdb.fnal.gov/cgi-bin/RetrieveFile?docid=441;filename=R11065BaseSCHv3.pdf;version=1>
- [15] http://www.hamamatsu.com/resources/pdf/etd/PMT_handbook_v3aE-Chapter4.pdf
- [16] F.J.Lombard and F.Martin, Statistics of Electron Multiplication, *Rev. Sci. Instrum.* 32, 200 (1961).