

Dissertation

**On Time-Reversal Equivariant
Hermitian Operator Valued Maps
from a 2D-Torus Phase Space**

Moritz Schulte

May 1, 2022

Contents

Acknowledgements	3
1. Introduction	4
1.1. Outline	5
2. Equivariant Homotopy Classification	9
2.1. Maps to \mathcal{H}_2	11
2.1.1. Maps to S^2	15
2.1.2. Classification of Maps to \mathcal{H}_2^*	39
2.1.3. An Example from Complex Analysis	39
2.2. Maps to \mathcal{H}_n	41
2.2.1. Maps to \mathcal{H}_3	50
2.2.2. Iterative Retraction Method	56
2.2.3. Classification of Maps to \mathcal{H}_n^*	70
3. Topological Jumps	72
3.1. Maps into $\text{cl}(\mathcal{H}_2)$	74
3.1.1. Type I	75
3.1.2. Type II	83
3.2. Maps into $\text{cl}(\mathcal{H}_n)$	85
3.3. An Example from Physics	87
A. Appendix	90
A.1. Topology	90
A.2. Hausdorff Dimension	94
Notation	97
List of Figures	99
Bibliography	100

Acknowledgements

First of all, I would like to express my sincerest gratitude to my supervisor Professor Huckleberry. His help and guidance have been invaluable to me throughout the project. The mathematical discussions we shared were crucial to my progress, in particular when he helped with several of the proofs by suggesting key ideas. The work enabled me to grasp what mathematical research is like.

I would also like to thank my parents, my family and my friends for supporting me throughout my studies and research.

And finally, there is somebody whose role throughout the critical phase of my PhD project I would like to underline: Thank you, Christina, for your unwavering support, especially when some of the proofs had given me a hard time. Your part in the completion of this paper can hardly be overestimated.

This research was conducted as part of the the Sonderforschungsbereich TR12 (SFB TR12) “Symmetries and Universality in Mesoscopic Systems” and was partially financed by the Deutsche Forschungsgemeinschaft (DFG) for which I am very thankful.

1. Introduction

In this paper we are primarily concerned with the equivariant homotopy classification of maps from a torus phase space X to \mathcal{H}_n^* , the space of $n \times n$, non-singular hermitian operators. The equivariance is with respect to a time-reversal involution on X and an involution on \mathcal{H}_n^* defining a certain symmetry class. This is in contrast to related works in this area (e.g. [11]), which deal with the classification of equivariant maps defined on *momentum space*, where the time-reversal involution on momentum space is given by $k \mapsto -k$. Here we consider the model problem where the phase space is a 2-dimensional symplectic torus (X, ω) and the time-reversal involution T is antisymplectic, i. e.

$$T^*(\omega) = -\omega.$$

In this case it is known (see e.g. [16], [19]) that up to equivariant symplectic diffeomorphisms there are exactly three classes of antisymplectic involutions on X . Representatives for these three classes can be given by

$$[z] \mapsto [\bar{z}] \text{ , } [z] \mapsto [i\bar{z}] \text{ and } [z] \mapsto [\bar{z} + \frac{1}{2}],$$

where X is regarded as the square torus \mathbb{C}/Λ defined by the lattice $\Lambda = \langle 1, i \rangle_{\mathbb{Z}}$. In this paper we only deal with the first two involutions, as these are the only ones, which have fixed points. In particular, in local coordinates they are of the form

$$(q, p) \mapsto (q, -p).$$

We call the first one *type I* involution and the second one *type II* involution. On \mathcal{H}_n^* resp. \mathcal{H}_n we define the involution, which we also denote by T , to be

$$H \mapsto \bar{H} = {}^t H.$$

We believe, though, that the methods described in this paper, are also applicable, when X is equipped with a time-reversal involution coming from the third class of (free) antisymplectic involutions on X and when physically relevant image spaces other than (\mathcal{H}_n, T) are considered.

Letting G be the cyclic group C_2 of order two and X and \mathcal{H}_n be equipped as above with G -actions, our main results in chapter 2 give a complete description of the spaces

$$[X, \mathcal{H}_n^*]_G$$

of G -equivariant homotopy classes of maps $X \rightarrow \mathcal{H}_n^*$, where X is equipped with the type I or the type II involution. These descriptions are in terms of numerical topological invariants. It turns out that the topological invariant given by the *total degree* together with certain *fixed point degrees* defines a *complete* topological invariant of equivariant homotopy. Recall that an invariant is called *complete* if the equality of the invariants associated to two objects (equivariant maps in our case) implies the equivalence of the objects (the maps are equivariantly homotopic). It is important to emphasize that not all combinations of total degree and fixed point degrees are realizable; a certain elementary number theoretic condition is necessary and sufficient for the existence of a map with given invariants.

In chapter 3 we study the situation where a certain controlled degeneration is allowed. In formal terms this is a curve

$$f: [-1, 1] \times X \rightarrow \mathcal{H}_n$$

where the image $\text{Im}(f_t)$ is contained in \mathcal{H}_n^* for $t \neq 0$ and where the degeneration $f_0(x)$ being singular is only allowed at isolated points in X . The interesting case is where f_{-1} and f_{+1} are in distinct G -homotopy classes, i.e. where we have a sort of *jump curve*. In this case we show exactly which jumps are possible and produce maps with given jumps.

This research was carried out in the context of the interdisciplinary project SFB TR12. Thus we have attempted to present a work that is mostly self-contained; for the convenience of the reader, the appendix (Chapter A) includes some well-known background material.

1.1. Outline

The equivariant homotopy classification of maps $X \rightarrow \mathcal{H}_n^*$ is contained in chapter 2. We begin by identifying the connected components of \mathcal{H}_n^* . These are the subspaces $\mathcal{H}_{(p,q)}$ of the matrices with p positive and q negative eigenvalues ($p + q = n$). It follows that this *eigenvalue signature* (p, q) is a homotopy invariant of maps $X \rightarrow \mathcal{H}_n^*$ and the classification of maps to \mathcal{H}_n^* reduces to the classification of maps to $\mathcal{H}_{(p,q)}$, where (p, q) takes on all possible eigenvalue signatures. We then begin by examining the case where X is equipped with the type I involution and $n = 2$. An ad-hoc computation shows that $\mathcal{H}_{(2,0)}$ resp. $\mathcal{H}_{(0,2)}$ are equivariantly contractible to plus resp. minus the identity matrix, whereas $\mathcal{H}_{(1,1)}$ contains a $U(2)$ -orbit diffeomorphic to S^2 as equivariant strong deformation retract. The induced T -action on the sphere is given by a reflection along the x, y -plane. This motivates the need to classify equivariant maps $X \rightarrow S^2$. Also note that the 2-sphere can be equivariantly identified with the projective space \mathbb{P}_1 , on which the involution is the standard real structure given by complex conjugation. Since X and S^2 are both 2-dimensional manifolds, we obtain the (Brouwer) degree, which we call *total degree*, as a homotopy invariant of maps $X \rightarrow S^2$. The

equivariance requires that fixed point sets are mapped to fixed point sets. The fixed point set in the torus – for the type I involution – consists of two disjoint circles – C_0 and C_1 – while the fixed point set in the sphere consists of only the equator E . This defines two additional invariants of equivariant homotopy: The *fixed point degrees*, which are the degrees of the restrictions of the maps to the respective fixed point circles in X , regarded as maps to the equator. This gives rise the *degree triple map* \mathcal{T} , which sends an equivariant map $f: X \rightarrow S^2$ to the degree triple (d_0, d, d_1) , where d is the total degree of f and d_0, d_1 denote the fixed point degrees of f . A convenient property of the type I involution is the fact that a fundamental region for this involution is given by a *cylinder*, which we call Z . The boundary circles of the cylinder are the fixed point circles in X . Maps $(Z, C_0 \cup C_1) \rightarrow (S^2, E)$ can be uniquely equivariantly extended to the full torus X . It follows that the equivariant homotopy classification of maps $X \rightarrow S^2$ reduces to the (non-equivariant) homotopy classification of maps $(Z, C_0 \cup C_1) \rightarrow (S^2, E)$. We then regard maps from the cylinder $Z = I \times S^1$ to S^2 as *curves* in the free loop space $\mathcal{L}S^2$. After this translation of the problem and a certain normalization procedure on the boundary circles, we are dealing with the problem of computing homotopy classes of curves in $\mathcal{L}S^2$ (with fixed endpoints). The key point now is to define the *degree map*, which associates to curves in $\mathcal{L}S^2$ the degree of its equivariant extension to the full torus. The degree map factors through the space of homotopy class of curves. Furthermore it satisfies a certain compatibility condition with respect to the concatenation of curves. In particular, the degree map becomes a group homomorphism, when it is restricted to a based fundamental group. This can be used for proving that the restriction of the degree map to based fundamental groups is injective. The injectivity of this map is then the basis for the proof of the statement that maps with the same degree triple are equivariantly homotopic. To summarize the above: The degree triple map \mathcal{T} is well-defined on the set of equivariant homotopy classes of maps $X \rightarrow S^2$ and defines a bijection to a subset of \mathbb{Z}^3 . We call a degree triple, which is contained in the image of the degree triple map, *realizable*. As a preparation for describing the image of the degree triple map we express the concatenation of curves in $\mathcal{L}S^2$ in terms of a binary operation (“concatenation”) on the space of degree triples:

$$(d_0, d, d_1) \bullet (d_1, d', d_2) = (d_0, d + d', d_2).$$

This concatenation operation is only defined for degree triples which are compatible in the sense that the fixed point degrees in the middle coincide. Using this formalism we observe that the image of the degree triple map $\text{Im}(\mathcal{T})$ is closed under the concatenation operation. Furthermore we show that certain basic triples, e. g. $(0, 1, 0)$, are not contained in the image of the degree triple map. These are the key tools for completely describing the image $\text{Im}(\mathcal{T})$ using the formalism of degree triple concatenations. It turns out that the number theoretic condition

$$d \equiv d_0 + d_1 \pmod{2} \tag{1.1}$$

is sufficient and necessary for a degree triple (d_0, d, d_1) to be in the image of the degree triple map. This completely solves the problem for the type I involution in the case $n = 2$.

In the next step we reduce the classification problem for the type II involution to the type I classification. The key observation here is that maps $X \rightarrow S^2$, where X is equipped with the type II involution, can be normalized on a subspace $A \subset X$ such that they push down to the quotient X/A , which happens to be equivariantly diffeomorphic to S^2 . The action on the 2-sphere is again given by a reflection along the x, y -plane. After another normalization procedure, concerning the images of the two poles of S^2 , we prove a one-to-one correspondence between equivariant maps $S^2 \rightarrow S^2$ and equivariant maps from a torus equipped with the type I involution to S^2 having the one fixed point degree be zero. This allows us to use the results for the type I involution. In particular it implies that we are dealing with degree *pairs* instead of degree triples. The degree pair map associates to an equivariant map $f: X \rightarrow S^2$ its degree pair (d, d_C) where d_C is the fixed point degree and d the total degree of f . Because of this correspondence between maps defined on a type II torus and maps defined on a type I torus, the condition (1.1) for degree triples to be in the image of the degree triple map induces a corresponding condition for a pair (d, d_C) to be in the image of the degree pair map:

$$d \equiv d_C \pmod{2}. \tag{1.2}$$

This completes the case $n = 2$ for both involutions.

For the general case $n > 2$ we begin with an examination of the connected components $\mathcal{H}_{(p,q)}$ of \mathcal{H}_n^* . As in the case $n = 2$ we prove that the components $\mathcal{H}_{(n,0)}$ and $\mathcal{H}_{(0,n)}$ are equivariantly contractible to a point. Fundamental for the following considerations is the result that the components $\mathcal{H}_{(p,q)}$ with $0 < p, q < n$ have a $U(n)$ -orbit as equivariant strong deformation retract, where $U(n)$ acts on $\mathcal{H}_{(p,q)}$ by conjugation. This orbit is equivariantly diffeomorphic to the complex Grassmann manifold $\text{Gr}_p(\mathbb{C}^n)$ on which the involution T acts as

$$V \mapsto \bar{V}.$$

Thus, the problem of classifying equivariant maps $X \rightarrow \mathcal{H}_{(p,q)}$ is equivalent to classifying equivariant maps $X \rightarrow \text{Gr}_p(\mathbb{C}^n)$. Now we fix the standard flag in \mathbb{C}^n and consider the – with respect to this flag – unique (complex) one-dimensional Schubert variety \mathcal{S} in $\text{Gr}_p(\mathbb{C}^n)$. In this situation we prove, using basic Hausdorff dimension theoretical results, that it is possible to iteratively remove certain parts of the Grassmann manifold $\text{Gr}_p(\mathbb{C}^n)$ so that in the end we obtain an equivariant strong deformation retract to the Schubert variety \mathcal{S} . The latter is equivariantly biholomorphic to the complex projective space \mathbb{P}_1 equipped with the standard real structure. This allows us to use the results for the $n = 2$ case. In terms of the invariants, the only difference between the case $n = 2$ and $n > 2$ is that in the former case the fixed point degrees are integers

from the set \mathbb{Z} while in the latter case they are only from the set $\{0, 1\}$. This stems from the fact that in the case $n > 2$ the fundamental group of the T -fixed points in the Grassmann manifold is not infinite cyclic anymore, but cyclic of order two. In this setup, the conditions for degree triples resp. pairs to be realizable are exactly (1.1) and (1.2). This completes the classification of equivariant maps $X \rightarrow \mathcal{H}_n^*$.

In chapter 3 we construct curves

$$H: [-1, 1] \times X \rightarrow \mathcal{H}_n$$

of equivariant maps with the property that the image $\text{Im}(H_t)$ is contained in \mathcal{H}_n^* for $t \neq 0$ and H_{-1} and H_{+1} are not equivariantly homotopic as maps to \mathcal{H}_n^* . This is only possible if we allow a certain degeneration at $t = 0$, which means that there exists a non-empty *singular set* $S(H_0)$ consisting of the points $x \in X$ such that the matrix $H_0(x)$ is singular. To make the construction non-trivial we require the singular set $S(H_0)$ to be discrete. As in the previous chapter we first consider the type I involution in the special case $n = 2$. As a first result we obtain that jump curves from H_{-1} to H_{+1} with discrete singular set can only exist if the eigenvalue signatures of H_{-1} and H_{+1} coincide. Hence we fix an eigenvalue signature (p, q) . The construction of *jump curves* is based on the decomposition of degree triples as a concatenation of simpler triples. First we show how to construct jumps for certain “model maps” for basic degree triples. Subsequently we extend this method such that we can construct jumps from any equivariant homotopy class to any other – as long as the eigenvalue signature remains unchanged.

For the type II involution in the case $n = 2$, we can employ the same correspondence that has been used during the homotopy classification to turn jump curves for the type I involution into corresponding jump curves for the type II involution. This completes the construction of jump curves in the case $n = 2$.

For the general case $n > 2$ we construct jump curves using the embedding of the Schubert variety $\mathcal{S} \cong \mathbb{P}_1$ into $\text{Gr}_p(\mathbb{C}^n)$. In other words: The jump curves we construct in the higher dimensional situation really come from jump curves in the case $n = 2$.

2. Equivariant Homotopy Classification

As indicated in the introduction, we may regard the torus X as being defined by the standard square lattice $\Lambda = \langle 1, i \rangle_{\mathbb{Z}}$. As a complex manifold it carries a canonical orientation. Furthermore, we regard X as being equipped with the real structure $T([z]) = [\bar{z}]$ (type I) or with the real structure $T([z]) = [i\bar{z}]$ (type II). Recall that G denotes the cyclic group C_2 of order two. The G -action on \mathcal{H}_n is assumed to be given by matrix transposition or – equivalently – complex conjugation:

$$\begin{aligned} T: \mathcal{H}_n &\rightarrow \mathcal{H}_n \\ H &\mapsto {}^t H = \bar{H}. \end{aligned}$$

The goal in this chapter is to completely describe the sets $[X, \mathcal{H}_n^*]_G$ of G -equivariant homotopy classes of maps $X \rightarrow \mathcal{H}_n^*$ ($n \geq 2$). Recall the basic definition of equivariant homotopy:

Definition 2.0.1 Let X and Y be two G -spaces and $f_0, f_1: X \rightarrow Y$ two G -maps. Note that $I \times X$ (I is the unit interval $[0, 1]$) can be regarded as a G -space by defining $T(t, x) = (t, T(X))$. Then f_0 and f_1 are said to be G -homotopic (or *equivariantly homotopic*¹) if there exists a G -map $f: I \times X \rightarrow Y$ such that $f(0, \cdot) = f_0$ and $f(1, \cdot) = f_1$.

The first invariant of maps $X \rightarrow \mathcal{H}_n^*$ we consider is the *eigenvalue signature*. We begin with the following

Definition 2.0.2 Let H be a non-singular $n \times n$ matrix and

$$\lambda_1^+ \geq \dots \geq \lambda_p^+ > 0 > \lambda_1^- \dots \geq \lambda_q^-$$

the eigenvalues of H (repetitions allowed). Then we call (p, q) the *eigenvalue signature* (or simply *signature*) of H and set $\text{sig } H = (p, q)$.

The connected components of the space \mathcal{H}_n^* are the $n + 1$ open subspaces $\mathcal{H}_{(p,q)}$, where

$$\mathcal{H}_{(p,q)} = \{H \in \mathcal{H}_n^* : \text{sig } H = (p, q)\}.$$

Thus we can write

$$[X, \mathcal{H}_n^*]_G = \dot{\bigcup}_{p+q=n} [X, \mathcal{H}_{(p,q)}]_G.$$

¹We use the terms “ G -homotopy” and “equivariant homotopy” interchangeably.

In particular this means that the signature $\text{sig}(H)$ for maps $H: X \rightarrow \mathcal{H}_n^*$ is well-defined and a topological invariant. It turns out that the components $\mathcal{H}_{(n,0)}$ and $\mathcal{H}_{(0,n)}$ are equivariantly contractible but the components $\mathcal{H}_{(p,q)}$ with $0 < p, q < n$ are topologically interesting as they have Grassmann manifolds as equivariant strong deformation retract. The classification of maps to a component $\mathcal{H}_{(p,q)}$ for a fixed (non-definite) eigenvalue signature (p, q) is in this way reduced to the problem of classifying equivariant maps to complex Grassmann manifolds $\text{Gr}_p(\mathbb{C}^n)$ on which the G -action is given by standard complex conjugation.

As a preparation for proving a general statement about the set $[X, \mathcal{H}_n^*]_G$, we first consider the special case $n = 2$ (theorem 2.1.51, p. 39). As mentioned earlier, the only non-trivial cases occur for maps whose images are contained in the components $\mathcal{H}_{(p,q)}$ of mixed signature. In the case $n = 2$ this boils down to $\mathcal{H}_{(1,1)}$. This space has the 2-sphere, equipped with the involution given by a reflection along the x, y -plane, as equivariant strong deformation retract.² Thus, the problem of describing $[X, \mathcal{H}_{(1,1)}]_G$ is reduced to classifying equivariant maps $X \rightarrow S^2$. We do this for the type I and the type II involution separately, but it turns out that the type II case can be reduced to the type I case (see theorem 2.1.32 and theorem 2.1.50). The result is that for both involutions the complete invariants of maps $X \rightarrow S^2$ consist of two pieces of data: First the *total degree* d (which is also an invariant of non-equivariant homotopy) and second the so-called *fixed point degrees* – two integers (named d_0, d_1) for the type I involution and one integer (named d_C) for the type II involution. Note that the notion of fixed point degree only makes sense for *equivariant* maps, as they are required to map the fixed point set in X into the fixed point set in S^2 . Furthermore we obtain the statement that not all combinations of total degree and fixed point degrees are realizable by G -maps. As mentioned in the introduction, the conditions which are sufficient and necessary are $d \equiv d_0 + d_1 \pmod{2}$ for the type I involution and $d \equiv d_C \pmod{2}$ for the type II involution.

After having proven a classification statement for $n = 2$, we observe that this case is really the fundamental case to which the general case (n arbitrary) can be reduced to by means of a retraction argument. In each Grassmannian $\text{Gr}_p(\mathbb{C}^n)$ there exists a Schubert variety $\mathcal{S} \cong \mathbb{P}_1$; after fixing a full flag in \mathbb{C}^n , this is the unique one-dimensional (over \mathbb{C}) Schubert variety which generates the second homology groups $H_2(\text{Gr}_p(\mathbb{C}^n), \mathbb{Z})$. After iteratively cutting out certain parts of a general Grassmannian $\text{Gr}_p(\mathbb{C}^n)$ we obtain an equivariant retraction to this embedded Schubert variety. It can be equivariantly identified with \mathbb{P}_1 on which the involution is given by the standard real structure:

$$[z_0 : z_1] \mapsto [\bar{z}_0 : \bar{z}_1]$$

This space can be equivariantly identified with S^2 . Hence, we can use the previous results for the case $n = 2$.

²The 2-sphere is regarded as being embedded as the unit sphere in \mathbb{R}^3

2.1. Maps to \mathcal{H}_2

In this section we provide a complete description of the set $[X, \mathcal{H}_2^*]_G$, where X is equipped with a real structure T , which is either the type I or the type II involution. This case is of particular importance, since all the other cases (i.e. $n > 2$) can be reduced to this one. Note that a general equivariant map $H: X \rightarrow \mathcal{H}_2$ is of the form

$$H = \begin{pmatrix} a_1 & b \\ \bar{b} & a_2 \end{pmatrix}, \quad (2.1)$$

where a_1, a_2 are functions $X \rightarrow \mathbb{R}$ and b is a function $X \rightarrow \mathbb{C}$ satisfying

$$a_j \circ T = a_j \text{ for } j = 1, 2 \quad (2.2)$$

$$b \circ T = \bar{b} \quad (2.3)$$

A map into \mathcal{H}_n^* has the additional property that $\det H = a_1 a_2 - |b|^2$ is nowhere zero. As we have mentioned previously, the space \mathcal{H}_2^* decomposes into the disjoint union

$$\mathcal{H}_{(2,0)} \dot{\cup} \mathcal{H}_{(1,1)} \dot{\cup} \mathcal{H}_{(0,2)},$$

where $(2,0)$, $(1,1)$ and $(0,2)$ are the possible eigenvalue signatures for maps $X \rightarrow \mathcal{H}_n^*$. First we note:

Remark 2.1.1 The components $\mathcal{H}_{(2,0)}$ and $\mathcal{H}_{(0,2)}$ have $\{\pm \mathbb{E}_2\}$ as equivariant strong deformation retract.³

Proof. It suffices to consider the component $\mathcal{H}_{(2,0)}$, as the proof for the other is exactly the same. We define the following strong deformation retract:

$$\begin{aligned} \rho: I \times \mathcal{H}_{(2,0)} &\rightarrow \mathcal{H}_{(2,0)} \\ (t, H) &\mapsto (1-t)H + t\mathbb{E}_2. \end{aligned}$$

We have to check that ρ really maps into $\mathcal{H}_{(2,0)}$. For this, let H be any positive-definite hermitian matrix. Then $(1-t)H$ is also positive-definite for $t \in (0,1)$. If $\det((1-t)H + t\mathbb{E}_2) = 0$, this means that the negative number $-t$ is an eigenvalue of $(1-t)H$, which is a contradiction. Equivariance of ρ_t follows from the fact that the equivariance conditions (2.2) and (2.3) are compatible with scaling by real numbers. \square

At this point we begin using the space $i\mathfrak{su}_2$, which is the vector space of traceless hermitian operators:

$$i\mathfrak{su}_2 = \left\{ \begin{pmatrix} a & b \\ \bar{b} & -a \end{pmatrix} : a \in \mathbb{R} \text{ and } b \in \mathbb{C} \right\}.$$

³Here, \mathbb{E}_k is the $k \times k$ identity matrix.

It can be identified with \mathbb{R}^3 via the linear isomorphism

$$\Psi: \begin{pmatrix} a & b \\ \bar{b} & -a \end{pmatrix} \mapsto \begin{pmatrix} a \\ \operatorname{Re}(b) \\ \operatorname{Im}(b) \end{pmatrix}. \quad (2.4)$$

We regard \mathbb{R}^3 as being equipped with the involution, which reflects along the x, y -plane:

$$\begin{pmatrix} x \\ y \\ z \end{pmatrix} \mapsto \begin{pmatrix} x \\ y \\ -z \end{pmatrix}.$$

With respect to this action, the diffeomorphism $isu_2 \xrightarrow{\sim} \mathbb{R}^3$ is equivariant. Regarding the topology of the component $\mathcal{H}_{(1,1)}$ we state:

Remark 2.1.2 The component $\mathcal{H}_{(1,1)}$ has $isu_2 \setminus \{0\}$ as equivariant, strong deformation retract.

Proof. A general matrix in isu_2 is of the form

$$\begin{pmatrix} a & b \\ \bar{b} & -a \end{pmatrix}$$

with a real and b complex. Its eigenvalues are

$$\pm \sqrt{a^2 + |b|^2}.$$

This implies that $isu_2 \setminus \{0\}$ is contained in $\mathcal{H}_{(1,1)}$. Now we prove that $\mathcal{H}_{(1,1)}$ has the space $isu_2 \setminus \{0\}$ as equivariant, strong deformation retract. A computation shows that the two eigenvalue functions λ_1, λ_2 of the general map H (2.1) are

$$\lambda_{1,2} = \frac{a_1 + a_2}{2} \pm \sqrt{\left(\frac{a_1 + a_2}{2}\right)^2 + |b|^2 - a_1 a_2}.$$

It is a straightforward computation to show that $\det H > 0$ implies that H is positive or negative definite. From this we can conclude that the eigenvalue signature being $(1, 1)$ implies $\det H < 0$, that is $|b|^2 - a_1 a_2 > 0$. Now define

$$c = \frac{a_1 + a_2}{2}$$

and consider the strong deformation retract

$$\begin{aligned} \rho: I \times \mathcal{H}_{(1,1)} &\rightarrow \mathcal{H}_{(1,1)} \\ (t, H) &\mapsto (1-t)H - tcE_2. \end{aligned}$$

For this to be well-defined we need $\det(\rho(t, H)) < 0$ for all t and H :

$$\begin{aligned}\det(\rho(t, H)) &= (a_1 - tc)(a_2 - tc) - |b|^2 \\ &= a_1 a_2 - |b|^2 - tc(a_1 + a_2) + (tc)^2 \\ &< -tc(a_1 + a_2) + (tc)^2 \\ &= -\frac{(a_1 + a_2)^2}{2} + t\frac{(a_1 + a_2)^2}{4} \\ &= \left(\frac{a_1 + a_2}{2}\right)^2 (t - 2) < 0.\end{aligned}$$

Furthermore, ρ stabilizes $i\mathfrak{su}_2 \setminus \{0\}$ and $\rho(1, \mathcal{H}_{(1,1)}) = i\mathfrak{su}_2 \setminus \{0\}$. As in the previous remark, equivariance of ρ_t follows since the equivariance conditions (2.2) and (2.3) are compatible with scaling by real numbers. \square

Clearly, the isomorphism Ψ maps the zero matrix to the origin. The space $\mathbb{R}^3 \setminus \{0\}$ has the unit 2-sphere as equivariant strong deformation retract. Under Ψ this corresponds to the $U(2)$ orbit of $\mathbb{E}_{1,1} = \text{Diag}(1, -1)$ in $i\mathfrak{su}_2$. This orbit consists of the matrices

$$\left\{ \begin{pmatrix} |a|^2 - |b|^2 & 2a\bar{c} \\ 2\bar{a}c & |b|^2 - |a|^2 \end{pmatrix} : \text{where } \begin{pmatrix} a & b \\ c & d \end{pmatrix} \text{ is unitary.} \right\}$$

This proves the following

Proposition 2.1.3 The space $i\mathfrak{su}_2 \setminus \{0\}$ has the $U(2)$ -orbit of $\mathbb{E}_{1,1}$ as equivariant strong deformation retract. The above isomorphism Ψ equivariantly identifies the $U(2)$ -orbit with the unit sphere in \mathbb{R}^3 on which the involution acts as a reflection along the x, y -plane. \square

This reduces the classification problem to the classification of equivariant maps $X \rightarrow S^2$. In order to discuss mapping degrees of maps to S^2 we need to fix an orientation on the sphere and on its equator E . We choose the orientation on S^2 to be defined by an outer normal vector field on the sphere. Furthermore we define the orientation on the equator E to be such that the loop

$$\begin{aligned}S^1 &\rightarrow E \subset S^2 \subset \mathbb{R}^3 \\ z &\mapsto \begin{pmatrix} \cos(\arg z) \\ \sin(\arg z) \\ 0 \end{pmatrix}\end{aligned}\tag{2.5}$$

has positive degree⁴. Later, when discussing the case $n > 2$, it will become important to equivariantly identify S^2 with the projective space \mathbb{P}_1 . The action on \mathbb{P}_1 is

⁴These choices are arbitrary. Choosing the opposite orientation on the sphere or on the equator only changes the signs appearing in concrete examples, but not the general discussion.

given by standard complex conjugation

$$[z_0 : z_1] \mapsto [\bar{z}_0 : \bar{z}_1].$$

Note that \mathbb{P}_1 is canonically oriented as a complex manifold. Let ψ be an equivariant, orientation-preserving diffeomorphism $S^2 \rightarrow \mathbb{P}_1$. This identifies the compactified real line $\widehat{\mathbb{R}}$ with the equator E . We can assume that this identification of S^2 with \mathbb{P}_1 is such that a loop of degree +1 into the compactified real line $\widehat{\mathbb{R}} \subset \mathbb{P}_1$ is given by

$$S^1 \rightarrow \mathbb{R}\mathbb{P}_1$$

$$z \mapsto \begin{cases} \infty & \text{if } \arg(z) \in 2\pi\mathbb{Z} \\ \tan\left(\frac{\arg z - \pi}{2}\right) & \text{else} \end{cases}.$$

That is, the loop starts at ∞ , then traverses the negative real numbers until it reaches zero, then it traverses the positive real numbers until it reaches ∞ again.

As indicated in the introduction, the relevant topological invariants of maps $X \rightarrow S^2$ consist of two pieces of data:

1. The *total degree*, which is the usual Brouwer degree, and
2. The *fixed point degrees*, which are the Brouwer degrees of the restrictions of the maps to the components of the fixed point sets of the respective involution on X .

For the type I involution this fixed point set consists of two disjoint circles. Hence we obtain *degree triples* of the form (d_0, d, d_1) as invariants, where the d_j are the fixed point degrees and d is the total degree. For the type II involution the fixed point set is a single circle, which is why the invariants we work with are *degree pairs* of the form (d, d_C) (d being the total degree and d_C the fixed point degree). We call a degree triple resp. a degree pair *realizable* if it occurs as invariant of a G -maps. The exact definitions will be given in definition 2.1.25 and definition 2.1.38.

The main result in this section is the following

Theorem 2.1.51 Let X be a torus equipped with either the type I or the type II involution. Then:

- (i) The sets $[X, \mathcal{H}_{(2,0)}]_G$ and $[X, \mathcal{H}_{(0,2)}]_G$ are trivial (i. e. one-point sets).
- (ii) Two G -maps $X \rightarrow \mathcal{H}_{(1,1)}$ are G -homotopic iff their degree triples (type I) resp. their degree pairs (type II) agree.
- (iii) The realizable degree triples (d_0, d, d_1) (type I) resp. degree pairs (d, d_C) (type II) are exactly those which satisfy

$$d \equiv d_0 + d_1 \pmod{2} \quad \text{resp.} \quad d \equiv d_C \pmod{2}.$$

The proof will be given in section 2.1.2 (p. 39).

2.1.1. Maps to S^2

After the reduction described above, we can regard G -maps $X \rightarrow \mathcal{H}_{(1,1)}$ as having their image contained in the oriented 2-sphere $S^2 \subset \mathbb{R}^3$. Throughout this section we use a fixed orientation-preserving identification of the equator E with S^1 . Furthermore, we let $p_0 \in E$ be the fixed base point in the equator, which corresponds – under this identification – to $1 \in S^1$. This point will be used later for bringing the maps into a convenient “normal form”. We will make frequent use of the following theorem:

Theorem 2.1.4 Let M be a closed, n -dimensional manifold. Then maps $M \rightarrow S^n$ are homotopic if and only if their degrees agree.

Proof. See e. g. [14, p. 50]. □

An important tool for the classification will be the study of homotopies on the fixed point sets. For this we start with a general definition:

Definition 2.1.5 (Fixed point degree) Let $f: M \rightarrow Y$ be a G -map between G -manifolds. Assume that the fixed point set Y^G is a closed, oriented manifold K of dimension m and that the fixed point set M^G is the disjoint union

$$M^G = \bigcup_{j=0, \dots, k} K_j$$

of closed, oriented (connected) manifolds K_j each of dimension m . Then we define the *fixed point degrees* to be the k -tuple (d_0, \dots, d_k) where d_j is the degree of the map $f|_{K_j}: K_j \rightarrow K$.

Remark 2.1.6 The fixed point degrees are invariants of G -homotopies.

Proof. Let M and Y be two G -manifolds as in definition 2.1.5 and let f, f' be two G -homotopic maps $M \rightarrow Y$. Denote by (d_0, \dots, d_k) resp. (d'_0, \dots, d'_k) their fixed point degrees. Assume that $d_j \neq d'_j$ for some j . By assumption, there exists a G -homotopy $H: I \times X \rightarrow Y$ from f to f' . This homotopy can be restricted to $I \times K_j$, which can be regarded as a homotopy $h: I \times K_j \rightarrow K$. The degree d_j is the degree of the map h_0 and d'_j is the degree of the map h_1 . But the degree is a homotopy invariant, hence $d_j \neq d'_j$ yields a contradiction. □

From now on we handle the involution types I and II separately.

2.1.1.1. Type I

In this section the real structure T on X is the type I involution:

$$\begin{aligned} T: X &\rightarrow X \\ [z] &\mapsto [\bar{z}]. \end{aligned}$$

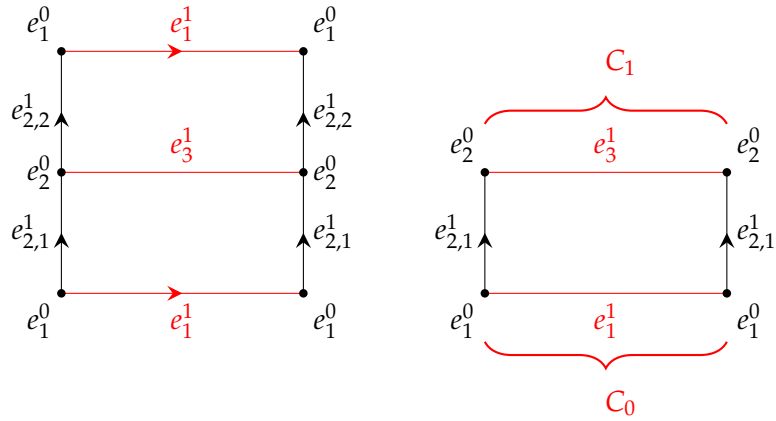

(a) G-CW structure of the torus X . (b) Fundamental region for the type I involution on X .

Figure 2.1. – Type I G-CW setup of the torus X .

Furthermore, we regard the torus X as being equipped with the structure of a G -CW complex (see e.g. [13, p. 16] or [17, p. 1]). Such a G -CW structure is depicted in figure 2.1a. We continue with the *cylinder reduction* method.

Cylinder Reduction In order to describe the cylinder reduction we need the notion of a fundamental region:

Definition 2.1.7 A *fundamental region* for the G -action on X is a connected subset $R \subset X$ such that each G -orbit in X intersects R in a single point.

The type I involution is particularly convenient to work with, since for this action there exists a sub- G -CW complex that is a fundamental region for the T -action (see figure 2.1b). Geometrically this fundamental region is a closed cylinder (including its boundary circles), which we denote by Z . The fixed point set X^G is the disjoint union of two circles C_0 and C_1 . The cylinder Z is bounded by these circles. We identify Z with $I \times S^1$. In this setup, the boundary circles are $C_0 = \{0\} \times S^1$ and $C_1 = \{1\} \times S^1$. For convenience we also set $C = C_0 \cup C_1$. In this situation we note the following general lemma:

Lemma 2.1.8 Let Y be a G -space, Y^G the T -fixed point set in Y and

$$f: (Z, C) \rightarrow (Y, Y^G)$$

a map. Then there exists a unique equivariant extension of f to a G -map $X \rightarrow Y$ which we denote by \hat{f} . The same applies to homotopies of such maps.

Proof. We only prove the statement for a given homotopy

$$H: I \times (Z, C) \rightarrow (Y, Y^G).$$

Denote the complementary cylinder by Z' (note that $Z \cap Z' = C = C_0 \cup C_1$). Then we can construct the equivariant extension \widehat{H} of H by defining

$$\widehat{H}: I \times X \rightarrow Y$$

$$(t, x) \mapsto \begin{cases} H(t, x) & \text{if } x \in Z \\ T(H(t, T(x))) & \text{if } x \in Z' \end{cases}$$

Since $H(t, \cdot)$ is a map $(Z, C) \rightarrow (Y, Y^G)$, this definition of \widehat{H} is well-defined on the boundary circles C_0 and C_1 and globally continuous. \square

For the concrete situation $(Y, Y^G) = (S^2, E)$ this implies:

Remark 2.1.9 (Cylinder reduction) Every G -map $f: X \rightarrow S^2$ is completely determined by its restriction $f|_Z$ to the cylinder Z . Discussing G -homotopies of maps $X \rightarrow S^2$ is equivalent to discussing homotopies of maps $(Z, C) \rightarrow (S^2, E)$.

For the following we need to fix an identification of C_0 and C_1 with S^1 .⁵ Let us assume that the identification of the circles C_j with S^1 is such that the loops

$$\gamma_j: I \rightarrow X$$

$$t \mapsto \left[t + \frac{j}{2}i \right] \quad \text{for } j = 0, 1$$

both define loops of degree one. Recall that loops in S^1 are up to homotopy determined by their degree. Based on this observation we define a normal form for equivariant maps $X \rightarrow S^2$:

Definition 2.1.10 (Type I normalization) Let $f: X \rightarrow S^2$ be a G -map (resp. a map $(Z, C) \rightarrow (S^2, E)$). Then f is *type I normalized* if the restrictions

$$f|_{C_j}: C_j \rightarrow E$$

are, using the fixed identifications of the circles C_j and E with S^1 , of the form $z \mapsto z^{k_j}$ for some integers k_j .

Remark 2.1.11 Let $f: (Z, C) \rightarrow (S^2, E)$ be a map (or let f be a G -map $X \rightarrow S^2$). Via the homotopy extension property (resp. its equivariant version, see corollary A.1.10) of the pair (Z, C) (resp. (X, C)), there exists a G -homotopy from f to a map f' , which is type I normalized. This means that, using the respective identifications of the C_j and E with S^1 , the map $f'|_{C_j}$ is of the form $z \mapsto z^{k_j}$ where k_j denotes the respective fixed point degree on the circle C_j . \square

⁵Here, S^1 is regarded as being equipped with the standard orientation.

Given a G -map $f: X \rightarrow S^2$ we have already defined its fixed point degree (d_0, d_1) (see definition 2.1.5). Given a map $f: (Z, C) \rightarrow (S^2, E)$ we define its fixed point degree to be the fixed point degree of its equivariant extension $X \rightarrow S^2$.

The Free Loop Space By the cylinder reduction (remark 2.1.9) it suffices to classify maps $(Z, C) \rightarrow (S^2, E)$ up to homotopy. The cylinder Z is just S^1 times some closed interval (e. g. the closed unit interval I). Recall that $\mathcal{L}S^2$, the free loop space of the space S^2 , is the space of all maps $S^1 \rightarrow S^2$:

$$\mathcal{L}S^2 = \mathcal{M}(S^1, S^2) = \{f: S^1 \rightarrow S^2\}.$$

First we make a general remark about the topology on the free loop space:

Remark 2.1.12 The space S^1 is Hausdorff and locally compact. Hence, in the terminology of e. g. [5], it is *exponentiable*, which means that for any other spaces Y and A , the natural bijection

$$\mathcal{M}(A, \mathcal{M}(S^1, Y)) = \left(Y^{S^1}\right)^A \cong Y^{A \times S^1} = \mathcal{M}(A \times S^1, Y)$$

is compatible with the topology in the sense that it preserves continuity. See [5]. The mapping spaces are regarded as being equipped with the compact-open topology. \square

As an immediate consequence of the above we note:

Remark 2.1.13 A map $f: (Z, C) \rightarrow (S^2, E)$ can be regarded as a curve in $\mathcal{L}S^2$ starting and ending at loops whose image are contained in E . After type I normalization the start and end curve are distinguished and indexed by \mathbb{Z} . \square

We do not make any distinction in the notation; we silently identify maps $(Z, C) \rightarrow (S^2, E)$ with curves in $\mathcal{L}S^2$.

Definition 2.1.14 Let α be a curve in $\mathcal{L}S^2$ from p_1 to p_2 and β a curve from p_2 to p_3 . Then we denote by $\beta * \alpha$ the concatenation of the curves α and β , which is a curve from p_1 to p_3 . Given a curve α , we denote by α^{-1} the curve with time reversed.

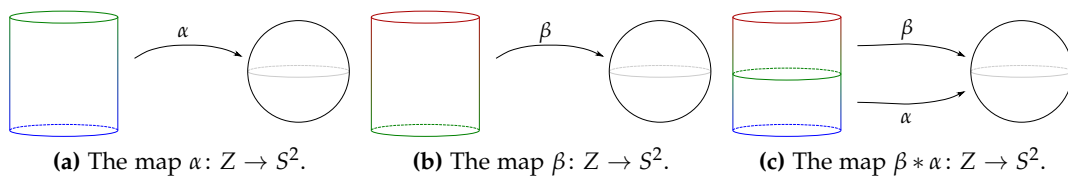

Figure 2.2. – Concatenation of maps from the cylinder.

Using the isomorphism

$$\mathcal{M}(I, \mathcal{L}S^2) \cong \mathcal{M}(Z, S^2), \tag{2.6}$$

concatenation of curves induces a corresponding operation on the space of (type I normalized) maps $(Z, C) \rightarrow (S^2, E)$. This is depicted in figure 2.2. We need to be careful to distinguish the inverse of a map from its inverse regarded as a curve. But this should always be clear from the context.

Of course, the homotopy classification of curves in $\mathcal{L}S^2$ depends on the topology of $\mathcal{L}S^2$. Our first remark towards understanding the topology of the latter is:

Remark 2.1.15 The free loop space $\mathcal{L}S^2$ is path-connected.

Proof. Let $\alpha, \beta \in \mathcal{L}S^2$ be two loops in S^2 . Since $\pi_1(S^2) = 0$, any loop can be deformed to the constant loop at some chosen point in S^2 . By transitivity, this implies that α and β can be deformed into each other. In other words, there is a path from α to β , regarded as elements of the free loop space. \square

Now we consider the set $\pi(\mathcal{L}S^2; \gamma_0, \gamma_1)$ of homotopy classes of curves in $\mathcal{L}S^2$ with fixed endpoints γ_0 and γ_1 . Using lemma A.1.2 we can conclude that two curves $f, g: I \rightarrow \mathcal{L}S^2$ from γ_0 to γ_1 are homotopic if and only if $g^{-1} * f$ is null-homotopic in $\pi(\mathcal{L}S^2, \gamma_0)$. This underlines that we need to understand the fundamental group $\pi_1(\mathcal{L}S^2)$. In the next step we compute the fundamental group $\pi_1(\mathcal{L}S^2)$. For this we make use of the following fibration (see e. g. [1])

$$\Omega S^2 \hookrightarrow \mathcal{L}S^2 \rightarrow S^2 \quad (2.7)$$

where ΩS^2 denotes the space of *based* loops in S^2 at some fixed basepoint, e. g. $p_0 \in E$. The map $\mathcal{L}S^2 \rightarrow S^2$ is the evaluation map, which takes a loop in $\mathcal{L}S^2$, i. e. a map $S^1 \rightarrow S^2$, and evaluates it at 1. Now we can state:

Lemma 2.1.16 The fundamental group $\pi_1(\mathcal{L}S^2)$ of the free loop space of S^2 is infinite cyclic.

Proof. We consider the fibration (2.7) and develop it into a long exact homotopy sequence. The relevant part of this sequence is:

$$\dots \rightarrow \mathbb{Z} \cong \pi_2(S^2) \rightarrow \pi_1(\Omega S^2) \rightarrow \pi_1(\mathcal{L}S^2) \rightarrow \pi_1(S^2) \cong 0 \quad (2.8)$$

It is known that

$$\pi_1(\Omega S^2) \cong \pi_2(S^2) \cong \mathbb{Z}.$$

Therefore, by exactness of the above sequence, it follows that $\pi_1(\mathcal{L}S^2)$ must be a quotient of \mathbb{Z} , i. e. either the trivial group, \mathbb{Z} or one of the finite groups \mathbb{Z}_n . We prove that it is \mathbb{Z} with the help of a geometric argument: Let γ_1 be the curve in S^2 which parametrizes the equator E with degree one and choose γ_1 as the basepoint for the fundamental group and then construct an infinite family of maps $X \rightarrow S^2$ with the same fixed point degree $(1, 1)$ but with different global degrees – the latter implies by Hopf's

theorem that they cannot be homotopic. In particular they cannot be G -homotopic and hence the curves associated to their restrictions to Z cannot be homotopic.

The construction goes as follows: We construct a map φ from the cylinder $Z = I \times S^1$ to S^2 such that $\varphi_0 \equiv \varphi_1$ and φ_0 and φ_1 are degree 1 maps $S^1 \rightarrow E$ as follows: Assume that for $t = 0$ we have an embedding of S^1 as the equator $E \subset S^2$. Then we fix two antipodal points on the equator and begin rotating the equator on the Riemann sphere while keeping the two antipodal points fixed for all t . We can rotate this S^1 -copy on the sphere as fast as we want, we just need to make sure that at $t = 1$ we again match up with the equator. By making the correct number (i. e. an even number) of rotations we obtain a map φ from Z to S^2 whose equivariant extension to the full torus X has the desired fixed point degree $(1, 1)$. By increasing the number of rotations, we can generate homotopically distinct G -maps from the torus into the sphere. Thus we obtain an infinite family of maps with fixed point degree $(1, 1)$ and with distinct total degrees. Therefore, the fundamental group cannot be finite, but must be infinite cyclic. \square

The Degree Map In the following we introduce the *total degree* into the discussion. The fixed point degree together with this total degree will turn out to be a complete invariant of equivariant homotopy. The degree map will be the fundamental tool for the proof. We would like to associate to a curve in $\mathcal{L}S^2$ the degree of its equivariant extension. This only makes sense for a certain subset of all curves. Thus we define:

Definition 2.1.17 For each $j \in \mathbb{Z}$ we let $\mathcal{D}_j \in \mathcal{L}S^2$ be the normalized loop in $E \subset S^2$ of degree j . We set

$$\mathcal{L}_{\text{std}} = \{\mathcal{D}_j : j \in \mathbb{Z}\} \subset \mathcal{L}S^2.$$

Let \mathcal{P} be the set of curves in $\mathcal{L}S^2$ starting and ending at points in \mathcal{L}_{std} :

$$\mathcal{P} = \{\alpha : I \rightarrow \mathcal{L}S^2 \mid \alpha(0), \alpha(1) \in \mathcal{L}_{\text{std}}\}.$$

The set \mathcal{P} is a suitable domain of definition for the degree map, which we now define:

Definition 2.1.18 The *degree map* on \mathcal{P} is the map

$$\begin{aligned} \text{deg} : \mathcal{P} &\rightarrow \mathbb{Z} \\ \alpha &\mapsto \text{deg } \hat{\alpha}, \end{aligned}$$

where $\hat{\alpha}$ denotes the equivariant extension of α . That is, α , which is a curve in the free loop space $\mathcal{L}S^2$, is to be regarded as a map $(Z, C) \rightarrow (S^2, E)$ and $\hat{\alpha} : X \rightarrow S^2$ is its equivariant extension to the full torus (see lemma 2.1.8).

An immediate property of the degree map is:

Remark 2.1.19 Let $\alpha \in \mathcal{P}$ be the constant curve at some $\gamma \in \mathcal{L}_{\text{std}}$. Then $\deg \alpha = 0$.

Proof. The equivariant extension $\widehat{\alpha}$ has its image contained in $E \subset S^2$. Hence it is not surjective as a map to S^2 , which implies $\deg \widehat{\alpha} = 0$. \square

For curves α, β we introduce the symbols $\alpha \simeq \beta$ to express that α and β are homotopic as curves (with fixed endpoints).

Remark 2.1.20 When $\alpha, \beta \in \mathcal{P}$ are two curves with common endpoints, then $\alpha \simeq \beta$ implies $\deg \alpha = \deg \beta$. In other words: the degree map is also well-defined on \mathcal{P}/\simeq , that is \mathcal{P} modulo homotopy.

Proof. Homotopies between two curves can be regarded as homotopies between maps $Z \rightarrow S^2 \text{ rel } C$. Such homotopies can also be equivariantly extended, giving homotopies between the respective equivariant extensions of the two maps $X \rightarrow S^2$. Therefore, their total degree must agree. \square

We have just seen that the degree map factors through \mathcal{P}/\simeq . The next goal is to prove an injectivity property of the degree map. Crucial for its proof is that the degree map is compatible with the aforementioned concatenation operation of loops:

Lemma 2.1.21 Let $\gamma_1, \gamma_2, \gamma_3$ be in \mathcal{L}_{std} , furthermore let $\alpha \in \mathcal{P}$ be a path in $\mathcal{L}S^2$ from γ_1 to γ_2 and β be a path in $\mathcal{L}S^2$ from γ_2 to γ_3 . Then $\beta * \alpha$ is a path from γ_1 to γ_3 and

$$\deg(\beta * \alpha) = \deg \beta + \deg \alpha.$$

Proof. Let α and β be paths in $\mathcal{L}S^2$ with the properties mentioned above. To prove the lemma, we have to show that

$$\deg \widehat{\beta * \alpha} = \deg \widehat{\beta} + \deg \widehat{\alpha}.$$

The idea we employ here is that – after smooth approximation of the maps – we can count preimage points of a regular fiber to compute the total degrees. We regard the curves α and β as maps from the cylinder $Z = I \times S^1$ to S^2 . We can assume that α and β are smooth on Z ; the concatenation $\beta * \alpha$ does not have to be smooth at the glueing curves. But after a smooth approximation of $\widehat{\beta * \alpha}$ near this glueing curve, we can assume that the equivariant extensions $\widehat{\alpha}$, $\widehat{\beta}$ and $\widehat{\beta * \alpha}$ are smooth maps from the torus into S^2 . Now let $q \in S^2$ be a regular point of $\widehat{\beta * \alpha}$, away from the neighborhood of the boundary circles where we have smoothed the map $\beta * \alpha$. We now consider its fiber over q . This consists of all points p_1, \dots, p_k with $\widehat{\alpha}(p_j) = q$ and all points p'_1, \dots, p'_ℓ with $\widehat{\beta}(p'_j) = q$. Summing the points p_j (resp. p'_j) respecting the orientation signs yields $\deg \widehat{\alpha}$ (resp. $\deg \widehat{\beta}$). Therefore, the points $p_1, \dots, p_k, p'_1, \dots, p'_\ell$ with their respective orientation signs attached add up to $\deg \widehat{\alpha} + \deg \widehat{\beta}$. \square

Note that lemma 2.1.21 also implies that

$$\deg(\alpha^{-1}) = -\deg(\alpha),$$

where α^{-1} is the curve $\alpha: I \rightarrow \mathcal{L}S^2$ with reversed time. The space \mathcal{P} does not carry a group structure in the usual sense, but of course the based fundamental groups $\pi_1(\mathcal{L}S^2, \gamma)$ do carry a group structure. When γ is in \mathcal{L}_{std} , then $\pi_1(\mathcal{L}S^2, \gamma) \subset \mathcal{P}/\simeq$ and we can note the following

Remark 2.1.22 The degree map induces a group homomorphism on fundamental groups:

$$\deg: \pi_1(\mathcal{L}S^2, \mathcal{D}_j) \rightarrow \mathbb{Z}$$

for every $j \in \mathbb{Z}$.

Proof. Let \mathcal{D}_j be in \mathcal{L}_{std} . By remark 2.1.20 we know that the degree map is well-defined as a map on the fundamental group $\pi_1(\mathcal{L}S^2, \mathcal{D}_j)$. By remark 2.1.19 the neutral element in $\pi_1(\mathcal{L}S^2, \mathcal{D}_j)$, that is the homotopy class of the constant curve at \mathcal{D}_j , gets mapped to $0 \in \mathbb{Z}$. The group structure in the fundamental group is given by the concatenation of loops at the basepoint. Lemma 2.1.21 shows that the degree map is compatible with the group structures. Hence, the degree map is a group homomorphism on fundamental groups. \square

Now that we know that restrictions of the degree map to fundamental groups are group homomorphisms it is useful to compute its kernel. For this we need a lemma, which deals with the special case of a fixed point degree of the form (d_0, d_0) . To formulate the statement, we introduce an equivalence relation \sim on the cylinder Z , which identifies the circles $C_0, C_1: (0, z) \sim (1, z)$. The resulting space $\tilde{Z} = Z/\sim$ is a 2-torus. Now we can state:

Lemma 2.1.23 A map $f: (Z, C) \rightarrow (S^2, E)$ with $f|_{C_0} \equiv f|_{C_1}$ has even degree. More concretely: The map f induces a map $\tilde{f}: \tilde{Z} \rightarrow S^2$ and

$$\deg \hat{f} = 2 \deg \tilde{f}.$$

In particular, the equivariant extension \hat{f} has degree zero iff the induced map \tilde{f} has degree zero.

Proof. Note that on the LHS we have the degree of the equivariant extension $\hat{f}: X \rightarrow S^2$ of f while on the RHS we have (two times) the degree of the induced map $\tilde{f}: \tilde{Z} \rightarrow S^2$.

We prove the statement by counting preimage points. The torus \tilde{Z} carries a differentiable structure. The induced map $\tilde{f}: \tilde{Z} \rightarrow S^2$ does not have to be smooth near $C \subset \tilde{Z}$. But after a smooth approximation near C we can assume that it is globally smooth. By the same reason the equivariant extension \hat{f} defined on X is globally smooth. Let q be

a regular value of the smoothed map f , away from the circle C . This implies that q is also a regular value of \tilde{f} and \hat{f} . Let d be the degree of \tilde{f} . The fiber of q under \tilde{f} can thus be written as

$$\tilde{f}^{-1}(q) = \{p_1, \dots, p_k\}.$$

Denoting the respective orientation signs at each preimage point p_j with σ_j we can express the degree d as

$$d = \sum_{1 \leq j \leq k} \sigma_j.$$

To simplify the proof we assume that q has been chosen such that $T(q)$ is also a regular value of \hat{f} and that q (and therefore also $T(q)$) has no preimage points on the boundary circles.

Recall that when regarding the cylinder Z as being embedded in X with boundary circles C_0 and C_1 , the equivariant extension \hat{f} is the map

$$\hat{f}: X \rightarrow S^2$$

$$x \mapsto \begin{cases} f(x) & \text{if } x \in Z \\ T \circ f \circ T(x) & \text{if } x \in Z' \end{cases}$$

where Z' denotes the complementary cylinder in X whose intersection with Z consists of the circles $C_0 \cup C_1$. It remains to compare the fibers $\hat{f}^{-1}(q)$ and $\tilde{f}^{-1}(q)$. Since q is assumed to have no preimage points in the boundary circles, we can write the first fiber as

$$\hat{f}^{-1}(q) = \hat{f}|_Z^{-1}(q) \cup \hat{f}|_{Z'}^{-1}(q).$$

By definition of \hat{f} , the preimage points in the cylinder Z are exactly those of \tilde{f} , with the same orientation signs. We now prove

$$\hat{f}|_{Z'}^{-1}(q) = T \left(\hat{f}|_Z^{-1}(T(q)) \right).$$

For this, let p be in Z' with $\hat{f}|_{Z'}(p) = q$. This implies $T \circ \hat{f}|_{Z'}(p) = T(q)$, which in turn implies by equivariance

$$\hat{f}|_Z(T(p)) = T(q).$$

In other words, after defining $\tilde{p} = T(p) \in Z$, we have: $p = T(\tilde{p})$ with $\tilde{p} \in Z$ and

$$\tilde{f}|_Z(\tilde{p}) = \tilde{f}|_Z(T(p)) = T \circ \tilde{f}|_{Z'}(p) = T(q).$$

On the other hand, let \tilde{p} be in $T(\hat{f}|_Z^{-1}(T(q)))$. This means that $\tilde{p} = p$ with $\hat{f}|_Z(p) = T(q)$. Set $p = T(\tilde{p})$. Then:

$$\hat{f}|_{Z'}(\hat{p}) = \hat{f}|_{Z'}(T(p)) = T \circ \hat{f}|_Z(p) = q,$$

which means $\tilde{p} \in \hat{f}|_{Z'}^{-1}(q)$.

Since T bijectively sends Z to Z' it follows that the number of preimage points on Z and Z' coincide. Also, since \hat{f} restricted to (the interior of) Z' is the composition of f with two orientation-reversing diffeomorphisms, the orientation sign at each preimage point p in Z is the same as the orientation sign of the corresponding preimage point $T(p)$ in Z' . This means that summing (respecting the orientation) over all the preimage points in the fiber $\hat{f}^{-1}(q)$ yields exactly $2 \deg \hat{f}$. \square

Now we can prove the desired injectivity property of the degree map:

Proposition 2.1.24 For any $\gamma \in \mathcal{L}_{\text{std}}$, the degree homomorphism

$$\deg: \pi_1(\mathcal{L}S^2, \gamma) \rightarrow \mathbb{Z}$$

is injective.

Proof. We prove that the degree homomorphism has trivial kernel. By path-connectedness of $\mathcal{L}S^2$ all the based fundamental groups of $\mathcal{L}S^2$ are isomorphic. Hence it suffices to prove the statement for one fixed loop γ . Therefore we reduce the problem to a simpler case and take γ to be the constant loop at the base point p_0 in E .

Let α be a type I normalized map of the cylinder Z into S^2 with fixed point degree $(0, 0)$ and $\deg \alpha = 0$. As before, α can be regarded as curve in $\mathcal{L}S^2$ and $[\alpha]$ defines an element in the fundamental group $\pi_1(\mathcal{L}S^2, \gamma)$. Let $\tilde{Z} = Z/\sim$ be the torus which results from the cylinder Z by identifying the circles C_0 and C_1 (see p.22). Since, by construction, $\alpha|_{C_0} \equiv \alpha|_{C_1} \equiv \gamma$, α induces a map $\tilde{Z} \rightarrow S^2$ which, by lemma 2.1.23, also has degree zero.

Denote the generator of the fundamental group of the torus \tilde{Z} which corresponds to C_0 resp. C_1 by C . Let C' denote the other generator of the fundamental group such that the intersection number of C with C' is $+1$. The restriction of $f: \tilde{Z} \rightarrow S^2$ to C is already constant. Using the homotopy extension property together with the simply-connectedness of S^2 we can assume that f is also constant along C' . Therefore we can collapse these two generators and f induces a map $\tilde{Z}/(C \cup C') \cong S^2 \rightarrow S^2 \cong S^2$. By remark A.1.12 the map $f: \tilde{Z}/(C \cup C') \rightarrow S^2$ also has degree zero. By Hopf's theorem, this map is null-homotopic (even as a map of pointed spaces, as can be shown by another application of the homotopy extension property). This corresponds to a null-homotopy of the curve α with fixed basis curve γ , hence $[\alpha] = 0$, which finishes the proof. \square

The Degree Triple In the following we combine the total degree and the fixed point degrees. For this we make the following

Definition 2.1.25 (Degree triple map) The *degree triple map* is the map

$$\begin{aligned} \mathcal{T}: \mathcal{M}_G(X, S^2) &\rightarrow \mathbb{Z}^3 \\ f &\mapsto (d_0, d, d_1), \end{aligned}$$

where (d_0, d_1) is the fixed point degree of f and d is the total degree of f . For a map $f: X \rightarrow S^2$ we define its *degree triple* (or simply *triple*) to be $\mathcal{T}(f)$. We call a given triple *realizable* if it is contained in the image $\text{Im}(\mathcal{T})$. For a map $f: (Z, C) \rightarrow (S^2, E)$ we define its *degree triple* to be the degree triple of the equivariant extension $\hat{f}: X \rightarrow S^2$.

As an immediate consequence we obtain:

Remark 2.1.26 The degree triple of a map is a G -homotopy invariant. □

Thus, the degree triple map factors through $[X, S^2]_G$. In the following we analyze the image $\text{Im}(\mathcal{T})$.

Remark 2.1.27 Let f be a G -map $X \rightarrow S^2$ with fixed point degrees (d_0, d_0) . Then the total degree $\deg f$ must be even. In other words, the degree triples $(d_0, 2k + 1, d_0)$ are not contained in the image $\text{Im}(\mathcal{T})$.

Proof. Assume that the map f is type I normalized. The restriction $f|_Z$ to the cylinder then satisfies the assumptions of lemma 2.1.23, hence we can conclude that its equivariant extension \hat{f} has even degree. But the equivariant extension of $f|_Z$ is f itself, hence f must have even degree. □

In particular, the triple $(0, 1, 0)$ is not contained in $\text{Im}(\mathcal{T})$. This gives rise to the mod 2 condition

$$d \equiv d_0 + d_1 \pmod{2}, \tag{2.9}$$

which was already mentioned in the outline and must hold for any realizable degree triple. The details will be explained in paragraph 2.1.1.1 (p. 28). In order to deduce the above “parity condition” (2.9) for general degree triples we introduce an algebraic structure on the set of realizable triples. This is the following binary operation for triples:

Definition 2.1.28 Two triples (d_0, d, d_1) and (d'_0, d', d'_1) are called *compatible* if $d_1 = d'_0$. Given two compatible triples (d_0, d, d_1) and (d_1, d', d_2) , then we define $(d_0, d, d_1) \bullet (d_1, d', d_2)$ to be the triple

$$(d_0, d + d', d_2).$$

We call this binary operation *concatenation* of triples. Its usefulness is illustrated by the following remark:

Remark 2.1.29 When the triples (d_0, d, d_1) and (d_1, d', d_2) are in $\text{Im}(\mathcal{T})$, then so is

$$(d_0, d, d_1) \bullet (d_1, d', d_2).$$

Proof. Assume that the triples (d_0, d, d_1) resp. (d_1, d', d_2) are realized by the paths α resp. β in \mathcal{P} satisfying $\alpha(1) = \beta(0)$. By definition,

$$(d_0, d, d_1) \bullet (d_1, d', d_2) = (d_0, d + d', d_2).$$

We need to show the existence of a path in the loop space $\mathcal{L}S^2$ from $\alpha(0)$ to $\beta(1)$ with total degree $d + d'$ of its associated equivariant extension. Recall that d (resp. d') is the degree of the equivariant extension $\widehat{\alpha}$ (resp. $\widehat{\beta}$). The concatenation $\alpha * \beta$ is a path in loop space from d_0 to d_2 . Its total degree is defined to be the degree of the equivariant extension $\widehat{\alpha * \beta}$. By lemma 2.1.21 this is the same as $\deg \widehat{\alpha} + \deg \widehat{\beta} = d + d'$. \square

In other words: the image $\text{Im}(\mathcal{T})$ is closed under the concatenation operation of degree triples. In the following lemma we encapsulate several fundamental properties of the image $\text{Im}(\mathcal{T})$.

Proposition 2.1.30 Let d_0, d_1 be integers. Then:

- (i) If the triple (d_0, d, d_1) is in $\text{Im}(\mathcal{T})$, then so is $(d_0, -d, d_1)$.
- (ii) For any fixed point degree (d_0, d_1) , the triple $(d_0, d_0 - d_1, d_1)$ is in $\text{Im}(\mathcal{T})$. In particular, the triple $(1, 1, 0)$ is in $\text{Im}(\mathcal{T})$.
- (iii) For any k , the triple $(0, 2k, 0)$ is in $\text{Im}(\mathcal{T})$.
- (iv) If (d_0, d, d_1) is in $\text{Im}(\mathcal{T})$, then so is (d_1, d, d_0) .

Proof. Regarding (i): Assume that $f: X \rightarrow S^2$ is a map with $\mathcal{T}(f) = (d_0, d, d_1)$. Note that $T: S^2 \rightarrow S^2$ is an orientation-reversing diffeomorphism of S^2 which keeps the equator E fixed. Therefore:

$$\mathcal{T}(T \circ f) = (d_0, -d, d_1).$$

In other words: the triple $(d_0, -d, d_1)$ is realizable.

Regarding (ii): We need to construct a map $X \rightarrow S^2$ with fixed point degrees (d_0, d_1) and total degree $d_0 - d_1$. For this, let D be the closed unit disk in the complex plane:

$$D = \{z \in \mathbb{C} : |z| \leq 1\}.$$

Let ι_D be the embedding of D onto one of the two hemispheres.:

$$\iota: D \hookrightarrow S^2 \quad (2.10)$$

$$re^{i\varphi} \mapsto \begin{pmatrix} r \cos \varphi \\ r \sin \varphi \\ \pm \sqrt{1-r^2} \end{pmatrix}. \quad (2.11)$$

We pick the sign defining either the lower or the upper hemisphere such that ι_D is orientation preserving. Now we define the map

$$f: Z \rightarrow D \\ (t, \varphi) \mapsto \begin{cases} (1-2t)e^{id_0\varphi} & \text{for } 0 \leq t \leq \frac{1}{2} \\ (2t-1)e^{id_1\varphi} & \text{for } \frac{1}{2} \leq t \leq 1. \end{cases}$$

To ease the notation, set

$$Z_1 = \left(0, \frac{1}{2}\right) \times S^1 \quad \text{and} \quad Z_2 = \left(\frac{1}{2}, 1\right) \times S^1.$$

Then we consider the composition map

$$F = \iota_D \circ f: Z \rightarrow S^2.$$

The restriction $F|_{C_j}$ to the boundary circles is of the form:

$$F|_{C_j}: S^1 \rightarrow E \subset S^2 \\ \varphi \mapsto \begin{pmatrix} \cos(d_j\varphi) \\ \sin(d_j\varphi) \\ 0 \end{pmatrix}.$$

Hence, by construction, F has fixed point degrees (d_0, d_1) (compare with (2.5), p. 13). It remains to show that the equivariant extension \hat{F} has total degree $d_0 - d_1$. At least away from the boundary circles, \hat{F} is a smooth map. Thus, let $q \in S^2$ be a regular value of \hat{F} , say, on the hemisphere $\iota_D(D)$, but not one of the poles (they are not regular values for f). The point q corresponds to some point $\tilde{q} = \tilde{t}e^{i\tilde{\varphi}}$ in the closed unit disk D with $\tilde{t} \in (0, 1)$. By construction, the fiber $\hat{F}^{-1}(q)$ will be the same as the fiber $F^{-1}(\tilde{q})$, which contains exactly $d_0 + d_1$ points in the cylinder Z :

$$q_{j,k} = \left(\frac{1 + (-1)^{j+1}\tilde{t}}{2}, d_j \left(\tilde{\varphi} + \frac{2k}{d_j}\pi \right) \right) \quad \text{for } j = 0, 1 \text{ and } k = 0, 1, \dots, d_j.$$

The points $q_{0,k}$, $k = 0, \dots, d_1 - 1$, are of the form

$$q_{0,k} = \left(\frac{1 - \tilde{t}}{2}, d_1 \left(\tilde{\varphi} + \frac{2k}{d_1}\pi \right) \right)$$

which means that they are contained in the cylinder half Z_1 . The points $q_{1,k}$, $k = 0, \dots, d_2 - 1$ are of the form

$$q_{2,k} = \left(\frac{1 + \tilde{t}}{2}, d_2 \left(\tilde{\varphi} + \frac{2k}{d_2} \pi \right) \right)$$

and therefore they are contained in Z_2 . A computation shows that the orientations signs at the points $q_{1,k} \in Z_1$ are the opposite of those at the points $q_{2,k} \in Z_2$. Therefore, summing over the points in the generic fiber $\hat{F}^{-1}(q)$ yields $\pm(d_0 - d_1)$ as total degree of \hat{F} . Since ι_D has been chosen orientation-preserving, the total degree is $d_0 - d_1$.

Regarding (iii): First note that by (i) and (ii) the triple $(0, 1, 1)$ is in $\text{Im}(\mathcal{T})$. But then the triple $(0, 1, 1) \bullet (1, 1, 0) = (0, 2, 0)$ is also in $\text{Im}(\mathcal{T})$. Concatenation of this triple with itself k times yields the desired triple $(0, 2k, 0)$.

Regarding (iv): Let $\tau: X \rightarrow X$ be the translation inside the torus, which swaps the boundary circles (e. g. $[z] \mapsto [z + \frac{1}{2}i]$ in our model). Then, composing a map of type (d_0, d, d_1) with τ yields a map of type (d_1, d, d_0) . This finishes the proof. \square

The proof of proposition 2.1.30 (ii) is of particular importance – it contains a constructive method for producing equivariant maps $X \rightarrow S^2$ with triple $(d_0, d_0 - d_1, d_1)$. These triples can be regarded as basic building blocks for equivariant maps $X \rightarrow S^2$, since all other triples can be built from triples of this form by concatenation.

Definition 2.1.31 We call the maps constructed in proposition 2.1.30 (ii) *maps in normal form* for the triple $(d_0, d_0 - d_1, d_1)$.

Note that the normal form map for a triple $(d_0, d_1 - d_0, d_1)$ is by definition the normal form map for $(d_0, d_0 - d_1, d_1)$ composed with $T: S^2 \rightarrow S^2$.

Main Result In this paragraph we state and prove the main classification result for the type I involution. The statement is:

Theorem 2.1.32 The G -homotopy class of a map $f \in \mathcal{M}_G(X, S^2)$ is uniquely determined by its degree triple $\mathcal{T}(f)$. The image $\text{Im}(\mathcal{T})$ of the degree triple map $\mathcal{T}: \mathcal{M}_G(X, S^2) \rightarrow \mathbb{Z}^3$ consists of those triples (d_0, d, d_1) satisfying

$$d \equiv d_0 + d_1 \pmod{2}.$$

We need one last lemma in order to prove this theorem:

Lemma 2.1.33 Let f and g be two type I normalized maps $(Z, C) \rightarrow (S^2, E)$ with the same triple (d_0, d, d_1) . Then f and g are homotopic rel C .

Proof. Both maps can be regarded as curves $f, g: I \rightarrow \mathcal{L}S^2$. Since they are assumed to be type I normalized, they start at the same curve $\gamma_0 \in \mathcal{L}_{\text{std}}$ and end at the same curve $\gamma_1 \in \mathcal{L}_{\text{std}}$. We need to prove the existence of a homotopy between the curves f and g in $\mathcal{L}S^2$.

By lemma A.1.2 it suffices to show that the loop $g^{-1} * f$ based at γ_0 is null-homotopic. To prove this we use the degree map restricted to the fundamental group based at γ_0 :

$$\begin{aligned} \deg: \pi_1(\mathcal{L}S^2, \gamma_0) &\rightarrow \mathbb{Z} \\ [\gamma] &\mapsto \deg \hat{\gamma}. \end{aligned}$$

From lemma 2.1.21 it follows that

$$\deg(g^{-1} * f) = \deg f - \deg g = \deg \hat{f} - \deg \hat{g} = \deg f - \deg g = d - d = 0.$$

Because of remark 2.1.20 this can also be stated on the level of homotopy classes:

$$\deg[g^{-1} * f] = \deg[f] - \deg[g] = 0.$$

Therefore, using the injectivity of the degree map (proposition 2.1.24) we can conclude that $[g^{-1} * f] = 0$ in $\pi_1(\mathcal{L}S^2, \gamma_0)$. In other words:

$$g^{-1} * f \simeq c_{\gamma_0},$$

where c_{γ_0} denotes the constant curve in $\mathcal{L}S^2$ at γ_0 . Now, lemma A.1.2 implies that f and g are homotopic by means of a homotopy $h: I \times I \rightarrow \mathcal{L}S^2$. This homotopy induces a homotopy

$$\begin{aligned} H: I \times (Z, C) &\rightarrow (S^2, E) \\ (t, (s, z)) &\mapsto h(t, s, z) \end{aligned}$$

between the maps f and g . □

Finally, we can prove theorem 2.1.32:

Proof. It is clear by remark 2.1.26 that the degree triple (d_0, d, d_1) is a G -homotopy invariant. Now we show that it is a *complete* invariant in the sense that

$$\mathcal{T}(f) = \mathcal{T}(g) \Rightarrow f \simeq_G g,$$

where $f \simeq_G g$ means that the maps f and g are G -homotopic. For this, let f and g be two G -maps with the same triple (d_0, d, d_1) . By remark 2.1.11 we can assume that f and g are type I normalized. Now we use remark 2.1.9 and reduce the construction of a G -homotopy from f to g to the construction of a homotopy from $f|_Z$ to $g|_Z$ rel C . The assumptions of lemma 2.1.33 are satisfied, hence this lemma provides us with a homotopy $H: I \times (Z, C) \rightarrow (S^2, E)$ rel C . Such a homotopy can be equivariantly extended to all of X , establishing a G -homotopy between f and g as maps $X \rightarrow S^2$.

It remains to compute the image $\text{Im}(\mathcal{T})$. To simplify the notation, set

$$p = \begin{cases} 0 & \text{if } d_0 + d_1 \text{ is even} \\ 1 & \text{if } d_0 + d_1 \text{ is odd.} \end{cases}$$

First we show that for any d of the form $2k + p$ the triple (d_0, d, d_1) is contained in the image $\text{Im}(\mathcal{T})$, then we show that the assumption of the triple $(d_0, 2k + 1 + p, d_1)$ being contained in $\text{Im}(\mathcal{T})$ leads to a contradiction. To ease the notation, let σ_j be the sign of d_j , i. e. $d_j = \sigma_j |d_j|$, for $j = 0, 1$. By definition of p we know that $2k + p - (d_0 + d_1)$ is an even number. Hence the triple

$$t = (0, 2k + p - (d_0 + d_1), 0)$$

is contained in $\text{Im}(\mathcal{T})$ by proposition 2.1.30 (ii). We define the following triples:

$$\begin{aligned} t_1 &= (\sigma_0, \sigma_0, 0) \\ t_2 &= (2\sigma_0, \sigma_0, \sigma_0) \\ &\dots \\ t_{|d_0|} &= (|d_0|\sigma_0, \sigma_0, |d_0|\sigma_0 - \sigma_0) \\ u_1 &= (0, \sigma_1, \sigma_1) \\ u_2 &= (\sigma_1, \sigma_1, 2\sigma_1) \\ &\dots \\ u_{|d_1|} &= (|d_1|\sigma_1 - \sigma_1, \sigma_1, |d_1|\sigma_1), \end{aligned}$$

which are contained in $\text{Im}(\mathcal{T})$ by proposition 2.1.30 (ii). From this we can form the triple

$$\begin{aligned} \tilde{t} &= t_{|d_0|} \bullet \dots \bullet t_2 \bullet t_1 \bullet t \bullet u_1 \bullet u_2 \bullet \dots \bullet u_{|d_1|} \\ &= (d_0, 2k + p, d_1) \end{aligned}$$

Therefore, the triple \tilde{t} is contained in $\text{Im}(\mathcal{T})$. On the other hand, assume that the triple $t = (d_0, 2k + 1 + p, d_1)$ is contained in $\text{Im}(\mathcal{T})$ for some k . As above, we define the following realizable triples

$$\begin{aligned} t_1 &= (0, -\sigma_1, \sigma_1) \\ t_2 &= (\sigma_1, -\sigma_1, 2\sigma_1) \\ &\dots \\ t_{|d_0|} &= (|d_0|\sigma_1 - \sigma_1, -\sigma_1, |d_0|\sigma_1) \\ u_1 &= (\sigma_2, -\sigma_2, 0) \\ u_2 &= (2\sigma_2, -\sigma_2, \sigma_2) \\ &\dots \\ u_{|d_1|} &= (|d_1|\sigma_2, -\sigma_2, |d_1|\sigma_2 - \sigma_2). \end{aligned}$$

This allows us to form the following triple

$$\begin{aligned} \tilde{t} &= t_1 \bullet t_2 \bullet \dots \bullet t_{|d_0|} \bullet t \bullet u_{|d_1|} \bullet \dots \bullet u_2 \bullet u_1 \\ &= (0, 2k + 1 + p - (d_0 + d_1), 0), \end{aligned}$$

which then also has to be in $\text{Im}(\mathcal{T})$. But, by definition, $p - (d_0 + d_1)$ is an even number, hence $2k + 1 + p - (d_0 + d_1)$ is odd, contrary to remark 2.1.27. Hence, the assumption that $(d_0, 2k + 1 + p, d_1)$ is in the image $\text{Im}(\mathcal{T})$ cannot hold. \square

A consequence of the above is that we can identify equivariant homotopy classes with their associated degree triples. At this point we underline that the proof of theorem 2.1.32 and lemma 2.1.33 shows that when two type I normalized G -maps $f, g: X \rightarrow S^2$ have the same degree triple, then they are not only equivariantly homotopic, but they are equivariantly homotopic rel $C = C_0 \cup C_1$. This will be of particular importance in the next section.

2.1.1.2. Type II

In this section, the torus X – still defined in terms of the standard square lattice – is equipped with the type II involution

$$\begin{aligned} T: X &\rightarrow X \\ [z] &\mapsto [i\bar{z}]. \end{aligned}$$

As before, we can regard the torus X as a G -CW complex. The G -CW structure we use for the type II involution is depicted in figure 2.3a. The first major difference when compared with type I is the fact that the fixed point set in the torus consists of a single circle C , not two. In the universal cover \mathbb{C} this circle can be described as the diagonal line $x + ix$. Furthermore, the complement of the circle C in the torus is still connected. The choice of “fundamental region” in this case is not completely obvious. Indeed, we need a new definition – the notion of a fundamental region in the sense of definition 2.1.7 is not suitable for the type II involution:

Definition 2.1.34 A connected subset $R \subset X$ is called a *pseudofundamental region* for the G -action on X if there exists a subset $R' \subset \partial R$ in the boundary of R such that $R \setminus R'$ is a fundamental region.

The idea behind the proof of the classification for type II is to identify a pseudofundamental region $R \subset X$, then bring the maps into a certain normal form such that we can collapse certain parts of ∂R and the maps push down to this quotient. In the quotient, the geometry of the T -action is easier to understand and the image of R in the quotient will be fundamental region for the induced T -action on the quotient.

The pseudofundamental region we use for the type II T -action on X is

$$R = \{[x + iy] : 0 \leq x \leq 1 \text{ and } 0 \leq y \leq x\}$$

See figure 2.3b for a depiction of this fundamental region. Note that T -equivariance of a map requires the values of this map along the circles A_1 and A_2 to be compatible, because T maps A_1 to A_2 and vice versa. To make this precise (and to ease the notation) we make the following definition.

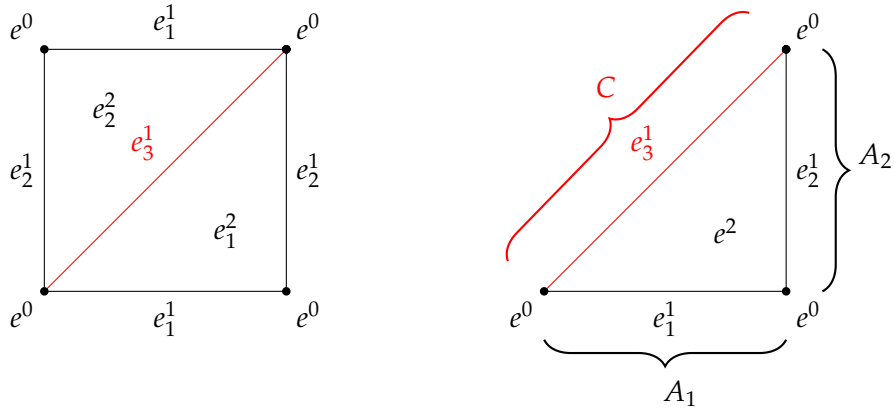

(a) G-CW Decomposition of X .

(b) Pseudofundamental region $R \subset X$.

Figure 2.3. – Type II G-CW Setup of the Torus X .

Definition 2.1.35 For $f: X \rightarrow S^2$ resp. $f: R \rightarrow S^2$ we let $f_{A_j}: I \rightarrow S^2$ ($j = 1, 2$) be the map

$$f_{A_j}: t \mapsto \begin{cases} f([t]) & \text{for } j = 1 \\ f([1 + it]) & \text{for } j = 2. \end{cases}$$

For convenience we also set $A = A_1 \cup A_2$.

Then we can reformulate what it means for a map $f: X \rightarrow S^2$ to be equivariant:

Remark 2.1.36 Let $F: X \rightarrow S^2$ be a G -map. Then its restriction $f = F|_R$ to R satisfies

- (i) $f(C) \subset E$ and
- (ii) $f_{A_1} = T \circ f_{A_2}$.

Lemma 2.1.37 Maps $R \rightarrow S^2$ resp. homotopies $I \times X \rightarrow S^2$ with the above two properties extend uniquely to equivariant maps $X \rightarrow S^2$ resp. equivariant homotopies $I \times X \rightarrow S^2$.

Proof. This is basically the same proof as for lemma 2.1.8. We let R' be the opposite pseudofundamental region, which has the intersection $A_1 \cup A_2 \cup C$ with R . Then we define the extension of the map on R' to be the T -conjugate of the map on R . The compatibility condition along $A_1 \cup A_2$ (from definition 2.1.35) guarantees that the resulting extension is globally well-defined on X . \square

Homotopy Invariant In the type I classification we have identified degree *triples* as the desired (complete) homotopy invariant; in the type II case we need something slightly different. In order to obtain well-defined notion of fixed point degree we must choose an orientation on the fixed point circle $C \subset X$ (compare with p. 17). Although we assume for this paragraph that an orientation has already been chosen, we will wait until paragraph 2.1.1.2 (p. 33) before we fix this orientation on C .

Definition 2.1.38 (Degree pair map) The *degree pair map* is the map

$$\begin{aligned} \mathcal{P}: \mathcal{M}_G(X, S^2) &\rightarrow \mathbb{Z}^2 \\ f &\mapsto (d, d_C), \end{aligned}$$

where d is the total degree of the map f and d_C is the fixed point degree of f . For a map $f: X \rightarrow S^2$ we define its *degree pair* (or simply *pair*) to be $\mathcal{P}(f)$. We call a given pair *realizable* if it is contained in the image $\text{Im}(\mathcal{P})$.

We need to be careful to distinguish the *degree pair* (d, d_C) of an equivariant map $X \rightarrow S^2$ (for the type II involution) from the *fixed point degrees* (d_0, d_1) of an equivariant map $X \rightarrow S^2$ (for the type I involution), but this should always be clear from the context. After having defined the degree pair, we immediately obtain:

Remark 2.1.39 The degree pair is a G -homotopy invariant. □

Reduction to Type I Although, at first glance, the type II involution appears to be quite different from the type I involution, it is nevertheless possible to use the results from the type I classification (section 2.1.1.1).

Definition 2.1.40 (Type II normalization) Let $f: X \rightarrow S^2$ be a G -map. We say f is *type II normalized* if

- (i) $f_{A_1} = f_{A_2} = c_{p_0}$, where $c_{p_0}: X \rightarrow S^2$ denotes the constant map whose image is $\{p_0\} \subset E$ and
- (ii) f is normalized on the circle C in the sense that, using the identifications of C and E with S^1 , the map $f|_C$ corresponds to $z \mapsto z^k$ for some k .

Proposition 2.1.41 Any G -map $f: X \rightarrow S^2$ is G -homotopic to a map f' which is type II normalized.

Proof. The statement is proved in several steps. Consider X with the G -CW-decomposition as in figure 2.3a consisting of the six cells e^0 , $e_{1,2,3}^1$, and $e_{1,2}^2$. Restrict f to the pseudo-fundamental region R . Then $A = A_1 \cup A_2$ is a subcomplex of R . We now successively apply two homotopies to f . Observe that the maps f_{A_j} ($j = 1, 2$) are loops in S^2 at some point $p \in E$. Using the simply-connectedness of S^2 there exists a null-homotopy

$\rho: I \times I \rightarrow S^2$ of f_{A_1} to the constant curve c_p . For the first homotopy, we define H on $\{0\} \times R$ to be the original map f and on $I \times A_1$ resp. $I \times A_2$ we set

$$(t, s) \mapsto \rho(t, s) \quad \text{resp.} \quad (t, 1 + is) \mapsto T \circ \rho(t, s).$$

By the homotopy extension property (HEP, see proposition A.1.1) this can be extended to a homotopy $H: I \times R \rightarrow S^2$ and the resulting map $H(1, \cdot)$, which we denote by \tilde{f} , has the property that $\tilde{f}(A_j) = \{p\}$ ($j = 1, 2$).

Define the second homotopy as follows: On $\{0\} \times R$ we define H to be the map \tilde{f} . On $I \times C$ we make a homotopy $H_C: I \times C \rightarrow E$ to the normalized form $z \mapsto z^k$. In particular, e_0 will then be mapped to $p_0 \in E$. But when we change the map on C we only need to adjust it accordingly on A , hence we define the homotopy on $I \times A_1$ resp. $I \times A_2$ to be

$$(t, s) \mapsto H_C(t, 0) \quad \text{resp.} \quad (t, 1 + is) \mapsto H_C(t, 0).$$

The map H is then well-defined on $I \times e_0$ and extends by the HEP to a homotopy $I \times R \rightarrow S^2$. By lemma 2.1.37, we can equivariantly extend this homotopy to a homotopy $I \times X \rightarrow S^2$ and the resulting map has the desired properties. \square

For the reduction to type I it will be very useful to replace the torus X with the quotient X/A . This will be formalized next. With the above remark we can assume without loss of generality that any map in $\mathcal{M}_G(X, S^2)$ is type II normalized. Type II normalized maps $f: X \rightarrow S^2$ push down to the quotient $X/A \rightarrow S^2$. Let us denote the topological quotient $X \rightarrow X/A$ by π_A and the image of A under π_A with A/A . In the next lemma we study the geometry of X/A .

Lemma 2.1.42 We state:

- (i) The T -action on X pushes down to the quotient.
- (ii) The projection map $\pi_A: X \rightarrow X/A$ is equivariant.
- (iii) The space $(X/A, T)$ can then be equivariantly identified with (S^2, T) , where T acts on S^2 as the standard reflection along the equator.

Proof. Regarding (i): First we prove that the T -action on X pushes down to X/A : The T -action stabilizes $A \subset X$. Hence, T is compatible with the relation on X , which identifies the points in A . By theorem A.1.7 T therefore induces a map $X/A \rightarrow X/A$, which we, by abuse of notation, again denote by T . Since $T: X \rightarrow X$ is an involutive homeomorphism on X , the same applies to $T: X/A \rightarrow X/A$ (see e. g. theorem A.1.7).

Regarding (ii): This is true by definition of the T -action on the quotient: $T([x]) = [T(x)]$.

Regarding (iii): The space X/A consists of two 2-cells, glued together along their boundary, which is stabilized by T . We can define an equivariant homeomorphism to

S^2 by mapping one of the 2-cells to e. g. the lower hemisphere of the sphere, mapping the boundary of the 2-cell to the equator. The map on the second cell can then be defined by equivariant extension, thus mapping it to the upper hemisphere. \square

Thus we can from now on identify X/A with S^2 as topological manifolds and by this identification equip X/A with the smooth structure from S^2 . We denote the point in S^2 corresponding to $A/A \in X/A$ by P_0 . The projection map π_A induces an equivariant map

$$\pi_{S^2}: X \rightarrow S^2, \quad (2.12)$$

whose restriction $X \setminus A \rightarrow S^2 \setminus \{P_0\}$ is smooth. The degree of π_{S^2} is either $+1$ or -1 but we can assume that it is $+1$ (if it were -1 , we could compose with a reflection along the equator in S^2). We must be careful to not confuse the 2-sphere introduced in (2.12) with the 2-sphere which has been identified as a deformation retract of $\mathcal{H}_{(1,1)}$. In particular their equators must be considered as distinct objects. Thus we denote the equator of the 2-sphere which appears as a quotient of the torus X by E' .

Now, let (X', T) be a type I torus, that is, the torus \mathbb{C}/Λ equipped with the type I involution T and denote the north resp. the south pole of S^2 by O_{\pm} . Observe that also the sets $X' \setminus C_0$ and $S^2 \setminus \{O_{\pm}\}$ are G -spaces. The former is an open cylinder and the latter is a doubly punctured 2-sphere. We note:

Remark 2.1.43 There exists a smooth and orientation preserving G -diffeomorphism

$$\Psi: X' \setminus C_0 \xrightarrow{\sim} S^2 \setminus \{O_{\pm}\}.$$

Proof. Regard S^2 as being embedded as the unit-sphere in \mathbb{R}^3 . Then we define the map Ψ as follows:

$$\Psi: X' \setminus C_0 \xrightarrow{\sim} S^2 \setminus \{O_{\pm}\}$$

$$[x + iy] \mapsto \begin{pmatrix} \sqrt{1 - (2y - 1)^2} \cos(2\pi x) \\ \sqrt{1 - (2y - 1)^2} \sin(2\pi x) \\ 2y - 1 \end{pmatrix}$$

This defines an equivariant and orientation preserving diffeomorphism. \square

On p. 33 we mentioned that we still need to decide for an orientation on the circle $C \subset X$, which is equivalent to choosing an identification of C with S^1 – we will do this now. Observe that the restriction of the above map Ψ to $C_1 \subset X'$ identifies the circle C_1 with the equator E' in S^2 , which the map π_{S^2} identifies with $C \subset X$. We define the identifications of $C \subset X$ and $E' \subset S^2$ with S^1 in terms of this identification with $C_1 \subset X'$. Analogously to definition 2.1.40 we make the following

Definition 2.1.44 We call a G -map $f: S^2 \rightarrow S^2$ *type II normalized*⁶, if the north pole O_+ and the south pole O_- both are mapped to $p_0 \in E \subset S^2$ and the map is normalized on the equator E' according to the above identification of E' with S^1 .

Remark 2.1.45 Any G -map $S^2 \rightarrow S^2$ is equivariantly homotopic to a type II normalized G -map.

Proof. This follows with the equivariant homotopy extension (corollary A.1.10): There exists a G -CW decomposition of S^2 such that the set $B = \{O_\pm\} \cup E'$ is a G -CW sub-complex of S^2 . \square

To summarize the above discussion: Above we have constructed a map from the set of type II normalized G -maps $X \rightarrow S^2$ to the set of type II normalized G -maps $S^2 \rightarrow S^2$. We denote this map by ψ and state:

Proposition 2.1.46 The map ψ is a bijection. Furthermore, the degree pairs of f and $\psi(f)$ agree.

Proof. Let us begin by reviewing how the map ψ is defined: If $f: X \rightarrow S^2$ is a type II normalized map, it is by definition constant along A . Hence it pushes down to a G -map $f: X/A \rightarrow S^2$. Now X/A can be equivariantly identified with S^2 , hence, by means of this identification, f defines a G -map $S^2 \rightarrow S^2$. By construction these two maps are related by the following diagram:

$$\begin{array}{ccc} X & & \\ \pi_{S^2} \downarrow & \searrow f & \\ S^2 & \xrightarrow{f'} & S^2 \end{array}$$

Injectivity of this map is clear: If $\psi(f) = \psi(g)$, then also

$$f = \psi(f) \circ \pi_{S^2} = \psi(g) \circ \pi_{S^2} = g.$$

For the surjectivity, let $f': S^2 \rightarrow S^2$ be a type II normalized G -map, then $f = f' \circ \pi_{S^2}: X \rightarrow S^2$ is a type II normalized G -map such that $\psi(f) = f'$.

Since π_{S^2} has degree +1 and using the functorial property of homology we see that the total degrees of f and f' must agree. Regarding the fixed point degree: π_{S^2} homeomorphically maps the circle $C \subset X$ to the equator $E \subset S^2$. Now the only possibility would be that the fixed point degrees differ by a sign. But, by definition, the identifications of $C \subset X$ and $E \subset S^2$ with S^1 differ only by π_{S^2} and above the orientation of $C \subset X$ has been chosen such that $\pi_{S^2}|_C$ preserves the orientation. \square

This correspondence between type II normalized G -maps $X \rightarrow S^2$ and type II normalized G -maps $S^2 \rightarrow S^2$ also implies a statement on the level of equivariant homotopy:

⁶as a map defined on the 2-sphere, not on the type II torus X

Remark 2.1.47 Given two type II normalized G -maps $f, g: X \rightarrow S^2$ and an equivariant homotopy $H: S^2 \rightarrow S^2$ between the induced maps $f', g': S^2 \rightarrow S^2$, then f and g are also equivariantly homotopic.

Proof. Compose the homotopy with the map $\text{id} \times \pi_{S^2}$. \square

We now describe a basic correspondence between type II normalized G -maps $S^2 \rightarrow S^2$ and type I normalized G -maps $X' \rightarrow S^2$. Assume f is a type II normalized G -map $S^2 \rightarrow S^2$. This induces a map

$$\phi(f): X' \rightarrow S^2$$

$$p \mapsto \begin{cases} f \circ \Psi(p) & \text{if } p \notin C_0 \\ p_0 & \text{if } p \in C_0 \end{cases}$$

Since f is type II normalized, i. e. $f(O_{\pm}) = p_0$, the map $\phi(f)$ is continuous everywhere and type I normalized as a map $X' \rightarrow S^2$. By construction f and $\phi(f)$ are related by

$$f|_{S^2 \setminus \{O_{\pm}\}} \circ \Psi = \phi(f)|_{X' \setminus C_0}, \quad (2.13)$$

where Ψ is the orientation preserving diffeomorphism from remark 2.1.43. The reduction to type I is now summarized in the following two statements:

Proposition 2.1.48 The above map ψ defines a bijection between type II normalized G -maps $S^2 \rightarrow S^2$ and type I normalized G -maps $X' \rightarrow S^2$ whose fixed point degree along the circle C_0 is zero. For a type II normalized G -map f , the degree pair of f is (d, d_C) iff the degree triple of $\phi(f)$ is $(0, d, d_C)$.

Proof. Regarding the injectivity: Let f and g be two type II normalized G -maps $S^2 \rightarrow S^2$ such that $\phi(f) = \phi(g)$. By (2.13) it follows that $f|_{S^2 \setminus \{O_{\pm}\}} = g|_{S^2 \setminus \{O_{\pm}\}}$. Since f and g are assumed to be type II normalized, hence in particular continuous, this implies that $f = g$. Regarding the surjectivity: Let f' be a type I normalized G -map $X' \rightarrow S^2$ with fixed point degree $(0, d_1)$. Then (2.13) defines a map $f: S^2 \setminus \{O_{\pm}\} \rightarrow S^2$ which, by defining $f(O_{\pm}) = p_0$, uniquely extends to a type II normalized G -map $S^2 \rightarrow S^2$. By construction we obtain $\phi(f) = f'$.

Regarding the correspondence between the degree invariants: Assume we are given a G -map $f: S^2 \rightarrow S^2$ with degree pair (d, d_C) . By corollary A.1.6, f can be equivariantly smoothed. Note that the map Ψ in (2.13) is an orientation preserving diffeomorphism. This implies that $\phi(f)$ is smooth, at least away from the boundary circle C_0 . Using theorem A.1.5 we can smooth $\phi(f)$ near the circle C_0 while keeping it unchanged away from C_0 . Now, let q be a regular value of f such that its preimage points p_1, \dots, p_m are contained in $S^2 \setminus \{O_{\pm}\}$. Then q is also a regular of $\phi(f)$ and its preimage points are $\Psi^{-1}(p_j)$, $j = 1, \dots, m$. Since Ψ preserves the orientation, $\deg f = \deg \phi(f)$. By definition of the identification of $E \subset S^2$ with S^1 (through Ψ), the fixed point degree d_C remains unchanged as well. Finally, by construction, the fixed point degree of $\phi(f)$ along C_0 is zero. \square

Now we can show that equivariant homotopies for maps $X' \rightarrow S^2$ induce equivariant homotopies for maps $S^2 \rightarrow S^2$:

Proposition 2.1.49 Given two type II normalized G -maps $f, g: S^2 \rightarrow S^2$ with the same degree pair, then they are G -homotopic rel $\{O_\pm\}$.

Proof. Without loss of generality we can assume that f and g are both type II normalized G -maps $S^2 \rightarrow S^2$ with the same degree pair. Then, by proposition 2.1.48, the induced maps $\phi(f), \phi(g): X' \rightarrow S^2$ share the same degree triple. Hence there exists a G -homotopy H' from $\phi(f)$ to $\phi(g)$ which is in particular relative with respect to the boundary circle C_0 . In other words, throughout the homotopy, H' maps the circle C_0 to $p_0 \in E \subset S^2$. This homotopy then induces an equivariant homotopy H between f and g :

$$H: I \times S^2 \rightarrow S^2$$

$$(t, p) \rightarrow \begin{cases} H'(t, \Psi^{-1}(p)) & \text{if } p \notin \{O_\pm\} \\ p_0 & \text{if } p \in \{O_\pm\} \end{cases}$$

Hence, f and g are equivariantly homotopic rel $\{O_\pm\}$. □

Main Result The main result in this section is the following

Theorem 2.1.50 The G -homotopy class of a map $f \in \mathcal{M}_G(X, S^2)$ is uniquely determined by its degree pair $\mathcal{P}(f)$. The image $\text{Im}(\mathcal{P})$ of the degree pair map $\mathcal{P}: \mathcal{M}_G(X, S^2) \rightarrow \mathbb{Z}^2$ consists of those pairs (d, d_C) satisfying

$$d \equiv d_C \pmod{2}.$$

Proof. First we prove that the degree pairs (d, d_C) are a complete invariant of equivariant homotopy for maps $X \rightarrow S^2$. For this, let f and g be two G -maps $X \rightarrow S^2$ with the same degree pair (d, d_C) . Without loss of generality we can assume that f and g are type II normalized (Proposition 2.1.41). In this case, by proposition 2.1.46, f and g push down to type II normalized maps $f', g': S^2 \rightarrow S^2$ with the same degree pair. With proposition 2.1.49 it now follows that f' and g' are equivariantly homotopic. Then remark 2.1.47 establishes the existence of an equivariant homotopy from f to g .

Regarding the image of $\text{Im}(\mathcal{P})$: Let d_C be an integer. We now have to compute all possible integers d such that the degree pair (d, d_C) is contained in the $\text{Im}(\mathcal{P})$. Let us first deduce a necessary condition for the given degree pair to be in the image $\text{Im}(\mathcal{P})$. For this, let $f: X \rightarrow S^2$ be a G -map with the aforementioned degree pair. By proposition 2.1.46 we obtain an induced G -map $f': S^2 \rightarrow S^2$ with the same degree pair. Now proposition 2.1.48 implies the existence of an induced map $\phi(f): X' \rightarrow S^2$ with the degree triple $(0, d, d_C)$. By theorem 2.1.32, we must have $d \equiv d_C \pmod{2}$. This shows that the condition is necessary for a pair to be contained in $\text{Im}(\mathcal{P})$; what

remains to show is that this condition is also sufficient. Let $f'' : X' \rightarrow S^2$ be a G -map with degree triple $(0, d, d_C)$. By proposition 2.1.48 there exists a G -map $f' : S^2 \rightarrow S^2$ with the degree pair (d, d_C) and by proposition 2.1.46 this induces a G -map $f : X \rightarrow S^2$ with the same degree pair. This proves the statement. \square

2.1.2. Classification of Maps to \mathcal{H}_2^*

Note that so far the degree triple map (resp. the degree pair map) has only been defined on $\mathcal{M}_G(X, S^2)$. But since S^2 has been shown to be an equivariant strong deformation retract, we can also define the degree triple map (resp. degree pair map) on $\mathcal{M}_G(X, \mathcal{H}_{(1,1)})$. In particular this allows us to speak of degree triples (resp. of degree pairs) of G -maps $X \rightarrow \mathcal{H}_{(1,1)}$. Now we state and prove the main result of this section:

Theorem 2.1.51 Let X be a torus equipped with either the type I or the type II involution. Then:

- (i) The sets $[X, \mathcal{H}_{(2,0)}]_G$ and $[X, \mathcal{H}_{(0,2)}]_G$ are trivial (i. e. one-point sets).
- (ii) Two G -maps $X \rightarrow \mathcal{H}_{(1,1)}$ are G -homotopic iff their degree triples (type I) resp. their degree pairs (type II) agree.
- (iii) The realizable degree triples (d_0, d, d_1) (type I) resp. degree pairs (d, d_C) (type II) are exactly those which satisfy

$$d \equiv d_0 + d_1 \pmod{2} \quad \text{resp.} \quad d \equiv d_C \pmod{2}.$$

Proof. The fact that the cases $\text{sig} = (2,0)$ and $\text{sig} = (0,2)$ constitute G -homotopy classes on their own has already been shown at the beginning of this chapter (remark 2.1.1). Regarding the case $\text{sig} = (1,1)$: By remark 2.1.3, $\mathcal{H}_{(1,1)}$ has S^2 as equivariant, strong deformation retract. Therefore,

$$[X, \mathcal{H}_{(1,1)}]_G \cong [X, S^2]_G.$$

Then theorem 2.1.32 (for the type I involution) and theorem 2.1.50 (for the type II involution) complete the proof. \square

2.1.3. An Example from Complex Analysis

The Weierstrass \wp -function is a meromorphic and doubly-periodic function on the complex plane associated to a lattice Λ . It can be defined as follows:

$$\wp(z) = \frac{1}{z^2} + \sum_{\lambda \in \Lambda \setminus \{0\}} \left(\frac{1}{(z - \lambda)^2} - \frac{1}{\lambda^2} \right).$$

This function can be regarded as a holomorphic map to \mathbb{P}_1 . Since the lattice Λ is stable under complex conjugation, we have the identity

$$\wp(\bar{z}) = \overline{\wp(z)}.$$

By the orientation-preserving identification $\mathbb{P}_1 \cong S^2$ (see p. 2.1) we can regard the map \wp as an equivariant map $X \rightarrow S^2$. Since its total degree as a map to \mathbb{P}_1 is two, its degree as a map to S^2 is also two. Analogously, the derivative \wp' defines an equivariant map $X \rightarrow \mathbb{P}_1 \cong S^2$ of degree three. Furthermore we state:

Remark 2.1.52 The Weierstrass \wp -function (resp. \wp'), regarded as a map

$$X \rightarrow \mathbb{P}_1 \cong S^2 \hookrightarrow \mathcal{H}_{(1,1)}$$

has fixed point degrees $(0, 0)$ (resp. $(1, 0)$).

Proof. Regarding \wp : The restriction $\wp|_{C_0}$ to boundary circle C_0 is not surjective to the compactified real line $\widehat{\mathbb{R}}$, since in the square lattice case, the only zero of $\wp(z)$ is at the point $z = \frac{1}{2}(1 + i)$ (see e. g. [4]). Similarly, the restriction of \wp to the boundary circle is not surjective to \mathbb{RP}_1 , because the only pole of \wp is at $z = 0$ (of order 2). This proves that the fixed point degrees are both zero.

Regarding \wp' : Since $\wp'(z)$ has its only pole at $z = 0$, its restriction to the circle $C_1 = I + \frac{1}{2}i$ cannot be surjective to $\widehat{\mathbb{R}}$, therefore its fixed point degree d_1 must be zero. But its fixed point degree d_0 is ± 1 : It is known that the only pole of $\wp'(z)$ is at $z = 0$ and its only zero in C_0 is at $z = \frac{1}{2}$. A computation shows that \wp' is negative along $(0, \frac{1}{2})$. In other words, along the curve segment $(0, \frac{1}{2})$, the image under \wp' moves from ∞ to the negative real numbers and finally to 0. By the identity

$$\wp'(-z) = -\wp'(z),$$

it follows that on the curve segment $(\frac{1}{2})$ the image under \wp' moves from 0 to the positive real numbers until it finally reaches ∞ . By definition of the orientation on $\widehat{\mathbb{R}}$ (see the discussion on p. 2.1), this is a loop of degree +1. \square

For the type II involution we consider the scaled Weierstrass functions

$$F = i\wp$$

$$\text{and } G = e^{i\frac{3\pi}{4}}\wp'.$$

As above, they can be considered as equivariant maps $X \rightarrow S^2$.

Remark 2.1.53 The fixed point degree of F is 0 and that of G is 1.

Proof. Regarding F : The map $F(z)$ has its only pole at $z = 0$ and its only zero at $\frac{1}{2}(1 + i)$. Thus, when z linearly moves from the origin to the point $\frac{1}{2}(1 + i)$, then its

image under F defines a curve from ∞ to 0. Since F is an even function it follows that on the second segment of the diagonal circle, F reverses the previous curve, going back from 0 to ∞ . Thus the fixed point degree for F is 0.

Regarding G : Along the curve segment from 0 to $\frac{1}{2}(1+i)$ it defines a curve from ∞ to 0. A computation shows that this curve is along the negative real numbers. Since G is not an odd map, its restriction to the segment from $\frac{1}{2}(1+i)$ to $1+i$ defines a curve from 0 to ∞ , but with the opposite sign, i. e. along the positive real numbers. This defines a degree +1 loop. \square

To summarize the above:

Remark 2.1.54 With respect to the identification $\mathbb{P}_1 \cong S^2$ described on p. 2.1, we have:

$$\begin{aligned}\mathcal{T}(\wp) &= (0, 2, 0) \\ \mathcal{T}(\wp') &= (1, 3, 0) \\ \mathcal{P}(i\wp) &= (2, 0) \\ \mathcal{P}(e^{i\frac{3\pi}{4}}\wp') &= (3, 1).\end{aligned}$$

By choosing a different equivariant identification $\mathbb{P}_1 \cong S^2$, we might introduce signs for the total degrees or for the fixed point degrees or for both. For instance, we can always compose the G -diffeomorphism $\mathbb{P}_1 \rightarrow S^2$ with reflections on S^2 . Thus, in some sense, the numbers in the above remark are only well-defined up to sign.

2.2. Maps to \mathcal{H}_n

In this chapter we generalize the results of the previous section to arbitrary $n > 2$. For this we begin by noting that the unitary group $U(n)$ acts on $\mathcal{H}_{(p,q)}$ by conjugation. Since every matrix in $\mathcal{H}_{(p,q)}$ can be diagonalized by unitary matrices, the set of $U(n)$ -orbits in $\mathcal{H}_{(p,q)}$ is parametrized by the set of (unordered) real eigenvalues $\lambda_1^+, \dots, \lambda_p^+, \lambda_1^-, \dots, \lambda_q^-$. The involution T stabilizes the components $\mathcal{H}_{(p,q)}$, since the matrices H and $T(H)$ clearly have the same spectrum. The T -action is also compatible with the $U(n)$ -orbit structure of $\mathcal{H}_{(p,q)}$, as shown in the next remark:

Remark 2.2.1 The T -action on \mathcal{H}_n stabilizes each $U(n)$ -orbit in each $\mathcal{H}_{(p,q)}$.

Proof. Let $D = \text{Diag}(\lambda_1, \dots, \lambda_n)$ be a diagonal matrix in $\mathcal{H}_{(p,q)}$. In particular all λ_j are non-zero real numbers. Let \mathcal{O} be the $U(n)$ -orbit of D . We have to show that \mathcal{O} is T -stable. For this, let M be a matrix in \mathcal{O} . By definition it is of the form $M = UDU^*$ for some $U \in U(n)$. Then we have

$$T(UDU^*) = \overline{UDU^*} = \overline{U}D\overline{U}^*.$$

But since $U \in U(n)$ implies $\overline{U} \in U(n)$, we can conclude that $T(UDU^*)$ is again contained in the orbit \mathcal{O} . \square

In each component $\mathcal{H}_{(p,q)}$ there is a $U(n)$ -orbit which is particularly convenient to work with:

Remark 2.2.2 The $U(n)$ -orbit of the block diagonal matrix

$$\mathbb{E}_{p,q} = \begin{pmatrix} \mathbb{E}_p & 0 \\ 0 & -\mathbb{E}_q \end{pmatrix}$$

is diffeomorphic to the Grassmannian $\text{Gr}_p(\mathbb{C}^n)$.

Proof. The $U(n)$ -isotropy of $\mathbb{E}_{p,q}$ is $U(p) \times U(q)$. Hence, for the $U(n)$ -orbit we have the following smooth identification:

$$U(n) \cdot \mathbb{E}_{p,q} \cong \frac{U(n)}{U(p) \times U(q)} \cong \text{Gr}_p(\mathbb{C}^n) \quad \square$$

In order to reduce the classification of maps to $\mathcal{H}_{(p,q)}$ to the classification of maps to this Grassmann manifold, it is important to understand the T -action on the latter. For this we make the following remark:

Remark 2.2.3 The induced T -action on $\text{Gr}_p(\mathbb{C}^n)$ is given by

$$V \mapsto \bar{V},$$

for each p -dimensional subvector space $V \subset \mathbb{C}^n$.

Proof. As a first step we compute the induced T -action under the identification

$$\begin{aligned} \frac{U(n)}{U(p) \times U(q)} &\xrightarrow{\sim} U(\mathbb{E}_{p,q}) \subset \mathcal{H}_{(p,q)} \\ [U] &\mapsto U\mathbb{E}_{p,q}U^*. \end{aligned}$$

Now, let $[U]$ be a point in the quotient. The above isomorphism sends $[U]$ to $U\mathbb{E}_{p,q}U^*$. The T -action on \mathcal{H}_n maps this to $\overline{U\mathbb{E}_{p,q}U^*} = \bar{U}\mathbb{E}_{p,q}\bar{U}^*$, which under the above isomorphism, corresponds to the point $[\bar{U}]$ in the quotient. Thus, the induced T -action on the quotient is via $T([U]) = [\bar{U}]$. For the next step we need to use the isomorphism

$$\begin{aligned} \frac{U(n)}{U(p) \times U(q)} &\xrightarrow{\sim} \text{Gr}_p(\mathbb{C}^n) \\ [U] &\mapsto U(V_0), \end{aligned}$$

where V_0 denotes a fixed base point in the Grassmannian, e.g. the subvector space spanned by e_1, \dots, e_p . Now, let $V \in \text{Gr}_p(\mathbb{C}^n)$ be a subvector space of \mathbb{C}^n generated by the vectors v_1, \dots, v_p . This subspace uniquely corresponds to a coset $[U]$ such that $U(V_0) = V$. Recalling that V_0 is by definition generated by the standard basis e_1, \dots, e_p , we see that the first p columns u_1, \dots, u_p of U constitute a unitary basis

of the subvector space V . The T -action on the quotient maps $[U]$ to $[\overline{U}]$, which then corresponds to the subvector space $\overline{U}(V_0)$. This subvector space can be described in terms of the basis

$$\overline{U}(e_1), \dots, \overline{U}(e_p),$$

which is just $\overline{u}_1, \dots, \overline{u}_p$. Therefore, the induced T -action on $\text{Gr}_p(\mathbb{C}^n)$ is

$$V \mapsto \overline{V},$$

which finishes the proof. \square

As a special case we also note:

Remark 2.2.4 The induced action on $\mathbb{P}_n = \text{Gr}_1(\mathbb{C}^{n+1})$ in terms of homogeneous coordinates is given by

$$[z_0 : \dots : z_n] \mapsto [\overline{z}_0 : \dots : \overline{z}_n].$$

Proof. Follows from remark 2.2.3 together with the fact that the homogeneous coordinates for a given line $L = \mathbb{C}(\ell_1, \dots, \ell_{n+1})$ in \mathbb{C}^{n+1} are $[\ell_1 : \dots : \ell_{n+1}]$. \square

Remark 2.2.5 Regard the Grassmannian $\text{Gr}_k(\mathbb{C}^n)$ as being equipped with the standard real structure given by complex conjugation. If T is a real structure on the n -dimensional vectorspace W , then there is a biholomorphic G -map

$$\text{Gr}_k(W) \xrightarrow{\sim} \text{Gr}_k(\mathbb{C}^n).$$

Proof. The real structure T on W induces a decomposition of W as $W = W_{\mathbb{R}} \oplus iW_{\mathbb{R}}$, where $W_{\mathbb{R}}$ is an n -dimensional, real subvector space of W . The vectorspace W can be identified with \mathbb{C}^n by sending an orthonormal basis w_1, \dots, w_n of $W_{\mathbb{R}}$ to the standard basis e_1, \dots, e_n . This is equivariant by construction and induces an equivariant biholomorphism $\text{Gr}_k(W) \rightarrow \text{Gr}_k(\mathbb{C}^n)$. \square

Let us now look at the topology of the two connected components $\mathcal{H}_{(n,0)}$ and $\mathcal{H}_{(0,n)}$ of \mathcal{H}_n^* :

Remark 2.2.6 The component $\mathcal{H}_{(n,0)}$ (resp. $\mathcal{H}_{(0,n)}$) has $\{\mathbb{E}_n\}$ (resp. $\{-\mathbb{E}_n\}$) as a strong equivariant deformation retract.

Proof. We only prove the statement for the component $\mathcal{H}_{(n,0)}$. For this we define:

$$\begin{aligned} \rho: I \times \mathcal{H}_{(n,0)} &\rightarrow \mathcal{H}_{(n,0)} \\ (t, A) &\mapsto (1-t)A + t\mathbb{E}_n \end{aligned}$$

Clearly, for $t = 0$ this is the identity on $\mathcal{H}_{(n,0)}$ and for $t = 1$ it is constant at the identity \mathbb{E}_n . Hence, in order to show that this is a well-defined deformation retract, we have

to prove that there exists no matrix $A \in \mathcal{H}_{(n,0)}$ such that $\rho_t(A)$ is singular for some $t \in (0,1)$.

Let A be a positive definite matrix in \mathcal{H}_n . By assumption we know that $\det A$, which coincides with the product of all eigenvalues of A , is positive. Let us assume that $\det \rho_t(A) = 0$. By definition this means

$$\det((1-t)A + t\mathbb{E}_n) = 0. \quad (2.14)$$

This means that $-t$ is an eigenvalue of $A' := (1-t)A$. But A' is just A , scaled by a positive real number. Hence A' is also positive definite and therefore cannot have a negative eigenvalue $-t$. Thus we obtain a contradiction, which proves that ρ_t really has its image contained in $\mathcal{H}_{(n,0)}$. The proof for the positive negative case works completely analogously.

What is now left to show is equivariance of the above deformation retract. But this follows from the fact that the involution on \mathcal{H}_n acts by conjugation and this is compatible with scaling by real numbers as done in (2.14). \square

This shows that the components $\mathcal{H}_{(n,0)}$ and $\mathcal{H}_{(0,n)}$ are equivariantly contractible to a point, thus the spaces $[X, \mathcal{H}_{(n,0)}]_G$ and $[X, \mathcal{H}_{(0,n)}]_G$ are trivial. On the other hand, as we will see in the following, interesting topology will occur in the case of mixed signatures: For $0 < p, q < n$ the components $\mathcal{H}_{(p,q)}$ have the $U(n)$ -orbit of $\mathbb{E}_{p,q}$ as equivariant strong deformation retract⁷. Proving this requires some preparations; we begin by introducing the following surjection:

$$\begin{aligned} \pi: \mathcal{H}_{(p,q)} &\rightarrow \text{Gr}_p(\mathbb{C}^n) \\ H &\mapsto E^+(H), \end{aligned}$$

where $E^+(H)$ denotes the direct sum of the positive eigenspaces of H . This is a p -dimensional subspace of \mathbb{C}^n . Fixing a basepoint $E_0 = \langle e_1, \dots, e_p \rangle$, this defines a fiber bundle with neutral fiber $F = \pi^{-1}(\{E_0\})$. The fiber consists of those matrices in $\mathcal{H}_{(p,q)}$ which have E_0 as the direct sum of their positive eigenspaces. Note that $K := U(n)$ acts transitively on $\text{Gr}_p(\mathbb{C}^n)$. Thus, denoting the stabilizer of E_0 in K with L , we can identify $\text{Gr}_p(\mathbb{C}^n)$ with K/L . We equip the product $K \times F$ with a K -action given by multiplication on the first factor:

$$k(k', H) \mapsto (kk', H).$$

The L -action on $K \times F$ is given by

$$\ell(k, H) = (k\ell, \ell^*H\ell).$$

⁷Here $\mathbb{E}_{p,q}$ denotes the block diagonal matrix with \mathbb{E}_p in the upper left corner and $-\mathbb{E}_q$ in the lower right corner.

It induces the quotient $K \times F \rightarrow K \times_L F$. The K -action on $K \times_L F$ is then given by

$$k[(k', H)] = [k(k', H)] = [(kk', H)].$$

The quotient $K \times_L F \rightarrow K/L$ is K -equivariant by definition of the respective K -actions. We obtain the following diagram of K -spaces:

$$\begin{array}{ccc} K \times F & \longrightarrow & K \times_L F \\ \downarrow & & \downarrow \\ K & \longrightarrow & K/L \end{array}$$

After these remarks we state:

Proposition 2.2.7 The component $\mathcal{H}_{(p,q)}$ has the orbit $U(n) \cdot \mathbb{E}_{p,q}$ as T -equivariant, strong deformation retract.

Proof. The idea of this proof is to use the above diagram and define a strong deformation retract of the fiber F which we then globalize to a strong deformation retraction on $K \times_L F$. Using the identifications $K \times_L F \cong \mathcal{H}_{(p,q)}$ and $K/L \cong \text{Gr}_p(\mathbb{C}^n)$ this defines a T -equivariant strong deformation retract from $\mathcal{H}_{(p,q)}$ to $U(n) \cdot \mathbb{E}_{p,q} \subset \mathcal{H}_{(p,q)}$ (see figure 2.4).

Note that we have the following isomorphism

$$\begin{aligned} \Psi: K \times_L F &\xrightarrow{\sim} \mathcal{H}_{(p,q)} \\ [(k, H)] &\mapsto kHk^*. \end{aligned} \tag{2.15}$$

Set $\Sigma = K \cdot \mathbb{E}_{p,q} \subset \mathcal{H}_{(p,q)}$. This defines (the image of) a global section of the bundle $K \times_L F \rightarrow K/L$. Observe that a matrix $H \in F$ is, by definition, positive-definite on $E_0 = \langle e_1, \dots, e_p \rangle$ and therefore negative-definite on $E_0^\perp = \langle e_{p+1}, \dots, e_{p+q} \rangle$ ⁸. This implies that H is of the form

$$H = \begin{pmatrix} H_p & 0 \\ 0 & H_q \end{pmatrix},$$

where H_p and H_q are both hermitian, H_p is positive-definite on E_0 and H_q is negative-definite on E_0^\perp . Now we can define a retraction $\rho: I \times F \rightarrow F$ of the neutral fiber:

$$\rho_t(H) = \begin{pmatrix} (1-t)H_p + t\mathbb{E}_p & 0 \\ 0 & (1-t)H_q - t\mathbb{E}_q \end{pmatrix}. \tag{2.16}$$

This is a well-defined map with image in the fiber F : The proof of remark 2.2.6 shows that the intermediate matrices during a homotopy of a definite matrix to $+\mathbb{E}_p$ resp.

⁸On \mathbb{C}^n we use the standard unitary structure.

$-\mathbb{E}_q$ stay definite. This generalizes to the situation at hand: Given a matrix H of signature (p, q) , then $\rho_t(H)$ will be of the same signature for every t . Therefore, $\rho_t(F) \subset F$ for all t . Next, extend ρ to a map

$$\begin{aligned}\hat{\rho}: I \times K \times F &\rightarrow K \times F \\ (t, (k, H)) &\mapsto (k, \rho_t(H))\end{aligned}$$

Now we prove that $\hat{\rho}$ is L -equivariant and therefore it pushes down to a map

$$I \times K \times_L F \rightarrow K \times_L F$$

For this, let ℓ be in L . Then

$$\ell(\hat{\rho}(t, k, H)) = \ell(k, \rho_t(H)) = (k\ell, \ell^* \rho_t(H)\ell)$$

On the other hand:

$$\hat{\rho}(\ell(t, k, H)) = \hat{\rho}(t, k\ell, \ell^* H\ell) = (k\ell, \rho_t(\ell^* H\ell))$$

Now, L -equivariance follows from the fact that matrix conjugation commutes with addition and scalar multiplication of matrices and therefore

$$\ell^* \rho_t(H)\ell = \rho_t(\ell^* H\ell).$$

By the isomorphism $K \times_L F \cong \mathcal{H}_{(p,q)}$, $\hat{\rho}$ induces a map $\tilde{\rho}: I \times \mathcal{H}_{(p,q)} \rightarrow \mathcal{H}_{(p,q)}$. Note that ρ_0 and therefore also $\hat{\rho}_0$ as well as the push-down to the quotient is the identity. On the other hand, ρ_1 retracts the fiber F to $\mathbb{E}_{p,q}$. Thus, $\hat{\rho}_1$ retracts $K \times F$ to $K \times \{\mathbb{E}_{p,q}\}$. Using the isomorphism $K \times_L F \cong \mathcal{H}_{(p,q)}$, it follows that $\tilde{\rho}$, retracts $\mathcal{H}_{(p,q)}$ to $\Sigma = K \cdot \mathbb{E}_{p,q}$.

It remains to prove that $\tilde{\rho}_t$ is T -equivariant for each t :

$$\tilde{\rho}_t(\overline{H}) = \overline{\tilde{\rho}_t(H)}. \quad (2.17)$$

A short computation shows that the isomorphism Ψ (2.15) is T -equivariant with respect to the T -action on $K \times_L F$ given by

$$T([(k, H)]) = [(\overline{k}, \overline{H})].$$

Therefore, in order to prove (2.17) we need to show that the induced map $I \times K \times_L F \rightarrow K \times_L F$ is T -equivariant. By definition this boils down to showing that

$$\left[(\overline{k}, \rho_t(\overline{H})) \right] = \left[(\overline{k}, \overline{\rho_t(H)}) \right],$$

which is a direct consequence of the definition of ρ_t as in (2.16). Summarizing the above we have seen that there exists a strong deformation retract $\tilde{\rho}$ from $\mathcal{H}_{(p,q)}$ to the orbit $K \cdot \mathbb{E}_{p,q}$ which is T -equivariant. \square

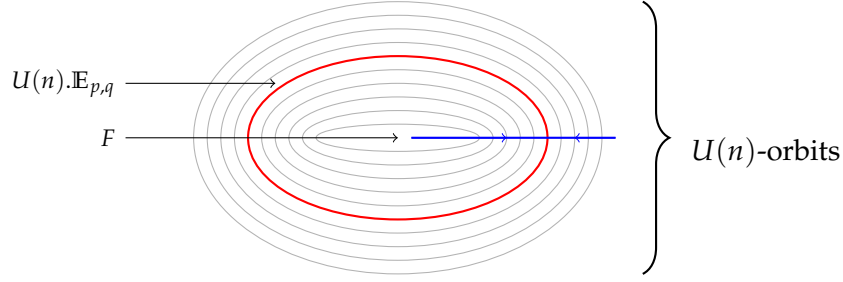

Figure 2.4. – The $U(n)$ -orbits in $\mathcal{H}_{(p,q)}$.

The $U(n)$ -orbit of $\mathbb{E}_{p,q}$ can be equivariantly and diffeomorphically identified with the complex Grassmann manifold $\text{Gr}_p(\mathbb{C}^n)$. This reduces the problem of describing the sets $[X, \mathcal{H}_{(p,q)}]_G$ to the problem of describing the sets $[X, \text{Gr}_p(\mathbb{C}^n)]_G$. As a first step towards the study of equivariant maps to $\text{Gr}_p(\mathbb{C}^n)$ we describe $(\text{Gr}_p(\mathbb{C}^n))_{\mathbb{R}}$, the space of real points with respect to the real structure T on $\text{Gr}_p(\mathbb{C}^n)$:

Remark 2.2.8 The space $(\text{Gr}_p(\mathbb{C}^n))_{\mathbb{R}}$ of real points is diffeomorphic to the real Grassmannian $\text{Gr}_p(\mathbb{R}^n)$.

Proof. Given any T -stable subspace V in \mathbb{C}^n , then T defines a decomposition $V = V_{\mathbb{R}} \oplus iV_{\mathbb{R}}$ where $V_{\mathbb{R}} = \text{Fix } T$ is a subspace of \mathbb{R}^n . Note that the group $O(n, \mathbb{R})$ acts transitively on $\text{Gr}_p(\mathbb{R}^n)$. Therefore, for any two T -stable p -dimensional subvector spaces $V, V' \subset \mathbb{C}^n$, there exists an orthogonal transformation g mapping the $V_{\mathbb{R}}$ to $V'_{\mathbb{R}}$. Such a transformation extends uniquely to a unitary transformation of \mathbb{C}^n which sends V to V' . Now, a computation shows that the stabilizer of the base point $V_0 = \langle e_1, \dots, e_p \rangle$ in $O(n, \mathbb{R})$ consists of the matrices of the form

$$g = \begin{pmatrix} g_1 & 0 \\ 0 & g_2 \end{pmatrix},$$

where $g_1 \in O(p, \mathbb{R})$ and $g_2 \in O(q, \mathbb{R})$. It follows that

$$(\text{Gr}_p(\mathbb{C}^n))_{\mathbb{R}} \cong \frac{O(n, \mathbb{R})}{O(p, \mathbb{R}) \times O(q, \mathbb{R})} \cong \text{Gr}_p(\mathbb{R}^n). \quad \square$$

We now proceed with the classification of equivariant maps to the space of non-singular $n \times n$ hermitian matrices:

$$H: X \rightarrow \mathcal{H}_n^*.$$

As shown earlier, such a map has a well-defined signature (p, q) (with $p + q = n$) specifying that $H(x)$ has exactly p positive eigenvalues and q negative eigenvalues for every $x \in X$. The classification for the image space \mathcal{H}_n will be achieved in the following way:

1. First we handle the classification of maps $X \rightarrow \mathcal{H}_3$ separately. In this situation the relevant image space can be reduced to the Grassmannian $\text{Gr}_1(\mathbb{C}^3) \cong \mathbb{P}_2$. The classification with respect to this image space works by making a reduction to the case of maps to \mathbb{P}_1 .
2. Then, for a general Grassmannian $\text{Gr}_p(\mathbb{C}^n)$ we apply a reduction method iteratively until we have reduced the situation to a copy of \mathbb{P}_1 embedded in $\text{Gr}_p(\mathbb{C}^n)$ as a Schubert variety. The separate discussion of \mathbb{P}_2 will act as a guiding example and provide useful statements for the final step of the iterative reduction.

For the following we need a notion of *total degree*, as the standard notion of degree (i. e. the Brouwer degree) is not applicable here, since X and a general Grassmann manifold $\text{Gr}_p(\mathbb{C}^n)$ have different dimensions. But because of the convenient geometrical properties of Grassmannians (see proposition A.1.13) we in fact do not have to change much: The second homology group is still infinite cyclic, which allows us to generalize the notion of total degree. For this, let $f: X \rightarrow \text{Gr}_p(\mathbb{C}^n)$ be a G -map. The homology group $H_2(X, \mathbb{Z})$ is generated by the fundamental class $[X]$. The homology group $H_2(\text{Gr}_p(\mathbb{C}^n), \mathbb{Z})$ is generated by $[S]$, where S denotes the Schubert variety

$$S = \left\{ E \in \text{Gr}_p(\mathbb{C}^n) : \mathbb{C}^{p-1} \subset E \subset \mathbb{C}^{p+1} \right\}. \quad (2.18)$$

Here, \mathbb{C}^ℓ is regarded as being embedded in \mathbb{C}^n , for $\ell < n$, via

$$(z_1, \dots, z_\ell) \mapsto (z_1, \dots, z_\ell, \underbrace{0, \dots, 0}_{n-\ell}).$$

In the terminology of e. g. [8], S is the Schubert variety

$$S = \left\{ E \in \text{Gr}_p(\mathbb{C}^k) : \dim(E \cap V_{k-p+i-a_i}) \geq i \text{ for all } i = 1, \dots, p \right\}$$

defined by the sequence

$$a_i = \begin{cases} n - p & \text{for } 1 \leq i < p - 1 \\ n - p - 1 & \text{for } p - 1 \leq i \leq p. \end{cases}$$

After having fixed the standard flag $V_1 \subset V_2 \subset \dots \subset V_n$, where V_j is the vector space generated by the standard basis vectors e_1, \dots, e_j , S is the unique one-dimensional Schubert variety in $\text{Gr}_p(\mathbb{C}^n)$. It is biholomorphic to \mathbb{P}_1 and comes equipped with its canonical orientation as a complex manifold. As it has been discussed on p. 14, this space can be equivariantly identified with the 2-sphere. Now we can make the following

Definition 2.2.9 Let $f: X \rightarrow \text{Gr}_p(\mathbb{C}^n)$ be a G -map. Then its induced map on the second homology is of the form

$$\begin{aligned} f_*: H_2(X, \mathbb{Z}) &\rightarrow H_2(\text{Gr}_p(\mathbb{C}^n), \mathbb{Z}) \\ [X] &\mapsto d[S]. \end{aligned}$$

We define the *total degree* of f to be this integer d and write $\deg f$ for the total degree of f .

Clearly, the total degree defined this way is a homotopy invariant of maps $X \rightarrow \text{Gr}_p(\mathbb{C}^n)$. We also need a slight generalization of definition 2.1.5 to account for the fundamental group of $(\text{Gr}_p(\mathbb{C}^n))_{\mathbb{R}}$ not being infinite cyclic unless $p = 1$ and $n = 2$:

Definition 2.2.10 (Fixed point signature) Let $f: M \rightarrow Y$ be a G -map between G -manifolds. Assume that the fixed point set $Y^G \subset Y$ is path-connected, $\pi_1(Y^G) = \mathbb{C}_2$ and that the fixed point set M^G is the disjoint union

$$M^G = \bigcup_{j=0, \dots, k} K_j$$

of circles K_j . Then we define the *fixed point signature* of f to be the k -tuple (m_0, \dots, m_k) where

$$m_j = \begin{cases} 0 & \text{if the loop } f|_{K_j}: K_j \rightarrow Y^G \text{ is contractible in } Y^G \\ 1 & \text{else.} \end{cases}$$

In the following let $n > 2$, i. e. we exclude the case $\text{Gr}_p(\mathbb{C}^n) = \mathbb{P}_1$, which has already been dealt with in section 2.1. For the type I involution on X we make the following definition:

Definition 2.2.11 (Degree triple map) For $n > 2$, we define the *degree triple map* to be the map

$$\begin{aligned} \mathcal{T}: \mathcal{M}_G(X, \text{Gr}_p(\mathbb{C}^n)) &\rightarrow \{0, 1\} \times \mathbb{Z} \times \{0, 1\} \\ f &\mapsto (m_0, d, m_1), \end{aligned}$$

where (m_0, m_1) is the fixed point signature of f with respect to the circles C_0, C_1 and d is the total degree of f . We call a given triple *realizable* if it is contained in the image $\text{Im}(\mathcal{T})$. For a map

$$f: (Z, C) \rightarrow (\text{Gr}_p(\mathbb{C}^n), \text{Gr}_p(\mathbb{C}^n)_{\mathbb{R}})$$

we define its *degree triple* to be the degree triple of the equivariant extension $\hat{f}: X \rightarrow \text{Gr}_p(\mathbb{C}^n)$.

For the type II involution on X we define:

Definition 2.2.12 (Degree pair map) For $n > 2$, we define the *degree pair map* to be the map

$$\begin{aligned} \mathcal{P}: \mathcal{M}_G(X, \mathrm{Gr}_p(\mathbb{C}^n)) &\rightarrow \mathbb{Z} \times \{0, 1\} \\ f &\mapsto (d, m), \end{aligned}$$

where (m) is the fixed point signature of f and d is the total degree of f . We call a given pair *realizable* if it is contained in the image $\mathrm{Im}(\mathcal{P})$. For a map

$$f: (Z, C) \rightarrow (\mathrm{Gr}_p(\mathbb{C}^n), \mathrm{Gr}_p(\mathbb{C}^n)_{\mathbb{R}})$$

we define its *degree pair* to be the degree pair of the equivariant extension $\hat{f}: X \rightarrow \mathrm{Gr}_p(\mathbb{C}^n)$.

The degree triple resp. the degree pair is clearly an invariant of equivariant homotopy.

2.2.1. Maps to \mathcal{H}_3

In this section we study the equivariant homotopy of maps $X \rightarrow \mathcal{H}_3^*$. The connected components of \mathcal{H}_3^* are parameterized by the eigenvalue signatures $(3, 0)$, $(2, 1)$, $(1, 2)$ and $(0, 3)$. The group actions are exactly the same as in the first chapter: we can regard X as being defined by the standard square torus, equipped with either the type I or the type II real structure and the involution on \mathcal{H}_3 is given by conjugation. It turns out that the classification of maps in the case where the image space is \mathcal{H}_3^* is not fundamentally different from the classification where it is \mathcal{H}_2^* . As before we start with a reduction procedure.

Let $H: X \rightarrow \mathcal{H}_3^*$ be a map with the signature (p, q) . Hence, H can be regarded as a map $X \rightarrow \mathcal{H}_{(p,q)}$. In the concrete case of maps to \mathcal{H}_3 with mixed signature we can now conclude with proposition 2.2.7 that $\mathcal{H}_{(2,1)}$ (resp. $\mathcal{H}_{(1,2)}$) can be equivariantly retracted to the orbit $U(3) \cdot \mathbb{E}_{2,1}$ (resp. $U(3) \cdot \mathbb{E}_{1,2}$). These orbits are equivariantly and diffeomorphically identifiable with $\mathrm{Gr}_2(\mathbb{C}^3)$ (resp. $\mathrm{Gr}_1(\mathbb{C}^3)$). Since these two Grassmann manifolds are by remark 2.2.25 equivalent as G -spaces, we can assume without loss of generality that we are dealing with G -maps of the form

$$X \rightarrow \mathrm{Gr}_1(\mathbb{C}^3) \cong \mathbb{P}_2,$$

where the involution T on \mathbb{P}_2 is given by standard complex conjugation:

$$T: [z_0 : z_1 : z_2] \mapsto [\bar{z}_0 : \bar{z}_1 : \bar{z}_2].$$

2.2.1.1. Maps to \mathbb{P}_2

For the following, let p_0 be the base point $[0 : 0 : 1] \in \mathbb{P}_2$ and regard \mathbb{P}_1 as being embedded in \mathbb{P}_2 as

$$[z_0 : z_1] \mapsto [z_0 : z_1 : 0].$$

Lemma 2.2.13 There exists an equivariant strong deformation retract ρ from $\mathbb{P}_2 \setminus \{p_0\}$ to $\mathbb{P}_1 \subset \mathbb{P}_2$.

Proof. Define ρ as follows:

$$\begin{aligned} \rho: I \times \mathbb{P}_2 \setminus \{p_0\} &\rightarrow \mathbb{P}_2 \setminus \{p_0\} \\ (t, [z_0 : z_1 : z_2]) &\mapsto [z_0 : z_1 : (1-t)z_2]. \end{aligned}$$

For $t = 0$ this is the identity of $\mathbb{P}_2 \setminus \{p_0\}$, for $t = 1$, this is the map

$$[z_0 : z_1 : z_2] \mapsto [z_0 : z_1 : 0].$$

This is well-defined, since ρ is only defined on the complement of the point p_0 . This construction is equivariant, because the multiplication with real numbers commutes with complex conjugation. \square

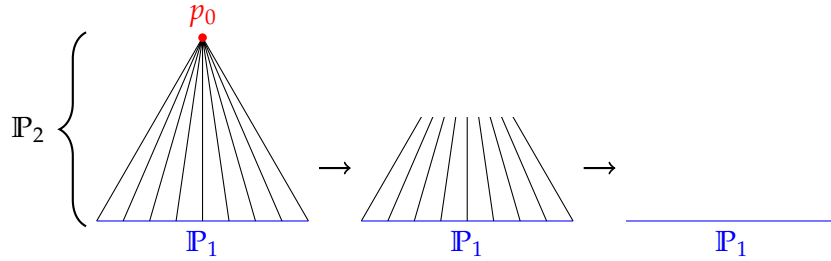

Figure 2.5. – $\mathbb{P}_2 \setminus \{p_0\}$ retracts to $\mathbb{P}_1 \subset \mathbb{P}_2$.

The strong deformation retract ρ (see figure 2.5 for a depiction) constructed in the previous lemma also defines a strong deformation retract of the fixed point set $(\mathbb{P}_2)_{\mathbb{R}}$ to the fixed point set $(\mathbb{P}_1)_{\mathbb{R}}$. For understanding what happens to fixed point signatures of maps $X \rightarrow \mathbb{P}_2$ during such a deformation retract we make the following remark:

Remark 2.2.14 Assume $n > 1$. Let $\gamma: I \rightarrow \mathbb{R}\mathbb{P}_1$ be the loop which wraps around $\mathbb{R}\mathbb{P}_1$ once. Let ι_n be the following embedding:

$$\begin{aligned} \iota_n: \mathbb{R}\mathbb{P}_1 &\rightarrow \mathbb{R}\mathbb{P}_n \\ [x_0 : x_1] &\mapsto [x_0 : x_1 : 0 : \dots : 0]. \end{aligned}$$

Then $\iota_n \circ \gamma$ defines the (up to homotopy) unique non-trivial loop in $\mathbb{R}\mathbb{P}_n$.

Proof. To simplify the notation set $\iota = \iota_n$. We have the following commutative diagram

$$\begin{array}{ccc} S^1 & \xrightarrow{\hat{\iota}} & S^n \\ \downarrow & & \downarrow \\ \mathbb{R}\mathbb{P}_1 & \xrightarrow{\iota} & \mathbb{R}\mathbb{P}_n \end{array}$$

Here, $\hat{\iota}$ can be regarded as the restriction of the embedding $\mathbb{R}^2 \hookrightarrow \mathbb{R}^{n+1}$ to $S^1 \subset \mathbb{R}^2$. Denote the loop which wraps around $\mathbb{R}P_1$ once by $\gamma: I \rightarrow \mathbb{R}P_1$. It can be lifted to a path $\hat{\gamma}: I \rightarrow S^1$, which makes a one-half loop in S^1 . Then, by commutativity of the diagram, it follows that $\widehat{\iota \circ \gamma} := \hat{\iota} \circ \hat{\gamma}$ is a lift of $\iota \circ \gamma$, the latter being a representant of the homotopy class $\iota_*[\gamma] \in \pi_1(\mathbb{R}P_n)$. It is well known (see e. g. [9, p. 74]) that $\pi_1(\mathbb{R}P_n)$ (for $n > 1$) is generated by the projection to $\mathbb{R}P_n$ of a curve in the universal covering space S^n which connects two antipodal points. Thus it is enough to show that $\widehat{\iota \circ \gamma}$ is not a closed loop in S^n . But this is clear, since $\hat{\gamma}$ is not a closed loop and $S^1 \hookrightarrow S^n$ is just an embedding. \square

As a consequence of the previous remark we can formulate:

Remark 2.2.15 Assume $n > 1$ and let ι be the embedding

$$\begin{aligned} \iota: \mathbb{R}P_n &\rightarrow \mathbb{R}P_{n+1} \\ [x_0 : \dots : x_n] &\mapsto [x_0 : \dots : x_n : 0]. \end{aligned}$$

Then the induced map $\iota_*: \pi_1(\mathbb{R}P_n) \rightarrow \pi_1(\mathbb{R}P_{n+1})$ is an isomorphism.

Proof. Since both fundamental groups are cyclic of order 2 it suffices to show that ι_* maps the non-trivial homotopy class $[\gamma] \in \pi_1(\mathbb{R}P_n)$ to the non-trivial homotopy class in $\pi_1(\mathbb{R}P_{n+1})$. Let α be the non-trivial loop in $\mathbb{R}P_n$ which is defined in terms of the embedding of $\mathbb{R}P_1 \hookrightarrow \mathbb{R}P_n$ (see remark 2.2.14). Then we have $[\gamma] = [\alpha]$. The homotopy class $\iota_*([\gamma])$ can thus be regarded as the homotopy class of the loop $\iota \circ \alpha$. But this is just the non-trivial loop constructed in the previous remark for $\mathbb{R}P_{n+1}$. Therefore, $\iota \circ \alpha$ is non-trivial and the statement is proven. \square

Note that there is a canonical embedding of $S^1 \cong \mathbb{R}P_1 \hookrightarrow \mathbb{R}P_2$ as the line at infinity:

$$[x_1 : x_2] \mapsto [x_1 : x_2 : 0]$$

Fix a point p_0 in $\mathbb{R}P_1$. We now define two loops: Let γ_0 be the loop which is constant at p_0 and let γ_1 be a fixed loop which wraps around $\mathbb{R}P_1 \subset \mathbb{R}P_2$ once. By remark 2.2.14 this defines the non-trivial element in $\pi_1(\mathbb{R}P_2)$.

Definition 2.2.16 A G -map $f: X \rightarrow \mathbb{P}_2$ is *fixed point normalized* if $f|_{C_j}$ is either γ_0 or γ_1 for all fixed point circles C_j in X .

Remark 2.2.17 Let X be equipped with the type I or the type II involution. Then every G -map $f: X \rightarrow \mathbb{P}_2$ can be fixed point normalized.

Proof. Using the equivariant version of the homotopy extension property of the pair (X, C) (see e. g. corollary A.1.10) we can prescribe a homotopy on each of the the fixed point circles of the torus which deforms the corresponding loop to either γ_0 or γ_1 , depending on the fixed point signature of the map. \square

Thus, after this normalization we can assume that maps with the same fixed point signature agree along the boundary circles.

Lemma 2.2.18 Let $f: X \rightarrow \mathbb{P}_2$ be a fixed point normalized G -map for the type I or the type II involution. Then:

- (i) The map f is equivariantly homotopic to a map f' which has its image contained in $\mathbb{P}_1 \subset \mathbb{P}_2$.
- (ii) The degree of f (definition 2.2.9) agrees with $\deg f'$, where f' is regarded as a map $X \rightarrow \mathbb{P}_1$.

Proof. Regarding (i): Let \widehat{C} be the union of the (finitely many) fixed point circles. Because of dimension reasons there exists a point $p \in \mathbb{R}\mathbb{P}_2$ which is not contained in the image of $f|_{\widehat{C}}$. Note that $\text{SO}(3, \mathbb{R})$ acts transitively on $\mathbb{R}\mathbb{P}_2$. Thus, let $g_1 \in \text{SO}(3, \mathbb{R})$ be the transformation in $\text{SO}(3, \mathbb{R})$ which sends p to $p_0 := [0 : 0 : 1]$. This transformation g_1 can also be regarded as a transformation of \mathbb{P}_2 , since $\text{SO}(3, \mathbb{R}) \subset \text{SU}(3)$. Also, since $\text{SO}(3, \mathbb{R})$ is path-connected we can find a path g_t from the identity in $\text{SO}(3, \mathbb{R})$ to g_1 . The composition $g_t \circ f$ is then a homotopy of f to a map \tilde{f} such that $p_0 \notin \text{Im } \tilde{f}$. This homotopy is also equivariant. Thus, without loss of generality we can assume that, at least after a G -homotopy, a given G -map $f: X \rightarrow \mathbb{P}_2$ does not have p_0 in its image. Let us assume that the given map f has this property. Then we can compose f with the equivariant strong deformation retract from remark 2.2.13 and therefore obtain an equivariant homotopy from f to a map f' such that $\text{Im } f' \subset \mathbb{P}_1 \subset \mathbb{P}_2$.

Regarding (ii): The degree $\deg f$ is the number d such that

$$f_*: H_2(X, \mathbb{Z}) \rightarrow H_2(\mathbb{P}_2, \mathbb{Z})$$

is the map

$$[X] \mapsto d[\mathbb{P}_1].$$

while the degree $\deg f'$ is the number d' such that

$$f'_*: H_2(X, \mathbb{Z}) \rightarrow H_2(\mathbb{P}_1, \mathbb{Z})$$

is the map

$$[X] \mapsto d'[\mathbb{P}_1].$$

The inclusion $\iota: \mathbb{P}_1 \hookrightarrow \mathbb{P}_2$ induces an isomorphism in the second homology group. Thus we can also regard f'_* as taking on values in $H_2(\mathbb{P}_2, \mathbb{Z})$. But since f and $\iota \circ f'$ are homotopic, their induced maps in homology must agree. This means $d = d'$. \square

Type I In this paragraph we are assuming the involution on X to be of type I.

Remark 2.2.19 Let $f: X \rightarrow \mathbb{P}_2$ be a fixed point normalized G -map. Then the map f has fixed point signature (m_1, m_0) iff f' (from lemma 2.2.18) has fixed point degree (m_0, m_1) .

Proof. Let us first assume that $f|_{C_j}: C_j \rightarrow \mathbb{R}\mathbb{P}_2$ is trivial, i.e. $m_j = 0$. Since f is fixed point normalized, we know that $f|_{C_j}$ is the constant map. Therefore, after making the deformation retract to $\mathbb{R}\mathbb{P}_1 \subset \mathbb{P}_1$ it is still constant, hence has degree zero. On the other hand, if a map $S^1 \rightarrow \mathbb{R}\mathbb{P}_1 \subset \mathbb{P}_1$ has degree zero, then it is already null-homotopic as a map to $\mathbb{R}\mathbb{P}_1$. Therefore it will also be null-homotopic as a map to $\mathbb{R}\mathbb{P}_2 \supset \mathbb{R}\mathbb{P}_1$.

Let us now assume that $f|_{C_j}: C_j \rightarrow \mathbb{R}\mathbb{P}_2$ is non-trivial, i.e. $m_j = 1$. In this case $f|_{C_j}$ is the map which wraps around $\mathbb{R}\mathbb{P}_1$ once. In particular, this loop will be fixed when composing with the strong deformation retract to \mathbb{P}_1 . Therefore, after the retraction, the resulting map will still have degree one along the boundary circle C_j . The reverse direction follows from remark 2.2.14, where we discussed the loop which wraps around $\mathbb{R}\mathbb{P}_1$ once; using the canonical embedding $\mathbb{R}\mathbb{P}_1 \hookrightarrow \mathbb{R}\mathbb{P}_2$, this loop defines a non-trivial element in $\pi_1(\mathbb{R}\mathbb{P}_2)$. \square

Theorem 2.2.20 The G -homotopy class of a map $f \in \mathcal{M}_G(X, \mathbb{P}_2)$ is uniquely determined by its degree triple $\mathcal{T}(f)$. The image $\text{Im}(\mathcal{T})$ of the degree triple map consists of those triples (m_0, d, m_1) (with $m_0, m_1 \in \{0, 1\}$) satisfying

$$d \equiv m_0 + m_1 \pmod{2}.$$

Proof. First we show that two maps with the same degree triple are equivariantly homotopic. Thus, let f and g be two G -maps $X \rightarrow \mathbb{P}_2$, both having the triple (m_0, d, m_1) . Using lemma 2.2.18 (i) we can assume that f and g have their images contained in $\mathbb{P}_1 \subset \mathbb{P}_2$. Applying lemma 2.2.18 (ii) and lemma 2.2.19 it then follows that the degree triple of f and g , regarded as a map $X \rightarrow \mathbb{P}_1$ is again (m_0, d, m_1) . Hence, by theorem 2.1.32, these maps are equivariantly homotopic.

Regarding the image $\text{Im}(\mathcal{T})$: Let us first assume that (m_0, d, m_1) is in the image. Then, by definition, there exists a map $f: X \rightarrow \mathbb{P}_2$ with this triple. Lemma 2.2.18 then implies the existence of a map $f': X \rightarrow \mathbb{P}_1$ with the same triple. Hence, by theorem 2.1.32, $d \equiv m_0 + m_1 \pmod{2}$. On the other hand, given a triple (m_0, d, m_1) with $m_0, m_1 \in \{0, 1\}$ and $d \equiv m_0 + m_1 \pmod{2}$, there exists a map $f: X \rightarrow S^2 \cong \mathbb{P}_1$ with this triple. Composing with the embedding $\mathbb{P}_1 \hookrightarrow \mathbb{P}_2$ we have produced a map $X \rightarrow \mathbb{P}_2$ which, again by lemma 2.2.18, has the same triple (m_0, d, m_1) . \square

Type II In this paragraph we are assuming the involution on X to be of type II.

Remark 2.2.21 Let $f: X \rightarrow \mathbb{P}_2$ be a fixed point normalized G -map. Then the map f has the fixed point signature m iff f' (from lemma 2.2.18) has the fixed point degree m .

Proof. The proof is exactly the same as in lemma 2.2.19. One only has consider the single circle C in X instead of two circles C_0 and C_1 . \square

Theorem 2.2.22 The G -homotopy class of a map $f \in \mathcal{M}_G(X, \mathbb{P}_2)$ is uniquely determined by its degree pair $\mathcal{P}(f)$. The image $\text{Im}(\mathcal{P})$ of the degree pair map consists of those pairs (d, m) (with $m \in \{0, 1\}$) satisfying

$$d \equiv m \pmod{2}.$$

Proof. The proof works completely analogously to the proof of theorem 2.2.20. For the first statement it suffices to show that two maps with the same degree pair are equivariantly homotopic. Thus, let f and g be two G -maps $X \rightarrow \mathbb{P}_2$, both having the pair (d, m) . Using lemma 2.2.18 (i) we can assume that f and g have their images contained in $\mathbb{P}_1 \subset \mathbb{P}_2$. Applying lemma 2.2.18 (ii) and lemma 2.2.21 it then follows that the degree pair of f and g , regarded as a map $X \rightarrow \mathbb{P}_1$ is again (d, m) . Hence, by theorem 2.1.50, these maps are equivariantly homotopic, which proves the statement.

Regarding the image $\text{Im}(\mathcal{P})$: Let us assume that (d, m) is in the image. By definition there exists a map $f: X \rightarrow \mathbb{P}_2$ with this pair. Lemma 2.2.18 then implies the existence of a map $f': X \rightarrow \mathbb{P}_1$ with the same pair. Hence, by theorem 2.1.50, $d \equiv m \pmod{2}$ is a necessary condition for a pair to be contained in $\text{Im}(\mathcal{P})$. On the other hand, given a pair (d, m) with $m \in \{0, 1\}$ and $d \equiv m \pmod{2}$, there exists a map $f: X \rightarrow S^2 \cong \mathbb{P}_1$ with this pair. Composing with the embedding $\mathbb{P}_1 \hookrightarrow \mathbb{P}_2$ we have produced a map $X \rightarrow \mathbb{P}_2$ which, again by lemma 2.2.18, has the same pair (d, m) . Therefore, (d, m) is contained in the image $\text{Im}(\mathcal{P})$. \square

2.2.1.2. Classification of Maps to \mathcal{H}_3^*

So far the degree triple map (resp. the degree pair map) has only been defined for G -maps $X \rightarrow \mathbb{P}_2$. But after fixing an identification of the orbit $U(3) \cdot \mathbb{E}_{p,q} \subset \mathcal{H}_{(p,q)}$, which has been shown to be an equivariant strong deformation retract, with \mathbb{P}_2 , the degree triple map (resp. the degree pair map) is also defined on all mapping spaces $\mathcal{M}_G(X, \mathcal{H}_{(p,q)})$ with $p + q = 3$. This remark then allows us to state and prove the main result of this section:

Theorem 2.2.23 Let X be a torus equipped with either the type I or the type II involution. Then:

- (i) The sets $[X, \mathcal{H}_{(3,0)}]_G$ and $[X, \mathcal{H}_{(0,3)}]_G$ are trivial.
- (ii) Two G -maps $X \rightarrow \mathcal{H}_{(p,q)}$ (with $0 < p, q < 3$) are G -homotopic iff their degree triples (type I) resp. their degree pairs (type II) agree.

- (iii) The realizable degree triples (m_0, d, m_1) (type I) resp. degree pairs (d, m) (type II) are exactly those which satisfy

$$d \equiv m_0 + m_1 \pmod{2} \text{ resp. } d \equiv m \pmod{2}.$$

Proof. The $\text{sig} = (3, 0)$ resp. the $\text{sig} = (0, 3)$ case is handled by remark 2.2.6, which proves that maps $X \rightarrow \mathcal{H}_{(2,0)}$ (resp. $X \rightarrow \mathcal{H}_{(0,2)}$) are equivariantly retractable to the map which is constant the identity (resp. minus identity). In the case of the signature being $(2, 1)$ (resp. $(1, 2)$) the image space has the projective space \mathbb{P}_2 as an equivariant strong deformation retract. In this case theorem 2.2.20 (for type I) and theorem 2.2.22 (for type II) complete the proof. \square

Remark 2.2.24 Clearly, the case $\text{sig} = (3, 0)$ (resp. $\text{sig} = (0, 3)$) is trivially realized by the map, which is constant the identity (resp. minus identity). Representants for the homotopy classes for $\text{sig} = (2, 1)$ and $\text{sig} = (1, 2)$ can be constructed as follows: Let $f: X \rightarrow S^2$ be a G -map. Using the orientation-preserving diffeomorphism $S^2 \xrightarrow{\sim} \mathbb{P}_1$, we can regard f as a map to \mathbb{P}_1 . Composing this map with the embedding $\mathbb{P}_1 \hookrightarrow \mathbb{P}_2$ yields a G -map $\tilde{f}: X \rightarrow \mathbb{P}_2$. Finally, we can compose \tilde{f} with one of the two embeddings $\iota_{(2,1)}, \iota_{(1,2)}: \mathbb{P}_2 \hookrightarrow \mathcal{H}_3^*$, which embed \mathbb{P}_2 in the respective component of \mathcal{H}_3^* associated to the signature $(2, 1)$ or $(1, 2)$.

2.2.2. Iterative Retraction Method

In this section we describe a reduction procedure which can be used iteratively until we arrive in a known situation, i.e. $\text{Gr}_1(\mathbb{C}^2) \cong \mathbb{P}_1$. We call this procedure *iterative retraction* of Grassmann manifolds. Recall section 2.2.1.1, in particular lemma 2.2.18: There we start with a G -map $f: X \rightarrow \mathbb{P}_2$ and remove a certain subset S (in this case, S is a point) from \mathbb{P}_2 which – at least after a G -homotopy – is not contained in the image $\text{Im}(f)$. The resulting space $\mathbb{P}_2 \setminus S$ has the submanifold $\mathbb{P}_1 \subset \mathbb{P}_2$ as equivariant, strong deformation retract. In this section we show that this method can be generalized to general Grassmann manifolds $\text{Gr}_p(\mathbb{C}^n)$. Fundamental for this reduction is the fact that the Schubert variety $\mathcal{S} \subset \text{Gr}_p(\mathbb{C}^n)$ is equivariantly identifiable with $\mathbb{P}_1 \cong S^2$ (see the definition of discussion of \mathcal{S} on p. 48).

The strategy in this chapter is to identify a higher-dimensional analog of the subset S in $\text{Gr}_p(\mathbb{C}^\ell)$ such that $\text{Gr}_p(\mathbb{C}^\ell) \setminus S$ has $\text{Gr}_p(\mathbb{C}^{\ell-1}) \subset \text{Gr}_p(\mathbb{C}^n)$ as equivariant strong deformation retract. This reduction step is the basic building block for the reducing the classification of maps to $\text{Gr}_p(\mathbb{C}^n)$ to the classification of maps to the Schubert variety \mathcal{S} . It works as follows:

Starting with a G -map $f: X \rightarrow \text{Gr}_p(\mathbb{C}^n)$, we identify a subset S with the aforementioned property and such that (after a G -homotopy) the image $\text{Im}(f)$ does not intersect S . Then, using the equivariant deformation retract to $\text{Gr}_p(\mathbb{C}^{n-1})$, we can regard f as having its image contained in $\text{Gr}_p(\mathbb{C}^{n-1})$. This step can be repeated until it can be assumed that the map f has its image contained in $\text{Gr}_p(\mathbb{C}^{p+1})$. The latter can

be equivariantly identified with $\text{Gr}_1(\mathbb{C}^{p+1})$. It follows that the reduction procedure just outlined can be repeated again until it can be assumed that the map f as its image contained in $\text{Gr}_1(\mathbb{C}^2)$. This subspace $\text{Gr}_1(\mathbb{C}^2)$ identified using the procedure just described is exactly the Schubert variety \mathcal{S} . We begin with the following remark in this direction:

Remark 2.2.25 Using the standard unitary structure on \mathbb{C}^n , the canonical map

$$\Psi: \text{Gr}_k(\mathbb{C}^n) \rightarrow \text{Gr}_{n-k}(\mathbb{C}^n),$$

where both Grassmannians are equipped with the real structure T sending a space V to \bar{V} , is equivariant with respect to T .

Proof. It must be shown that, for $V \in \text{Gr}_k(\mathbb{C}^n)$, $T(V)^\perp = T(V^\perp)$. This is equivalent to showing that $T(V)$ and $T(V^\perp)$ are orthogonal with respect to the standard hermitian form on \mathbb{C}^n . Thus, let $T(v)$ be in $T(V)$ (with $v \in V$) and $T(w)$ be in $T(V^\perp)$ (with $w \in V^\perp$). We have to show that $\langle T(v), T(w) \rangle = 0$. Equivalently we can show that $\overline{\langle T(v), T(w) \rangle} = 0$. A short computation yields:

$$\overline{\langle T(v), T(w) \rangle} = \overline{T(v)^* T(w)} = \overline{v^* w} = v^* w = 0.$$

This proves that $T(V)$ is orthogonal to $T(V^\perp)$ and therefore $T(V)^\perp = T(V^\perp)$. \square

For the technical arguments in this section we require that the smooth manifolds X and $\text{Gr}_p(\mathbb{C}^n)$ are both smoothly embedded in some euclidean space (using e.g. the Whitney embedding theorem). By $\dim_H(\cdot)$ we denote the Hausdorff dimension of a topological space. See section A.2 for some introductory statements about Hausdorff dimensions. The set S , being the higher dimensional analog of a point in the \mathbb{P}_2 situation, will be denoted by \mathcal{L}_L , where L is a line⁹ in \mathbb{C}^n , and is defined as follows:

$$\mathcal{L}_L = \{E \in \text{Gr}_p(\mathbb{C}^n) : L \subset E\}$$

Remark 2.2.26 The set \mathcal{L}_L is a submanifold of $\text{Gr}_p(\mathbb{C}^n)$ of complex dimension $(p - 1)(n - p)$.

Proof. Consider the map

$$\begin{aligned} f: \text{Gr}_{p-1}(L^\perp) &\rightarrow \text{Gr}_p(\mathbb{C}^n) \\ E &\mapsto \langle L, E \rangle, \end{aligned}$$

where $\langle L, E \rangle$ denotes the p -plane that is spanned by the line L together with the $p - 1$ -dimensional plane $E \subset L^\perp$. Clearly, $\text{Im } f = \mathcal{L}_L$. One can write down f in local coordinates for the Grassmannians, which shows that f is a holomorphic immersion. Furthermore, it is injective. Together with the compactness of $\text{Gr}_p(L^\perp)$ this shows

⁹By *line* we mean a 1-dimensional complex subspace.

that f is an holomorphic embedding (see e. g. [10, p. 214]). In other words, \mathcal{L}_L is biholomorphically equivalent to $\text{Gr}_{p-1}(\mathbb{C}^{n-1})$, a complex manifold of dimension $(p-1)(n-p)$. \square

Let $\mathbb{C}^n = L \oplus W$ be a decomposition of \mathbb{C}^n as direct sum of a T -stable line L and a 1-codimensional, T -stable subvector space W . In this setup, we can regard the Grassmann manifold $\text{Gr}_p(W)$ as a submanifold of $\text{Gr}_p(\mathbb{C}^n)$. The usefulness of the submanifold \mathcal{L}_L is illustrated by the following lemma:

Lemma 2.2.27 The space $\text{Gr}_p(\mathbb{C}^n) \setminus \mathcal{L}_L$ has $\text{Gr}_p(W)$ as equivariant strong deformation retract.

Proof. To ease the notation set $\Omega = \text{Gr}_p(\mathbb{C}^n) \setminus \mathcal{L}_L$. The idea of this proof is that

$$\pi: \Omega \rightarrow \text{Gr}_p(W)$$

can be regarded as a complex rank- k vector bundle, where π is defined in terms of the projection $\mathbb{C}^n \rightarrow W$. Here we use the fact that a p -dimensional plane E in \mathbb{C}^n which does not contain the line L projects down to a p -dimensional plane in W . The local trivializations of this bundle are defined using local trivializations of the tautological bundle $\mathcal{T} \rightarrow \text{Gr}_p(W)$: Let U_α be a trivializing neighborhood in $\text{Gr}_p(W)$ of the tautological bundle and

$$\psi_\alpha: \mathcal{T}|_{U_\alpha} \rightarrow U_\alpha \times \mathbb{C}^k$$

a local trivialization. In other words, the k maps

$$\begin{aligned} f_{\alpha,j}: U_\alpha &\rightarrow \mathcal{T}|_{U_\alpha} \\ E &\mapsto \psi_\alpha^{-1}(E, e_j) \quad \text{for } j = 1, \dots, k \end{aligned}$$

define a local frame over U_α . Let ℓ be non-zero vector in the line L . Notice that the fiber of $\Omega \rightarrow \text{Gr}_p(W)$ over a plane $E \in U_\alpha$ consists of those planes \hat{E} which are spanned by bases of the form

$$\lambda_1 \ell + f_{\alpha,1}(E), \dots, \lambda_k \ell + f_{\alpha,k}(E),$$

for a unique vector $\lambda = (\lambda_1, \dots, \lambda_k)$. The uniqueness follows from the fact that every vector in $\mathbb{C} = L \oplus W$ uniquely decomposes into $v_L + v_W$. Now we can define a local trivialization for $\Omega \rightarrow \text{Gr}_p(W)$ over U_α :

$$\begin{aligned} \varphi_\alpha: U_\alpha &\rightarrow \mathbb{C}^k \\ \hat{E} &\mapsto \left(\pi(\hat{E}), \lambda \right). \end{aligned}$$

This also defines the vectorspace structure on the fibers: For a given k -vector λ , define

$$\hat{E}_\lambda = \langle \lambda_1 \ell + f_{\alpha,1}(E), \dots, \lambda_k \ell + f_{\alpha,k}(E) \rangle.$$

Using this notation we obtain

$$\widehat{E}_\lambda + \widehat{E}_\mu = \widehat{E}_{\lambda+\mu} \text{ for all } \lambda, \mu \in \mathbb{C}^k \text{ and } a\widehat{E}_\lambda = \widehat{E}_{a\lambda} \text{ for all } a \in \mathbb{C}.$$

Thus, $\pi: \Omega \rightarrow \text{Gr}_p(W)$ defines a rank- k vector bundle. Note that the zero section of this bundle can be naturally identified with $\text{Gr}_p(W)$. Thus it remains to show that there is a G -equivariant retraction of Ω to its zero section. We define the retraction $\varphi_t: \Omega \rightarrow \Omega$ in local trivializations for a covering $\{U_\alpha\}$ via

$$\begin{aligned} \varphi_\alpha: I \times \mathbb{C}^k &\rightarrow \mathbb{C}^k \\ \lambda &\mapsto t\lambda. \end{aligned}$$

We now show that this gives a globally well-defined map $\varphi: I \times \Omega \rightarrow \Omega$: Let E be a plane in $U_\alpha \cap U_\beta$. Over U_α , the map φ_α is defined using the frame $f_{\alpha,1}, \dots, f_{\alpha,k}$, while φ_β is defined using the frame $f_{\beta,1}, \dots, f_{\beta,k}$. Let \widehat{E} be a plane in $\Omega|_{U_\alpha \cap U_\beta}$ such that

$$\widehat{E} = \langle \ell_1^\alpha + w_1^\alpha, \dots, \ell_k^\alpha + w_k^\alpha \rangle = \langle \ell_1^\beta + w_1^\beta, \dots, \ell_k^\beta + w_k^\beta \rangle,$$

where

$$w_j^\alpha = f_{\alpha,j} \left(\pi \left(\widehat{E} \right) \right) \text{ resp. } w_j^\beta = f_{\beta,j} \left(\pi \left(\widehat{E} \right) \right).$$

Since these two bases generate the same plane, there exists a $k \times k$ matrix $A = (a_{ij})$ such that

$$\ell_j^\alpha + w_j^\alpha = \sum a_{ij} \left(\ell_i^\beta + w_i^\beta \right).$$

Using the fact that the intersection $L \cap W$ is trivial we obtain

$$\ell_j^\alpha = \sum a_{ij} \ell_i^\beta \text{ and } w_j^\alpha = \sum a_{ij} w_i^\beta.$$

But then the bases

$$t\ell_1^\alpha + w_1^\alpha, \dots, t\ell_k^\alpha + w_k^\alpha \text{ and } t\ell_1^\beta + w_1^\beta, \dots, t\ell_k^\beta + w_k^\beta$$

are related by the same matrix A , hence they define the same plane \widehat{E}_t . In other words, the deformation retract φ_t is globally well-defined on Ω . In particular the above shows that for any plane $E = \langle \ell_1 + w_1, \dots, \ell_k + w_k \rangle$, where the W -vectors are not necessarily the ones defined by one of the trivializing frames of the tautological bundle we have

$$\varphi_t(E) = \langle (1-t)\ell_1 + w_1, \dots, (1-t)\ell_k + w_k \rangle.$$

Now, using the fact that L and W are both T -stable, equivariance follows by a computation:

$$\begin{aligned}
\varphi_t \circ T(E) &= \varphi_t (T(\langle \ell_1 + w_1, \dots, \ell_k + w_k \rangle)) \\
&= \varphi_t \left(\langle \overline{\ell_1 + w_1}, \dots, \overline{\ell_k + w_k} \rangle \right) \\
&= \langle (1-t)\overline{\ell_1} + \overline{w_1}, \dots, (1-t)\overline{\ell_k} + \overline{w_k} \rangle \\
&= \langle \overline{(1-t)\ell_1 + w_1}, \dots, \overline{(1-t)\ell_k + w_k} \rangle \\
&= T(\langle (1-t)\ell_1 + w_1, \dots, (1-t)\ell_k + w_k \rangle) \\
&= T(\varphi_t(\langle \ell_1 + w_1, \dots, \ell_k + w_k \rangle)) \\
&= T \circ \varphi_t(E).
\end{aligned}$$

This proves the statement. \square

The next intermediate result will be the statement that, given a map H from X to $\text{Gr}_p(\mathbb{C}^n)$ where $n-1 > p$, there always exists a line L in \mathbb{C}^n such that – at least after a G -homotopy – the image of H does not intersect \mathcal{L}_L . Then, lemma 2.2.27 is applicable and we obtain an equivariant homotopy from H to a map H' having its image contained in the lower-dimensional Grassmannian embedded in $\text{Gr}_p(\mathbb{C}^n)$. We begin by outlining some technical preparations and introducing a convenient notation. For a plane p -plane E in \mathbb{C}^n we set $E_T = E \cap T(E)$. Note that $0 \leq \dim E_T \leq p$. For $k = 0, \dots, p$ define $\mathcal{E}_k = \{E \in \text{Gr}_p(\mathbb{C}^n) : \dim E_T = k\}$. This induces a stratification of $\text{Gr}_p(\mathbb{C}^n)$:

$$\text{Gr}_p(\mathbb{C}^n) = \bigcup_{k=0, \dots, p} \mathcal{E}_k.$$

Note that in particular we have

$$\mathcal{E}_p = \{E \in \text{Gr}_p(\mathbb{C}^n) : T(E) = E\} = (\text{Gr}_p(\mathbb{C}^n))_{\mathbb{R}}$$

Define the following incidence set:

$$\mathcal{I} = \{(L, E) \in \mathbb{P}(\mathbb{C}^n) \times \text{Gr}_p(\mathbb{C}^n) : L \subset E\}.$$

The set \mathcal{I} is a manifold, which can be seen by considering the diagonal action of $U(n)$ on the product manifold $\mathbb{P}(\mathbb{C}^n) \times \text{Gr}_p(\mathbb{C}^n)$: $U(n)$ acts transitively on \mathcal{I} . Furthermore we introduce

$$\mathcal{I}_{\mathbb{R}} = \{(L, E) \in (\mathbb{P}(\mathbb{C}^n))_{\mathbb{R}} \times \text{Gr}_p(\mathbb{C}^n) : L \subset E\} = \{(L, E) \in \mathcal{I} : T(L) = L\}.$$

We obtain two projections, namely

$$\begin{aligned}
\pi_1 : \mathcal{I} &\rightarrow \mathbb{P}(\mathbb{C}^n) \\
\text{and } \pi_2 : \mathcal{I} &\rightarrow \text{Gr}_p(\mathbb{C}^n),
\end{aligned}$$

together with their “real” counterparts

$$\begin{aligned}\pi_{1,\mathbb{R}}: \mathcal{I}_{\mathbb{R}} &\rightarrow (\mathbb{P}(\mathbb{C}^n))_{\mathbb{R}} \\ \text{and } \pi_{2,\mathbb{R}}: \mathcal{I}_{\mathbb{R}} &\rightarrow \text{Gr}_p(\mathbb{C}^n).\end{aligned}$$

We regard the incidence manifold \mathcal{I} as being smoothly embedded in some \mathbb{R}^N (e. g. with the Whitney embedding theorem).

Defining $M_k := \pi_{2,\mathbb{R}}^{-1}(\mathcal{E}_k)$ we obtain – for each k – a fiber bundle

$$M_k \xrightarrow{\pi_{2,\mathbb{R}}} \mathcal{E}_k$$

with the fiber, over a plane $E \in \mathcal{E}_k$, being

$$\begin{aligned}F_k &= \{(L, E): L \in \mathbb{P}(\mathbb{C}^n), T(L) = L \text{ and } L \subset E\} \\ &= \{(L, E): L \in \mathbb{P}(\mathbb{C}^n) \text{ and } L \subset E_T\} \\ &\cong \mathbb{P}(E_T) \\ &\cong \mathbb{P}_{k-1}\end{aligned}$$

for all $k = 1, \dots, p$. In particular we obtain the estimate

$$\dim_{\mathbb{R}} F_k = \dim_{\mathbb{C}}(E_T) - 1 = k - 1 \leq p - 1. \quad (2.19)$$

Let us now focus on the image $\text{Im } H$ of a map $H: X \rightarrow \text{Gr}_p(\mathbb{C}^n)$. Without loss of generality we can assume that H is equivariantly smoothed (theorem A.1.5). For each $k = 0, \dots, p$ we set $H(X)_k = H(X) \cap \mathcal{E}_k$ and $M = \pi_{2,\mathbb{R}}^{-1}(H(X)) \subset \mathcal{I}_{\mathbb{R}}$. Note that

$$M = \{(L, E) \in (\mathbb{P}(\mathbb{C}^n))_{\mathbb{R}} \times \text{Gr}_p(\mathbb{C}^n): E \in \text{Im } H \text{ and } L \subset E\}.$$

Having the above formalism in place, we can now focus on the fundamental problem: Understanding the image of M under the projection $\pi_{1,\mathbb{R}}$. The following remark highlights what kind of dimension estimate we need in order to conclude the existence of a line L such that the image $\text{Im } H$ does not intersect \mathcal{L}_L .

Remark 2.2.28 If the inequality

$$\dim_H(\pi_{1,\mathbb{R}}(M)) < \dim_H(\mathbb{P}(\mathbb{C}^n)_{\mathbb{R}}) = n - 1$$

is satisfied, then there exists a line L in \mathbb{C}^n such that $\mathcal{L}_L \cap H(X) = \emptyset$.

Proof. The inequality implies that $\pi_{1,\mathbb{R}}(M) \subsetneq \mathbb{P}(\mathbb{C}^n)_{\mathbb{R}}$, since otherwise both sets would have the same Hausdorff dimension. Recall that $M = \pi_{2,\mathbb{R}}^{-1}(H(X))$. Thus, the non-surjectivity of $\pi_{1,\mathbb{R}}|_M$ means that there exists a T -fixed line L in \mathbb{C}^n which has no $\pi_{1,\mathbb{R}}$ -preimage in the set

$$\pi_{2,\mathbb{R}}^{-1}(H(X)) = \{(L, E) \in \mathbb{P}(\mathbb{C}^n)_{\mathbb{R}} \times \text{Gr}_p(\mathbb{C}^n): E \in H(X) \text{ and } L \subset E\}.$$

If there was a plane $E \in H(X)$ with $L \subset E$, then (L, E) would be in $\pi_{2,\mathbb{R}}^{-1}(H(X))$, which is a contradiction. Hence, there cannot exist such a plane E in the image of H . \square

By the above remark together with theorem A.2.1 (5) it suffices to prove that $\dim_H(M)$ is smaller than $n - 1$ in order to conclude the existence of a T -fixed line L such that $\text{Im } H$ has empty intersection with \mathcal{L}_L . This is the next goal. The preimage M can be written as a finite union

$$M = \bigcup_{k=0, \dots, p} \pi_{2, \mathbb{R}}^{-1}(H(X)_k).$$

With corollary A.2.3 it follows that

$$\dim_H M = \max_k \left\{ \dim_H(\pi_{2, \mathbb{R}}^{-1}(H(X)_k)) \right\}. \quad (2.20)$$

But each set $\pi_{2, \mathbb{R}}^{-1}(H(X)_k)$ is contained in the total space M_k of the fiber bundle $M_k \rightarrow \mathcal{E}_k$. Applying corollary A.2.5 yields

$$\dim_H \left(\pi_{2, \mathbb{R}}^{-1}(H(X)_k) \right) = \dim_H(H(X)_k) + \dim(F_k).$$

Substituting the dimension of the fiber computed in (2.19) yields

$$\dim_H \left(\pi_{2, \mathbb{R}}^{-1}(H(X)_k) \right) = \dim_H(H(X)_k) + k - 1.$$

Therefore, (2.20) implies:

$$\dim_H(M) = \max_k \left\{ \dim_H(H(X)_k) + k - 1 \right\}. \quad (2.21)$$

Thus, in order to control $\dim_H(M)$ it suffices to control each $\dim_H(H(X)_k)$. But since $H(X)$ cannot have Hausdorff dimension bigger than two (H is assumed to be smooth) and under the assumption that $p \leq n - 2$, we directly obtain the estimate

$$\begin{aligned} \dim_H(M) &\leq \max\{p, \dim_H(H(X)_p) + p - 1\} \\ &\leq \max\{n - 2, \dim_H(H(X)_p) + p - 1\}. \end{aligned}$$

Thus we only have to control the dimension of $H(X)_p$. In order to obtain the desired estimate $\dim_H(M) < n - 1$ it suffices to have $\dim_H(H(X)_p) \leq 1$. In the following we show that – up to G -homotopy – this can be assumed. Although, for proving the main result of this section, it suffices to reduce a general Grassmannian $\text{Gr}_p(\mathbb{C}^n)$ until we arrive at $\text{Gr}_1(\mathbb{C}^3) \cong \mathbb{P}_2$, we state the following in its general form, i. e. including the statement for the reduction from \mathbb{P}_2 to \mathbb{P}_1 :

Proposition 2.2.29 Given an equivariant map $f: X \rightarrow \text{Gr}_p(\mathbb{C}^n)$ with $n \geq 3$ and $1 \leq p \leq n - 2$, there exists a decomposition of \mathbb{C}^n into the direct sum of a line $L \subset \mathbb{C}^n$ and a 1-codimensional subvector space $W \subset \mathbb{C}^n$, both T -stable, such that $\mathcal{L}_L \cap \text{Im } f = \emptyset$.

Proof. We prove the statement in two parts. First we prove that the statement is true for $0 < p \leq n - 3$ and then we separately deal with the case $p = n - 2$. Both proofs

work by analyzing the image $\text{Im } f$ and then using dimension estimates to deduce the existence of a line $L \subset \mathbb{C}^n$ with $\mathcal{L}_L \cap \text{Im } f$ being the empty set. Without loss of generality we can assume that f is a smooth G -map (see theorem A.1.5). Recall that smooth functions are, in particular, Lipschitz continuous.

First assume $p \leq n - 3$. Since $\dim_H(X) = 2$, it follows that $\dim_H(H(X)) \leq 2$ by theorem A.2.1 (5). In particular, $\dim_H(H(X)_k) \leq 2$ for all $k = 0, \dots, p$. Thus, using (2.21) we obtain

$$\begin{aligned} \dim_H(M) &= \max_{k=0, \dots, p} \{ \dim_H(H(X)_k) + k - 1 \} \\ &\leq p + 1 \\ &\leq n - 2 \\ &< n - 1. \end{aligned}$$

Hence, the non-surjectivity of $\pi_{1, \mathbb{R}}|_M$ is established in the case $p \leq n - 3$. For the remaining case $p = n - 2$ we can apply lemma 2.2.30 (see below) which guarantees that, at least after a G -homotopy:

$$\dim_H(H(X)_p) \leq 1.$$

In this case we can write

$$\dim_H(M) = \max_{k=0, \dots, p} \{ \dim_H(H(X)_k) + k - 1 \} \leq p = n - 2 < n - 1.$$

Thus, in both cases we have constructed a homotopy from the map H to a map H' such that $\mathcal{L}_L \cap \text{Im}(H') = \emptyset$ for some T -fixed line $L \subset \mathbb{C}^n$. Take W to be the orthogonal complement $L^\perp \subset \mathbb{C}^n$. In particular W is also T -stable. This finishes the proof. \square

The following lemma completes the proof of the previous proposition 2.2.29:

Lemma 2.2.30 Every G -map $H: X \rightarrow \text{Gr}_p(\mathbb{C}^n)$ is equivariantly homotopic to a G -map H' such that $\dim_H(H'(X)_p) \leq 1$.

Proof. Recall that $H(X)_p = H(X) \cap \mathcal{E}_p$ and $\mathcal{E}_p = (\text{Gr}_p(\mathbb{C}^n))_{\mathbb{R}}$. Thus in order to minimize the dimension of $H(X)_p$ we need to modify H by moving its image away from the real points in $\text{Gr}_p(\mathbb{C}^n)$. To ease the notation we set $Y = \text{Gr}_p(\mathbb{C}^n)$. Now we let

$$N \xrightarrow{\pi_{Y, \mathbb{R}}} Y_{\mathbb{R}}$$

be the normal vector bundle of $Y_{\mathbb{R}}$ in Y . The bundle N comes equipped with a bundle norm $\|\cdot\|$. Now we can use the standard method of diffeomorphically identifying an open tubular neighborhood U of the 0-section of N (which can be identified with $Y_{\mathbb{R}}$ itself) with an open neighborhood V of $Y_{\mathbb{R}}$ in Y . We denote this diffeomorphism $U \rightarrow V$ by Ψ . In the following we construct an equivariant homotopy H_t such that $H_0 = H$ and H_1 has the desired property of $\dim_H(H_1(X) \cap Y_{\mathbb{R}})$ being at most one.

For this, let s be a generic section in $\Gamma(Y_{\mathbb{R}}, N)$. In particular this means that there are only finitely many points over which s vanishes. Furthermore, let χ be a smooth cut-off function which is constantly one in a small neighborhood $U' \subset\subset U$ of the zero section in N and which vanishes outside of U . Now define

$$g_t^s(v) = v - t\chi(v)s(\pi_{Y,\mathbb{R}}(v)).$$

After scaling s by a constant such that $\|s(\cdot)\|$ is sufficiently small, g_t^s defines a diffeomorphism $U \rightarrow U$. Then, via the diffeomorphism Ψ , we obtain an induced diffeomorphism $\tilde{g}_t^s: V \rightarrow V$. Since the cut-off function χ vanishes near the boundary of U , \tilde{g}_t^s extends to a diffeomorphism $Y \rightarrow Y$ which is the identity outside of V . Define

$$H_t^s := \tilde{g}_t^s \circ H: X \rightarrow Y.$$

Note that H_t^s is not necessarily equivariant anymore for positive t . This will be corrected later in the proof by restricting the maps H_t^s to a (pseudo-)fundamental region R of X and then equivariantly extending to all of X . As a first step towards equivariance of H_t^s , we need to make sure that H_t^s maps $\text{Fix } T \subset X$ into $Y_{\mathbb{R}}$ for all t . To guarantee this, let f be a C^∞ function on $Y_{\mathbb{R}}$ such that

$$\{f = 0\} = \Psi^{-1}(H(\text{Fix } T)) \subset U. \quad (2.22)$$

By multiplying the section s with this function f (and, by abuse of notation, denoting the resulting section again s) it is guaranteed that \tilde{g}_t^s is the identity along $\text{Fix } T \subset X$, hence H_t^s still maps the fixed point set X^T into $Y^T = Y_{\mathbb{R}}$ for all t . In the next step we need to estimate of the ‘‘critical set’’

$$C_s = \{x \in X: H_1^s(x) \in Y_{\mathbb{R}}\}.$$

By construction, a matrix $H_1^s(x)$ is contained in the real part $Y_{\mathbb{R}}$ iff $\Psi^{-1} \circ H_1^s(x)$ is contained in the zero-section in the normal bundle N . By definition this means

$$g_1^s \circ \Psi^{-1} \circ H(x) = 0,$$

which, by definition of g_t^s , is equivalent to saying that

$$\Psi^{-1}(H(x)) = s \left(\pi_{Y,\mathbb{R}} \left(\Psi^{-1}(H(x)) \right) \right).$$

Using the fact that C_s must be contained in $H^{-1}(V)$ we can conclude that

$$C_s = \left\{ x \in H^{-1}(V): \Psi^{-1} \circ H(x) = s \circ \pi_{Y,\mathbb{R}} \circ \Psi^{-1} \circ H(x) \right\}.$$

We have to prove that, for some choice of s , $\dim_H(C_s) \leq 1$. If $H(x) \in Y_{\mathbb{R}}$ for some x , then $H_1^s(x) \in Y_{\mathbb{R}}$ is almost never satisfied (s is almost never zero). Hence, it suffices to estimate the dimension of the set

$$C_s \setminus H^{-1}(Y_{\mathbb{R}}) = \{x \in \Omega: \Psi^{-1} \circ H(x) = s \circ \pi_{Y,\mathbb{R}} \circ \Psi^{-1} \circ H(x)\},$$

where

$$\Omega = H^{-1}(V) \setminus H^{-1}(Y_{\mathbb{R}}).$$

We show that by scaling the section s appropriately, we obtain the desired estimate $\dim_H(C_s) \leq 1$. Observe that Ω is an open set in X , hence in particular a real manifold of dimension two, not necessarily connected. But it has at most countably many connected components which we denote by $\{\Omega_j\}_{j \in J}$. Define the following function

$$h_s: \Omega \rightarrow \mathbb{R}$$

$$x \mapsto \frac{\|s(\pi_{Y, \mathbb{R}}(\Psi^{-1}(H(x))))\|}{\|\Psi^{-1}(H(x))\|}.$$

This quotient is well-defined on Ω , since Ω does not include the H -preimage of $Y_{\mathbb{R}}$, which corresponds to the zero-section in U . Therefore h_s defines a smooth function on Ω . It now follows that

$$C_s \setminus H^{-1}(Y_{\mathbb{R}}) = h_s^{-1}(\{1\}).$$

Now we introduce the scaling of the section s such that $h_s^{-1}(\{1\})$ is at most one-dimensional. Since the number of connected components Ω_j is at most countable, there exists a number ε arbitrary close to 1 such that there exists no component Ω_j on which $h_s \equiv \varepsilon$ and furthermore such that ε is a regular value for h_s on all the components Ω_j on which h_s is not constant. It then follows that $h_s^{-1}(\{\varepsilon\})$ is one-dimensional and

$$h_s^{-1}(\{\varepsilon\}) = h_{\varepsilon s}^{-1}(\{1\}) = C_{\varepsilon s} \setminus H^{-1}(Y_{\mathbb{R}}).$$

Thus, for the section εs we have the desired dimension estimate of the critical set.

Finally we correct the missing equivariance of H_1 as follows: In the type I case we let Z be the cylinder fundamental region and restrict the homotopy H_t just constructed to Z . By remark 2.1.8, the homotopy $H|_Z$ extends uniquely to an equivariant homotopy $\tilde{H}: I \times X \rightarrow Y$. Define $H' = \tilde{H}_1$. It remains to check that the above estimate of $h_s^{-1}(\{1\})$ remains valid. But this follows with corollary A.2.3, which proves the statement for the type I involution.

For the type II case we let R be the pseudofundamental region introduced in the beginning of section (p. 31). In this case we need to make sure that we do not destroy the equivariance property on the set $A = A_1 \cup A_2$ (see p. 31). In order to be able to use the method of restriction (to R) followed by equivariant extension, we need to make sure that the homotopy $H|_{I \times R}$ behaves well on the boundary of R (see remark 2.1.36). For this we make two small adjustments to the above construction. First, using the homotopy extension property together with the simply-connectedness of Y we make a homotopy to the original map H such that it is constant along $A_1, A_2 \subset \partial R$ (compare with the type II normalization, in particular proposition 2.1.41, p. 2.1.41). It follows

that the images $H(A_1)$ and $H(A_2)$ are one-point sets contained in $Y_{\mathbb{R}}$. Second, we modify the function f introduced in (2.22): Instead of letting this helper function f vanish exactly over $\Psi^{-1}(H(\text{Fix } T))$, we let it vanish over the bigger set $\Psi^{-1}(H(\partial R))$ (notice that $\text{Fix } T \subset \partial R$). It then follows that the homotopy H_t does not change H along the image $H(\partial R) \subset V$. In particular, it preserves the compatibility condition on $A \subset \partial R$ which is required for the equivariance. Now we can construct the equivariant extension to all of X as in the type I case above. The desired dimension estimate remains satisfied because of corollary A.2.3. \square

Having proposition 2.2.29 in place, we formulate the main result of this section:

Proposition 2.2.36 Assume $n \geq 3$ and $1 \leq p \leq n - 1$. Let $f: X \rightarrow \text{Gr}_p(\mathbb{C}^n)$ be a G -map. Then f is equivariantly homotopic to the map $\iota \circ f'$ where $\text{Im}(f')$ is contained in the Schubert variety \mathcal{S} and ι is the above embedding of \mathcal{S} into $\text{Gr}_p(\mathbb{C}^n)$. By identifying $\mathcal{S} \cong \mathbb{P}_1$, the degree triples (resp. degree pairs) of $f: X \rightarrow \text{Gr}_p(\mathbb{C}^n)$ and $f': X \rightarrow \mathcal{S} \cong \mathbb{P}_1$ agree.

Its proof will be given on p. 69. By proposition 2.2.29 we know there exists a line L such that \mathcal{L}_L is not contained in the image of a given map H . For using this statement as the building block for the iterative retraction procedure it is convenient to be able to normalize this line L . This is made precise in the following remark:

Remark 2.2.31 Let L be a T -stable line in \mathbb{C}^n . Then there exists a curve $g(t)$ in $\text{SO}(n, \mathbb{R})$ such that $g(0) = \text{Id}$ and $g(1)$ maps \mathcal{L}_L to \mathcal{L}_{L_0} where L_0 is the n -th standard line $L_0 = \mathbb{C} \cdot e_n$.

Proof. By assumption the line L is T -stable. This implies that L is generated by a vector v_n of unit length such that $T(v_n) = v_n$. In other words, v_n is in $(\mathbb{C}^n)_{\mathbb{R}} = \mathbb{R}^n$. Furthermore, the orthogonal complement L^{\perp} of L is also T -invariant. Let (v_1, \dots, v_{n-1}) be an orthonormal basis of $(L^{\perp})_{\mathbb{R}}$. Then, (v_1, \dots, v_n) is an orthonormal basis of \mathbb{C}^n consisting solely of real vectors. Define g as the element of $\text{SO}(n, \mathbb{R})$ which maps v_j to e_j for all $j = 1, \dots, n$. Using the path-connectedness of $\text{SO}(n, \mathbb{R})$ we can find a path $g(t)$ such that $g(0) = \text{Id}$ and $g(1) = g$. Hence, by construction, $g(1)$ maps the line L to L_0 . It remains to show that

$$g(\mathcal{L}_L) = \mathcal{L}_{L_0}.$$

For this, let E be a p -plane in \mathcal{L}_L . Then, by definition, $L \subset E$. But then also $g(L) = L_0 \subset g(E)$. On the other hand, given a plane E in with $L_0 \subset E$, then define $E' = g^{-1}(E)$. It follows that $L \subset E'$, on other words $E' \in \mathcal{L}_L$. Now we see that $E = g(E') \in \mathcal{L}_L$. \square

Combining the above we can make a reduction from $\text{Gr}_p(\mathbb{C}^n)$ to the smaller manifold $\text{Gr}_p(\mathbb{C}^{n-1})$:

Proposition 2.2.32 Given an equivariant map $f: X \rightarrow \text{Gr}_p(\mathbb{C}^n)$ where $3 \leq n$ and $1 \leq p \leq n-2$, then there exists a G -homotopy from f to a map f' whose image is contained in $\text{Gr}_p(\mathbb{C}^{n-1})$, where \mathbb{C}^{n-1} is regarded as being embedded in \mathbb{C}^n as $(z_1, \dots, z_n) \mapsto (z_1, \dots, z_n, 0)$.

Proof. Due to the conditions on p and n , proposition 2.2.29 is applicable. Hence there exists a T -stable decomposition $\mathbb{C}^n = L \oplus W$ such that $\mathcal{L}_L \cap \text{Im } f = \emptyset$. Using remark 2.2.31 it follows that there exists a curve $g(t)$ of $\text{SO}(n, \mathbb{R})$ transformations such that $g(1)$ maps \mathcal{L}_L to \mathcal{L}_{L_0} where L_0 is the standard line $\mathbb{C}e_n$. Now define a homotopy $F_t = g(t)f$. Then, by construction, $F_0 = f$ and $\text{Im } F_1 \cap \mathcal{L}_{L_0} = \emptyset$. In this situation lemma 2.2.27 is applicable and we obtain an equivariant homotopy from f to a map f' such that $\text{Im}(f')$ is contained in the lower dimensional Grassmannian $\text{Gr}_p(\mathbb{C}^{n-1})$. \square

Taking the degree invariants (triples and pairs) into account we state the following addition to the previous proposition:

Lemma 2.2.33 As before, assume $n \geq 4$ and $1 \leq p \leq n-2$. Let f be a G -map $X \rightarrow \text{Gr}_p(\mathbb{C}^n)$ and denote the canonical embedding $\text{Gr}_p(\mathbb{C}^{n-1}) \hookrightarrow \text{Gr}_p(\mathbb{C}^n)$ by ι . Assume there exists a G -map $f': X \rightarrow \text{Gr}_p(\mathbb{C}^{n-1})$ such that f and $\iota \circ f'$ are equivariantly homotopic. Then, depending on the involution type, the degree triples (type I) resp. the degree pairs (type II) of f and f' agree for any two such maps.

Proof. The existence of the map f' is the statement of proposition 2.2.32: we obtain a map f' , equivariantly homotopic to f , whose image is contained in $\text{Gr}_p(\mathbb{C}^{n-1})$. Thus, we can regard f' as a map to $\text{Gr}_p(\mathbb{C}^{n-1})$ and clearly we then obtain $f = \iota \circ f'$. Regarding the degree invariants: By remark 2.2.34, the embedding ι induces an isomorphism

$$\iota_*: H_2(\text{Gr}_p(\mathbb{C}^{n-1}), \mathbb{Z}) \xrightarrow{\sim} H_2(\text{Gr}_p(\mathbb{C}^n), \mathbb{Z}).$$

Note that ι_* maps a generating cycle $[C]$ of $H_2(\text{Gr}_p(\mathbb{C}^{k-1}), \mathbb{Z})$ to the generating cycle $\iota_*([C]) = [\iota(C)]$ of $H_2(\text{Gr}_p(\mathbb{C}^k), \mathbb{Z})$. We regard C as being canonically oriented as a complex manifold. Since $f_* = \iota_* \circ f'_*$, it follows that f_* and f'_* are defined in terms of the same multiplication factor; in other words: The total degree of the map does not change when we regard it as a map to the lower dimensional Grassmann manifold.

It remains to check that the fixed point signatures do not change during the retraction. For this let $C \subset X$ be one of the fixed point circles (any of the two circles in type I or the unique circle in type II). The restrictions

$$f|_C: C \rightarrow \text{Gr}_p(\mathbb{R}^n) \quad \text{and} \quad \iota \circ f'|_C: C \rightarrow \text{Gr}_p(\mathbb{R}^n)$$

are homotopic, thus they define the same class $[\gamma]$ in the fundamental group of $\text{Gr}_p(\mathbb{R}^n)$. By construction f' has its image contained in $\text{Gr}_p(\mathbb{R}^{n-1}) \subset \text{Gr}_p(\mathbb{R}^n)$, thus its restriction to the circle C can be regarded as a map $C \rightarrow \text{Gr}_p(\mathbb{R}^{n-1})$, defining a homotopy class $[\gamma']$ in $\pi_1(\text{Gr}_p(\mathbb{R}^{n-1}))$. By remark 2.2.35, the inclusion $\text{Gr}_p(\mathbb{R}^{n-1}) \hookrightarrow$

$\text{Gr}_p(\mathbb{R}^n)$ induces an isomorphism of their fundamental groups if $n \geq 4$. This implies that $[\gamma]$ and $[\gamma']$ are either both trivial or both non-trivial, which proves the statement. \square

To complete the previous lemma we need the following two remarks:

Remark 2.2.34 Assume $0 < p < k - 1$. The embedding

$$\iota: \text{Gr}_p(\mathbb{C}^{k-1}) \hookrightarrow \text{Gr}_p(\mathbb{C}^k)$$

of Grassmann manifold induces an isomorphism on their second homology groups. More precisely, let \mathcal{S} be the Schubert variety generating $H_2(\text{Gr}_p(\mathbb{C}^{k-1}), \mathbb{Z})$ (see p. 48), then

$$\iota_*([\mathcal{S}]) = [\iota(\mathcal{S})].$$

Proof. Note that the second homology groups of complex Grassmann manifolds are infinite cyclic. Fix the standard flag in \mathbb{C}^k and let \mathcal{C} be the Schubert variety with respect to this flag which generates $H_2(\text{Gr}_p(\mathbb{C}^{k-1}), \mathbb{Z})$. By means of the embedding ι it can also be regarded as being contained in the bigger Grassmannian $\text{Gr}_p(\mathbb{C}^k)$, where it also generates $H_2(\text{Gr}_p(\mathbb{C}^k), \mathbb{Z})$. In other words: the embedding ι maps the generator of $H_2(\text{Gr}_p(\mathbb{C}^{k-1}), \mathbb{Z})$ to the generator of $H_2(\text{Gr}_p(\mathbb{C}^k), \mathbb{Z})$. It follows that the induced map

$$\iota_*: H_2(\text{Gr}_p(\mathbb{C}^{k-1}), \mathbb{Z}) \rightarrow H_2(\text{Gr}_p(\mathbb{C}^k), \mathbb{Z})$$

is an isomorphism. \square

Remark 2.2.35 Let $k \geq 4$. The embedding

$$\iota: \text{Gr}_p(\mathbb{R}^{k-1}) \hookrightarrow \text{Gr}_p(\mathbb{R}^k)$$

of real Grassmannians induces an isomorphism of their fundamental groups.

Proof. We begin the proof with a general remark: For every Grassmannian $\text{Gr}_p(\mathbb{R}^m)$ we have the following double cover

$$\widetilde{\text{Gr}}_p(\mathbb{R}^m) \rightarrow \text{Gr}_p(\mathbb{R}^m), \tag{2.23}$$

where $\widetilde{\text{Gr}}_p(\mathbb{R}^k)$ denotes the *oriented* Grassmannian. The covering map is given by forgetting the orientation of each subspace. It is known that for $m > 2$ the oriented Grassmannian $\text{Gr}_p(\mathbb{R}^m)$ is simply connected. Thus, by assumption about k , the oriented Grassmannians $\widetilde{\text{Gr}}_p(\mathbb{R}^{k-1})$ and $\widetilde{\text{Gr}}_p(\mathbb{R}^k)$ are simply-connected. Thus, (2.23) defines the universal cover of $\text{Gr}_p(\mathbb{R}^m)$, and this implies that $\pi_1(\text{Gr}_p(\mathbb{R}^m))$ is isomorphic to the Deck transformation group $\text{Deck}(\widetilde{\text{Gr}}_p(\mathbb{R}^m)/\text{Gr}_p(\mathbb{R}^m))$ (see [9, p. 71]). The Deck

transformation group in this case consists of the single homeomorphism σ , which flips the orientation on each subspace, thus it is C_2 and we obtain $\pi_1(\mathrm{Gr}_p(\mathbb{R}^k)) \cong C_2$.

To show that the induced map

$$\iota_*: \pi_1(\mathrm{Gr}_p(\mathbb{R}^{k-1})) \rightarrow \pi_1(\mathrm{Gr}_p(\mathbb{R}^k))$$

is an isomorphism it suffices to show that a non-trivial loop γ in $\mathrm{Gr}_p(\mathbb{R}^{k-1})$ will still be non-trivial when it is, using the embedding ι , regarded as a loop in $\mathrm{Gr}_p(\mathbb{R}^k)$. We have the following diagram:

$$\begin{array}{ccc} \widetilde{\mathrm{Gr}}_p(\mathbb{R}^{k-1}) & \xrightarrow{\hat{\iota}} & \widetilde{\mathrm{Gr}}_p(\mathbb{R}^k) \\ \downarrow & & \downarrow \\ \mathrm{Gr}_p(\mathbb{R}^{k-1}) & \xrightarrow{\iota} & \mathrm{Gr}_p(\mathbb{R}^k) \end{array}$$

Let γ be a non-trivial loop in $\mathrm{Gr}_p(\mathbb{R}^{k-1})$, say $\gamma(0) = \gamma(1) = E$. Its lift to the universal cover is a non-closed curve $\hat{\gamma}$ with $\hat{\gamma}(0) = E^+$ and $\hat{\gamma}(1) = E^-$, where E^+ and E^- denote the same plane E but equipped with different orientations, i.e. $\sigma(E^+) = \sigma(E^-)$. It follows that $\hat{\iota} \circ \hat{\gamma}$ is a lift of $\iota \circ \gamma$. The curve $\hat{\iota} \circ \hat{\gamma}$ is not closed, as it is still a curve whose endpoints are related by the orientation-flipping map σ . Under the isomorphism from the Deck transformation group to the fundamental group of the base (see e.g. on p. 34 the proof of theorem 5.6 in [7]), σ corresponds to the curve $\iota \circ \gamma$. Since σ is non-trivial, so is $\iota \circ \gamma$. This proves that the embedding ι induces an isomorphism on the fundamental groups. \square

Now we can finally prove our main reduction statement:

Proposition 2.2.36 Assume $n \geq 3$ and $1 \leq p \leq n - 1$. Let $f: X \rightarrow \mathrm{Gr}_p(\mathbb{C}^n)$ be a G -map. Then f is equivariantly homotopic to the map $\iota \circ f'$ where $\mathrm{Im}(f')$ is contained in the Schubert variety \mathcal{S} and ι is the above embedding of \mathcal{S} into $\mathrm{Gr}_p(\mathbb{C}^n)$. By identifying $\mathcal{S} \cong \mathbb{P}_1$, the degree triples (resp. degree pairs) of $f: X \rightarrow \mathrm{Gr}_p(\mathbb{C}^n)$ and $f': X \rightarrow \mathcal{S} \cong \mathbb{P}_1$ agree.

Proof. Note that in the case $n = 3$, this is just the statement of lemma 2.2.18 together with remark 2.2.19 resp. remark 2.2.21.

If $n \geq 4$, apply proposition 2.2.32 iteratively until we arrive at $n = p + 1$, producing a G -homotopy from f to a map f' whose image is contained in $\mathrm{Gr}_p(\mathbb{C}^{p+1})$. Note that by assumption $p + 1 > 3$. This space can be equivariantly identified with $\mathrm{Gr}_1(\mathbb{C}^{p+1})$ by remark 2.2.25. Now proposition 2.2.32 can be applied again iteratively to the map

$$\tilde{f}: X \rightarrow \mathrm{Gr}_p(\mathbb{C}^{p+1}) \cong \mathrm{Gr}_1(\mathbb{C}^{p+1})$$

until we arrive at $p = 2$, yielding a map

$$f': X \rightarrow \mathrm{Gr}_1(\mathbb{C}^3) \cong \mathbb{P}_2.$$

By lemma 2.2.33, up to this point, the degree triple (type I) resp. the degree pair (type II) of the map is unchanged. For the last reduction step to $\text{Gr}_1(\mathbb{C}^2)$ we first apply a G -homotopy in order to make sure that both maps are fixed point normalized (see definition 2.2.16). Then lemma 2.2.18 and remark 2.2.19 (type I) resp. remark 2.2.21 (type II) together with remark 2.2.34 imply that the final reduction step to $\mathcal{S} \cong \mathbb{P}_1$ also keeps the degree triple (resp. the degree pair) unchanged. Thus, in the end we have an equivariant homotopy from f to a map whose image is contained in \mathcal{S} and whose degree triples (resp. pairs) as a map $X \rightarrow \mathcal{S} \cong \mathbb{P}_1$ are those of f . \square

We can now prove the main result for the equivariant homotopy classification of maps $X \rightarrow \text{Gr}_p(\mathbb{C}^n)$:

Theorem 2.2.37 Let the torus X be equipped with the type I involution (resp. the type II involution). Assume $n > 3$ and $1 < p < n$. Then the homotopy class of a map f in $\mathcal{M}_G(X, \text{Gr}_p(\mathbb{C}^n))$ is completely determined by its degree triple (type I) resp. its degree pair (type II). Furthermore, the image $\text{Im}(\mathcal{T})$ (resp. $\text{Im}(\mathcal{P})$) consists of those degree triples (m_0, d, m_1) (resp. degree pairs (d, m)) satisfying

$$d \equiv m_0 + m_1 \pmod{2} \text{ (resp. } d \equiv m \pmod{2}\text{)}.$$

Proof. We only prove the statement for the type I involution case, as the other case works analogously. Let f and g be two G -maps with the same degree triple. By proposition 2.2.36 these maps are equivariantly homotopic to maps $\iota \circ f'$ and $\iota \circ g'$, where f' and g' are G -maps $X \rightarrow \mathcal{S}$ and ι is the embedding of the Schubert variety \mathcal{S} into $\text{Gr}_p(\mathbb{C}^n)$. Furthermore, by the same statement, the degree invariants remain unchanged. By transitivity, this proves the first statement.

Regarding the image $\text{Im}(\mathcal{T})$ (resp. $\text{Im}(\mathcal{P})$): As before, we can use the embedding

$$\mathcal{S} \hookrightarrow \text{Gr}_p(\mathbb{C}^n)$$

together with the iterative retraction method to show that the conditions

$$d \equiv m_0 + m_1 \pmod{2} \text{ (type I) resp. } d \equiv m \pmod{2} \text{ (type II)}$$

are both sufficient and necessary for the degree triples (resp. degree pairs) to be in the image of \mathcal{T} (type I) resp. \mathcal{P} (type II). \square

2.2.3. Classification of Maps to \mathcal{H}_n^*

As in the previous cases we note that the degree triple map (resp. the degree pair) is so far only defined on the mapping spaces $\mathcal{M}_G(X, \text{Gr}_p(\mathbb{C}^n))$. But after fixing an identification of each orbit $U(n) \cdot \mathbb{E}_{p,q} \subset \mathcal{H}_{(p,q)}$ ($0 < p, q < n$) with $\text{Gr}_p(\mathbb{C}^n)$, the degree triple map (resp. the degree pair map) is also defined on the mapping spaces $\mathcal{M}_G(X, \mathcal{H}_{(p,q)})$ for each non-definite signature (p, q) . This allows us to state and prove the main result of this section:

Theorem 2.2.38 Let X be a torus equipped with either the type I or the type II involution. Assume $n \geq 3$ and $0 < p, q < 1$. Then:

- (i) The sets $[X, \mathcal{H}_{(n,0)}]_G$ and $[X, \mathcal{H}_{(0,n)}]_G$ are trivial.
- (ii) Two G -maps $X \rightarrow \mathcal{H}_{(p,q)}$ are G -homotopic iff their degree triples (type I) resp. their degree pairs (type II) agree.
- (iii) The realizable degree triples (m_0, d, m_1) (type I) resp. degree pairs (d, m) (type II) are exactly those which satisfy

$$d \equiv m_0 + m_1 \pmod{2} \quad \text{resp.} \quad d \equiv m \pmod{2}.$$

Proof. The case $n = 3$ has already been dealt with in theorem 2.2.23. Therefore it suffices to consider the case $n > 3$. The topological triviality of the definite signature cases is handled in remark 2.2.6. Let f and g be two equivariant maps $X \rightarrow \mathcal{H}_{(p,q)}^*$. By proposition 2.2.7 the image space has $\text{Gr}_p(\mathbb{C}^n)$ as equivariant deformation retract. Thus, f and g can be regarded as G -maps $X \rightarrow \text{Gr}_p(\mathbb{C}^n)$ with the same degree triple resp. the same degree pair. Now theorem 2.2.37 can be applied. Part (i) implies that f and g are G -homotopic while part (ii) contains the statement about realizable degree triples resp. degree invariants. \square

Remark 2.2.24 explains how to concretely realize maps to \mathcal{H}_3 of a given degree invariant. This works equally well in the general situation. Let (p, q) be a fixed signature ($p + q = n$) such that $0 < p, q < n$. If n is smaller than 4 we end up in one projective situations already handled (i. e. maps to \mathbb{P}_1 or maps to \mathbb{P}_2). Thus, assume $n \geq 4$. In section 2.1 we have seen how to construct maps of a (realizable) degree triple resp. degree pair to $S^2 \cong \mathbb{P}_1$. We then identify \mathbb{P}_1 with the Schubert variety \mathcal{S} and compose this map with the embedding $\mathcal{C} \hookrightarrow \text{Gr}_p(\mathbb{C}^n)$ to obtain a map into the $\text{Gr}_p(\mathbb{C}^n)$. The latter Grassmannian needs to be embedded as the $U(n)$ -orbit of $\mathbb{E}_{p,q}$ into $\mathcal{H}_{(p,q)}$ (see proposition 2.2.7).

3. Topological Jumps

In this chapter we construct curves

$$H: [-1, 1] \times X \rightarrow \mathcal{H}_n$$

of equivariant maps $X \rightarrow \mathcal{H}_n$ such that the maps H_{-1} and H_{+1} , whose images are assumed to be contained in \mathcal{H}_n^* , represent distinct G -homotopy classes. In order to make this precise, we make the following definitions:

Definition 3.0.39 Let $H: X \rightarrow \mathcal{H}_n$ be a G -map. Then we define its *singular set* to be the set

$$S(H) = \{x \in X: \det H(x) = 0\} \subset X.$$

A G -map $X \rightarrow \mathcal{H}_n$ is called *singular* (resp. non-singular) if its singular set is non-empty (resp. empty).

Definition 3.0.40 A *jump curve* from H_- to H_+ (both in $\mathcal{M}_G(X, \mathcal{H}_n)$) is a G -map¹ $H: [-1, 1] \times X \rightarrow \mathcal{H}_n$ such that

- (i) $H_{\pm 1} = H_{\pm}$ and
- (ii) $H_t = H(t, \cdot)$ is non-singular for $t \neq 0$.

Given two G -maps $H_{\pm}: X \rightarrow \mathcal{H}_n$ belonging to distinct G -homotopy classes and a jump curve H_t from H_- to H_+ , then H_0 must be singular. Otherwise H_t would induce a G -homotopy $I \times X \rightarrow \mathcal{H}_n^*$ from H_- to H_+ , which would imply that H_- and H_+ are equivariantly homotopic.

Of course, given a two G -maps $H_{\pm}: X \rightarrow \mathcal{H}_n$, we can always consider the affine curve

$$(1 - t)H_- + tH_+$$

of G -maps connecting H_- and H_+ in the vectorspace \mathcal{H}_n . But in this case we have no control over the singular set; neither is it guaranteed that the degeneration only occurs at $t = 0$, nor that the singularity set $S(H_0)$ is in some sense “small”. In this chapter we construct jump curves obeying the restriction that the singular set $S(H_0)$ is *discrete*. The main result of this chapter is the description of a procedure for constructing jump

¹ G is assumed to act trivially on the interval.

curves for G -maps $X \rightarrow \mathcal{H}_{(p,q)} \subset \mathcal{H}_n^*$ ($n \geq 2$) from any G -homotopy class to any other G -homotopy class with a finite singular set; the only requirement is that the signature (p, q) remains unchanged. Note that jumps from one signature (p, q) to a different signature (p', q') are not possible with a finite singular set as shown in the following remark:

Remark 3.0.41 If a curve $H_t: X \rightarrow \mathcal{H}_n^*$ of G -maps whose only degeneration occurs at $t = 0$ jumps from one signature (p, q) to a different signature (p', q') , then the singular set $S(H_0)$ is the whole space X .

Proof. Under the assumption that $(p, q) \neq (p', q')$, let x be an arbitrary point in X . We have to show that $H_0(x)$ is singular. Assume the opposite, i.e. that $H_0(x)$ is non-singular. Then $c(t) = H_t(x)$ is a continuous curve in \mathcal{H}_n^* with $c(-1) \in \mathcal{H}_{(p,q)}$ and $c(1) \in \mathcal{H}_{(p',q')}$. But for $(p, q) \neq (p', q')$, $\mathcal{H}_{(p,q)}$ and $\mathcal{H}_{(p',q')}$ denote two distinct connected components of \mathcal{H}_n^* , this yields a contradiction. Therefore, $S(H_0) = X$. \square

Note that in order to be able to construct jump curves, it does not suffice to consider maps of the type $X \rightarrow Y$ where Y is a Grassmannian $\text{Gr}_p(\mathbb{C}^n)$, as these spaces are the deformation retracts of the components $\mathcal{H}_{(p,q)}$, which consist entirely of non-singular matrices. Instead we need to let the image space Y be a subspace of the closure of $\mathcal{H}_{(p,q)}$ having non-empty intersection with its boundary:

$$\begin{aligned} Y &\subset \text{cl}(\mathcal{H}_{(p,q)}) \\ Y \cap \partial\mathcal{H}_{(p,q)} &\neq \emptyset. \end{aligned}$$

For the curve H_t to be a jump curve it must satisfy

$$\text{Im}(H_0) \cap \partial\mathcal{H}_{(p,q)} \neq \emptyset,$$

as otherwise it would not be singular at $t = 0$ and the possibility of jumps would be excluded. See figure 3.1 for a depiction of a jump curve.

As in the previous chapter, we handle the case $n = 2$ first and then use the methods for $n = 2$ for proving a general statement. For the $n = 2$ case we will use as image space a certain subspace of $\text{cl}(\mathcal{H}_{(1,1)})$, namely the vector space $isu_2 \subset \text{cl}(\mathcal{H}_{(1,1)})$ consisting of the hermitian operators of trace zero in \mathcal{H}_2 . The space $isu_2 \setminus \{0\}$ contains the $U(2)$ -orbit of $\mathbb{E}_{1,1}$, which we have already identified as an equivariant strong deformation retract of $\mathcal{H}_{(1,1)}$ (see proposition 2.1.3), and the origin in isu_2 , which is the unique singular matrix among the hermitian matrices of trace zero, is contained in the boundary $\partial\mathcal{H}_{(1,1)}$. For the general case we embed isu_2 into $\mathcal{H}_{(p,q)}$ such that it contains the – with respect to the standard flag for \mathbb{C}^n – unique one-dimensional Schubert variety $\mathcal{S} \subset \text{Gr}_p(\mathbb{C}^n)$ (see the discussion on p. 48). This setup allows us to use the same methods as for the $n = 2$ case.

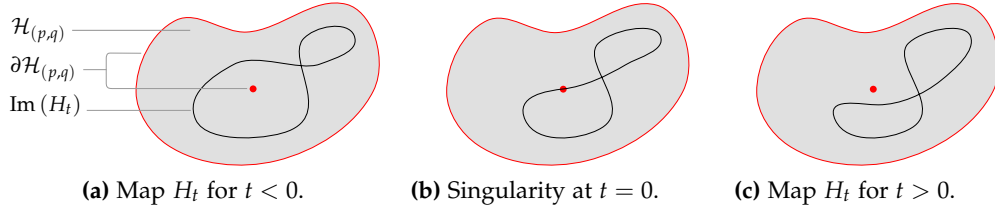

Figure 3.1. – A jump curve.

3.1. Maps into $\text{cl}(\mathcal{H}_2)$

Let us first understand how jumps can occur for maps into \mathcal{H}_2 . Since the components $\mathcal{H}_{(2,0)}$ and $\mathcal{H}_{(0,2)}$ are topologically trivial, the only relevant component to consider is $\mathcal{H}_{(1,1)}$. Recall the definition of the vector space isu_2 :

$$isu_2 = \left\{ \begin{pmatrix} a & b \\ \bar{b} & -a \end{pmatrix} : a \in \mathbb{R}, b \in \mathbb{C} \right\}.$$

The space $isu_2 \setminus \{0\}$ is contained in $\mathcal{H}_{(1,1)}$. It is important that this space is not *entirely* contained in $\mathcal{H}_{(1,1)}$, as we have

$$isu_2 \cap \partial\mathcal{H}_{(1,1)} = \left\{ \begin{pmatrix} 0 & 0 \\ 0 & 0 \end{pmatrix} \right\}$$

As discussed earlier, isu_2 can be linearly identified with \mathbb{R}^3 via

$$\begin{pmatrix} a & b \\ \bar{b} & -a \end{pmatrix} \mapsto \begin{pmatrix} a \\ \text{Re}(b) \\ \text{Im}(b) \end{pmatrix}. \quad (3.1)$$

Recall that the $U(2)$ -orbit of the diagonal matrix $\mathbb{E}_{1,1}$ is contained in $isu_2 \setminus \{0\}$ and is identified by the isomorphism (3.1) with the unit sphere in \mathbb{R}^3 .

In the following we construct jump curves as follows: Given two G -maps $H_{\pm}: X \rightarrow S^2$, we regard them as maps into $S^2 \subset \mathbb{R}^3$ and then construct a map of the form $H: [-1, 1] \times X \rightarrow \mathbb{R}^3$ such that $H_{-1} = H_-$ and $H_{+1} = H_+$. First we introduce some new definitions, which are slightly more suitable for this concrete approach than definition 3.0.40:

Definition 3.1.1 Let $H: X \rightarrow \mathbb{R}^3$ be a G -map. We define the *singular set* $S(H)$ of H to be the fiber $H^{-1}(\{0\})$. The singular set of a map $(Z, C) \rightarrow (\mathbb{R}^3, \{z = 0\})$ is the singular set of its equivariant extension.

Definition 3.1.2 A *jump curve* from H_- to H_+ (both in $\mathcal{M}_G(X, \mathbb{R}^3 \setminus \{0\})$) is a G -map $H: [-1, 1] \times X \rightarrow \mathbb{R}^3$ such that

- (i) $H_{\pm 1} = H_{\pm}$ and
- (ii) $0 \notin \text{Im}(H_t)$ for $t \neq 0$.

Futhermore, a *jump curve* from

$$H_- \in \mathcal{M}((Z, C), (\mathbb{R}^3 \setminus \{0\}, (\mathbb{R}^3 \setminus \{0\}) \cap \{z = 0\}))$$

to

$$H_+ \in \mathcal{M}((Z, C), (\mathbb{R}^3 \setminus \{0\}, (\mathbb{R}^3 \setminus \{0\}) \cap \{z = 0\}))$$

is a G -map $H: [-1, 1] \times (Z, C) \rightarrow (\mathbb{R}^3, \{z = 0\})$ such that the equivariant extension of H to $[-1, 1] \times X$ is a jump curve from the equivariant extension of H_- to the equivariant extension of H_+ .

By means of the isomorphism (3.1), a jump curve between maps $X \rightarrow \mathbb{R}^3 \setminus \{0\}$ induces a jump curve between maps $X \rightarrow \mathcal{H}_n^*$. For the concrete construction of the curve H_t we often require that the maps H_{\pm} are in *normal form* (see p. 28) or in *modified normal form* (see p. 76, definition 3.1.4). We use the terms *curves* and *homotopies* (of G -maps) interchangeably.

3.1.1. Type I

In this section, X always denotes the torus equipped with the type I involution. For illustrative purposes, we begin with a very naive jumping method, which does not satisfy our requirement of the singular set being small:

Lemma 3.1.3 Let X be the type I torus and let $d_0^{\pm}, d_1^{\pm}, d_0^{\pm}, d_1^{\pm}$ be integers. Denote by $H_{\pm}: X \rightarrow \mathcal{H}_{(1,1)}$ the G -maps in normal form for the triples

$$(d_0^{\pm}, d_0^{\pm} - d_1^{\pm}, d_1^{\pm}).$$

Then there exists a jump curve

$$H: [-1, 1] \times X \rightarrow \text{cl}(\mathcal{H}_{(1,1)})$$

from H_- to H_+ such that the singular set $S(H_0)$ consists of the two circles $C_0 \cup C_1$.

Proof. Let $H_{\pm}: X \rightarrow S^2 \subset \mathbb{R}^3$ be the maps in normal form for the triples $(d_0^{\pm}, d_0^{\pm} - d_1^{\pm}, d_1^{\pm})$ as it has been constructed as part of the proof of proposition 2.1.30 (ii). In the following we construct a jump curve

$$H: [-1, 1] \times X \rightarrow \mathbb{R}^3$$

from H_- to H_+ . The maps H_\pm are of the form

$$H_\pm = \begin{pmatrix} x_\pm \\ y_\pm \\ z_\pm \end{pmatrix}.$$

Since both maps are in normal form (see proof of proposition 2.1.30), they have the convenient property that $z_- = z_+$. The functions x_\pm and y_\pm define the rotation defined by the respective degree triples. Note that a matrix $H_\pm(p)$ is singular iff $x_\pm(p) = y_\pm(p) = z(p) = 0$. The functions x_-, y_- and z (resp. x_+, y_+ and z) do not simultaneously vanish, because the maps H_\pm are non-singular by assumption. Now we define the jump curve as:

$$H_t = \begin{pmatrix} x_t \\ y_t \\ z \end{pmatrix}$$

where

$$x_t = \begin{cases} |t|x_- & \text{for } t < 0 \\ 0 & \text{for } t = 0 \\ |t|x_+ & \text{for } t > 0 \end{cases} \quad \text{and} \quad y_t = \begin{cases} |t|y_- & \text{for } t < 0 \\ 0 & \text{for } t = 0 \\ |t|y_+ & \text{for } t > 0 \end{cases}$$

Then H_t defines a non-singular map for $t \neq 0$. The only points of degeneracy which were introduced by the t -scaling are those points in X where together with z also t vanishes. Since the maps H_\pm are in normal form, this means

$$S(H_0) = \{p \in X : z(p) = 0\} = C_0 \cup C_1,$$

which finishes the proof. □

For the construction of more interesting topological jumps we employ a new normal form for maps for triples (d_0, d, d_1) . This is described in the following definition

Definition 3.1.4 For triples $(d_0, \pm(d_0 - d_1), d_0)$ we define G -maps $F: X \rightarrow S^2 \subset \mathbb{R}^3$ in *modified normal form* as follows: Let D be the closed two-disk, $D = \{z \in \mathbb{C} : |z| \leq 1\}$ and let $\iota_D: (D, \partial D) \hookrightarrow (S^2, E)$ be the embedding (2.10 from p. 27 of D onto one of the hemispheres of S^2 . By Z we denote the fundamental region cylinder of the torus X . Now define the map

$$f: (Z, C) \rightarrow (D, \partial D)$$

$$(t, \varphi) \mapsto \begin{cases} (1 - 2t)e^{id_1\varphi} + 2t & \text{for } 0 \leq t \leq \frac{1}{2} \\ (2t - 1)e^{id_2\varphi} + 2(1 - t) & \text{for } \frac{1}{2} \leq t \leq 1 \end{cases}$$

and let $F: X \rightarrow S^2$ be the equivariant extension of the composition map $\iota_D \circ f$ (see lemma 2.1.8). The resulting map has the triple $(d_0, d_0 - d_1, d_1)$.

The fact that the map F constructed above has the triple $(d_0, d_0 - d_1, d_0)$ can be shown as in the proof for proposition 2.1.30 (ii). The crucial point of this modified normal form is that the fibers over the north- resp. south pole of the sphere contains only a finite number of points, precisely $|d_0| + |d_1|$ for each of the poles. In the original normal form the fibers over the poles were copies of S^1 in X (see figure 3.2).

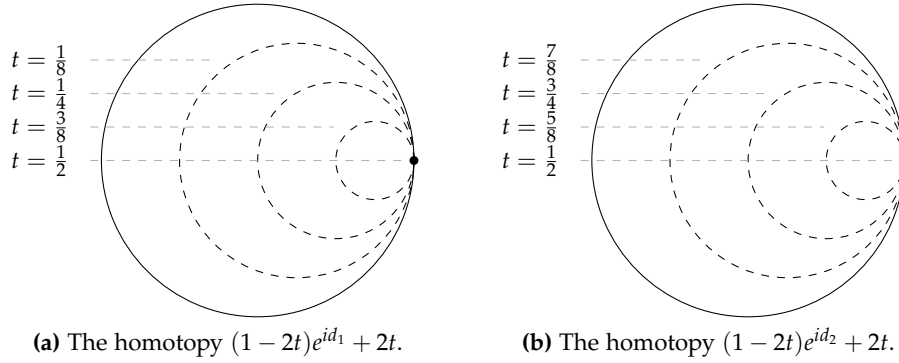

Figure 3.2. – Homotopy Visualization on the closed 2-Disk.

Now we construct a jump curve with only a discrete set of singular points. This jump curve “flips” the total degree of maps in modified normal form for basic triples.

Lemma 3.1.5 Let d_0 and d_1 be two integers and assume that the maps

$$H_{\pm}: (Z, C) \rightarrow (S^2, E) \subset (\mathbb{R}^3, \{z = 0\})$$

have the triples $(d_0, \pm(d_1 - d_0), d_1)$. Then there exists a jump curve

$$H: [-1, 1] \times (Z, C) \rightarrow (\mathbb{R}^3, \{z = 0\})$$

from H_- to H_+ such that the singular set of the equivariant extension of H_0 consists of $2(|d_0| + |d_1|)$ isolated points in $X \setminus (C_0 \cup C_1)$. If the maps are already normalized along the boundary circles C_0 and C_1 , then this homotopy H_t can be chosen to be relative to $C_0 \cup C_1$.

Proof. After a G -homotopy we can assume that the maps H_{\pm} are in modified normal form for the triples $(d_0, \pm(d_1 - d_0), d_1)$. This homotopy can be chosen to be relative to $C_0 \cup C_1$ if the original maps H_{\pm} are already type I normalized. It now suffices to prove the statement under the assumption that H_{\pm} are in modified normal form. We can regard H_{\pm} as maps

$$H_{\pm}: (Z, C) \rightarrow (\mathbb{R}^3, \{z = 0\})$$

$$p \mapsto \begin{pmatrix} x_{\pm}(p) \\ y_{\pm}(p) \\ z_{\pm}(p) \end{pmatrix}$$

where the functions x_{\pm} , y_{\pm} and z_{\pm} satisfy:

$$\begin{aligned}x_{\pm} \circ T &= x_{\pm} \\y_{\pm} \circ T &= y_{\pm} \\z_{\pm} \circ T &= -z_{\pm}.\end{aligned}$$

Note that the functions x_{-} , y_{-} and z_{-} (resp. x_{+} , y_{+} and z_{+}) do not simultaneously vanish. Also, since the maps in modified normal form for triples of the form $(d_0, \pm(d_1 - d_0), d_1)$ only differ by a reflection along the x, y -plane, we can conclude that $x_{-} = x_{+}$, $y_{-} = y_{+}$ and $z_{-} = -z_{+}$. We set $x = x_{\pm}$ and $y = y_{\pm}$ and define the jump curve H_t as follows:

$$\begin{aligned}H: [-1, 1] \times (Z, C) &\rightarrow (\mathbb{R}^3, \{z = 0\}) \\(t, p) &\mapsto \begin{pmatrix} x(p) \\ y(p) \\ z_t(p) \end{pmatrix}\end{aligned}$$

where

$$z_t(p) = \begin{cases} |t|z_{-}(p) & \text{for } t < 0 \\ 0 & \text{for } t = 0. \\ |t|z_{+}(p) & \text{for } t > 0 \end{cases}$$

As long as $t \neq 0$, the map H_t is non-singular. For $t = 0$, the singular set $S(H_0)$ consists of those points $p \in X$ which are mapped to the south resp. the north pole (this is the set $\{x = y = 0\}$). In the cylinder $Z \subset X$ we obtain $|d_0|$ singular points during the shrinking process of the degree d_0 loop and $|d_1|$ points during the enlarging process of the degree d_1 loop. By equivariant extension (lemma 2.1.8), the same applies to the complementary fundamental cylinder Z' , yielding a total number of $2(|d_0| + |d_1|)$ singular points in X . Equivariance of the curve is guaranteed because the equivariance conditions on the functions x_{\pm} , y_{\pm} and z are compatible with scaling by real numbers. \square

Given integers d_0 and d_1 , let

$$H^{(d_0, \pm(d_1 - d_0), d_1)}: [-1, 1] \times (Z, C) \rightarrow (\mathbb{R}^3, \{z = 0\}).$$

denote the jump curve from H_{-} to H_{+} (with $\mathcal{T}(H_{\pm}) = (d_0, \pm(d_1 - d_0), d_1)$) whose existence is guaranteed by lemma 3.1.5. In the following we consider jump curves, which modify the fixed point degrees. For the proof of the next lemma it is useful to introduce a new notation for maps $(Z, C) \rightarrow (S^2, E)$ having triples of the form $(d_0, d_0 - d_1, d_1)$. Let us recall how the normal form maps $(Z, C) \rightarrow (S^2, E)$ for such triples were constructed in the proof of proposition 2.1.30 (ii). The cylinder is to be

regarded as $I \times S^1$ where we use s as the interval coordinate. Denote the closed unit disk in \mathbb{C} by D . Let $\gamma_d: S^1 \rightarrow S^1$ be the normalized loop of degree d . Let ι_D be the embedding (2.10) of the disk D as one of the hemispheres in S^2 and let f be the following map:

$$f: [0, 1] \times S^1 \rightarrow D$$

$$(s, z) \mapsto \begin{cases} (1 - 2s)\gamma_{d_0}(z) & \text{for } 0 \leq t \leq \frac{1}{2} \\ (2s - 1)\gamma_{d_1}(z) & \text{for } \frac{1}{2} \leq t \leq 1 \end{cases}.$$

In particular, f_0 and f_1 both map S^1 to the boundary of D . Therefore, $\iota_D \circ f$ can be regarded as a map

$$(Z, C) \rightarrow (S^2, E) \subset (\mathbb{R}^3, \{z = 0\}).$$

We can then define a map for the above triple as the equivariant extension of the composition $\iota_D \circ f$ (see lemma 2.1.8):

$$F = \widehat{\iota_D \circ f}.$$

In other words, F is the equivariant extension of the map

$$I \times S^1 \rightarrow S^2 \tag{3.2}$$

$$(s, z) \mapsto \begin{cases} \begin{pmatrix} (1 - 2s)\operatorname{Re}(\gamma_{d_0}(z)) \\ (1 - 2s)\operatorname{Im}(\gamma_{d_0}(z)) \\ -2\sqrt{s - s^2} \end{pmatrix} & \text{for } s \in [0, \frac{1}{2}] \\ \begin{pmatrix} (1 - 2s)\operatorname{Re}(\gamma_{d_1}(z)) \\ (1 - 2s)\operatorname{Im}(\gamma_{d_1}(z)) \\ -2\sqrt{s - s^2} \end{pmatrix} & \text{for } s \in [\frac{1}{2}, 1] \end{cases}.$$

What this shows is that normal form maps for a triple $(d_0, \pm(d_0 - d_1), d_1)$ can be defined in terms of two loops $S^1 \rightarrow S^1$ which are of degree d_0 resp. of degree d_1 . This motivates the following

Definition 3.1.6 By $F_{\alpha, \beta}$ we denote the map $(Z, C) \rightarrow (S^2, E)$ which is defined in terms of the loops α and β as described above. In particular, $F_{\alpha, \beta}$ has the triple $(\deg \alpha, \deg \alpha - \deg \beta, \deg \beta)$.

Recall that for loops $\gamma_{d_0}, \dots, \gamma_{d_n}$ we can form the concatenation loop

$$\gamma_{d_n} * \dots * \gamma_{d_0}: S^1 \rightarrow S^1$$

$$z \mapsto \gamma_{d_j}(z_{n+1}), \text{ where } \arg z \in \left[\frac{2\pi j}{n+1}, \frac{2\pi(j+1)}{n+1} \right]$$

Lemma 3.1.7 Let d^\pm be two integers and $H_\pm: (Z, C) \rightarrow (S^2, E) \subset (\mathbb{R}^3, \{z = 0\})$ be maps with the degree triples

$$(d^\pm, d^\pm, 0) \text{ (resp. } (0, d^\pm, d^\pm)).$$

Then there exists a jump curve $H: [-1, 1] \times (Z, C) \rightarrow (\mathbb{R}^3, \{z = 0\})$ from H_- to H_+ such that the singular set $S(H_0)$ consists of $|d^+ - d^-|$ isolated points in C_0 (resp. in C_1). If the original maps H_\pm are already normalized along the boundary circle C_1 (resp. C_0), then H_t can be chosen relative to C_1 (resp. C_0).

Proof. We prove the statement only for the triples $(d^\pm, d^\pm, 0)$; the other case works completely analogously. After a G -homotopy we can assume that H_- is defined in terms of the loops $\gamma_k^{-1} * \gamma_k * \gamma_{d^-}$ and γ_0 :

$$H_- = F_{\gamma_k^{-1} * \gamma_k * \gamma_{d^-}, \gamma_0}. \quad (3.3)$$

After defining $k = d^+ - d^-$ and after another G -homotopy we can assume that H_+ is defined in terms of the loops $\gamma_0 * \gamma_k * \gamma_{d^-}$ and γ_0 :

$$H_+ = F_{\gamma_0 * \gamma_k * \gamma_{d^-}, \gamma_0}. \quad (3.4)$$

In order to prove the statement it suffices to construct a jump curve H_t from H_- to H_+ . We define the curve H_t as:

$$H_t = F_{\iota_t * \gamma_k * \gamma_{d^-}, \gamma_0},$$

where ι_t ("jump") is the following null-homotopy of the loop γ_k^{-1} :

$$\begin{aligned} \iota_t: [-1, 1] \times S^1 &\rightarrow \mathbb{C} \\ (t, z) &\mapsto \frac{(1-t)z^{-k} + t + 1}{2}. \end{aligned}$$

By construction we have $H_{\pm 1} = H_\pm$. Let us compute the singular set of H_t . From the definition of the map $F_{\alpha, \beta}$ in (3.2) we can conclude that the singular set consists of the common zeros of

$$\begin{aligned} (1 - 2s)\iota_t * \gamma_k * \gamma_{d^-}(z) \\ \text{and } -2\sqrt{s - s^2}. \end{aligned}$$

Since the square root only vanishes for $s \in \{0, 1\}$ and $(1 - 2s)$ does not vanish for these values of s , the only possibility for both functions to vanish is

$$s = 0 \text{ and } \iota_t * \gamma_k * \gamma_{d^-}(z) = 0.$$

By construction, ι_t crosses the origin once and that happens at $t = 0$. Therefore, H_t is only singular for $t = 0$ and the singular set consists of $|k| = |d^+ - d^-|$ points in $C_0 \subset Z$. \square

Note that this method also changes the total degree of the map. That is to be expected, since we have all the freedom possible for changing the fixed point degrees, but as we have seen earlier, not all combinations of fixed point degrees and total degree are allowed. The previous lemma also covers the special case $d^- = d^+$, in which there are no singular points introduced. For two integers d^\pm we denote the jump curve from H_- to H_+ (with $\mathcal{T}(H_\pm) = (d^\pm, d^\pm, 0)$ resp. $\mathcal{T}(H_\pm) = (0, d^\pm, d^\pm)$) whose existence is guaranteed by lemma 3.1.7 by

$$\begin{aligned} H^{(d^\pm, d^\pm, 0)} &: [-1, 1] \times (Z, C) \rightarrow (\mathbb{R}^3, \{z = 0\}) \\ \text{resp. } H^{(0, d^\pm, d^\pm)} &: [-1, 1] \times (Z, C) \rightarrow (\mathbb{R}^3, \{z = 0\}). \end{aligned}$$

Now we combine the results of lemma 3.1.5 and 3.1.7 into one theorem:

Theorem 3.1.8 Let the torus X be equipped with the type I involution and let $H_\pm: X \rightarrow S^2 \subset \mathbb{R}^3$ be two G -maps with triples $(d_0^\pm, d_1^\pm, d_1^\pm)$. Then there exists a jump curve $H: [-1, 1] \times X \rightarrow \mathbb{R}^3$ of G -maps from H_- to H_+ such that the singular set $S(H_0) \subset X$ consists of

$$|d_0^+ - d_0^-| + |d_1^+ - d_1^-| + d^+ - (d_0^+ + d_1^+) - [d^- - (d_0^- + d_1^-)]$$

isolated points.

If the original maps H_\pm are type I normalized along the boundary circles C_0 and C_1 and $d_0^- = d_0^+$ or $d_1^- = d_1^+$, then the curve H_t can be chosen such that it does not modify the maps on the respective boundary circles where they agree.

Proof. Assume we are given two maps $H_\pm: X \rightarrow S^2 \subset \mathbb{R}^3$ having the degree triples $(d_0^\pm, d_1^\pm, d_1^\pm)$. Define

$$k = \frac{d^+ - (d_0^+ + d_1^+) - [d^- - (d_0^- + d_1^-)]}{2}.$$

Since $d^\pm - (d_0^\pm + d_1^\pm) \equiv 0 \pmod{2}$, k is an integer. Note that we then have the identity

$$d^+ = d_0^+ + 2k + d^- - d_0^- - d_1^- + d_1^+. \quad (3.5)$$

The maps H_\pm are equivariantly homotopic (as non-singular maps $X \rightarrow S^2 \subset \mathbb{R}^3$) to maps H'_\pm which are assumed to be the concatenations of simpler maps, corresponding to the triple decomposition

$$\begin{aligned} (d_0^\pm, d_0^\pm, 0) &\bullet (0, k, k) \\ &\bullet (k, \pm k, 0) \\ &\bullet (0, d^- - (d_0^- + d_1^-), 0) \\ &\bullet (0, d_1^\pm, d_1^\pm). \end{aligned} \quad (3.6)$$

If the original maps H_{\pm} are already normalized along any of the fixed point circles and if they have the same degree there, then the homotopy to the maps described by the aforementioned triples can be chosen relatively to those boundary circles. After this reduction to the maps H'_{\pm} , it suffices to prove the existence of a jump curve from H'_- to H'_+ . The restrictions of the maps for the triple (3.6) to the cylinder Z are defined as the concatenation of five maps H^j , each defined on one fifth Z_j of the cylinder Z , $j = 0, \dots, 4$. We can assume that each map H^j is normalized on the boundary circles of its subcylinder Z_j . Note that H'_- and H'_+ agree on $Z_1 \cup Z_3$ and differ only on $Z_0 \cup Z_2 \cup Z_4$. This allows us to define a curve

$$H': [-1, 1] \times (Z, C) \rightarrow (\mathbb{R}^3, \{z = 0\})$$

$$(t, p) \mapsto \begin{cases} H^{(d_0^{\pm}, d_0^{\pm}, 0)}(t, p) & \text{if } p \in Z_0 \\ H'_-(t, p) & \text{if } p \in Z_1 \\ H^{(k, \pm k, 0)}(t, p) & \text{if } p \in Z_2 \\ H'_-(t, p) & \text{if } p \in Z_3 \\ H^{(0, d_1^{\pm}, d_1^{\pm})}(t, p) & \text{if } p \in Z_4 \end{cases}$$

Note that if $d_0^+ = d_0^-$ or $d_1^+ = d_1^-$, then this homotopy H_t is relative to the respective boundary circles on which the fixed point degrees agree. Equivariant extension of H' yields a G -map

$$\widehat{H}': [-1, 1] \times X \rightarrow \mathbb{R}^3$$

satisfying the desired properties (see lemma 2.1.8). By lemma 3.1.7 we obtain $|d_0^+ - d_0^-|$ singular points from $H^{(d_0^{\pm}, d_0^{\pm}, 0)}$, $|d_1^+ - d_1^-|$ singular points from $H^{(0, d_1^{\pm}, d_1^{\pm})}$. To this we have to add the singular set added by $H^{(k, \pm k, 0)}$, which (by lemma 3.1.5) and by (3.5) consists of

$$2k = d^+ - (d_0^+ + d_1^+) - [d^- - (d_0^- + d_1^-)]$$

points. In total these are

$$|d_0^+ - d_0^-| + |d_1^+ - d_1^-| + d^+ - (d_0^+ + d_1^+) - [d^- - (d_0^- + d_1^-)]$$

singular points on the torus. □

The following corollary is a reformulation of theorem 3.1.9 using the isomorphism $\mathbb{R}^3 \cong \text{isu}_2$:

Corollary 3.1.9 Let the torus X be equipped with the type I involution and let

$$H_{\pm}: X \rightarrow \text{isu}_2 \setminus \{0\} \subset \mathcal{H}_{(1,1)}$$

be two G -maps with the triples $(d_0^\pm, d^\pm, d_1^\pm)$. Then there exists a jump curve

$$H: [-1, 1] \times X \rightarrow \text{isu}_2 \subset \mathcal{H}_{(1,1)}$$

from H_- to H_+ such that the singular set $S(H_0) \subset X$ consists of

$$|d_0^+ - d_0^-| + |d_1^+ - d_1^-| + d^+ - (d_0^+ + d_1^+) - [d^- - (d_0^- + d_1^-)]$$

isolated points.

3.1.2. Type II

As in the classification chapter, it is possible to deduce results for the type II involution from the respective results of the type I involution. Let (X, T) be the torus equipped with the type II involution and (X', T') be the torus equipped with the type I involution. As an immediate corollary to theorem 3.1.8 note:

Corollary 3.1.10 Let $H_\pm: X' \rightarrow S^2 \subset \mathbb{R}^3$ be two G -maps with triples $(0, d^\pm, d_1^\pm)$. Then there exists a jump curve $H: [-1, 1] \times X' \rightarrow \mathbb{R}^3$ from H_- to H_+ such that the singular set $S(H_0) \subset X'$ consists of

$$|d_1^+ - d_1^-| + d^+ - d^- + d_1^- - d_1^+$$

isolated points. In particular, if the maps H_- and H_+ are normalized along the boundary circle C_0 (meaning that $H_\pm(C_0) = \{p_0\} \in E \subset S^2$), then the curve H_t can be chosen such that $H_t(C_0) = \{p_0\}$ for all t .

Proof. This is just the special case $d_0^\pm = 0$ of theorem 3.1.8. □

For reducing jump curves for the type II involution to jump curves for the type I involution, recall the equivariant and orientation preserving diffeomorphism

$$\Psi: X' \setminus C_0 \xrightarrow{\sim} S^2 \setminus \{O_\pm\}.$$

from remark 2.1.43 which we have used for identifying type I normalized G -maps $X' \rightarrow S^2$ with type II normalized G -maps $S^2 \rightarrow S^2$. We can use the same method for jump curves:

Proposition 3.1.11 Let H_\pm be two type II normalized G -maps $S^2 \rightarrow S^2 \subset \mathbb{R}^3$ with degree pairs (d^\pm, d_E^\pm) . Then there exists a jump curve $H: [-1, 1] \times S^2 \rightarrow \mathbb{R}^3$ from H_- to H_+ such that the singular set $S(H_0)$ consists of

$$|d_E^+ - d_E^-| + d^+ - d^- + d_E^- - d_E^+$$

isolated points in X .

Proof. By lemma 2.1.48, the maps H_{\pm} induce type I normalized equivariant maps $H'_{\pm}: X' \rightarrow S^2 \subset \mathbb{R}^3$ with the degree triples $(0, d^{\pm}, d_E^{\pm})$ such that

$$H'_{\pm}|_{X' \setminus C_0} = H_{\pm}|_{S^2 \setminus \{O_{\pm}\}} \circ \Psi.$$

Using corollary 3.1.10 we obtain a jump curve $H': [-1, 1] \times X' \rightarrow \mathbb{R}^3$ from H'_- to H'_+ such that the singular set $S(H'_0)$ consists of

$$|d_E^+ - d_E^-| + d^+ - d^- + d_E^- - d_E^+ \quad (3.7)$$

points. In particular this curve has the property that $H'_t(C_0) = \{p_0\}$ for all times t . The last property allows us to define the curve

$$H: [-1, 1] \times S^2 \rightarrow \mathbb{R}^3$$

$$(t, p) \mapsto \begin{cases} H'(t, \Psi^{-1}(p)) & \text{if } p \notin \{O_{\pm}\} \\ p_0 & \text{if } p \in \{O_{\pm}\} \end{cases}$$

Since H'_t is non-singular for $t \neq 0$, the same applies to H . By construction H_t is a jump curve from H_- to H_+ . The diffeomorphism Ψ maps the singular set $S(H'_0)$ onto the singular set $S(H_0)$, thus the number of singular points of $S(H_0)$ is also given by (3.7). This finishes the proof. \square

Now we can deduce the following result for type II jump curves:

Theorem 3.1.12 Let X be the torus equipped with the type II involution and let H_{\pm} be two G -maps $X \rightarrow S^2 \subset \mathbb{R}^3$ with degree pairs (d^{\pm}, d_C^{\pm}) . Then there exists a jump curve $H: [-1, 1] \times X \rightarrow \mathbb{R}^3$ from H_- to H_+ such that the singular set $S(H_0)$ consists of

$$|d_C^+ - d_C^-| + d^+ - d^- + d_C^- - d_C^+$$

isolated points in X .

Proof. After a G -homotopy we can assume that both maps H_{\pm} are type II normalized. Therefore they push down to maps H'_{\pm} on the quotient X/A , which can be equivariantly identified with S^2 . Thus H'_{\pm} can be regarded as type II normalized maps $S^2 \rightarrow S^2$ and we have the identity $H_{\pm} = H'_{\pm} \circ \pi_{S^2}$. By remark 2.1.46 the degree pairs of the maps H'_{\pm} are the same as those of the original maps H_{\pm} . Now proposition 3.1.11 guarantees the existence of a jump curve $H': I \times S^2 \rightarrow \mathbb{R}^3$ from H'_- to H'_+ with

$$|d_C^+ - d_C^-| + d^+ - d^- + d_C^- - d_C^+$$

singular points on S^2 . Then the composition $H'_t \circ \pi_{S^2}$ defines a jump curve from H_- to H_+ with the same number of singular points. \square

As in the case of the type I involution we use the isomorphism $\mathbb{R}^3 \cong \mathfrak{isu}_2$ to note the following reformulation:

Corollary 3.1.13 Let X be the torus equipped with the type II involution and let H_{\pm} be two G -maps $X \rightarrow \mathfrak{isu}_2 \subset \mathcal{H}_{(1,1)}$ with degree pairs (d^{\pm}, d_C^{\pm}) . Then there exists a jump curve

$$H: [-1, 1] \times X \rightarrow \mathfrak{isu}_2 \subset \mathcal{H}_{(1,1)}$$

from H_- to H_+ such that the singular set $S(H_0)$ consists of

$$|d_C^+ - d_C^-| + d^+ - d^- + d_C^- - d_C^+$$

isolated points in X .

3.2. Maps into $\text{cl}(\mathcal{H}_n)$

In this section we assume $n > 2$. Recall that $\mathcal{H}_{(p,q)}$ contains the orbit $U(n) \cdot \mathbb{E}_{p,q}$ as an equivariant strong deformation retract. This orbit can be equivariantly identified with the Grassmann manifold $\text{Gr}_p(\mathbb{C}^n)$. In order to employ the method described in the previous section in the higher dimensional setting, we embed the space \mathfrak{isu}_2 into $\text{cl}(\mathcal{H}_{(p,q)})$ such that $\mathfrak{isu}_2 \setminus \{0\} \subset U(n) \cdot \mathbb{E}_{p,q}$ and the origin in \mathfrak{isu}_2 defines a singular matrix in the boundary of this orbit. As we have seen earlier, the topology on the mapping space is only non-trivial in the case of a mixed-signature. Thus we can assume that $0 < p, q < n$. The space \mathfrak{isu}_2 can be equivariantly embedded into $\text{cl}(\mathcal{H}_{(p,q)})$ as an affine subspace via

$$\begin{aligned} \iota: \mathfrak{isu}_2 &\hookrightarrow \text{cl}(\mathcal{H}_{(p,q)}) & (3.8) \\ \zeta &\mapsto \begin{pmatrix} \mathbb{E}_{p-1} & 0 & 0 \\ 0 & \zeta & 0 \\ 0 & 0 & -\mathbb{E}_{q-1} \end{pmatrix} \end{aligned}$$

Similarly, the group $U(2)$ can be embedded into $U(n)$ via

$$\begin{aligned} U(2) &\hookrightarrow U(n) \\ U &\mapsto \begin{pmatrix} \mathbb{E}_{p-1} & 0 & 0 \\ 0 & U & 0 \\ 0 & 0 & -\mathbb{E}_{q-1} \end{pmatrix}. \end{aligned}$$

Since $U(n)$ acts on $\mathcal{H}_{(p,q)}$ via conjugation, so does $U(2)$, by regarding each element of $U(2)$ as being embedded in $U(n)$. The $U(2)$ -orbit of $\mathbb{E}_{p,q}$ is the same as $\iota(U(2) \cdot \mathbb{E}_{1,1})$. It is contained as a subspace in the orbit $U(n) \cdot \mathbb{E}_{p,q}$ and corresponds – under the isomorphism $\text{Gr}_p(\mathbb{C}^n) \cong U(n) \cdot \mathbb{E}_{p,q}$ – to the Schubert variety $\mathcal{S} \cong \mathbb{P}_1$ (see the remarks about the Schubert variety \mathcal{S} on p. 48). This follows from the fact that $U(2)$ acts transitively on

$$\mathcal{S} = \left\{ E \in \text{Gr}_p(\mathbb{C}^n) : \mathbb{C}^{p-1} \subset E \subset \mathbb{C}^{p+1} \right\}.$$

Under the above embedding $isu_2 \hookrightarrow \text{cl}(\mathcal{H}_{(p,q)})$, the origin of isu_2 corresponds to a singular matrix, which is contained in the boundary $\partial\mathcal{H}_{(p,q)}$.

Since $\mathcal{H}_{(p,q)}$ has $\text{Gr}_p(\mathbb{C}^n)$ as equivariant deformation retract, these two spaces and also their real parts have the same fundamental group:

$$\pi_1\left(\left(\mathcal{H}_{(p,q)}\right)_{\mathbb{R}}\right) \cong \pi_1\left(\left(\text{Gr}_p(\mathbb{C}^n)\right)_{\mathbb{R}}\right) \cong C_2.$$

We write C_2 additively as the group \mathbb{Z}_2 and identify elements of $\pi_1\left(\left(\mathcal{H}_{(p,q)}\right)_{\mathbb{R}}\right)$ with \mathbb{Z}_2 . Thus we can regard the restrictions of maps $X \rightarrow \mathcal{H}_{(p,q)}$ to the boundary circle(s) in X as defining an element in $\pi_1\left(\left(\mathcal{H}_{(p,q)}\right)_{\mathbb{R}}\right) \cong \{0, 1\}$.

Theorem 3.2.1 Assume $n = p + q > 2$. Let X be the torus equipped with the type I (resp. type II) involution and let H_{\pm} be two G -maps $X \rightarrow \mathcal{H}_{(p,q)}$ with the degree triples $(m_0^{\pm}, d^{\pm}, m_1^{\pm})$ resp. the degree pairs (d^{\pm}, m_C^{\pm}) . Then there exists a jump curve

$$H: [-1, 1] \times X \rightarrow \text{cl}(\mathcal{H}_{(p,q)})$$

from H_- to H_+ such that the singular set $S(H_0)$ consists of

$$\begin{aligned} & |m_0^+ - m_0^-| + |m_1^+ - m_1^-| + d^+ - (m_0^+ + m_1^+) - [d^- - (m_0^- + m_1^-)] \\ \text{resp. } & |m_C^+ - m_C^-| + d^+ - d^- + m_C^- - m_C^+ \end{aligned}$$

isolated points.

Proof. Let H_{\pm} be G -maps $X \rightarrow \mathcal{H}_{(p,q)}$ with degree triples $(m_0^{\pm}, d^{\pm}, m_1^{\pm})$ resp. degree pairs (d^{\pm}, m_C^{\pm}) . By applying proposition 2.2.36 we can assume that the maps H_{\pm} have their images contained in the Schubert variety $\mathcal{S} \subset \text{Gr}_p(\mathbb{C}^n)$. The Schubert variety is the $U(2)$ -orbit of $\mathbb{E}_{p,q}$, which is $\iota(U(2).\mathbb{E}_{1,1})$. That is, it is contained in the image of the embedding

$$\iota: isu_2 \hookrightarrow \text{cl}(\mathcal{H}_{(p,q)}) \tag{3.9}$$

from (3.8). This means that we can assume that the maps H_{\pm} are of the form

$$H_{\pm} = \iota \circ H'_{\pm}: X \rightarrow \text{cl}(\mathcal{H}_{(p,q)})$$

where the H'_{\pm} are G -maps

$$H'_{\pm}: X \rightarrow U(2).\mathbb{E}_{1,1} \subset isu_2$$

By construction, their degree triples resp. their degree pairs of H'_{\pm} agree with those of H_{\pm} . Now corollary 3.1.9 (type I) resp. corollary 3.1.13 (type II) implies the existence of a jump curve

$$H': [-1, 1] \times X \rightarrow isu_2$$

from H'_- to H'_+ such that the singular set $S(H_0)$ consists of

$$\begin{aligned} & |m_0^+ - m_0^-| + |m_1^+ - m_1^-| + d^+ - (m_0^+ + m_1^+) - [d^- - (m_0^- + m_1^-)] \\ \text{resp. } & |m_C^+ - m_C^-| + d^+ - d^- + m_C^- - m_C^+ \end{aligned} \quad (3.10)$$

isolated points in X . Composing H'_t with ι yields a jump curve

$$H = \iota \circ H': X \rightarrow \text{cl}(\mathcal{H}_{(p,q)})$$

from H_- to H_+ whose number of isolated points is the same as that of H'_t , namely that given in (3.10). \square

3.3. An Example from Physics

In this section we present an example jump curve coming from physics (see e. g. [2, p. 11]). For this we regard the torus X as \mathbb{R}^2/Λ , where

$$\Lambda = \left\langle \begin{pmatrix} 2\pi \\ 0 \end{pmatrix}, \begin{pmatrix} 0 \\ 2\pi \end{pmatrix} \right\rangle_{\mathbb{Z}}.$$

The orientation on X is the orientation inherited from \mathbb{R}^2 . Employing physics notation for the coordinates on the torus phase space, we define the jump curve as

$$H_t(q, p) = \begin{pmatrix} t - \cos q - \cos p & \sin q - i \sin p \\ \sin q + i \sin p & -(t - \cos q - \cos p) \end{pmatrix}. \quad (3.11)$$

Each map H_t is equivariant with respect to the type I involution. This curve differs from the jump curves we have constructed earlier in that it depends on a continuous parameter $t \in \mathbb{R}$ with multiple jumps taking place as t varies. These occur precisely at $t = -2$, $t = 0$ and at $t = 2$. The associated curve of scaled maps into $S^2 \subset \mathbb{R}^3$ is

$$\tilde{H}_t(q, p) = c_t(q, p) \begin{pmatrix} t - \cos q - \cos p \\ \sin q \\ -\sin p \end{pmatrix},$$

where

$$c_t(q, p) = \frac{1}{\sqrt{(t - \cos q \cos p)^2 + (\sin q)^2 + (\sin p)^2}}.$$

In the following we compute the degree triples $\mathcal{T}(H_t)$. For this it is convenient to decompose \tilde{H}_t as

$$\tilde{H}_t(q, p) = c_t(q, p) \left[\begin{pmatrix} t - \cos p \\ 0 \\ -\sin p \end{pmatrix} + \begin{pmatrix} -\cos q \\ \sin q \\ 0 \end{pmatrix} \right].$$

Now we can regard \tilde{H}_t as a family of circles in the x, y -plane whose centers in \mathbb{R}^3 varies with t and p . It follows that \tilde{H}_t is not surjective (as a map to S^2) for $|t| \in (2, \infty)$, therefore we have $\deg \tilde{H}_t = 0$ for these t . Furthermore, when t is in a neighborhood of the origin and transitions from a negative real number to a positive real number, then the total degree of \tilde{H}_t flips its sign. Hence it suffices to compute the total degree of e. g. \tilde{H}_1 . This can be done by counting preimage points, for example in the fiber $\tilde{H}_1^{-1}(y_0)$ where $y_0 = (0, 1, 0)$. A computation shows that the y_0 -fiber consists only of the point $(q_0, p_0) = (\frac{1}{2}\pi, 0)$. Using the orientation of S^2 induced by an outer normal vector field one can find that the orientation sign of the map \tilde{H}_1 at (q_0, p_0) is positive. This then implies that $\deg \tilde{H}_t = 1$ for $t \in (0, 2)$ and $\deg \tilde{H}_t = -1$ for $t \in (-2, 0)$.

Regarding the fixed point degrees: For $p = 0$ resp. $p = \pi$ the map $\tilde{H}_t(p, \cdot)$ can be written as

$$q \mapsto c_t(q, 0) \left[\begin{pmatrix} t-1 \\ 0 \\ 0 \end{pmatrix} + \begin{pmatrix} -\cos q \\ \sin q \\ 0 \end{pmatrix} \right] \quad (3.12)$$

$$\text{resp. } q \mapsto c_t(q, \pi) \left[\begin{pmatrix} t+1 \\ 0 \\ 0 \end{pmatrix} + \begin{pmatrix} -\cos q \\ \sin q \\ 0 \end{pmatrix} \right]$$

Using the orientation on the equator $E \subset S^2$ as defined on p. 13 it follows that the fixed point degree for $p = 0$ is 0 for $t \in \mathbb{R} \setminus [0, 2]$, and -1 for $t \in (0, 2)$. The fixed point degree for $p = \pi$ is 0 for $t \in \mathbb{R} \setminus [-2, 0]$ and -1 for $t \in (-2, 0)$. To summarize the above:

Remark 3.3.1 The following table lists the degree triples for H_t depending on t , where t is assumed to be in one of the t -intervals such that H_t is non-singular:

t -interval	degree triple $\mathcal{T}(H_t)$
$(-\infty, -2)$	$(0, 0, 0)$
$(-2, 0)$	$(0, -1, -1)$
$(0, 2)$	$(-1, 1, 0)$
$(2, \infty)$	$(0, 0, 0)$

Now we consider a generalization of the above map H_t . We define

$$H_t^m(q, p) = c_t(q, mp) \begin{pmatrix} t - \cos q - \cos(mp) & \sin q - i \sin(mp) \\ \sin q + i \sin(mp) & -(t - \cos q - \cos(mp)) \end{pmatrix}, \quad (3.13)$$

with m a positive integer. The maps H_t^m are still type I equivariant. They can be expressed as the composition $H_t \circ p_m(q, p)$, where p_m is the following $m : 1$ -cover of X :

$$p_m: X \rightarrow X$$

$$(q, p) \mapsto (q, mp).$$

In particular, p_m has degree m , which implies that $\deg H_t^m = m \deg H_t$. Let us now compute the fixed point degrees of H_t^m . These depend on the parity of m . If m is even, then the 2π -periodicity of the trigonometric functions implies that the fixed point degrees for $p = 0$ and $p = \pi$ must be the same. They are given by the map (3.12). Therefore, the fixed point degrees for even m must be $(0, 0)$ for $t \in \mathbb{R} \setminus [0, 2]$ and $(-1, -1)$ otherwise. The periodicity of the trigonometric functions implies that fixed point degrees for odd m are the same as those for $m = 1$. We obtain the following result:

Remark 3.3.2 The following table lists the degree triples for H_t^m for even m varying with t such that H_t^m is non-singular:

t -interval	degree triple $\mathcal{T}(H_t^m)$
$(-\infty, -2)$	$(0, 0, 0)$
$(-2, 0)$	$(0, -m, 0)$
$(0, 2)$	$(-1, m, -1)$
$(2, \infty)$	$(0, 0, 0)$

In particular, this example shows how the degree triples vary with t in such a way that the condition $d \equiv d_0 + d_1 \pmod{2}$ is always satisfied.

A. Appendix

This chapter lists some standard material, which is included for the convenience of the reader.

A.1. Topology

Taken from [9]:

Proposition A.1.1 (Homotopy Extension Property) Let X be a CW complex and $A \subset X$ a CW subcomplex. Then the CW pair (X, A) has the homotopy extension property (HEP) for all spaces.

Proof. See [9, p. 15]. □

Lemma A.1.2 Let X be a topological space and $f, g: I \rightarrow X$ be two curves in X with $f(0) = g(0) = p$ and $f(1) = g(1) = q$. Then $g^{-1} * f$ is null-homotopic if and only if f and g are homotopic (with fixed endpoints).

Proof. The one direction is trivial: When f and g are homotopic, then we can define a null-homotopy $H: I \times I \rightarrow X$ as follows: During $0 \leq t \leq \frac{1}{2}$ use a homotopy from f to g to build a homotopy from $g^{-1} * f$ to $g^{-1} * g$. Then, during $\frac{1}{2} \leq t \leq 1$ we shrink $g^{-1} * g$ the constant curve at p .

Now assume that we are given a homotopy from $\gamma_1^{-1} * \gamma_0$ to the constant curve at p . This is a map $H: I \times I \rightarrow X$. On the left, top and right boundary of the square I the map H takes on the value p , on the bottom boundary, i.e. H_0 , this is the curve $\gamma_1^{-1} * \gamma_0$. We use this map to construct a new map $\gamma: I \times I \rightarrow X$ which is a homotopy from γ_0 to γ_1 as follows:

We define $\gamma_t: I \rightarrow X$ to be the map $I \xrightarrow{\iota_t} I \times I \xrightarrow{H} X$ where the embedding ι_t is defined as follows:

$$\iota_t: I \rightarrow I \times I$$

$$s \mapsto \frac{1}{\max\{|\cos \pi(1-t)|, |\sin \pi(1-t)|\}} \begin{pmatrix} \frac{\cos \pi(1-t)}{2} \\ i \sin \pi(1-t) \end{pmatrix} + \begin{pmatrix} 1 \\ 2 \end{pmatrix}$$

With this definition, ι_0 is the embedding $s \mapsto \frac{1}{2}(1-s)$ and ι_1 is the embedding $s \mapsto \frac{1}{2}(1+s)$. Hence, γ_t is indeed a homotopy from γ_0 to γ_1 . Furthermore, the construction makes sure that for every t , $\iota_t(0) = \frac{1}{2}$ and $\iota_t(1)$ is always contained in the left, top or

right boundary of $I \times I$. This translates to the fact that $\gamma_t(0) = p$ and $\gamma_t(1) = q$ for all t . \square

Theorem A.1.3 (Taken from John Lee, Whitney Approximation Theorem) Suppose N is a smooth manifold with or without boundary, M is a smooth manifold (without boundary), and $F: N \rightarrow M$ is a continuous map. Then F is homotopic to a smooth map. If F is already smooth on a closed subset $A \subseteq N$, then the homotopy can be taken to be relative to A .

Proof. See [12, p. 141]. \square

Here is a theorem by Whitney, taken from [12]:

Theorem A.1.4 Let N and M be smooth manifolds and let $F: N \rightarrow M$ be a map. Then F is homotopic to a smooth map $\tilde{F}: N \rightarrow M$. If F is smooth on a closed subset $A \subset N$, then the homotopy can be taken to be relative to A .

Proof. See [12, p. 142] \square

The following two statements can be found in [3]:

Theorem A.1.5 Let G be a compact Lie group acting smoothly on the manifolds M and N . Let $\varphi: M \rightarrow N$ be an equivariant map. Then φ can be approximated by a smooth equivariant map $\psi: M \rightarrow N$ which is equivariantly homotopic to φ by a homotopy approximating the constant homotopy. Moreover, if φ is already smooth on the closed invariant set $A \subset M$, then ψ can be chosen to coincide with φ on A , and the homotopy between φ and ψ to be constant there.

Proof. See [3, p. 317]. \square

Corollary A.1.6 Let G, M, N be as in [the previous theorem]. Then any equivariant map $M \rightarrow N$ is equivariantly homotopic to a smooth equivariant map. Moreover, if two smooth equivariant maps $M \rightarrow N$ are equivariantly homotopic, then they are so by a smooth equivariant homotopy.

Proof. [3, p. 317]. \square

The following theorem is taken (and translated) from [18]:

Theorem A.1.7 Let $f: X \rightarrow Y$ be a continuous map, which is compatible with given equivalence relations R resp. S on X resp. Y (which means: $x \sim_R x'$ implies $f(x) \sim_S f(x')$). Then $f'([x]_R) = [f(x)]_S$ ¹ defines a continuous map $f': X/R \rightarrow Y/S$; it is called the map induced by f . If f is a homeomorphism and f^{-1} is also compatible with the relations R resp. S , then the induced map f' is also a homeomorphism.

¹Here $[x]_R$ denotes the equivalence class of x under the relation R (likewise for y and S).

Proof. See [18, p. 9]. □

The same applies to the following

Theorem A.1.8 Let (X, A) be a CW pair and $A \neq \emptyset$, then X/A is a CW complex with the zero cell $[A] \in X/A$ and the cells of the form $p(e)$, where $p: X \rightarrow X/A$ denotes the identifying map and e is a cell in $X \setminus A$.

Proof. See [18, p. 93]. □

Taken from [13]:

Theorem A.1.9 (G-HELP) Let A be a subcomplex of a G -CW complex X of dimension ν and let $e: Y \rightarrow Y$ be a ν -equivalence. Suppose given maps $g: A \rightarrow Y$, $h: A \times I \rightarrow Z$, and $f: X \rightarrow Z$ such that $e \circ g = h \circ i_1$ and $f \circ i = h \circ i_0$ in the following diagram:

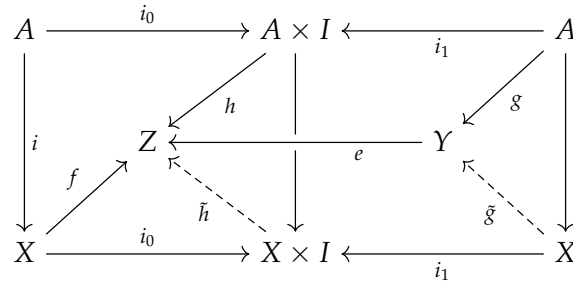

Then there exist maps \tilde{g} and \tilde{h} that make the diagram commute.

Proof. See [13, p. 17]. □

From this we can deduce a statement about equivariant homotopy extensions for G -CW complexes:

Corollary A.1.10 (Equivariant HEP) Let G be a topological group. Let X and Y be G -CW complexes and A a G -CW subcomplex of X . Then the G -CW pair (X, A) has the equivariant homotopy extension property. That is, given a G -map $f: X \rightarrow Y$ and a G -homotopy $h: I \times A \rightarrow Y$. Then h extends to a homotopy $H: I \times X \rightarrow Y$ such that $H_0 \equiv f$ and $H|_{I \times A} \equiv h$.

Proof. Set $Z = Y$ and let $f: Y \rightarrow Z$ be the identity. In particular this makes f be a ν -equivalence where we set $\nu(H) = \dim(X)$ for all subgroups $H \subset G$. Then, the equivariant homotopy extension property follows from the LHS square of the diagram (A.1.9). □

Remark A.1.11 Let M be an n -dimensional, connected, closed, oriented CW manifold and $A \subset M$ such that

- (i) A is contained in the $n - 1$ skeleton M^{n-1} and
- (ii) M/A is topologically an n -dimensional, connected, closed, orientable manifold.

Then the quotient M/A can be equipped with an orientation such that the projection map $M \rightarrow M/A$ has degree $+1$.

Proof. The manifold M is assumed to be oriented, which corresponds to a choice of fundamental class $[M]$ in $H_n(M, \mathbb{Z}) \cong \mathbb{Z}$. Denote the quotient map with

$$\pi: M \rightarrow M/A.$$

Since A is contained in M^{n-1} , π maps the n -cells in M homeomorphically to the n -cells in the quotient M/A . It follows that there exists an n -ball in one of the n -cells in M/A such that $\pi^{-1}(B)$ is a single n -ball in M which gets mapped homeomorphically to B . Fix a fundamental class $[M/A]$ of $H_n(M/A, \mathbb{Z})$. Using exercise 8 from [9, p. 258] we can conclude that the degree of π is ± 1 , depending on whether it is orientation preserving or orientation reversing. In case it is orientation reversing we can choose the opposite orientation on M/A such that $\deg \pi = +1$. \square

A direct consequence of the previous remark is:

Remark A.1.12 Let M and N be n -dimensional, connected, closed, oriented manifolds and $f: M \rightarrow N$ a map of degree d . Furthermore, assume that f is constant on $A \subset M$ such that it induces a map $f': M/A \rightarrow N$. If the pair (M, A) satisfies the assumptions of remark A.1.11, then f' also has degree d .

Proof. Denote the quotient map with $\pi: M \rightarrow M/A$. We then have the following commutative diagram:

$$\begin{array}{ccc} M & & \\ \pi \downarrow & \searrow f & \\ M/A & \xrightarrow{f'} & N \end{array}$$

In homology we obtain:

$$\begin{array}{ccc} H_n(M, \mathbb{Z}) & & \\ \pi_* \downarrow & \searrow f_* & \\ H_n(M/A, \mathbb{Z}) & \xrightarrow{f'_*} & H_n(N, \mathbb{Z}) \end{array}$$

By remark A.1.11 the quotient M/A can be equipped with an orientation such that, after identifying all homology groups with \mathbb{Z} , π_* is multiplication by $+1$ and f'_* is

multiplication by d' . Thus we have:

$$\begin{array}{ccc} \mathbb{Z} & & \\ \cdot +1 \downarrow & \searrow \cdot d & \\ \mathbb{Z} & \xrightarrow{\cdot d'} & \mathbb{Z} \end{array}$$

By commutativity of the diagram it follows that the degree of f' is $d = d'$. \square

Proposition A.1.13 Assume $0 < p < n$. Then:

- (i) The second homology group $H_2(\text{Gr}_p(\mathbb{C}^n), \mathbb{Z})$ is infinite cyclic for all p and n . Fixing a full flag of \mathbb{C}^n induces a decomposition of $\text{Gr}_p(\mathbb{C}^n)$ into Schubert cells. With respect to a fixed flag there exists a unique (complex) 1-dimensional Schubert variety, which can be regarded as the generator of $H_2(\text{Gr}_p(\mathbb{C}^n), \mathbb{Z})$.
- (ii) The fundamental group $\pi_1(\text{Gr}_p(\mathbb{R}^n))$ is cyclic of order two unless $p = 1$ and $n = 2$, in which case it is infinite cyclic.

\square

A.2. Hausdorff Dimension

For completeness we quote a theorem taken from [15, p. 515]:

Theorem A.2.1 Hausdorff dimension has the following properties:

- (1) if $X \subset Y$, then $\dim_H X \leq \dim_H Y$;
- (2) if X_i is a countable collection of sets with $\dim_H X_i \leq d$, then

$$\dim_H \bigcup_i X_i \leq d$$

- (3) if X is countable, then $\dim_H X = 0$;
- (4) if $X \subset \mathbb{R}^d$, then $\dim_H X \leq d$;
- (5) if $f: X \rightarrow f(X)$ is a Lipschitz map, then $\dim_H(f(X)) \leq \dim_H(X)$.
- (6) if $\dim_H X = d$ and $\dim_H Y = d'$, then $\dim_H(X \times Y) \geq d + d'$;
- (7) if X is connected and contains more than one point, then $\dim_H X \geq 1$; more generally, the Hausdorff dimension of any set is no smaller than its topological dimension;

(8) if a subset X of \mathbb{R}^n has finite positive d -dimensional Lebesgue measure, then

$$\dim_H X = d.$$

Although the Hausdorff dimension is not invariant under homeomorphisms, it is invariant under diffeomorphisms:

Corollary A.2.2 If $f: X \rightarrow Y$ is a diffeomorphism (between metric spaces), then $\dim_H X = \dim_H Y$.

Proof. Let $f: X \rightarrow Y$ be a diffeomorphism. In particular, f and f^{-1} are both Lipschitz continuous. Thus, by theorem A.2.1 (5) we obtain

$$\begin{aligned} \dim_H(Y) &= \dim_H(f(X)) \leq \dim_H(X) \\ \text{and } \dim_H(X) &= \dim_H(f^{-1}(Y)) \leq \dim_H Y \end{aligned}$$

and the statement follows. □

Corollary A.2.3 If X is the finite union of sets X_i , then

$$\dim_H X = \max_i \dim_H X_i.$$

Proof. Each X_i is contained in X , hence by theorem A.2.1 (1) we obtain

$$\dim_H X_i \leq \dim_H X \text{ for all } i.$$

In other words:

$$\max_i \dim_H X_i \leq \dim_H X$$

On the other hand, noting the trivial fact

$$\dim_H X_i \leq \max_i \dim_H X_i$$

and using (2) of the same theorem we can conclude

$$\dim_H X = \dim_H \left(\bigcup_i X_i \right) \leq \max_i (\dim_H X_i).$$

Thus we get the desired equation:

$$\dim_H X = \max_i (\dim_H X_i).$$

□

Proposition A.2.4 For sets $A, B \subset \mathbb{R}^n$ we have

$$\dim_H(A) + \dim_H(B) \leq \dim_H(A \times B) \leq \dim_H(A) + \dim_P(B)$$

Proof. See [20, p. 1]. □

For a submanifold $B \subset \mathbb{R}^n$ the packing dimension $\dim_P(B)$, the Hausdorff dimension $\dim_H(B)$ and the usual manifold dimension $\dim(B)$ agree². Thus we obtain for submanifolds $A, B \subset \mathbb{R}^n$:

$$\dim_H(A \times B) = \dim_H(A) + \dim(B). \tag{A.1}$$

This allows us to prove the following:

Corollary A.2.5 Let $E \xrightarrow{\pi} X$ be a fiber bundle over the smooth manifold X where E is a smooth submanifold of \mathbb{R}^N such that the fiber F is also a smooth manifold. Let A be a subset in X . Then $\dim_H(\pi^{-1}(A)) = \dim_H(A) + \dim(F)$.

Proof. The statement follows by using using a trivializing covering of X together with corollary A.2.2, corollary A.2.3 and (A.1). □

²See e. g. [6, p. 48]

Notation

\emptyset	The empty set
I	The closed unit interval $[0, 1]$
$\widehat{\mathbb{R}}$	Compactified real line, $\widehat{\mathbb{R}} = \mathbb{R} \cup \{\infty\}$
$\langle \omega_1, \omega_2 \rangle_{\mathbb{Z}}$	The lattice in \mathbb{C} generated by ω_1 and ω_2
C_n	The cyclic group of order n
$\mathcal{M}(X, Y)$	The space of maps $X \rightarrow Y$
$\mathcal{M}((X, A), (Y, B))$	The space of maps $(X, A) \rightarrow (Y, B)$
$\mathcal{M}_G(X, Y)$	The space of continuous G -maps $X \rightarrow Y$ (both G -spaces)
$f \simeq g$	The maps f and g are homotopic
$f \simeq_G g$	The maps f and g are G -equivariantly homotopic
$[X, Y]_G$	The G -homotopy classes of maps $X \rightarrow Y$
(d_0, d, d_1)	Degree triple for equivariant homotopy classes (see p. 25)
$\mathcal{L}X$	The free loop space of X
ΩX	The space of based loops in X
$\Omega(X, x_0)$	The space of based loops in X with basepoint x_0
\mathbb{H}^+	The upper half plane in \mathbb{C}
$\pi(X, p)$	The fundamental group of X with basepoint p
$\pi(X; p, q)$	The homotopy classes of curves in X with fixed endpoints p and q
\mathcal{H}_n	The set of complex, hermitian $n \times n$ matrices
\mathcal{H}_n^*	The set of complex, hermitian, non-singular $n \times n$ matrices
$\mathcal{H}_{(p,q)}$	The subset of \mathcal{H}_{p+q}^* consisting of matrices with eigenvalue signature (p, q)
$c_p: X \rightarrow Y$	The constant map, which sends every $x \in X$ to $p \in Y$
iff	if and only if
LHS, RHS	Left-hand side, right-hand side
X^G	For a G -space X , $X^G = \{x \in X: G(x) = \{x\}\}$
tM	Matrix transpose of the matrix M
M^*	For a matrix M , M^* denotes its conjugate-transpose, i. e. $M^* = {}^t\overline{M}$
e^n	An open n -cell
$\gamma_2 * \gamma_1$	Concatenation of curves γ_1 and γ_2 where $\gamma_1(1) = \gamma_2(0)$
γ^{-1}	For a curve γ , γ^{-1} denotes the same curve with reversed time
\mathbb{P}_n	The n -dimensional complex projective space
$\mathbb{R}\mathbb{P}_n$	The n -dimensional real projective space
\mathbb{E}_n	The $n \times n$ identity matrix
$\mathbb{E}_{p,q}$	The block diagonal matrix $\text{Diag}(\mathbb{E}_p, -\mathbb{E}_q)$
$\dim_H X$	The Hausdorff dimension of the topological space X
$\dim_p X$	The packing dimension of the topological space X
$\text{Gr}_k(\mathbb{C}^n)$	Grassmannian of k -dimensional complex subvectorspaces in \mathbb{C}^n
$\text{Gr}_k(\mathbb{R}^n)$	Grassmannian of k -dimensional real subvectorspaces in \mathbb{R}^n
$\text{cl}(X)$	Closure of the topological space X
∂X	Boundary of the topological space X

All maps are assumed to be continuous, unless otherwise stated. When discussing the dimension of complex geometric objects we refer to its *complex* dimension unless we explicitly use the term *real dimension*.

List of Figures

2.1. Type I G -CW setup of the torus X	16
2.2. Concatenation of maps from the cylinder.	18
2.3. Type II G -CW Setup of the Torus X	32
2.4. The $U(n)$ -orbits in $\mathcal{H}_{(p,q)}$	47
2.5. $\mathbb{P}_2 \setminus \{p_0\}$ retracts to $\mathbb{P}_1 \subset \mathbb{P}_2$	51
3.1. A jump curve.	74
3.2. Homotopy Visualization on the closed 2-Disk.	77

Bibliography

- [1] Jaume Agaudé. Decomposable free loop spaces. *Canadian Journal of Mathematics*, 39(4):938–955, 1987. <http://cms.math.ca/cjm/v39/cjm1987v39.0938-0955.pdf>.
- [2] Alexander Altland and Lars Fritz. Primer on topological insulators. http://www.sfbtr12.uni-koeln.de/files/top_ins.pdf.
- [3] Glen E. Bredon. *Introduction to Compact Transformation Groups*. Academic Press, 1972.
- [4] M. Eichler and D. Zagier. On the zeros of the weierstrass \wp -function. *Mathematische Annalen*, 258:399–407, 1982.
- [5] Martín Escardó and Reinhold Heckmann. Topologies on spaces of continuous functions. 2001. <http://www.cs.bham.ac.uk/~mhe/papers/newyork.pdf>.
- [6] Kenneth Falconer. *Fractal Geometry*. Reader in Mathematics, University of Bristol. John Wiley & Sons, 1990.
- [7] Otto Forster. *Lecture on Riemann Surfaces*. Springer, 1981.
- [8] Phillip Griffiths and Joseph Harris. *Principles of Algebraic Geometry*. John Wiley & Sons, 1978.
- [9] Allen Hatcher. *Algebraic Topology*. Cambridge University Press, 2002.
- [10] H. Grauert K. Fritzsche. *From Holomorphic Functions to Complex Manifolds*. 2002.
- [11] Ricardo Kennedy. *Homotopy Theory of Topological Insulators*. 2014.
- [12] John M. Lee. *Introduction to Smooth Manifolds*. Springer, 2000.
- [13] J. Peter May. *Equivariant Homotopy and Cohomology Theory*. American Mathematical Society, 1996. <http://www.math.rochester.edu/people/faculty/doug/otherpapers/alaska1.pdf>.
- [14] John W. Milnor. *Topology from the differentiable viewpoint*. The University Press of Virginia, 1965.
- [15] Dierk Schleicher. Hausdorff dimension, its properties and its surprises. 114:509–528, 2007.

- [16] Mike Seppälä. Moduli space of real algebraic curves. *Annales scientifiques de l'École normale supérieure*, 24(5):519–544, 1991.
- [17] Jay Shah. Equivariant algebraic topology. <http://www.math.uchicago.edu/~may/VIGRE/VIGRE2010/REUPapers/Shah.pdf>.
- [18] Ralph Stöcker and Heiner Zieschang. *Algebraische Topologie*. B. G. Teubner, 1994.
- [19] Mohammad Farajzadeh Tehrani. Notes on genus one real gromov-witten invariants. *pre-print*, 2014.
- [20] Ximin Xiao. Packing dimension, hausdorff dimension and cartesian product sets. *Math. Proc. Camb. Phil. Soc.*, 120:535–546, 1996.