

COMPACT STEIN SURFACES AS BRANCHED COVERS WITH SAME BRANCH SETS

TAKAHIRO OBA

ABSTRACT. Loi and Piergallini showed that a smooth compact, connected 4-manifold X with boundary admits a Stein structure if and only if X is a simple branched cover of a 4-disk D^4 branched along a positive braided surface S in a bidisk $D_1^2 \times D_2^2 \approx D^4$. For each integer $N \geq 2$, we construct a braided surface S_N in D^4 and simple branched covers $X_{N,1}, X_{N,2}, \dots, X_{N,N}$ of D^4 branched along S_N such that the covers have the same degrees, and they are mutually diffeomorphic, but the Stein structures associated to the covers are mutually not homotopic. Furthermore, by reinterpreting this result in terms of contact topology, for each integer $N \geq 2$, we also construct a transverse link L_N in the standard contact 3-sphere (S^3, ξ_{std}) and simple branched covers $M_{N,1}, M_{N,2}, \dots, M_{N,N}$ of S^3 branched along L_N such that the covers have the same degrees, and they are mutually diffeomorphic, but the contact structures associated to the covers are mutually not isotopic.

1. INTRODUCTION.

Compact Stein surfaces are sublevel sets of exhausting strictly plurisubharmonic functions on Stein manifolds. They have been studied by using complex and symplectic geometry. For example, Eliashberg [5] characterized handle decompositions of compact Stein surfaces, and Gompf [11] gave how to draw Kirby diagrams of them. Since early 2000s, compact Stein surfaces also have been examined by using combinatorial techniques, and research on them has been dramatically altered. This development was caused by results of Loi and Piergallini [19] and Akbulut and Ozbagci [1]. They showed that a smooth, oriented, connected, compact 4-manifold X with boundary admits a Stein structure J if and only if X admits a *positive allowable Lefschetz fibration* $f : X \rightarrow D^2$ (see Section 2.3). It is known that Lefschetz fibrations are studied through mapping class groups, so group theoretical approaches of them help us to treat compact Stein surfaces. For example, by using such techniques, uniqueness results for Stein fillings of contact 3-manifolds were proven in [24, 15, 16, 21]. For more various results, we refer the reader to [23] as a survey on this subject.

Date: September 24, 2018.

2010 Mathematics Subject Classification. Primary 57M12; Secondary 32Q28, 57R17, 57R65.

Loi and Piergallini also showed that a smooth, oriented, connected, compact 4-manifold X with boundary admits a Stein structure J if and only if X is a simple branched cover of a 4-disk D^4 branched along a *positive braided surface* S in a bidisk $D_1^2 \times D_2^2$ (see Definition 2.1 and 2.2), where, by rounding the corner of $D_1^2 \times D_2^2$, it is identified with D^4 . Unfortunately, although the fact is well-known, little is known about how Stein structures behave towards positive braided surfaces. We can describe braided surfaces by using combinatorial tools such as chart descriptions, quandles, and braid monodromies (cf. [14]). In order to use them effectively for research on compact Stein surfaces, we need to better understand interactions between Stein structures and braided surfaces.

In this paper, we consider whether or not, for a given positive braided surface S , there exist more than one compact Stein surfaces as covers of D^4 branched along S such that the covers have the same degrees, and they are mutually diffeomorphic but admit mutually distinct Stein structures. The following theorem is a positive answer to this problem.

Theorem 1.1. *For a given integer $N \geq 2$, there exist a positive braided surface S_N and simple branched covers $X_{N,1}, X_{N,2}, \dots, X_{N,N}$ of D^4 branched along S_N such that*

- (1) *the degrees of these covers are same,*
- (2) *$X_{N,1}, X_{N,2}, \dots, X_{N,N}$ are mutually diffeomorphic, and*
- (3) *Stein structures $J_{N,1}, J_{N,2}, \dots, J_{N,N}$ on $X_{N,1}, X_{N,2}, \dots, X_{N,N}$ respectively, which are associated to the covers, are mutually not homotopic.*

In the above theorem, we consider as a Stein structure on the branched cover one given by a Lefschetz fibration associated to the branched covering (see Remark 2.5).

This theorem become more interesting, compared with the case of branched covers of $\mathbb{C}\mathbb{P}^2$ and cuspidal curves in $\mathbb{C}\mathbb{P}^2$. Here, a cuspidal curve is a projective plane curve whose singular points are ordinary nodes and ordinary cusps. Chisini's conjecture (see [4]) claims that if $S \subset \mathbb{C}\mathbb{P}^2$ is a cuspidal curve, a *generic* branched covering of $\mathbb{C}\mathbb{P}^2$ whose branch set is S and degree is at least 5 is unique up to covering isomorphism. Kulikov [17, 18] showed that this conjecture is true under certain conditions. The degree of each simple branched covering we will constructed in the proof of Theorem 1.1 is $3N - 1$ for each $N \geq 2$. In addition, according to Rudolph [25], a positive braided surface is isotopic to the intersection of a complex analytic curve with $D^4 \subset \mathbb{C}^2$, and the converse is also true. Hence, an analogue of Chisini's conjecture does not hold for simple branched coverings of D^4 whose branch sets are the intersections of complex analytic curves with D^4 .

We can reinterpret Theorem 1.1 in terms of contact 3-manifolds and transverse links. Let M be an oriented, connected, closed 3-manifold. A 2-plane field ξ on M is called a *contact structure* on M if there exists a 1-form on M such that $\xi = \text{Ker}(\alpha)$ and $\alpha \wedge d\alpha > 0$ with respect to the orientation of M , and the pair (M, ξ) is called a *contact manifold*. An oriented link L in (M, ξ) is called a *transverse link* if L is transverse to the contact plane ξ_x at any point x in L . Write (D^2, id) for a *supporting open book decomposition* of the standard contact 3-sphere (S^3, ξ_{std}) (cf. [7] for instance). Bennequin [3] showed that any transverse link in (S^3, ξ_{std}) can be braided about the binding of (D^2, id) .

Corollary 1.2. *For a given integer $N \geq 2$, there exist a transverse link L_N in (S^3, ξ_{std}) and simple branched covers $M_{N,1}, M_{N,2}, \dots, M_{N,N}$ of S^3 branched along L_N such that*

- (1) *the degrees of these covers are same,*
- (2) *$M_{N,1}, M_{N,2}, \dots, M_{N,N}$ are mutually diffeomorphic, and*
- (3) *contact structures $\xi_{N,1}, \xi_{N,2}, \dots, \xi_{N,N}$ on $M_{N,1}, M_{N,2}, \dots, M_{N,N}$ respectively, which are associated to the covers, are mutually not isotopic.*

Here, a contact structure on a branched cover means one supported by an open book associated to the branched covering.

This article is organized as follows: In Section 2, we review some definitions and properties of mapping class groups, braided surfaces, positive Lefschetz fibrations and supporting open book decompositions. In Section 3, first, we observe braids satisfying a certain condition, called liftable braids, and, by using this notion, prove a lemma to construct branched covers of D^4 in the proof of Theorem 1.1. Next, we review how to evaluate $\langle c_1(X, J), \cdot \rangle$, where $c_1(X, J)$ is the first Chern class of a compact Stein surface (X, J) . Finally, we prove Theorem 1.1 by using contact structures, PALFs and Kirby diagrams coupled with the above lemma.

Throughout this article we will work in the smooth category. We assume that the reader is familiar with basics of Kirby diagrams (see [12, Chapter 4, 5]).

Acknowledgments. The author would like to express his gratitude to Professor Hisaaki Endo for his encouragement and helpful comments for the draft of this article. He would also like to thank Burak Ozbagci for his helpful comments and fruitful discussions. The author was partially supported by JSPS KAKENHI Grant Number 15J05214.

2. PRELIMINARIES.

2.1. Mapping class groups. Let $\Sigma_{g,r}^k$ be an oriented, connected genus g surface with k marked points and r boundary components. We denote the mapping class

group of $\Sigma_{g,r}^k$ by $\mathcal{M}_{g,r}^k$. More precisely, $\mathcal{M}_{g,r}^k$ is the group of isotopy classes of orientation preserving self-diffeomorphisms of $\Sigma_{g,r}^k$ which fix the marked points setwise and the boundary pointwise. We also use the notations $\mathcal{M}_{g,r}$ if $k = 0$, and $\mathcal{M}_{\Sigma_{g,r}^k}$ for $\mathcal{M}_{g,r}^k$. For a simple closed curve α in $\Sigma_{g,r}^k$, $t_\alpha \in \mathcal{M}_{g,r}^k$ denotes the *right-handed Dehn twist* along α . Furthermore, for a simple arc a connecting two distinct marked points in $\Sigma_{g,r}^k$, write $\tau_a \in \mathcal{M}_{g,r}^k$ for the *right-handed half-twist* along a . We will use the opposite notation to the usual functional one for the products in $\mathcal{M}_{g,r}^k$, i.e. $h_1 h_2$ means that we apply h_1 first and then h_2 . Moreover, for a subset $A \subset \Sigma_{g,r}^k$ and $h \in \mathcal{M}_{g,r}^k$, the notation $(A)h$ means the image of A under h .

It is well known that the braid group B_m on m strands can be identified with the mapping class group $\mathcal{M}_{0,1}^m$ as follows (cf. [9, Section 3.2]): Consider an m -marked disk $\Sigma_{0,1}^m$ as the unit closed disk $\mathbb{D}_m \subset \mathbb{C}$ with m marked points which lie on the real axis. Set P_1, P_2, \dots, P_m as the m marked points, where $P_1 < P_2 < \dots < P_m$. Define an arc A_i on the real axis to be one with end points in P_i and P_{i+1} . Then, the i -th standard generator σ_i of B_m can be identified with the right-handed half-twist τ_{A_i} . In this article, under this identification, a simple arc with end points in the set of marked points represents the corresponding element of B_m to the half-twist along the arc.

2.2. Braided surfaces. Let D_1^2 and D_2^2 be oriented 2-disks.

Definition 2.1. *A properly embedded surface S in $D_1^2 \times D_2^2$ is called a (simply) braided surface of degree m if the first projection $pr_1 : D_1^2 \times D_2^2 \rightarrow D_1^2$ restricts to a simple branched covering $p_S := pr_1|_S : S \rightarrow D_1^2$ of degree m .*

We will review briefly braid monodromies of braided surfaces (see, for more details, [2, Section 3], [14, Chapter 16, 17], [26, §1, 2]). Before that, we recall a special basis for the fundamental group of a punctured disk. Let Q be a set of n points x_1, x_2, \dots, x_n in the interior of an oriented 2-disk D^2 with the standard orientation and let x_0 be a point in ∂D^2 . Since the fundamental group $\pi_1(D^2 - Q, x_0)$ is a free group of rank n , we give a basis for this group as follows: Take a collection of oriented paths s_1, s_2, \dots, s_n starting from x_0 to each x_i , respectively. Assume that s_i and s_j , if $i \neq j$, are disjoint except x_0 , and the arcs s_1, s_2, \dots, s_n are indexed so that they appear in order as we move counterclockwise about x_0 . By using the path s_i , connect x_0 to a small oriented disk around each x_i with the same orientation of D^2 . Then, we obtain an oriented loop γ_i based at x_0 , and $\gamma_1, \gamma_2, \dots, \gamma_n$ freely generate $\pi_1(D^2 - Q, x_0)$. The ordered n -tuple $(\gamma_1, \gamma_2, \dots, \gamma_n)$ is called a *Hurwitz system* for (Q, x_0) (see Figure 1).

We now turn to the case of braided surfaces. Let $Q(p_S) := \{a_1, a_2, \dots, a_n\} \subset \text{Int } D_1^2$ be the set of branch points of the branched covering $p_S : S \rightarrow D_1^2$. Fix a point a_0 in ∂D_1^2 and Hurwitz system $(\gamma_1, \gamma_2, \dots, \gamma_n)$ for $(Q(p_S), a_0)$. For each γ_i , the

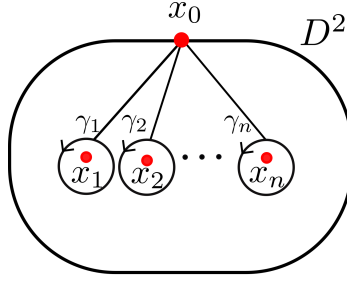
 FIGURE 1. The standard Hurwitz system for (Q, x_0) .

restriction of pr_1 to $pr_1^{-1}(\gamma_i)$ induces a trivial disk bundle over γ_i . Since for any point $a \in \gamma_i \subset D_1^2 - Q(p_S)$, $p_S^{-1}(a)$ consists of m points, each fiber $pr_1^{-1}(a) = \{a\} \times D_2^2 =: D_2^2(a)$ of the disk bundle contains m points, which are the intersection points of $D_2^2(a_0)$ and S . Hence, we associate an element $\beta_i \in B_m$ to γ_i as a motion of the set $D_2^2(a_0) \cap S$ over γ_i . By this correspondence, we can define a homomorphism $\omega_S : \pi_1(D_1^2 - Q(p_S)) \rightarrow B_m$ by $\omega_S(\gamma_i) = \beta_i$ for each i . This homomorphism ω_S is called a *braid monodromy* of S . The ordered n -tuple $(\omega_S(\gamma_1), \omega_S(\gamma_2), \dots, \omega_S(\gamma_n))$ is also called a braid monodromy of S . Since p_S is a simple branched covering, each $\omega_S(\gamma_i)$ is a conjugate $w_j^{-1} \sigma_{j_i}^{\varepsilon_i} w_j$ of $\sigma_{j_i}^{\varepsilon_i}$ for some $w_j \in B_m$ and $\varepsilon_i \in \{\pm 1\}$. It is known that, for a finite set Q and representation $\omega : \pi_1(D_1^2 - Q, a_0) \rightarrow B_m$ as above, we can construct a braided surface of degree m whose branch set is Q and braid monodromy is ω . Obviously, since p_S is a branched covering, we consider a *covering monodromy* of p_S , i.e. a representation $\rho_S : \pi_1(D_1^2 - Q(p_S), a_0) \rightarrow \mathfrak{S}_m$, where \mathfrak{S}_m is the symmetric permutation group of degree m . Note that each $\rho_S(\gamma_i) \in \mathfrak{S}_m$ is a transposition because p_S is simple. Furthermore, we also remark that ω_S is a lift of ρ_S to B_m .

At the end of this subsection, we define a crucial notion to examine compact Stein surfaces by braided surfaces.

Definition 2.2. A braided surface S is called *positive* if each $\omega_S(\gamma_i)$ is positive, that is, for a braid monodromy $(w_1^{-1} \sigma_{j_1}^{\varepsilon_1} w_1, w_2^{-1} \sigma_{j_2}^{\varepsilon_2} w_2, \dots, w_n^{-1} \sigma_{j_n}^{\varepsilon_n} w_n)$ of S , each ε_i is 1.

2.3. Lefschetz fibrations and simple branched coverings. We will briefly review positive Lefschetz fibrations and their monodromies (see [12, Chapter 8]).

Let X be an oriented, connected, compact 4-manifold.

Definition 2.3. A smooth map $f : X \rightarrow D^2$ is called a *positive Lefschetz fibration* if there exists the set $Q(f)$ of points a_1, a_2, \dots, a_n of the interior of D^2 such that

- (1) $f|_{f^{-1}(D^2 - Q(f))} : f^{-1}(D^2 - Q(f)) \rightarrow D^2 - Q(f)$ is a smooth fiber bundle over $D^2 - Q(f)$ with fiber diffeomorphic to an oriented compact surface Σ with boundary,

- (2) a_1, a_2, \dots, a_n are the critical values of f , and each singular fiber $f^{-1}(a_i)$ has a unique critical point $p_i \in f^{-1}(a_i)$, and
- (3) for each p_i and a_i , there are local complex coordinate charts with respect to the orientations of X and D^2 such that locally f can be written as $f(z_1, z_2) = z_1^2 + z_2^2$.

A positive Lefschetz fibration $f : X \rightarrow D^2$ can be described by the mapping class group \mathcal{M}_Σ of the fiber Σ of f . Let $a_0 \in \partial D^2$ be a fixed base point. Take a Hurwitz system $(\gamma_1, \gamma_2, \dots, \gamma_n)$ for $(Q(f), a_0)$. We can consider a homomorphism $\eta_f : \pi_1(D^2 - Q(f), a_0) \rightarrow \mathcal{M}_\Sigma$ as follows: The positive Lefschetz fibration f restricts to a fiber bundle $f|_{f^{-1}(\gamma_i)} : f^{-1}(\gamma_i) \rightarrow \gamma_i$ for each γ_i . The monodromy of this fiber bundle is the right-handed Dehn twist t_{α_i} along a simple closed curve α_i in $f^{-1}(a_0) \approx \Sigma$. The simple closed curve α_i is called a *vanishing cycle* of the singular fiber $f^{-1}(a_i)$. Define $\eta_f : \pi_1(D^2 - Q(f), a_0) \rightarrow \mathcal{M}_\Sigma$ by $\eta_f(\gamma_i) = t_{\alpha_i}$ for each γ_i and call η_f a *monodromy* of f . We also call the ordered n -tuple $(t_{\alpha_1}, t_{\alpha_2}, \dots, t_{\alpha_n})$ a monodromy of f . We say a positive Lefschetz fibration to be *allowable* if all of the vanishing cycles $\alpha_1, \alpha_2, \dots, \alpha_n$ are homologically non-trivial in the fiber. After this, we call a positive allowable Lefschetz fibration a *PALF* shortly.

The following theorem tells us that PALFs and positive braided surfaces are so important to study compact Stein surfaces.

Theorem 2.4 (Loi and Piergallini [19, Theorem 3] (cf. Akbulut and Ozbagci [1, Theorem 5])). *Let X be an oriented, connected, compact 4-manifold with boundary. Then the following conditions are equivalent:*

- (1) X is a compact Stein surface, that is, X admits a Stein structure J ;
- (2) X admits a PALF $f : X \rightarrow D^2$;
- (3) X is a simple branched cover of D^4 branched along a positive braided surface in $D_1^2 \times D_2^2 \approx D^4$.

Note that according to [19, Proposition 1, 2] and the proof of Theorem 2.4, for a given PALF $f : X \rightarrow D^2$, we can construct a simple branched covering $p : X \rightarrow D^4$ whose branch set is a positive braided surface S so that $f = pr_1 \circ p$ and $Q(p_S) = Q(f)$. Conversely, for a given simple branched covering $p : X \rightarrow D^4$ whose branch set is a positive braided surface S , $f := pr_1 \circ p : X \rightarrow D_1^2$ is a PALF, and $Q(f) = Q(p_S)$ (cf. Figure 2). Suppose $a \in D_1^2$ is a regular point of the above PALF $f = pr_1 \circ p$. The point a is also a regular point of p_S . Since p is a simple branched covering branched along S , p restricts to a simple branched covering $p|_{p^{-1}(D_2^2(a))} : p^{-1}(D_2^2(a)) \rightarrow D_2^2(a)$ whose branch set is $S \cap D_2^2(a)$. It is easy to check that $p^{-1}(D_2^2(a))$ is the regular fiber $f^{-1}(a)$ of f .

Remark 2.5. It is known that the total space of a PALF admits a Stein structure by using the handle decomposition given by the PALF (see. [1, Theorem 5]). As mentioned above, a simple branched covering $p : X \rightarrow D^4 \approx D_1^2 \times D_2^2$ branched along a positive braided surface gives a PALF $pr_1 \circ p : X \rightarrow D_1^2$. Thus, we equip the cover X with the Stein structure coming from the PALF $pr_1 \circ p$.

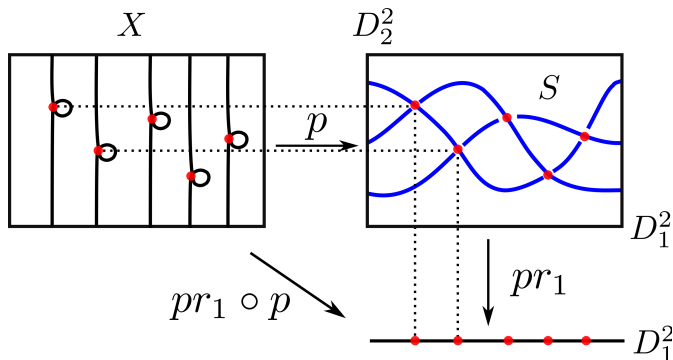

FIGURE 2. The left (resp. right) square represents the total space X of p (resp. $D_1^2 \times D_2^2$). The red points in X (resp. $D_1^2 \times D_2^2$) represents the critical points of the PALF $pr_1 \circ p$ (resp. the branched covering ps).

2.4. Supporting open book decompositions of tight lens spaces $L(2N, 1)$.

In order to show Theorem 1.1, we will discuss contact structures on the lens space $L(2N, 1)$ via open books. Hence, we review contact structures on $L(2N, 1)$ and their supporting open book decompositions (see [7], [24, Section 2] for more details).

To begin with, we recall a stabilization of a Legendrian knot. Let L be a Legendrian knot in (S^3, ξ_{std}) . A *positive* (resp. *negative*) *stabilization* on L is a Legendrian knot L_+ (resp. L_-) obtained from adding a zig-zag to L as depicted in the left (resp. right) of Figure 3. If L lies on a page of a supporting open book decomposition of (S^3, ξ_{std}) , we stabilize the open book and modify L as shown in the bottom of Figure 3.

Let $(L(2N, 1), \xi_{N,j})$ be a tight contact manifold obtained from the Legendrian surgery on the Legendrian knot $O_{N,j}$ shown in Figure 4. Since $O_{N,j}$ is a Legendrian knot with $tb = -2N + 1$ and $rot = 2(N - j)$, $O_{N,1}, O_{N,2}, \dots, O_{N,N}$ are mutually not Legendrian isotopic by [6, THEOREM 1.1]. Thus, according to Honda's classification of tight contact structures on $L(2N, 1)$ (see [13, Theorem 2.1]), $\xi_{N,1}, \xi_{N,2}, \dots, \xi_{N,N}$ are mutually not isotopic tight contact structures. To obtain a supporting open book decomposition of $(L(2N, 1), \xi_{N,j})$, we explain how $O_{N,j}$ is obtained from the Legendrian unknot O with $tb = -1$. Repeat $j - 1$

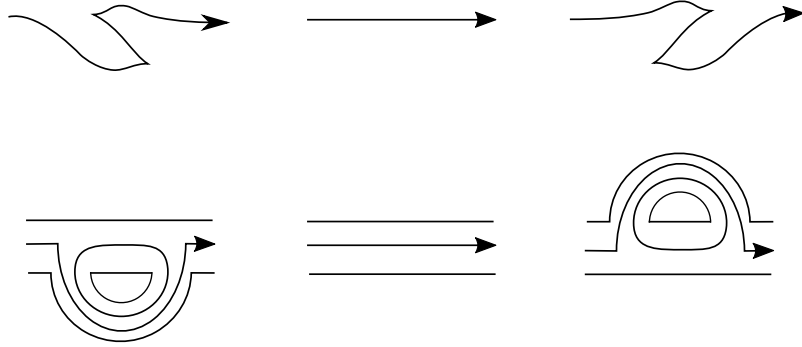

FIGURE 3. The stabilizations L_+ and L_- of a Legendrian knot L and the corresponding open books.

times positively and negatively stabilizing O alternately and, after that, perform $2(N - j)$ times negatively stabilizing the resulting Legendrian knot. Hence, the corresponding open book decomposition of $(L(2N, 1), \xi_{N,j})$ is given as in Figure 5. We write $(\Sigma_{0,2N}, \varphi_{N,j})$ for this open book, where the monodromy $\varphi_{N,j}$ is given by

$$\varphi_{N,j} = t_{\alpha_{N,j}} t_{\beta_{N,j}} t_{\delta_2} t_{\delta_3} \cdots t_{\delta_{2N-1}}.$$

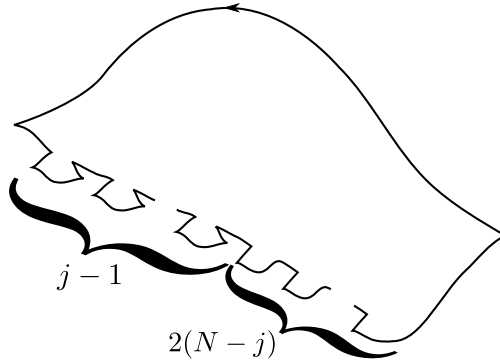
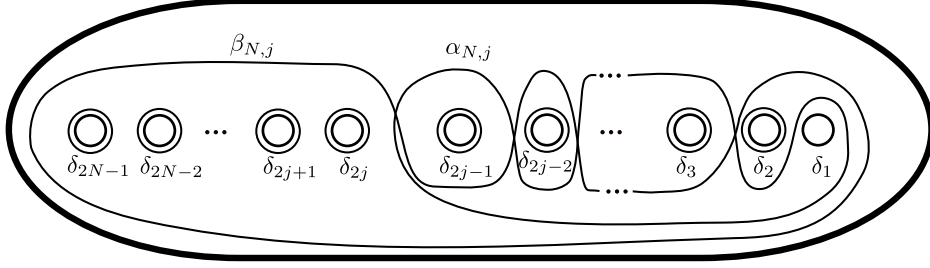

FIGURE 4. Legendrian knot $O_{N,j}$.

3. MAIN RESULTS.

Let Σ be an oriented, connected, compact surface with boundary. Suppose $q : \Sigma \rightarrow D^2$ is a simple branched covering of degree d . This covering q determines a covering monodromy $\rho_q : \pi_1(D^2 - Q(q), b_0) \rightarrow \mathfrak{S}_d$. Identifying B_m with $\mathcal{M}_{0,1}^m$ as in Section 2.1, we associate with a given $\beta \in B_m$ the mapping class $h_\beta \in \mathcal{M}_{0,1}^m$. We call $\beta \in B_m$ or $h_\beta \in \mathcal{M}_{0,1}^m$ *liftable* with respect to the branched covering $q : \Sigma \rightarrow D^2$ with m branch points if there exists an orientation preserving diffeomorphism H_β

 FIGURE 5. Supporting open book decomposition of $(L(2N, 1), \xi_{N,j})$.

of Σ such that $q \circ H_\beta = h \circ q$ for some representative h of h_β . Note that, in this definition, we identify with \mathbb{D}_m the base disk D^2 with m branch points and consider $\mathcal{M}_{0,1}^m$ as the mapping class group of \mathbb{D}_m . In [20, Lemma 4.3.3], it is shown that, if $h_\beta \in \mathcal{M}_{0,1}^m$ is liftable with respect to q , then we have

$$(3.1) \quad \rho_q \circ h_{\beta_*} = \rho_q$$

for the induced isomorphism $h_{\beta_*} : \pi_1(D^2 - Q(q), \beta_0) \rightarrow \pi_1(D^2 - Q(q), b_0)$.

The following lemma is useful to construct simple branched covers of D^4 .

Lemma 3.1. *Let S be a positive braided surface of degree m with braid monodromy $(w_1^{-1}\sigma_{j_1}w_1, w_2^{-1}\sigma_{j_2}w_2, \dots, w_n^{-1}\sigma_{j_n}w_n)$ and let a_0 be a fixed base point in ∂D_1^2 . Suppose $q : \Sigma \rightarrow D_2^2(a_0)$ is a simple branched covering of degree d with branch set $S \cap D_2^2(a_0)$ and covering monodromy ρ_q . If each $w_i^{-1}\sigma_{j_i}w_i \in B_m$ is liftable with respect to q , then there exist an oriented, connected, compact 4-manifold X and a simple branched covering $p : X \rightarrow D^4$ branched along S such that $p|_{p^{-1}(D_2^2(a_0))} = q$.*

Proof. Fix a point $b_0 \in \partial D_2^2$. Let $(\gamma'_1, \gamma'_2, \dots, \gamma'_m)$ be the standard Hurwitz system for $(D_2^2(a_0 - S), (a_0, b_0))$ as in Figure 1. It is known that

$$\pi_1(D^4 - S, (a_0, b_0)) = \langle \gamma'_1, \gamma'_2, \dots, \gamma'_m | (\gamma'_{j_i})w_{i*} = (\gamma'_{j_{i+1}})w_{i*} \ i = 1, 2, \dots, n \rangle,$$

where each w_{i*} is the Artin automorphism of the free group $\langle \gamma'_1, \gamma'_2, \dots, \gamma'_m \rangle$ defined by

$$(\gamma'_j)\sigma_{i*} = \begin{cases} \gamma'_i \gamma'_{i+1} \gamma'^{-1}_i & (j = i), \\ \gamma'_i & (j = i + 1), \\ \gamma'_j & (j \neq i, i + 1). \end{cases}$$

More precisely we refer the reader to [10, p.133] and [26, PROPOSITION 4.1] about this fundamental group. If we show $\rho_q((\gamma'_{j_i})w_{i*}) = \rho_q((\gamma'_{j_{i+1}})w_{i*})$ for each i , we conclude that ρ_q induces a homomorphism $\rho : \pi_1(D^4 - S, (a_0, b_0)) \rightarrow \mathfrak{S}_d$, and this ρ determines a simple branched covering $p : X \rightarrow D^4$ of degree d whose branch set is S .

For each i , we have

$$\begin{aligned} (\gamma'_{j_i})w_{i*} &= ((\gamma'_{j_{i+1}})\sigma_{j_{i*}})w_{i*} \\ &= (\gamma'_{j_{i+1}})\{w_{i*}(w_i)_*^{-1}\}\sigma_{j_{i*}}w_{i*} \\ &= ((\gamma'_{j_{i+1}})w_{i*})(w_i^{-1}\sigma_{j_i}w_i)_*. \end{aligned}$$

Since each $w_i^{-1}\sigma_{j_i}w_i$ is liftable and the equation (3.1) holds for any liftable braid,

$$\begin{aligned} \rho_q((\gamma'_{j_i})w_{i*}) &= \rho_q(((\gamma'_{j_{i+1}})w_{i*})(w_i^{-1}\sigma_{j_i}w_i)_*) \\ &= (\rho_q \circ (w_i^{-1}\sigma_{j_i}w_i)_*)((\gamma'_{j_{i+1}})w_{i*}) \\ &= \rho_q((\gamma'_{j_{i+1}})w_{i*}). \end{aligned}$$

According to the above construction of p , we can easily check $p|p^{-1}(D_2^2(a_0)) = q$. \square

In the proof of Theorem 1.1, we use the first Chern class of a compact Stein surface. In order to compute them, we make use of the following facts in [8, Section 3] and [11, Proposition 2.3]. Let $f : X \rightarrow D^2$ denote a PALF with fiber Σ and let $\alpha_1, \alpha_2, \dots, \alpha_n$ be the its vanishing cycles. Note that X admits a Stein structure J by Theorem 2.4. Once choosing a trivialization of the regular fiber of f , the rotation number $\text{rot}(C)$ of a simple closed curve C is defined with respect to this trivialization. Give an orientation to a vanishing cycle α_i and regard this α_i as a generator $[\alpha_i]$ of the chain group $C_2(X)$ (cf. [12, Section 4.2]). Then, we have for the first Chern class $c_1(X, J)$ of (X, J) ,

$$\langle c_1(X, J), [\alpha_i] \rangle = \text{rot}(\alpha_i).$$

Proof of Theorem 1.1. Fix a_0 in ∂D_1^2 and b_0 in $\partial D_2^2(a_0)$. At first, in order to construct a braided surface, we give elements $\beta_{1,N}, \beta_{2,N}, \beta_{3,i}, \beta_{4,i}, \beta_{5,i}$ of $B_{8(N-1)}$ for $i = 1, 2, \dots, N-1$ as depicted in Figure 6. After this proof, we give explicit braid words of these braids. Now we define a braided surface S_N of degree $6N-4$ to be one with braid monodromy

$$(3.2) \quad (\beta_{1,N}, \beta_{2,N}, \beta_{3,1}, \beta_{3,2}, \dots, \beta_{3,N-1}, \beta_{4,1}, \beta_{4,2}, \dots, \beta_{4,N-1}, \beta_{5,1}, \beta_{5,2}, \dots, \beta_{5,N-1}).$$

In order to use Lemma 3.1, we need to construct appropriate simple branched covers of $D_2^2(a_0)$. Define a simple branched covering $q_{N,j} : \Sigma_{0,3N-1} \rightarrow D_2^2(a_0)$ of degree $3N-1$ for each $j = 1, 2, \dots, N$ as shown in Figure 7. After this proof, by using a covering monodromy, we will describe this covering more explicitly. According to [20, Lemma 3.2.3] for example, we can check that each braid of the tuple (3.2) is liftable with respect to each covering $q_{N,j}$ (see Figure 7). It follows from Lemma 3.1 that for each covering $q_{N,j}$, there exists a simple branched covering $p_{N,j} : X_{N,j} \rightarrow D^4$ branched along S_N such that $p_{N,j}|p_{N,j}^{-1}(D_2^2(a_0)) = q_{N,j}$.

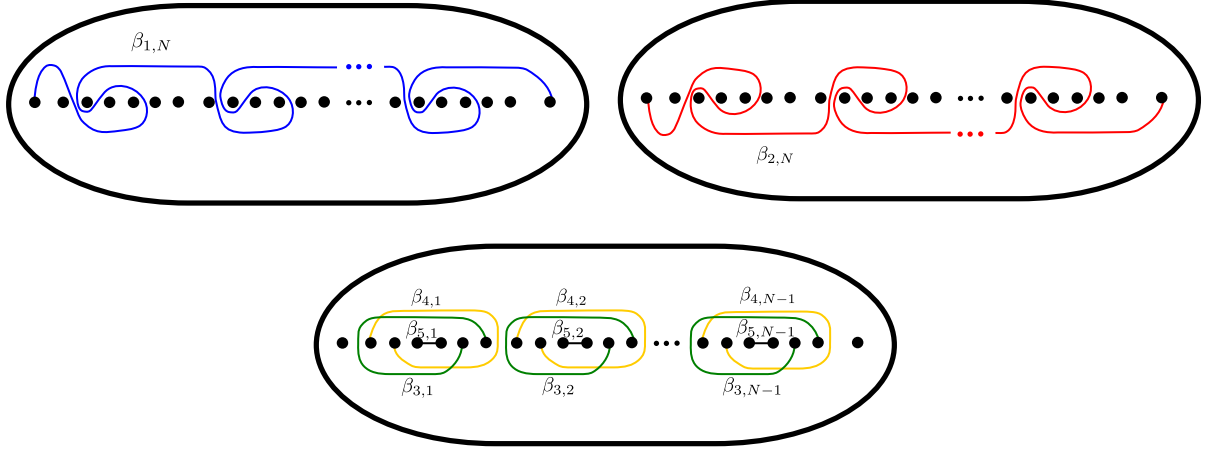

FIGURE 6. Generating arcs of $\beta_{1,N}, \beta_{2,N}, \beta_{3,i}, \beta_{4,i}, \beta_{5,i} \in B_{8(N-1)}$ as elements of $\mathcal{M}_{0,1}^m$.

We show that $X_{N,1}, X_{N,2}, \dots, X_{N,N}$ are mutually diffeomorphic. To do this, we will make use of stabilizations of open books and the classification of Stein fillings of a contact manifold. The map $pr_1 \circ p_{N,j} : X_{N,j} \rightarrow D_1^2$ is a PALF, and a monodromy of this PALF is the lift of the braid monodromy (3.2) of S_N by $q_{N,j}$. Write

$$(t_{C_{1,N}^j}, t_{C_{2,N}^j}, t_{C_{3,1}^j}, t_{C_{3,2}^j}, \dots, t_{C_{3,N-1}^j}, t_{C_{4,1}^j}, t_{C_{4,2}^j}, \dots, t_{C_{4,N-1}^j}, t_{C_{5,1}^j}, t_{C_{5,2}^j}, \dots, t_{C_{5,N-1}^j})$$

for this monodromy of $pr_1 \circ p_{N,j}$, where each $C_{k,i}^j$ is the simple closed curve generating the right-handed Dehn twist as the lift of $\beta_{k,i}$ by $q_{N,j}$ (see Figure 8). We obtain from this PALF an open book decomposition of $\partial X_{N,1}$ with page $\Sigma_{0,3N-1}$ and monodromy

$$\psi_{N,j} := t_{C_{1,N}^j} t_{C_{2,N}^j} t_{C_{3,1}^j} t_{C_{3,2}^j} \cdots t_{C_{3,N-1}^j} t_{C_{4,1}^j} t_{C_{4,2}^j} \cdots t_{C_{4,N-1}^j} t_{C_{5,1}^j} t_{C_{5,2}^j} \cdots t_{C_{5,N-1}^j}.$$

Stabilize the open book $(\Sigma_{0,2N}, \varphi_{N,j})$ $N - 1$ times as shown in Figure 10. We can easily check that the resulting stabilization is $(\Sigma_{0,3N-1}, \psi_{N,j})$. Hence, each $\partial X_{N,j}$ is diffeomorphic to $L(2N, 1)$. Furthermore, since a positive stabilization of an open book supports the same contact structure supported by the previous one, $(\Sigma_{0,3N-1}, \psi_{N,j})$ supports the contact structure $\xi_{N,j}$. Consider $X_{N,j}$ as a Stein filling of $(L(2N, 1), \xi_{N,j})$ and apply to $X_{N,j}$ the classification of Stein fillings of $(L(2N, 1), \xi_{N,j})$. By [24, Corollary 1.3], $X_{N,j}$ is diffeomorphic to the disk bundle $X(S^2, -2N)$ over S^2 with Euler number $-2N$ if $(N, j) \neq (2, 1)$; otherwise either $X(S^2, -4)$ or the rational ball with Euler characteristic 1. In our case, since $X_{2,1}$ admits the PALF $pr_1 \circ p_{2,1}$ with fiber $\Sigma_{0,5}$ and 5 critical points, the Euler characteristic of $X_{2,1}$ is 2. Thus, every $X_{N,j}$ is diffeomorphic to $X(S^2, -2N)$.

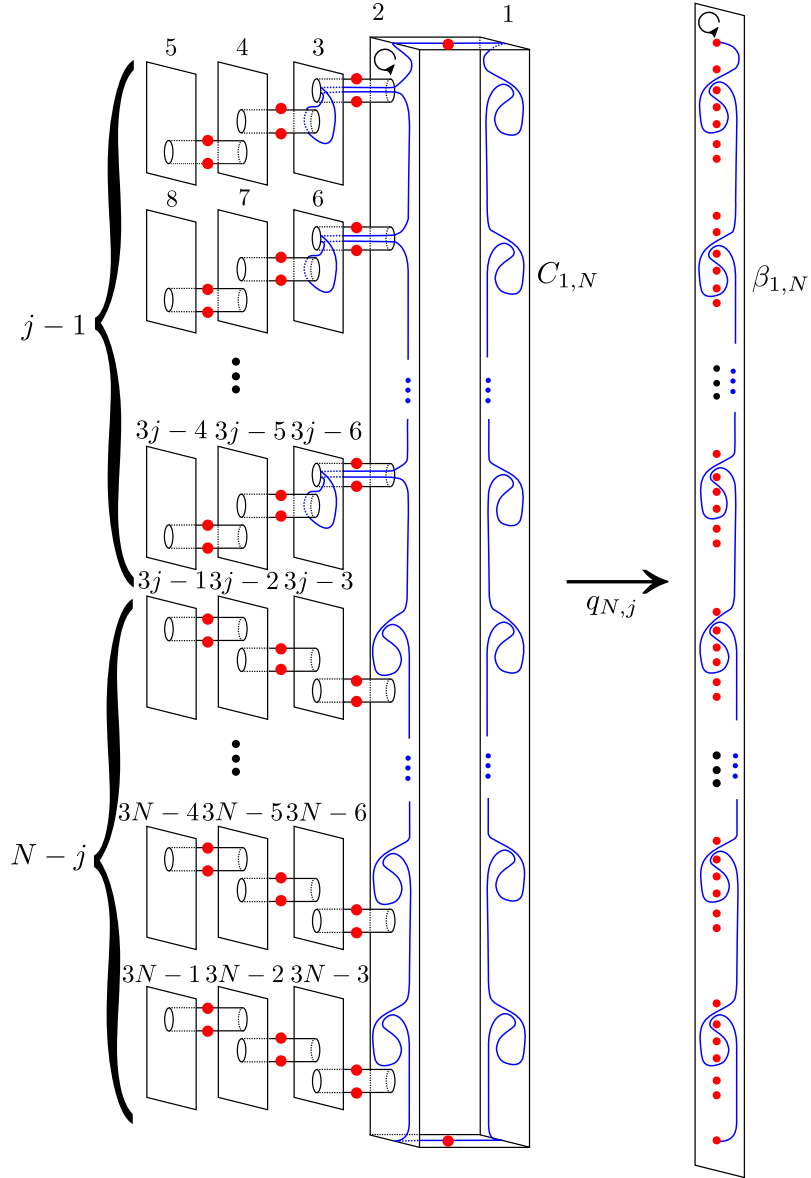

FIGURE 7. Covering $q_{N,j} : \Sigma_{0,3N-1} \rightarrow D_2^2(a_0)$. Each number represents an index of each sheet of the covering. The blue curve $C_{1,N}$ in the cover is the closed component of the lift of the arc generating the half-twist $\beta_{1,N}$

To finish the proof, we compute the first Chern class of each $(X_{N,j}, J_{N,j})$, where $J_{N,j}$ is the Stein structure associated to $p_{N,j}$. To begin with, we draw a Kirby diagram of $X_{N,j}$ from the PALF structure to examine a generator of $H_2(X_{N,j}; \mathbb{Z}) \cong \mathbb{Z}$. Since the regular fiber of $pr_1 \circ p_{N,j}$ is $\Sigma_{0,3n-1}$, a Kirby diagram of $X_{N,j}$ has $3N - 2$ dotted

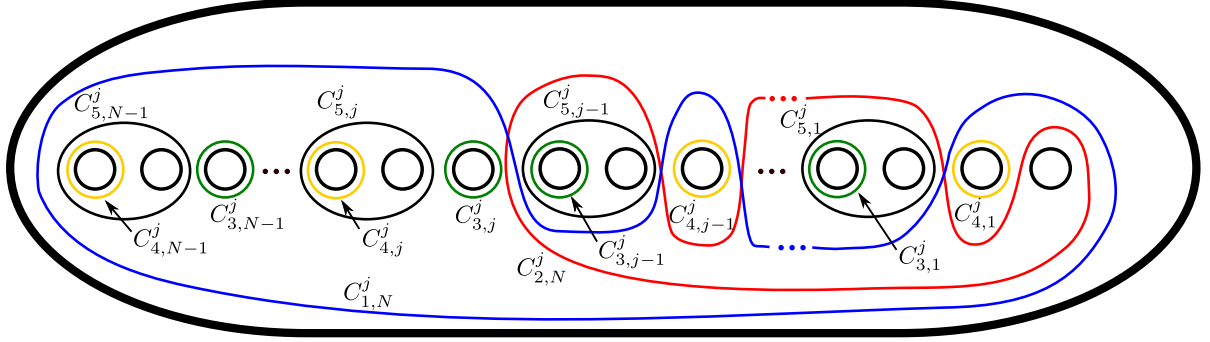

FIGURE 8. Vanishing cycles of the PALF $pr_1 \circ p_{N,j} : X_{N,j} \rightarrow D_1^2$.

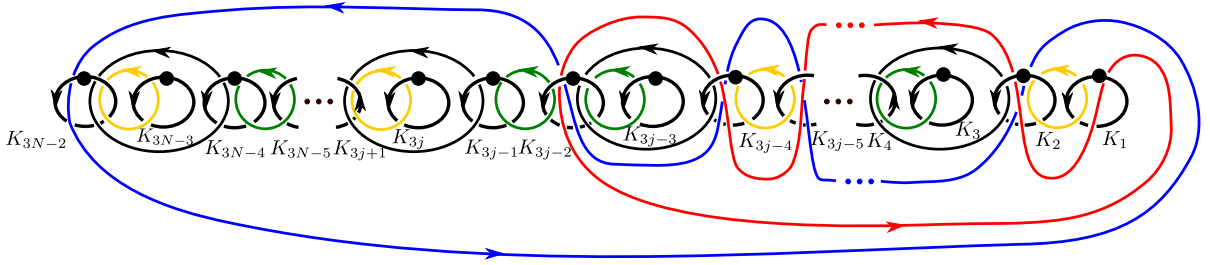

FIGURE 9. Kirby diagram of $X_{N,j}$

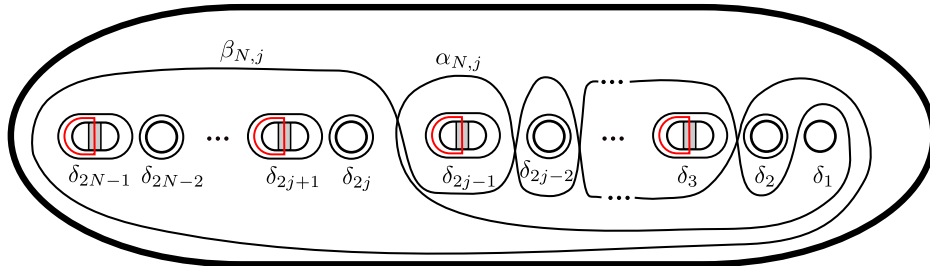

FIGURE 10. Stabilization of the open book decomposition $(\Sigma_{0,2N}, \varphi_{N,j})$. Each shaded band (resp. red curve) represents an added band (resp. curve generating added Dehn twists) by this stabilizing.

1-handles $K_1, K_2, \dots, K_{3N-2}$. We give orientations to the dotted circles of these 1-handles, and the attaching circles $C_{1,N}^j, C_{2,N}^j, C_{3,1}^j, \dots, C_{5,N-1}^j$ of these 2-handles as in Figure 9. These $[K_1], \dots, [K_{3N-2}]$ and $[C_{1,N}^j], \dots, [C_{5,N-1}^j]$ freely generate the chain group $C_1(X)$ and $C_2(X)$ respectively (cf. [12, Section 4.2] and [22, Section

2.3]). We claim that, for each $j = 1, 2, \dots, N$,

$$Z_{N,j} := [C_{1,N}^j] - [C_{2,N}^j] - \sum_{i=j}^{N-1} [C_{3,i}^j] - \sum_{i=1}^{j-1} [C_{4,i}^j] + \sum_{i=1}^{j-1} [C_{5,i}^j] - \sum_{i=j}^{N-1} [C_{5,i}^j]$$

is a generator of $H_2(X_{N,j}; \mathbb{Z})$. Let $\partial : C_2(X) \rightarrow C_1(X)$ denote the boundary operator on the two chain groups $C_1(X)$ and $C_2(X)$ defined by $\partial([C]) := \sum_{i=1}^{3N-2} lk(C, K_i)[K_i]$ on the generators and extended linearly. Here, $lk(C, K_i)$ is the linking number of C and K_i . We have

$$\begin{aligned} & \partial([C_{1,N}^j] - [C_{2,N}^j]) \\ &= \{([K_2] - [K_4]) + ([K_5] - [K_7]) + \dots + ([K_{3j-4}] - [K_{3j-2}]) + [K_{3N-2}]\} \\ & \quad - \{([K_1] - [K_2]) + ([K_4] - [K_5]) + \dots + ([K_{3j-5}] - [K_{3j-4}]) + [K_{3j-2}]\} \\ &= -[K_1] + 2\{([K_2] - [K_4]) + ([K_5] - [K_7]) + \dots + ([K_{3j-4}] - [K_{3j-2}])\} + [K_{3N-2}], \\ & \partial(-\sum_{i=j}^{N-1} [C_{3,i}^j] - \sum_{i=1}^{j-1} [C_{4,i}^j]) \\ &= -\{(-[K_{3j-2}] + [K_{3j-1}]) + (-[K_{3j+1}] + [K_{3j+2}]) + \dots + (-[K_{3N-5}] + [K_{3N-4}])\} \\ & \quad - \{(-[K_1] + [K_2]) + (-[K_4] + [K_5]) + \dots + (-[K_{3j-5}] + [K_{3j-4}])\} \\ &= [K_1] - \{([K_2] - [K_4]) + ([K_5] - [K_7]) + \dots + ([K_{3j-4}] - [K_{3j-2}])\} \\ & \quad - \{([K_{3j-1}] - [K_{3j+1}]) + ([K_{3j+2}] - [K_{3j+4}]) + \dots + ([K_{3N-7}] - [K_{3N-5}])\} - [K_{3N-4}], \end{aligned}$$

and

$$\begin{aligned} & \partial(\sum_{i=1}^{j-1} [C_{5,i}^j] - \sum_{i=j}^{N-1} [C_{5,i}^j]) \\ &= -\{([K_2] - [K_4]) + ([K_5] - [K_7]) + \dots + ([K_{3j-4}] - [K_{3j-2}])\} \\ & \quad + \{([K_{3j-1}] - [K_{3j+1}]) + ([K_{3j+2}] - [K_{3j+4}]) + \dots \\ & \quad + ([K_{3N-7}] - [K_{3N-5}]) + ([K_{3N-4}] - [K_{3N-2}])\}. \end{aligned}$$

Therefore,

$$\partial(Z_{N,j}) = \partial([C_{1,N}^j] - [C_{2,N}^j] - \sum_{i=j}^{N-1} [C_{3,i}^j] - \sum_{i=1}^{j-1} [C_{4,i}^j] + \sum_{i=1}^{j-1} [C_{5,i}^j] - \sum_{i=j}^{N-1} [C_{5,i}^j]) = 0,$$

and $Z_{N,j}$ is an element of $\text{Ker } \partial$. Since $\text{Ker } \partial \cong H_2(X_{N,j}; \mathbb{Z}) \cong \mathbb{Z}$ is abelian and the coefficient of each term in $Z_{N,j} = [C_{1,N}^j] - [C_{2,N}^j] - \sum_{i=j}^{N-1} [C_{3,i}^j] - \sum_{i=1}^{j-1} [C_{4,i}^j] + \sum_{i=1}^{j-1} [C_{5,i}^j] - \sum_{i=j}^{N-1} [C_{5,i}^j]$ is either 1 or -1 , it is a generator of $\text{Ker } \partial$. Now, we can compute $c_1(X_{N,j}, J_{N,j})$. Strictly speaking, $c_1(X_{N,j}, J_{N,j})$ can evaluate on the generator of $H_2(X_{N,j}; \mathbb{Z})$ as follows:

$$\begin{aligned} & \langle c_1(X_{N,j}, J_{N,j}), Z_{N,j} \rangle \\ &= \langle c_1(X_{N,j}, J_{N,j}), [C_{1,N}^j] - [C_{2,N}^j] - \sum_{i=j}^{N-1} [C_{3,i}^j] - \sum_{i=1}^{j-1} [C_{4,i}^j] + \sum_{i=1}^{j-1} [C_{5,i}^j] - \sum_{i=j}^{N-1} [C_{5,i}^j] \rangle \\ &= \text{rot}(C_{1,N}^j) - \text{rot}(C_{2,N}^j) - \sum_{i=j}^N \text{rot}(C_{3,i}^j) - \sum_{i=1}^{j-1} \text{rot}(C_{4,i}^j) + \sum_{i=1}^{j-1} \text{rot}(C_{5,i}^j) - \sum_{i=j}^N \text{rot}(C_{5,i}^j) \\ &= 0 - 0 - \sum_{i=j}^{N-1} (+1) - \sum_{i=1}^{j-1} (+1) + \sum_{i=1}^{j-1} (+1) - \sum_{i=j}^{N-1} (+1) \\ &= -2(N-j) \end{aligned}$$

Therefore, $c_1(X_{N,j}, J_{N,j}) \neq c_1(X_{N,j'}, J_{N,j'})$ if $j \neq j'$, and the Stein structures $J_{N,1}, J_{N,2}, \dots, J_{N,N}$ are mutually not homotopic. \square

In the following, we give explicit descriptions of the braids $\beta_{1,N}, \beta_{2,N}, \beta_{3,i}, \beta_{4,i}, \beta_{5,i}$ and covering $q_{N,j} : \Sigma_{0,3N-1} \rightarrow D_2^2(a_0)$ in the above proof. These are not essential in this article, hence the reader can skip them if he or she likes.

We give first explicit braid words of the above braids. For convenience, set

$$\beta_1^{\beta_2} := \beta_2^{-1} \beta_1 \beta_2$$

for $\beta_1, \beta_2 \in B_m$, and

$$\tau_{i,j} := \sigma_i^{\sigma_{i+1}\sigma_{i+2}\cdots\sigma_{j-1}}, \quad \bar{\tau}_{i,j} := \sigma_i^{\sigma_{i+1}^{-1}\sigma_{i+2}^{-1}\cdots\sigma_{j-1}^{-1}} \in B_m,$$

where $i < j$ (see Figure 11). Obviously, if $j = i + 1$, both $\tau_{i,j}$ and $\bar{\tau}_{i,j}$ are σ_i . Define

$$T_{1,N} := \prod_{j=1}^{N-1} \{\tau_{2+6(j-1), 5+6(j-1)}^{-1} \bar{\tau}_{5+6(j-1), 8+6(j-1)}^{-1}\} \prod_{j=1}^{N-1} \{\sigma_{4+6(j-1)} \sigma_{3+6(j-1)}\},$$

$$\bar{T}_{1,N} := \prod_{j=1}^{N-1} \{\bar{\tau}_{2+6(j-1), 5+6(j-1)} \tau_{5+6(j-1), 8+6(j-1)}\} \prod_{j=1}^{N-1} \{\sigma_{4+6(j-1)}^{-1} \sigma_{3+6(j-1)}^{-1}\}.$$

Then, we have

$$\beta_{1,N} := \sigma_1^{T_{1,N}}, \quad \beta_{2,N} := \sigma_1^{\bar{T}_{1,N}},$$

$$\beta_{3,i} := \tau_{2+6(i-1), 6+6(i-1)}^{\bar{\tau}_{2+6(i-1), 7+6(i-1)}^{-1}}, \quad \beta_{4,i} := \tau_{3+6(i-1), 7+6(i-1)}^{\bar{\tau}_{2+6(i-1), 7+6(i-1)}}, \quad \beta_{5,i} := \tau_{6i-2, 6i-1} = \sigma_{6i-2}.$$

Next, we describe the covering $q_{N,j} : \Sigma_{0,3N-1} \rightarrow D_2^2(a_0)$ by using a covering monodromy. Let $(\gamma'_1, \gamma'_2, \dots, \gamma'_{6N-4})$ be the standard Hurwitz system for $(D_2^2(a_0) \cap S_N, (a_0, b_0))$. By observing Figure 7, we can check that a covering monodromy $\rho_{N,1} : \pi_1(D_2^2(a_0) - S_N, (a_0, b_0)) \rightarrow \mathfrak{S}_{3N-1}$ of the covering $q_{N,j}$ is a homomorphism

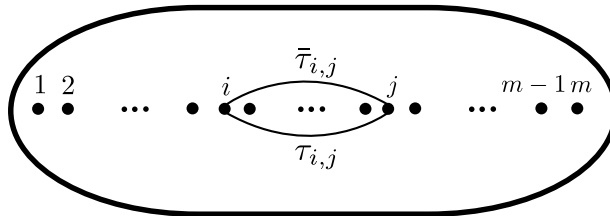

FIGURE 11. Generating curves of $\tau_{i,j}$ and $\bar{\tau}_{i,j}$, where we identify B_m with $\mathcal{M}_{0,1}^m$.

defined by

$$\rho_{N,j}(\gamma'_i) = \begin{cases} (1 \ 2) & (i = 1, 6N - 4), \\ (2 \ 3k) & (i = 2 + 6(k - 1), 3 + 6(k - 1); k = 1, 2, \dots, j - 1), \\ (3k \ 3k + 1) & (i = 4 + 6(k - 1), 5 + 6(k - 1); k = 1, 2, \dots, j - 1), \\ (3k + 1 \ 3k + 2) & (i = 6 + 6(k - 1), 7 + 6(k - 1); k = 1, 2, \dots, j - 1), \\ (3\ell + 1 \ 3\ell + 2) & (i = 2 + 6(\ell - 1), 3 + 6(\ell - 1); \ell = j, j + 1, \dots, N - 1), \\ (3\ell \ 3\ell + 1) & (i = 4 + 6(\ell - 1), 5 + 6(\ell - 1); \ell = j, j + 1, \dots, N - 1), \\ (2 \ 3\ell) & (i = 6 + 6(\ell - 1), 7 + 6(\ell - 1); \ell = j, j + 1, \dots, N - 1). \end{cases}$$

Remark 3.2. In the above proof, the case of $N = 2$ is crucial, so we explain how the author found the braided surface S_2 . First, he fixed two different branched coverings $q_{2,1}$ and $q_{2,2}$ and considered liftable braids with respect to both coverings. He observed how corresponding lifts change if we change $q_{2,1}$ into $q_{2,2}$, and he chose some braids among them to obtain the braided surface S_2 . Finally, drawing Kirby diagrams of the two corresponding covers branched along S_2 , he checked whether these covers satisfied the conditions of our theorem. Hence, his construction is very ad hoc. As far as he knows, there is no systematic construction of such a braided surface.

Proof of Corollary 1.2. Note that the boundary of a given braided surface S is contained in $\partial D_1^2 \times D_2^2$, and it is the closure of a braid. Letting U be the core of $D_1^2 \times \partial D_2^2$, we obtain from the product structure on $\partial D_1^2 \times D_2^2$, an open book decomposition of $S^3 \approx \partial D^4 \approx \partial(D_1^2 \times D_2^2)$ whose page is a disk and binding is U . This open book supports the standard contact structure ξ_{std} on S^3 . Thus, we can regard ∂S as a transverse link in (S^3, ξ_{std}) .

Let L_N be the boundary of S_N in the proof of Theorem 1.1. By the previous argument, L_N can be seen as a transverse link in (S^3, ξ_{std}) . Set $M_{N,j} := \partial X_{N,j}$. $M_{N,1}, M_{N,2}, \dots, M_{N,N}$ are mutually diffeomorphic to $L(2N, 1)$. Here, $p_{N,j} : X_{N,j} \rightarrow D^4$ restricts on the boundary $M_{N,j}$ to the simple branched cover of S^3 branched along L_N . By the proof of Theorem 1.1, the associated open book $(\Sigma_{0,3N-1}, \psi_{N,j})$ to the covering is adapted to $(L(2N, 1), \xi_{N,j})$. By the classification of tight contact structures on $L(2N, 1)$ in [13, Theorem 2.1], $\xi_{N,1}, \xi_{N,2}, \dots, \xi_{N,N}$ are mutually not isotopic. \square

REFERENCES

1. S. Akbulut and B. Ozbagci, *Lefschetz fibrations on compact Stein surfaces*, *Geom. Topol.* **5** (2001), 939–945.
2. N. Apostolakis, R. Piergallini, and D. Zuddas, *Lefschetz fibrations over the disc*, *Proc. Lond. Math. Soc.* (3) **107** (2013), no. 2, 340–390.
3. D. Bennequin, *Entrelacements et équations de Pfaff*, *Astérisque* **107–108** (1983), 87–161.

4. O. Chisini, *Sulla identita birazionale delle funzioni algebriche di due variabili dotate di una medesima curva di diramazione*, Ist. Lombardo Sci. Lett. Cl. Sci. Mat. Nat. Rend. (3) **8(77)** (1944). 339–356.
5. Y. Eliashberg, *Topological characterization of Stein manifolds of dimension > 2* , Internat. J. Math. **1** (1990), no. 1, 29–46.
6. Y. Eliashberg and M. Fraser, *Classification of topologically trivial Legendrian knots*, Geometry, topology, and dynamics (Montreal, PQ, 1995), 17–51, CRM Proc. Lecture Notes, 15, Amer. Math. Soc., Providence, RI, 1998.
7. J. Etnyre, *Lectures on open book decompositions and contact structures*, Floer Homology, Gauge Theory, and Low Dimensional Topology, Clay Math. Proc. **5**, Amer. Math. Soc., Providence, RI, 2006.
8. J. Etnyre and B. Ozbagci, *Invariants of contact structures from open books*, Trans. Amer. Math. Soc. **360** (6) (2008), 3133–3151.
9. J. Etnyre and J. Van Horn-Morris, *Monoids in the mapping class groups*, to appear in Geom. and Topol. Monogr: arXiv:1504.02106.
10. R. H. Fox, *A quick trip through knot theory*, Topology of 3-manifolds and related topics (Prentice-Hall, Englewood Cliffs, N.J., 1962), pp. 120–167.
11. R. Gompf, *Handlebody construction of Stein surfaces*, Ann. of Math. (2) **148** (1998), no. 2, 619–693.
12. R. Gompf and A. Stipsicz, *4-Manifolds and Kirby Calculus*, Grad. Stud. Math. **20**, Amer. Math. Soc., Providence, RI, 1999.
13. K. Honda, *On the classification of tight contact structures, I*, Geom. Topol. **4** (2000), 309–368.
14. S. Kamada, *Braid and knot theory in dimension four*, Mathematical Surveys and Monographs, **95**. American Mathematical Society, Providence, RI, 2002.
15. A. Kaloti, *Stein fillings of planar open books*, arXiv:1311.0208.
16. A. Kaloti and Y. Li, *Stein fillings of contact 3-manifolds obtained as Legendrian surgeries*, arXiv:1307.4726.
17. Vik. S. Kulikov, *On Chisini's conjecture*, Izv. Ross. Akad. Nauk Ser. Mat. **63** (1999), no. 6, 83–116; translation in Izv. Math. **63** (1999), no. 6, 1139–1170.
18. Vik. S. Kulikov, *On Chisini's conjecture. II*, Izv. Ross. Akad. Nauk Ser. Mat. **72** (2008), no. 5, 63–76; translation in Izv. Math. **72** (2008), no. 5, 901–913.
19. A. Loi and R. Piergallini, *Compact Stein surfaces with boundary as branched covers of B^4* , Invent. Math. **143** (2001), no. 2, 325–348.
20. J. M. Montesinos-Amilibia and H. R. Morton, *Fibred links from closed braids*, Proc. London Math. Soc. (3) **62** (1991), no. 1, 167–201.
21. T. Oba, *Stein fillings of homology 3-spheres and mapping class groups*, arXiv:1407.5257.
22. B. Ozbagci and A. Stipsicz, *Surgery on contact 3-manifolds and Stein surfaces*, Bolyai Soc. Math. Stud. **13**, Springer-Verlag, 2004.
23. B. Ozbagci, *On the topology of fillings of contact 3-manifolds*, to appear in Geom. Topol. Monogr. Vol 19 (2015).
24. O. Plamenevskaya and J. Van Horn-Morris, *Planar open books, monodromy factorizations and symplectic fillings*, Geom. Topol. **14** (2010), 2077–2101.
25. L. Rudolph, *Algebraic functions and closed braids*, Topology **22** (1983), no. 2, 191–202.
26. L. Rudolph, *Braided surfaces and Seifert ribbons for closed braids*, Comment. Math. Helv. **58** (1983), no. 1, 1–37.

DEPARTMENT OF MATHEMATICS, TOKYO INSTITUTE OF TECHNOLOGY, 2-12-1 OOKAYAMA,
MEGUROKU, TOKYO 152-8551, JAPAN

E-mail address: `oba.t.ac@m.titech.ac.jp`