

On Geometry of Interaction for Polarized Linear Logic

Masahiro Hamano ^{*} Philip Scott [†]

March 7, 2019

Abstract

We present Geometry of Interaction (GoI) models for Multiplicative Polarized Linear Logic, MLLP, which is the multiplicative fragment of Olivier Laurent’s Polarized Linear Logic. This is done by uniformly adding *multipoints* to various categorical models of GoI. Multipoints are shown to play an essential role in semantically characterizing the dynamics of proof networks in polarized proof theory. For example, they permit us to characterize the key feature of polarization, *focusing*, as well as being fundamental to our construction of concrete polarized GoI models.

Our approach to polarized GoI involves two independent studies, based on different categorical perspectives of GoI.

- (i) Inspired by the work of Abramsky, Haghverdi, and Scott, a *polarized GoI situation* is defined in which multipoints are added to a traced monoidal category equipped with a reflexive object U . Using this framework, categorical versions of Girard’s Execution formula are defined, as well as the GoI interpretation of MLLP proofs. Running the Execution formula is shown to characterize the focusing property (and thus polarities) as well as the dynamics of cut-elimination.
- (ii) The Int construction of Joyal-Street-Verity is another fundamental categorical structure for modelling GoI. Here, we investigate it in a multipointed setting. Our presentation yields a compact version of Hamano-Scott’s polarized categories, and thus denotational models of MLLP. These arise from a contravariant duality between monoidal categories of *positive* and *negative* objects, along with an appropriate bimodule structure (representing “non-focused proofs”) between them.

Finally, as a special case of (ii) above, a compact model of MLLP is also presented based on Rel (the category of sets and relations) equipped with multi-points.

Contents

1	Introduction	2
2	Polarized Multiplicative Linear Logic MLLP	4

^{*}PRESTO, Japan Science and Technology Agency (JST), 4-1-8 Honcho Kawaguchi, Saitama 332-0012, JAPAN. hamano@jaist.ac.jp Research supported by a PRESTO grant from JST.

[†]Department of Mathematics and Statistics, University of Ottawa, 585 King Edward, Ottawa, Ontario, K1N 6N5, CANADA. phil@site.uottawa.ca Research supported by an NSERC Discovery grant.

3	Polarized GoI and GoI Situations	6
3.1	Polarized GoI situations	7
3.2	Multipoints in polarized GoI situations	11
3.3	The GoI interpretation of MLLP proofs	15
3.4	Polarized execution formulas are an invariant for cut-elimination	23
3.5	Polarized execution formulas characterize focusing	25
4	Constructing a compact polarized category via GoI	31
4.1	Polarized logic and polarized categories	32
4.2	The Int construction	33
4.3	A polarized Int construction	34
5	A polarized Int construction using Rel with multipoints	40
6	Conclusion and Future Work	44
7	Appendices	47
7.1	Appendix 1: GoI situations and Execution formulas for MELL	47
7.2	Appendix 2: Unique Decomposition Categories (UDCs)	49
7.3	Appendix 3: Generalized Yanking for a traced monoidal category	49
7.4	Appendix 4: Omitted Proofs	50
7.5	Appendix 5: Remarks on Retractions $U \triangleright_{(k,j)} U \otimes U$ and $U \otimes 1 \triangleright_{(!\alpha, r_\alpha)} U$	52
7.6	Appendix 6: Pictorial Proof for Prop 3.21 (Ex is an Invariant)	53

1 Introduction

Linear Logic, introduced by Girard in 1987 [12], originated from a profound analysis of the proof theory of traditional logic. In particular, linear logic involves a fine-grained study of how rules and connectives manipulate resources. This important development is by now quite familiar to researchers in many areas of logic and computer science. What is somewhat less familiar is that shortly after the introduction of linear logic, Andreoli [3, 4] pointed out a different approach to the fundamental connectives of linear logic; namely, to classify the connectives according to whether their introduction rules are reversible (*negative*) or irreversible (*positive*). Positive connectives are the foundation of Andreoli’s influential notion of *focusing* in proof search. The fundamental role of focusing in logic programming has been actively explored in numerous recent works (for example, in papers of D. Miller, K. Chaudhuri, et. al. [41, 35, 42, 7, 8]).

The Andreoli view also led to intrinsic studies of polarity and polarized logics, first taken up by Girard in [15, 16], and systematically studied by O. Laurent in [32, 34]. Such logics are also related to Girard’s Ludics games [17] and other games-semantics models (cf. the dialogue games and recent dialogue categories with chiralities of Melliès [38, 39].) In related categorical proof theory, we should mention the polarized categories and proof theory of Cockett and Seely [10], which influenced our own [23], as well as proof-theoretical papers of one of us [24, 25].

In this paper we begin a study of the dynamics of cut-elimination for the multiplicative fragment MLLP of O. Laurent’s polarized linear logic, using categorical versions of Girard’s

Geometry of Interaction (GoI) program [13, 14]; here we follow the categorical GoI literature [1, 20]. A common theme to the different parts of this paper is a fundamental new semantical idea first discussed in [24]: the addition of *multipoints*. These multipoints have no syntactic counterpart but nevertheless provide a new understanding of the dynamics of cut-elimination in the presence of polarities.

- In Section 3, following the methods of Abramsky, Haghverdi, and Scott [1] we introduce *polarized GoI situations with multipoints* as an appropriate but simple categorical setting for studying Girard’s Execution formula in the polarized setting. The version of the execution formula we use is inspired by the general categorical execution formula in Haghverdi-Scott [20, 21] for linear logic, but now extended to the multipointed setting. For the polarized multiplicative system MLLP, the execution formula becomes a *two-layered* pair of execution formulas, one at the usual reflexive object level (as in [20]) and a similar one at the multipoint-level. The usual GoI properties for the dynamics of cut-elimination [13, 20, 21] turn out to be much stronger for MLLP. The execution formula(s) form *full invariants* for normalization ¹, which is well-known to fail in full linear logic (see [1] and Section 3.4 below). In fact the polarized execution formula(s) satisfy a fundamental additional property. Namely, in Proposition 3.28 below, we characterize focusing, which is intrinsic to MLLP, as preservation of multipoints under the (polarized) execution formulas. Thus, in a precise sense, the execution formulas give rise to the polarities.
- In the next Sections 4 and 5, which are independent of Section 3, we consider general multipointed traced monoidal categories (TMCs) and study the **Int** construction of Joyal, Street, and Verity [29] in this setting. As is well-known [1, 20], the **Int** construction is an essential feature of all the different categorical approaches to GoI. It yields a kind of “compact closure” of a traced monoidal category; moreover, composition in the **Int** category leads to categorical versions of Girard’s execution formula. As in Section 3 above, we investigate a two-layered **Int** construction, the upper layer for general objects and the lower one restricted to multipoints.

In Section 4, we study a general categorical semantics for certain polarized linear logics, a simplified version of the bi-module duality framework in our paper [23]. These are related to more general polarized categories introduced for modelling polarities (see [10, 23, 38, 39]). Our goal is to use GoI and the **Int** construction to build compact polarized categorical models of MLLP.

In these sections multipoints give a semantical framework for explaining the idea of bidirectional dataflow implicit in the **Int** construction (see the discussion preceding Proposition 4.8 below). In this setting, multipoints satisfy a weak pullback condition—corresponding to the focusing condition discussed in Section 3—which we show is compatible with this construction. As one expects, this yields an appropriate compact closed version of a denotational model for MLLP.

Finally, Section 5 constructs a concrete instance of the **Int** construction of Section 4, when specialized to a multipointed version of Rel. It may be read independently of the

¹in the sense that if $\pi \rightarrow_* \pi'$ by MLLP cut-elimination, then $\text{Ex}(\llbracket \pi \rrbracket, \sigma) = \text{Ex}(\llbracket \pi' \rrbracket, \sigma')$

previous section and uses the relational calculus of Joyal-Street-Verity [29].

- In order to make the paper self-contained, the Appendices include some supplemental material. In Appendix 7.1 we briefly recall the original *GoI situations* in the sense of Abramsky, Haghverdi and Scott [1], as well as the categorical approach to GoI (for a survey, see [21]). In Appendix 7.2 we recall Haghverdi’s Unique Decomposition Categories (UDC’s) which provide a general framework (and matrix calculus) for “particle-style” GoI, familiar from Girard’s GoI 1 [13, 20]. The other Appendices include some detailed but routine proofs.

2 Polarized Multiplicative Linear Logic MLLP

Following the work of Andreoli, polarities naturally arise within the proof theory of linear logic, LL. We can further divide the connectives according to whether their introduction rules are reversible or not [16, 34]. Those connectives which are reversible are called *negative*; those which are not are called *positive*. Positive connectives are the foundation of Andreoli’s influential *focusing property* in proof search for linear logic [3, 4, 41]. Focusing is a property dual to reversibility.

We recall Olivier Laurent’s theory of *polarized multiplicative linear logic*, MLLP. The theory MLLP is a fragment (without structural rules) of Laurent’s full polarized linear logic LLP [17].

Definition 2.1 (Polarized MLL) The theory MLLP is defined as follows.

Syntax: *Positive* and *Negative* formulas are given by the following BNF notation:

$$\begin{aligned} P & ::= X \mid P \otimes P \mid \mathbf{1} \mid \downarrow N \\ N & ::= X^\perp \mid N \wp N \mid \perp \mid \uparrow P \end{aligned}$$

Here X is an atom, \uparrow and \downarrow are called *polarity shifting* operations. Note that $\mathbf{1}$ is the unit of \otimes (and dually for \perp with respect to \wp). In our categorical models introduced later, \uparrow and \downarrow will be functorial operators weaker than the traditional exponentials of linear logic.

Syntactic Negation: Following O. Laurent, we adjoin to MLLP a syntactic strictly involutive negation $(-)^{\perp}$, defined by general de Morgan duality. Thus we extend the negation on positive atoms to all formulas, as follows: $X^{\perp\perp} = X$ for atoms X , and we assume $\{\otimes, \wp\}$ are de Morgan duals, as in linear logic. Finally de Morgan duals for polarity changing operators are $(\downarrow A)^{\perp} = \uparrow A^{\perp}$ and $(\uparrow A)^{\perp} = \downarrow A^{\perp}$ for any formula A . Positivity and negativity of formulas may be defined as before, after cancelling any occurrences of double-negations.

Rules of MLLP

In the following rules, M and N (resp. \mathcal{M} and \mathcal{N}) range over negative formulas (resp. sequences of negative formulas) and P and Q over positive formulas. Γ contains *at most one* positive formula. We assume the rule of exchange, so sequents are closed under permutation.

$$\frac{}{\vdash N, N^{\perp}} \text{Axiom} \qquad \frac{\vdash \mathcal{M}, P \quad \vdash \mathcal{N}, Q}{\vdash \mathcal{M}, \mathcal{N}, P \otimes Q} \otimes \qquad \frac{\vdash \Gamma, N, M}{\vdash \Gamma, N \wp M} \wp$$

$$\frac{\vdash N, \mathcal{N}}{\vdash \downarrow N, \mathcal{N}} \downarrow \qquad \frac{\vdash P, \mathcal{N}}{\vdash \uparrow P, \mathcal{N}} \uparrow \qquad \frac{\vdash \Gamma, N \quad \vdash \mathcal{M}, N^\perp}{\vdash \Gamma, \mathcal{M}} \text{cut}$$

The following theorem is an important proof-theoretical property of MLLP, proved in [32, 34]:

Proposition 2.2 (Focalization Property) *If $\vdash \Gamma$ is provable in MLLP, then the sequence Γ contains at most one positive formula.*

A *focused sequent* is one of the form $\vdash P, \mathcal{N}$, while a *nonfocused sequent* has the form $\vdash \mathcal{N}$, where \mathcal{N} is a finite sequence of negative formulas and P is positive. Proposition 2.2 says that every provable sequent of MLLP is either focused or nonfocused. We say a proof is focused if the sequent it proves is focused. We say a proof *has the focusing property* if it is focused.

Notation: For the discussion of GoI and Cut-elimination, we use the Girard notation [13] for sequent calculus proofs: a proof of the sequent $\vdash [\Delta], \Gamma$ denotes a proof of the sequent $\vdash \Gamma$ appended with the list Δ of all pairs of cut formulas A, A^\perp used in the proof. Here $|\Gamma| = n$ and $|\Delta| = 2m$, for some m, n . This is further described in the categorical GoI papers of Haghverdi-Scott (see Appendix 7.1 and Figure 6 there.)

Cut elimination for MLLP: MLLP is the subsystem of polarized linear logic LLP [34] without additive connectives and structural rules (where \downarrow and \uparrow replace, respectively, $!$ and $?$). The cut elimination theorem for MLLP is obtained by restricting the one for LLP (cf. Definition 5.27 of [34]). For this, the interpretation using polarized proof-nets (e.g. [32]) is essential. The crucial ingredient for our subsystem MLLP is the use of *boxes* to interpret the \downarrow -rules. Each box has a principal door and an auxiliary door on which occur, respectively, the principal formula $\downarrow N$ and the side formulas \mathcal{M} .

The crucial step for cut-elimination is the following (cf. the $!/!$ case of Definition 5.27 of [34]): reduction of a cut against a side formula of the \downarrow rule. Here, a proof ending with a cut against a formula at an auxiliary door of a box is reduced to that ending with the \downarrow -rule, whose box is enlarged to contain all rules including the original cut. This is illustrated as follows:

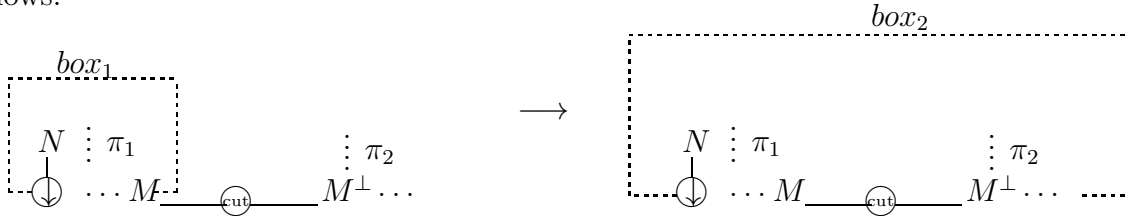

Example 2.3 (Extrusion of \downarrow -boxes through cut-elimination) Consider the following three proofs, as instances of normalization: $\pi_1 \succ \pi_2 \succ \pi_3$.

$$\begin{array}{c} \pi_1 = \\ \frac{\vdash X_1^\perp, X_1}{\vdash X_1^\perp, \uparrow X_1} \downarrow \quad \vdots \\ \frac{\vdash \downarrow X_1^\perp, \uparrow X_1 \quad \vdash \downarrow X_2^\perp, \uparrow X_2}{\vdash [\uparrow X_1, \downarrow X_2^\perp], \downarrow X_1^\perp, \uparrow X_2} \text{cut} \quad \vdots \\ \frac{\vdash [\uparrow X_1, \downarrow X_2^\perp], \downarrow X_1^\perp, \uparrow X_2 \quad \vdash \downarrow X_3^\perp, \uparrow X_3}{\vdash [\uparrow X_1, \downarrow X_2^\perp, \uparrow X_2, \downarrow X_3^\perp], \downarrow X_1^\perp, \uparrow X_3} \text{cut} \end{array} \qquad \begin{array}{c} \pi_2 = \\ \frac{\vdash X_1^\perp, X_1}{\vdash X_1^\perp, \uparrow X_1} \quad \vdots \\ \frac{\vdash X_1^\perp, \uparrow X_1 \quad \vdash \downarrow X_2^\perp, \uparrow X_2}{\vdash [\uparrow X_1, \downarrow X_2^\perp], X_1^\perp, \uparrow X_2} \text{cut} \quad \vdots \\ \frac{\vdash [\uparrow X_1, \downarrow X_2^\perp], \downarrow X_1^\perp, \uparrow X_2 \quad \vdash \downarrow X_3^\perp, \uparrow X_3}{\vdash [\uparrow X_1, \downarrow X_2^\perp, \uparrow X_2, \downarrow X_3^\perp], \downarrow X_1^\perp, \uparrow X_3} \text{cut} \end{array}$$

$$\pi_3 = \frac{\frac{\frac{\vdash X_1^\perp, X_1}{\vdash X_1^\perp, \uparrow X_1} \quad \vdash \downarrow X_2^\perp, \uparrow X_2}{\vdash [\uparrow X_1, \downarrow X_2^\perp], X_1^\perp, \uparrow X_2} \text{ cut} \quad \vdash \downarrow X_3^\perp, \uparrow X_3}{\vdash [\uparrow X_1, \downarrow X_2^\perp, \uparrow X_2, \downarrow X_3^\perp], X_1^\perp, \uparrow X_3} \text{ cut} \quad \downarrow}{\vdash [\uparrow X_1, \downarrow X_2^\perp, \uparrow X_2, \downarrow X_3^\perp], \downarrow X_1^\perp, \uparrow X_3} \downarrow$$

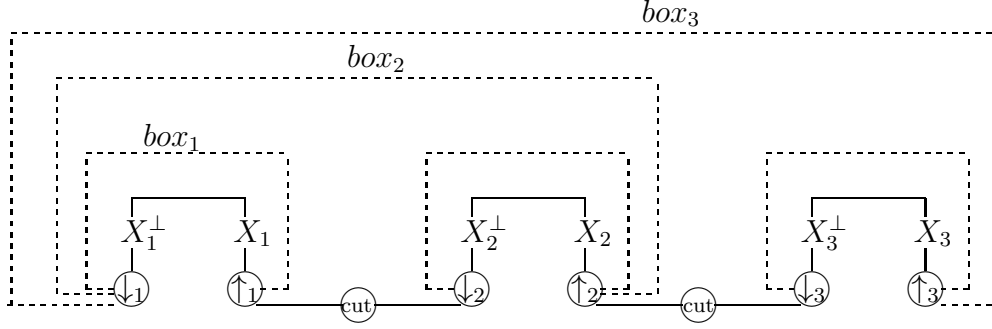

During normalization, boxes enter outer boxes and the scope of the outer box is extruded. That is, for $i = 1, 2, 3$, we represent proof π_i by the proof-net obtained by choosing box_i for the left-most \downarrow . The box_i corresponds to the indicated \downarrow -rule in π_i . Normalization gives rise to extrusions of box_1 into box_2 to include the middle box of π_2 and then into box_3 to include both the middle and right boxes of π_3 .

3 Polarized GoI and GoI Situations

GoI situations were first introduced in Abramsky, Haghverdi, and Scott [1] as an algebraic framework for Girard's GoI for full linear logic. Later, Haghverdi and Scott [20, 21] gave a detailed categorical analysis of Girard's original GoI for MELL in GoI situations associated to Unique Decomposition categories (UDCs), augmented with abstract (Hyland-Schalk) orthogonality relations. For a quick summary of this categorical GoI for the original (nonpolarized) setting, see Appendix 7.1 (and its references) for GoI and Appendix 7.2 for UDCs. In particular, we will make use of the categorical version of the Execution Formula.

In this section we develop an appropriate notion of *Polarized GoI Situation with multipoints* for MLLP. Multipoints will enable us to give a detailed analysis of the dynamics and information flow in cut-elimination, via polarized (2-layered) execution formulas. It will also enable us to give a characterization of focusing. Our main result in this Section 3 is to semantically characterize the proof-theoretical notion of focusing in terms of the polarized execution formulas. This goes as follows. First, in Proposition 3.25, the polarized execution formulas for focused sequents are shown to satisfy an invariance property preserving the multipoints. Conversely in Proposition 3.28, this invariance property is shown to be sufficient to distinguish focused sequents. Thus, in a precise sense, polarized GoI execution formulas give rise to the polarities.

Notation: In a category \mathcal{C} , we denote identity arrows $X \rightarrow X$ either as Id_X or just X , depending on context. Let $Y \begin{array}{c} \xrightarrow{g} \\ \xleftarrow{f} \end{array} X$ be a pair of morphisms in a category. We write $g : Y \triangleright X : f$ to mean $g \circ f = \text{Id}_X$ and we say X is a retract of Y with respect to (g, f) . This

is often abbreviated by $Y \triangleright_{(g,f)} X$. We say X is a retract of Y if there is a pair (g, f) as above such that $Y \triangleright_{(g,f)} X$.

For simplicity, we assume all categories \mathcal{C} below are locally small, so we can speak of hom-sets (rather than hom-classes).

3.1 Polarized GoI situations

We introduce a polarized analog of GoI situations from [1] (see Appendix 7.1 for a summary), which is suitable for polarized multiplicative linear logic. The full exponential operators T of GoI situations for (nonpolarized) linear logic LL are here replaced by much weaker, functorial *polarity shifters*: \uparrow and \downarrow , as well as by introducing the critical notion of multipoints.

Definition 3.1 (Polarized GoI situation) A polarized GoI situation is a tuple

$$(\mathcal{C}, \otimes, I, s, U, 1, (!, r), 1 \xrightarrow{\alpha} U, (!_\alpha, r_\alpha), 0)$$

where:

1. $(\mathcal{C}, \otimes, I, s)$ is a traced symmetric monoidal category (with symmetry maps $s = \{s_{A,B} : A \otimes B \rightarrow B \otimes A\}$), and with unit object I , satisfying the usual identities ([36]). In the monoidal structure, X^m and f^m denote respectively m -ary tensors (also called *tensor foldings*) $\overbrace{X \otimes \cdots \otimes X}^m$ and $\overbrace{f \otimes \cdots \otimes f}^m$.
2. U is an object of \mathcal{C} with a retraction $U \triangleright_{(k,j)} U \otimes U$, i.e. ²

$$U \begin{array}{c} \xrightarrow{k} \\ \xleftarrow{j} \end{array} U \otimes U \quad \text{such that } k \circ j = \text{Id}_{U \otimes U}.$$

3. 1 is an object of \mathcal{C} with a retraction $1 \otimes 1 \triangleright_{(!,r)} 1$, i.e.

$$1 \otimes 1 \begin{array}{c} \xrightarrow{!} \\ \xleftarrow{r} \end{array} 1 \quad \text{such that } ! \circ r = \text{Id}_1.$$

Note: In general, $1 \neq I$.

4. (*Distinguished point*) A morphism $1 \rightarrow U$ is called a *point* of U . A polarized GoI situation has a distinguished point $1 \xrightarrow{\alpha} U$ among the points of U
5. (*Uniformity of Trace*)

The trace of \mathcal{C} is *uniform* (cf. Simpson and Plotkin [43] and Hasegawa [26]) over points; i.e., every point $p : 1 \rightarrow U$ satisfies the following condition, which says points are trace invariant.

² A coherence result is shown in Hines [27] for the monoidal structures for (k, j) . E.g., the associativity of the monoidal structure of j is obtained by $j \circ (U \otimes j) \circ a = \tau \circ j \circ (j \otimes U)$ where a is the associativity isomorphism for \otimes in \mathcal{C} and $\tau := j \circ (j \otimes U) \circ a \circ (U \otimes k) \circ k$ is the associativity isomorphism for the monoidal structure defined by $j \circ (f \otimes g) \circ k$ on U . In what follows, we identify canonically isomorphic objects which the coherence guarantees.

For any morphisms f and g ,

$$\begin{array}{ccc}
 X \otimes U & \xrightarrow{f} & Y \otimes U \\
 \uparrow X \otimes p & & \uparrow Y \otimes p \\
 X \otimes 1 & \xrightarrow{g} & Y \otimes 1
 \end{array}
 \quad \text{implies} \quad
 \text{Tr}_{X,Y}^U(f) = \text{Tr}_{X,Y}^1(g).$$

The final axioms 6, 7 and 9 in the definition concern properties satisfied by the distinguished point $1 \xrightarrow{\alpha} U$.

6. (*Lifting Property* $U \otimes 1 \triangleright_{(!_\alpha, r_\alpha)} U$ along α)

For the distinguished point $1 \xrightarrow{\alpha} U$, there exists a pair $(!_\alpha, r_\alpha)$ giving a retraction $U \otimes 1 \triangleright_{(!_\alpha, r_\alpha)} U$ which lifts the retraction $1 \otimes 1 \triangleright_{(!, r)} 1$ along the point α . This means the following diagram commutes (in all possible ways) with $!_\alpha \circ r_\alpha = \text{Id}_U$ and $! \circ r = \text{Id}_1$:

$$\begin{array}{ccc}
 U \otimes 1 & \xrightarrow{!_\alpha} & U \\
 \uparrow \alpha \otimes 1 & & \uparrow \alpha \\
 1 \otimes 1 & \xrightarrow{!} & 1 \\
 & \xleftarrow{r} & \\
 & \xleftarrow{r_\alpha} &
 \end{array}$$

7. (*Semi-invertibility of α*)

The point $\alpha : 1 \rightarrow U$ is *semi-invertible*. That is, there exists $\alpha^* : U \rightarrow 1$ such that $\alpha^* \circ \alpha = \text{Id}_1$.

8. (*0 morphisms*)

The category \mathcal{C} has *zero morphisms*. This means for every pair of objects $X, Y \in \mathcal{C}$, there is an assigned map $0_{XY} : X \rightarrow Y$ such that the family $\{0_{XY} \mid X, Y \in \mathcal{C}\}$ satisfies: for every $f : W \rightarrow X, g : Y \rightarrow Z$,

$$\begin{array}{ccc}
 W & \xrightarrow{0_{WZ}} & Z \\
 \downarrow f & & \downarrow g \\
 X & \xrightarrow{0_{XY}} & Y
 \end{array}$$

Note: if f or g equals the identity, this amounts to the fact that any composition with one factor zero is itself zero (see also [37]). For simplicity, 0 denotes the zero morphism $0_{11} : 1 \rightarrow 1$. Note that $f \otimes 0_{Y,Z}$ is not in general $0_{W \otimes Y, X \otimes Z}$ for any objects X, Y, W, Z .³

9. ($(!_\alpha, r_\alpha)$ and 0)

For every morphism $f : V \otimes X \rightarrow W \otimes X$ with $X \in \{U, 1\}$ and $0 : 1 \rightarrow 1$,

$$(\text{Id}_W \otimes !_\alpha) \circ (f \otimes 0) \circ (\text{Id}_V \otimes r_\alpha) = f \quad \text{and} \quad (\text{Id}_W \otimes !) \circ (f \otimes 0) \circ (\text{Id}_V \otimes r) = f$$

Diagrammatically, the following are the respective equations when $X = U$ and $X = 1$:

³Hence zero morphisms are absorbing with respect to composition, but not with respect to tensor.

$$\begin{array}{c}
\begin{array}{ccc}
V & \xrightarrow{\quad} & W \\
\downarrow & & \downarrow \\
U & \xrightarrow{\quad} & U \\
\downarrow & & \downarrow \\
U & \xrightarrow{\quad} & U \\
\downarrow & & \downarrow \\
1 & \xrightarrow{\quad} & 1 \\
\downarrow & & \downarrow \\
0 & \xrightarrow{\quad} & 0
\end{array}
\begin{array}{c}
\boxed{f} \\
\otimes \\
\otimes
\end{array}
= f
\end{array}
\quad \text{and} \quad
\begin{array}{c}
\begin{array}{ccc}
V & \xrightarrow{\quad} & W \\
\downarrow & & \downarrow \\
1 & \xrightarrow{\quad} & 1 \\
\downarrow & & \downarrow \\
1 & \xrightarrow{\quad} & 1 \\
\downarrow & & \downarrow \\
1 & \xrightarrow{\quad} & 1 \\
\downarrow & & \downarrow \\
0 & \xrightarrow{\quad} & 0
\end{array}
\begin{array}{c}
\boxed{f} \\
\otimes \\
\otimes
\end{array}
= f
\end{array}$$

This ends the definition of a polarized GoI situation.

The following Examples 3.2 and 3.3 of polarized GoI situations are built from the category Rel of sets and relations. Rel has two standard traced-monoidal structures (see [1, 29] for details), one with $\otimes = \times$ (cartesian product), the other $\otimes = +$ (disjoint union). These two categories are denoted by Rel_\times and Rel_+ , respectively. We don't discuss Rel_\times in this paper, so in what follows we often abbreviate Rel_+ to Rel . Below, we emphasize the additional polarized structure.

Example 3.2 (Polarized GoI situation Rel_+)

$$(\text{Rel}, \otimes, I, s, \mathbb{N}, 1, (!, r), 1 \xrightarrow{\alpha} U, (!_\alpha, r_\alpha), 0)$$

is a polarized GoI situation, denoted Rel_+ (or just Rel), where we define:

- The objects of Rel_+ are sets and morphisms are (binary) relations between them.
- \otimes is the disjoint union $+$, where $A + B := (\{1\} \times A) \cup (\{2\} \times B)$.
- $I := \emptyset, U := \mathbb{N}, 1 := \{*\}$.
- The retraction $k : \mathbb{N} \triangleright \mathbb{N} + \mathbb{N} : j$ is a standard one often used in GoI [13, 1, 19]:
$$j(1, n) = 2n, j(2, n) = 2n + 1, \text{ and } k(n) = \begin{cases} (1, \frac{n}{2}) & n \text{ even} \\ (2, \frac{n-1}{2}) & n \text{ odd} \end{cases}$$
- $r : 1 \rightarrow 1 + 1$ is the maximal relation, and $! : 1 + 1 \rightarrow 1$ is its converse.
- $\alpha : \{*\} \rightarrow \mathbb{N}$ is a *non-empty relation* that determines a distinguished *singleton* subset $\{n_\alpha\}$ of \mathbb{N} .
- $!_\alpha : U + 1 \rightarrow U$ is the relation whose restriction on U (resp. on 1) is Id_U (resp. α) and r_α is the converse relation of $!_\alpha$.
- The zero morphism 0_{XY} is the empty relation, for all X, Y .

Example 3.3 (Pfn and Plnj as degenerate polarized GoI situations) Starting with the category Rel above, we consider the two major subcategories Pfn (partial functions) and Plnj (partial injective functions) from [1], with the following choices of $!, r, !_\alpha, r_\alpha$: for both Pfn and Plnj , $r : 1 \rightarrow 1 + 1$ is the left (or right) inclusion and $!$ is its inverse. $r_\alpha : U \rightarrow U + 1$ is the left embedding.

- Pfn: $!_\alpha : U + 1 \rightarrow U$ is the total function whose restriction on U (resp. on 1) is Id_U (resp. α).
- Plnj: $!_\alpha : U + 1 \rightarrow U$ is the partial injection determined by the identity on U .

We say these models are *degenerate* since in Rel, $r[1] := \{y \mid (*, y) \in r\} = 1 + 1$, whereas in the other models Pfn and Plnj, $r[1] = 1$. This latter property of 1 causes the interpretation of polarized proofs in MLLP to become degenerate (see Remark 3.19 below.)

We now make some remarks and observations about the axioms for polarized GoI situations in Definition 3.1 above. We generalize Axioms **2** and **3** to m -ary tensors, and denote them by Axioms **2'** and **3'** respectively. We will apply these remarks in Proposition 3.7 below, where Axioms **6** and **9** are generalized, resulting in Axioms **6'** and **9'**, resp.

- *Strengthening of Axiom 5 (Uniformity of Trace):*

Proposition 3.4 (Strong Uniformity of Trace:) *For any morphisms*

$$X_2 \otimes U \xrightarrow{f} Y_2 \otimes U, X_1 \otimes U \xrightarrow{g} Y_1 \otimes U, X_1 \xrightarrow{a} X_2, Y_1 \xrightarrow{b} Y_2,$$

and point $p : 1 \rightarrow U$, we have:

$$\begin{array}{ccc} X_2 \otimes U & \xrightarrow{f} & Y_2 \otimes U \\ \uparrow a \otimes p & & \uparrow b \otimes p \\ X_1 \otimes 1 & \xrightarrow{g} & Y_1 \otimes 1 \end{array} \quad \text{implies} \quad \begin{array}{ccc} X_2 & \xrightarrow{\text{Tr}_{X_2, Y_2}^U(f)} & Y_2 \\ \uparrow a & & \uparrow b \\ X_1 & \xrightarrow{\text{Tr}_{X_1, Y_1}^1(g)} & Y_1 \end{array}$$

Proof. Define

$$f' = f \circ (a \otimes U) : X_1 \otimes U \rightarrow Y_2 \otimes U \quad \text{and} \quad g' = (b \otimes 1) \circ g : X_1 \otimes 1 \rightarrow Y_2 \otimes 1.$$

Apply Axiom 5 to f' and g' with $X = X_1$ and $Y = Y_2$, then

$$\text{Tr}_{X_1, Y_2}^U(f \circ (a \otimes U)) = \text{Tr}_{X_1, Y_2}^1((b \otimes 1) \circ g).$$

By naturality, the L.H.S (resp. R.H.S) is equal to $\text{Tr}_{X_2, Y_2}^U(f) \circ a$ (resp. $b \circ \text{Tr}_{X_1, Y_1}^1(g)$), which proves the assertion. \square

Observe, strong uniformity of trace implies the original version (Axiom 5) by setting a and b to be the appropriate identity arrows.

- *Generalizing Axiom 2 to the case of m -ary tensors.*

Axiom 2'. *For any natural numbers $m \geq 2$ there is a retraction $U \triangleright_{(k_m, j_m)} U^m$*

$$U \begin{array}{c} \xrightarrow{k_m} \\ \xleftarrow{j_m} \end{array} U^m \quad \text{such that } k_m \circ j_m = \text{Id}_{U^m}.$$

From the coherence of the monoidal structure for (k, j) , we define j_m and k_m , modulo associativity of the monoidal (resp. comonoidal) structure of j (resp. k):

$$j_m = j \circ (j \otimes U) \circ \dots \circ (j \otimes U^{m-1}) \quad k_m = (k \otimes U^{m-1}) \circ \dots \circ (k \otimes U) \circ k$$

Note: *The modulo associativity* assumption above ensures that the representation of j_m and of k_m does not depend on the choice of the definition tree arising from the order of the monoidal j and comonoidal k applications.

When $m = 1$, under the convention that $j_m = U = k_m$, the retraction of 2' becomes the trivial identity. Hence in what follows, (k_m, j_m) is used for any non-zero natural number m . When $m = 2$, we get the original Axiom 2.

- An m -fold tensor version of Axiom 3 : $1^m \otimes 1^m \triangleright_{(!^m, r^m)} 1^m$.

It is straightforward to show the following:

Axiom 3'. $!^m$ has right inverse r^m , i.e. $1^m \otimes 1^m \begin{array}{c} \xrightarrow{!^m} \\ \xleftarrow{r^m} \end{array} 1^m$ satisfying $!^m \circ r^m = \text{Id}_{1^m}$.

Finally, the reader may wonder why, in our definition of polarized GoI situation (Definition 3.1), we introduced opposite directions for the retractions on U and on 1 . This will be explained in Appendix 7.5 below.

3.2 Multipoints in polarized GoI situations

In this section we introduce the key notion of *multipoints* for interpreting the weak exponentials \uparrow and \downarrow (polarity shifting) of MLLP in polarized GoI situations. We then generalize Axioms 6 and 9 of a polarized GoI situation to the level of multipoints. In the following Section 3.3, we shall make use of multipoints to translate polarized formulas, and then extend this to a polarized GoI interpretation of MLLP proofs. This will be used later (in Sections 3.4, 3.5 below) to find new invariants for cut-elimination, and to characterize focussing, hence positivity and negativity, in polarized logics.

Definition 3.5 (points and multipoints)

Multipoints in a polarized GoI situation form a certain class (denoted MIP) of morphisms $1^m \rightarrow U$ for natural numbers m . *Points* are the subclass (denoted \mathbb{P}) of multipoints in which $m = 1$.

First, \mathbb{P} is constructed by the following BNF construction:

$$\mathbb{P} := \alpha \mid j^\circ(\mathbb{P} \otimes 0_{IU}) \mid j^\circ(0_{IU} \otimes \mathbb{P})$$

That is,

- The distinguished point $\alpha : 1 \rightarrow U$ is a point.
- If $\beta : 1 \rightarrow U$ is a point, so are $1 \cong 1 \otimes I \xrightarrow{\beta \otimes 0_{IU}} U \otimes U \xrightarrow{j} U$ and $1 \cong I \otimes 1 \xrightarrow{0_{IU} \otimes \beta} U \otimes U \xrightarrow{j} U$.

Second, MIP is constructed by

$$\text{MIP} := \mathbb{P} \mid j^\circ(\text{MIP} \otimes \text{MIP})$$

That is, while all points are multipoints, the second construction stipulates in addition that

- If $\beta_1 : 1^{m_1} \rightarrow U$ and $\beta_2 : 1^{m_2} \rightarrow U$ are multipoints, so is

$$j \circ (\beta_1 \otimes \beta_2) : 1^{m_1} \otimes 1^{m_2} = 1^{m_1+m_2} \xrightarrow{\beta_1 \otimes \beta_2} U \otimes U \xrightarrow{j} U.$$

Then it follows directly from the construction that each multipoint \mathbf{p} can be written (modulo associativity) as

$$\mathbf{p} : 1^m \xrightarrow{\otimes_{i=1}^m p_i} U^m \xrightarrow{j_m} U$$

using a sequence of points $p_i : 1 \rightarrow U$ with $i = 1, \dots, m$ for a certain natural number m .

Example 3.6 In the Rel model of Example 3.2 where the distinguished α is taken to be a singleton subset $\{n_\alpha\}$ of $U = \mathbb{N}$, a multipoint $1^m \rightarrow U$ (generated by this α) determines a finite indexed family of cardinality m of U .

Later we shall see how polarized formulas can be interpreted in a multipointed setting (Definition 3.12 in Section 3.3 below). Together with a two-layered GoI-interpretation of MLLP proofs (Definition 3.17), this will turn out to be essential in our characterization of focusing (see Proposition 3.25).

We now prove generalizations of Axioms **6** and **9** of a polarized GoI situation to the level of multipoints, using the m -fold setting of **3'**. We call these **Axioms 6'** and **9'** respectively.

Proposition 3.7 (Axiom 6': Lifting Property $U \otimes 1^m \triangleright_{(!_{\mathbf{p}}, r_{\mathbf{p}})} U$ along a multipoint \mathbf{p})

For any multipoint $\mathbf{p} : 1^m \rightarrow U$, there exists a pair $(!_{\mathbf{p}}, r_{\mathbf{p}})$ giving a retraction which lifts the retraction $1^m \otimes 1^m \triangleright_{(!^m, r^m)} 1^m$ along \mathbf{p} . This means the following diagram commutes (in all possible ways), with $!_{\mathbf{p}} \circ r_{\mathbf{p}} = \text{Id}_U$:

$$\begin{array}{ccc} U \otimes 1^m & \xrightarrow{!_{\mathbf{p}}} & U \\ \uparrow \mathbf{p} \otimes 1^m & & \uparrow \mathbf{p} \\ 1^m \otimes 1^m & \xrightarrow{!^m} & 1^m \\ & \xleftarrow{r^m} & \end{array}$$

Proof. See Appendix 7.4 □

The next Proposition discusses the lifted retraction pair $(!_{\mathbf{p}}, r_{\mathbf{p}})$ of the above Axiom **6'**.

Proposition 3.8 (Axiom 9': On the lifted retraction pair $(!_{\mathbf{p}}, r_{\mathbf{p}})$)

For any multipoint $\mathbf{p} : 1^m \rightarrow U$, any morphism $f : V \otimes X \rightarrow W \otimes X$ with $X \in \{U, 1^m\}$ and $0 : 1^m \rightarrow 1^m$,

$$(\text{Id} \otimes !_{\mathbf{p}}) \circ (f \otimes 0) \circ (\text{Id} \otimes r_{\mathbf{p}}) = f \quad \text{and} \quad (\text{Id} \otimes !^m) \circ (f \otimes 0) \circ (\text{Id} \otimes r^m) = f$$

This is illustrated in Figure 1 for the respective equations when $X = U$ and $X = 1^m$.

Proof. Straightforward induction on the construction of \mathbf{p} . □

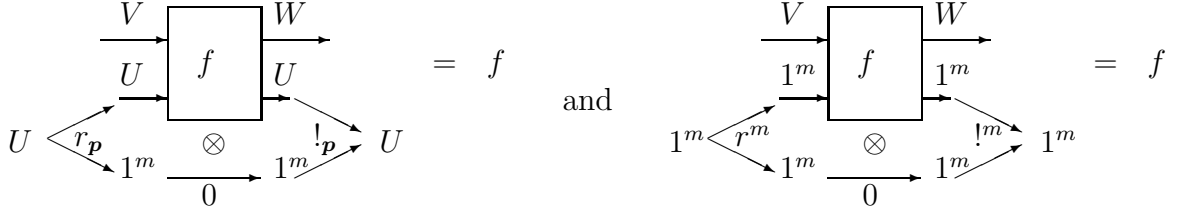

Figure 1: Axiom 9'

The above definition of multipoints is compatible with Axiom 5 (Uniformity of Trace) in Definition 3.1, in the sense that uniformity of trace generalizes to multipoints (see Axiom 5' in Proposition 3.10 below.)

Lemma 3.9 (Invariance of traces under conjugate actions of the retractions)

For any non-zero natural number m and a multipoint $\mathbf{p} : 1^m \rightarrow U$, the retractions (k_m, j_m) and $(l_{\mathbf{p}}, r_{\mathbf{p}})$ respectively act by conjugation on morphisms $f : X \otimes U^m \rightarrow Y \otimes U^m$ and $g : X \otimes U \rightarrow Y \otimes U$ as follows:

$$\begin{aligned} f^{(k_m, j_m)} &:= (X \otimes j_m) \circ f \circ (X \otimes k_m) & : X \otimes U &\rightarrow Y \otimes U \\ g^{(l_{\mathbf{p}}, r_{\mathbf{p}})} &:= (X \otimes r_{\mathbf{p}}) \circ g \circ (X \otimes l_{\mathbf{p}}) & : X \otimes U \otimes 1^m &\rightarrow Y \otimes U \otimes 1^m \end{aligned}$$

Then the following invariant equations hold:

$$\mathrm{Tr}_{X,Y}^{U^m}(f) = \mathrm{Tr}_{X,Y}^U(f^{(k_m, j_m)}) \tag{1}$$

$$\mathrm{Tr}_{X,Y}^U(g) = \mathrm{Tr}_{X,Y}^{U \otimes 1^m}(g^{(l_{\mathbf{p}}, r_{\mathbf{p}})}) \tag{2}$$

The two equations guarantee the invariance of taking traces along U (instead of U^m) and along $U \otimes 1^m$ (instead of $U \otimes 1$).

Proof. See Appendix 7.4 □

The following Axiom 5' generalizes Axiom 5:

Proposition 3.10 (Axiom 5' (Uniformity of Trace on multipoints))

Every multipoint $\mathbf{p} : 1^m \rightarrow U$ satisfies the following condition: for any morphisms f and g ,

$$\begin{array}{ccccc} X \otimes U & \xrightarrow{X \otimes k_m} & X \otimes U^m & \xrightarrow{f} & Y \otimes U^m & \xrightarrow{Y \otimes j_m} & Y \otimes U \\ & \searrow^{X \otimes \mathbf{p}} & & & & & \nearrow^{Y \otimes \mathbf{p}} \\ & & X \otimes 1^m & \xrightarrow{g} & Y \otimes 1^m & & \end{array}$$

commuting implies

$$\mathrm{Tr}_{X,Y}^{1^m}(g) = \mathrm{Tr}_{X,Y}^U(f^{(k_m, j_m)}) = \mathrm{Tr}_{X,Y}^{U^m}(f) .$$

Note:

- (i) The composition of the top horizontal arrows above is $f^{(k_m, j_m)}$ of Lemma 3.9.
- (ii) Axiom 5 is a special case, by setting $m = 1$ and using our convention that $j_1 = U = k_1$.

Proof. We first note that the second equation of the assertion is by (1) of Lemma 3.9.

We prove the assertion by induction on $m \geq 1$; i.e., by induction on the construction of a multipoint $\mathbf{p} : 1^m \rightarrow U$

(Base Case): $m = 1$. The assertion is the original Axiom 5 of Definition 3.1.

(Induction Case for $m + 1$)

The given commutative diagram with $m + 1$ factors as follows from the construction of \mathbf{p} by Definition 3.5.

$$\begin{array}{ccccccc}
 X \otimes U & \xrightarrow{X \otimes k} & X \otimes U \otimes U & \xrightarrow{X \otimes U \otimes k_m} & X \otimes U \otimes U^m & \xrightarrow{f} & Y \otimes U \otimes U^m & \xrightarrow{Y \otimes U \otimes j_m} & Y \otimes U \otimes U & \xrightarrow{Y \otimes j} & Y \otimes U \\
 & \searrow^{X \otimes \mathbf{p}} & & \searrow^{X \otimes \mathbf{p}' \otimes p_{m+1}} & \uparrow^{X \otimes \otimes_{i=1}^{m+1} p_i} & & \uparrow^{Y \otimes \otimes_{i=1}^{m+1} p_i} & & \uparrow^{Y \otimes \mathbf{p}' \otimes p_{m+1}} & & \uparrow^{Y \otimes \mathbf{p}} \\
 & & & & X \otimes 1 \otimes 1^m & \xrightarrow{g} & Y \otimes 1 \otimes 1^m & & & &
 \end{array}$$

$$\text{where } \mathbf{p} = j_{m+1} \circ \otimes_{i=1}^{m+1} p_i \text{ and } \mathbf{p}' = j_m \circ \otimes_{i=1}^m p_i.$$

Suppose the outer trapezium commutes. We note that the inner trapezium commutes by both precomposing $X \otimes U \xleftarrow{X \otimes j} X \otimes U \otimes U$ and postcomposing $Y \otimes U \otimes U \xleftarrow{Y \otimes k} Y \otimes U$ respectively on the top left-most and right-most horizontal arrows, because $k \circ j = \text{Id}_{U \otimes U}$ and since the left and right triangles commute.

Then applying the I.H. to this inner trapezium, we have:

$$\begin{array}{ccc}
 X \otimes U & \xrightarrow{\text{Tr}_{X \otimes U, Y \otimes U}^U(f^{(j_m, k_m)})} & Y \otimes U \\
 \uparrow^{X \otimes p_{m+1}} & & \uparrow^{Y \otimes p_{m+1}} \\
 X \otimes 1 & \xrightarrow{\text{Tr}_{X \otimes 1, Y \otimes 1}^{1^m}(g)} & Y \otimes 1
 \end{array}$$

Note that the top horizontal arrow of the square is $\text{Tr}_{X \otimes U, Y \otimes U}^{U^m}(f)$ by (1).

Then applying the original Axiom 5 (Uniformity of Trace) to the above square, we obtain

$$\text{Tr}_{X, Y}^U(\text{Tr}_{X \otimes U, Y \otimes U}^{U^m}(f)) = \text{Tr}_{X, Y}^1(\text{Tr}_{X \otimes 1, Y \otimes 1}^{1^m}(g))$$

By Vanishing applied to both sides of the equation, we have $\text{Tr}_{X, Y}^{U^{m+1}}(f) = \text{Tr}_{X, Y}^{1^{m+1}}(g)$ \square

As in the case for points in Proposition 3.4, a stronger version of **5'** can be derived for multipoints:

Corollary 3.11 (Strong Uniformity of Trace on multipoints)

Every multipoint $\mathbf{p} : 1^m \rightarrow U$ satisfies the following condition: for any morphisms f, g, a, b ,

$$\begin{array}{ccc}
X_2 \otimes U \xrightarrow{X \otimes km} X_2 \otimes U^m \xrightarrow{f} Y_2 \otimes U^m \xrightarrow{Y \otimes jm} Y_2 \otimes U & & X_2 \xrightarrow{\text{Tr}_{X_2, Y_2}^{U^m}(f)=} Y_2 \\
\swarrow a \otimes p & \text{implies} & \uparrow a \\
X_1 \otimes 1^m \xrightarrow{g} Y_1 \otimes 1^m & & X_1 \xrightarrow{\text{Tr}_{X_1, Y_1}^{1^m}(g)} Y_1 \\
& & \uparrow b
\end{array}$$

Proof. Same as Proposition 3.10, using naturality. \square

3.3 The GoI interpretation of MLLP proofs

We now define one of the central notions of this paper: the GoI interpretation of MLLP proofs in polarized GoI situations. We shall begin with a detailed discussion of how to interpret multipoints of polarized formulas. We then present a categorical approach to GoI in the polarized case, influenced by the categorical approach to ordinary GoI of Haghverdi and Scott[20, 21] in (ordinary) GoI situations, as summarized in Appendix 7.1 below.

Definition 3.12 (Multipoints associated with Formulas) Given a polarized GoI situation and a polarized MLLP formula A , we will inductively construct below a morphism $\text{mp}(A)$ together with its domain $\mathbb{1}_A$ and codomain U_A , where $U_A := U$.

$$\text{mp}(A) : \mathbb{1}_A \longrightarrow U_A.$$

More generally, for a sequence $\mathcal{M} = A_1, \dots, A_n$ of polarized formulas, we will construct a morphism

$$\text{mp}(\mathcal{M}) : \mathbb{1}_{\mathcal{M}} \longrightarrow U_{\mathcal{M}}.$$

from the constructed domain $\mathbb{1}_{\mathcal{M}}$ to the codomain $U_{\mathcal{M}}$. The arrows $\text{mp}(A)$ (resp. $\text{mp}(\mathcal{M})$) defined below are called *the multipoint associated with formula A* (resp. *with sequence \mathcal{M}*).

Construction of multipoints.

First, to each positive (resp. negative) formula P (resp. N) of MLLP, we associate an object $\mathbb{1}_P$ (resp. $\mathbb{1}_N$), which is a tensor product of 1s, defined inductively as follows:

$$\begin{array}{lll}
\mathbb{1}_X := 1 & \mathbb{1}_{P \otimes Q} := \mathbb{1}_P \otimes \mathbb{1}_Q & \mathbb{1}_{\downarrow N} := 1 \\
\mathbb{1}_{X^\perp} := 1 & \mathbb{1}_{N \wp M} := \mathbb{1}_N \otimes \mathbb{1}_M & \mathbb{1}_{\uparrow P} := 1
\end{array}$$

For a sequence $\mathcal{M} = A_1, \dots, A_n$ of polarized formulas, $\mathbb{1}_{\mathcal{M}} := \mathbb{1}_{A_1} \otimes \dots \otimes \mathbb{1}_{A_n}$

Second, with each positive (resp. negative) formula P (resp. N), we associate three objects \mathbf{U}_P, P^D and P^U (resp. \mathbf{U}_N, N^D and N^U) so that

$$U_A \cong A^U \otimes A^D \tag{3}$$

inductively as follows:

$$\begin{array}{lll}
\mathbf{U}_X := U & \mathbf{U}_{P \otimes Q} := \mathbf{U}_P \otimes \mathbf{U}_Q & \mathbf{U}_{\downarrow N} := U \otimes \mathbf{U}_N \\
X^D := I & (P \otimes Q)^D := P^D \otimes Q^D & (\downarrow N)^D := \mathbf{U}_N \\
X^U := U & (P \otimes Q)^U := P^U \otimes Q^U & (\downarrow N)^U := U \\
\\
\mathbf{U}_{X^\perp} := U & \mathbf{U}_{N \wp M} := \mathbf{U}_N \otimes \mathbf{U}_M & \mathbf{U}_{\uparrow P} := \mathbf{U}_P \otimes U \\
(X^\perp)^D := I & (N \wp M)^D := N^D \otimes M^D & (\uparrow P)^D := \mathbf{U}_P \\
(X^\perp)^U := U & (N \wp M)^U := N^U \otimes M^U & (\uparrow P)^U := U
\end{array}$$

All these objects are isomorphic to tensor products of U s. For a sequence $\mathcal{M} = A_1, \dots, A_n$ of polarized formulas, we define the object $\mathbf{U}_{\mathcal{M}} := \mathbf{U}_{A_1} \otimes \dots \otimes \mathbf{U}_{A_n}$ and for $\star \in \{D, U\}$, we define the object $\mathcal{M}^\star := A_1^\star \otimes \dots \otimes A_n^\star$.

Note that the following hold for any polarized formula A .

- If A is a literal, $U_A = \mathbf{U}_A$. Otherwise,

$$U_A \triangleright_{(k_a, j_a)} \mathbf{U}_A \quad (4)$$

where a is a certain natural number determined by the length of A , as in Axiom **2'**.

- There exists a natural number m such that

$$A^U \cong U^m \quad \text{and} \quad \mathbb{1}_A \cong 1^m \quad (5)$$

Finally, using (3), (4) and (5), we define $\mathbf{mp}(A)$ by the following composition:

$$\mathbf{mp}(A) : \mathbb{1}_A \xrightarrow{\alpha^m} A^U \cong A^U \otimes I \xrightarrow{A^U \otimes 0_{I, A^D}} A^U \otimes A^D \cong \mathbf{U}_A \xrightarrow{j_a} U_A \quad (6)$$

and in the case of a sequence $\mathcal{M} = A_1, \dots, A_n$,

$$\mathbf{mp}(\mathcal{M}) := \mathbf{mp}(A_1) \otimes \dots \otimes \mathbf{mp}(A_n) : \mathbb{1}_{\mathcal{M}} \longrightarrow U_{\mathcal{M}}. \quad (7)$$

Remark 3.13 Multipoints $\mathbf{mp}(A)$ can be inductively defined as follows, where the first, second and third constructions correspond respectively to 1, 2 and 3 of Definition 3.5:

- $\mathbf{mp}(X) := \alpha$ and $\mathbf{mp}(X^\perp) := \alpha$
- $\mathbf{mp}(\downarrow N) := j^\circ(\alpha \otimes 0_{I, U_N})$ and $\mathbf{mp}(\uparrow P) := j^\circ(0_{I, U_P} \otimes \alpha)$.
- $\mathbf{mp}(P \otimes Q) := j^\circ(\mathbf{mp}(P) \otimes \mathbf{mp}(Q))$ and $\mathbf{mp}(N \wp M) := j^\circ(\mathbf{mp}(N) \otimes \mathbf{mp}(M))$.

In what follows, we make the convention that U_\downarrow (resp. U_\uparrow) denotes the codomain U of α in the above construction of $\mathbf{mp}(\downarrow N)$ (resp. of $\mathbf{mp}(\uparrow P)$). That is, U_\downarrow (resp. U_\uparrow) denotes U of $(\downarrow N)^U$ (resp. of $(\uparrow P)^U$).

Example 3.14 In the Rel polarized GoI situation,

- $\mathbb{1}_{\uparrow X} = 1 = \{n_\alpha\}$ and $\mathbf{mp}(\uparrow X) : 1 \cong I + 1 \xrightarrow{0 \otimes \alpha} U_X + U_\uparrow \xrightarrow{j} U_{\uparrow X}$ is a singleton subset consisting of the element $j((2, n_\alpha)) = 2n_\alpha + 1 \in \mathbb{N}$.
- $\mathbb{1}_{Y^\perp \wp X^\perp} = 1^2 = \{n_\alpha\} + \{n_\alpha\}$ and $\mathbf{mp}(Y^\perp \wp X^\perp) : 1^2 \xrightarrow{\alpha^2} U_{Y^\perp} + U_{X^\perp} \xrightarrow{j} U_{Y^\perp \wp X^\perp}$ is a subset of cardinality 2 consisting of the elements $j((1, n_\alpha)) = 2n_\alpha$ and $j((2, n_\alpha)) = 2n_\alpha + 1$ in \mathbb{N} .

Definition 3.15 (retractions $(!_A, r_A)$ and $(\hat{!}_A, \hat{r}_A)$) For a polarized formula A , we define two morphisms r_A and $!_A$ to give a retraction

$$A^U \otimes \mathbb{1}_A \triangleright_{(!_A, r_A)} A^U \quad \text{so that } !_A \circ r_A = A^U.$$

These are defined inductively on A as follows:

r_X and r_{X^\perp} are r_α , $r_{P \otimes Q} := r_P \otimes r_Q$, $r_{N \wp M} := r_N \otimes r_M$, $r_{\downarrow N}$ and $r_{\uparrow P}$ are r_α ,
 $!_X$ and $!_{X^\perp}$ are $!_\alpha$, $!_{P \otimes Q} := !_P \otimes !_Q$, $!_{N \wp M} := !_N \otimes !_M$, $!_{\downarrow N}$ and $r_{\uparrow N}$ are $!_\alpha$.

For a sequence $\mathcal{M} = A_1, \dots, A_n$ of polarized formulas, define $r_{\mathcal{M}}$ (resp. $!_{\mathcal{M}}$) to be $r_{A_1} \otimes \dots \otimes r_{A_n}$ (resp. $!_{A_1} \otimes \dots \otimes !_{A_n}$).

Using the canonical isomorphism (3), we define $\hat{!}_A := !_A \otimes A^D$ and $\hat{r}_A := r_A \otimes A^D$. This gives the retraction

$$U_A \otimes \mathbb{1}_A \triangleright_{(\hat{!}_A, \hat{r}_A)} U_A \quad \text{satisfying } \hat{!}_A \circ \hat{r}_A = U_A$$

The same definitions as above also apply for $\hat{!}_{\mathcal{M}}$ and $\hat{r}_{\mathcal{M}}$ for a sequence \mathcal{M} .

Then the lifting property (Axiom 6' of Proposition 3.7) has the following variant:

Proposition 3.16 (Lifting property $A^U \otimes \mathbb{1}_A \triangleright_{(!_A, r_A)} A^U$ along α^m)

Suppose m is a natural number satisfying (5). Then $(!_A, r_A)$ gives a retraction which lifts the retraction $\mathbb{1} \otimes \mathbb{1} \triangleright_{(!^m, r^m)} \mathbb{1}$ along α^m . This means the following diagram commutes with $!_A \circ r_A = \text{Id}_{A^U}$.

$$\begin{array}{ccc} A^U \otimes \mathbb{1}_A & \begin{array}{c} \xrightarrow{!_A} \\ \xleftarrow{r_A} \end{array} & A^U \\ \alpha^m \otimes \mathbb{1}^m \uparrow & & \uparrow \alpha^m \\ \mathbb{1}_A \otimes \mathbb{1}_A & \begin{array}{c} \xrightarrow{!^m} \\ \xleftarrow{r^m} \end{array} & \mathbb{1}_A \end{array}$$

Proof. Straightforward by noting that composing the right (resp. left) vertical arrow with the second and third maps of (6) (resp. \otimes^m of these maps) gives rise to Axiom 6'. \square

In what follows, we introduce the GoI interpretation for MLLP. The original GoI situations in Abramsky, et. al. [1] (summarized in Appendix 7.1 below) form a very basic framework for interpreting GoI. For example, their exponential structure, which is sufficient for defining linear combinatory algebras on $\text{End}_{\mathcal{C}}(U)$, for a reflexive object U , does not include the more elaborate categorical structure of the exponentials (e.g. cocommutative coalgebras, comonoids, etc.) in genuine models of linear logic [40].

Recall that the GoI interpretation of an MLL proof π of the sequent $\vdash [\Delta], \Gamma$ in an (ordinary) GoI situation \mathcal{C} yields an endomorphism $\llbracket \pi \rrbracket \in \text{End}_{\mathcal{C}}(U^{2m+n})$, for the reflexive object U . We now introduce the analog for the polarized case of MLLP.

Let us sketch the framework, before going into details. Consider a *polarized* GoI situation \mathcal{C} , with a reflexive object U and an object 1 . The *polarized GoI Interpretation* in Definition 3.17 below will yield a *pair* of endomorphisms, $(\llbracket \pi \rrbracket, f_\pi) \in \text{End}_{\mathcal{C}}(U^{2m+n}) \times \text{End}_{\mathcal{C}}(1^{2m'+n'})$.

We think of the two endomorphisms as layers: an “upper” and a “lower” GoI interpretation.

- The *upper* interpretation, $\llbracket \pi \rrbracket \in \text{End}_{\mathcal{C}}(U^{2m+n})$, is on the level of the reflexive object U . It is analogous to the non-polarized GoI interpretation, using the polarized retraction structure $U \triangleright U \otimes U$ for coding “untyped” GoI, by folding tensors of U 's into a single

U . Here U^{2m+n} comes from $U_{\Delta, \Gamma}$ of Definition 3.12; n (resp. $2m$) is the number of formulas in Γ (resp. Δ). At this level, the polarity will be handled by the retraction $U \otimes 1 \triangleright U$. Hence, both the retraction structures 3 and 6 of Definition 3.1 are used.

- The *lower* interpretation, $f_\pi \in \text{End}_{\mathcal{C}}(1^{2m'+n'})$, is a similar GoI formula to $\llbracket \pi \rrbracket$, but without assuming any reflexivity on 1. It is defined on the level of multipoints. Here $1^{2m'+n'}$ comes from $\mathbb{1}_{\Delta, \Gamma}$ of Definition 3.12; n' (resp. $2m'$) is the sum, over formulas in Γ (resp. Δ), of the number of MLLP logical connectives (including literals) not bounded by polarity shifting operations. At this level, the polarity will be handled by the retraction $1 \otimes 1 \triangleright 1$. Hence, only retraction 3 of Definition 3.1 is used.

Definition 3.17 (The two-layered Polarized GoI interpretation of MLLP proofs) An MLLP proof π of $\vdash [\Delta], \Gamma$ is interpreted by two endomorphisms

$$\llbracket \pi \rrbracket \in \mathcal{C}(U_{\Delta, \Gamma}, U_{\Delta, \Gamma}) \quad \text{and} \quad f_\pi \in \mathcal{C}(\mathbb{1}_{\Delta, \Gamma}, \mathbb{1}_{\Delta, \Gamma})$$

We see the polarized view as a *two-layered interpretation*: an *upper* layer $\llbracket \pi \rrbracket$ at the level of reflexive objects U , a *lower* layer f_π at the level of multipoints 1.

We define simultaneously ⁴ $\llbracket \pi \rrbracket$ and f_π by induction on π .

1. (*Axiom*): π is $\vdash P^\perp, P$.

Remember that $U_P = U_{P^\perp} = U$ and $\mathbb{1}_P \cong \mathbb{1}_{P^\perp} := 1^n$ for a certain natural number n .

$$\begin{aligned} \llbracket \pi \rrbracket &:= s_{U, U} : U_P \otimes U_{P^\perp} \longrightarrow U_P \otimes U_{P^\perp} \\ f_\pi &:= s_{1^n, 1^n} : \mathbb{1}_P \otimes \mathbb{1}_{P^\perp} \longrightarrow \mathbb{1}_P \otimes \mathbb{1}_{P^\perp} \end{aligned}$$

where

$$s_{U, U} = \begin{array}{ccc} U_P & & U_P \\ & \nearrow & \searrow \\ & U_{P^\perp} & \\ & \nwarrow & \nearrow \\ U_{P^\perp} & & U_{P^\perp} \end{array} \quad \text{and} \quad s_{1^n, 1^n} = \begin{array}{ccc} \mathbb{1}_P & & \mathbb{1}_P \\ & \nearrow & \searrow \\ & \mathbb{1}_{P^\perp} & \\ & \nwarrow & \nearrow \\ \mathbb{1}_{P^\perp} & & \mathbb{1}_{P^\perp} \end{array}$$

Each arrow consisting of the crossing $s_{1^n, 1^n}$ denotes the permutation (between factors of the tensor foldings $\mathbb{1}_P$ and $\mathbb{1}_{P^\perp}$) which is induced by De Morgan duality between polarized formulas P and P^\perp .

2. (*Cut*): π is
$$\frac{\begin{array}{c} \vdots \pi' \\ \vdash [\Delta'], P, \mathcal{N} \end{array} \quad \begin{array}{c} \vdots \pi'' \\ \vdash [\Delta''], P^\perp, \Xi \end{array}}{\vdash [\Delta', \Delta'', P, P^\perp], \mathcal{N}, \Xi} \text{ cut}$$

We define

$$\llbracket \pi \rrbracket := \tau^-(\llbracket \pi' \rrbracket \otimes \llbracket \pi'' \rrbracket) \tau \quad f_\pi := \tau^-(f_{\pi'} \otimes f_{\pi''}) \tau$$

where τ denotes the indicated exchange for the conclusions and the cut-formulas. Here τ and its inverse τ^- are simply permutations of the interface (denoted by $U_{(\)}$ and $\mathbb{1}_{(\)}$). See the following:

⁴**Notation:** In Appendix 7.1 for traditional GoI, (e.g., see Figure 6), we illustrate proofs of sequents $\vdash [\Delta], \Gamma$ as I/O boxes with labelled wires as interface. In what follows below, for typographical reasons, we often omit the wires and just write I/O labels for the interface (e.g. see the Cut-Rule below.)

On the I/O box, interface formulas are ordered (from top to bottom) as follows: first, the unique focused (positive) formula (if it exists), then the negative formulas, and finally the sequence Δ of cut formulas.

$$\llbracket \pi \rrbracket := \begin{array}{c} U_{\Xi} \\ U_{\mathcal{N}} \\ U_P \\ U_{P^\perp} \\ U_{\Delta'} \\ U_{\Delta''} \end{array} \left[\begin{array}{c} U_P \\ U_{\mathcal{N}} \\ U_{\Delta'} \\ U_{P^\perp} \\ U_{\Delta''} \end{array} \right] \begin{array}{c} \boxed{\llbracket \pi' \rrbracket} \\ \otimes \\ \boxed{\llbracket \pi'' \rrbracket} \end{array} \begin{array}{c} U_P \\ U_{\mathcal{N}} \\ U_{\Delta'} \\ U_{P^\perp} \\ U_{\Delta''} \end{array} \left[\begin{array}{c} U_{\Xi} \\ U_{\mathcal{N}} \\ U_P \\ U_{P^\perp} \\ U_{\Delta'} \\ U_{\Delta''} \end{array} \right] \tau$$

$$f_\pi := \begin{array}{c} \mathbb{1}_{\Xi} \\ \mathbb{1}_{\mathcal{N}} \\ \mathbb{1}_P \\ \mathbb{1}_{P^\perp} \\ \mathbb{1}_{\Delta'} \\ \mathbb{1}_{\Delta''} \end{array} \left[\begin{array}{c} \mathbb{1}_P \\ \mathbb{1}_{\mathcal{N}} \\ \mathbb{1}_{\Delta'} \\ \mathbb{1}_{P^\perp} \\ \mathbb{1}_{\Delta''} \end{array} \right] \begin{array}{c} \boxed{f_{\pi'}} \\ \otimes \\ \boxed{f_{\pi''}} \end{array} \begin{array}{c} \mathbb{1}_P \\ \mathbb{1}_{\mathcal{N}} \\ \mathbb{1}_{\Delta'} \\ \mathbb{1}_{P^\perp} \\ \mathbb{1}_{\Delta''} \end{array} \left[\begin{array}{c} \mathbb{1}_{\Xi} \\ \mathbb{1}_{\mathcal{N}} \\ \mathbb{1}_P \\ \mathbb{1}_{P^\perp} \\ \mathbb{1}_{\Delta'} \\ \mathbb{1}_{\Delta''} \end{array} \right] \tau$$

In the following cases, we define $\llbracket \pi \rrbracket^\dagger \in \mathcal{C}(\mathbf{U}_{\Delta, \Gamma}, \mathbf{U}_{\Delta, \Gamma})$ so that $\llbracket \pi \rrbracket = j_a \circ \llbracket \pi \rrbracket^\dagger \circ k_a$, where j_a and k_a are the retractions for $\mathbf{U}_{\Delta, \Gamma} \triangleright_{(k_a, j_a)} \mathbf{U}_{\Delta, \Gamma}$ in equation (4) of the construction of multipoints after Definition 3.12.

3. (*Linear Connectives*): For a \mathfrak{A} -rule, the interpretation remains that of the premise proof. For a \otimes -rule, the interpretations are the same as those of the cut-rule defined above. To be precise:

(\mathfrak{A} rule) We define

$$\llbracket \pi \rrbracket^\dagger = \llbracket \pi' \rrbracket^\dagger \quad \text{and} \quad f_\pi = f_{\pi'}$$

(\otimes rule) We define

$$\llbracket \pi \rrbracket^\dagger = \tau^- \llbracket \pi' \rrbracket^\dagger \tau \quad \text{and} \quad f_\pi = \tau^- f_{\pi'} \tau,$$

where τ for $\llbracket \pi \rrbracket^\dagger$ (resp. for f_π) is $\mathbf{U}_P \otimes \mathbf{U}_Q \otimes \mathbf{U}_{\Gamma'} \otimes \mathbf{U}_{\Gamma''} \otimes \mathbf{U}_{\Delta'} \otimes \mathbf{U}_{\Delta''} \longrightarrow \mathbf{U}_P \otimes \mathbf{U}_{\Gamma'} \otimes \mathbf{U}_{\Delta'} \otimes \mathbf{U}_Q \otimes \mathbf{U}_{\Gamma''} \otimes \mathbf{U}_{\Delta''}$ (resp. $\mathbb{1}_P \otimes \mathbb{1}_Q \otimes \mathbb{1}_{\Gamma'} \otimes \mathbb{1}_{\Gamma''} \otimes \mathbb{1}_{\Delta'} \otimes \mathbb{1}_{\Delta''} \longrightarrow \mathbb{1}_P \otimes \mathbb{1}_{\Gamma'} \otimes \mathbb{1}_{\Delta'} \otimes \mathbb{1}_Q \otimes \mathbb{1}_{\Gamma''} \otimes \mathbb{1}_{\Delta''}$).

Note that in the above Cases 1 - 3, $\llbracket \pi \rrbracket^\dagger$ and f_π are defined in the same way: replace \mathbf{U} 's by $\mathbb{1}$'s. However this is no longer true in the following Cases 4 and 5 (cf. the paragraph above Definition 3.17).

4. (*Polarity Changing* \uparrow):

$$\pi \text{ is } \frac{\vdots \pi'}{\vdash [\Delta], \mathcal{M}, P} \uparrow$$

We define

$$\begin{aligned} \llbracket \pi \rrbracket^\dagger &= 0_{U, U} \otimes \llbracket \pi' \rrbracket^\dagger \quad \text{with } 0_{U, U} : U_\uparrow \longrightarrow U_\uparrow. \\ f_\pi &= 0 \otimes ((0_{\mathbb{1}_P, I} \otimes \mathbb{1}_{\mathcal{M}} \otimes \mathbb{1}_{\Delta}) \circ f_{\pi'} \circ (0_{I, \mathbb{1}_P} \otimes \mathbb{1}_{\mathcal{M}} \otimes \mathbb{1}_{\Delta})) \quad \text{with } 0 : 1 \longrightarrow 1. \end{aligned}$$

See the following:

$$\llbracket \pi \rrbracket^\dagger := \begin{array}{c} U_\uparrow \\ \otimes \\ U_P \\ U_{\mathcal{M}} \\ U_{\Delta} \end{array} \xrightarrow{\begin{array}{c} 0_{U, U} \\ \otimes \end{array}} \begin{array}{c} U_\uparrow \\ \otimes \\ U_P \\ U_{\mathcal{M}} \\ U_{\Delta} \end{array} \left[\begin{array}{c} \boxed{\llbracket \pi' \rrbracket^\dagger} \end{array} \right] \begin{array}{c} U_P \\ U_{\mathcal{M}} \\ U_{\Delta} \end{array}$$

$$f_\pi := \begin{array}{c} \mathbb{1}_{\uparrow P} \\ \otimes \\ I \end{array} \xrightarrow{\begin{array}{c} 0_{I, \mathbb{1}_P} \\ \otimes \end{array}} \begin{array}{c} \mathbb{1}_P \\ \mathbb{1}_{\mathcal{M}} \\ \mathbb{1}_{\Delta} \end{array} \left[\begin{array}{c} \boxed{f_{\pi'}} \end{array} \right] \begin{array}{c} \mathbb{1}_P \\ \mathbb{1}_{\mathcal{M}} \\ \mathbb{1}_{\Delta} \end{array} \xrightarrow{\begin{array}{c} 0_{\mathbb{1}_P, I} \\ \otimes \end{array}} I$$

5. (*Polarity Changing* \downarrow):

$$\pi \text{ is } \frac{\vdots \pi'}{\vdash [\Delta], \mathcal{M}, N} \downarrow \frac{}{\vdash [\Delta], \mathcal{M}, \downarrow N}$$

For the interpretation of this case, $r_{\mathcal{M}}$ and $!_{\mathcal{M}}$ of Definition 3.15 are used. We assume $\mathbb{1}_{\mathcal{M}} = 1^m$ for a natural number m . Depending on the value of m , two morphisms g_m and h_m are defined as follows, modulo associativity of the monoidal (resp. comonoidal) structure of j (resp. k) (cf. Axiom 2⁵): let

$$g_m := (! \otimes 1^{m-2}) \circ \dots \circ (! \otimes 1) \circ ! \quad \text{and} \quad h_m := (r \otimes 1^{m-2}) \circ \dots \circ (r \otimes 1) \circ r \quad (8)$$

to yield a retraction $1^m \triangleright_{(g_m, h_m)} 1$. When m is 1, both g_m and h_m are defined to be Id_1 .

In what follows, $\hat{\circ}$ denotes composition modulo permutation of \otimes .⁵ For an exchange τ of the interface, the conjugate actions $(\)^\tau$ and ${}^\tau(\)$ are defined as follows: $x^\tau = (\tau^- \otimes 1^m) \circ x \circ \tau$ and ${}^\tau x = \tau^- \circ x \circ (\tau \otimes 1^m)$.

We define:

$$\llbracket \pi \rrbracket^\dagger := \theta^- \hat{\circ} (h_m \otimes \llbracket \pi' \rrbracket^\dagger \otimes g_m) \hat{\circ} \theta,$$

where $\theta^- = \alpha \otimes {}^\tau(\mathbf{U}_N \otimes \mathbf{U}_\Delta \otimes \mathcal{M}^D \otimes !_{\mathcal{M}})$ and $\theta = \alpha^* \otimes (\mathbf{U}_N \otimes \mathbf{U}_\Delta \otimes \mathcal{M}^D \otimes r_{\mathcal{M}})^\tau$.

See the following:

$$\begin{array}{c} \mathbf{U}_{\downarrow N} \cong \begin{array}{c} U \\ \otimes \\ \mathbf{U}_N \end{array} \xrightarrow{\alpha^*} 1 \xrightarrow{h_m} 1^m \xrightarrow{\alpha} U \\ \llbracket \pi \rrbracket^\dagger := \mathbf{U}_{\mathcal{M}} \cong \begin{array}{c} \mathcal{M}^U \\ \otimes^D \\ \mathcal{M}^D \\ \otimes \\ \mathbf{U}_\Delta \end{array} \begin{array}{c} \tau \\ \left[\begin{array}{c} \mathbf{U}_N \dots \mathbf{U}_N \\ \mathbf{U}_\Delta \dots \mathbf{U}_\Delta \\ \mathcal{M}^U \dots \mathcal{M}^U \\ \mathcal{M}^D \dots \mathcal{M}^D \end{array} \right] \\ \tau \end{array} \xrightarrow{r_{\mathcal{M}}} \begin{array}{c} \mathbf{U}_N \dots \mathbf{U}_N \\ \mathbf{U}_\Delta \dots \mathbf{U}_\Delta \\ \mathcal{M}^U \dots \mathcal{M}^U \\ \mathcal{M}^D \dots \mathcal{M}^D \end{array} \xrightarrow{\otimes} 1 \xrightarrow{g_m} 1 \xrightarrow{!_{\mathcal{M}}} \begin{array}{c} \mathbf{U}_N \dots \mathbf{U}_N \\ \mathbf{U}_\Delta \dots \mathbf{U}_\Delta \\ \mathcal{M}^U \dots \mathcal{M}^U \\ \mathcal{M}^D \dots \mathcal{M}^D \end{array} \begin{array}{c} \left[\begin{array}{c} \mathbf{U}_N \dots \mathbf{U}_N \\ \mathbf{U}_\Delta \dots \mathbf{U}_\Delta \\ \mathcal{M}^U \dots \mathcal{M}^U \\ \mathcal{M}^D \dots \mathcal{M}^D \end{array} \right] \\ \tau^- \end{array} \end{array}$$

We define:

$$f_\pi := \eta^- \hat{\circ} (h_m \otimes f_{\pi'} \otimes g_m) \hat{\circ} \eta$$

where $\eta^- = 1 \otimes 0_{\mathbb{1}_N, I} \otimes \rho(\mathbb{1}_\Delta \otimes !^m)$ and $\eta = 1 \otimes 0_{I, \mathbb{1}_N} \otimes (\mathbb{1}_\Delta \otimes r^m)^\rho$.

See the following:

⁵That is, in composing two maps between tensors of objects, the matching of the codomain of one with the domain of the other is only up to permutation of the tensor factors.

$$\begin{array}{c}
\mathbb{1}_{\downarrow N} \cong \begin{array}{c} 1 \\ \otimes \\ I \end{array} \xrightarrow{\dots} 1 \xrightarrow{h_m} 1^m \xrightarrow{\dots} 1 \\
\mathbb{1}_{\downarrow N} \xrightarrow{0_{I, \mathbb{1}_N}} \mathbb{1}_N \xrightarrow{0_{\mathbb{1}_N, I}} I \\
f_\pi := \begin{array}{c} \mathbb{1}_{\mathcal{M}} = 1^m \left[\begin{array}{c} \rho \\ \mathbb{1}_\Delta \end{array} \right] \mathbb{1}_\Delta \dots \left[\begin{array}{c} \rho^- \\ \mathbb{1}_\Delta \end{array} \right] \mathbb{1}_{\mathcal{M}} \left[\begin{array}{c} f_{\pi'} \\ \mathbb{1}_\Delta \end{array} \right] \mathbb{1}_{\mathcal{M}} \dots \left[\begin{array}{c} \rho \\ \mathbb{1}_\Delta \end{array} \right] \mathbb{1}_\Delta \dots \left[\begin{array}{c} \rho^- \\ \mathbb{1}_\Delta \end{array} \right] 1^m \\
\mathbb{1}_\Delta \left[\begin{array}{c} \rho \\ \mathbb{1}_\Delta \end{array} \right] 1^m \xrightarrow{\gamma^m} 1^m \dots 1^m \xrightarrow{\otimes} 1 \xrightarrow{g_m} 1 \dots 1^m \xrightarrow{!^m} 1^m \left[\begin{array}{c} \rho^- \\ \mathbb{1}_\Delta \end{array} \right] \mathbb{1}_\Delta \end{array}
\end{array}$$

Example 3.18 ($\llbracket \pi \rrbracket$ and f_π of Definition 3.17) The following two examples are interpretations of proofs in the GoI situation Rel of Example 3.2 and Example 3.14, in which α is identified with the singleton subset $\{n_\alpha\}$ of $\mathbb{N} = U$. In the following, matrices are UDC representations of Rel morphisms (see Appendix 7.2), the blank elements denote 0 morphisms (i.e., empty relations) of appropriate types and g_m and h_m are from (8).

(i) Let π be the unique cut-free proof for $\vdash \downarrow X^\perp, \uparrow X$ (the η -expansion of $\vdash X^\perp, X$). The side formula of the \downarrow -rule of π is $\uparrow X$ so that $\mathbb{1}_{\uparrow X} = 1$. It also holds that $\mathbb{1}_{\downarrow X^\perp} = 1$.

Then

$$\llbracket \pi \rrbracket^\dagger = \begin{array}{c} U_\downarrow \\ U_{X^\perp} \\ U_X \\ U_\uparrow \end{array} \left(\begin{array}{ccc} U_\downarrow & U_{X^\perp} & U_X \\ & \text{Id}_U & \text{Id}_U \\ & & \{(n_\alpha, n_\alpha)\} \end{array} \right) \text{ and } f_\pi = \begin{array}{c} \mathbb{1}_{\downarrow X^\perp} \\ \mathbb{1}_{\uparrow X} \end{array} \left(\begin{array}{cc} \mathbb{1}_{\downarrow X^\perp} & \mathbb{1}_{\uparrow X} \\ \text{Id}_1 & \text{Id}_1 \end{array} \right).$$

They are obtained respectively from

$$\begin{array}{c} U_\downarrow \\ U_{X^\perp} \\ U_X \\ U_\uparrow \\ 1 \end{array} \left(\begin{array}{ccccc} U_\downarrow & U_{X^\perp} & U_X & U_\uparrow & 1 \\ & & \text{Id}_U & & \alpha \circ g_1 \\ & \text{Id}_U & & & \\ & & & & \\ h_1 \circ \alpha^* & & & & \end{array} \right) \text{ and } \begin{array}{c} \mathbb{1}_{\downarrow X^\perp} \\ \mathbb{1}_{\uparrow X} \\ 1 \end{array} \left(\begin{array}{ccc} \mathbb{1}_{\downarrow X^\perp} & \mathbb{1}_{\uparrow X} & 1 \\ & & g_1 \\ h_1 & & \end{array} \right)$$

when contracting the last two columns (resp. rows) respectively by $r_{\uparrow X}$ (resp. $!_{\uparrow X}$) and by r (resp. $!$).

(ii) Let π be the unique cut-free proof for $\vdash \downarrow \uparrow (X \otimes Y), Y^\perp \wp X^\perp$.

The side formula of the \downarrow -rule of π is $Y^\perp \wp X^\perp$ so that $\mathbb{1}_{Y^\perp \wp X^\perp} = 1^2$. Both $\mathbb{1}_{\uparrow(X \otimes Y)}$ and $\mathbb{1}_{\downarrow(X \otimes Y)}$ are 1. Note that $\mathbf{U}_{Y^\perp \wp X^\perp} = (Y^\perp \wp X^\perp)^U = U + U$.

Then

$$\llbracket \pi \rrbracket^\dagger = \begin{array}{c} U_\uparrow \\ \mathbf{U}_{Y^\perp \wp X^\perp} \end{array} \left(\begin{array}{cc} U_\downarrow & \mathbf{U}_{X \otimes Y} \\ \{(n_\alpha, n_\alpha)\} & \text{Id}_{U+U} \\ +\{(n_\alpha, n_\alpha)\} & \end{array} \right) \otimes \begin{array}{c} U_\downarrow \\ \mathbf{U}_{X \otimes Y} \end{array} \left(\begin{array}{c} U_\uparrow \\ \mathbf{U}_{Y^\perp \wp X^\perp} \\ \{(n_\alpha, n_\alpha)\} \\ +\{(n_\alpha, n_\alpha)\} \\ \text{Id}_{U+U} \end{array} \right)$$

and

$$f_\pi = \begin{array}{c} \mathbb{1}_{\Downarrow(X \otimes Y)} \quad \mathbb{1}_{Y^\perp \wp X^\perp} \\ \mathbb{1}_{Y^\perp \wp X^\perp} \left(\begin{array}{c} \text{Id}_1 + \text{Id}_1 \\ \text{Id}_1 + \text{Id}_1 \end{array} \right) \end{array}.$$

They are obtained respectively from

$$\begin{array}{c} U_\downarrow \\ \mathbf{U}_{X \otimes Y} \\ U_\uparrow \\ \mathbf{U}_{Y^\perp \wp X^\perp} \\ 1^2 \end{array} \left(\begin{array}{c} U_\downarrow \quad \mathbf{U}_{X \otimes Y} \quad U_\uparrow \quad \mathbf{U}_{Y^\perp \wp X^\perp} \quad 1^2 \\ \alpha \circ g_2 \\ \text{Id}_{U+U} \\ \text{Id}_{U+U} \\ h_2 \circ \alpha^* \end{array} \right) \text{ and } \begin{array}{c} \mathbb{1}_{\Downarrow(X \otimes Y)} \quad \mathbb{1}_{Y^\perp \wp X^\perp} \quad 1^2 \\ \mathbb{1}_{Y^\perp \wp X^\perp} \\ 1^2 \end{array} \left(\begin{array}{c} \mathbb{1}_{\Downarrow(X \otimes Y)} \quad \mathbb{1}_{Y^\perp \wp X^\perp} \quad 1^2 \\ g_2 \\ h_2 \end{array} \right)$$

when contracting the last two columns (resp. rows) respectively by $r_{Y^\perp \wp X^\perp}$ (resp. $!_{Y^\perp \wp X^\perp}$) and by r^2 (resp. $!^2$).

Remark 3.19 (On degenerate GoI situations) In Example 3.3, we noted that the two polarized GoI situations Pfn and Plnj are degenerate. We can now say why we chose this terminology. The reader can check that in both Pfn and Plnj, the interpretation above of the polarity-changing rule \downarrow has no effect; that is, $\llbracket \pi \rrbracket = \llbracket \pi' \rrbracket$ for the conclusion of this rule. This is definitely *not* the case in the Rel model.

Definition 3.20 (Polarized Execution formulas) Let $\sigma = \otimes^m s$, the m -fold tensor product of the symmetry $s = s_{U,U}$, and $\sigma_* = \otimes_{i=1}^m s_i$ where each s_i is the symmetry $s_{1^{\ell_i}, 1^{\ell_i}}$ for certain ℓ_i . The s corresponds to the permutation between dual cut formulas so that $U = U_P = U_{P^\perp}$ and the s_i corresponds to the permutation induced by De Morgan duality for dual cut formulas so that $1^{\ell_i} \cong \mathbb{1}_P \cong \mathbb{1}_{P^\perp}$. Then *polarized execution formulas* are defined both on $\llbracket \pi \rrbracket$ and on f_π as follows:

$$\begin{aligned} \text{Ex}(\llbracket \pi \rrbracket, \sigma) &:= \text{Tr}_{U_\Gamma, U_\Gamma}^{U_\Delta} ((\text{Id}_{U_\Gamma} \otimes \sigma) \circ \llbracket \pi \rrbracket) = \text{Tr}_{U^n, U^n}^{U^{2m}} ((\text{Id}_{U^n} \otimes \sigma) \circ \llbracket \pi \rrbracket) \\ \text{Ex}(f_\pi, \sigma_*) &:= \text{Tr}_{\mathbb{1}_\Gamma, \mathbb{1}_\Gamma}^{\mathbb{1}_\Delta} ((\text{Id}_{\mathbb{1}_\Gamma} \otimes \sigma_*) \circ f_\pi) = \text{Tr}_{1^{n'}, 1^{n'}}^{1^{2m'}} ((\text{Id}_{1^{n'}} \otimes \sigma_*) \circ f_\pi) \end{aligned}$$

Note: $\text{Ex}(\llbracket \pi \rrbracket, \sigma) \in \text{End}_C(U_\Gamma) = \text{End}_C(U^n)$ and $\text{Ex}(f_\pi, \sigma_*) \in \text{End}_C(\mathbb{1}_\Gamma) = \text{End}_C(1^{n'})$, as pictured below.

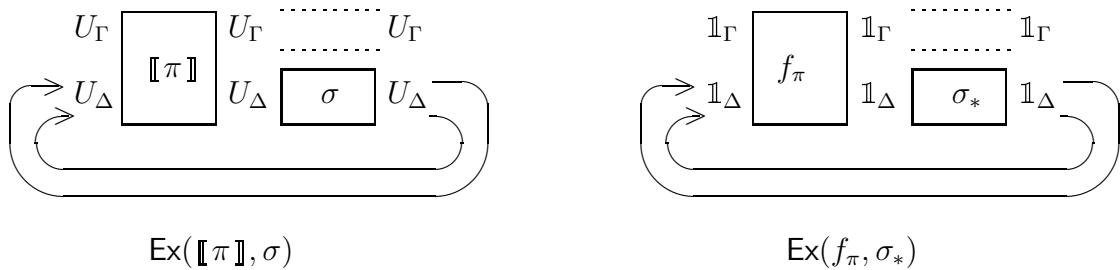

Figure 2: Execution Formulas on $\llbracket \pi \rrbracket$ and on f_π of Polarized Proofs of $\vdash [\Delta], \Gamma$

3.4 Polarized execution formulas are an invariant for cut-elimination

In MELL, the execution formula is only an invariant of normalization for sequents not containing “?” (see [20, 21]). But in MLLP, \uparrow and \downarrow are logically weak (although still functorial) operators. In the case of the exponentials in [1], semantical axioms inspired directly from the syntactical rules of ! and ? in linear logic are imposed on top of the GoI situation. Here, for the weaker polarized case, we instead use the multipoint semantical structure to simulate the logically weak \uparrow and \downarrow . That is the purpose of the rather subtle retraction structure of multipoints. The simulation is indirect in the sense that the notion of multipoint does not live in the syntax of MLLP. But semantically the notion is fine-grained enough to sufficiently simulate \uparrow and \downarrow . This allows us to prove the execution formula is a full invariant for cut-elimination, in the sense of the following Proposition.

Proposition 3.21 (Ex is an invariant) *If $\pi \rightarrow_* \pi'$ by MLLP cut-elimination, then $\text{Ex}(\llbracket \pi \rrbracket, \sigma) = \text{Ex}(\llbracket \pi' \rrbracket, \sigma')$ and $\text{Ex}(f_\pi, \sigma_*) = \text{Ex}(f_{\pi'}, (\sigma')_*)$. In particular, if π' is a (cut-free) normal form of π , then (since σ' and $(\sigma')_*$ are Id_I) we have: $\text{Ex}(\llbracket \pi \rrbracket, \sigma) = \llbracket \pi' \rrbracket$ and $\text{Ex}(f_\pi, \sigma_*) = f_{\pi'}$.*

Proof. The crucial polarized case is where π contains cut formulas $\downarrow P^\perp$ and $\uparrow P$, which are transformed into the cut formulas P^\perp and P of π' by cut elimination. The other cases are similar to the non-polarized MLL case. So the crucial case is that of a proof π , ending with a cut between $\uparrow P$ and $\downarrow P^\perp$, which has the following form. A one-step reduction then gives rise to the proof ending with a cut between P in π'_1 and P^\perp in π'_2 :

$$\frac{\frac{\vdots \pi'_1}{\vdash [\dots], P, \dots} \uparrow \quad \frac{\vdots \pi'_2}{\vdash [\dots], P^\perp, \mathcal{M}} \downarrow}{\vdash [\dots], \downarrow P^\perp, \mathcal{M}} \text{cut}}{\vdash [\dots], \uparrow P, \downarrow P^\perp, \dots, \mathcal{M}}$$

Recall the definition of the interpretations of polarity changing \uparrow (see 4 of Definition 3.17)), where $U_\uparrow \rightarrow U_\uparrow$ occurring in the construction of $\llbracket \pi \rrbracket$ (for the principal \uparrow) is the zero morphism. This directly means that in $(\text{Id} \otimes s^m) \circ \llbracket \pi \rrbracket$ there arise no new loops via U_\uparrow and U_\downarrow for the $\uparrow P$ and $\downarrow P$ in the last cut. Hence the trace of $(\text{Id} \otimes s^m) \circ \llbracket \pi \rrbracket =$ the trace of $(\text{Id} \otimes s^m) \circ \llbracket \pi' \rrbracket$. Let us calculate this precisely using the trace axioms. Let π_1 (resp. π_2) denote π'_1 (resp. π'_2) applied by \uparrow (resp. by \downarrow) -rule to P (resp. to P^\perp). Let Γ_i (resp. Γ) be conclusions with the list of cut-formulas of π'_i (resp. π).

$$\begin{aligned} \llbracket \pi_1 \rrbracket^\dagger &= \llbracket \pi'_1 \rrbracket^\dagger \otimes (c : U_\uparrow \rightarrow U_\uparrow) \text{ with } c = 0 \\ \llbracket \pi_2 \rrbracket^\dagger &= (!_{\mathcal{M}} \otimes \mathbf{U}_{\Gamma'_2 \setminus \mathcal{M}}) \circ \{ \llbracket \pi'_2 \rrbracket \otimes (a : U_\downarrow \rightarrow 1^m) \otimes (b : 1^m \rightarrow U_\downarrow) \} \circ (r_{\mathcal{M}} \otimes \mathbf{U}_{\Gamma'_2 \setminus \mathcal{M}}) \\ &\quad \text{where } \mathbb{1}_{\mathcal{M}} = 1^m, a = h_m \circ \alpha^* \text{ and } b = \alpha \circ g_m. \\ \llbracket \pi \rrbracket^\dagger &= \llbracket \pi_1 \rrbracket^\dagger \otimes \llbracket \pi_2 \rrbracket^\dagger \\ &= (\hat{!}_{\mathcal{M}} \otimes \mathbf{U}_{\Gamma \setminus \mathcal{M}}) \circ \{ (\llbracket \pi'_1 \rrbracket \otimes c) \otimes (\llbracket \pi'_2 \rrbracket \otimes a \otimes b) \} \circ (\hat{r}_{\mathcal{M}} \otimes \mathbf{U}_{\Gamma \setminus \mathcal{M}}) \end{aligned}$$

Note that the compositions and precompositions of the middle arrows occurring in the above (R.H.S) are modulo permutations of their domains and codomains.

In the following proof, \mathbf{U}_x is simply abbreviated by x : it is either a formula A or a sequence \mathcal{M} . We abbreviate U_\uparrow and U_\downarrow by \uparrow and \downarrow . For the proof, it suffices to show

$$\mathrm{Tr}_{\Gamma \setminus \{\downarrow, \uparrow\}, \Gamma \setminus \{\downarrow, \uparrow\}}^{\uparrow \otimes \downarrow} ((id \otimes s_{\uparrow, \downarrow} \otimes s_{P, P^\perp}) \circ \llbracket \pi \rrbracket^\dagger) = (id \otimes s_{P, P^\perp}) \circ (\llbracket \pi'_1 \rrbracket^\dagger \otimes \llbracket \pi'_2 \rrbracket^\dagger) \quad (9)$$

where $id = \mathrm{Id}_{\Gamma \setminus \{P, P^\perp\}}$ and $\llbracket \pi' \rrbracket^\dagger = \llbracket \pi'_1 \rrbracket^\dagger \otimes \llbracket \pi'_2 \rrbracket^\dagger$.

For proving (9), we start with observing the following identity derivable by generalized yanking (Appendix 7.3), vanishing and dinaturality in a traced monoidal category.

(Iterated generalized yanking)

For any morphisms $f : X \rightarrow U$, $g : U \rightarrow V$ and $h : V \rightarrow Y$ in a traced monoidal category,

$$\mathrm{Tr}_{X, Y}^{V \otimes U} ((s_{Y, U} \otimes V) \circ (Y \otimes s_{U, V}) \circ (h \otimes f \otimes g)) = h \circ g \circ f \quad (10)$$

Pictorially, this says;

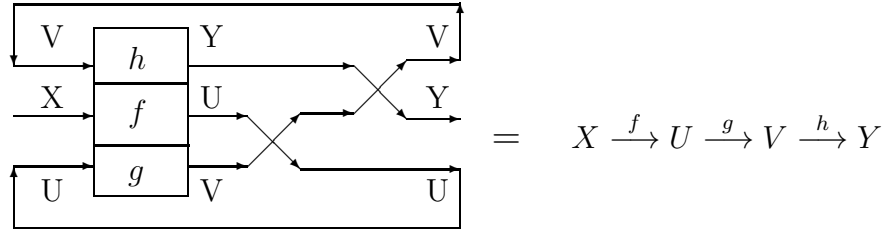

The (L.H.S) of (9), by naturality w.r.t $\hat{r}_{\mathcal{M}}$ and $\hat{!}_{\mathcal{M}}$, is equal to

$$\begin{aligned} & (\hat{!}_{\mathcal{M}} \otimes \mathrm{Id}_{\Gamma \setminus \{\mathcal{M}, \downarrow, \uparrow\}}) \circ \\ & \mathrm{Tr}_{1^m \otimes \Gamma \setminus \{\downarrow, \uparrow\}, 1^m \otimes \Gamma \setminus \{\downarrow, \uparrow\}}^{\downarrow} \{ (id \otimes \sigma) \circ (\llbracket \pi'_1 \rrbracket^\dagger \otimes c \otimes \llbracket \pi'_2 \rrbracket^\dagger \otimes a \otimes b) \} \circ (\hat{r}_{\mathcal{M}} \otimes \mathrm{Id}_{\Gamma \setminus \{\mathcal{M}, \downarrow, \uparrow\}}) \end{aligned} \quad (11)$$

The middle arrow of (11) is, by superposing, equal to

$$(id \otimes s_{\uparrow, \downarrow} \otimes s_{P, P^\perp}) \circ (\llbracket \pi'_1 \rrbracket^\dagger \otimes \llbracket \pi'_2 \rrbracket^\dagger) \otimes \mathrm{Tr}_{1^m, 1^m}^{\uparrow \otimes \downarrow} (a \otimes b \otimes c)$$

which by (10), is equal to $(id \otimes s_{\uparrow, \downarrow} \otimes s_{P, P^\perp}) \circ (\llbracket \pi'_1 \rrbracket^\dagger \otimes \llbracket \pi'_2 \rrbracket^\dagger) \otimes a \circ c \circ b$.

This amounts to showing that (11) is equal to the (R.H.S) of (9) by Axiom 9' since $a \circ c \circ b = 0$ when $c = 0$. See Appendix 7.6 for a pictorial representation of the above calculations.

The analogous assertion for f_{π_1} , f_{π_2} and f_π is easily checked in the bottom layer. \square

Example 3.22 (Extrusion of \downarrow -boxes by expanding Ex) In the dynamics of normalization, *extrusion* of \downarrow -boxes depicted in Example 2.3 is captured by running the execution formula. Let us illustrate this phenomenon in Rel, considered as a polarized GoI situation arising from Haghverdi's notion of a UDC (Unique Decomposition Category) (see Appendix 7.2). In this case, the execution formulas (defined via traces) can be written in Girard's original form of a power series, as in (18) of Definition 7.1 in Appendix 7.1, and have a matrix representation.

This phenomenon is sufficiently explained by examining the lower layer (= multipoint) interpretation f_{π_i} of the three proofs ($i = 1, 2, 3$) together with permutation $\sigma_* = s_{\mathbb{1}_{\uparrow 1}, \mathbb{1}_{\downarrow 2}} \otimes s_{\mathbb{1}_{\downarrow 3}, \mathbb{1}_{\uparrow 2}}$ of cuts, which are common to the three proofs:

$$f_{\pi_i} = \begin{array}{c} \mathbb{1}_{\downarrow 1} \quad \mathbb{1}_{\uparrow 3} \\ \mathbb{1}_{\uparrow 3} \left(\begin{array}{cc|cc} \delta_{i3} & \delta_{i3} & \delta_{i1} & \delta_{i2} \\ \delta_{i3} & & & 1 \\ \delta_{i1} & & & \\ & & & 1 \end{array} \right) \\ \mathbb{1}_{\uparrow 1} \\ \mathbb{1}_{\downarrow 2} \\ \mathbb{1}_{\downarrow 3} \\ \mathbb{1}_{\uparrow 2} \end{array} \quad \sigma_* = \begin{array}{c} \mathbb{1}_{\uparrow 1} \quad \mathbb{1}_{\downarrow 2} \\ \mathbb{1}_{\downarrow 2} \left(\begin{array}{cc} 1 & 1 \\ & \end{array} \right) \otimes \begin{array}{c} \mathbb{1}_{\downarrow 3} \quad \mathbb{1}_{\uparrow 2} \\ \mathbb{1}_{\uparrow 2} \left(\begin{array}{cc} 1 & 1 \\ & \end{array} \right) \end{array} \end{array}$$

In the above, 1 abbreviates Id_1 and δ_{ij} is the Kronecker delta. Note that the normal form π of π_1 , π_2 and π_3 is the η -expansion of the axiom-link, hence is interpreted by the 2×2 anti-diagonal identity matrix f_π indexed with $\mathbb{1}_{\downarrow 1}$ and $\mathbb{1}_{\uparrow 3}$.

The scope extrusion of Example 2.3 is represented by the expansion of the Execution formula $Ex(f_{\pi_1}, \sigma_*)$ (i.e., taking the trace of $(\text{Id} \otimes \sigma_*) \circ f_{\pi_1}$). Note that the box_j with $j \in \{1, 2, 3\}$ is represented by the two paired elements δ_{ij} in the symmetric matrix f_{π_i} , while the symmetric pair of 1s at $(\mathbb{1}_{\downarrow i}, \mathbb{1}_{\uparrow i})$ and $(\mathbb{1}_{\uparrow i}, \mathbb{1}_{\downarrow i})$ with $i \in \{2, 3\}$ represents the box introduced by \downarrow_i . Then, the calculation passes through $Ex(f_{\pi_2}, \sigma_*)$, then $Ex(f_{\pi_3}, \sigma_*)$ and finally will terminate in f_π . Here, the lower left δ_{i1} moves to the lower left δ_{i2} by the action of $(f_{\pi_1})_{22} \sigma_*(f_{\pi_1})_{21}$. Then it moves finally to the lower left δ_{i3} by the action of $(f_{\pi_1})_{12} \sigma_*(f_{\pi_1})_{22} \sigma_*(f_{\pi_1})_{21}$. This says that as j decreases, the sum for $Ex(f_{\pi_j}, \sigma_*)$ becomes “finer grained”: that is, the information flow realized in the sum of $Ex(f_{\pi_j}, \sigma_*)$ can be retrieved from that in $Ex(f_{\pi_i}, \sigma_*)$ with $i > j$. For the information flow arising from the Execution formula in a UDC, the reader is referred to Appendices 7.1, 7.2 and Haghverdi’s thesis [19].

3.5 Polarized execution formulas characterize focusing

As we saw above in MLLP, the execution formula yields invariants of the dynamical process of cut-elimination. In this section we give a second property peculiar to the polarized execution formula. As far as we know it has no analogue in traditional linear logic.

Our main result is that the execution formula in polarized GoI situations is able to characterize the focusing property, which is the fundamental characteristic of polarized logics. Observe that in a polarized GoI situation, a proof π of an MLLP sequent is interpreted as a pair $(\llbracket \pi \rrbracket, f_\pi)$. This interpretation does not capture the focusing property. Instead, the GoI situation only provides an interpretation of polarities in terms of multipoints arising from the retractions $U \otimes 1^m \triangleright U$ for $\llbracket \pi \rrbracket$ and $1^m \otimes 1^m \triangleright 1^m$ for f_π . We may now ask: how do we semantically obtain the stronger notion of positivity/negativity? We show that this stronger property can be characterized in terms of *preservation of multipoints* through running the execution formulas. These results are described in Proposition 3.25 below. For this proposition, we introduce the following definition:

Definition 3.23 (restriction and range of morphisms)

Let \mathcal{C} be a polarized GoI situation.

- In the presence of 0 morphisms of \mathcal{C} , the two morphisms ι_i and ρ_j are derivable, as

follows:

$$\begin{aligned} \iota_i : X_j &\simeq X_j \otimes \bigotimes_{i \in K \setminus \{j\}} I \xrightarrow{X_j \otimes \bigotimes_{i \in K \setminus \{j\}} 0_{I, X_i}} X_j \otimes \bigotimes_{i \in K \setminus \{j\}} X_i \simeq \bigotimes_{i \in K} X_i \\ \rho_j : \bigotimes_{i \in K} X_i &\simeq X_j \otimes \bigotimes_{i \in K \setminus \{j\}} X_i \xrightarrow{X_j \otimes \bigotimes_{i \in K \setminus \{j\}} 0_{X_i, I}} X_j \otimes \bigotimes_{i \in K \setminus \{j\}} I \simeq X_j \end{aligned}$$

so that $\rho_k \iota_j = X_i$ if $j = k$ and $0_{X_j, X_k}$ otherwise (These are called quasi-injections and quasi-projections in [19, 21])

- For a morphism f with domain $\bigotimes_{i \in K} X_i$, its *restriction* to X_j is the morphism $f \circ \iota_j$.
- For a morphism f with codomain $\bigotimes_{i \in K} X_i$, f *ranges over* X_j if $(\iota_j \circ \rho_j) \circ f = f$.

The following lemma will be used for Proposition 3.25.

Lemma 3.24 (Trace on zero morphisms)

Zero morphisms satisfy the following property. For any morphism $f : X \otimes U \rightarrow Y \otimes U$:

$$\begin{aligned} \text{Tr}_{X,Y}^U (f \circ (X \otimes 0_{U,U})) &= \rho_1 \circ f \circ \iota_1 = \text{Tr}_{X,Y}^U ((X \otimes 0_{U,U}) \circ f) \\ &\text{where } \iota_1 = X \otimes 0_{I,U} \quad \text{and} \quad \rho_1 = X \otimes 0_{U,I} \end{aligned}$$

Proof. We prove the first equation (a similar calculation goes for the second).

$$\text{Tr}_{X,Y}^U (f \circ (X \otimes 0_{I,U} \circ 0_{U,I})) \stackrel{\text{dinat.}}{=} \text{Tr}_{X,Y}^I ((X \otimes 0_{U,I}) \circ f \circ (X \otimes 0_{I,U})) \stackrel{\text{vanishing}}{=} (X \otimes 0_{U,I}) \circ f \circ (X \otimes 0_{I,U})$$

□

Notation: for a sequence Γ containing a formula A , consider the composition

$\mathbb{1}_A \xrightarrow{\text{mp}(A)} U_A \xrightarrow{\iota} U_\Gamma$, where ι is the quasi-injection induced by the embedding of A into Γ . This is denoted (by abuse of notation) by $\text{mp}(A) : \mathbb{1}_A \rightarrow U_\Gamma$, leaving the ι implicit.

Proposition 3.25 (focusing = invariance of mp) *Let π be an MLLP proof of a sequent $\vdash [\Delta], \mathcal{N}, P$, where P is a positive formula. Then the execution formulas over $\llbracket \pi \rrbracket$ and over f_π give rise to the following commutative diagram:*

$$\begin{array}{ccc} U_{\mathcal{N}, P} & \xrightarrow{\text{Ex}(\llbracket \pi \rrbracket, \sigma)} & U_{\mathcal{N}, P} \\ \text{mp}(P) \uparrow & & \uparrow \text{mp}(\mathcal{N}) \\ \mathbb{1}_P & \xrightarrow{\text{Ex}(f_\pi, \sigma_*)} & \mathbb{1}_{\mathcal{N}} \end{array}$$

The bottom arrow of this diagram indicates that $\text{Ex}(f_\pi, \sigma_*)$, when its domain is restricted to $\mathbb{1}_P$, ranges over $\mathbb{1}_{\mathcal{N}}$.

Proof. We prove the proposition directly for Case 1 (axiom) and Case 4 (\downarrow rule) and by induction on the size of π for the other cases. *Note:* symbols used in the proof are the same as those in Definition 3.17.

1. (*Axiom:*)

The following diagram commutes because multipoints associated with De Morgan dual formulas are equal by the duality-induced permutation on their domains (which are foldings of tensors of 1's).

$$\begin{array}{ccc} U_P \otimes U_{P^\perp} & \xrightarrow{s_{U,U}} & U_P \otimes U_{P^\perp} \\ \text{mp}(P) \otimes 0 \uparrow & & \uparrow 0 \otimes \text{mp}(P^\perp) \\ \mathbb{1}_P \otimes \mathbb{1}_{P^\perp} & \xrightarrow{s_{1^n, 1^n}} & \mathbb{1}_P \otimes \mathbb{1}_{P^\perp} \end{array}$$

2. (*Linear connectives:*)

We prove it for a proof π ending with the \otimes -rule (the result is obvious for the \wp -rule). Suppose π is

$$\frac{\begin{array}{c} \vdots \pi_1 \\ \vdash [\Delta_1], \mathcal{M}_1, P_1 \end{array} \quad \begin{array}{c} \vdots \pi_2 \\ \vdash [\Delta_2], \mathcal{M}_2, P_2 \end{array}}{\vdash [\Delta_1, \Delta_2], \mathcal{M}_1, \mathcal{M}_2, P_1 \otimes P_2} \otimes$$

First, note that

$$\begin{aligned} \text{Ex}(\llbracket \pi_1 \rrbracket \otimes \llbracket \pi_2 \rrbracket, \sigma_1 \otimes \sigma_2) &= \text{Ex}(\llbracket \pi_1 \rrbracket, \sigma_1) \otimes \text{Ex}(\llbracket \pi_2 \rrbracket, \sigma_2) \\ \text{Ex}(f_{\pi_1} \otimes f_{\pi_2}, (\sigma_1)_* \otimes (\sigma_2)_*) &= \text{Ex}(f_{\pi_1}, (\sigma_1)_*) \otimes \text{Ex}(f_{\pi_2}, (\sigma_2)_*) \end{aligned}$$

where the σ_i are iterated tensors of symmetries s , representing the cut formulas in π_i , for $i = 1, 2$.

Then commutativity of the first diagram by I.H. yields directly that of the second where $n = n_1 + n_2$:

$$\begin{array}{ccc} U_{\mathcal{M}_i, P_i} & \xrightarrow{\text{Ex}(\llbracket \pi_i \rrbracket, \sigma_i)} & U_{\mathcal{M}_i, P_i} \\ \text{mp}(P_i) \uparrow & i=1,2 & \uparrow \text{mp}(\mathcal{M}_i) \\ \mathbb{1}_{P_i} & \xrightarrow{\text{Ex}(f_{\pi_i}, (\sigma_i)_*)} & \mathbb{1}_{\mathcal{M}_i} \end{array} \quad \begin{array}{ccc} U_{\mathcal{M}_1, \mathcal{M}_2, P_1 \otimes P_2} & \xrightarrow{\text{Ex}(\llbracket \pi \rrbracket, \sigma)} & U_{\mathcal{M}_1, \mathcal{M}_2, P_1 \otimes P_2} \\ \text{mp}(P_1) \otimes \text{mp}(P_2) \uparrow & & \uparrow \text{mp}(\mathcal{M}_1) \otimes \text{mp}(\mathcal{M}_2) \\ \mathbb{1}_{P_1} \otimes \mathbb{1}_{P_2} & \xrightarrow{\text{Ex}(f_\pi, \sigma_*)} & \mathbb{1}_{\mathcal{M}_1} \otimes \mathbb{1}_{\mathcal{M}_2} \end{array}$$

3. (*Polarity Changing \uparrow :*)

This case never happens since a conclusion of any such proof does not contain a positive formula.

4. (*Polarity Changing \downarrow :*)

Let $\mathbb{1}_{\mathcal{M}} := 1^m$. First, see the following diagram for the commutativity ⁶:

$$\alpha^m \circ f_\pi = \llbracket \pi \rrbracket^\dagger \circ \alpha$$

⁶For typographical simplicity, we rotated the diagram 90 degrees clockwise

where f_π is restricted to $\mathbb{1}_{\downarrow N} = 1$.

$$\begin{array}{ccc}
\mathbb{1}_{\downarrow N} = 1 & \xrightarrow{\alpha \otimes 0_{I, \mathcal{M}^U \otimes \mathcal{M}^D \otimes \mathcal{U}_\Xi}} & U_{\downarrow} \otimes \mathcal{M}^U \otimes \mathcal{M}^D \otimes \mathcal{U}_\Xi \\
\downarrow f_\pi & \searrow h_m & \downarrow U_{\downarrow} \otimes r_{\mathcal{M} \otimes \mathcal{M}^D \otimes \mathcal{U}_\Xi} \\
& & U_{\downarrow} \otimes 1^m \otimes \mathcal{M}^U \otimes \mathcal{M}^D \otimes \mathcal{U}_\Xi \\
& & \downarrow (h_m \circ \alpha^*) \otimes (\alpha \circ g_m) \otimes \llbracket \pi' \rrbracket^\dagger \\
& & 1^m \otimes U_{\downarrow} \otimes \mathcal{M}^U \otimes \mathcal{M}^D \otimes \mathcal{U}_\Xi \\
& & \downarrow \text{symmetry} \\
& & 1^m \otimes 1^m \otimes V \xrightarrow{1^m \otimes \alpha^m \otimes V} 1^m \otimes \mathcal{M}^U \otimes \mathcal{M}^D \otimes U_{\downarrow} \otimes \mathcal{U}_\Xi \\
& & \downarrow !^m \otimes V \quad \quad \quad \downarrow !_{\mathcal{M} \otimes V} \\
& & 1^m \otimes V \xrightarrow{\alpha^m \otimes V} \mathcal{M}^U \otimes \mathcal{M}^D \otimes U_{\downarrow} \otimes \mathcal{U}_\Xi \\
& & \downarrow V \otimes \text{lifting} \\
& & V = \mathcal{M}^D \otimes U_{\downarrow} \otimes \mathcal{U}_\Xi
\end{array}$$

In the diagram, Ξ denotes Δ, N . The upper right pentagon commutes because $\alpha^* \circ \alpha = \text{Id}_1$. The left pentagon commutes from the definition of f_π . The lower right square is $V \otimes$ lifting along α^m of Proposition 3.16, hence commutes. These three commutativities imply that of the outer most square.

Then the following is a composition of the above outermost square (L.H.S below) with the R.H.S square:

$$\begin{array}{ccccc}
& & \llbracket \pi \rrbracket^\dagger & & \\
& & \uparrow & \xrightarrow{\sigma \otimes U_{\mathcal{M}, \downarrow N}} & \\
& & U_{\Delta, \mathcal{M}, \downarrow N} & & U_{\Delta, \mathcal{M}, \downarrow N} \\
& \uparrow \alpha = \text{mp}(\downarrow N) & & \uparrow \alpha^m & \uparrow \alpha^m = \text{mp}(\mathcal{M}) \\
& & \mathbb{1}_{\downarrow N} & \xrightarrow{f_\pi} & 1^m \xrightarrow{\sigma_* \otimes \mathbb{1}_{\mathcal{M}, \downarrow N}} & 1^m
\end{array} \tag{12}$$

From (12) and the construction of $\llbracket \pi \rrbracket^\dagger$ and of f_π in this case, the following diagram commutes, whose upper (resp. lower) middle morphism is the composition of the upper (resp. lower but relaxing the restriction on its domain and codomain) horizontal morphisms of (12).

$$\begin{array}{ccccc}
I \otimes U_{\mathcal{M}} \otimes U_{\downarrow N} & \xrightarrow{0_{I, U_\Delta} \otimes U_{\mathcal{M}, \downarrow N}} & U_{\Delta, \mathcal{M}, \downarrow N} & \xrightarrow{\quad} & U_{\Delta, \mathcal{M}, \downarrow N} & \xrightarrow{0_{U_\Delta, I} \otimes U_{\mathcal{M}, \downarrow N}} & I \otimes U_{\mathcal{M}} \otimes U_{\downarrow N} \\
\uparrow I \otimes 0_{\mathbb{1}_{\mathcal{M}}, U_{\mathcal{M}} \otimes \alpha} & & & & & & \uparrow I \otimes \alpha^m \otimes 0_{\mathbb{1}_{\downarrow N}, U_{\downarrow N}} \\
I \otimes \mathbb{1}_{\mathcal{M}} \otimes \mathbb{1}_{\downarrow N} & \xrightarrow{0_{I, \mathbb{1}_\Delta} \otimes \mathbb{1}_{\mathcal{M}, \downarrow N}} & \mathbb{1}_{\Delta, \mathcal{M}, \downarrow N} & \xrightarrow{\quad} & \mathbb{1}_{\Delta, \mathcal{M}, \downarrow N} & \xrightarrow{0_{\mathbb{1}_\Delta, I} \otimes \mathbb{1}_{\mathcal{M}, \downarrow N}} & I \otimes \mathbb{1}_{\mathcal{M}} \otimes \mathbb{1}_{\downarrow N}
\end{array}$$

The assertion is proved by Lemma 3.24 on U_Δ (resp. $\mathbb{1}_\Delta$) for the horizontal upper (resp. lower) compositions of the above diagram.

5.(Cut:) ⁷

This case uses the following property of the associativity of cut (cf. [21]):

$$\text{Ex}(\llbracket \pi \rrbracket, \sigma \otimes s) = \text{Ex}(\text{Ex}(\llbracket \pi \rrbracket, \sigma), s) \quad \text{and} \quad \text{Ex}(f_\pi, \sigma_* \otimes s_*) = \text{Ex}(\text{Ex}(f_\pi, \sigma_*), s_*)$$

where s corresponds to the last cut of π .

The sequence Ξ of Case 2 of Definition 3.17 must be of the form Q, \mathcal{M} with a positive Q : i.e., π is

$$\frac{\begin{array}{c} \vdots \pi' \\ \vdash [\Delta'], P, \mathcal{N} \end{array} \quad \begin{array}{c} \vdots \pi'' \\ \vdash [\Delta''], P^\perp, Q, \mathcal{M} \end{array}}{\vdash [\Delta', \Delta'', P, P^\perp], \mathcal{N}, Q, \mathcal{M}} \text{ cut}$$

Note first that $\sigma = \sigma' \otimes \sigma''$ with σ' (resp. σ'') representing all the cuts of π' (resp. π'').

The I.H. implies the following two diagrams commute:

$$\begin{array}{ccc} U_{P, \mathcal{N}} & \xrightarrow{\text{Ex}(\llbracket \pi' \rrbracket, \sigma')} & U_{P, \mathcal{N}} \\ \uparrow \text{mp}(P) & & \uparrow \text{mp}(\mathcal{N}) \\ \mathbb{1}_P & \xrightarrow{\text{Ex}(f_{\pi'}, \sigma'_*)} & \mathbb{1}_\mathcal{N} \end{array} \quad \begin{array}{ccc} U_{P^\perp, Q, \mathcal{M}} & \xrightarrow{\text{Ex}(\llbracket \pi'' \rrbracket, \sigma'')} & U_{P^\perp, Q, \mathcal{M}} \\ \uparrow \text{mp}(Q) & & \uparrow \text{mp}(P^\perp, \mathcal{M}) \\ \mathbb{1}_Q & \xrightarrow{\text{Ex}(f_{\pi''}, \sigma''_*)} & \mathbb{1}_{P^\perp} \otimes \mathbb{1}_\mathcal{M} \end{array}$$

Since $\llbracket \pi \rrbracket \cong \llbracket \pi' \rrbracket \otimes \llbracket \pi'' \rrbracket$ modulo permutation of interface,

$$\text{Ex}(\llbracket \pi \rrbracket, \sigma) \cong \text{Ex}(\llbracket \pi' \rrbracket, \sigma') \otimes \text{Ex}(\llbracket \pi'' \rrbracket, \sigma'')$$

Then

$$(U_{\mathcal{N}, Q, \mathcal{M}} \otimes s_{U_P, U_{P^\perp}}) \circ \text{Ex}(\llbracket \pi \rrbracket, \sigma) \cong (U_{\mathcal{N}, Q, \mathcal{M}} \otimes s_{U_P, U_{P^\perp}}) \circ (\text{Ex}(\llbracket \pi' \rrbracket, \sigma') \otimes \text{Ex}(\llbracket \pi'' \rrbracket, \sigma''))$$

This composing morphisms is realized by the upper horizontal morphisms of the following composition of the two commutative squares whose left one is obtained by tensoring the above two squares:

$$\begin{array}{ccccc} U_{P, \mathcal{N}} \otimes U_{P^\perp, Q, \mathcal{M}} & \xrightarrow{\text{Ex}(\llbracket \pi' \rrbracket, \sigma') \otimes \text{Ex}(\llbracket \pi'' \rrbracket, \sigma'')} & U_{P, \mathcal{N}} \otimes U_{P^\perp, Q, \mathcal{M}} & \xrightarrow{U_{\mathcal{N}, Q, \mathcal{M}} \otimes s_{U_P, U_{P^\perp}}} & U_{\mathcal{N}, Q, \mathcal{M}} \otimes U_{P, P^\perp} \\ \uparrow \text{mp}(P) \otimes \text{mp}(Q) & & \uparrow \text{mp}(P^\perp) \otimes \text{mp}(\mathcal{N}, \mathcal{M}) & & \uparrow \text{mp}(P) \otimes \text{mp}(\mathcal{N}, \mathcal{M}) \\ \mathbb{1}_P \otimes \mathbb{1}_Q & \xrightarrow{\text{Ex}(f_{\pi'}, \sigma'_*) \otimes \text{Ex}(f_{\pi''}, \sigma''_*)} & \mathbb{1}_\mathcal{N} \otimes \mathbb{1}_{P^\perp} \otimes \mathbb{1}_\mathcal{M} & \xrightarrow{\mathbb{1}_{\mathcal{N}, Q, \mathcal{M}} \otimes s_{\mathbb{1}_P, \mathbb{1}_{P^\perp}}} & \mathbb{1}_\mathcal{N} \otimes \mathbb{1}_\mathcal{M} \otimes \mathbb{1}_P \end{array}$$

In the outermost square, taking trace along $U_P \otimes U_{P^\perp}$ (resp. along $\mathbb{1}_P \otimes \mathbb{1}_{P^\perp}$) of the upper (resp. the lower) horizontal morphism, by Corollary 3.11 (strong uniformity) we have the following diagram, which is the assertion by virtue of the associativity mentioned at the beginning of this case.

⁷This is the case where Corollary 3.11 (strong uniformity) is used.

$$\begin{array}{ccc}
U_{\mathcal{N}} \otimes U_{Q,\mathcal{M}} & \xrightarrow{\text{Tr}^{U_P \otimes U_{P^\perp}} ((U_{\mathcal{N},Q,\mathcal{M}} \otimes s) \circ \text{Ex}(\llbracket \pi \rrbracket, \sigma))} & U_{\mathcal{N}} \otimes U_{Q,\mathcal{M}} \\
\uparrow \text{mp}(Q) & & \uparrow \text{mp}(\mathcal{N}) \otimes \text{mp}(\mathcal{M}) \\
\mathbb{1}_Q & \xrightarrow{\text{Tr}^{\mathbb{1}_P \otimes \mathbb{1}_{P^\perp}} ((\mathbb{1}_{\mathcal{N},Q,\mathcal{M}} \otimes s_{\mathbb{1}_P, \mathbb{1}_{P^\perp}}) \circ \text{Ex}(f_\pi, \sigma_*))} & \mathbb{1}_{\mathcal{N}} \otimes \mathbb{1}_{\mathcal{M}}
\end{array}$$

□

Remark 3.26 (weak pullback)⁸ The square diagram in Proposition 3.25 determines a weak pull back in a restricted sense. That is, the weak universal property holds for any given morphisms $\mathbb{1} \rightarrow U_{\mathcal{N},P}$ and $\mathbb{1} \rightarrow \mathbb{1}_{\mathcal{N}}$ so that the common domain $\mathbb{1}$ of the two morphisms is restricted to be of the form $\mathbb{1}^m$.

Example 3.27 (invariance of Proposition 3.25) We give two examples of Proposition 3.25 for the interpretations shown in Example 3.18. In these examples $\text{Ex}(\llbracket \pi \rrbracket, \sigma)$ and $\text{Ex}(f_\pi, \sigma_*)$ are $\llbracket \pi \rrbracket$ and f_π respectively, since π is cut-free.

(i) In this case, $P = \downarrow X^\perp$ and $\mathcal{M} = \uparrow X$.

Since f_π restricted to $\mathbb{1}_{\downarrow X^\perp} := \mathbb{1}$ ranges over $\mathbb{1}_{\uparrow X}$, the Proposition follows from

$$\llbracket \pi \rrbracket^\dagger \circ (\alpha : \mathbb{1}_{\downarrow X^\perp} \rightarrow U_\downarrow) = (\alpha : \mathbb{1}_{\uparrow X} \rightarrow U_\uparrow) \circ f_\pi \quad \text{under this restriction.}$$

Recall that in the Rel examples, the equated morphisms are identified with $\{n_\alpha\}$.

(ii) In this case, $P = \downarrow \uparrow (X \otimes Y)$ and $\mathcal{M} = Y^\perp \wp X^\perp$.

Since f_π restricted to $\mathbb{1}_{\downarrow \uparrow (X \otimes Y)}$ ranges over $\mathbb{1}_{Y^\perp} \otimes \mathbb{1}_{X^\perp}$, the commutativity follows from:

$$\llbracket \pi \rrbracket^\dagger \circ (\alpha : \mathbb{1}_{\downarrow \uparrow (X \otimes Y)} \rightarrow U_\downarrow) = (\alpha^2 : \mathbb{1}_{Y^\perp} \wp \mathbb{1}_{X^\perp} \rightarrow \mathbf{U}_{Y^\perp} \wp \mathbb{1}_{X^\perp}) \circ f_\pi \quad \text{under the restriction.}$$

The equated morphisms are identified with $\{n_\alpha\} + \{n_\alpha\}$.

We now show there a kind of “converse”: any MLLP-provable sequent $\vdash [\Delta], \mathcal{N}, A$ with A invariant in the sense of the diagram in Proposition 3.25 must have A positive. More precisely:

Proposition 3.28 (converse of focusing) *Let $\vdash [\Delta], \mathcal{M}, A$ be a sequent provable in MLLP such that A contains a polarity changing connective and \mathcal{M} is a sequence of negative formulas. If the following diagram nontrivially commutes in all models⁹*

$$\begin{array}{ccc}
U_{\mathcal{M},A} & \xrightarrow{\text{Ex}(\llbracket \pi \rrbracket, \sigma)} & U_{\mathcal{M},A} \\
\uparrow \text{mp}(A) & & \uparrow \text{mp}(\mathcal{M}) \\
\mathbb{1}_A & \xrightarrow{\text{Ex}(f_\pi, \sigma_*)} & \mathbb{1}_{\mathcal{M}}
\end{array}$$

then A is a positive formula.

⁸ The notion of *weak pull back* plays a fundamental role later in Section 4.

⁹ We say a commutative diagram *trivially commutes* if the unique arrow in it is the zero morphism, and *nontrivially commutes* if it is not the zero morphism.

Proof. It suffices to prove the assertion for cut-free proofs for $\vdash \mathcal{M}, A$ so that $\text{Ex}(\llbracket \pi \rrbracket, \sigma)$ and $\text{Ex}(f_\pi, \sigma_*)$ become respectively $\llbracket \pi \rrbracket$ and f_π because of the invariance of cut-elimination of Proposition 3.21. For the proof, we make the following observation, which is proved for f_π by induction on the construction of proofs π :

For a positive formula Q and any negative formula M in a conclusion of a cut-free focused proof π , the following holds in any Rel polarized GoI situation:

$$[\mathbb{1}_M]f_\pi \cap \mathbb{1}_Q \neq \emptyset \quad (13)$$

(cf. Notation 5.1 for Rel in Section 5 below.)¹⁰

We prove Proposition 3.28 by contradiction; suppose that A is negative and consider the polarized GoI situation Rel. From the assumption, the given cut-free proof π has the bottom most \uparrow -rule, say I whose principal formula is denoted by $\uparrow Q$, so that any inference (if it exists) below I is either the \wp -rule or exchange. Let π' be the subproof of π ending at the premise of I . Then we have the following:

$$f_\pi \cong f_{\pi'} \otimes 0_{\mathbb{1}_{\uparrow Q}, \mathbb{1}_{\uparrow Q}} \quad \text{modulo exchange rules below } I.$$

(Case 1) The case where the distinguished occurrence $\uparrow Q$ occurs in \mathcal{M} :

In this case, \mathcal{M} is constructed from negative formulas and the $\uparrow Q$ via \wp -connectives and commas. The conclusion of π' has occurrences Q and a factorization A' of A by means of \wp -rules below I . Note that $\mathbb{1}_{A'} \subseteq \mathbb{1}_A$. Because π' is focused, we have $[\mathbb{1}_{A'}]f_{\pi'} \cap \mathbb{1}_Q \neq \emptyset$ by (13). On the other hand, since $\uparrow Q$ occurs in \mathcal{M} but $\mathbb{1}_{\uparrow Q} \cap \mathbb{1}_Q = \emptyset$, we have $\mathbb{1}_Q \cap \mathbb{1}_{\mathcal{M}} = \emptyset$. This contradicts that f_π restricted to $\mathbb{1}_A$ ranges over $\mathbb{1}_{\mathcal{M}}$.

(Case 2) The case where the distinguished occurrence $\uparrow Q$ occurs in A :

In this case A is constructed from negative formulas and the $\uparrow Q$ via \wp -connectives.

(Case 2.1) The case where $A = \uparrow Q$.

From the definition of the interpretation of the \uparrow -rule, f_π restricted to $\mathbb{1}_A = 1$ is 0, hence the diagram trivially commutes.

(Case 2.2) Otherwise. In this case Q and another factor A' both occur in the conclusion of π' , where A' as well as $\uparrow Q$ is a factorization of A by means of \wp -rules below I . By the same argument for Q and A' as Case 1 (but more directly) $\mathbb{1}_Q \cap \mathbb{1}_{\mathcal{M}} = \emptyset$; since this Q does not occur in \mathcal{M} , we have a contradiction.

□

4 Constructing a compact polarized category via GoI

In this section we describe certain kinds of polarized categories arising from a different view of GoI; namely, from Joyal-Street-Verity's **Int**-construction in the multipointed setting. Although the material of this section is formally independent of the previous Section 3, it highlights different aspects of GoI arising from **Int**-constructions, in particular the construction of compact polarized models in the sense of our previous paper [23].

¹⁰ Proof of (13): Note first that the last rule of π must not be \uparrow -rule. Since the induction is straightforward for the axiom and linear connectives \otimes and \wp , we prove the case when the last rule is \downarrow . The corresponding case of Definition 3.17 says that $[\mathbb{1}_{\mathcal{M}}]f_\pi \supseteq \mathbb{1}_{\downarrow N}$ so that $\mathbb{1}_{\mathcal{M}} = 1^m$ and $\mathbb{1}_{\downarrow N} = 1$, which directly implies (13).

4.1 Polarized logic and polarized categories

In Section 2 we described O. Laurent’s polarized multiplicative linear logic MLLP. For references to polarized categories, the reader is referred to our own paper [23], as well as the original sources referred to there. We begin with a very general definition of a polarized categorical model for MLLP. Our models are included among Cockett-Seely polarized categories [10], although theirs are considerably more general. The definition below is simpler than assumed in our previous paper [23], which emphasized full completeness theorems. As also mentioned there, our previous categorical models (as well as the categorical models below) are related to the dialogue categories and dialogue chiralities of Paul-André Melliès [38, 39], although our motivation arises from the proof theory of MLLP.

Definition 4.1 (Polarized Categories) A *polarized category* $(\langle \mathcal{C}_+, \mathcal{C}_- \rangle, \widehat{\mathcal{C}})$ consists of the following data:

- A pair of monoidal categories (\mathcal{C}_+, \otimes) and $(\mathcal{C}_-, \boxtimes)$ called *positive* (resp. *negative*).
- A contravariant monoidal equivalence $()^\perp$ of the two categories:

$$(-)^\perp : (\mathcal{C}_+)^{op} \xrightarrow{\cong} \mathcal{C}_-$$

- (*Polarity changing functors*) A pair of adjoint functors $\uparrow \dashv \downarrow$, where $\uparrow : \mathcal{C}_+ \rightarrow \mathcal{C}_-$ and $\downarrow : \mathcal{C}_- \rightarrow \mathcal{C}_+$. Diagrammatically:

$$\begin{array}{ccc} & \uparrow & \\ \mathcal{C}_+ & \begin{array}{c} \xrightarrow{\quad} \\ \perp \\ \xleftarrow{\quad} \end{array} & \mathcal{C}_- \\ & \downarrow & \end{array}$$

- De Morgan duality for \downarrow and \uparrow (wrt the monoidal equivalence):

$$(\downarrow X)^\perp \cong \uparrow X^\perp \quad \text{and} \quad (\uparrow X)^\perp \cong \downarrow X^\perp$$

- A bimodule ¹¹ $\widehat{\mathcal{C}} : \mathcal{C}_+^{op} \times \mathcal{C}_- \rightarrow \mathbf{Set}$ satisfying that there is a natural equivalence:

$$\widehat{\mathcal{C}}(P, N) \cong \mathcal{C}_+(P, \downarrow N) \quad \text{for all } P \in \mathcal{C}_+, N \in \mathcal{C}_-$$

This may be written as a reversible “rule”:

$$\frac{\widehat{\mathcal{C}}(P, N)}{\mathcal{C}_+(P, \downarrow N)} \downarrow$$

Remark 4.2 By duality, there is a dual rule:

$$\frac{\mathcal{C}_-(\uparrow P, N)}{\widehat{\mathcal{C}}(P, N)} \uparrow$$

In the language of distributors (profunctors), we are demanding that $\widehat{\mathcal{C}}$ be left and right representable [30] and compatible with $()^\perp$.

¹¹Intuitively, families of *nonfocused proofs*

At the $*$ -autonomous category level $(\otimes, \wp, ()^\perp)$, the various coherence theorems in [9] guarantee negation can be taken to be strictly involutive (along with strict monoidal structure for each monoidal product). We have not, however, examined the more general question of strictness for polarized categories.

Remark 4.3 (The case where the profunctor $\widehat{\mathcal{C}}$ is a hom functor $\mathcal{C}(-, -)$) A polarized category arises from the following framework of adjoint functors $L \dashv \downarrow$ and $\uparrow \dashv R$ with contravariant equivalence $()^\perp$, as shown in the following diagram:

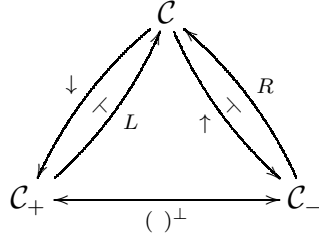

These functors are subject to a natural isomorphism $(\uparrow L())^\perp \simeq \downarrow R()^\perp$ between two endofunctors on \mathcal{C}_+ . In this framework, the polarity changing functors for Definition 4.1 are defined by $\uparrow \circ L$ and $\downarrow \circ R$:

The following definition of compactness is sufficient for the purposes of this paper, although more general frameworks are possible.

Definition 4.4 (Compact Polarized Category) We say a polarized category is *compact* if

- $\mathcal{C}_+^{op} = \mathcal{C}_-$.
- $(A \otimes B)^\perp = B^\perp \otimes A^\perp$ for all objects A, B .

A compact polarized category is *degenerate* if \downarrow (equivalently \uparrow) is the identity functor.

Examples of compact polarized categories include various categories of multipointed relations (arising in work of Hamano and Takemura [24]), as well as various polarized Int-categories arising from GoI, to be discussed below. The reader is referred to Section 5 for the above-mentioned category of multipointed relations. An analogous approach to pointed relations is seen in Ehrhard’s category **PpL** of preorders with projections [11].

Remark 4.5 Although the notion of compact polarized category may appear to be “degenerate” in some informal sense, nevertheless the notion is sufficiently robust to distinguish the two key proofs in our paper [23] (Example 2.2). In other words, compact polarized categories are adequate to account for \downarrow -boxes in MLLP. These boxes are intrinsic for MLLP, but not for the weaker logic $\text{MLL}^{\downarrow\uparrow}$ of [34].

4.2 The Int construction

The original connection of GoI to categories was realized by several researchers (e.g. M. Hyland and S. Abramsky) as being related to the so-called **Int**-construction in the original paper of Joyal-Street Verity [29]. Further history and related notions are discussed in the paper of Abramsky, Haghverdi, and Scott [1].

Given a traced monoidal category \mathcal{C} , we can define a compact closed category $\text{Int}(\mathcal{C})$ as follows: an object is a pair (A^+, A^-) of \mathcal{C} -objects and a morphism $f : (A^+, A^-) \rightarrow (B^+, B^-)$ is a \mathcal{C} -morphism $f : A^+ \otimes B^- \rightarrow B^+ \otimes A^-$. The composition of $\text{Int}(\mathcal{C})$ is defined by

$$g \circ f = \text{Tr}_{A^+ \otimes C^-, C^+ \otimes A^-}^{B^-} ((C^+ \otimes s_{B^-, A^-}) \circ (g \otimes A^-) \circ (B^+ \otimes s_{A^-, C^-}) \circ (f \otimes C^-) \circ (A^+ \otimes s_{C^-, B^-})) \quad (14)$$

This composition is shown in Figure 3 below, after Proposition 4.8. An arrow $(A^+, A^-) \xrightarrow{f} (B^+, B^-) \in \text{Int}(\mathcal{C})$ is really an arrow $A^+ \otimes B^- \xrightarrow{f} B^+ \otimes A^- \in \mathcal{C}$. We picture the arrow pointing upwards and denote it by a box, with the four objects at the corners. The domain $A^+ \otimes B^-$ is denoted by the lower edge, the codomain $B^+ \otimes A^-$ denoted by the upper edge. We would like to think of an $\text{Int}(\mathcal{C})$ morphism $f : (A^+, A^-) \rightarrow (B^+, B^-)$ intuitively as a bidirectional data flow: a *pair* of arrows, one from A^+ to B^+ and the other “backwards” from B^- to A^- . Unfortunately, this view of f is only heuristic; officially, f is not a tensor of two maps going in opposite directions, i.e. $f \neq g \otimes h$, where $g : A^+ \rightarrow B^+$ and $h : B^- \rightarrow A^-$. However, in the following subsections, we shall explicitly model this bidirectional dataflow by using multipoints.

4.3 A polarized Int construction

In what follows in this subsection, let \mathcal{C} be a traced monoidal category

$$(\mathcal{C}, \otimes, I, s, 1, (!, r), 0)$$

with 0 morphisms (Axiom 8) and a distinguished object 1 satisfying the retraction $1 \otimes 1 \triangleright_{(!, r)} 1$ (Axiom 3) of Definition 3.1 of the previous Section. Moreover \mathcal{C} is supposed to satisfy the following variations of the Lifting properties (Axiom 6') and (Axiom 9) in which U can be taken to be *any* object A of \mathcal{C} and β can be *any* morphism $1^m \rightarrow A$:¹²

Axiom 6'' for Section 4 : (Lifting Property along β)

For any object A of \mathcal{C} , any non-zero natural number m and any morphism $\beta : 1^m \rightarrow A$, there exists a retraction pair $A \otimes 1^m \triangleright_{(!, r_\beta)} A$ lifting the retraction $1^m \otimes 1^m \triangleright_{(!, r^m)} 1^m$ along β :

$$\begin{array}{ccc} A \otimes 1^m & \xrightarrow{!_\beta} & A \\ & \xleftarrow{r_\beta} & \\ \beta \otimes 1^m \uparrow & & \uparrow \beta \\ 1^m \otimes 1^m & \xrightarrow{!^m} & 1^m \\ & \xleftarrow{r^m} & \end{array}$$

Axiom 9' for Section 4

For any morphism $f : V \otimes X_1 \rightarrow W \otimes X_2$ with $X \in \{A, 1\}$, any non-zero natural number m_i , and any morphism $\beta_i : 1^{m_i} \rightarrow A_i$,

$$(W \otimes !_{\beta_2}) \circ (f \otimes 0_{1^{m_1}, 1^{m_2}}) \circ (V \otimes r_{\beta_1}) = f \quad \text{and} \quad (W \otimes !) \circ (f \otimes 0_{1^{m_1}, 1^{m_2}}) \circ (V \otimes r) = f$$

Note that we make the convention $(1^m)_i$ denotes 1^{m_i} . See the following figure for the respective equations when $X = A$ and $X = 1$:

¹²Note: unlike in the previous Section, here A is not assumed to have any retraction structure and we also assume $A \otimes 1^m \triangleright_{(!, r_\beta)} A$ lifts the m -fold retraction structure of $1 \otimes 1 \triangleright_{(!, r)} 1$ on 1.

$$\begin{array}{ccc}
\begin{array}{c}
V \xrightarrow{\quad} \boxed{f} \xrightarrow{\quad} W \\
\begin{array}{ccc}
A_1 & \xrightarrow{\quad} & A_2 \\
\uparrow \scriptstyle r_{\beta_1} & & \downarrow \scriptstyle !\beta_2 \\
A_1 & \xrightarrow{1^{m_1}} & A_2 \\
\downarrow \scriptstyle 1^{m_1} & & \downarrow \scriptstyle 1^{m_2} \\
A_1 & \xrightarrow{0_{1^{m_1}, 1^{m_2}}} & A_2
\end{array}
\end{array}
& = f & \text{and} \\
\begin{array}{c}
V \xrightarrow{\quad} \boxed{f} \xrightarrow{\quad} W \\
\begin{array}{ccc}
1^{m_1} & \xrightarrow{\quad} & 1^{m_2} \\
\uparrow \scriptstyle r^{m_1} & & \downarrow \scriptstyle !m_2 \\
1^{m_1} & \xrightarrow{\quad} & 1^{m_2} \\
\downarrow \scriptstyle 1^{m_1} & & \downarrow \scriptstyle 1^{m_2} \\
1^{m_1} & \xrightarrow{0_{1^{m_1}, 1^{m_2}}} & 1^{m_2}
\end{array}
\end{array}
& = f
\end{array}$$

Notation 4.6 (morphism f_{X_i, Y_j}) For a morphism $f : X_1 \otimes X_2 \longrightarrow Y_1 \otimes Y_2$, we denote by $f_{X_i, Y_j} : X_i \longrightarrow Y_j$ the following composition (where $(\) + 1$ is mod 2):

$$X_i \simeq X_i \otimes I \xrightarrow{X_i \otimes 0_{I, X_{i+1}}} X_i \otimes X_{i+1} \simeq X_1 \otimes X_2 \xrightarrow{f} Y_1 \otimes Y_2 \simeq Y_j \otimes Y_{j+1} \xrightarrow{Y_j \otimes 0_{Y_{j+1}, I}} Y_j \otimes I \simeq Y_j$$

Definition 4.7 (Positive category $\text{Int}_P(\mathcal{C})$) The positive category $\text{Int}_P(\mathcal{C})$ consists of the following data:

- objects are multipointed objects of $\text{Int}_P(\mathcal{C})$:

$$(A_{\alpha^+}^+, A_{\alpha^-}^-)$$

where (A^+, A^-) is an object of $\text{Int}(\mathcal{C})$ and for $* \in \{+, -\}$, α^* is a morphism $1^{m^*} \xrightarrow{\alpha^*} A^*$, whose domain is the m^* -ary tensor-folding of 1. Here m^* is a natural number associated to α^* . We call α^* a *multipoint* of A^* .

- morphisms are 3-tuples:

$$(A_{\alpha^+}^+, A_{\alpha^-}^-) \xrightarrow{(f, f_+, f_-)} (B_{\beta^+}^+, B_{\beta^-}^-)$$

where

- $f : (A^+, A^-) \longrightarrow (B^+, B^-)$ is a morphism in $\text{Int}(\mathcal{C})$.
- f_+ and f_- are morphisms in \mathcal{C} making the following respective diagrams weak pullbacks wrt the indicated morphisms (see Notation 4.6):

$$\begin{array}{ccc}
A^+ & \xrightarrow{f_{A^+, B^+}} & B^+ \\
\alpha^+ \uparrow & \text{WPB} & \uparrow \beta^+ \\
1^{m^+} & \xrightarrow{f_+} & 1^{n^+}
\end{array}
\qquad
\begin{array}{ccc}
B^- & \xrightarrow{f_{B^-, A^-}} & A^- \\
\beta^- \uparrow & \text{WPB} & \uparrow \alpha^- \\
1^{n^-} & \xrightarrow{f_-} & 1^{m^-}
\end{array}$$

- f makes the following diagram commute:

$$\begin{array}{ccc}
B^- & \xrightarrow{f_{B^-, B^+}} & B^+ \\
\beta^- \uparrow & & \uparrow \beta^+ \\
1^{n^-} & \xrightarrow{0} & 1^{n^+}
\end{array}$$

Diagrammatically a morphism (f, f_+, f_-) of $\text{Int}_P(\mathcal{C})$ is described as follows:

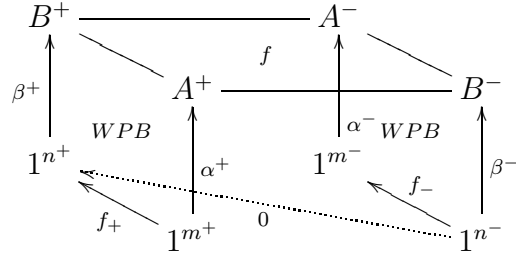

In the above diagram, we say f_+ and f_- represent the bidirectional dataflow implicit in the upper arrow f .

Proposition 4.8 $\text{Int}_P(\mathcal{C})$ forms a monoidal category.

Proof. $\text{Id}_{(A^+, A^-)}$ is defined by $(\text{Id}_{(A^+, A^-)}, \text{Id}_+, \text{Id}_-)$ where Id_* is Id on the domain of α^* with $*$ $\in \{+, -\}$. Since the first element of the tuple is $\text{Id}_{A^+} \otimes \text{Id}_{A^-}$ in \mathcal{C} , $\text{Id}_{(A^+, A^-)}$ belongs to $\text{Int}_P(\mathcal{C})$. It is immediate that the tensor product of $\text{Int}(\mathcal{C})$ is closed in $\text{Int}_P(\mathcal{C})$. We show that $\text{Int}(\mathcal{C})$ composition preserves the positivity of morphisms. Recall the composition of two $\text{Int}(\mathcal{C})$ morphisms $(A^+, A^-) \xrightarrow{f} (B^+, B^-)$ and $(B^+, B^-) \xrightarrow{g} (C^+, C^-)$ given in Equation (14) and Figure 3 below.

The general $\text{Int}_P(\mathcal{C})$ composition with multipoints is shown in Figure 5 below. It represents the morphism $(g, g_+, g_-) \circ (f, f_+, f_-)$. Here the top plane corresponds to the ordinary $\text{Int}(\mathcal{C})$ composition in Figure 3 below. The bottom plane represents the analogous composition at the level of multipoints, and is illustrated separately in Figure 4 below.

Preservation of weak pullbacks is explained diagrammatically in Figure 5 below. The left vertical WPBs in the diagram compose to form a WPB. The right vertical WPBs become a WPB because of generalized yanking in Appendix 7.3. \square

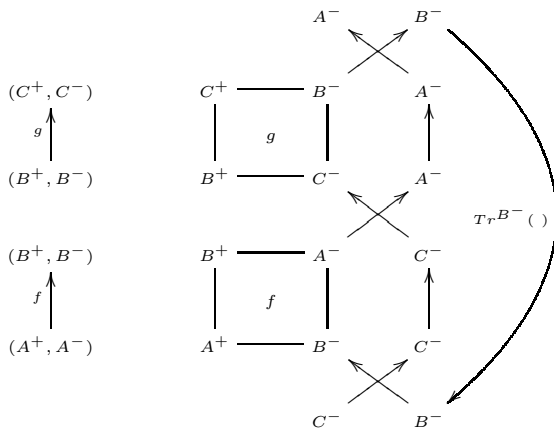

Figure 3: Composition in $\text{Int}(\mathcal{C})$

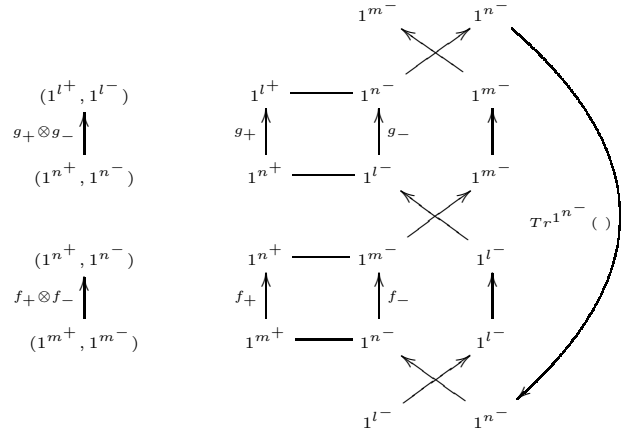

Figure 4: Composition in $\text{Int}_P(\mathcal{C})$ for multipoints

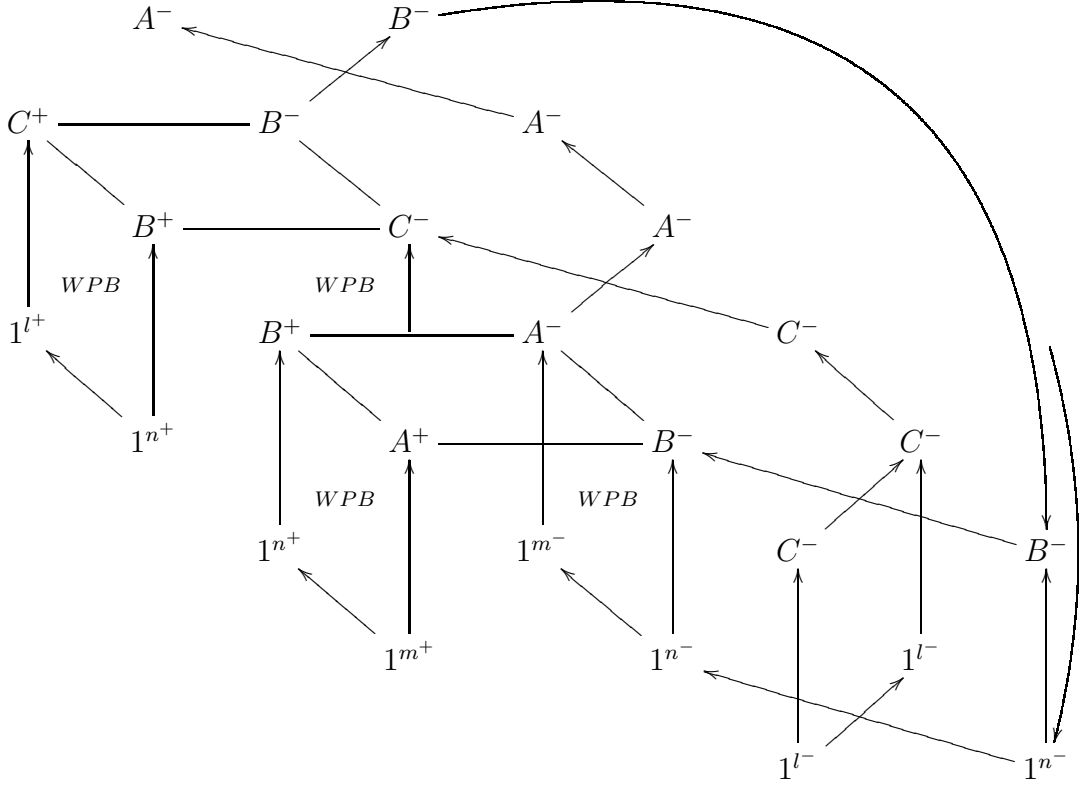

Figure 5: Composition $(g, g_+, g_-) \circ (f, f_+, f_-)$ in $\text{Int}_P(\mathcal{C})$ (the top plane is from Figure 3 and the bottom plane is from Figure 4.)¹³

Obviously there is a forgetful functor $|\cdot| : \text{Int}_P(\mathcal{C}) \rightarrow \text{Int}(\mathcal{C})$.

Definition 4.9 (functor \downarrow) The functor $\downarrow : \text{Int}(\mathcal{C}) \rightarrow \text{Int}_P(\mathcal{C})$ is defined as follows:

- On objects: $\downarrow(A^+, A^-) := ((A^+ \otimes 1)_1, (A^- \otimes 1)_1)$, where $(A^* \otimes 1)_1$ denotes adjoining the point $1 \cong I \otimes 1 \xrightarrow{0_I, A^* \otimes 1} A^* \otimes 1$, $* \in \{+, -\}$.
- On morphisms: for $f : (A^+, A^-) \rightarrow (B^+, B^-)$, define

$$\downarrow f : ((A^+ \otimes 1)_1, (A^- \otimes 1)_1) \rightarrow ((B^+ \otimes 1)_1, (B^- \otimes 1)_1)$$

as $\downarrow f := (s_{1, B^+} \otimes A^- \otimes 1) \circ (1 \otimes f \otimes 1) \circ (s_{A^+, 1} \otimes B^- \otimes 1)$ and f_+ and f_- are Id's on 1.

Diagrammatically,

$$\begin{array}{ccccc}
 B^+ \otimes 1 & \xrightarrow{\quad} & A^- \otimes 1 & & \\
 \uparrow & \searrow & \uparrow & \searrow & \\
 1 & & A^+ \otimes 1 & \xrightarrow{\quad} & B^- \otimes 1 \\
 \uparrow & \text{WPB} & \uparrow & \text{WPB} & \uparrow \\
 1 & & 1 & & 1 \\
 \searrow & & \searrow & & \searrow \\
 & & & & 1 \\
 & & & & \uparrow \\
 & & & & f_- \\
 & & & & \uparrow \\
 & & & & 1 \\
 & & & & \uparrow \\
 & & & & f_+ \\
 & & & & \uparrow \\
 & & & & 1
 \end{array}$$

¹³The rightmost feedback arrow on the lower level maps 1^{n^-} (below the upper B^-) to 1^{n^-} .

Proposition 4.10 (adjunction)

\downarrow is right adjoint to the forgetful functor $| \cdot |$, i.e.

$$\text{Int}(\mathcal{C})((A^+, A^-), (B^+, B^-)) \cong \text{Int}_P(\mathcal{C})((A_{\alpha^+}^+, A_{\alpha^-}^-), ((B^+ \otimes 1)_1, (B^- \otimes 1)_1)) \quad (15)$$

Proof. Note first (15) gives the required adjunction, because $(A^+, A^-) = |(A_{\alpha^+}^+, A_{\alpha^-}^-)|$ and $\downarrow(B^+, B^-) = ((B^+ \otimes 1)_1, (B^- \otimes 1)_1)$. The natural bijection in (15) is given by:

- **(From right to left):** define $\epsilon_{(B^+, B^-)} : \downarrow(B^+, B^-) = (B^+ \otimes 1, B^- \otimes 1) \longrightarrow (B^+, B^-)$ by:

$$\epsilon_{(B^+, B^-)} : B^+ \otimes 1 \otimes B^- \xrightarrow{B^+ \otimes 0_1 \otimes B^-} B^+ \otimes 1 \otimes B^- \xrightarrow{B^+ \otimes s_{1, B^-}} B^+ \otimes B^- \otimes 1$$

modulo canonical associativity isomorphisms of \otimes . Then ϵ is the co-unit of the adjunction. Given a morphism g of the R.H.S, we obtain a morphism of the L.H.S. by composing with $\epsilon_{(B^+, B^-)}$. That is, by the composition of $\text{Int}(\mathcal{C})$,

$$\begin{aligned} \epsilon_{(B^+, B^-)} \circ g &:= \text{Tr}_{A^+ \otimes B^-, B^+ \otimes A^-}^{B^- \otimes 1} \left(\begin{array}{c} (B^+ \otimes s_{B^- \otimes 1, A^-}) \circ (\epsilon_{(B^+, B^-)} \otimes A^-) \circ \\ (B^+ \otimes 1 \otimes s_{A^-, B^-}) \circ (g \otimes B^-) \circ (A^+ \otimes s_{B^-, B^- \otimes 1}) \end{array} \right) \\ &= \text{Tr}_{A^+ \otimes B^-, B^+ \otimes A^-}^{B^- \otimes 1} \left((B^+ \otimes s_{1, A^-}) \circ (B^+ \otimes A^- \otimes 0_1) \circ g \otimes B^- \right) \\ &\stackrel{\text{vanishing}}{=} \text{Tr}_{A^+ \otimes B^-, B^+ \otimes A^-}^1 \left((B^+ \otimes s_{1, A^-}) \circ (B^+ \otimes 0_1 \otimes A^-) \circ g \right) \end{aligned} \quad (16)$$

- **(From left to right):** This is the part where weak pullbacks will be used.

Given a morphism $f : (A^+, A^-) \longrightarrow (B^+, B^-)$ from the L.H.S.

$$\begin{array}{ccc} B^+ & \xrightarrow{\quad} & A^- \\ & \searrow & \swarrow \\ & A^+ & \xrightarrow{\quad} & B^- \end{array}$$

$f' : (A_{\alpha^+}^+, A_{\alpha^-}^-) \longrightarrow \downarrow(B^+, B^-) := ((B^+ \otimes 1)_1, (B^- \otimes 1)_1)$ is constructed by the following diagram:

$$\begin{array}{ccccc} B^+ \otimes 1 & \xrightarrow{\quad} & A^- & & \\ \uparrow 1 & \swarrow & \uparrow \alpha^- & \swarrow \alpha^- & \\ & A^+ \otimes 1^{m^+} & & A^- \otimes 1^{m^-} & \\ & \uparrow r_{\alpha^+} & & \uparrow \alpha^- \otimes 1^{m^-} & \\ & \alpha^+ \otimes 1^{m^+} & & & \\ & \uparrow \alpha^+ & & & \\ & 1^{m^+} \otimes 1^{m^+} & & 1^{m^-} \otimes 1^{m^-} & \\ \uparrow g_{2m^+} & \swarrow r^{m^+} & \uparrow \alpha^+ & \swarrow \alpha^+ & \uparrow 1 \\ & 1^{m^+} & & 1^{m^-} & \\ & \uparrow r^{m^+} & & \uparrow h_{2m^-} & \\ & 1 & & 1 & \\ & & & & \uparrow 1 \\ & & & & B^- \otimes 1 \end{array}$$

where the upper (outer) square denotes the morphism f' constructed and the parallelogram (inside the square) with the vertices $A^+ \otimes 1^{m^+}, B^- \otimes 1, B^+ \otimes 1, A^- \otimes 1^{m^-}$ denotes the following morphism with $g_{m^+} : 1^{m^+} \longrightarrow 1$ and $h_{m^-} : 1 \longrightarrow 1^{m^-}$ of (8):

$$(s_{1,B^+} \otimes A^- \otimes 1^{m^-}) \circ (g_{m^+} \otimes f \otimes h_{m^-}) \circ (s_{A^+,1^{m^+}} \otimes B^- \otimes 1) : \\ (A^+ \otimes 1^{m^+}) \otimes (B^- \otimes 1) \longrightarrow (B^+ \otimes 1) \otimes (A^- \otimes 1^{m^-})$$

The vertical square on the right front face and the left rear face are lifting properties (Axiom 6'') over α^+ and α^- , respectively. Hence

$$f' := (s_{1,B^+} \otimes !_{\alpha^-}) \circ (g_{m^+} \otimes f \otimes h_{m^-}) \circ (r_{\alpha^+} \otimes B^- \otimes 1) \quad (17)$$

In the bottom surface, f'_+ and f'_- are constructed by composing the bottom arrows in the diagram. The right and left faces are shown to be WPB's by virtue of the fact that the two morphisms $g_{2m} \circ r^{2m}$ and $!^{2m} \circ h_{2m}$ give the retraction structure $1^{2m} \triangleright 1$.

Finally we show that when the f' of (17) is applied to the above "from right to left" construction, then the original f is recovered.

$$\begin{aligned} \epsilon_{(B^+, B^-)} \circ f' &\stackrel{(16)}{=} \text{Tr}_{A^+ \otimes B^-, B^+ \otimes A^-}^1 \left((B^+ \otimes s_{1,A^-}) \circ (B^+ \otimes 0_1 \otimes A^-) \circ f' \right) \\ &= \text{Tr}_{A^+ \otimes B^-, B^+ \otimes A^-}^1 \left((B^+ \otimes !_{\alpha^-} \otimes 1) \circ (B^+ \otimes A^- \otimes s_{1,1^{m^-}}) \circ (s_{1,B^+ \otimes A^-} \otimes 1^{m^-}) \circ \right. \\ &\quad \left. (0_1 \circ g_{m^+} \otimes f \otimes h_{m^-}) \circ (r_{\alpha^+} \otimes B^- \otimes 1) \right) \quad \text{modulo symmetry} \\ &= (B^+ \otimes !_{\alpha^-}) \circ \text{Tr}_{1^{m^+} \otimes A^+ \otimes B^-, B^+ \otimes A^- \otimes 1^{m^-}}^1 \left((B^+ \otimes A^- \otimes s_{1,1^{m^-}}) \circ (s_{1,B^+ \otimes A^-} \otimes 1^{m^-}) \circ (0_{1^{m^+},1} \otimes f \otimes h_{m^-}) \right) \\ &\quad \circ (r_{\alpha^+} \otimes B^-), \quad \text{naturalities} \end{aligned}$$

whose Tr part is

$$\begin{aligned} &\text{Tr}_{1^{m^+} \otimes A^+ \otimes B^-, B^+ \otimes A^- \otimes 1^{m^-}}^1 \left((B^+ \otimes A^- \otimes s_{1,1^{m^-}}) \circ (f \otimes 0_{1^{m^+},1} \otimes h_{m^-}) \circ (s_{1^{m^+}, A^+ \otimes B^-} \otimes 1) \right) \\ &= \text{Tr}_{A^+ \otimes B^- \otimes 1^{m^+}, B^+ \otimes A^- \otimes 1^{m^-}}^1 \left((B^+ \otimes A^- \otimes s_{1,1^{m^-}}) \circ (f \otimes 0_{1^{m^+},1} \otimes h_{m^-}) \right) \circ s_{1^{m^+}, A^+ \otimes B^-} \\ &= f \otimes \text{Tr}_{1^{m^+}, 1^{m^-}}^1 \left(s_{1,1^{m^-}} \circ (0_{1^{m^+},1} \otimes h_{m^-}) \right) \circ s_{1^{m^+}, A^+ \otimes B^-} \\ &= f \otimes h_{m^-} \circ 0_{1^{m^+},1} \circ s_{1^{m^+}, A^+ \otimes B^-} = f \otimes 0_{1^{m^+}, 1^{m^-}} \circ s_{1^{m^+}, A^+ \otimes B^-} \quad \text{generalized yanking} \end{aligned}$$

We conclude: $\epsilon_{(B^+, B^-)} \circ f' = (B^+ \otimes !_{\alpha^-}) \circ (f \otimes 0_{1^{m^+}, 1^{m^-}}) \circ (r_{\alpha^+} \otimes B^-) = f$, by Axiom 9'. \square

Recall that the duality $(\)^\perp$ of $\text{Int}(\mathcal{C})$ is a contravariant endofunctor such that $(A^+, A^-)^\perp := (A^-, A^+)$ and $f^\perp := s_{B^+, A^-} \circ f \circ s_{B^-, A^+}$ for $f : (A^+, A^-) \longrightarrow (B^+, B^-)$. This duality $(\)^\perp$ acts on $\text{Int}_P(\mathcal{C})$ to yield the following dual category $\text{Int}_N(\mathcal{C})$.

Definition 4.11 (Negative category $\text{Int}_N(\mathcal{C})$) The negative category $\text{Int}_N(\mathcal{C})$ consists of the following data:

- objects: those of $\text{Int}_P(\mathcal{C})$.

- morphisms: those of $\text{Int}_P(\mathcal{C})$ but the last condition on f is replaced by:

$$\begin{array}{ccc}
 A^+ & \xrightarrow{f_{A^+,A^-}} & A^- \\
 \alpha^+ \uparrow & & \uparrow \alpha^- \\
 1^{m^+} & \xrightarrow{0} & 1^{m^-}
 \end{array}$$

Diagrammatically a morphism (f, f_+, f_-) of $\text{Int}_N(\mathcal{C})$ is described as follows:

$$\begin{array}{ccccc}
 B^+ & \xrightarrow{\quad} & A^- & & \\
 \beta^+ \uparrow & & \uparrow \alpha^- & & \uparrow \beta^- \\
 & \searrow & & \swarrow & \\
 & & A^+ & \xrightarrow{f} & B^- \\
 & & \uparrow \alpha^+ & & \uparrow \beta^- \\
 & & 1^{m^+} & \xrightarrow{0} & 1^{m^-} \\
 & \swarrow f_+ & & \searrow f_- & \\
 1^{n^+} & & & & 1^{n^-}
 \end{array}$$

(Note: The diagram above is a simplified representation of the complex commutative diagram in the image. The original diagram includes labels 'WPB' for weak pullbacks and '0' for the 0-morphism.)

Note that the 0 morphism occurring in the bottom level is antidiagonal to that of the 0 morphism of $\text{Int}_P(\mathcal{C})$.

Hence the positive and the negative categories are contravariantly equivalent. The functor $\uparrow: \text{Int}(\mathcal{C}) \rightarrow \text{Int}_P(\mathcal{C})$ is defined by de Morgan duality $\uparrow(\cdot) := (\downarrow(\cdot)^\perp)^\perp$.

Thus we obtain a compact polarized category (Definition 4.4), in the style of Remark 4.3:

Theorem 4.12 (A compact polarized category)

$(\langle \text{Int}_P(\mathcal{C}), \text{Int}_N(\mathcal{C}) \rangle, \widehat{\text{Int}(\mathcal{C})})$ is a polarized category such that \downarrow (resp. \uparrow) is right (resp. left) adjoint to the forgetful functor $|\cdot|$. The polarized category is compact so that $(\text{Int}_P(\mathcal{C}))^{op} = \text{Int}_N(\mathcal{C})$. In diagrammatic form:

$$\begin{array}{ccc}
 & \text{Int}(\mathcal{C}) & \\
 \downarrow & \swarrow & \searrow \\
 \text{Int}_P(\mathcal{C}) & & \text{Int}_N(\mathcal{C}) \\
 & \xleftarrow{(\cdot)^\perp} &
 \end{array}$$

5 A polarized Int construction using Rel with multipoints

In this section we show how to build a concrete instance of the previous polarized Int-construction using Rel with multipoints to construct weak pullbacks compatible with these multipoints. Thus we obtain a concrete compact polarized model of MLLP.

Let us make the following observations. First, this section is a relational instance of the previous Section 4 and the reader can read it independently of that. Second, in Sections 2 and 3 of this paper, we often use the matrix formalism of Haghverdi’s UDC’s (see Appendix

7.2). This agrees with the usual matrix calculus in linear algebra. In what follows, we adopt instead the matrix notation of Joyal-Street-Verity [29] for $\text{Int}(\text{Rel})$, since these authors do similar calculations to those below. We introduce the following standard notions.

Notation 5.1

- For a relation $R : A \rightarrow B$, and subsets $X \subseteq A$ and $Y \subseteq B$,

$$[Y]R := \{x \mid \exists b \in Y(x, b) \in R\} \quad R[X] := \{y \mid \exists a \in X(a, y) \in R\}$$

- A morphism $R : (A^+, A^-) \rightarrow (B^+, B^-)$ of $\text{Int}(\text{Rel})$ is represented by the following matrix (where the border objects represent appropriate domains and codomains of the entries, as shown below:)

$$\begin{array}{cc} A^+ & B^- \\ B^+ & \begin{pmatrix} R_{12} & R_{22} \\ R_{11} & R_{21} \end{pmatrix} \\ A^- & \end{array}$$

The entries are relations $R_{11} : A^+ \rightarrow A^-$, $R_{12} : A^+ \rightarrow B^+$, $R_{21} : B^- \rightarrow A^-$, $R_{22} : B^- \rightarrow B^+$.

E.g., $\text{Id}_{(A^+, A^-)}$ is represented by $\begin{pmatrix} 1 & 0 \\ 0 & 1 \end{pmatrix}$

- The dual morphism $R^\perp : (B^-, B^+) \rightarrow (A^-, A^+)$ in $\text{Int}(\text{Rel})$ is represented by

$$R^\perp := \begin{pmatrix} 0 & 1 \\ 1 & 0 \end{pmatrix} R \begin{pmatrix} 0 & 1 \\ 1 & 0 \end{pmatrix} = \begin{pmatrix} R_{21} & R_{11} \\ R_{22} & R_{12} \end{pmatrix}$$

Fact 5.2 (composition in $\text{Int}(\text{Rel})$) Given morphisms $R : (A^+, A^-) \rightarrow (B^+, B^-)$ and $S :$

$(B^+, B^-) \rightarrow (C^+, C^-)$ of $\text{Int}(\text{Rel})$ represented by $\begin{array}{cc} A^+ & B^- \\ B^+ & \begin{pmatrix} R_{12} & R_{22} \\ R_{11} & R_{21} \end{pmatrix} \\ A^- & \end{array}$ and $\begin{array}{cc} B^+ & C^- \\ C^+ & \begin{pmatrix} S_{12} & S_{22} \\ S_{11} & S_{21} \end{pmatrix} \\ B^- & \end{array}$,
the composition $S \circ R$, in $\text{Int}(\text{Rel})$ is given by the following relation¹⁴ :

$$\begin{array}{cc} A^+ & C^- \\ C^+ & \begin{pmatrix} \emptyset & S_{22} \\ R_{11} & \emptyset \end{pmatrix} \\ A^- & \end{array} \cup \begin{array}{cc} A^+ & C^- \\ C^+ & \begin{pmatrix} S_{12}(R_{22}S_{11})^*R_{12} & S_{12}R_{22}(S_{11}R_{22})^*S_{21} \\ R_{21}S_{11}(R_{22}S_{11})^*R_{12} & R_{21}(S_{11}R_{22})^*S_{21} \end{pmatrix} \\ A^- & \end{array}$$

which we can write as:

$$\begin{array}{ccccc} A^+ & \xrightarrow{R_{12}} & B^+ & \xrightarrow{S_{12}} & C^+ \\ R_{11} \downarrow & & R_{22} \updownarrow & S_{11} & \uparrow S_{22} \\ A^- & \xleftarrow{R_{21}} & B^- & \xleftarrow{S_{21}} & C^- \end{array}$$

In general in Rel_+ , a multipoint $1^m \rightarrow A$ is an m -indexed family of subsets of A . In what follows, we denote a multipoint of a set A by $\text{mp}(A)$ and think of it as a subset $\text{mp}(A) \subseteq A$.

¹⁴We write relational composition from right to left and omit the \circ symbol.

Definition 5.3 (Positive category Pos)

- Objects are $(A_{\text{mp}(A^+)}^+, A_{\text{mp}(A^-)}^-)$ where (A^+, A^-) is an object of $\text{Int}(\text{Rel})$ and $\text{mp}(A^+) \subseteq A^+$ and $\text{mp}(A^-) \subseteq A^-$ are multipoints respectively of A^+ and A^- .
- Arrows (also called *positive maps*) are morphisms $R : (A^+, A^-) \rightarrow (B^+, B^-)$ in $\text{Int}(\text{Rel})$ satisfying the following three conditions:
 - 1) $[\text{mp}(B^+)]R_{12} = \text{mp}(A^+)$
 - 2) $R_{21}[\text{mp}(B^-)] = \text{mp}(A^-)$
 - 3) $[\text{mp}(B^+)]R_{22} = \emptyset = R_{22}[\text{mp}(B^-)]$

The above three conditions are instances of the three conditions on morphisms of Definition 4.7. The following figure explains how the conditions 1) and 2) correspond to the left and right WPB's, respectively and that the condition 3) corresponds to the 0 morphism.

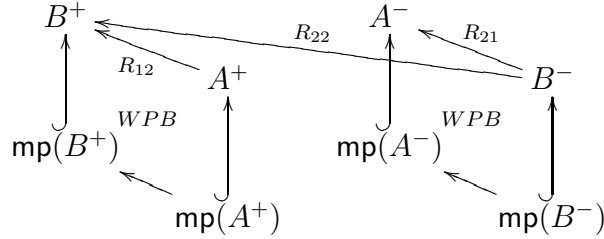

Proposition 5.4 Pos forms a category.

Proof. Id's are Pos maps since Id on (A^+, A^-) is given by the matrix s.t. $\text{Id}_{12} = \text{Id}_{A^+}$, $\text{Id}_{21} = \text{Id}_{A^-}$ and $\text{Id}_{11} = \text{Id}_{22} = \emptyset$. We check that the composition of $\text{Int}(\text{Rel})$ preserves Pos maps. The computation below is essentially a concrete instance of Figure 5.

Given two morphisms $R : (A^+, A^-) \rightarrow (B^+, B^-)$ and $S : (B^+, B^-) \rightarrow (C^+, C^-)$ of $\text{Int}(\text{Rel})$.

$$\begin{aligned}
1) \quad [\text{mp}(C^+)](SR)_{12} &= [\text{mp}(C^+)](S_{12}(R_{22}S_{11})^*R_{12}) \\
&= [\text{mp}(B^+)]((R_{22}S_{11})^*R_{12}) \\
&= [\text{mp}(B^+)]R_{12} \cup [\text{mp}(B^+)]((R_{22}S_{11})(R_{22}S_{11})^*R_{12}) \\
&= \text{mp}(A^+) \cup \emptyset \\
2) \quad (SR)_{21}[\text{mp}(C^-)] &= (R_{21}(S_{11}R_{22})^*S_{21})[\text{mp}(C^-)] \\
&= (R_{21}(S_{11}R_{22})^*)[\text{mp}(B^-)] \\
&= R_{21}[\text{mp}(B^-)] \cup (R_{21}(S_{11}R_{22})^*S_{11})(R_{22}[\text{mp}(B^-)]) \\
&= \text{mp}(A^-) \cup \emptyset \\
3) \quad [\text{mp}(C^+)](SR)_{22} &= [\text{mp}(C^+)]S_{22} \cup [\text{mp}(C^+)](S_{12}R_{22}(S_{11}R_{22})^*S_{21}) \\
&= \emptyset \cup [\text{mp}(B^+)](R_{22}(S_{11}R_{22})^*S_{21}) \\
&= \emptyset \cup \emptyset \\
(SR)_{22}[\text{mp}(C^-)] &= S_{22}[\text{mp}(C^-)] \cup (S_{12}R_{22}(S_{11}R_{22})^*S_{21})[\text{mp}(C^-)] \\
&= \emptyset \cup (S_{12}R_{22}(S_{11}R_{22})^*)[\text{mp}(B^-)] \\
&= \emptyset \cup (S_{12}R_{22})[\text{mp}(B^-)] \cup (S_{12}R_{22}(S_{11}R_{22})^*S_{11}R_{22})[\text{mp}(B^-)] \\
&= \emptyset \cup \emptyset \cup \emptyset
\end{aligned}$$

□

Proposition 5.5 *The category Pos is monoidal with respect to the tensor product of Int(Rel).*

Proof. Given Pos maps $R : (A^+_{\text{mp}(A^+)}, A^-_{\text{mp}(A^-)}) \rightarrow (B^+_{\text{mp}(B^+)}, B^-_{\text{mp}(B^-)})$ and $S : (C^+_{\text{mp}(C^+)}, C^-_{\text{mp}(C^-)}) \rightarrow (D^+_{\text{mp}(D^+)}, D^-_{\text{mp}(D^-)})$, the tensor product $R \otimes S : ((A^+ + C^+)_{\text{mp}(A^+) + \text{mp}(C^+)}, (A^- + C^-)_{\text{mp}(A^-) + \text{mp}(C^-)}) \rightarrow ((B^+ + D^+)_{\text{mp}(B^+) + \text{mp}(D^+)}, (B^- + D^-)_{\text{mp}(B^-) + \text{mp}(D^-)})$ is given by:

$$\begin{array}{c} A^+ \quad C^+ \quad B^- \quad D^- \\ \begin{array}{c} D^+ \\ B^+ \\ C^- \\ A^+ \end{array} \left(\begin{array}{cccc} \emptyset & S_{12} & \emptyset & S_{22} \\ R_{12} & \emptyset & R_{22} & \emptyset \\ \emptyset & S_{11} & \emptyset & S_{21} \\ R_{11} & \emptyset & R_{21} & \emptyset \end{array} \right) \end{array}$$

It is straightforward that \otimes preserves positivity. □

Dually in Int(Rel), negative maps are defined so that they form a monoidal category Neg.

Definition 5.6 (Negative category Neg) The objects of Neg are the same as those of Pos and the morphisms (*negative maps*) are dual; that is, they satisfy the following three conditions:

- 1) $R_{12}[\text{mp}(A^+)] = \text{mp}(B^+)$
- 2) $[\text{mp}(A^-)]R_{21} = \text{mp}(B^-)$
- 3) $[\text{mp}(A^-)]R_{11} = \emptyset = R_{11}[\text{mp}(A^+)]$

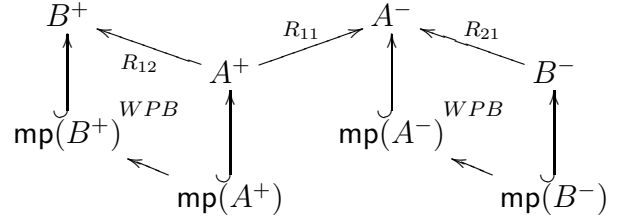

Proposition 5.7 (negative category) Neg forms a monoidal category.

Remark 5.8 (positive \neq negative) Pos maps and Neg maps are different, so the categories are different and the model is in this sense non-degenerate.

The following functor \downarrow is a special instance of the previously-defined functor in Definition 4.9 and dually for \uparrow .

Definition 5.9 (functors \downarrow and \uparrow) Functors $\downarrow: \text{Int(Rel)} \rightarrow \text{Pos}$, $\uparrow: \text{Int(Rel)} \rightarrow \text{Neg}$ are defined as follows:

- On objects: $\downarrow(A^+, A^-) := \uparrow(A^+, A^-) := ((A^+ + 1)_1, (A^- + 1)_1)$
- On morphisms: For $R : (A^+, A^-) \rightarrow (B^+, B^-)$, $\downarrow R$ and $\uparrow R$ are defined by

$$\downarrow R := \uparrow R := \begin{array}{c} 1 \quad A^+ \quad B^- \quad 1 \\ B^+ \\ A^- \\ 1 \end{array} \left(\begin{array}{cccc} (\star, \star) & \emptyset & \emptyset & \emptyset \\ \emptyset & R_{12} & R_{22} & \emptyset \\ \emptyset & R_{11} & R_{21} & \emptyset \\ \emptyset & \emptyset & \emptyset & (\star, \star) \end{array} \right)$$

Note that the functors \uparrow and \downarrow are not full since $\text{Pos} \neq \text{Neg}$.

Proposition 5.10 (adjunctions)

\downarrow (resp. \uparrow) is right (resp. left) adjoint to the forgetful functor $| \cdot |$:

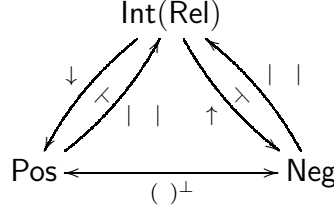

Proof. We show the following:

$$\begin{aligned} \text{Int}(\text{Rel})((A^+, A^-), (B^+, B^-)) &\cong \text{Pos}((A_{\text{mp}(A^+)}^+, A_{\text{mp}(A^-)}^-), ((B^+ + 1)_1, (B^- + 1)_1)) \\ &\cong \text{Neg}(((A^+ + 1)_1, (A^- + 1)_1), (B_{\text{mp}(B^+)}^+, B_{\text{mp}(B^-)}^-)) \end{aligned}$$

where $((B^+ + 1)_1, (B^- + 1)_1) = \downarrow(B^+, B^-)$ and $((A^+ + 1)_1, (A^- + 1)_1) = \uparrow(A^+, A^-)$. Every positive map R' from the R.H.S is of the form

$$\begin{array}{c} A^+ \quad B^- \quad 1 \\ 1 \quad \left(\begin{array}{ccc} \text{mp}(A^+) \times 1 & \emptyset & \emptyset \\ R_{12} & R_{22} & \emptyset \\ R_{11} & R_{21} & 1 \times \text{mp}(A^-) \end{array} \right) \\ B^+ \\ A^- \end{array}$$

so that $R' = R \cup \text{mp}(A^+) \times 1 \cup 1 \times \text{mp}(A^-)$ with R from the L.H.S. This gives a natural bijective correspondence. \square

6 Conclusion and Future Work

In this paper we presented two independent studies of GoI for multiplicative polarized linear logic (MLLP): one based on the notion of GoI situations [1] and the other based on a direct application of Joyal-Street-Verity’s **Int** construction [29]. Both modellings use the idea of adjoining multipoints to account for polarities, hence focusing. In polarized GoI situations, preservation of multipoints via the execution formula allows us to characterize focusing semantically. In the case of the **Int** construction, the goal was instead to construct compact polarized denotational models. This involved adding multipoints to the **Int** construction so as to be compatible with weak pullbacks.

Finally, in the last section, we construct a concrete example of such a polarized category, based on the **Int** construction applied to the category of multipointed relations. For future studies, we leave open the following questions.

(1) What is the logical status of multipoints? For example, multipoints have no counterpart in the syntax: they are an additional structure added to a nonpolarized (although somewhat “degenerate”) compact closed model. Yet multipoints allow us to characterize syntactic questions of polarized logic, for example, characterizing focusing.

(2) This paper is restricted to the multiplicative fragment. It would be interesting to extend this to the full MALLP level, which is the language of Girard’s Ludics, as studied in our paper [23]. This seems more promising compared to nonpolarized additive models because the additive connectives are less complicated in the polarized setting, as mentioned in the work of O. Laurent (for example, [34]). This future work may relate our work to Laurent’s GoI model for additives [33].

References

- [1] S. Abramsky, E.Haghverdi, P. J. Scott: Geometry of Interaction and Linear Combinatory Algebras. *Math. Structures in Computer Science*, **12** (2002), pp. 1–40.
- [2] S. Abramsky and R. Jagadeesan, Games and Full Completeness Theorem for Multiplicative Linear Logic, *J. Symbolic Logic*, Vol.59, No.2 (1994), pp. 543-574.
- [3] J-M. Andreoli, Logic Programming with Focusing Proofs in Linear Logic, *J. Logic and Computation*, **2**(3),(1992).
- [4] J-M. Andreoli, Focussing and proof construction, *Ann. Pure and Applied Logic*, 107(1), (2001), pp. 131-163.
- [5] R. Blute, M. Hamano, P. Scott, Softness of Hypercoherences and MALL Full Completeness. *Ann. Pure and Applied Logic*, 131 (2005), pp. 1-63.
- [6] R. F. Blute and P. J. Scott, Category Theory for Linear Logicians, in *Linear Logic and Computer Science*, T. Ehrhard, J-Y Girard, P. Ruet, P. Scott, eds. London Mathematical Society Lecture Note Series 316, C.U.P. (2004).
- [7] K. Chaudhuri. Focusing Strategies in the Sequent Calculus of Synthetic Connectives. *Logic for Programming, Artificial Intelligence and Reasoning (LPAR-15)*, Doha, Qatar. Springer LNCS 5330 (2008), pp. 467-481.
- [8] K. Chaudhuri, S. Hetzl, D. Miller The Isomorphism Between Expansion Proofs and Multi-Focused Sequent Proofs *J. Logic and Computation* (2013, to appear).
- [9] J.R.B. Cockett, M. Hasegawa, and R.A.G. Seely, Coherence of the Double Involution on *-Autonomous Categories, *TAC* 17(2006), pp 17-29.
- [10] J.R.B. Cockett and R.A.G. Seely, Polarized Category Theory, Modules and Game Semantics, *TAC* 18(2007), pp. 4-101.
- [11] T. Ehrhard, The Scott model of linear logic is the extensional collapse of its relational model, *Theoretical Computer Science*, **424** (23) 2012, pp 20–45
- [12] J-Y. Girard. Linear Logic, *Theoretical Computer Science*, **50**, 1987, 1-102.
- [13] J.-Y. Girard, Geometry of Interaction I: Interpretation of System F, in: *Logic Colloquium '88*, ed. R. Ferro, et al. North-Holland, 1989), pp. 221-260.
- [14] J.-Y. Girard, Geometry of Interaction III: Accommodating the Additives. In: *Advances in Linear Logic*, LNS **222**, CUP, 1995, 329–389.
- [15] J.-Y. Girard, A new constructive logic: classical logic, *Math. Struct. in Comp. Science* 1 (3), (1991), pp. 255-296.
- [16] J.-Y. Girard, On the meaning of logical rules I: syntax vs. semantics, in *Computational Logic*, U.Berger, H.Schwichtenberg, eds. NATO ASI Series 165, Springer, (1999), pp. 215-272.

- [17] J.-Y. Girard, Locus Solum: from the rules of logic to the logic of rules, *Math. Struct. in Comp. Science*, vol. 11 (2001), 301-506.
- [18] J.-Y. Girard, *The Blind Spot: Lectures in Logic*, European Mathematical Society, 2011, 550 pp.
- [19] E. Haghverdi, *A Categorical Approach to Linear Logic, Geometry of Proofs and Full Completeness*, PhD Thesis, University of Ottawa, Canada 2000.
- [20] E. Haghverdi, P.Scott, A Categorical Model for the Geometry of Interaction, *Theoretical Computer Science*, Volume 350, Issues 2-3 , (2006), pp. 252-274.
- [21] E. Haghverdi and P. J. Scott, Geometry of Interaction and the Dynamics of Proof Reduction: a tutorial, New Structures in Physics, *Springer Lectures Notes in Physics*, Vol. 813, R. Coecke (Oxford), ed. (2011) .
- [22] E. Haghverdi and P.J. Scott, Towards a Typed Geometry of Interaction, *Mathematical Structures in Computer Science*, Vol. 20, (2010), Camb. Univ. Press, pp. 473-521.
- [23] M. Hamano, P.Scott, A categorical semantics for polarized MALL, *Ann. Pure & Applied Logic*, 145 (2007), pp. 276-313
- [24] M. Hamano and R. Takemura, An Indexed System for Multiplicative Additive Polarized Linear Logic , Proc. of 17th Annual Conference on Computer Science Logic (CSL'08), Lecture Notes in Computer Science, 5213 (2008), pp. 262-277.
- [25] M. Hamano and R. Takemura, A Phase Semantics for Polarized Linear Logic and Second Order Conservativity, *The Journal of Symbolic Logic* 75 (1) (2010) pp.77-102.
- [26] M. Hasegawa, The uniformity principle on traced monoidal categories. *Publications of the Research Institute for Mathematical Sciences* 40(3) (2004), pp. 991-1014.
- [27] Peter Hines, Types and forgetfulness in categorical linguistics and quantum mechanics, arXiv:1303.3170, (2013).
- [28] J. M. E. Hyland, and A. Schalk , Glueing and Orthogonality for Models of Linear Logic. *Theoretical Computer Science* vol. 294, (2003), pp. 183–231.
- [29] A. Joyal, R. Street, and D. Verity, Traced Monoidal Categories. *Math. Proc. Camb. Phil. Soc.* **119** (1996), pp. 447-468.
- [30] A. Joyal: Joyal's CatLab, Distributors and Barrels, Nov. 2011, in:
http://ncatlab.org/joyalcatlab/show/Distributors+and+barrels#distributors_6
- [31] J. Lambek and P. J. Scott, *Introduction to Higher Order Categorical Logic*, Cambridge Studies in Advanced Mathematics **7**, Cambridge University Press, 1986.
- [32] O. Laurent, Polarized Proof-Nets: Proof-Nets for LC (Extended Abstract), *LNCS 1581 (TLCA '99)* (1999), pp. 213-217.

- [33] O. Laurent, A Token Machine for Full Geometry of Interaction (Extended Abstract), *LNCS 2044 (TLCA '01)* (2001), pp. 283–297.
- [34] O. Laurent, Étude de la polarisation en logique. (A study of polarization in logic.) Thèse de Doctorat. Institut de Mathématiques de Luminy - Université Aix-Marseille II. March 2002.
- [35] C. Liang and D. Miller. Focusing and Polarization in Linear, Intuitionistic, and Classical Logic. *Theoretical Computer Science*, 410(46) (2009), pp. 4747-4768.
- [36] S. Mac Lane: *Categories for the Working Mathematician*, Springer, 1971.
- [37] E. G. Manes and M. A. Arbib, *Algebraic Approaches to Program Semantics*, Springer-Verlag, 1986.
- [38] P.-A. Mellès. Dialogue Categories and Frobenius monoids, in: *Computation, Logic, Games, and Quantum Foundations - The Many Facets of Samson Abramsky* Springer LNCS, Vol. 7860, 2013, pp. 197-224.
- [39] P.-A. Mellès. Dialogue categories and chiralities, manuscript, 2006-2012, <http://www.pps.univ-paris-diderot.fr/~mellies/tensorial-logic.html>
- [40] P.-A. Mellès. Categorical semantics of linear logic. Published in: “Interactive models of computation and program behaviour”. Pierre-Louis Curien, Hugo Herbelin, Jean-Louis Krivine, Paul-André Mellès. *Panoramas et Synthèses* 27, Société Mathématique de France, 2009.
- [41] D. Miller, An Overview of Linear Logic Programming, in *Linear Logic and Computer Science*, T. Ehrhard, J-Y Girard, P. Ruet, P. Scott, eds. LMS Lecture Note Series 316, C.U.P. 2004, pp. 119-150.
- [42] D. Miller. Tutorial: Sequent Calculus: overview and recent developments, 8th Panhellenic Logic Symposium Ioannina, Greece, July 4-8, 2011 (slides available: <http://www.lix.polytechnique.fr/Labo/Dale.Miller/papers/pls8.html>)
- [43] Alex Simpson and Gordon Plotkin Complete Axioms for Categorical Fixed-point Operators, *Proc. 15th Annual IEEE Symposium on Logic in Computer Science (LICS)*, IEEE Computer Society, 2000, pp. 30-41.

7 Appendices

7.1 Appendix 1: GoI situations and Execution formulas for MELL

In [1] the authors introduced a general algebraic framework for studying Girard’s Geometry of Interaction (GoI) ([13, 14]) for multiplicative-exponential linear logic, MELL. This framework, called a *GoI Situation*, contains an underlying traced monoidal category \mathcal{C} , along with a reflexive object U and an endofunctor T used to represent the exponentials of linear logic. It is shown in that paper how to interpret GoI as yielding linear combinatory algebras on the endomorphism monoids $End_{\mathcal{C}}(U)$.

In later work ([20, 21]) the underlying traced category \mathcal{C} of a GoI situation was specialized to a traced Unique Decomposition Category (e.g. **Rel**, **Pfn**, **Plnj**) (see Appendix 7.2 below) which is equipped with a standard *particle-style* trace, as developed in Haghverdi's thesis [19], together with an abstract categorical execution formula given in terms of that trace (see below). The categorical GoI interpretation of Haghverdi-Scott (which captures Girard's GoI1 [13]) contains three components: (i) an interpretation of proofs in $End_{\mathcal{C}}(U)$, (ii) an interpretation of formulas as types (= bi-orthogonally closed subsets of $End_{\mathcal{C}}(U)$, with respect to an appropriate Girard-Hyland-Schalk orthogonality), and (iii) an analysis of the dynamics of cut-elimination via the execution formula. For the polarized system MLLP studied in this paper, we only discuss (i) and (iii).

Definition 7.1 A *GoI Situation* is a triple (\mathcal{C}, T, U) where:

1. \mathcal{C} is a traced symmetric monoidal category and $T : \mathcal{C} \rightarrow \mathcal{C}$ is a traced symmetric monoidal functor with the following *monoidal* retractions (i.e. the retraction pairs are monoidal natural transformations):
 - (a) $e' : T \triangleright TT : e$ (Comultiplication)
 - (b) $d' : T \triangleright Id : d$ (Dereliction)
 - (c) $c' : T \triangleright T \otimes T : c$ (Contraction)
 - (d) $w' : T \triangleright \mathcal{K}_I : w$ (Weakening). Here \mathcal{K}_I is the constant I functor.
2. U is an object of \mathcal{C} , called a *reflexive object*, with retractions:
 - (a) $k : U \triangleright U \otimes U : j$
 - (b) $U \triangleright I$,
 - (c) $v : U \triangleright TU : u$

Here $e' : T \triangleright TT : e$ means that there are monoidal natural transformations $e_X : TTX \rightarrow TX$ and $e'_X : TX \rightarrow TTX$ such that $e'e = Id_{TT}$. We say that TT is a (*monoidal*) *retract* of T . Similarly for the other items.

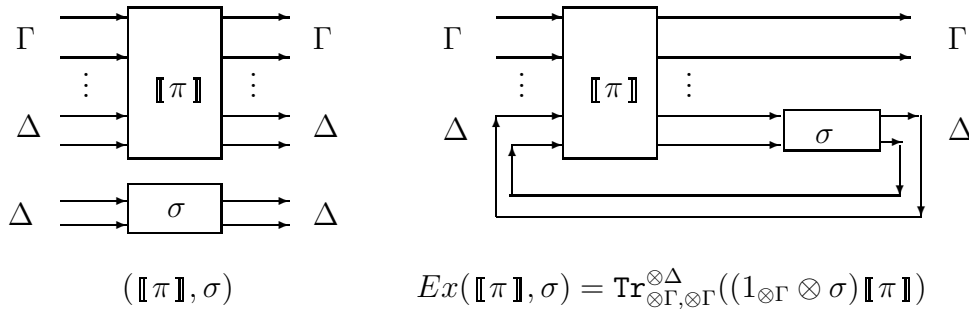

Figure 6: Proofs of $\vdash [\Delta], \Gamma$ as I/O Boxes and the Execution Formula

Following the presentation in [20, 21], given a GoI situation (\mathcal{C}, T, U) , the GoI interpretation of a proof π of an MELL sequent (with explicit cuts) $\vdash [\Delta], \Gamma$ (where Δ denotes the set of all pairs of cut formulas A, A^\perp used in π) is determined by a pair of morphisms $(\llbracket \pi \rrbracket, \sigma)$ as in Figure 6, where σ represents the cuts Δ . If $|\Delta| = 2m$ and $|\Gamma| = n$, these data are given by \mathcal{C} -arrows, $\sigma : U^{2m} \rightarrow U^{2m}$, $\llbracket \pi \rrbracket : U^{n+2m} \rightarrow U^{n+2m}$. Finally, Girard's *Execution Formula*

determines an arrow $\text{Ex}(\llbracket \pi \rrbracket, \sigma) : U^n \rightarrow U^n$, where $U^k = U \otimes \cdots \otimes U$ (k times). If \mathcal{C} is a Haghverdi traced Unique Decomposition Category (UDC) with a standard (particle-style) trace (as in the Rel-based models in this paper: see Appendix 7.2 below) we can write the Execution Formula in the more familiar form

$$\text{Ex}(\llbracket \pi \rrbracket, \sigma) = \pi_{11} + \sum_{n \geq 0} \pi_{12}(\sigma \pi_{22})^n(\sigma \pi_{21}) \quad (18)$$

where $[\pi_{ij}]$ is the matrix representation of $\llbracket \pi \rrbracket$; this was shown in [20] to agree with Girard's original execution formula [13] in his model $\text{Hilb}_2 (= \ell_2[\text{PInj}])$. Such UDC models also support a robust matrix calculus to represent morphisms, which agrees with the usual matrix representation of relations used in this paper (see Proposition 7.2 below).

7.2 Appendix 2: Unique Decomposition Categories (UDCs)

E. Haghverdi, in his thesis [19], introduced *Unique Decomposition Categories* (UDCs). These were specifically developed for modelling ‘‘particle-style’’ GoI as in GoI 1 [13, 20].

Briefly, UDCs are symmetric monoidal categories with the following additional structure:

- The homsets are enriched with a Σ -monoid additive structure, such that composition distributes over addition, both from the left and the right. For the precise Σ -monoid axioms, we refer to Haghverdi's thesis, Chapter 4. In particular, there are zero morphisms $0_{XY} : X \rightarrow Y$ between any two objects X, Y .
- For a finite set I and for each $j \in I$, there are *quasi injections* $\iota_j : X_j \rightarrow \otimes_I X_i$, and *quasi projections* $\rho_j : \otimes_I X_i \rightarrow X_j$ such that:
 1. $\rho_k \iota_j = \text{Id}_{X_j}$ if $j = k$ and $0_{X_j X_k}$ otherwise.
 2. $\sum_{i \in I} \iota_i \rho_i = \text{Id}_{\otimes_I X_i}$.

Examples of UDC's (for Geometry of Interaction) include variations of Rel_+ , for example: the categories Pfn and PInj of *partial functions* (resp. *partial injective functions*).

The main theorem on UDC's, which is used in various places in this paper, is the representation of morphisms as matrices, with an associated full matrix calculus for computations. This can be summarized as follows (see Haghverdi [19], Prop. 4.0.6):

Proposition 7.2 (Matricial Representation) *Given a morphism $f : \otimes_J X_j \rightarrow \otimes_I Y_i$ in a UDC, with $|I| = m, |J| = n$, there exists a unique family $\{f_{ij}\}_{i \in I, j \in J} : X_j \rightarrow Y_i$ with $f = \sum_{i \in I, j \in J} \iota_i f_{ij} \rho_j$, where $f_{ij} = \rho_i f \iota_j$. Moreover, composition of morphisms in a UDC corresponds to matrix multiplication of their associated matrices.*

7.3 Appendix 3: Generalized Yanking for a traced monoidal category

The following identity is frequently used in calculating traces (see Proposition 2.4, in [1]),

$$\text{Tr}_{X,Y}^U(s \circ (f \otimes g)) = g \circ f$$

Pictorially, this says:

$$\begin{array}{c}
 \text{X} \longrightarrow \boxed{\begin{array}{c} f \\ g \end{array}} \begin{array}{l} \longrightarrow \text{U} \\ \longrightarrow \text{Y} \end{array} \\
 \text{U} \longrightarrow \boxed{\begin{array}{c} f \\ g \end{array}} \begin{array}{l} \longrightarrow \text{U} \\ \longrightarrow \text{Y} \end{array}
 \end{array}
 = X \xrightarrow{f} U \xrightarrow{g} Y$$

7.4 Appendix 4: Omitted Proofs

Proof of Proposition 3.7

By induction on the construction of a multipoint \mathbf{p} .

(Base Case): This is when \mathbf{p} is the distinguished point α , hence the property is the original lifting property 6'.

(Induction Case): \mathbf{p} is constructed either by 2 or 3 of Definition 3.5 (Note in 2, the \mathbf{p} is a point.): We define

\mathbf{p} constructed by 3	\mathbf{p} constructed by 2
$r_{\mathbf{p}} := (j \otimes 1^{m_1+m_2}) \circ (r_{\mathbf{p}_1} \otimes r_{\mathbf{p}_2}) \circ k$	$r_{\mathbf{p}} := (j \otimes 1) \circ (U \otimes r_{\mathbf{p}'}) \circ k$
$!_{\mathbf{p}} := j \circ (!_{\mathbf{p}_1} \otimes !_{\mathbf{p}_2}) \circ (k \otimes 1^{m_1+m_2})$	$!_{\mathbf{p}} := j \circ (U \otimes !_{\mathbf{p}'}) \circ (k \otimes 1)$

Then the commutativity property follows from I.H.'s (the lower square of the following diagram) and the retractions $U \triangleright U^2$ and $U \otimes 1^k \triangleright U^2 \otimes 1^k$ with k either $m_1 + m_2$ or 1 by Axiom 2 (the upper right and left vertical arrows, respectively):

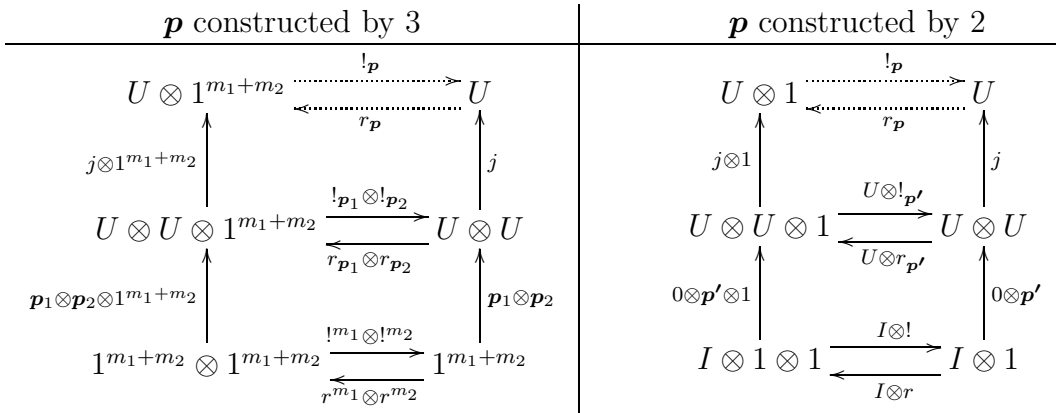

We check one commutativity for each of the constructions 2 and 3 of \mathbf{p} .

\mathbf{p} constructed by 3	\mathbf{p} constructed by 2	
$ \begin{aligned} & r_{\mathbf{p}} \circ j \circ (\mathbf{p}_1 \otimes \mathbf{p}_2) \circ !_{m_1+m_2} \\ &= (j \otimes 1^{m_1+m_2}) \circ (r_{\mathbf{p}_1} \otimes r_{\mathbf{p}_2}) \circ k \circ j \\ & \quad \circ (\mathbf{p}_1 \otimes \mathbf{p}_2) \circ !_{m_1+m_2} \\ &= (j \otimes 1^{m_1+m_2}) \circ (r_{\mathbf{p}_1} \otimes r_{\mathbf{p}_2}) \\ & \quad \circ (\mathbf{p}_1 \otimes \mathbf{p}_2) \circ !_{m_1+m_2} \\ &= (j \otimes 1^{m_1+m_2}) \circ (\mathbf{p}_1 \otimes \mathbf{p}_2 \otimes 1^{m_1+m_2}) \\ &= \mathbf{p} \otimes 1^{m_1+m_2} \end{aligned} $	$ \begin{aligned} & r_{\mathbf{p}} \circ j \circ (0 \otimes \mathbf{p}') \circ (I \otimes !) \\ &= (j \otimes 1) \circ (U \otimes r_{\mathbf{p}'}) \circ k \circ j \\ & \quad \circ (0 \otimes \mathbf{p}') \circ (I \otimes !) \\ &= (j \otimes 1) \circ (U \otimes r_{\mathbf{p}'}) \\ & \quad \circ (0 \otimes \mathbf{p}') \circ (I \otimes !) \\ &= (j \otimes 1) \circ (0 \otimes \mathbf{p}' \otimes 1) \\ &= \mathbf{p} \otimes 1 \end{aligned} $	<p>the retraction $U \triangleright U^2$</p> <p>the lower square the definition of \mathbf{p}</p>

Proof of Lemma 3.9

These retractions are compatible with traced monoidal categories [1] by virtue of dinaturality and the directions of the retractions (k_m, j_m) and $(!_{\mathbf{p}}, r_{\mathbf{p}})$, respectively, as follows:

$$\begin{aligned}
\text{For (1); } & \text{Tr}_{X,Y}^U((j \otimes Y) \circ f \circ (k \otimes X)) \\
&= \text{dinaturality} \\
& \text{Tr}_{X,Y}^{U^m}(f \circ (k \otimes X)) \circ (j \otimes X) \\
&= \\
& \text{Tr}_{X,Y}^{U^m}(f \circ (k \circ j \otimes X)) \\
&= \text{ } k \circ j = \text{Id}_{U^m} \\
& \text{Tr}_{X,Y}^{U^m}(f)
\end{aligned}$$

$$\begin{aligned}
\text{For (2); } & \text{Tr}_{X,Y}^{U \otimes 1^m}((r_{\mathbf{p}} \otimes Y) \circ g \circ (!_{\mathbf{p}} \otimes X)) \\
&= \text{dinaturality} \\
& \text{Tr}_{X,Y}^U(g \circ (!_{\mathbf{p}} \otimes X)) \circ (r_{\mathbf{p}} \otimes X) \\
&= \\
& \text{Tr}_{X,Y}^U(g \circ (!_{\mathbf{p}} \circ r_{\mathbf{p}} \otimes X)) \\
&= \text{ } !_{\mathbf{p}} \circ r_{\mathbf{p}} = \text{Id}_U \\
& \text{Tr}_{X,Y}^U(g)
\end{aligned}$$

See the following pictures in Figure 7, in which Tr^{U^m} is described via vanishing II.

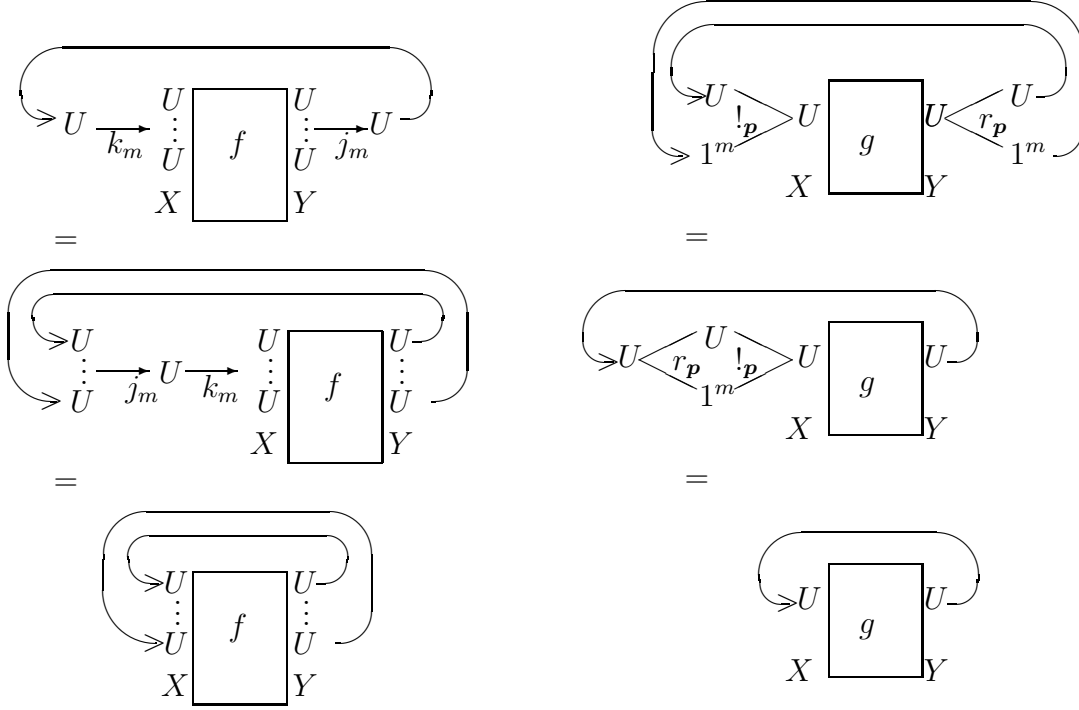

Invariance w.r.t $U \triangleright_{(k_m, j_m)} U^m$

Invariance w.r.t. $U \otimes 1^m \triangleright_{(!_{\mathbf{p}}, r_{\mathbf{p}})} U$

Figure 7: Invariance of traces under conjugate actions

7.5 Appendix 5: Remarks on Retractions $U \triangleright_{(k,j)} U \otimes U$ and $U \otimes 1 \triangleright_{(!\alpha, r_\alpha)} U$

The reader may wonder about the opposite directions of the retractions $U \triangleright_{(k,j)} U \otimes U$ and $U \otimes 1 \triangleright_{(!\alpha, r_\alpha)} U$ in the two-layered GoI interpretation $\llbracket \pi \rrbracket$ and f_π .

(i) (On the retraction $U \triangleright_{(k,j)} U \otimes U$)

The retract $U \otimes U$ (of U) follows the form of the logical constructions. In (untyped) GoI, where there is a reflexive object U , the interpretations of \otimes and \wp are indistinguishable. In general, for any formula A , U_A is identified with U . So to make sense of the logical connectives, via reflexivity of U , we use the retraction. Thus $U_A \otimes U_B$, which is $U \otimes U$ is faithfully projected to U which is defined to be both $U_{A \otimes B}$ as well as $U_A \wp B$. Similarly, letting $U_\downarrow = U_\uparrow = U$, we have $U_\downarrow \otimes U_A$ (resp. $U_A \otimes U_\uparrow$) is faithfully projected to U , which itself is defined to be $U_{\downarrow A}$ (resp. $U_{\uparrow A}$). The faithfulness is guaranteed by $k \circ j = \text{Id}_{U \otimes U}$. Note that at the level of the U 's, the dual logical connectives \downarrow and \uparrow are not distinguishable, just as \otimes and \wp are not distinguishable. However to account for the asymmetry in logical rules for the polarities, we will need to employ a new ingredient, the object 1 .

(ii) On the retraction $U \otimes 1 \triangleright_{(!\alpha, r_\alpha)} U$

The retract 1 (of $1 \otimes 1$) is for the sake of realizing the retract U (of $U \otimes 1$) of the lifting property (along α) of Definition 3.1. Then what is the meaning of the retraction $U \otimes 1 \triangleright_{(!\alpha, r_\alpha)} U$? Tensoring 1 with U in the construction of $r_\alpha : U \rightarrow U \otimes 1$ corresponds to making the point $\alpha : 1 \rightarrow U$ explicitly appear. Conversely $!_\alpha : U \otimes 1 \rightarrow U$ hides the point α (i.e. makes it implicit). The faithfulness of making the point α explicit is guaranteed by $!_\alpha \circ r_\alpha = \text{Id}_U$, i.e. intuitively, making α explicit, then hiding it gives the identity.

For a multipoint $\text{mp}(A) : 1^m \xrightarrow{p} U$ for any given polarized formula A so that $\mathbb{1}_A \cong 1^m$, the retraction $1 \otimes 1 \triangleright_{(!, r)} 1$ and its lifting $U \otimes 1 \triangleright_{(!\alpha, r_\alpha)} U$ are correspondingly generalized into the retraction $1^m \otimes 1^m \triangleright_{(!^m, r^m)} 1^m$ and the lifting $U \otimes 1^m \triangleright_{(!^p, r^p)} U$ of Axiom 6' of Proposition 3.7. These retractions are in order to accommodate polarities in U and in 1^m .

(iii) Note also the opposite directions of retractions between (i) and (ii) above are compatible with the conjugate actions of Lemma 3.9.

7.6 Appendix 6: Pictorial Proof for Prop 3.21 (Ex is an Invariant)

L.H.S. of (9)

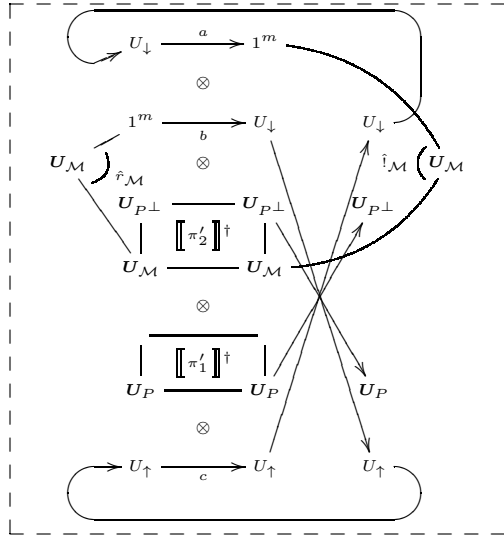

naturality

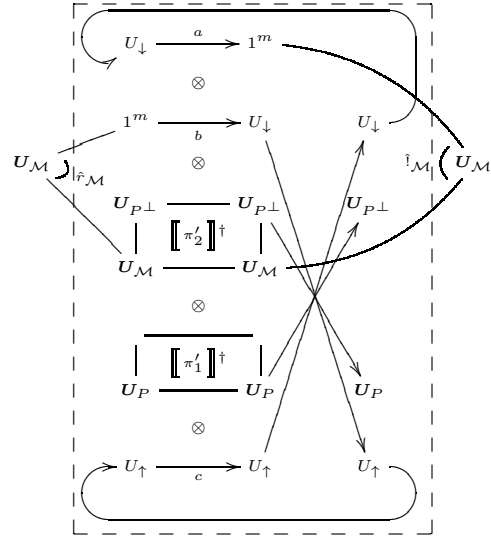

superposing

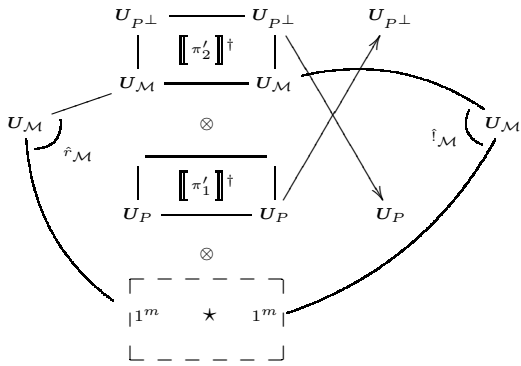

\star is L.H.S of Fig for (10) when $f = b, g = c$ and $h = a$.

(10) and $c = 0$

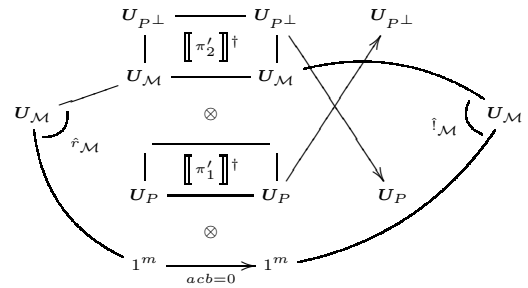

Ax 9'

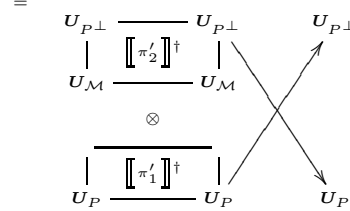

R.H.S. of (9)