

ON THE CLASSIFICATION OF A LARGE SET OF RATIONAL 3-TANGLE DIAGRAMS

BO-HYUN KWON

ABSTRACT. We note that a rational 3-tangle diagram is obtained from a combination of four generators. There is an algorithm to distinguish two rational 3-tangle diagrams up to isotopy. ([5]) However, there is no perfect classification about rational 3-tangle diagrams such as the classification of rational 2-tangle diagrams corresponding to rational numbers. In this paper, we classify a large set of rational 3-tangles which are generated by only three generators.

1. INTRODUCTION

A *3-tangle* is the disjoint union of 3 properly embedded arcs in the unit 3-ball. The embedding must send the endpoints of the arcs to 6 fixed points on the ball's boundary. Without loss of generality, consider the fixed points on the 3-ball boundary to lie on a great circle. The tangle can be arranged to be in general position with respect to the projection onto the disk in the xy -plane bounded by the great circle. The projection then gives us a tangle diagram where we make note of over and undercrossings as with knot diagrams. Then we say that a 3-tangle $\alpha_1 \cup \alpha_2 \cup \alpha_3$ in B^3 is *rational* if there exists a homeomorphism of pairs $\bar{h} : (B^3, \alpha_1, \alpha_2, \alpha_3) \rightarrow (D^2 \times I, \{x_1, x_2, x_3\} \times I)$. Also, we define that two rational 3-tangles, \mathbb{T}, \mathbb{T}' , in B^3 are *isotopic*, denoted by $\mathbb{T} \approx \mathbb{T}'$, if there is an orientation-preserving self-homeomorphism $h : (B^3, \mathbb{T}) \rightarrow (B^3, \mathbb{T}')$ that is the identity map on the boundary. Also we say that two rational 3-tangle diagrams T and T' are *isotopic*, denoted by $T \sim T'$, if there exist two rational 3-tangles \mathbb{T} and \mathbb{T}' so that $\mathbb{T} \approx \mathbb{T}'$ and T and T' are projections of \mathbb{T} and \mathbb{T}' respectively.

In 1970, Conway [4] introduced tangles and he proved that two rational 2-tangles are isotopic if and only if they have the same rational number. However, there is no similar invariant known which classifies rational 3-tangles. Currently, the author [5] found an algorithm to check whether or not two rational 3-tangle diagrams are isotopic by using a modified version of Dehn's method for classifying simple closed curves on surfaces.

We note that the rational 3-tangles are obtained by four generators extended from four half Dehn twists on $\Sigma_{0,6}$. (Refer to [5].) Especially, if we use two proper generators of them then we obtain a family of all the rational 3-tangle diagrams presented by the braids group with three strings, \mathbb{B}_3 , such as the first diagram in Figure 1. Recently, Cabrera-Ibarra ([2], [3]) found a pair of invariants which is defined for all rational 3-tangles. Each invariant is a 3×3 matrix with complex number entries. The pair of invariants classifies the elements of six special sets of rational 3-tangles each of which contains the braid 3-tangles. In this paper, we are investigating a large set of rational 3-tangles, $\mathcal{T}_{\{\hat{\sigma}_1, \hat{\sigma}_2, \hat{\sigma}_3\}}$, which are generated by the three

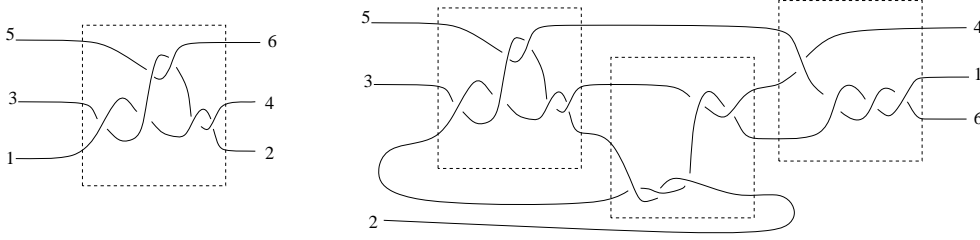
FIGURE 1. Two examples in $\mathcal{T}_{\{\hat{\sigma}_1, \hat{\sigma}_2, \hat{\sigma}_3\}}$

generators $\hat{\sigma}_1, \hat{\sigma}_2, \hat{\sigma}_3$, where $\hat{\sigma}_1, \hat{\sigma}_2, \hat{\sigma}_3$ are extensions of the three half Dehn twists $\sigma_1, \sigma_2, \sigma_3$ on $\Sigma_{0,6}$. (See Figure 6.) We note that our family of rational 3-tangle diagrams contains at least five of the special sets by Cabrera-Ibarra. We also note that our set contains lots of rational 3-tangle diagrams which are not in the six special sets.

The following is the main corollary of this paper that classifies $\mathcal{T}_{\{\hat{\sigma}_1, \hat{\sigma}_2, \hat{\sigma}_3\}}$. We will prove this corollary in Section 3.

Corollary 13 Suppose that two rational 3-tangle diagrams $T_F, T_G \in \mathcal{T}_{\{\hat{\sigma}_1, \hat{\sigma}_2, \hat{\sigma}_3\}}$. $T_F \sim T_G$ if and only if $[F(\partial E_1)] = [G(\partial E_1)]$ and $(F(\epsilon_2) \cup F(\epsilon_3), B^3) \approx (G(\epsilon_2) \cup G(\epsilon_3), B^3)$.

2. DEHN PARAMETERIZATION OF \mathcal{C}

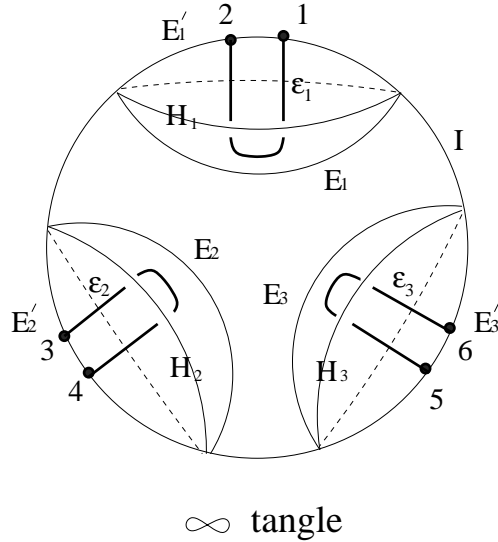

FIGURE 2.

Let $\Sigma_{0,6}$ be the six punctured sphere and $(B^3, \epsilon) = (B^3, \epsilon_1 \cup \epsilon_2 \cup \epsilon_3)$ be the trivial tangle (or ∞ tangle) as in Figure 2. Also, let E_i be the three disjoint essential disks in $B^3 - \epsilon$ as in Figure 2. Then we have the three 2-punctured disks E'_i in $\Sigma_{0,6}$ so that $\partial E'_i = \partial E_i$. Then

we note that $E_i \cup E'_i$ bounds the ball H_i which only contains ϵ_i . Let $E = E_1 \cup E_2 \cup E_3$ and $E' = E'_1 \cup E'_2 \cup E'_3$. Also, let $\partial E = \partial E' = \partial E_1 \cup \partial E_2 \cup \partial E_3$. Then we can get the pair of pants $I = (\Sigma_{0,6} - E')$.

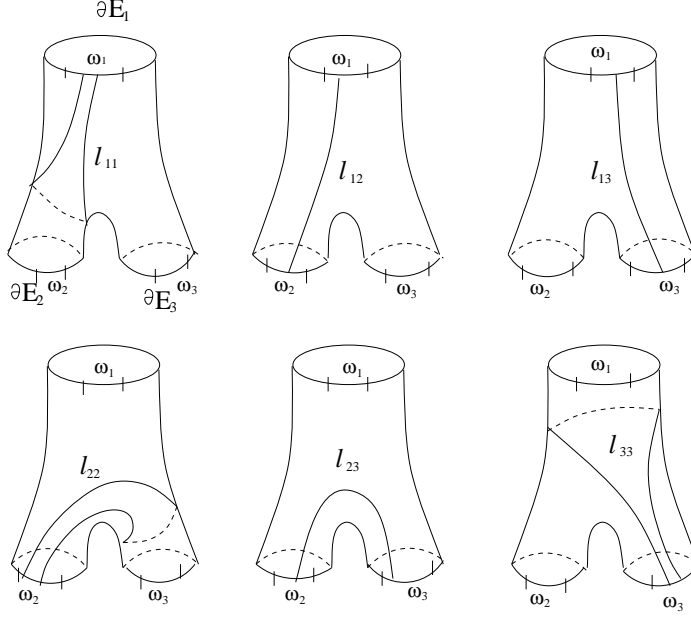

FIGURE 3. Standard arcs l_{ij}

Let γ be a simple closed curve in $\Sigma_{0,6}$.

Figure 3 shows *standard arcs* l_{ij} in the pair of pants I . We notice that we can isotope γ into δ in $\Sigma_{0,6}$ so that each component of $\delta \cap I$ is isotopic to one of the standard arcs and $\delta \cap \partial E_i \subset \omega_i$. Then we say that subarc α of δ is *carried by* l_{ij} if some component of $\alpha \cap I$ is isotopic to l_{ij} . The closed arc $\omega_i \subset \partial E_i$ is called a *window*.

Let $I_i = |\delta \cap \omega_i|$. Then δ can have many parallel arcs which are the same type in I . Let x_{ij} be the number of parallel arcs of the type l_{ij} which is called the *weight* of l_{ij} .

We define a bigon as follows. For two simple subarcs λ and μ of a collection K of simple closed curves in a surface Σ , (Δ, λ, μ) is a *bigon* in a surface Σ if $\lambda \cup \mu$ bounds a disk Δ in Σ and $\partial \lambda = \partial \mu = \lambda \cap \mu$. Then we say that a bigon Δ is *innermost* if $\Delta^\circ \cap K = \emptyset$.

Now, consider E'_1 . Let j_1 and k_1 be the simple arcs as in Figure 4. We assume that $\partial E'_1 \cup \delta \cup j_1 \cup k_1 \cup l_1$ has no bigon in $\Sigma_{0,6}$. We note that $j_1 \cup k_1 \cup l_1$ separates E'_1 into two semi-disks $E'_1{}^+$ and $E'_1{}^-$ as in Figure 4. Let u_1^+ be the number of subarcs of δ from l_1 to j_1 in $E'_1{}^+$. Also, let v_1^+ be the number of subarcs of δ from l_1 to k_1 in $E'_1{}^+$ and let w_1^+ be the number of subarcs of δ from j_1 to k_1 in $E'_1{}^+$. Let $m_1 = |\delta \cap j_1|$ and $n_1 = |\delta \cap k_1|$ in E'_1 . For example, in the third diagram of Figure 4, we have $u_1^+ = 0$, $v_1^+ = 3$, $w_1^+ = 4$, $m_1 = 4$ and $n_1 = 7$.

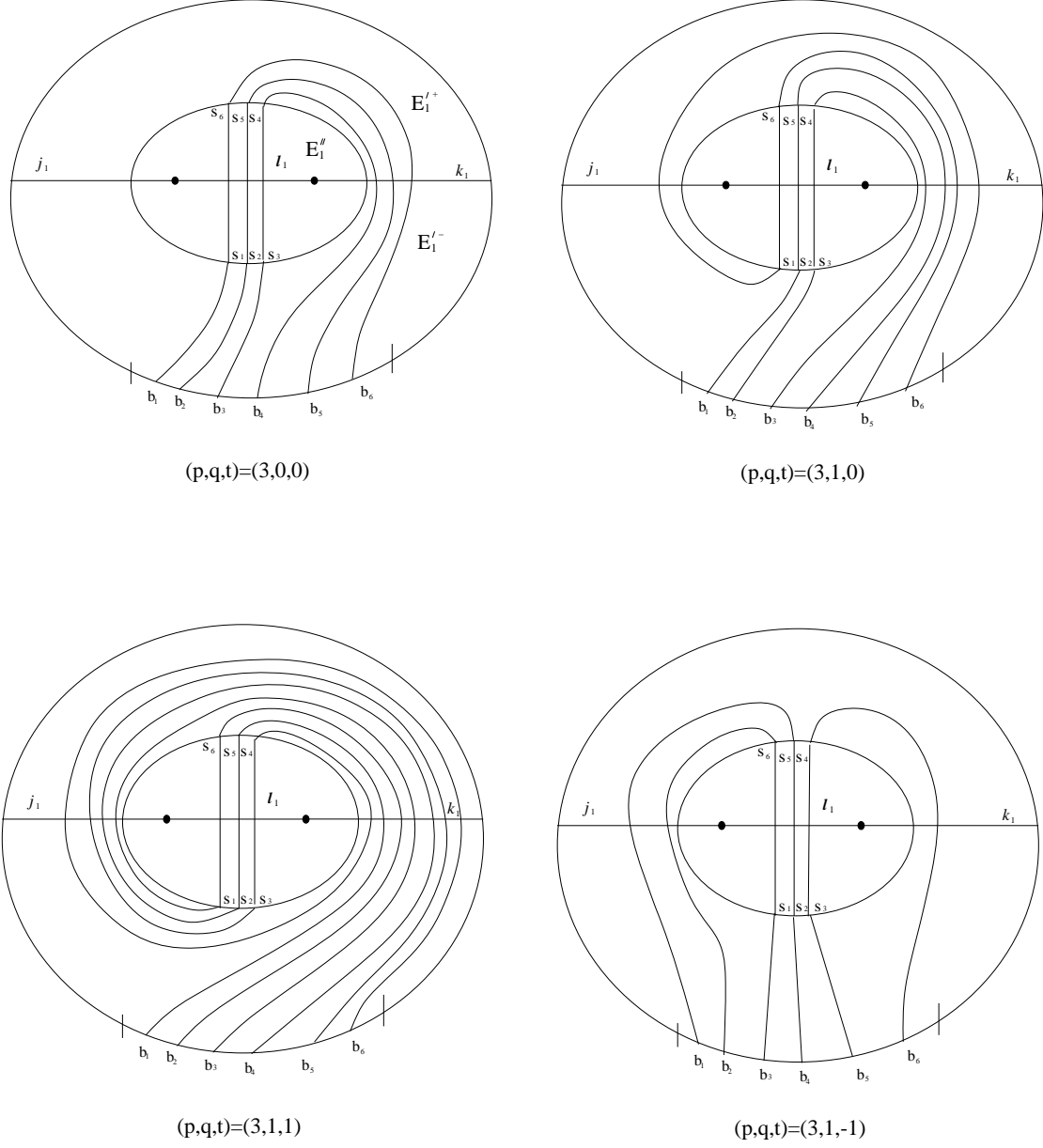

FIGURE 4.

We notice that each component of $\delta \cap E'_1$ meets l_1 exactly once. Also, we know that each such component is essential in E'_1 . Let E''_1 be the nested 2-punctured disk in E'_1 as in Figure 4. We can isotope δ in E'_1 so that all the components of $\delta \cap E''_1$ are pairwise parallel. Then, let $I' = \Sigma_{0,6} - \{E''_1 \cup E''_2 \cup E''_3\}$.

The components of $\delta \cap E'_1$ are determined by three parameters p_1, q_1, t_1 as in Figure 4, where $p_1 = \min\{|\delta' \cap l_1| \mid \delta' \sim \delta \text{ in } \Sigma_{0,6}\}$, $q_1 \in \mathbb{Z}$, $0 \leq q_1 < p_1$. In order to define q_1 and t_1 , consider m_1 and n_1 . Then we know that $u_1^+ + v_1^+ = p_1$. So, $m_1 - n_1 = (u_1^+ + w_1^+) - (v_1^+ + w_1^+) = u_1^+ - v_1^+$. Therefore, $-p_1 = -u_1^+ - v_1^+ \leq u_1^+ - v_1^+ = m_1 - n_1 = u_1^+ - v_1^+ \leq u_1^+ + v_1^+ = p_1$. So, we know

$-p_1 \leq m_1 - n_1 \leq p_1$. Now, we define q_1 and t_1 as follows. If $n_1 - m_1 = p_1$ then $q_1 \equiv m_1 \pmod{p_1}$ and $0 \leq q_1 < p_1$, and $t_1 = \frac{m_1 - q_1}{p_1}$ and if $-p_1 \leq n_1 - m_1 < p_1$ then $q_1 \equiv -m_1 \pmod{p_1}$ and $0 \leq q_1 < p_1$, and $t_1 = \frac{-m_1 - q_1}{p_1}$. Then t_1 is called the *twisting number* in E'_1 . Also, let (p_1, q_1, t_1) be the three parameters to determine the arcs in E'_1 . Similarly, we have the three parameters (p_i, q_i, t_i) for E'_i ($i = 2, 3$). Then γ is determined by a sequence of nine parameters $(p_1, q_1, t_1, p_2, q_2, t_2, p_3, q_3, t_3)$ by Lemma 1.

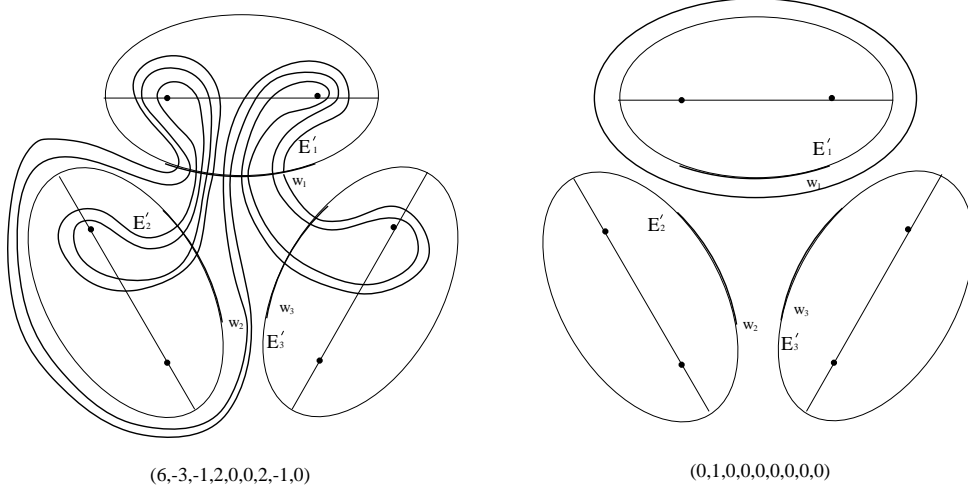

FIGURE 5. Essential curves obtained by a sequece of nine parameters

Lemma 1 ([5]). *From I_i ($i = 1, 2, 3$), we have $x_{ij} = I_j$, $x_{ik} = I_k$ and $x_{ii} = \frac{I_i - I_j - I_k}{2}$.*

Let \mathcal{C} be the set of isotopy classes of simple closed curves in $\Sigma_{0,6}$. For a given simple closed curve δ in a hexagon diagram, we define p_i , q_i and t_i in E'_i as above. Then let $q'_i = p_i t_i + q_i$ for $i = 1, 2, 3$.

Theorem 2 (Special case of Dehn's Theorem). *There is an one-to-one map $\phi : \mathcal{C} \rightarrow \mathbb{Z}^6$ so that $\phi(\delta) = (p_1, p_2, p_3, q'_1, q'_2, q'_3)$. i.e., it classifies isotopy classes of simple closed curves.*

When $p_1 = p_2 = p_3 = 0$ then $t'_i = 1$ if the simple closed curve is isotopic to $\partial E'_i$ and $t'_j = 0$ if $j \neq i$. Refer [1] to see the general Dehn's theorem.

We will use a sequence of nine parameters instead of six parameters for convenience in the rest of this paper.

Lemma 3. *If γ bounds an essential disk in $B^3 - \epsilon$ and $|\gamma \cap \partial E| \neq \emptyset$, then $x_{ii} \geq 2$ for some $i \in \{1, 2, 3\}$.*

Proof. Let D be an essential disk in $B^3 - \epsilon$ so that $\partial D = \gamma$. Then we know that E_i will separates D into some sub-disks D_i since $|\gamma \cap \partial E| \neq \emptyset$. We notice that at least two of D_i need to be bounded by a bigon. One side of bigons needs to be a component of $\gamma \cap I$ and another side of bigons is a properly embedded arc in E_i for some i since H_i cannot have a bigon. If H_i has a bigon then the disk Δ bounded by the bigon should meet ϵ_i . This makes

a contradiction. So, we need $x_{11} + x_{22} + x_{33} \geq 2$. However, l_{ii} and l_{jj} cannot coexist for $i \neq j$. This implies that $x_{ii} \geq 2$ for some $i \in \{1, 2, 3\}$. \square

Consider the three half Dehn twists $\sigma_1, \sigma_2, \sigma_3$ and σ_4 supported on the 2-punctured disks A, B, E'_1 and E'_3 counter clockwise as in Figure 6. Then let $\hat{\sigma}_i$ be an isotopy extension to B^3 of σ_i for $i = 1, 2, 3$. Then we note that $\hat{\sigma}_1, \hat{\sigma}_2, \hat{\sigma}_3, \hat{\sigma}_4$ generates all the rational 3-tangles. (Refer to [5].)

Let $\mathcal{T}_{\{\hat{\sigma}_1, \hat{\sigma}_2, \hat{\sigma}_3\}}$ be the set of rational 3-tangles which are generated by $\hat{\sigma}_1, \hat{\sigma}_2, \hat{\sigma}_3$. Actually, the main goal of this paper is the classification of $\mathcal{T}_{\{\hat{\sigma}_1, \hat{\sigma}_2, \hat{\sigma}_3\}}$.

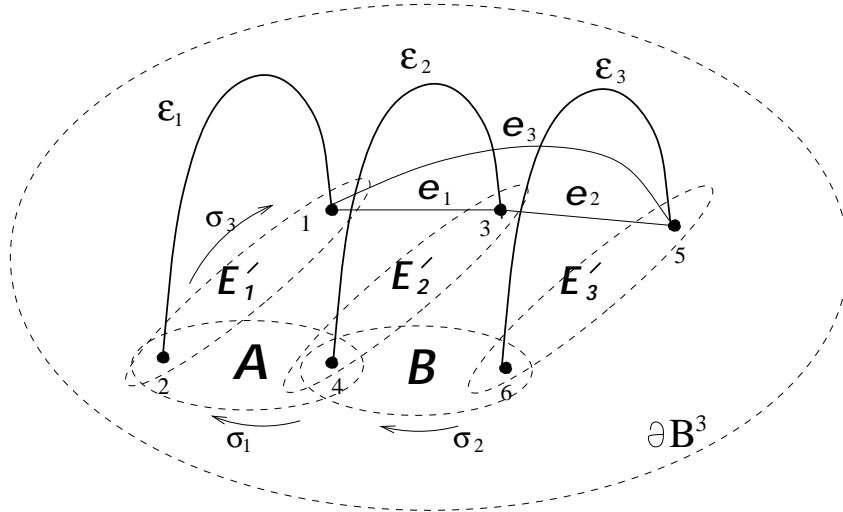

FIGURE 6.

Let f and g be orientation preserving homeomorphisms from $\Sigma_{0,6}$ to $\Sigma_{0,6}$. Then we have isotopy extensions F and G of f and g respectively to B^3 . Let $\mathbb{T}_F = (F(\epsilon), B^3)$ and $\mathbb{T}_G = (G(\epsilon), B^3)$. Then we have the following theorem.

Theorem 4 ([5]). *For two rational 3-tangles \mathbb{T}_F and \mathbb{T}_G , $\mathbb{T}_F \approx \mathbb{T}_G$ if and only if $G^{-1}F(\partial E)$ bounds essential disks in $B^3 - \epsilon$.*

Actually, if $G^{-1}F(\partial E_i)$ and $G^{-1}F(\partial E_j)$ bound essential disks in $B^3 - \epsilon$ for $i \neq j$ then $G^{-1}F(\partial E_k)$ also bounds an essential disk in $B^3 - \epsilon$ for $k \neq i, j$. So, it is enough to check whether two of them bound essential disks or not. The following lemma supports this argument.

Lemma 5 ([5]). *Suppose that two essential simple closed curves α, β ($\approx \alpha$) bound disjoint disks in $B^3 - \epsilon$. If γ is an essential simple closed curve which encloses two punctures, disjoint with α and β and non-parallel to α and β , then γ bounds an essential disk in $B^3 - \epsilon$.*

Let γ_1 and γ_2 be disjoint two simple closed curves in $\Sigma_{0,6}$. Then we consider a rectangle R (or band) in $\Sigma_{0,6}$ so that the interior of R is disjoint with $\gamma_1 \cup \gamma_2$ and $R_i = \gamma_i \cap R$ is a side of R for $i = 1, 2$. Let R_3 and R_4 be the other two sides of R .

Now, we define the *band sum* of γ_1 and γ_2 by R , denoted by $\gamma_1 +_R \gamma_2$, which is $(\gamma_1 \cup \gamma_2) \cup (R_3 \cup R_4) - (R_1^o \cup R_2^o)$. Then we have the following lemma.

Lemma 6. *Let γ_1 and γ_2 be two disjoint, non-parallel simple closed curves in $\Sigma_{0,6}$ which enclose only two punctures of $\{1, 2, 3, 4, 5, 6\}$. Then $\gamma_1 +_R \gamma_2$ is disjoint with γ_1 and γ_2 up to isotopy and it is a non-parallel simple closed curve to γ_1 and γ_2 which encloses only two punctures of $\{1, 2, 3, 4, 5, 6\}$.*

Proof. Take γ'_i which is parallel to γ_i and the 2-punctured disk bounded by γ'_i contains γ_i . We also need to assume that γ'_1 and γ'_2 are disjoint. Then we can take R' so that $\gamma'_1 +_{R'} \gamma'_2$ is isotopic to $\gamma_1 +_R \gamma_2$ and $\gamma'_1 +_{R'} \gamma'_2$ is disjoint with both γ_1 and γ_2 .

Let $\{a, b\}$ and $\{c, d\}$ be the two punctures which are enclosed in γ_1 and γ_2 respectively. Since γ_1 and γ_2 are two disjoint, non-parallel simple closed curves in $\Sigma_{0,6}$, they have $\{a, b\} \cap \{c, d\} = \emptyset$. Then we note that $\gamma_1 +_R \gamma_2$ enclose the two punctures $\{1, 2, 3, 4, 5, 6\} - \{a, b, c, d\}$. This implies that $\gamma_1 +_R \gamma_2$ are not parallel to both γ_1 and γ_2 . \square

Now, we consider the “standard parameterization” of \mathcal{C} for easier argument in the next section.

3. STANDARD PARAMETERIZATION OF \mathcal{C} AND THE PROOF OF MAIN THEOREM

First, let γ be a simple closed curve which bounds an essential disk in $B^3 - \epsilon$. Then by Lemma 3, $x_{ii} \geq 2$ for some $i \in \{1, 2, 3\}$. Without loss of generality, assume that $x_{11} \geq 2$. So, $x_{22} = x_{33} = 0$.

Now, we modify γ into γ_0 so that γ_0 bounds an essential disk in $B^3 - \epsilon$ if and only if γ does and every components of $\gamma_0 \cap P'$ are isotopic to one of arcs in the given diagrams as in Figure 7 which are called *standard diagrams*. Also, we say that γ_0 is in *standard position* if γ_0 has a standard diagram.

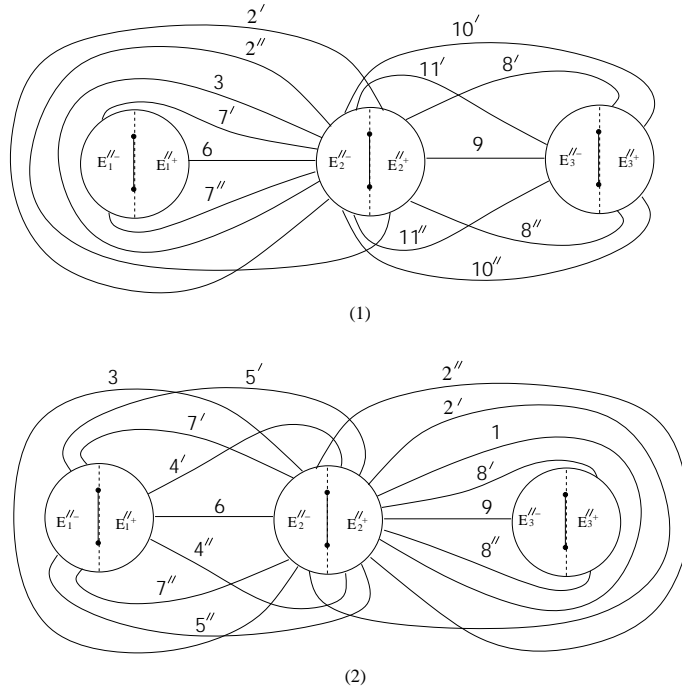

FIGURE 7. Standard diagrams

The following lemma shows us how to modify γ into γ_0 so that γ_0 has a standard diagram.

Lemma 7 ([5]). *Suppose that γ' is a simple closed curve which is parameterized by $(p_1, q_1, 0, p_2, q_2, 0, p_3, q_3, 0)$. If $x_{11} > 0$, then we can construct a simple closed curve γ_0 which is parameterized by $(p_1, q_1, t_1, p_2, q_2, t_2, p_3, q_3, t_3)$ for $t_i \in \mathbb{Z}$ as in the table below, and it bounds an essential disk in $B^3 - \epsilon$ if γ' does. Moreover, each component of $\gamma_0 \cap I'$ is carried by one of the given arc types in one of the standard diagrams.*

$$(1) \quad q_1 + p_1 < x_{11} + x_{13} : (t_1, t_2, t_3) = (0, -1, 0) \text{ if } p_2 \neq 0, (t_1, t_2, t_3) = (0, 0, 0) \text{ if } p_2 = 0.$$

$$(2) \quad q_1 + p_1 \geq x_{11} + x_{13} : (t_1, t_2, t_3) = (-1, -1, 0) \text{ if } p_2 \neq 0, (t_1, t_2, t_3) = (-1, 0, 0) \text{ if } p_2 = 0.$$

Moreover, if we have the following condition then γ' does not bound an essential disk in $B^3 - \epsilon$.

$$(3) \quad x_{11} + x_{13} \leq q_1 + p_1 < x_{11} + x_{12} + x_{13} \text{ and } x_{13} \geq q_1.$$

Then γ_0 should satisfy the following condition to bound an essential disk in $B^3 - \epsilon$.

Lemma 8 ([5]). *Suppose that γ_0 is a simple closed curve which bounds an essential disk A in $B^3 - \epsilon$ and it is in standard position with $x_{11} > 0$. Then $m_1 + m_3 > 0$.*

Let m_i be the number of the arcs which are isotopic to arc type i . We note that there are two non-isotopic arc types i' and i'' for some arc type i , where i' is the upper arc type of i and i'' is the lower arc type of i . Then we define $m_{i'}$ and $m_{i''}$ which are the weight of each of the arc types. So, $m_i = m_{i'} + m_{i''}$.

Now, we have the following three lemmas which support the main theorem.

Lemma 9 ([5]). *γ_0 bounds an essential disk in $B^3 - \epsilon$ if and only if $(\delta_1 \delta_2^{-1})^{\pm 1}(\gamma_0)$ does, where δ_1 and δ_2 be half Dehn twists counter clockwise supported on two punctured disks C_1 and C_2 respectively. (Refer to Figure 8.)*

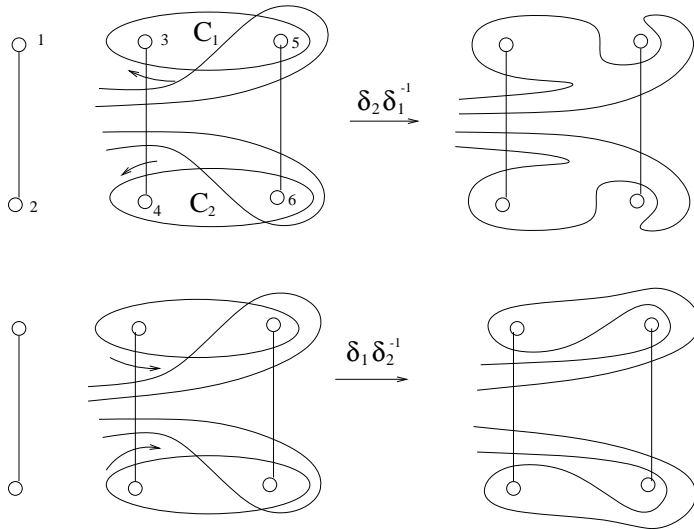

FIGURE 8.

Lemma 10 ([5]). γ_0 bounds an essential disk in $B^3 - \epsilon$ if and only if $\delta_3^{\pm 1}(\gamma_0)$ does, where δ_3 be a half Dehn twist counter clockwise supported on the punctured disk E'_4 . (Refer to Figure 9.)

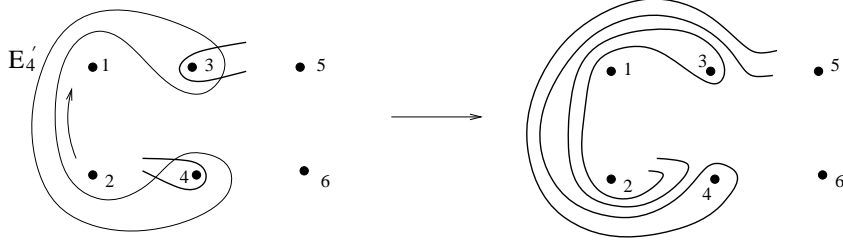

FIGURE 9.

Lemma 11. Suppose that γ_0 is in standard position with $m_3 > 0$. If $m_{2'} = m_{8'} = m_{11'} = 0$ and $m_{8''} + m_{11''} > 0$, then γ_0 does not bound an essential disk in $B^3 - \epsilon$.

Proof. Suppose that γ_0 is in standard position with $m_3 > 0$ and $m_{2'} = m_{8'} = m_{11'} = 0$ and $m_{8''} + m_{11''} > 0$.

Now, we consider several subcases for this. We note that $m_9 > 0$. If not, then there is no output either from $E_1^{''+}$ or from $E_3^{''-}$. Then, it contradicts the connectivity of arcs in E_1'' or E_3'' .

First, assume that $m_{2''} = 0$.

We claim that $m_{10''} > 0$ and $m_{8''} > 0$ if $m_{11''} = 0$. The proof is as follows; If both $m_{10''}$ and $m_{8''}$ are zero, then γ_0 cannot be a simple closed curve because of the connectivity of arcs in E_3'' . If $m_{10''} > 0$ and $m_{8''} = 0$ ($m_{11''} = 0$) then the uppermost arc of type 10'' and the lowermost arc of type 9 make the simple closed curve γ_0 . We easily can check that it does not bound an essential disk in $B^3 - \epsilon$ by the fundamental group argument. If $m_{8''} > 0$ and $m_{10''} = 0$ ($m_{11''} = 0$) then we can take the uppermost arc of type 9 and the lowermost arc of type 8'' and the outermost arc of type 3 which make the simple closed curve γ_0 . However, we can check that γ_0 does not bound an essential disk in $B^3 - \epsilon$ because γ_0 encloses exactly three punctures in $\Sigma_{0,6}$ and it is impossible to bound an essential disk in $B^3 - \epsilon$. Therefore, $m_{10''} > 0$ and $m_{8''} > 0$ if $m_{11''} = 0$.

We also note that $m_{10''} > 0$ and $m_{11''} > 0$ if $m_{8''} = 0$ by a similar argument in the previous claim. It is impossible that both $m_{8''}$ and $m_{11''}$ are positive since they intersect. So, we have the following two cases.

Case 1. Suppose that $m_{8''} = 0$. Then we have the diagram as in Figure 10. So, we have two conditions $m_{10''} = m_{11''} + m_9$ for E_3'' and $m_9 > m_{10''} + m_{11''}$ for E_1'' . This implies that $m_9 > m_{11''} + m_9 + m_{11''} \geq m_9$. It makes a contradiction.

Case 2. Suppose that $m_{11''} = 0$. Then we have the diagram as in Figure 11. Let $m_{8''} = a$ and $m_{10''} = b$. Then we can consider the three subcases as follows.

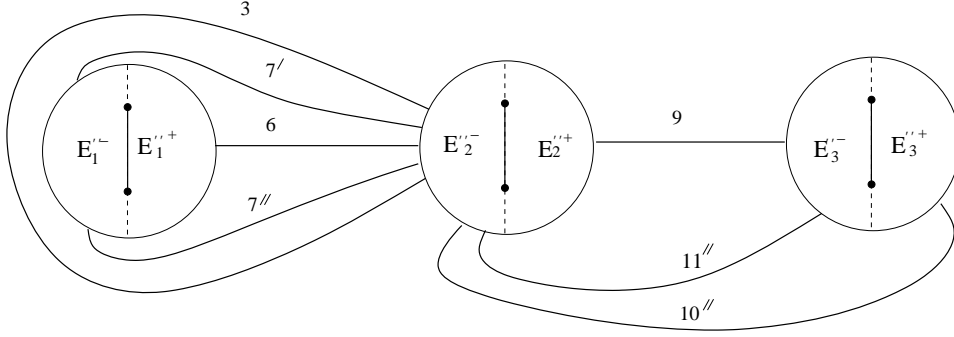

FIGURE 10.

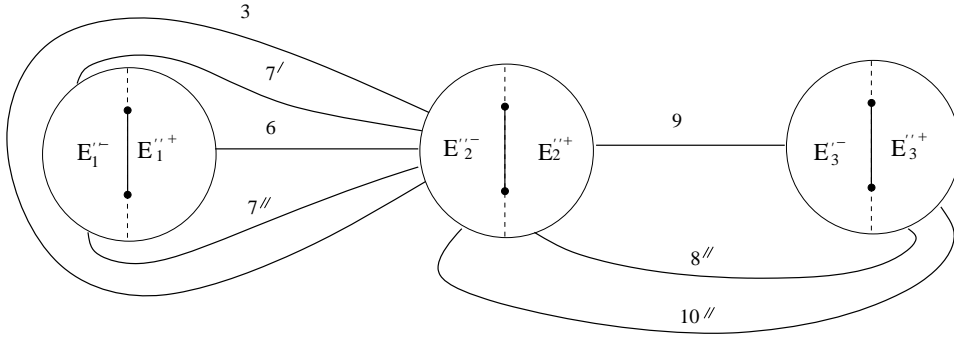
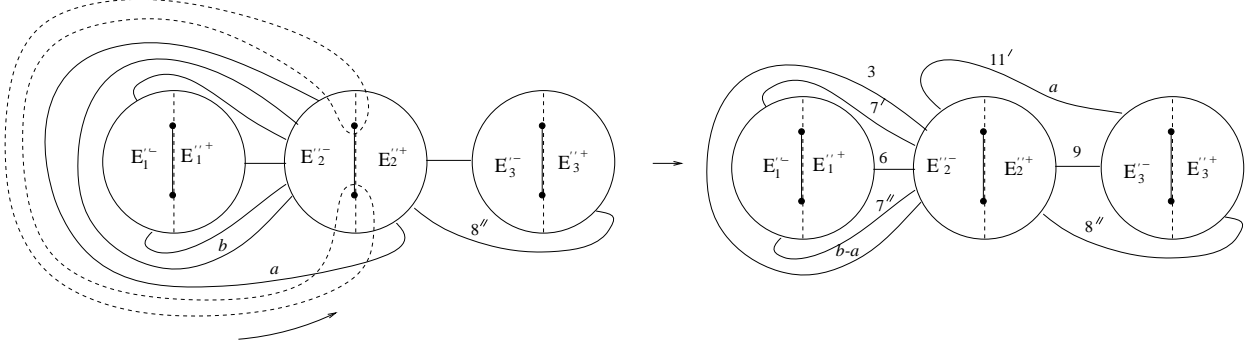

FIGURE 11.

- (1) $m_{8''} = m_{10''}$: Apply the homeomorphism $\delta_1^{-1}\delta_2$ to γ_0 . Then we have a case that has $m_2 = m_{10} = m_{11} = 0$. However, we already knew that $\delta_1^{-1}\delta_2(\gamma_0)$ does not bound an essential disk in $B^3 - \epsilon$. By Lemma 9, we see that γ_0 also does not bound an essential disk in $B^3 - \epsilon$.
- (2) $m_{8''} < m_{10''}$: We also apply the homeomorphism $\delta_1^{-1}\delta_2$ to γ_0 . Then we have the same diagram as in Figure 11. Let m'_i be the weights of the newly obtained diagram by applying $\delta_1^{-1}\delta_2$. Then we have $m'_{8''} = m_{8''}$ and $m'_{10''} = m_{10''} - m_{8''}$. If $m'_{10''} \geq m'_{8''}$, then we return to one of the cases (1) and (2). If $m'_{10''} < m'_{8''}$, then we move to the next case.
- (3) $m_{8''} > m_{10''}$: We apply the homeomorphism $\delta_1^{-1}\delta_2$ to γ_0 . Then $\delta_1^{-1}\delta_2(\gamma_0)$ has $m'_{8''} = m_{10''}, m'_{10''} = 0$ and $m'_{2''} = m_{8''} - m_{10''} > 0$. So, we move to the case that $m_{2''} > 0$.

Second, we assume that $m_{2''} > 0$.

Then, we notice that $m_{10''} = m_{11''} = 0$ since the arcs for $m_{10''}$ and $m_{11''}$ intersect with the arc for $m_{2''}$. Let $m_{2''} = a, m_3 = b$ and $m_{8''} = c$ for convenience. Also, let m'_i be the weights of the new diagram by applying δ_3 or $\delta_1^{-1}\delta_2$.

 FIGURE 12. $m_{2''} > 0$

We apply the half Dehn twist δ_3 to γ_0 . Here, we note that $b > a$. If not, then $\delta_3(\gamma_0)$ has $m'_1 + m'_3 = 0$. It violates Lemma 3 and Lemma 8.

Then $\delta_3(\gamma_0)$ has the new weights $m'_3 = b - a$ and $m'_{11'} = a$ as the second diagram of Figure 12. Now, we consider the three subcases.

- (1) $a = c$: Then $m'_9 = 0$. This implies that $m'_3 = 0$ and it contradicts the condition to bound an essential disk in $B^3 - \epsilon$.
- (2) $a > c$: It violates the condition $c \geq a$ for the connectivity in E''_3 .

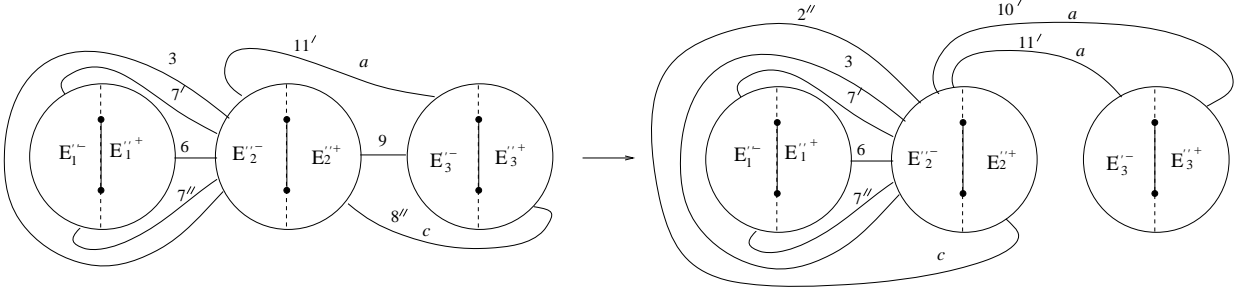

FIGURE 13.

- (3) $a < c$: Apply the homeomorphism $\delta_1^{-1}\delta_2$ to $\delta_3(\gamma_0)$. Let $\gamma_1 = \delta_1^{-1}\delta_2(\delta_3(\gamma_0))$. Let m''_i be the weights for γ_1 . Then we have $m''_3 = b - a > a$. Otherwise, $\delta_3(\gamma_1)$ does not bound an essential disk in $B^3 - \epsilon$. This implies that γ_1 also does not bound an essential disk in $B^3 - \epsilon$. We also have $m_{2''} = c$ and $m_{10'} = m_{11'} = a$ for γ_1 as the second diagram of Figure 13. This implies that $m_9 = 0$ because of the connectivity in E''_3 . Therefore, $m_3 = 0$ because of the connectivity in E''_2 . This violates the condition that $m_3 > 0$. Therefore, if γ has $m_{2''} > 0$ then γ does not bound an essential disk in $B^3 - \epsilon$.

These complete this lemma. □

Now, we will prove the main theorem.

Theorem 12. *Suppose that two rational 3-tangle diagrams $T_F, T_G \in \mathcal{T}_{\{\hat{\sigma}_1, \hat{\sigma}_2, \hat{\sigma}_3\}}$. $T_F \approx T_G$ if and only if $[G^{-1}F(\partial E_1)] = [\partial E_1]$ and $(G^{-1}F(\epsilon_2) \cup G^{-1}F(\epsilon_3), B^3) \approx (\epsilon_2 \cup \epsilon_3, B^3)$.*

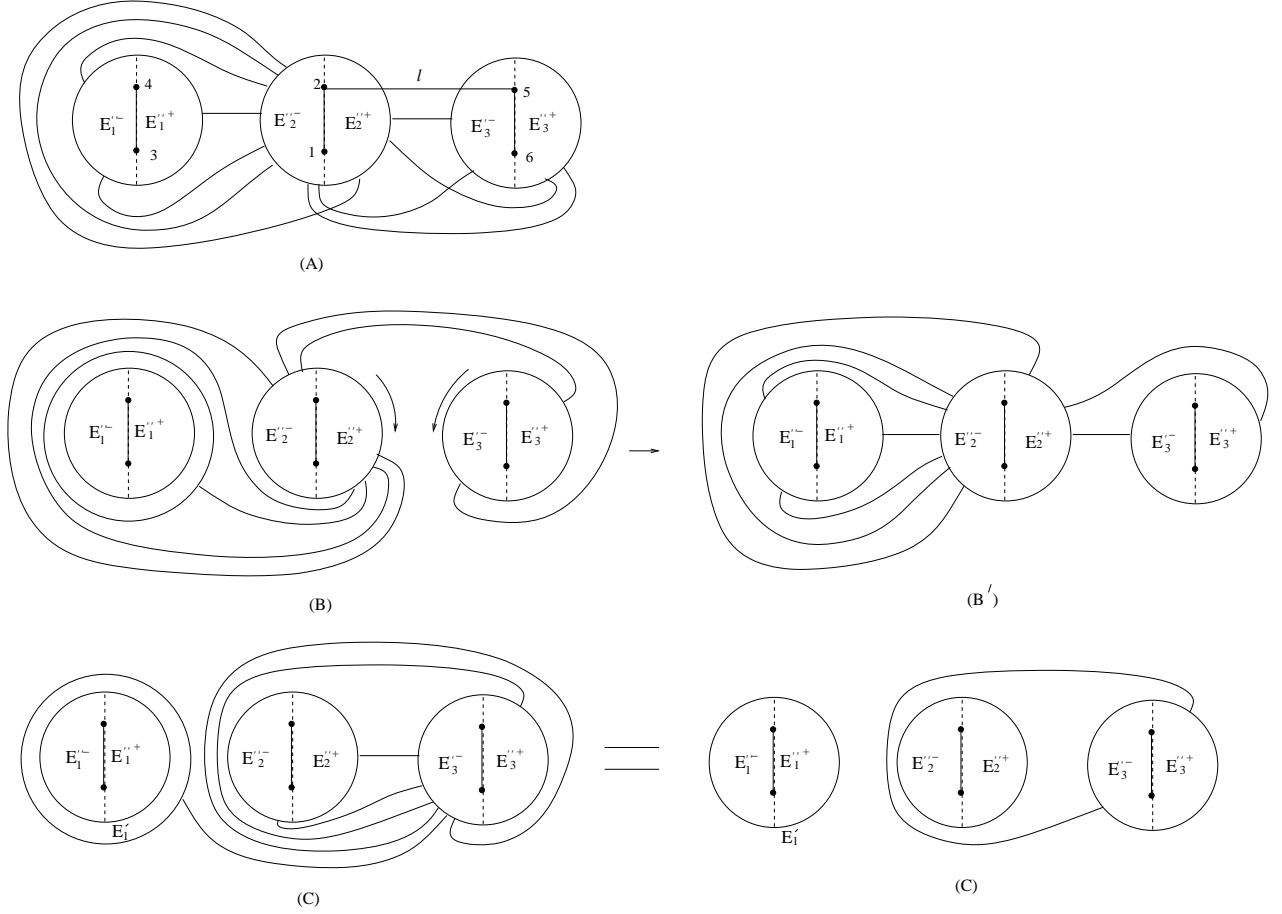

FIGURE 14.

Proof. Since $T_F \approx T_G$, we know that $T_{G^{-1}F} \approx T_{id}$. By Lemma 4, $G^{-1}F(\partial E_1)$ bounds an essential disk in $B^3 - \epsilon$. So, $G^{-1}F(\partial E_1)$ is isotopic to either ∂E_2 or a simple closed curve γ_0 which has $x_{ii} > 0$ for some i . Let l be a simple arc between the puncture 2 and the puncture 5 as in the first diagram of Figure 14. Let $|A \cap B|$ be the minimal intersection number between A and B .

Claim: $|\gamma_0 \cap l| = 0$.

Proof of Claim. We note that $|\partial E_1 \cap l| = 0$. For a simple closed curve γ , if $|\gamma \cap l| = 0$ then $|\sigma_i^{\pm 1}(\gamma) \cap l| = 0$ for $i = 1, 2, 3$. This completes the proof of this claim.

Now, we have some possible cases (A), (B) and (C) for γ_0 which has $|\gamma_0 \cap l| = 0$.

We note that any simple closed curve for the cases (A) and (B') cannot bound an essential disk in $B^3 - \epsilon$ by using the similar argument in Lemma 11. In the case (B), we get (B') from (B) by applying half Dehn twists supported on E_2'' and E_3'' with the given direction as

in the diagram (B).

Also, it is not difficult to show that the any simple closed curves for the case (C) cannot bound an essential disk in $B^3 - \epsilon$ by considering the connectivity of arcs in E'_i . Therefore, $G^{-1}F(\partial E_1)$ should be isotopic to ∂E_1 .

Now, it is clear that if $T_F \approx T_G$ then $[G^{-1}F(\partial E_1)] = [\partial E_1]$ and $(G^{-1}F(\epsilon_2) \cup G^{-1}F(\epsilon_3), B^3) \approx (\epsilon_2 \cup \epsilon_3, B^3)$ by the previous argument.

To show the other direction, assume that $T_F \not\approx T_G$ and $[G^{-1}F(\partial E_1)] = [\partial E_1]$. We will show that $(G^{-1}F(\epsilon_2) \cup G^{-1}F(\epsilon_3), B^3) \not\approx (\epsilon_2 \cup \epsilon_3, B^3)$

We consider $G^{-1}F(\partial E_3)$. We note that $G^{-1}F(\partial E_3)$ is non-parallel, disjoint with $G^{-1}F(\partial E_1)$ which is isotopic to ∂E_1 since ∂E_1 and ∂E_3 are disjoint.

Consider the band sum as in Figure 15. We note that the band sum slides over the two punctures $\{1, 2\}$.

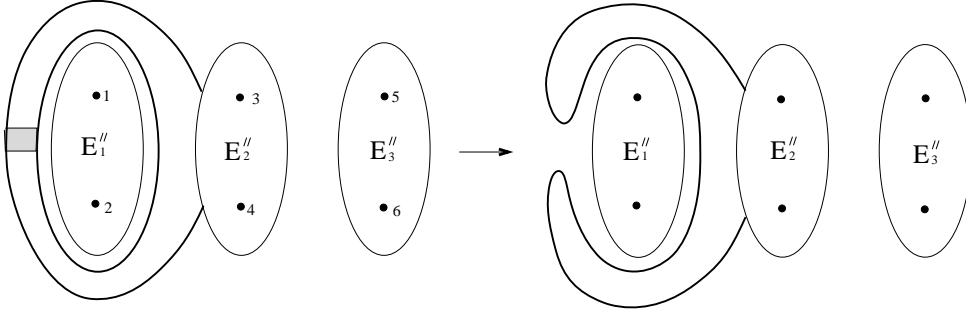

FIGURE 15.

Also, by Lemma 6, $G^{-1}F(\partial E_3) +_R \partial E_1$ is non-parallel, disjoint with both $G^{-1}F(\partial E_3)$ and ∂E_1 . Especially, since $G^{-1}F(\partial E_3)$ is disjoint, non-parallel with ∂E_1 up to isotopy, we can use the band sum anytime we want. This implies that we can ignore the two punctures $\{1, 2\}$ when we check whether or not $G^{-1}F(\partial E_3)$ bounds an essential disk in $B^3 - \epsilon$. Also, we note that there is unique simple closed curve which bounds an essential disk in $B^3 - (\epsilon_2 \cup \epsilon_3)$ and especially it is isotopic to ∂E_3 .

So, if $(G^{-1}F(\epsilon_2) \cup G^{-1}F(\epsilon_3), B^3) \approx (\epsilon_2 \cup \epsilon_3, B^3)$ then we note that $G^{-1}F(\partial E_3)$ does bound an essential disk in $B^3 - \epsilon$ since ∂E_1 does. Then we have $T_{G^{-1}F}$ is the ∞ -tangle diagram. This implies that $T_F \approx T_G$. This contradicts the assumption that $T_F \not\approx T_G$. Therefore, $(G^{-1}F(\epsilon_2) \cup G^{-1}F(\epsilon_3), B^3) \not\approx (\epsilon_2 \cup \epsilon_3, B^3)$ and it completes the proof.

This completes this Theorem.

□

Corollary 13. *Suppose that two rational 3-tangle diagrams $T_F, T_G \in \mathcal{T}_{\{\hat{\sigma}_1, \hat{\sigma}_2, \hat{\sigma}_3\}}$. $T_F \sim T_G$ if and only if $[F(\partial E_1)] = [G(\partial E_1)]$ and $(F(\epsilon_2) \cup F(\epsilon_3), B^3) \approx (G(\epsilon_2) \cup G(\epsilon_3), B^3)$.*

Proof. It is a modification of Theorem 12. □

REFERENCES

- [1] R. C. Penner with J. L. Harer, *combinatorics of Train Tracks*, Annals of Mathematics Studies No. 125, Princeton University Press (1992), Sections 1.1-1.2.
- [2] H. Cabrera-Ibarra, *On the classification of rational 3-tangles*, J. Knot Theory Ramifications 12 (2003), no. 7, 921-946.
- [3] H. Cabrera-Ibarra, *Results on the classification of rational 3-tangles*, J. Knot Theory Ramifications 13 (2004), no. 2, 175-192.
- [4] J. Conway, *An enumeration of knots and links, and some of their algebraic properties*, 1970 Computational Problems in Abstract Algebra (Proc. Conf., Oxford, 1967) pp. 329-358 Pergamon, Oxford
- [5] B. Kwon, *An algorithm to classify rational 3-tangles*, preprint, arXiv:1406.4496.