

A KNOT WITH DESTABILIZED BRIDGE SPHERES OF ARBITRARILY HIGH BRIDGE NUMBER

YEONHEE JANG, TSUYOSHI KOBAYASHI, MAKOTO OZAWA, AND KAZUTO TAKAO

ABSTRACT. We show that there exists an infinite family of knots, each of which has, for each integer $k \geq 0$, a destabilized $(2k+5)$ -bridge sphere. We also show that, for each integer $n \geq 4$, there exists a knot with a destabilized 3-bridge sphere and a destabilized n -bridge sphere.

1. INTRODUCTION

We study bridge spheres of knots in the 3-sphere, paying particular attention to destabilized ones. Any knot admits infinitely many bridge spheres, and to classify them is a general problem. In particular, studying destabilized ones is essential because all the others can be obtained from them by stabilizations up to isotopy. (See Section 2 for definitions.)

Some knots admit unique destabilized bridge spheres up to isotopy. Otal [10] showed that the trivial knot admits no other destabilized bridge spheres than those isotopic to the canonical 1-bridge sphere. Schubert [16] showed that each non-trivial rational knot admits a unique 2-bridge sphere up to isotopy, and Otal [11] showed that it admits no other destabilized bridge spheres than those isotopic to the 2-bridge sphere. The third author [12] obtained the corresponding result for torus knots. Zupan [19] showed that if a meridionally small knot admits a unique destabilized bridge sphere up to isotopy, then any cable knot of it also does.

Some knots, however, admit multiple non-isotopic destabilized bridge spheres. Birman [2] gave a composite knot with two non-isotopic destabilized 3-bridge spheres. Montesinos [7] gave a prime knot with two non-isotopic destabilized 3-bridge spheres. Johnson–Tomova [5] gave a knot with two non-isotopic destabilized bridge spheres which are far apart in the sense of stable equivalence. The first author [3, 4] gave a knot with four destabilized 3-bridge spheres which are pairwise non-isotopic. The third and fourth authors [13] gave a knot with a destabilized 3-bridge sphere and a destabilized 4-bridge sphere.

In this paper, we give an infinite family of knots, each of which has a 5-bridge sphere and destabilized bridge spheres of arbitrarily high bridge number, as follows.

2010 *Mathematics Subject Classification.* 57M25.

Key words and phrases. knots, bridge spheres, stabilizations.

The first author is supported by Grant-in-Aid for Research Activity Start-up (No. 25887039). The second author is supported by Grant-in-Aid for Scientific Research (C) (No. 25400091). The third author is partially supported by Grant-in-Aid for Scientific Research (C) (No. 23540105) and Grant-in-Aid for Scientific Research (C) (No. 26400097). The fourth author is supported by Grant-in-Aid for JSPS Fellows (No. 26-3358) and Grant-in-Aid for Young Scientists (B) (No. 26800042).

Theorem 1. Let $K_{p_1, p_2, p_3, p_4, q, k}$ and $S_{p_1, p_2, p_3, p_4, q, k}$ be the knot and the sphere, respectively, shown in Figure 1, for integers p_1, p_2, p_3, p_4, q and a non-negative integer k . The knot type of $K_{p_1, p_2, p_3, p_4, q, k}$ does not depend on k , and if $|2p_i + 1| \geq 5$ for each $i \in \{1, 2, 3, 4\}$ and q is an even number with $|q| \geq 12$, then $S_{p_1, p_2, p_3, p_4, q, k}$ is a destabilized $(2k + 5)$ -bridge sphere of $K_{p_1, p_2, p_3, p_4, q, k}$.

For the proof of the assertion that $S_{p_1, p_2, p_3, p_4, q, k}$ is destabilized, we show the strong irreducibility of it.

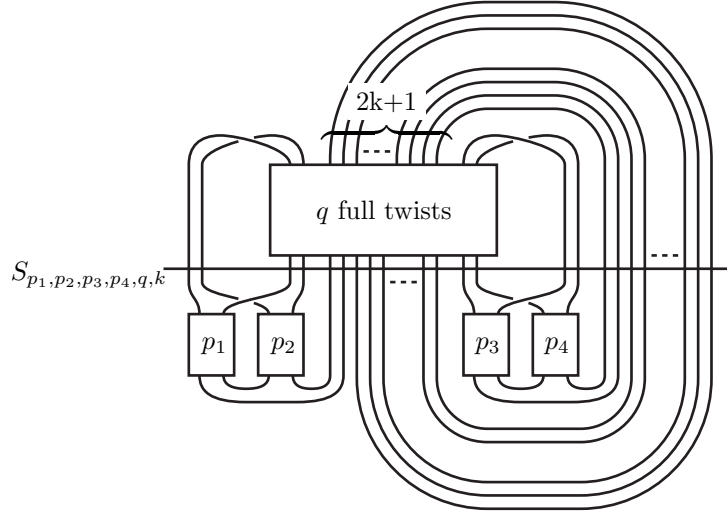

FIGURE 1. A knot $K_{p_1, p_2, p_3, p_4, q, k}$ and a sphere $S_{p_1, p_2, p_3, p_4, q, k}$. The box labelled “ p_i ” represents the p_i left-handed half-twists. See also the top of Figure 6 for the case where $p_1 = p_2 = p_3 = p_4 = 2$, $q = 0$ and $k = 4$.

It remains an open problem whether there exists a knot that has a 3-bridge or 4-bridge sphere and destabilized bridge spheres of arbitrarily high bridge number. We remark that such a knot cannot have a 2-bridge sphere, by the fact that only rational knots may admit 2-bridge spheres, and the results about rational knots mentioned above. As an answer for a subordinate problem, we give the following theorem.

Theorem 2. Let K_n , S_n^\perp and S_n be the knot and the two spheres, respectively, shown in Figure 2, for an integer n with $n \geq 4$. Then, S_n^\perp is a destabilized 3-bridge sphere of K_n , and S_n is a destabilized n -bridge sphere of K_n .

For the proof of the assertion that S_n is destabilized, we show the strong irreducibility of it.

This work is motivated by Casson–Gordon’s work for Heegaard surfaces of 3-manifolds. They gave an infinite family of 3-manifolds, each of which has destabilized Heegaard surfaces of arbitrarily high genus, and we use their result for the proof of Theorem 1 (see Section 3). Also, they introduced a criterion for recognizing destabilized Heegaard surfaces and used it for their proof, and similarly we introduce a criterion for recognizing destabilized bridge spheres (see Section 4) and use it for our proof of Theorem 2 (see Section 5).

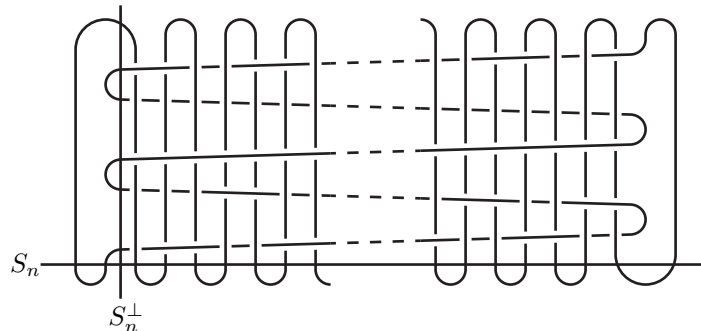

in the case where n is even

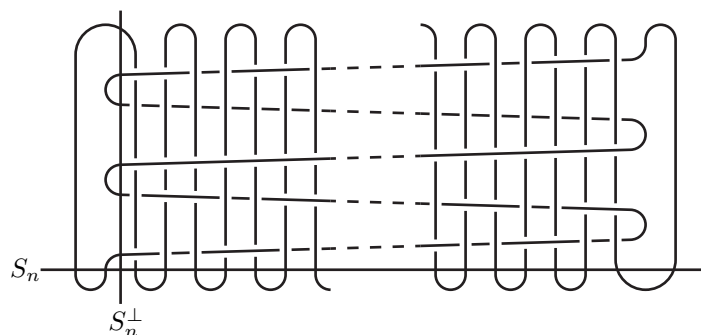

in the case where n is odd

FIGURE 2. A knot K_n and spheres S_n^\perp and S_n . The knot K_n intersects S_n in $2n$ points. The second top weft runs under the warps, and the third weft runs over the warps. Each of the other wefts threads across the warps by repeating “over, over, under, under” with the exception in the leftmost and rightmost parts.

2. HEEGAARD SURFACES AND BRIDGE SPHERES

In this section, we briefly review standard definitions and facts concerning Heegaard surfaces of 3-manifolds and bridge spheres of links.

2.1. Heegaard surfaces. A *handlebody* is a 3-manifold H homeomorphic to a closed regular neighborhood of a connected finite graph embedded in \mathbb{R}^3 . An *essential disk* of H is a properly embedded disk D in H such that ∂D does not bound a disk in the surface ∂H .

A *Heegaard surface* of a closed orientable 3-manifold M is a closed surface $\Sigma \subset M$ which decomposes M into two handlebodies. That is to say, there are two handlebodies $H^+, H^- \subset M$ such that $H^+ \cup H^- = M$ and $H^+ \cap H^- = \partial H^+ = \partial H^- = \Sigma$. Two Heegaard surfaces Σ_1, Σ_2 of M are said to be *isotopic* if there is an ambient isotopy $\{F_t : M \rightarrow M\}_{t \in [0,1]}$ such that $F_0 = id_M$ and $F_1(\Sigma_1) = \Sigma_2$.

The notion of stabilization for Heegaard surfaces is defined as follows. Let M, Σ, H^+, H^- be as above. Let γ be a properly embedded arc in H^+ parallel to Σ , and $N(\gamma)$ be a closed regular neighborhood of γ . Let \tilde{H}^- denote the union $H^- \cup N(\gamma)$, \tilde{H}^+ denote the closure of $H^+ \setminus N(\gamma)$, and $\tilde{\Sigma}$ denote their common boundary (see Figure 3). Then, both \tilde{H}^+, \tilde{H}^- are handlebodies and so $\tilde{\Sigma}$ is a Heegaard surface of

M . We say that $\tilde{\Sigma}$ is obtained from Σ by a *stabilization*. Note that the genus of $\tilde{\Sigma}$ is greater than that of Σ by one, and that the isotopy class of $\tilde{\Sigma}$ depends only on the isotopy class of Σ .

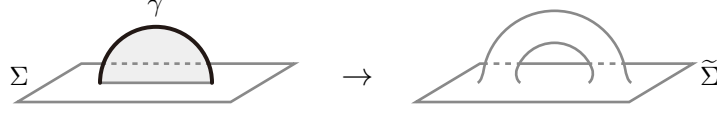

FIGURE 3. A stabilization for a Heegaard surface.

A Heegaard surface is said to be *destabilized* if it cannot be obtained from another Heegaard surface by a stabilization.

A Heegaard surface is said to be *strongly irreducible* if any essential disk of one of the handlebodies and any essential disk of the other have non-empty intersection. It is known that a strongly irreducible Heegaard surface is destabilized, with the exception of Heegaard surfaces of genus 1 of S^3 .

2.2. Bridge spheres. An n -string trivial tangle is the pair (B, τ) of a 3-ball B and a collection τ of pairwise disjoint properly embedded arcs $\tau_1, \tau_2, \dots, \tau_n$ in B simultaneously parallel to ∂B . There are pairwise disjoint disks E_1, E_2, \dots, E_n in B such that E_i is cobounded by τ_i and an arc in ∂B for each $i \in \{1, 2, \dots, n\}$. We call $\{E_1, E_2, \dots, E_n\}$ a *complete collection of bridge disks* of (B, τ) . An *essential disk* of (B, τ) is a properly embedded disk D in B such that $D \cap \tau = \emptyset$ and ∂D does not bound a disk in the $2n$ -punctured sphere $\partial B \setminus \tau$.

An n -bridge sphere of a link L in the 3-sphere S^3 is a 2-sphere $S \subset S^3$ which is transverse to L and decomposes (S^3, L) into two n -string trivial tangles. That is to say, the pairs $(B^+, \tau^+), (B^-, \tau^-)$ are n -string trivial tangles, where $B^+, B^- \subset S^3$ denote the 3-balls divided by S and $\tau^+ = L \cap B^+, \tau^- = L \cap B^-$. We call the number n the *bridge number* of the bridge sphere S . Two bridge spheres S_1, S_2 of L are said to be *isotopic* if there is an ambient isotopy $\{F_t : S^3 \rightarrow S^3\}_{t \in [0, 1]}$ such that $F_0 = id_{S^3}$, $F_1(S_1) = S_2$, and $F_t(S_1)$ is transverse to L for $t \in [0, 1]$.

The notion of stabilization for bridge spheres is defined as follows. Let $L, S, n, B^+, B^-, \tau^+, \tau^-$ be as above. Let α, β, γ be arcs in τ^+, S, B^+ , respectively, such that $\gamma \cap S$ consists of one endpoint of γ and $\gamma \cap \tau^+$ consists of the other endpoint, and $\alpha \cup \beta \cup \gamma$ is the boundary of a disk in B^+ whose interior is disjoint from τ^+ . Let $N(\gamma)$ be a closed regular neighborhood of γ . Let \tilde{B}^- denote the union $B^- \cup N(\gamma)$, \tilde{B}^+ denote the closure of $B^+ \setminus N(\gamma)$, and \tilde{S} denote their common boundary (see Figure 4). Let $\tilde{\tau}^+ = L \cap \tilde{B}^+$ and $\tilde{\tau}^- = L \cap \tilde{B}^-$. Then, both $(\tilde{B}^+, \tilde{\tau}^+), (\tilde{B}^-, \tilde{\tau}^-)$ are $(n+1)$ -string trivial tangles and so \tilde{S} is an $(n+1)$ -bridge sphere of L . We say that \tilde{S} is obtained from S by a *stabilization*. Note that the isotopy class of \tilde{S} depends only on the isotopy class of S if L is a knot.

A bridge sphere is said to be *destabilized* if it cannot be obtained from another bridge sphere by a stabilization.

A bridge sphere is said to be *strongly irreducible* if any essential disk of one of the trivial tangles and any essential disk of the other have non-empty intersection. It is

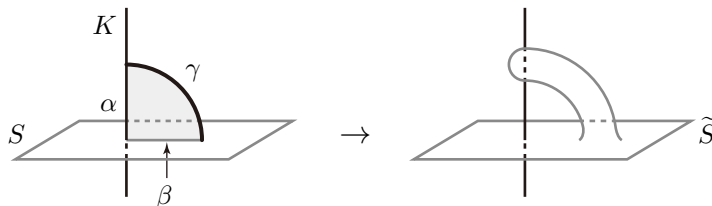

FIGURE 4. A stabilization for a bridge sphere.

known that a strongly irreducible bridge sphere is destabilized, with the exception of 2-bridge spheres of the trivial knot.

3. PROOF OF THEOREM 1

In this section, we give a proof of Theorem 1. To do this, we use the result of Casson–Gordon’s about Heegaard surfaces of 3-manifolds as mentioned in Section 1.

We use, for simplicity, the symbols $K_{q,k}$ and $S_{q,k}$ for the knot $K_{p_1,p_2,p_3,p_4,q,k}$ and the sphere $S_{p_1,p_2,p_3,p_4,q,k}$, respectively, shown in Figure 1. At this stage, we make no assumption on the integers p_1, p_2, p_3, p_4, q and the non-negative integer k .

First of all, it is easy to see that the sphere $S_{q,k}$ is a $(2k + 5)$ -bridge sphere of the knot $K_{q,k}$. Indeed, $K_{q,k}$ is in a $(2k + 5)$ -bridge position with respect to the height in Figure 1, and $S_{q,k}$ is a dividing sphere for $K_{q,k}$ (see [15] for the concept of bridge position).

The q full twists in the construction of $K_{q,k}$ can be regarded as a $(1/q)$ -surgery along a trivial knot O as in Figure 5. That is to say, $(S^3, K_{q,k})$ is obtained from $(S^3, K_{0,k})$ by drilling out a closed regular neighborhood V of O , and filling it back so that a meridian of V is identified with a $(1/q)$ -curve on ∂W , where W denotes the closure of $S^3 \setminus V$. We may suppose that O is contained in the sphere $S_{0,k}$, and that $\partial(S_{0,k} \cap V)$ is identified with $\partial(S_{0,k} \cap W)$ under the surgery. It follows that the images of $S_{0,k} \cap V$ and $S_{0,k} \cap W$ form the sphere $S_{q,k}$. Let $V_{q,k}$ and $W_{q,k}$ denote the images of V and W , respectively.

The knot type of $K_{q,k}$ does not depend on the number k , which can be seen as follows. Note that the link $K_{0,k} \cup O$ can be obtained from $K_{0,0} \cup O$ by rotating the ball B_2 illustrated in the top of Figure 6 about the axis O . This shows that the link type of $K_{0,k} \cup O$ does not depend on k . The link type and the integer q uniquely determine the knot type of the knot obtained from $K_{0,k}$ by the $(1/q)$ -surgery along O . The resultant knot therefore does not depend on k . This, together with the fact mentioned in the last paragraph, gives the desired result.

We deform the link $K_{0,k} \cup O$ together with the sphere $S_{0,k}$ by an ambient isotopy of S^3 as illustrated in Figure 6. In the first step, the two arcs a_1, a_2 of $K_{0,k} \setminus (B_1 \cup B_2)$ are pulled forward and backward, respectively, to coil around O . In the second step, the ball above $S_{0,k}$ is shrunk, and $K_{0,k}$ is moved to be suspended from one edge of O . In the third step, $K_{0,k}$ is straightened and $O \subset S_{0,k}$ is distorted for it. Abusing notation, we continue to denote the results of this deformation by $K_{0,k}, S_{0,k}, O, V, W$, and to denote the images under the $(1/q)$ -surgery by $K_{q,k}, S_{q,k}, V_{q,k}, W_{q,k}$.

From now on, we consider the 2-fold covering of S^3 branched along $K_{q,k}$, denoted by $\rho_{q,k} : M_{q,k} \rightarrow S^3$. Let $\Sigma_{q,k} = \rho_{q,k}^{-1}(S_{q,k})$, $\tilde{V}_{q,k} = \rho_{q,k}^{-1}(V_{q,k})$, $\tilde{W}_{q,k} = \rho_{q,k}^{-1}(W_{q,k})$.

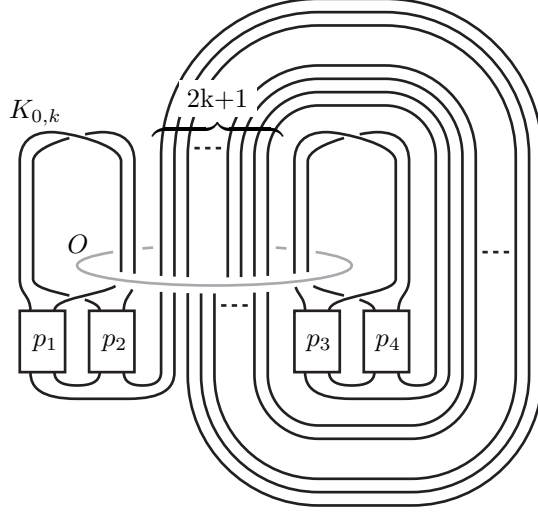

FIGURE 5. The knots $K_{0,k}$ and O . The sphere $S_{0,k}$ is represented as the horizontal plane containing O .

We can understand the covering $\rho_{0,k} : M_{0,k} \rightarrow S^3$ from the bottom of Figure 6. Specifically, we can see the following. The covering space $M_{0,k}$ is the 3-sphere, $\Sigma_{0,k}$ is a Heegaard surface of genus $2k+4$, and $\rho_{0,k}^{-1}(O)$ is a knot P contained in $\Sigma_{0,k}$ as illustrated in Figure 7. Note that P is the pretzel knot of type

$$(2p_1 + 1, \underbrace{1, 1, \dots, 1}_k, 2p_3 + 1, 2p_4 + 1, \underbrace{-1, -1, \dots, -1}_{k+1}, 2p_2 + 1).$$

The covering map $\rho_{0,k}$ is the quotient by the π -rotation of $M_{0,k}$ about the central horizontal axis. Note that $\tilde{V}_{0,k}$ is a closed regular neighborhood of P in $M_{0,k}$, and $\tilde{W}_{0,k}$ is the closure of $M_{0,k} \setminus \tilde{V}_{0,k}$.

We can regard $\rho_{2q',k} : \tilde{W}_{2q',k} \rightarrow W_{2q',k}$ as the same covering as $\rho_{0,k} : \tilde{W}_{0,k} \rightarrow W_{0,k}$ for each integer q' , as follows. Let $\varphi_{2q',k} : H_1(S^3 \setminus K_{2q',k}) \rightarrow \mathbb{Z}/2\mathbb{Z}$ denote the homomorphism associated with $\rho_{2q',k}$, and $e_{2q',k} : H_1(W_{2q',k} \setminus K_{2q',k}) \rightarrow H_1(S^3 \setminus K_{2q',k})$ denote the natural epimorphism. Since $W_{2q',k} \setminus K_{2q',k}$ coincides with $W_{0,k} \setminus K_{0,k}$, we may regard $e_{2q',k}$ as defined on $H_1(W_{0,k} \setminus K_{0,k})$. Note that $H_1(W_{0,k} \setminus K_{0,k})$ is generated by the elements coming from meridians of $K_{0,k}$ and O , denoted by m and μ , respectively. Let λ denote the element coming from a longitude of O . We have $(\varphi_{2q',k} \circ e_{2q',k})(\mu) = (\varphi_{2q',k} \circ e_{2q',k})(\mu) + 2(\varphi_{2q',k} \circ e_{2q',k})(q'\lambda) = (\varphi_{2q',k} \circ e_{2q',k})(\mu + 2q'\lambda) = 0$ since $e_{2q',k}(\mu + 2q'\lambda)$ comes from a meridian of $V_{2q',k}$. Also, we have $(\varphi_{2q',k} \circ e_{2q',k})(m) = 1$ since $e_{2q',k}(m)$ comes from a meridian of the branch set $K_{2q',k}$ of $\rho_{2q',k}$. Thus, we obtain $\varphi_{2q',k} \circ e_{2q',k} = \varphi_{0,k} \circ e_{0,k}$. This shows that the associated coverings $\rho_{2q',k} : \tilde{W}_{2q',k} \rightarrow W_{2q',k}$ and $\rho_{0,k} : \tilde{W}_{0,k} \rightarrow W_{0,k}$ coincide under a homeomorphism between $\tilde{W}_{2q',k}$ and $\tilde{W}_{0,k}$.

We can regard $\rho_{2q',k} : \tilde{V}_{2q',k} \rightarrow V_{2q',k}$ as the same covering as $\rho_{0,k} : \tilde{V}_{0,k} \rightarrow V_{0,k}$, as follows. Since $V_{2q',k}$ is disjoint from $K_{2q',k}$, the restriction $\rho_{2q',k} : \tilde{V}_{2q',k} \rightarrow V_{2q',k}$ is an unbranched 2-fold covering of the solid torus $V_{2q',k}$. There are two possibilities

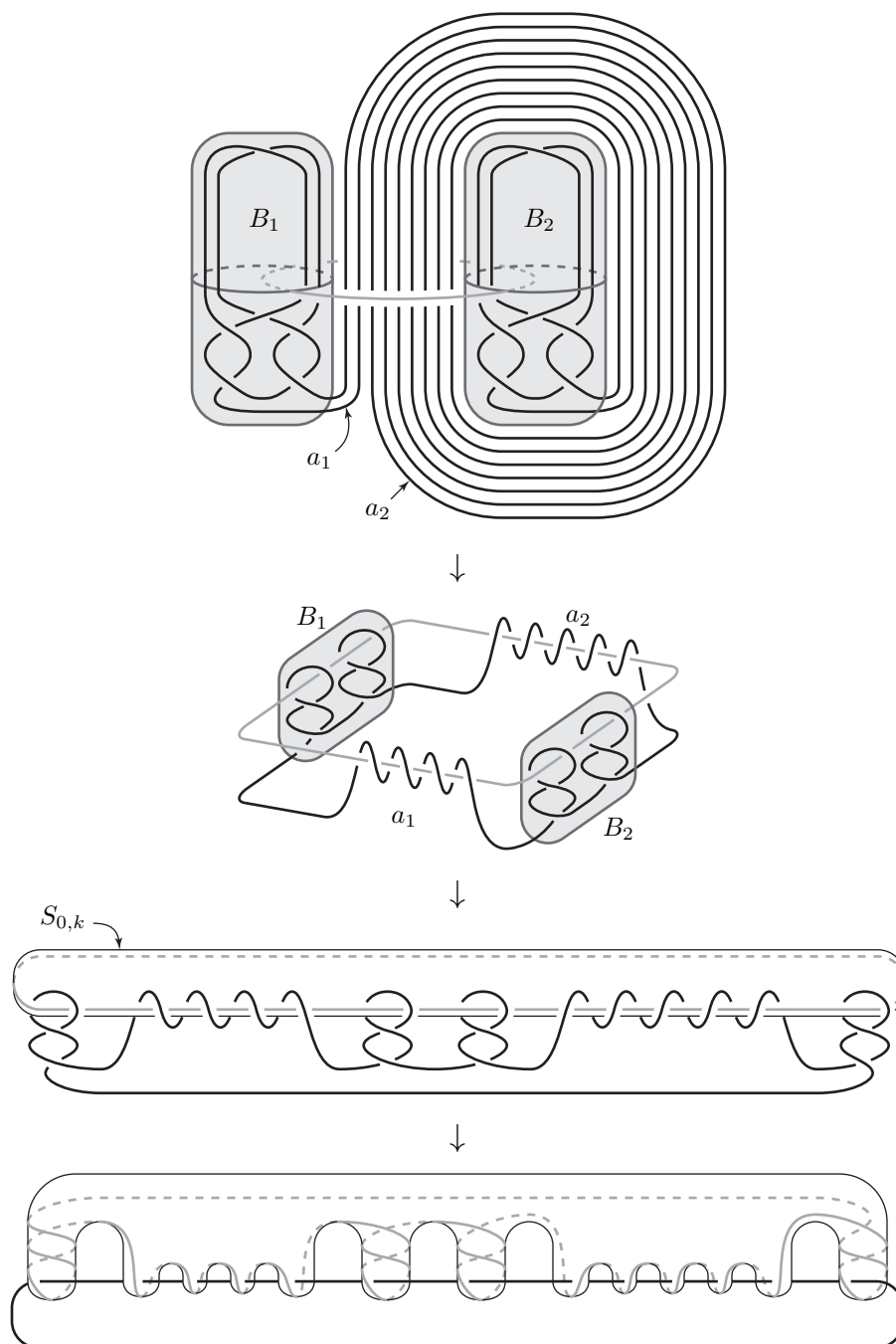

FIGURE 6. Deformation of the link $K_{0,k} \cup O$ and the sphere $S_{0,k}$, in the case where $p_1 = p_2 = p_3 = p_4 = 2$ and $k = 4$. In the top two pictures, $S_{0,k}$ is represented as the horizontal plane containing O .

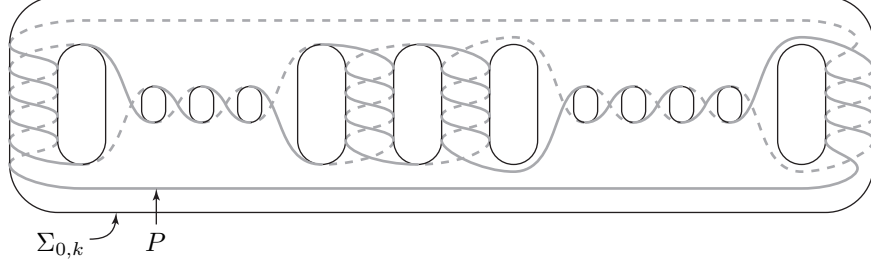

FIGURE 7. The Heegaard surface $\Sigma_{0,k}$ and the pretzel knot P , in the case where $p_1 = p_2 = p_3 = p_4 = 2$ and $k = 4$.

in one of which $\tilde{V}_{2q',k}$ is a solid torus, and in the other of which $\tilde{V}_{2q',k}$ is the union of two solid tori. Note that $\partial\tilde{W}_{2q',k}$ is a single torus as well as $\partial\tilde{W}_{0,k}$ by the above results. Since $\partial\tilde{V}_{2q',k}$ is identified with the single torus, $\tilde{V}_{2q',k}$ is a single solid torus as well as $\tilde{V}_{0,k}$.

The total covering space $M_{2q',k}$ is obtained by gluing $\tilde{W}_{2q',k}$ and $\tilde{V}_{2q',k}$ appropriately. Recall that a meridian of $V_{2q',k}$ is identified with a $(1/2q')$ -curve on $\partial W_{2q',k}$, and $\partial(S_{2q',k} \cap V_{2q',k})$ is identified with $\partial(S_{2q',k} \cap W_{2q',k})$. Note that the meridian of $V_{2q',k}$ lifts to a pair of meridians of $\tilde{V}_{2q',k}$. One can see that a $(1/2q')$ -curve on $\partial W_{0,k}$ lifts to a pair of $(1/q')$ -curves on $\partial\tilde{W}_{0,k}$, and it follows that the $(1/2q')$ -curve on $\partial W_{2q',k}$ lifts to a pair of $(1/q')$ -curves on $\partial\tilde{W}_{2q',k}$. These facts show that a meridian of $\tilde{V}_{2q',k}$ is identified with a $(1/q')$ -curve on $\partial\tilde{W}_{2q',k}$, and $\partial(\Sigma_{2q',k} \cap \tilde{V}_{2q',k})$ is identified with $\partial(\Sigma_{2q',k} \cap \tilde{W}_{2q',k})$.

By the above, the covering space $M_{2q',k}$ and the lift $\Sigma_{2q',k}$ of $S_{2q',k}$ turn out to be the 3-manifold and the Heegaard surface constructed by Casson–Gordon. That is to say, $M_{2q',k}$ is obtained from the 3-sphere $M_{0,k}$ by a $(1/q')$ -surgery along the pretzel knot P , and $\Sigma_{2q',k}$ is the image of the Heegaard surface $\Sigma_{0,k}$. Casson–Gordon showed that if $|2p_i + 1| \geq 5$ for each $i \in \{1, 2, 3, 4\}$ and $|q'| \geq 6$, then the Heegaard surface $\Sigma_{2q',k}$ is strongly irreducible. Though their original proof has been unpublished, one can verify this fact by [8, Theorem A] and the incompressibility of $\Sigma_{0,k} \setminus P$ shown in [14].

The strong irreducibility of $\Sigma_{q,k}$ guarantees the strong irreducibility of $S_{q,k}$, which can be seen as follows. Assume that $S_{q,k}$ is not strongly irreducible. There exist disjoint essential disks D^+, D^- of the trivial tangles divided by $S_{q,k}$. A component of $\rho_{q,k}^{-1}(D^+)$ and a component of $\rho_{q,k}^{-1}(D^-)$ are disjoint essential disks of the handlebodies divided by $\Sigma_{q,k}$. This contradicts the strong irreducibility of $\Sigma_{q,k}$.

Thus, we conclude that if $|2p_i + 1| \geq 5$ for each $i \in \{1, 2, 3, 4\}$ and q is an even number with $|q| \geq 12$, then the bridge sphere $S_{q,k}$ is strongly irreducible, and hence destabilized, for $k \geq 0$. This completes the proof of Theorem 1.

We remark that $\{K_{2q',k}\}_{q' \in \mathbb{Z}}$ contains infinitely many equivalence classes of knots, which can be seen as follows. By [18], the knot P is hyperbolic and the manifold $M_{2q',k}$ is hyperbolic if $|2p_i + 1| \geq 2$ for each $i \in \{1, 2, 3, 4\}$ and $q' \neq 0$. By [9], the set $\{\text{the length of the shortest geodesic in } M_{2q',k}\}_{q' \in \mathbb{Z}}$ is an infinite set.

We remark that another proof of Theorem 1 by constructing our bridge spheres from Casson–Gordon’s Heegaard surfaces is no easier than the above proof. It is

well known that one can construct a bridge sphere of a link from a Heegaard surface of a 3-manifold if the manifold admits an involution whose restriction to each of the handlebodies is hyperelliptic. It is true that the π -rotation of $W_{2q',k} = W_{0,k} \subset M_{0,k}$ about the central horizontal axis in Figure 7 extends to an involution of $M_{2q',k}$. It is also true, but cannot be proved easily that the restriction of the involution to each of the handlebodies divided by $\Sigma_{2q',k}$ is hyperelliptic.

4. BRIDGE DIAGRAMS AND 2-CONNECTED CONDITION

In this section, we define the notions of bridge diagram and 2-connected condition, and prove the following theorem.

Theorem 3. *An n -bridge sphere S with $n \geq 3$ of a link is strongly irreducible if there exist a bridge diagram (σ^+, σ^-) of the bridge sphere S and a loop l on S such that the pair $((\sigma^+, \sigma^-), l)$ satisfies the 2-connected condition.*

This is a refinement of previous work by the fourth author [17]. We mention that Kwon [6] recently gave another criterion for recognizing strongly irreducible bridge spheres.

We use the following notation. Let S be an n -bridge sphere with $n \geq 3$ of a link L in S^3 . Let $B^+, B^- \subset S^3$ denote the 3-balls divided by S , and let $\tau^+ = L \cap B^+$, $\tau^- = L \cap B^-$. For each $\varepsilon \in \{+, -\}$, let $\{E_1^\varepsilon, E_2^\varepsilon, \dots, E_n^\varepsilon\}$ be a complete collection of bridge disks of $(B^\varepsilon, \tau^\varepsilon)$, and let $\tau_i^\varepsilon = E_i^\varepsilon \cap L$, $\sigma_i^\varepsilon = E_i^\varepsilon \cap S$, and $\sigma^\varepsilon = \sigma_1^\varepsilon \cup \sigma_2^\varepsilon \cup \dots \cup \sigma_n^\varepsilon$.

A *bridge diagram* of the bridge sphere S is the diagram composed of the arcs of σ^+ and σ^- on S , and is denoted by (σ^+, σ^-) . One can think of it as a link diagram of L obtained by projecting $\tau_1^\varepsilon, \tau_2^\varepsilon, \dots, \tau_n^\varepsilon$ into S disjointly for each $\varepsilon \in \{+, -\}$.

Let l be a simple loop on S containing σ^- such that the arcs $\sigma_1^-, \sigma_2^-, \dots, \sigma_n^-$ are located in l in this order. We may suppose that σ^+ intersects l transversely and $|\sigma^+ \cap l|$ is minimal by deforming $E_1^+, E_2^+, \dots, E_n^+$ by an ambient isotopy of B^+ rel $L \cap B^+$.

We define a graph $\mathcal{G}_{i,j,\varepsilon}$ for distinct $i, j \in \{1, 2, \dots, n\}$ and $\varepsilon \in \{+, -\}$ as follows. Let $S_+, S_- \subset S$ denote the hemispheres divided by l , and δ_i denote the component of $l \setminus \sigma^-$ between σ_i^- and σ_{i+1}^- for each $i \in \{1, 2, \dots, n\}$, where the index $i+1$ is considered modulo n . Let $\mathcal{A}_{i,j,\varepsilon}$ be the collection of components of $\sigma^+ \cap S_\varepsilon$ separating δ_i from δ_j in S_ε for distinct $i, j \in \{1, 2, \dots, n\}$ and $\varepsilon \in \{+, -\}$. Note that $\mathcal{A}_{i,j,\varepsilon}$ consists of parallel arcs in S_ε . Let $\mathcal{G}_{i,j,\varepsilon}$ be the graph such that the vertex set is $\{1, 2, \dots, n\}$, and distinct vertices v, w span an edge if $\mathcal{A}_{i,j,\varepsilon}$ has a subarc of σ_v^+ and a subarc of σ_w^+ that are adjacent in S_ε . By ‘‘adjacent’’, we mean that the subarcs of σ_v^+ and σ_w^+ are contained in the closure of one component of $S_\varepsilon \setminus \sigma^+$.

We say that the pair $((\sigma^+, \sigma^-), l)$ satisfies the *2-connected condition* if the graph $\mathcal{G}_{i,j,\varepsilon}$ is 2-connected for every combination of distinct $i, j \in \{1, 2, \dots, n\}$ and $\varepsilon \in \{+, -\}$. Here, a graph is said to be 2-connected if it is connected even after deleting any vertex.

For example, we examine the bridge diagram (σ^+, σ^-) of a 4-bridge sphere of a knot as in the top of Figure 8. We choose l, S_+, S_- as in the figure. The middle of the figure shows the arcs of $\mathcal{A}_{1,2,+}$, and the bottom shows the graph $\mathcal{G}_{1,2,+}$. Clearly, $\mathcal{G}_{1,2,+}$ is 2-connected. One can check that $\mathcal{G}_{2,3,+}$ is, however, not 2-connected, and so the pair $((\sigma^+, \sigma^-), l)$ does not satisfy the 2-connected condition. See Section 5 for examples satisfying the 2-connected condition.

In the rest of this section, we give a proof of Theorem 3.

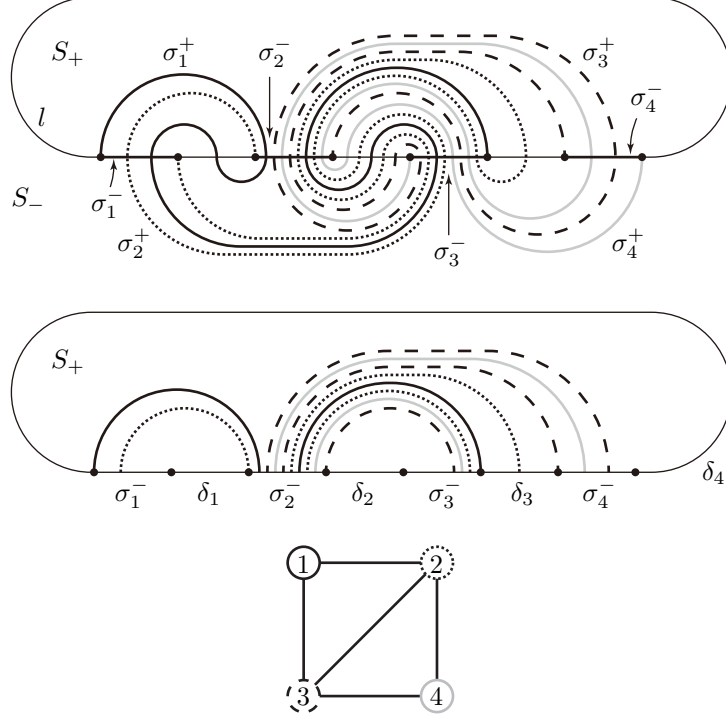
 FIGURE 8. A bridge diagram, the arcs of $\mathcal{A}_{1,2,+}$ and the graph $\mathcal{G}_{1,2,+}$.

By way of contradiction, we assume that an n -bridge sphere S is not strongly irreducible and the pair $((\sigma^+, \sigma^-), l)$ satisfies the 2-connected condition with the above notation.

There exist disjoint essential disks D^+ , D^- of the tangles (B^+, τ^+) , (B^-, τ^-) , respectively, since S is not strongly irreducible. By [17, Lemma 3], we may simultaneously suppose that

$$|\partial D^+ \cap \sigma^+| = \min \left\{ |\partial \tilde{D}^+ \cap \sigma^+| \mid \tilde{D}^+ \text{ is isotopic to } D^+ \text{ in } B^+ \text{ rel } L \cap B^+ \right\},$$

$$|\partial D^- \cap l| = \min \left\{ |\partial \tilde{D}^- \cap l| \mid \tilde{D}^- \text{ is isotopic to } D^- \text{ in } B^- \text{ rel } L \cap B^- \right\}.$$

We consider another graph $\mathcal{G}(D^-)$ defined as follows. The vertex set of $\mathcal{G}(D^-)$ is $\{1, 2, \dots, n\}$. Distinct vertices v, w of $\mathcal{G}(D^-)$ span an edge if ∂D^- contains a subarc connecting σ_v^+ and σ_w^+ directly. By “directly”, we mean that the interior of the subarc is disjoint from σ^+ .

On the one hand, we show that the graph $\mathcal{G}(D^-)$ is 2-connected as follows. By [17, Lemma 1], there exist distinct $i, j \in \{1, 2, \dots, n\}$ and $\varepsilon \in \{+, -\}$ such that ∂D^- contains a subarc connecting δ_i and δ_j in S_ε . Note that the subarc of ∂D^- intersects all the arcs of $\mathcal{A}_{i,j,\varepsilon}$. In particular, if two arcs of $\mathcal{A}_{i,j,\varepsilon}$ are adjacent in S_ε , then ∂D^- contains a subarc connecting them directly. This shows that $\mathcal{G}_{i,j,\varepsilon}$ is a subgraph of $\mathcal{G}(D^-)$. Recall that $\mathcal{G}_{i,j,\varepsilon}$ and $\mathcal{G}(D^-)$ have the same vertex set $\{1, 2, \dots, n\}$. The graph $\mathcal{G}(D^-)$ therefore inherits the 2-connectedness from $\mathcal{G}_{i,j,\varepsilon}$.

On the other hand, we show that the graph $\mathcal{G}(D^-)$ is not 2-connected as follows. After an isotopy of $\text{int}D^+$ if necessary, we may suppose that D^+ intersects $E_1^+ \cup E_2^+ \cup \dots \cup E_n^+$ transversely and $D^+ \cap (E_1^+ \cup E_2^+ \cup \dots \cup E_n^+)$ has no loop component. First, consider the case where $D^+ \cap (E_1^+ \cup E_2^+ \cup \dots \cup E_n^+)$ is empty. Note that each of $E_1^+, E_2^+, \dots, E_n^+$ is contained in one of the two components of $B^+ \setminus D^+$. This gives a decomposition of $\{1, 2, \dots, n\}$ into two subsets V and W . Since D^+ is an essential disk of (B^+, τ^+) , both V and W are not empty. By the disjointness of D^+ and D^- , for any $v \in V$ and $w \in W$, the curve ∂D^- cannot connect σ_v^+ and σ_w^+ . This implies that the graph $\mathcal{G}(D^-)$ is not connected, and hence not 2-connected. Secondly, consider the case where $D^+ \cap (E_1^+ \cup E_2^+ \cup \dots \cup E_n^+)$ is not empty. Note that it consists of properly embedded arcs in D^+ . Let D_0^+ be an outermost subdisk of D^+ cut off by an arc of $D^+ \cap (E_1^+ \cup E_2^+ \cup \dots \cup E_n^+)$, which is an arc of $D^+ \cap E_u^+$ for some $u \in \{1, 2, \dots, n\}$. Note that each of $E_1^+, \dots, E_{u-1}^+, E_{u+1}^+, \dots, E_n^+$ is contained in one of the two components of $B^+ \setminus (D_0^+ \cup E_u^+)$. This gives a decomposition of $\{1, \dots, u-1, u+1, \dots, n\}$ into two subsets V and W . Since $n \geq 3$ and $|\partial D^+ \cap \sigma^+|$ is minimal, both V and W are not empty. By the disjointness of D^+ and D^- , for any $v \in V$ and $w \in W$, any subarc of ∂D^- cannot connect σ_v^+ and σ_w^+ directly. This implies that the graph $\mathcal{G}(D^-)$ is not connected after deleting the vertex u , and hence $\mathcal{G}(D^-)$ is not 2-connected.

Thus, we have a contradiction to the 2-connectedness of the graph $\mathcal{G}(D^-)$. This completes the proof of Theorem 3.

5. PROOF OF THEOREM 2

In this section, we give a proof of Theorem 2. To do this, we use the method introduced in Section 4. This is a sequel of previous work by the third and fourth authors [13].

First of all, it is easy to see that the spheres S_n and S_n^\perp shown in Figure 2 are an n -bridge sphere and a 3-bridge sphere, respectively, of the knot K_n . Indeed, the figure shows a $2n$ -plat presentation of K_n , and shows a 6-plat presentation of K_n after the $(\pi/2)$ -rotation and a slight deformation (see [1] for the concept of plat presentation).

We regard the knot K_n as lying in the product space $S_n \times [-1, 6]$ as in Figure 9. The sphere S_n is regarded as the section $S_n \times \{0\}$, and we let $S_n(s) = S_n \times \{s\}$ for each $s \in [0, 5]$. We suppose that K_n is contained in the vertical annulus A shown in the figure except for the gray arc. Let $l(s) = A \cap S_n(s)$ for each $s \in [0, 5]$ and let $l = l(0)$.

We choose complete collections of bridge disks of the trivial tangles divided by S_n as follows. Let $\bar{E}_1^+, \bar{E}_2^+, \dots, \bar{E}_n^+$ and $E_1^-, E_2^-, \dots, E_n^-$ be the disks in the vertical annulus A as in Figure 9. Note that $\{E_1^-, E_2^-, \dots, E_n^-\}$ is a complete collection of bridge disks of the trivial tangle below S_n . Let $\sigma_i^- = E_i^- \cap S_n$ for each $i \in \{1, 2, \dots, n\}$ and $\sigma^- = \sigma_1^- \cup \sigma_2^- \cup \dots \cup \sigma_n^-$. There exists a homeomorphism $\Phi : S_n \times [0, 5] \rightarrow S_n \times [0, 5]$ such that $\Phi(S_n(s)) = S_n(s)$ for $s \in [0, 5]$, $\Phi|_{S_n(5)} = \text{id}_{S_n(5)}$ and $\Phi(K_n \cap (S_n \times [0, 5])) = (K_n \cap S_n(5)) \times [0, 5]$. Let $\sigma_i^+(s)$ denote the arc $\Phi^{-1}((\bar{E}_i^+ \cap S_n(5)) \times \{s\})$ for each $i \in \{1, 2, \dots, n\}$ and $s \in [0, 5]$, and let $\sigma^+(s) = \sigma_1^+(s) \cup \sigma_2^+(s) \cup \dots \cup \sigma_n^+(s)$. We may suppose that $\sigma^+(r)$ intersects $l(r)$ transversely and $|\sigma^+(r) \cap l(r)|$ is minimal for each $r \in \{0, 1, 2, 3, 4\}$ after a modification of Φ . Let E_i^+ denote the disk $\bar{E}_i^+ \cup \bigcup_{s \in [0, 5]} \sigma_i^+(s)$ for each $i \in \{1, 2, \dots, n\}$. Note

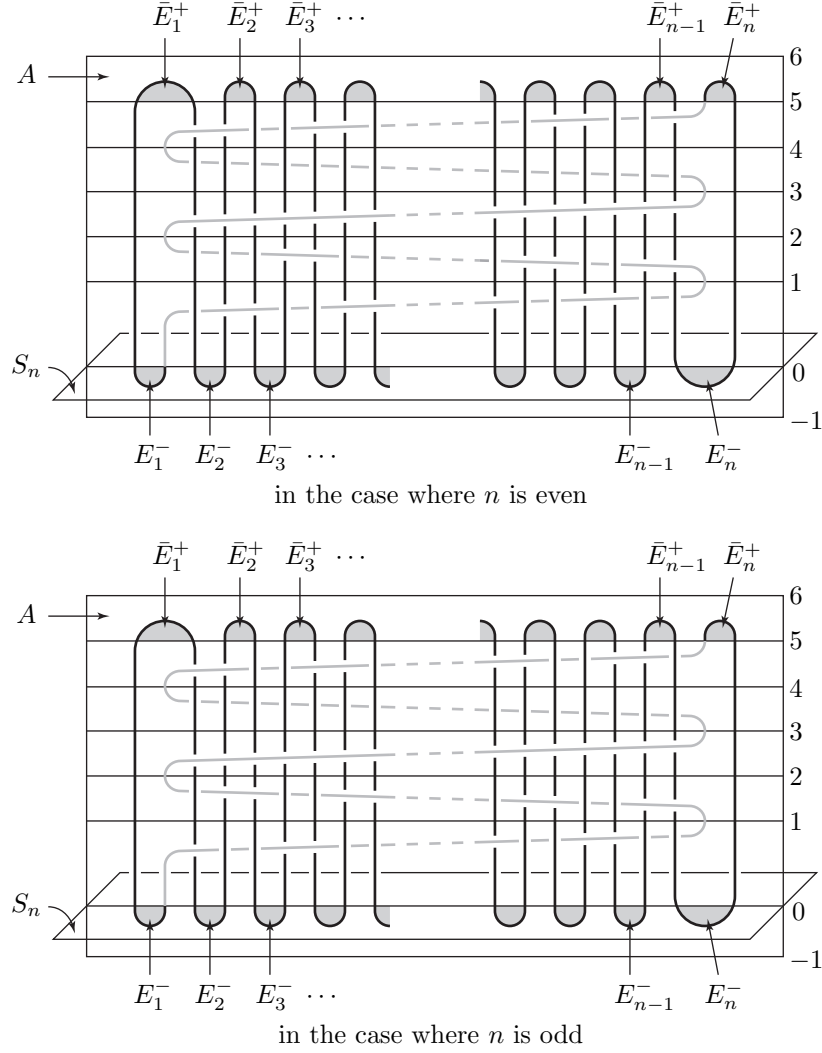

FIGURE 9. The knot K_n and a vertical annulus A in the product space $S_n \times [-1, 6]$, and disks $\bar{E}_1^+, \bar{E}_2^+, \dots, \bar{E}_n^+, E_1^-, E_2^-, \dots, E_n^-$.

that $\{E_1^+, E_2^+, \dots, E_n^+\}$ is a complete collection of bridge disks of the trivial tangle above S_n . Let $\sigma_i^+ = \sigma_i^+(0)$ for each $i \in \{1, 2, \dots, n\}$ and $\sigma^+ = \sigma^+(0)$. Note that $\sigma_i^+ = E_i^+ \cap S_n$.

To draw the bridge diagram (σ^+, σ^-) of S_n , we observe the deformation of the arcs of $\sigma^+(s)$ as s descends from 5 to 0. Note that $\sigma^+(5)$ is the collection of straight arcs in the sphere $S_n(5)$ as in Figure 10. As s descends from 5 to 4, the left endpoint of the rightmost arc $\sigma_n^+(s)$ moves as described by the gray arrow in the figure. This gives us $\sigma^+(4) \subset S_n(4)$ as in Figure 11. By similar observation, as s descends to 3 (respectively, to 2), we have $\sigma^+(3)$ (respectively, $\sigma^+(2)$) as in Figure 12 (respectively, Figure 13). Note that the region $R(2) \subset S_n(2)$ in Figure 13 contains $n + 1$ subarcs of $\sigma^+(2)$ as in Figure 14. We continue our observation as

s descends to 1 and to 0. Though we do not include the whole picture of $\sigma^+(1)$ (respectively, $\sigma^+(0)$), by paying particular attention to the deformation of $R(2)$, we can find a region $R(1) \subset S_n(1)$ (respectively, $R(0) \subset S_n(0)$) as in Figure 15 (respectively, Figure 16) which contains $n+1$ subarcs of $\sigma^+(1)$ (respectively, $\sigma^+(0)$) as in Figure 14.

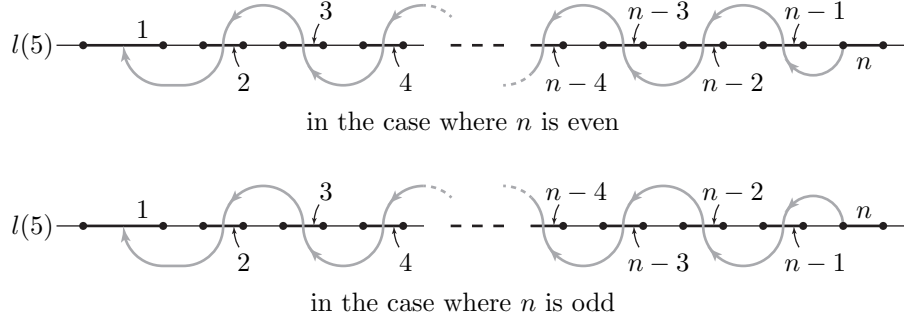

FIGURE 10. The arcs of $\sigma^+(5)$ in the sphere $S_n(5)$, where “ i ” stands for $\sigma_i^+(5)$ for each $i \in \{1, 2, \dots, n\}$.

We can see that the pair $((\sigma^+, \sigma^-), l)$ satisfies the 2-connected condition as follows. We choose S_+ (respectively, S_-) to be the hemisphere above (respectively, below) l in Figure 16, and let $\delta_1, \delta_2, \dots, \delta_n$ and $\mathcal{G}_{i,j,\varepsilon}$ be as in Section 4. We can see from Figure 16 that there exist components of $R(0) \cap S_+$ as in Figure 17. In particular, there exists at least one component of $R(0) \cap S_+$ separating δ_i from δ_j in S_+ for each pair of distinct $i, j \in \{1, 2, \dots, n\}$. Since $R(0)$ contains subarcs of $\sigma^+(0)$ as in Figure 14, the component of $R(0) \cap S_+$ contains a subarc of σ_v^+ and a subarc of σ_{v+1}^+ that are adjacent in S_+ for each $v \in \{1, 2, \dots, n\}$, where the index $v+1$ is considered modulo n . The graph $\mathcal{G}_{i,j,+}$ therefore has a cycle passing through the vertices $1, 2, \dots, n$ in this order, which implies that $\mathcal{G}_{i,j,+}$ is 2-connected. Similarly, one can also check that $\mathcal{G}_{i,j,-}$ is 2-connected for each pair of distinct $i, j \in \{1, 2, \dots, n\}$.

By Theorem 3, the n -bridge sphere S_n is strongly irreducible, and hence destabilized. It follows that the knot K_n is not a rational knot, since a rational knot cannot admit a destabilized n -bridge sphere by the results mentioned in Section 1. It follows that the 3-bridge sphere S_n^\perp is also destabilized, since only rational knots may admit a 2-bridge sphere. This completes the proof of Theorem 2.

REFERENCES

- [1] J. S. Birman, *Plat presentations for link groups*, Collection of articles dedicated to Wilhelm Magnus. *Comm. Pure Appl. Math.* **26** (1973), 673–678.
- [2] J. S. Birman, *On the stable equivalence of plat representations of knots and links*, *Canad. J. Math.* **28** (1976), no. 2, 264–290.
- [3] Y. Jang, *Classification of 3-bridge arborescent links*, *Hiroshima Math. J.* **41** (2011), no. 1, 89–136.
- [4] Y. Jang, *Classification of 3-bridge spheres of 3-bridge arborescent links*, *J. Math. Soc. Japan* **65** (2013), no. 1, 97–136.
- [5] J. Johnson and M. Tomova, *Flipping bridge surfaces and bounds on the stable bridge number*, *Algebr. Geom. Topol.* **11** (2011), no. 4, 1987–2005.
- [6] B. Kwon, *Rectangle condition on n -bridge presentation of knots*, arXiv:1404.7165.

- [7] J. M. Montesinos, *Minimal plat representations of prime knots and links are not unique*, *Canad. J. Math.* **28** (1976), no. 1, 161–167.
- [8] Y. Moriah and J. Schultens, *Irreducible Heegaard splittings of Seifert fibered spaces are either vertical or horizontal*, *Topology* **37** (1998), no. 5, 1089–1112.
- [9] W. D. Neumann and D. Zagier, *Volumes of hyperbolic three-manifolds*, *Topology* **24** (1985), no. 3, 307–332.
- [10] J.-P. Otal, *Présentations en ponts du nœud trivial*, *C. R. Acad. Sci. Paris Sér. I Math.* **294** (1982), no. 16, 553–556.
- [11] J.-P. Otal, *Presentations en ponts des nœuds rationnels*, *Low-dimensional topology* (Chelwood Gate, 1982), 143–160, *London Math. Soc. Lecture Note Ser.*, 95, Cambridge Univ. Press, Cambridge, 1985.
- [12] M. Ozawa, *Nonminimal bridge positions of torus knots are stabilized*, *Math. Proc. Cambridge Philos. Soc.* **151** (2011), 307–317.
- [13] M. Ozawa and K. Takao, *A locally minimal, but not globally minimal bridge position of a knot*, *Math. Proc. Cambridge Philos. Soc.* **155** (2013), no. 1, 181–190.
- [14] R. L. Paris, *Pretzel Knots*, Ph. D. Thesis, Princeton University, 1978.
- [15] M. Scharlemann, *Thin position in the theory of classical knots*, *Handbook of knot theory*, 429–459, Elsevier B. V., Amsterdam, 2005.
- [16] H. Schubert, *Knoten mit zwei Brücken*, *Math. Z.* **65** (1956), 133–170.
- [17] K. Takao, *Bridge decompositions with distances at least two*, *Hiroshima Math. J.* **42** (2012), no. 2, 161–168.
- [18] Y.-Q. Wu, *Dehn surgery on arborescent knots*, *J. Differential Geom.* **43** (1996), no. 1, 171–197.
- [19] A. Zupan, *Properties of knots preserved by cabling*, *Comm. Anal. Geom.* **19** (2011), no. 3, 541–562.

DEPARTMENT OF MATHEMATICS, NARA WOMEN'S UNIVERSITY, KITAUOYANISHI-MACHI, NARA 630-8506, JAPAN

E-mail address: yeonheejang@cc.nara-wu.ac.jp

DEPARTMENT OF MATHEMATICS, NARA WOMEN'S UNIVERSITY, KITAUOYANISHI-MACHI, NARA 630-8506, JAPAN

E-mail address: tsuyoshi@cc.nara-wu.ac.jp

DEPARTMENT OF NATURAL SCIENCES, FACULTY OF ARTS AND SCIENCES, KOMAZAWA UNIVERSITY, 1-23-1 KOMAZAWA, SETAGAYA-KU, TOKYO, 154-8525, JAPAN

E-mail address: w3c@komazawa-u.ac.jp

INSTITUTE OF MATHEMATICS FOR INDUSTRY, KYUSHU UNIVERSITY, 744 MOTOOKA, NISHI-KU, FUKUOKA 819-0395, JAPAN

E-mail address: takao@imi.kyushu-u.ac.jp

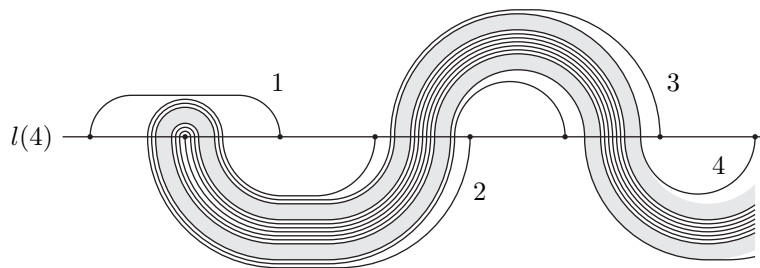

the leftmost part

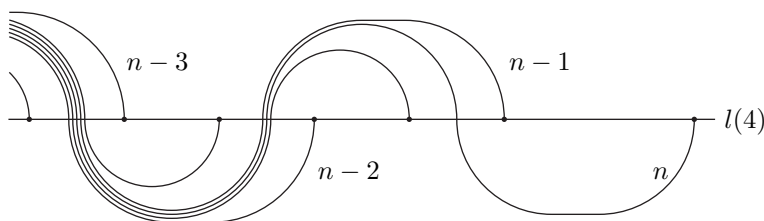

the rightmost part in the case where n is even

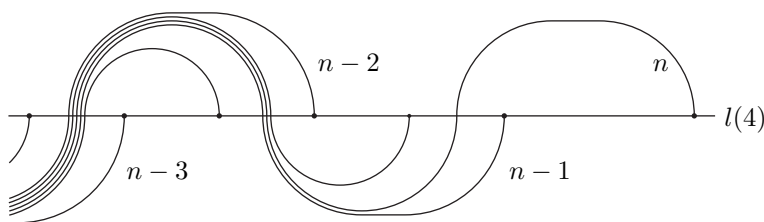

the rightmost part in the case where n is odd

FIGURE 11. The arcs of $\sigma^+(4)$ in the sphere $S_n(4)$. The gray band represents a bunch of parallel arcs.

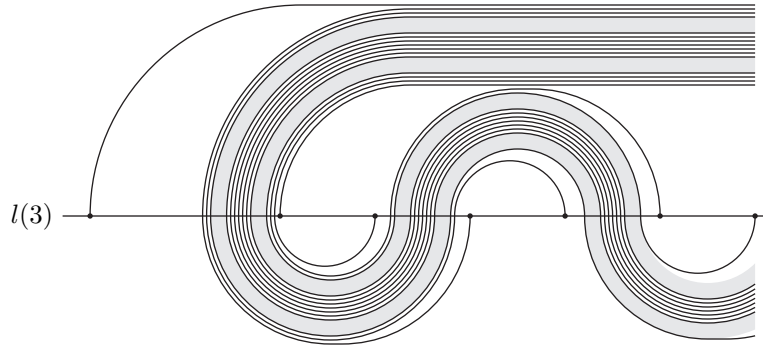

the leftmost part

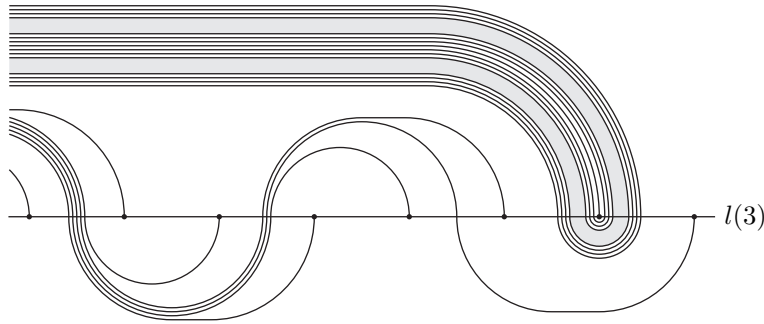

the rightmost part in the case where n is even

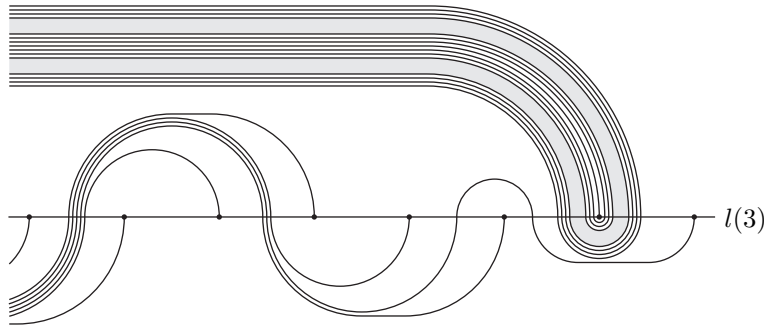

the rightmost part in the case where n is odd

FIGURE 12. The arcs of $\sigma^+(3)$ in the sphere $S_n(3)$.

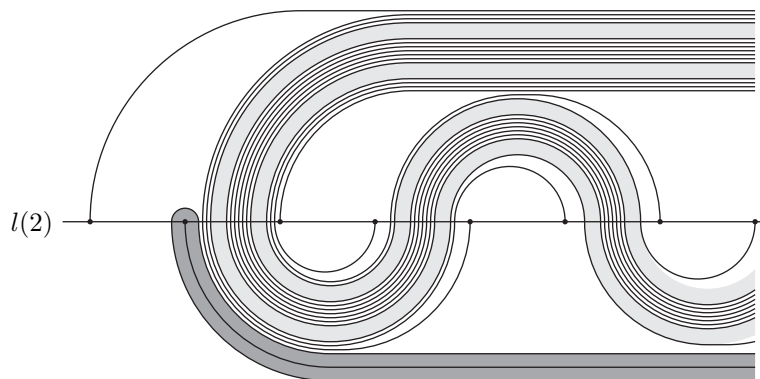

the leftmost part

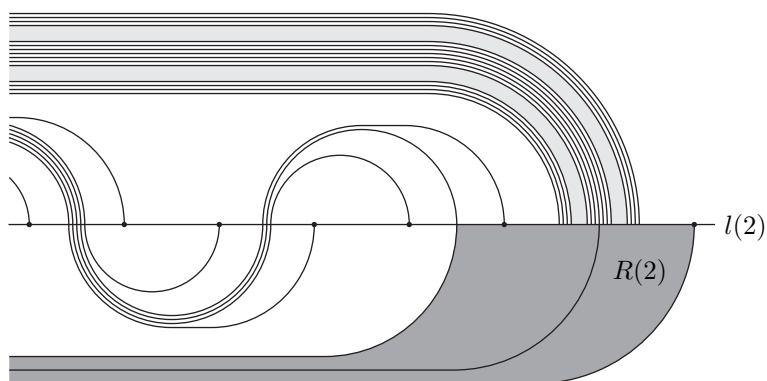

the rightmost part in the case where n is even

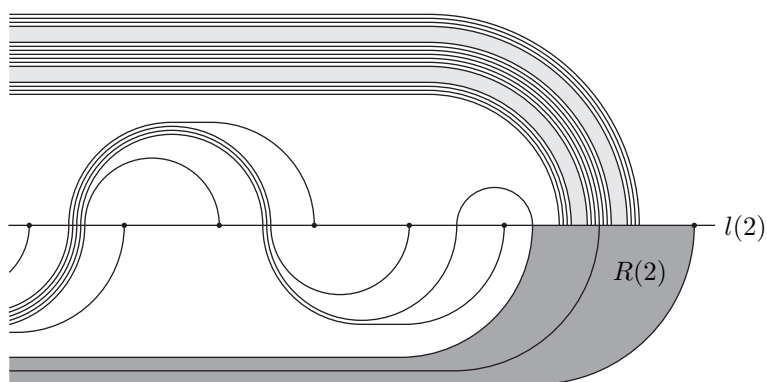

the rightmost part in the case where n is odd

FIGURE 13. The arcs of $\sigma^+(2)$ in the sphere $S_n(2)$. A region $R(2)$ is painted over with darker gray.

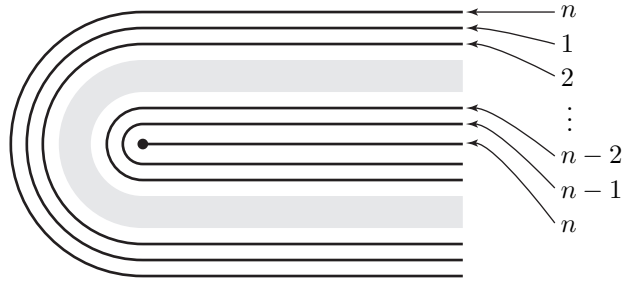
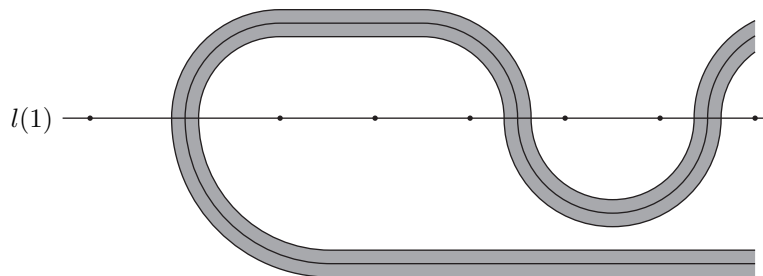
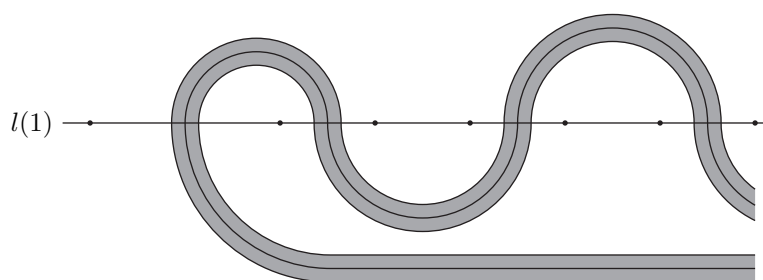

FIGURE 14. Subarcs of $\sigma^+(r)$ contained in the region $R(r)$ for each $r \in \{2, 1, 0\}$, where “ i ” stands for a subarc of $\sigma_i^+(r)$ for each $i \in \{1, 2, \dots, n\}$.



the leftmost part in the case where n is even



the leftmost part in the case where n is odd

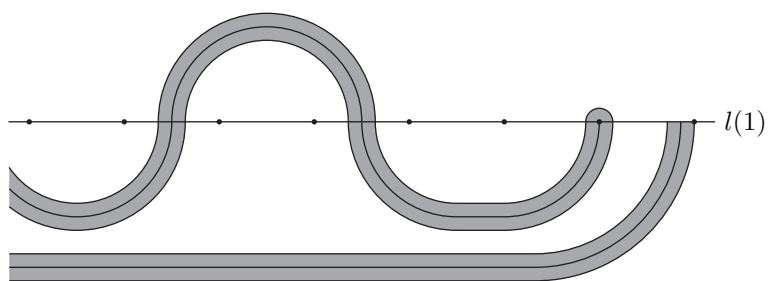

the rightmost part

FIGURE 15. The region $R(1)$ in the sphere $S_n(1)$.

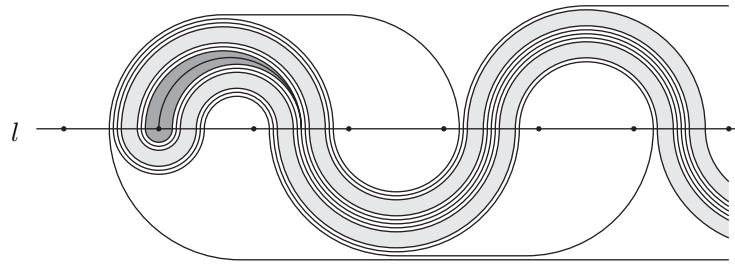

the leftmost part in the case where n is even

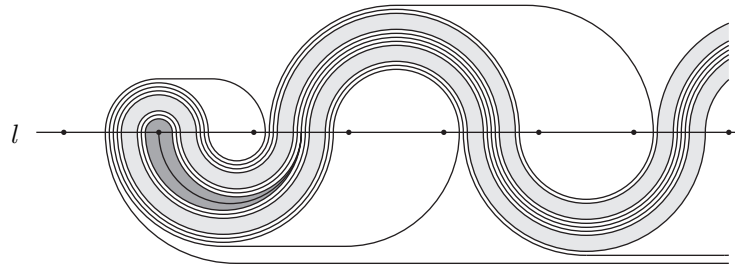

the leftmost part in the case where n is odd

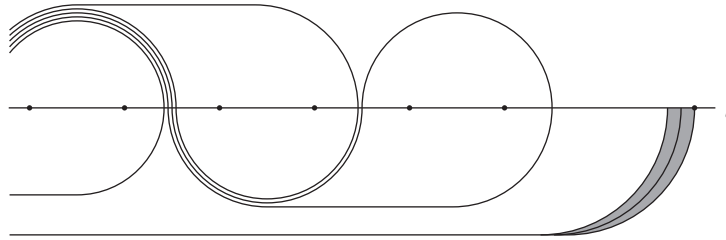

the rightmost part

FIGURE 16. The region $R(0)$ in the sphere S_n , whose long middle part looks like an arc.

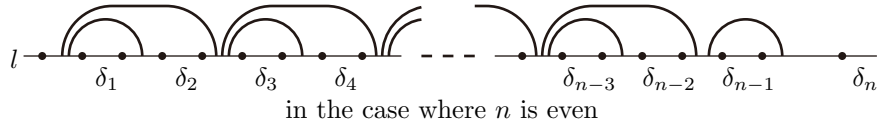

in the case where n is even

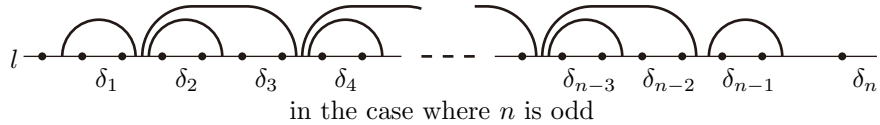

in the case where n is odd

FIGURE 17. Some components of $R(0) \cap S_+$.