

ON HOMOTOPY $K3$ SURFACES CONSTRUCTED BY TWO KNOTS AND THEIR APPLICATIONS

MASATSUNA TSUCHIYA

ABSTRACT. Let LHT be a left handed trefoil knot and K be any knot. We define $M_n(K)$ to be the homology 3-sphere which is represented by a simple link of LHT and $LHT\sharp K$ with framings 0 and n respectively. Starting with this link, we construct homotopy $K3$ and spin rational homology $K3$ surfaces containing $M_n(K)$. Then we apply the adjunction inequality to show that if $n > 2g_s^n(K) - 2$, $M_n(K)$ does not bound any smooth spin rational 4-ball, and that under the same assumption the negative n -twisted Whitehead double of $LHT\sharp K$ is not a slice knot, where $g_s^n(K)$ is the n -shake genus of K .

1. Introduction

Let K be a knot in S^3 . We define $X_n(K)$ to be the 4-dimensional handlebody which has a handle decomposition represented by Figure 1.1, and define $M_n(K)$ to be $\partial(X_n(K))$. The boundary $M_n(K)$ is a homology 3-sphere. Note that the right side knot of this link is the connected sum of a left handed trefoil knot LHT and K .



FIGURE 1.1. $X_n(K)$

Definition 1.1 (r -shake genus of K). Let $N_{K,r}$ be a 4-dimensional handlebody which is constructed by attaching a 2-handle to D^4 along a knot K with r -framing. We define the r -shake genus of K to be the minimal genus of smoothly embedded closed oriented surfaces in $N_{K,r}$ representing the generator of $H_2(N_{K,r})$. We denote the r -shake genus of K by $g_s^r(K)$.

Remark 1.2. Let $g_4(K)$ be the 4-ball genus of K . Then we have $g_s^r(K) \leq g_4(K)$, for any $r \in \mathbb{Z}$.

In this paper, we show the following

Theorem 1.3. *If $n > 2g_s^n(K) - 2$, $M_n(K)$ does not bound any smooth spin rational 4-ball.*

If K is an unknot, Theorem 1.3 is closely related to M. Tange's result (see Remark 1.7), who uses the Heegaard Floer homology $HF^+(M_n(U))$ and the correction term $d(M_n(U))$, while we apply the adjunction inequality.

2010 *Mathematics Subject Classification.* Primary 57R65; Secondary 57M25.

Corollary 1.4. *If $n > 2g_s^n(K) - 2$, the negative n -twisted Whitehead double of $LHT\sharp K$ is not a slice knot, where $LHT\sharp K$ is the connected sum of LHT and K .*

Remark 1.5. By Corollary 1.4, if $LHT\sharp K$ is a slice knot, $g_s^0(K)$ is not equal to 0.

If $\tau(K) = g_s^n(K)$, Corollary 1.4 is a special case of Hedden's result (see [6, Theorem 1.5]), where $\tau(K)$ is the τ -invariant of K .

We will prove Theorem 1.3 and Corollary 1.4 in Section 2.

Theorem 1.6. *Let (a_1, a_2, a_3, a_4) be any permutation of $(-1, -1, -2k-1, -2m-1)$, where m and k are integers and $k \geq 0$. Then the knot represented by Figure 1.2 is not a slice knot, where a_i is the number of full twists ($i = 1, 2, 3, 4$).*

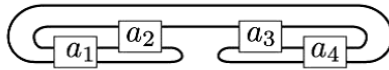

FIGURE 1.2.

We will prove Theorem 1.6 in Section 3.

Remark 1.7. Let U be an unknot. Y. Matsumoto asked in [7, Problem 4.28] whether $M_0(U)$ bounds a contractible 4-manifold or not. By Gordon's result [5], if n is odd, $M_n(U)$ does not bound any contractible 4-manifold (cf. [10, §3.1]). If n is equal to -6 , N. Maruyama [9] proved that $M_{-6}(U)$ bounds a contractible 4-manifold. If n is equal to 0, S. Akbulut [2] proved that $M_0(U)$ does not bound any contractible 4-manifold. If $n > -2$, M. Tange [12] proved that $M_n(U)$ does not bound any negative definite 4-manifold by computing the Heegaard Floer homology $HF^+(M_n(U))$ and the correction term $d(M_n(U))$.

Acknowledgements. The author would like to thank Tetsuya Abe, Mikio Furuta, Yukio Matsumoto, Nobuhiro Nakamura and Motoo Tange for their useful comments and encouragement.

2. Proof of Theorem 1.3

Notation.

- (1) We represent a knot K by Figure 2.1. If K is a right handed trefoil knot RHT , $X_n(RHT)$ is represented by Figure 2.2.



FIGURE 2.1. K



FIGURE 2.2. $X_n(RHT)$

(2) Let $D_-(K, n)$ (resp. $D_+(K, n)$) be the negative (resp. positive) n -twisted Whitehead double of K , and we represent $D_-(K, n)$ by Figure 2.3. For example, $D_-(LHT, -6)$ is represented by Figure 2.4. To simplify the diagram, we usually use Figure 2.5 instead of Figure 2.4.

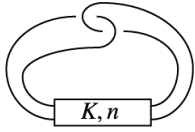

FIGURE 2.3. $D_-(K, n)$



FIGURE 2.4. $D_-(LHT, -6)$

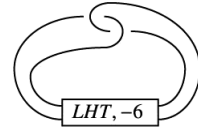

FIGURE 2.5. $D_-(LHT, -6)$

Let $V_n(K)$ be the 4-dimensional handlebody represented by Figure 2.7.

Proposition 2.1. *The 4-dimensional handlebodies $X_n(K)$ and $V_n(K)$ have the same boundary.*



FIGURE 2.6. $X_n(K)$

\cong

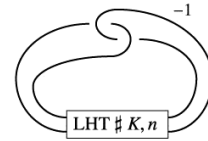

FIGURE 2.7. $V_n(K)$

Proof. We show Proposition 2.1 by the following handle calculus:



FIGURE 2.8. X_n

$\xrightarrow[\text{isotopy}]{\cong}$



FIGURE 2.9.

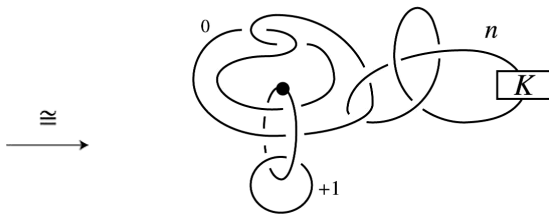

FIGURE 2.10.

$\xrightarrow[\text{isotopy}]{\cong}$

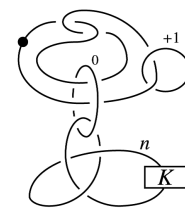

FIGURE 2.11.

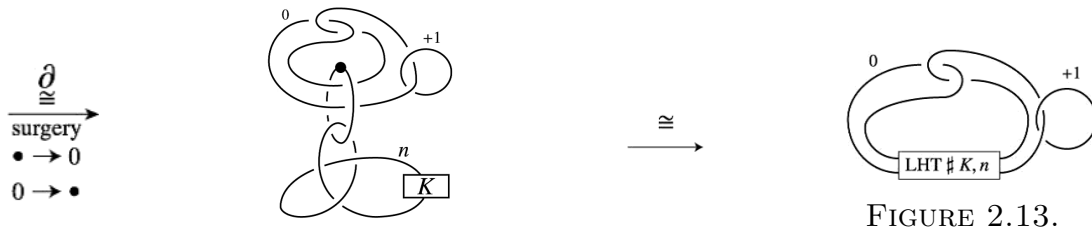

FIGURE 2.12.



FIGURE 2.14. $V_n(K)$

□

Remark 2.2. By Figure 2.7, we can compute the Casson invariant $\lambda(M_n(K))$ as follows (cf. [13, §2(vii)]):

$$\lambda(M_n(K)) = -n.$$

The Casson invariant, when reduced modulo 2, is the Rohlin invariant:

$$\lambda(M_n(K)) \equiv \mu(M_n(K)) \pmod{2}.$$

Therefore, if n is odd, $M_n(K)$ does not bound any smooth spin rational 4-ball.

Remark 2.3. If $D_-(LHT \# K, n)$ is a slice knot, we have a smooth S^2 with self intersection -1 in $V_n(K)$ representing the generator of $H_2(V_n(K))$. We can blow down this S^2 to get a smooth contractible 4-manifold $W_n(K)$. For example, Casson showed that $D_-(LHT, -6)$ is a slice knot. Therefore $V_{-6}(U)$ can be blown down to a contractible 4-manifold $W_{-6}(U)$ represented by Figure 2.16.

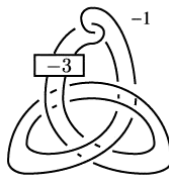

FIGURE 2.15. $V_{-6}(U)$

$\partial \cong$

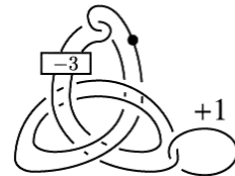

FIGURE 2.16. $W_{-6}(U)$

Let $Y_n(K)$ be the 4-dimensional handlebody represented by Figure 2.17 with intersection from $2E_8 \oplus 2\begin{pmatrix} 0 & 1 \\ 1 & 0 \end{pmatrix} \oplus \begin{pmatrix} 0 & 1 \\ 1 & n \end{pmatrix} \oplus 1$.

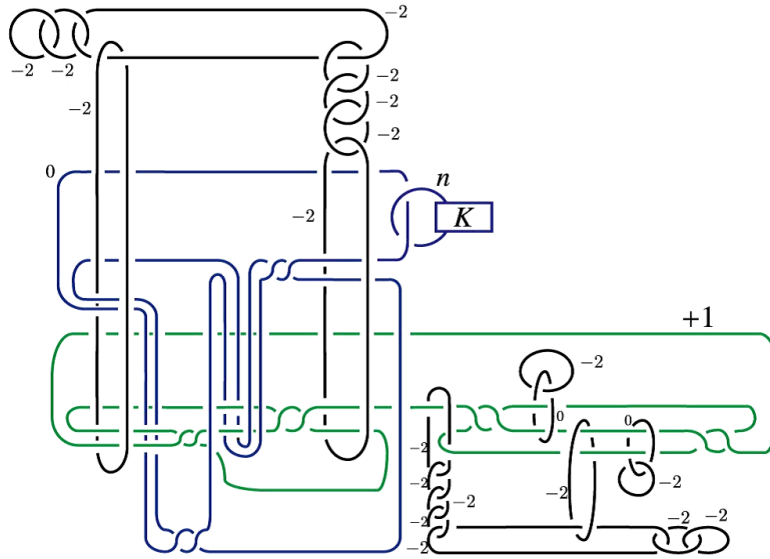

FIGURE 2.17. $Y_n(K)$

Because the $+1$ -framed knot in Figure 2.17 is a slice knot ($RHT \sharp LHT$), we can blow it down. Then we have a smooth simply connected 4-dimensional handlebody $Z_n(K)$ represented by Figure 2.18 with intersection form $2E_8 \oplus 2\begin{pmatrix} 0 & 1 \\ 1 & 0 \end{pmatrix} \oplus \begin{pmatrix} 0 & 1 \\ 1 & n \end{pmatrix}$. Note that $Y_n(K)$ and $Z_n(K)$ have the same boundary.

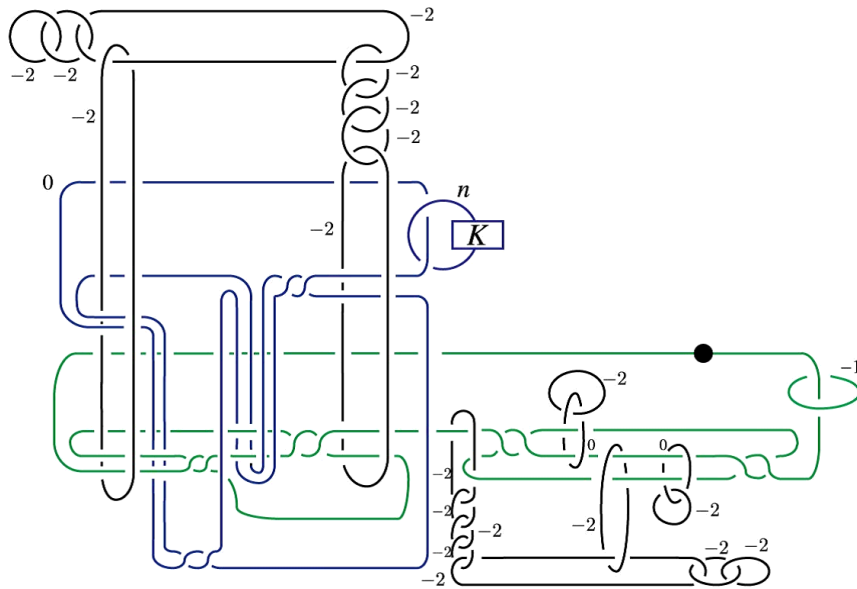

FIGURE 2.18. $Z_n(K)$

Proposition 2.4. *The 4-dimensional handlebodies $X_n(K)$ and $Z_n(K)$ have the same boundary.*

Proof. Because $Y_n(K)$ and $Z_n(K)$ have the same boundary, we show that $X_n(K)$ and $Y_n(K)$ have the same boundary by “S. Akbulut’s blowing up down process” (see [2, Figures 1–4] and [1, Figures 9–19]) as follows:

FIGURE 2.19. X_n

$\xrightarrow[\cong]{\partial}$
blowing down

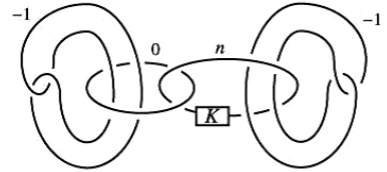

FIGURE 2.20.

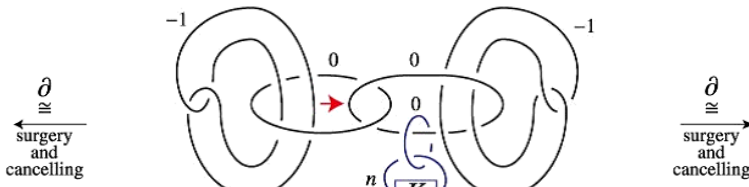

FIGURE 2.21.

$\xrightarrow[\cong]{\partial}$
surgery and cancelling

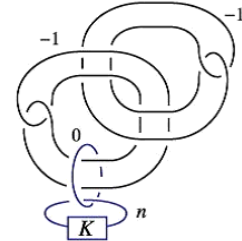

FIGURE 2.22.

$\xrightarrow[\cong]{\partial}$
blowing up

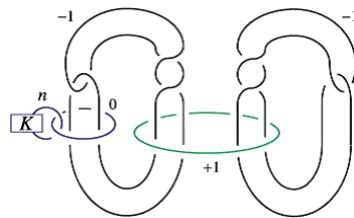

FIGURE 2.23.

$\xrightarrow[\cong]{\partial}$
isotopy

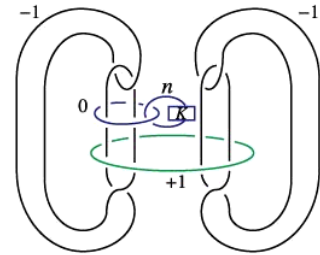

FIGURE 2.24.

$\xrightarrow[\cong]{\partial}$
isotopy

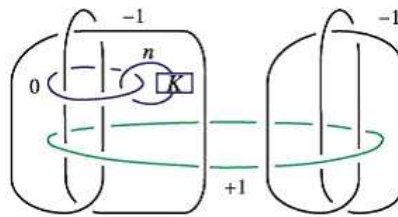

FIGURE 2.25.

$\xrightarrow[\cong]{\partial}$
blowing up

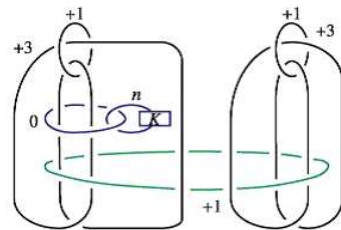

FIGURE 2.26.

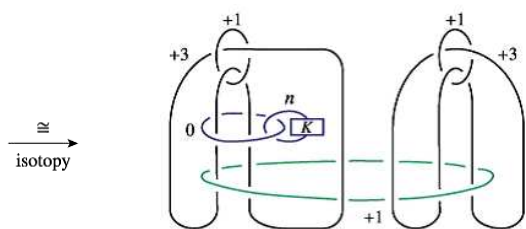

FIGURE 2.27.

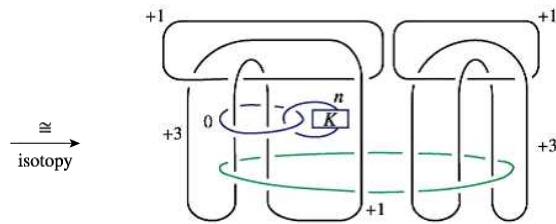

FIGURE 2.28.

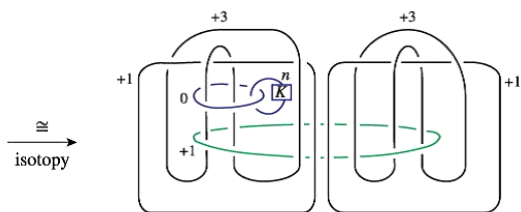

FIGURE 2.29.

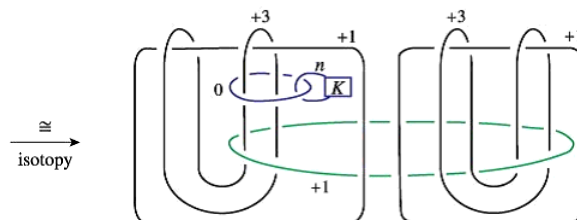

FIGURE 2.30.

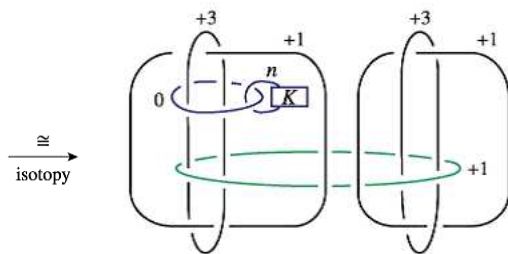

FIGURE 2.31.

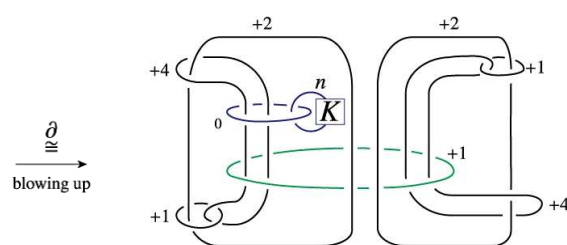

FIGURE 2.32.

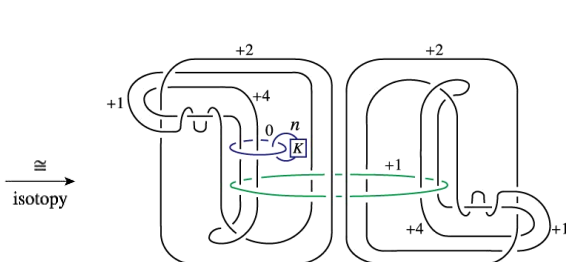

FIGURE 2.33.

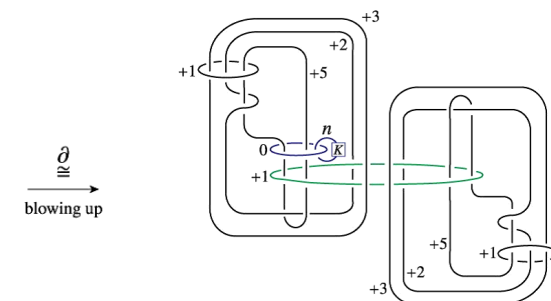

FIGURE 2.34.

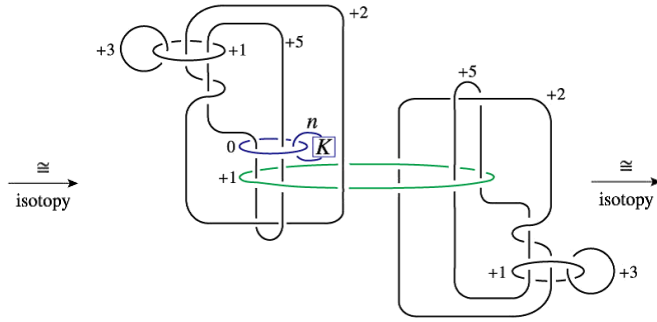

FIGURE 2.35.

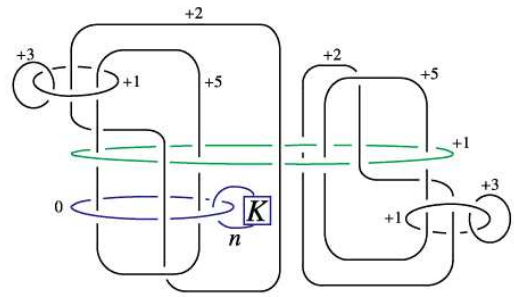

FIGURE 2.36.

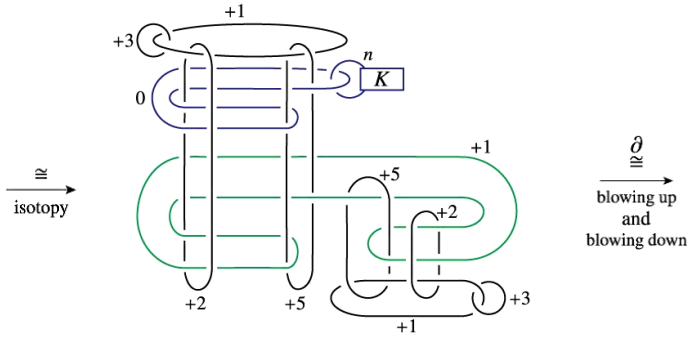

FIGURE 2.37.

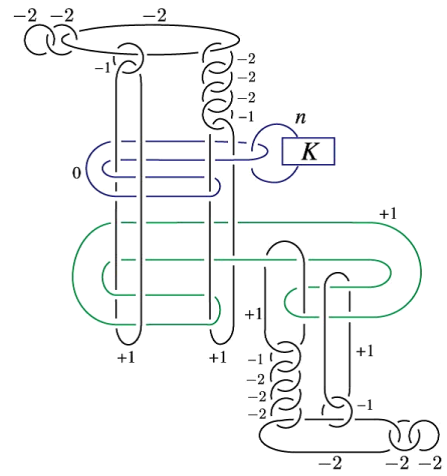

FIGURE 2.38.

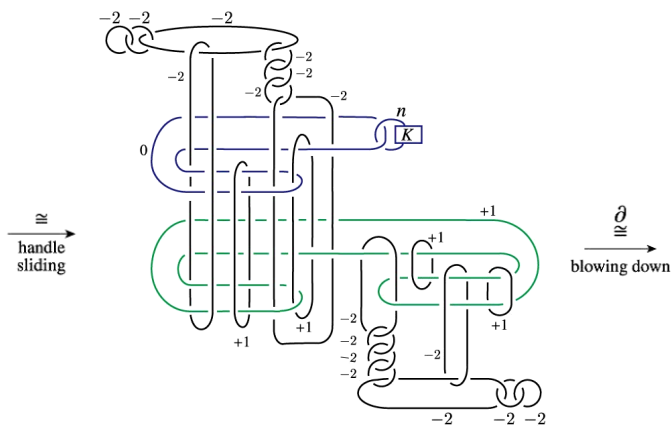

FIGURE 2.39.

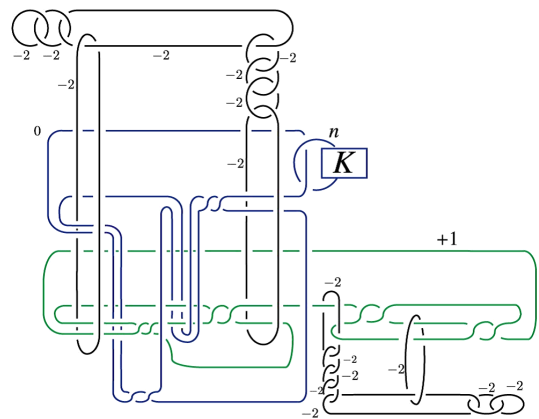

FIGURE 2.40.

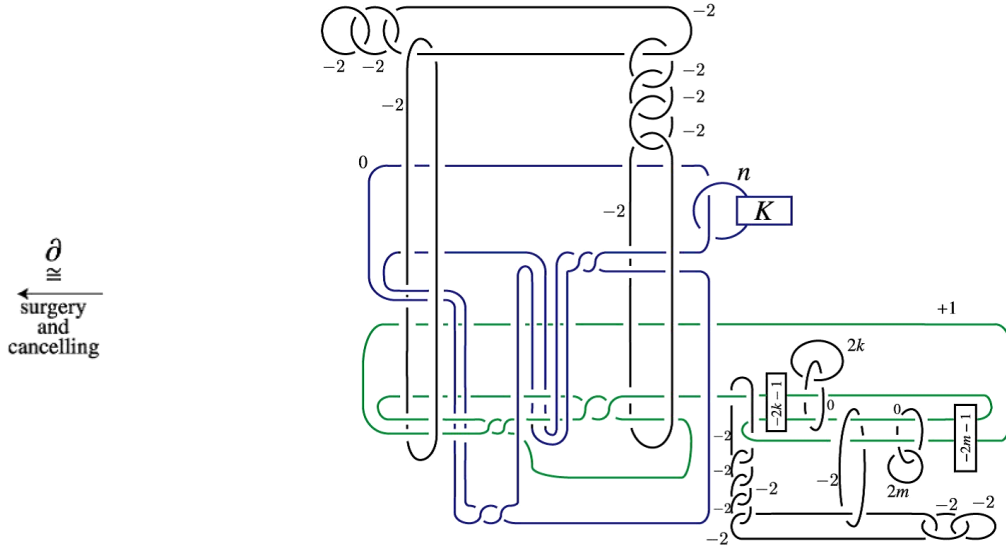

FIGURE 2.41.

Putting $k = m = -1$ in Figure 2.41, we get Figure 2.17. □

Remark 2.5. If $M_n(K)$ bounds a smooth contractible 4-manifold $W_n(K)$ and n is even, we have a smooth homotopy K3 surface $Z_n(K) \cup_{\partial} (-W_n(K))$.

Morgan and Szabó proved the following adjunction inequality.

Theorem 2.6 (see [11, Corollary 1.2]). *Let X be a smooth closed homotopy K3 surface and $g(x)$ be the minimal genus of smoothly embedded closed oriented surfaces representing x , where $x \in H_2(X; \mathbb{Z})$. For every $x \in H_2(X; \mathbb{Z}), x \neq 0, x \cdot x \geq 0$, we have*

$$2g(x) - 2 \geq x \cdot x.$$

The author is informed from Mikio Furuta [4] that the following stronger version can be proved essentially in the same way as Theorem 2.6.

Theorem 2.6' ([4]). *Let X be a smooth closed spin rational homology K3 surface and $g(x)$ be the minimal genus of smoothly embedded closed oriented surfaces representing x , where $x \in H_2(X; \mathbb{Z})$. For every $x \in H_2(X; \mathbb{Z}), x \neq 0, x \cdot x \geq 0$, we have*

$$2g(x) - 2 \geq x \cdot x.$$

We will prove Theorem 1.3.

Proof of Theorem 1.3. Let $N_{K,n}$ be a 4-dimensional handlebody constructed by attaching a 2-handle to D^4 along the n -framed knot K of Figure 2.18. Let x be a generator of $H_2(N_{K,n}; \mathbb{Z})$. This homology class x is represented by smooth closed oriented surface Σ with genus $g_s^n(K)$ and $x \cdot x = n$. The handlebody $N_{K,n}$ is a submanifold of $Z_n(K)$.

Suppose that $n > 2g_s^n(K) - 2$, $M_n(K)$ ($= \partial(Z_n(K))$) bounds a smooth spin rational 4-ball $W_n(K)$ and n is even, then we have a smooth spin rational homology K3 surface

$Z_n(K) \cup_{\partial} (-W_n(K))$ in which x persists and is represented by Σ with genus $g_s^n(K)$ and $x \cdot x = n$. We apply the adjunction inequality to x in $Z_n(K) \cup_{\partial} (-W_n(K))$. Then we get

$$2g_s^n(K) - 2 \geq x \cdot x = n.$$

This contradicts the assumption $n > 2g_s^n(K) - 2$. Therefore if $n > 2g_s^n(K) - 2$ and n is even, $M_n(K)$ does not bound any smooth spin rational 4-ball. By Remark 2.2, we know that if n is odd, $M_n(K)$ does not bound any smooth spin rational 4-ball. Therefore we conclude that if $n > 2g_s^n(K) - 2$, $M_n(K)$ does not bound any smooth spin rational 4-ball. \square

We will show Corollary 1.4.

Proof of Corollary 1.4. By Remark 2.3, if $D_-(LHT\sharp K, n)$ is a slice knot, $M_n(K)$ bounds a contractible 4-manifold. By Theorem 1.3, if $n > 2g_s^n(K) - 2$, $M_n(K)$ does not bound any smooth spin rational 4-ball. Therefore if $n > 2g_s^n(K) - 2$, $D_-(LHT\sharp K, n)$ is not a slice knot. \square

3. Proof of Theorem 1.6

We show that if (a_1, a_2, a_3, a_4) is any permutation of $(-1, -1, -2k - 1, -2m - 1)$, the knot represented by Figure 1.2 is not a slice knot, where $m \in \mathbb{Z}$ and $k \in \mathbb{Z}_{\geq 0}$.

Proof of Theorem 1.6. Let Y be the 4-dimensional handlebody represented by Figure 3.3 with intersection form $2E_8 \oplus 3\begin{pmatrix} 0 & 1 \\ 1 & 0 \end{pmatrix} \oplus 1$. By the proof of Proposition 2.4, $X_{-6}(U)$ and Y have the same boundary.

If $k \geq 0$ and the $+1$ -framed knot in Figure 3.3 is a slice knot, then we can blow it down and get a smooth simply connected 4-dimensional handlebody Z represented by Figure 3.4 with intersection form $2E_8 \oplus 3\begin{pmatrix} 0 & 1 \\ 1 & 0 \end{pmatrix}$. Because $M_{-6}(U)$ bounds a contractible 4-manifold $W_{-6}(U)$ (see Remark 2.3), we have a homotopy $K3$ surface $Z \cup_{\partial} (-W_{-6}(U))$. Let x be the element of $H_2(Z \cup_{\partial} (-W_{-6}(U)); \mathbb{Z})$ which is generated by attaching a 2-handle along the $2k$ -framed unknot in Figure 3.4. The homology class x is represented by a smooth S^2 and $x \cdot x = 2k$. By Theorem 2.6, we have the following inequality:

$$-2 \geq x \cdot x = 2k.$$

This contradicts the assumption $k \geq 0$. Therefore if $k \geq 0$, the $+1$ -framed knot in Figure 3.3 is not a slice knot. By the handle calculus from Figure 3.5 to Figure 3.6, we can show that if $k \geq 0$, the $+1$ -framed knot in Figure 3.6 is not a slice knot essentially in the same way as above. Similarly we can prove that if $k \geq 0$ and (a_1, a_2, a_3, a_4) is any permutation of $(-1, -1, -2k - 1, -2m - 1)$, the knot represented by Figure 1.2 is not a slice knot. \square

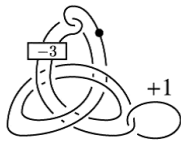

FIGURE 3.1. $W_{-6}(U)$



FIGURE 3.2. $X_{-6}(U)$

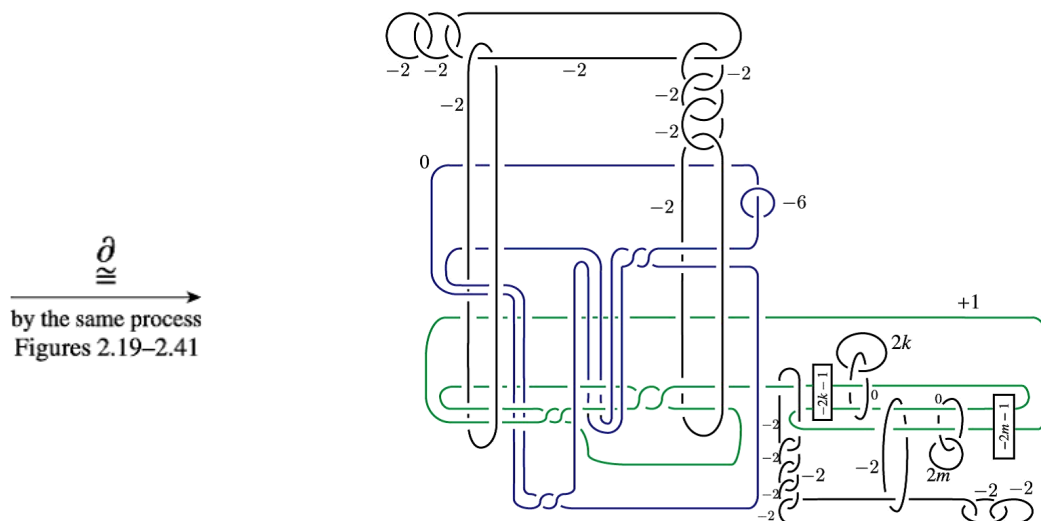

FIGURE 3.3. Y

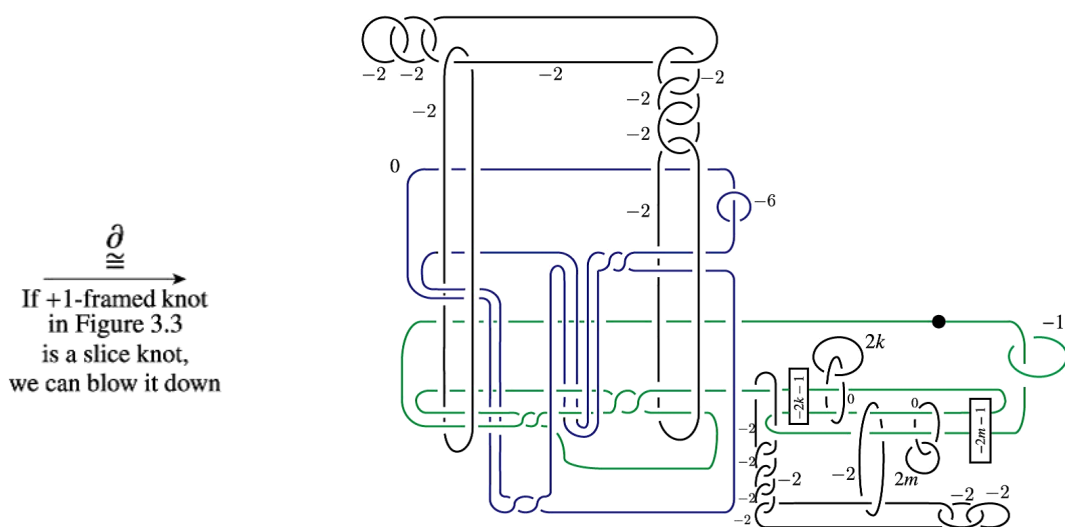

FIGURE 3.4. Z

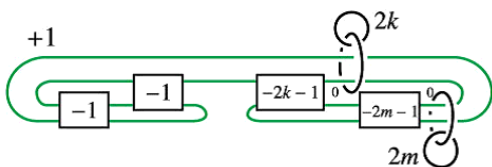

FIGURE 3.5.

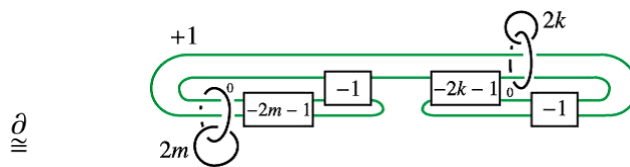

FIGURE 3.6.

4. Some homotopy $K3$ surfaces

We will exhibit some homotopy $K3$ surfaces obtained by the method of this paper.

(a). Since $RHT \sharp LHT$ is a slice knot, we have a smooth S^2 with self intersection 0 in $X_0(RHT)$. By performing surgery on the S^2 , we have a contractible 4-manifold $W'_0(RHT)$ represented by Figure 4.1. By Proposition 2.4, $W'_0(RHT)$ and $Z_0(RHT)$ have the same boundary. Therefore we have a homotopy $K3$ surface $Z_0(RHT) \cup_{\partial} (-W'_0(RHT))$.



FIGURE 4.1. $W'_0(RHT)$

\cong_{∂}

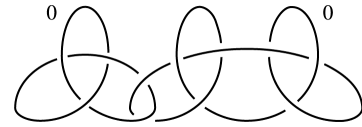

FIGURE 4.2. $X_0(RHT)$

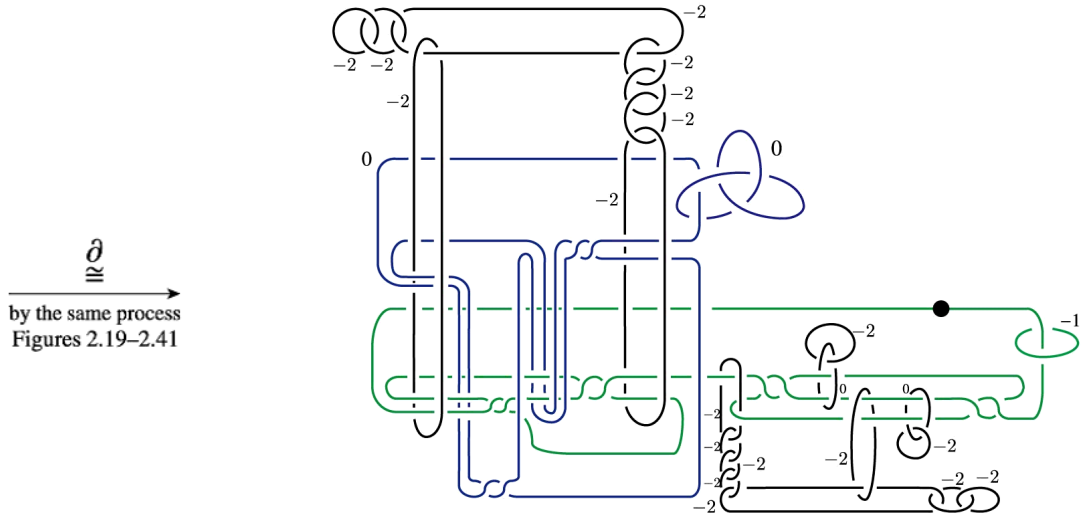

FIGURE 4.3. $Z_0(RHT)$

$\xrightarrow[\cong]{\partial}$
by the same process
Figures 2.19–2.41

Let X be the homotopy $K3$ surface $Z_0(RHT) \cup_{\partial} (-W'_0(RHT))$. By $g_s^0(RHT) = g_4(RHT) = 1$, we have a smooth T^2 with trivial normal bundle represented by Figure 4.5 in $Z_0(RHT) \subset X$. Then we can perform *knot surgery* which is introduced by Fintushel and Stern [3] on the $T^2 \times D^2$ in X . By the existence of the 2-handle with 0-framing which is linking to the 0-framed RHT in $Z_0(RHT)$, we have $\pi_1(X \setminus T^2) = 1$. If we perform the knot surgery using a knot whose symmetric Alexander polynomial is $t^2 - t + 1$ for example, then the resulting 4-manifold is an exotic homotopy $K3$ surface (see [3]).

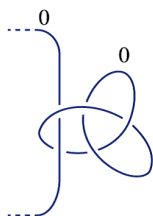

FIGURE 4.4. 0-framed RHT in $Z_0(RHT)$

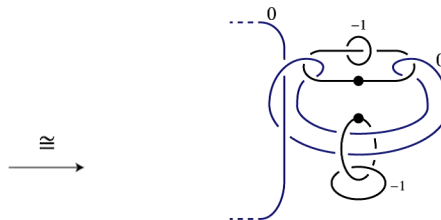

FIGURE 4.5. $T^2 \times D^2$ in $Z_0(RHT)$

(b). By Proposition 2.1, $X_0(RHT)$ and $V_0(RHT)$ have the same boundary. Since $RHT \sharp LHT$ is a slice knot, $D_-(RHT \sharp LHT, 0)$ is a slice knot. By Remark 2.3, we have a contractible 4-manifold represented by Figure 4.8.



FIGURE 4.6. $X_0(RHT)$

\cong

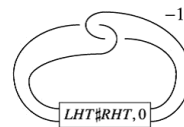

FIGURE 4.7. $V_0(RHT)$

\cong

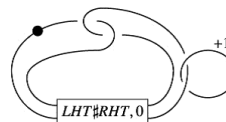

FIGURE 4.8. $W_0(RHT)$

Since $X_0(RHT)$ and $Z_0(RHT)$ have the same boundary, we have a homotopy $K3$ surface $Z_0(RHT) \cup_{\partial} (-W_0(RHT))$.

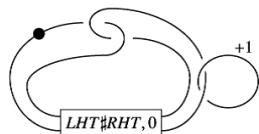

FIGURE 4.9. $W_0(RHT)$

\cong

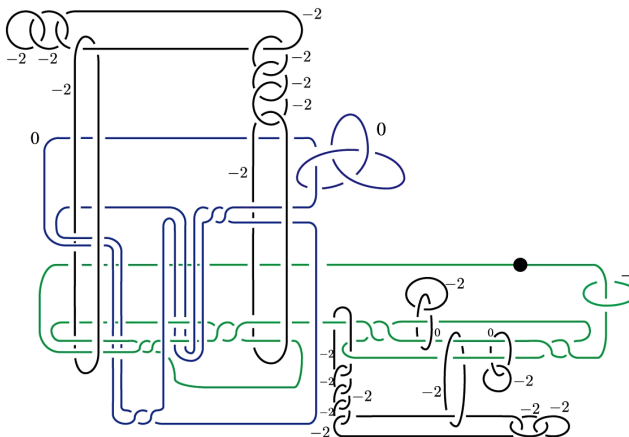

FIGURE 4.10. $Z_0(RHT)$

(c). Let $Y'_n(K)$ be the 4-dimensional handlebody represented by Figure 4.11 with intersection form $2E_8 \oplus 2\begin{pmatrix} 0 & 1 \\ 1 & 0 \end{pmatrix} \oplus \begin{pmatrix} 0 & 1 \\ 1 & n \end{pmatrix} \oplus 1$. Note that $Y_n(K)$ of Figure 2.17 and $Y'_n(K)$ have the same boundary.

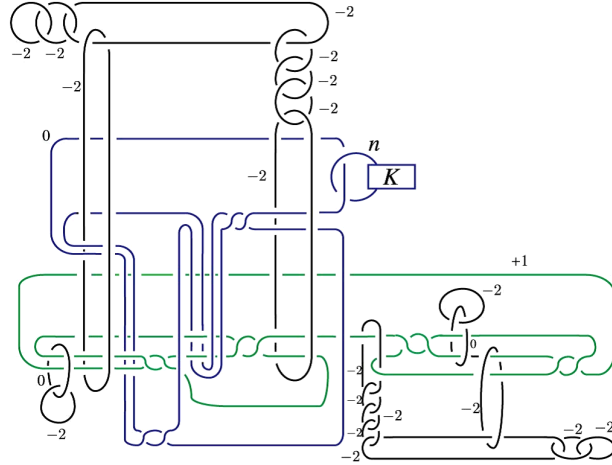

FIGURE 4.11. $Y'_n(K)$

Since the +1-framed knot in Figure 4.11 is a slice knot (the connected sum of two figure eight knots), we can blow it down. Then we have a smooth simply connected 4-dimensional handlebody $Z'_n(K)$ represented by Figure 4.12 with intersection form $2E_8 \oplus 2\begin{pmatrix} 0 & 1 \\ 1 & 0 \end{pmatrix} \oplus \begin{pmatrix} 0 & 1 \\ 1 & n \end{pmatrix}$. Note that $Y'_n(K)$ and $Z'_n(K)$ have the same boundary.

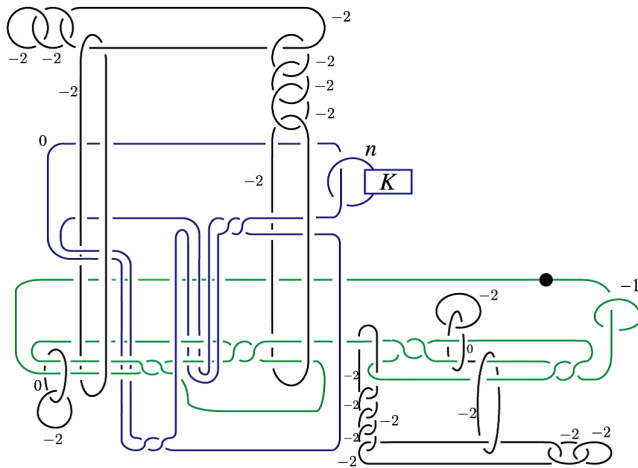

FIGURE 4.12. $Z'_n(K)$

Therefore we have homotopy $K3$ surfaces $Z'_0(RHT) \cup_{\partial} (-W'_0(RHT))$ and $Z'_0(RHT) \cup_{\partial} (-W_0(RHT))$.

5. Appendix: On homology 3-spheres which bound a contractible 4-manifold

We show a series of homology 3-spheres which bound a contractible 4-manifold. Let $V_{K_1,s}(K_2,t)$ be the 4-dimensional handlebody represented by Figure 5.1 and $M_{K_1,s}(K_2,t)$ be $\partial(V_{K_1,s}(K_2,t))$, where K_1 and K_2 are knots and $s, t \in \mathbb{Z}$. If K_1 (or K_2) is an unknot U , a box in Figure 5.1 represents the s full twists (or t full twists). Note that $M_{K_1,s}(K_2,t)$ is a homology 3-sphere.

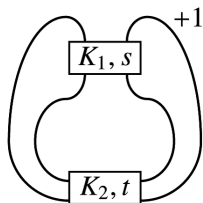

FIGURE 5.1. $V_{K_1,s}(K_2,t)$

Let $T_{s,s+1}$ be a $(s, s+1)$ -torus knot and $T_{1,2}$ be an unknot U , where s is a positive integer. We choose an orientation of S^3 such that $T_{2,3}$ is *RHT*.

Theorem 5.1. *The homology 3-sphere $M_{T_{s,s+1},s(s+1)}(K,n)$ bounds a contractible 4-manifold, where K is any knot and n is any integer.*

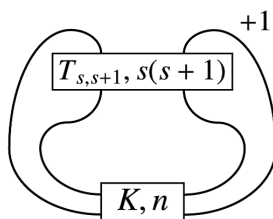

FIGURE 5.2. $V_{T_{s,s+1},s(s+1)}(K,n)$

Example . If s is equal to 1, $T_{1,2}$ is an unknot U . The homology 3-sphere $M_{U,2}(K,n)$ bounds a contractible 4-manifold, where K is any knot and n is any integer.

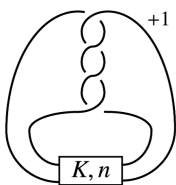

FIGURE 5.3. $V_{U,2}(K,n)$

To prove Theorem 5.1, we show the following Lemma 5.2.

Lemma 5.2. *The 4-dimensional handlebodies represented by Figures 5.4, 5.5 and 5.6 have the same boundary, where K_1, K_2 and K_3 are knots and $s, t, r \in \mathbb{Z}$.*

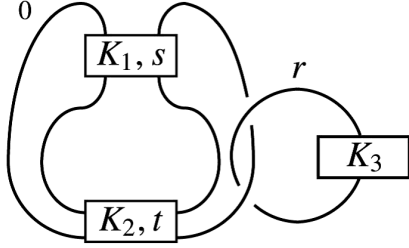

FIGURE 5.4.

\cong_{∂}

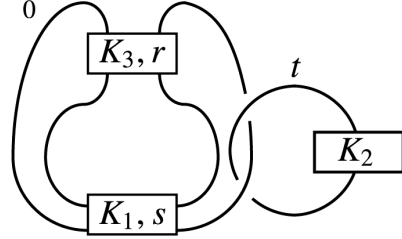

FIGURE 5.5.

\cong_{∂}

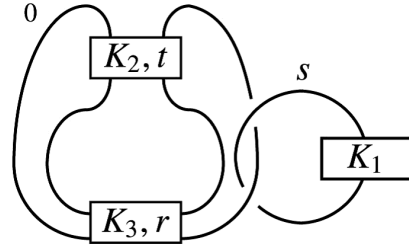

FIGURE 5.6.

Proof. We show Lemma 5.2 by the following handle calculus:

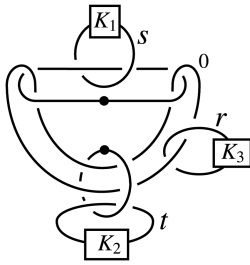

FIGURE 5.7.

\cong_{∂}

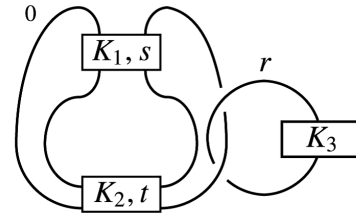

FIGURE 5.8.

$\xrightarrow[\text{surgery}]{\cong_{\partial}}$
 $\bullet \rightarrow 0$
 $0 \rightarrow \bullet$

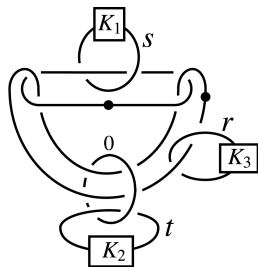

FIGURE 5.9.

\cong_{∂}

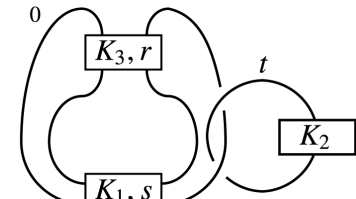

FIGURE 5.10.

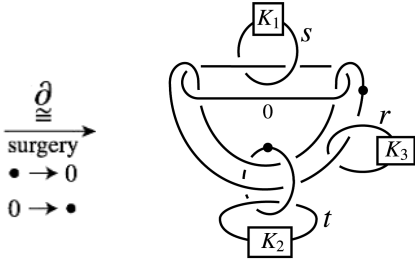

FIGURE 5.11.

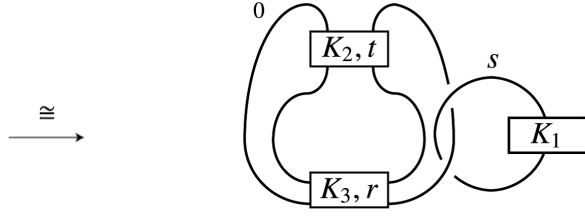

FIGURE 5.12.

□

We will prove Theorem 5.1.

Proof of Theorem 5.1. We prove Theorem 5.1 by the following handle calculus:

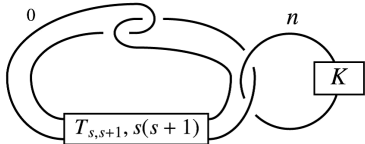

FIGURE 5.13.

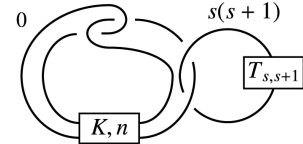
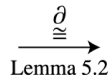

FIGURE 5.14.

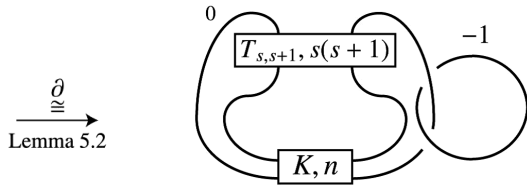

FIGURE 5.15.

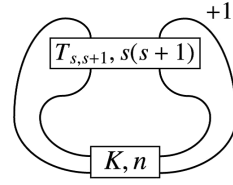
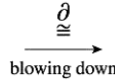

FIGURE 5.16. $V_{T_{s,s+1}, s(s+1)}(K, n)$

Note that the left side knot in Figure 5.13 is $D_+(T_{s,s+1}, s(s+1))$. If s is equal to 1, it is known that $D_+(U, 2)$ is a slice knot. If $s \geq 2$, Litherland [8] remarks that $D_+(T_{s,s+1}, s(s+1))$ is a slice knot. Therefore we have a smooth S^2 with self intersection 0 in the 4-dimensional handlebody represented by Figure 5.13. By performing surgery on the S^2 , we have a contractible 4-manifold W represented by Figure 5.18.

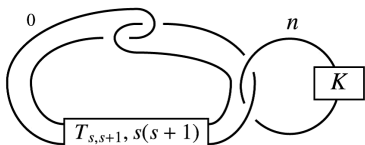

FIGURE 5.17.

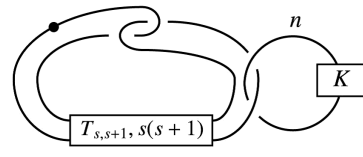

FIGURE 5.18. W

□

Remark 5.3. By Theorem 5.1, the 4-manifold $V_{T_{s,s+1},s(s+1)}(K,n) \cup_{\partial} (-W)$ is a homotopy to $\mathbb{C}P^2$.

Remark 5.4. In the case s is equal to 1, we could prove that this 4-manifold is diffeomorphic to $\mathbb{C}P^2$.

Remark 5.5. Let t be a positive integer. If K is $T_{t,t+1}$ and n is equal to $t(t+1)$ in Figure 5.13, we have a smooth S^2 with self intersection 0 in the 4-dimensional handlebody represented by Figure 5.14. By performing surgery on the S^2 , we have a contractible 4-manifold represented by Figure 5.19. By the proof of Theorem 5.1, the 4-dimensional handlebodies represented by Figures 5.19 and 5.20 have the same boundary. Therefore by gluing these two contractible 4-manifolds, we get a homotopy S^4 . We do not know whether or not this homotopy S^4 is diffeomorphic to S^4 .

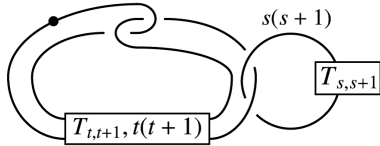

FIGURE 5.19.

$$\cong$$

FIGURE 5.20.

References

- [1] S. Akbulut, *A fake compact contractible 4-manifold*, J. Differential Geom. **33** (1991), no. 2, 335–356.
- [2] S. Akbulut, *A note on a homology sphere*, Proc. Amer. Math. Soc. **125** (1997), no. 2, 625–628.
- [3] R. Fintushel and R. Stern, *Knots, links, and 4-manifolds*, Invent. Math. **134**, (1998), no. 2, 363–400.
- [4] M. Furuta, (private communication)
- [5] C. McA. Gordon, *Knots, homology spheres, and contractible 4-manifolds*, Topology **14** (1975), 151–172.
- [6] M. Hedden, *Knot Floer homology of Whitehead doubles*, Geom. Topol. **11** (2007), 2277–2338.
- [7] R. C. Kirby, *Problems in low dimensional manifold theory*, Algebraic and geometric topology (Stanford, 1976) **32**, Part 2 of Proc. Sympos. Pure Math., 273–312. (Amer. Math. Soc., Providence, R.I. 1978)
- [8] R. A. Litherland, *Slicing doubles of knots in homology 3-spheres*, Invent. Math. **54** (1979), no. 1, 69–74.
- [9] N. Maruyama, *Knot surgery descriptions of some closed oriented 3-manifolds*, Journal of Tsuda College **16** (1984), 1–14.
- [10] Y. Matsumoto, *On the bounding genus of homology 3-spheres*, J. Fac. Sci. Univ. Tokyo Sect. IA Math. **29** (1982), no. 2, 287–318.
- [11] J. W. Morgan and Z. Szabó, *Homotopy K3 surfaces and mod 2 Seiberg-Witten invariants*, Math. Res. Lett. **4** (1997), no. 1, 17–21.
- [12] M. Tange, *Heegaard Floer homology of Matsumoto’s manifolds*, <http://www.math.tsukuba.ac.jp/~tange/MatsumotoM.pdf>
- [13] M. Tsuchiya, *On homology 3-spheres defined by two knots*, arXiv:1401.7445v2 (2014). (To appear in Osaka J. Math.)

DEPARTMENT OF MATHEMATICS, GAKUSHUIN UNIVERSITY, 5-1, MEJIRO 1-CHOME, TOSHIMA-KU, TOKYO, 171-8588, JAPAN

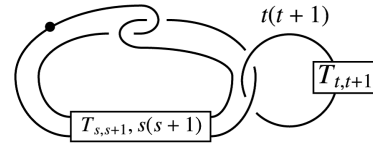
E-mail address: tsuchiya@math.gakushuin.ac.jp