

ON METRICS DEFINED BY LENGTH SPECTRA ON TEICHMÜLLER SPACES OF SURFACES WITH BOUNDARY

YOU LIANG ZHONG, LIXIN LIU, AND WEIXU SU

ABSTRACT. We prove that the length spectrum metric and the arc-length spectrum metric are almost-isometric on the ϵ_0 -relative part of Teichmüller spaces of surfaces with boundary.

Keywords: Teichmüller space; length spectrum metric; arc-length spectrum metric.

1. INTRODUCTION

Let $S = S_{g,p,b}$ be a connected oriented surface of genus $g \geq 0$ with $p \geq 0$ punctures and $b \geq 0$ boundary components. The boundary of S is denoted by ∂S . The Euler characteristic of S is $\mathcal{X}(S) = 2 - 2g - p - b$. In this paper, we always assume that $g \geq 0$, $p \geq 0$, $b \geq 1$ and $\mathcal{X}(S) < 0$.

In the following, all hyperbolic metrics on S are assumed to be complete and totally geodesic on the boundary components. By the assumption that $\mathcal{X}(S) < 0$, there always exist a hyperbolic metric on S .

A *marked hyperbolic metric* (X, f) is a hyperbolic metric X on S equipped with an orientation-preserving homeomorphism $f : S \rightarrow X$, where f maps each component of ∂S to a geodesic boundary of X and maps punctures to cusps. The *reduced Teichmüller space* of S , denoted by $\mathcal{T}(S)$, is the set of equivalence classes of marked hyperbolic metrics on S , where two markings (X_1, f_1) and (X_2, f_2) are *equivalent* if there is an isometry $h : X_1 \rightarrow X_2$ homotopic to $f_2 \circ f_1^{-1}$. We should point out that, in this reduced theory, homotopies do not necessarily fix ∂S pointwise. The notion of a reduced Teichmüller space was introduced by Earle [8, 9], where he defined the space by using quasiconformal deformations of Fuchsian groups (of the second kind).

Since all Teichmüller spaces that we consider are reduced, we shall omit the word “reduced” in this paper. For the sake of simplicity, we shall denote a marked hyperbolic surface (X, f) or its equivalence class in $\mathcal{T}(S)$ by X , without explicit reference to the marking or to the equivalence relation.

There are several natural metrics on Teichmüller space, e.g. the classical Teichmüller metric and the Weil-Petersson metric. In this paper, we will study the length spectrum metric and the arc-length spectrum metric. The length spectrum metric was first studied by Sorvali [24, 25], which can also be considered as the symmetrization of an asymmetric Finsler metric defined

Date: May 28, 2021.

L. Liu and Y. Zhong are partially supported by NSFC No: 11271378; W. Su is partially supported by NSFC No: 11201078.

by Thurston [27]. The arc-length spectrum metric is new, which is defined only on Teichmüller spaces of surfaces with boundary. Both of the two above metrics are defined by using hyperbolic (or geodesic) length functions. There is no doubt that hyperbolic length is one of the most fundamental tools in Teichmüller theory. We note that by recent works of Danciger, Guéritaud and Kassel [7], deformations of hyperbolic surfaces with boundary is related to Margulis spacetimes in Lorentz geometry.

1.1. Metrics defined by length spectra. To provide concrete definitions and state our results, we fix some terminology and notation.

A simple closed curve on S is said to be *peripheral* if it is isotopic to a puncture. It is said to be *essential* if it is neither peripheral nor isotopic to a point. It should be noticed that an essential closed curve may be isotopic to a boundary component. We denote by $\mathcal{C}(S)$ the set of homotopy classes of essential simple closed curves on S .

An *arc* on S is the homeomorphic image of a closed interval which is properly embedded in S , that is, the interior of the arc is in the interior of S and the endpoints of the arc lie on ∂S . An arc is said to be *essential* if it is not isotopic to a subset of ∂S . All homotopies of arcs that we consider here are relative to ∂S . However, we don't require homotopies to fix ∂S pointwise. Let $\mathcal{B}(S)$ be the set of homotopy classes of essential arcs on S .

For any $\alpha \in \mathcal{B}(S) \cup \mathcal{C}(S)$ and $X \in \mathcal{T}(S)$, we denote by $\ell_X(\alpha)$ the *hyperbolic length* of α , that is, the length of the geodesic representation of α under the hyperbolic metric X .

For surfaces without boundary, Thurston [27] defined the following asymmetric metric:

$$d(X, Y) = \log \sup_{\alpha \in \mathcal{C}(S)} \frac{\ell_Y(\alpha)}{\ell_X(\alpha)}.$$

For surfaces with boundary, the following asymmetric metric is a natural generalization of Thurston's formula [16, 3] :

$$\bar{d}(X, Y) = \log \sup_{\alpha \in \mathcal{C}(S) \cup \mathcal{B}(S)} \frac{\ell_Y(\alpha)}{\ell_X(\alpha)}.$$

Both of the above two metrics satisfy the separation axiom and triangle inequality, but none of them satisfies the symmetric condition.

Remark 1.1. For surfaces with boundary, there exist (see [22]) distinct hyperbolic structures X and Y on S such that for any element $\alpha \in \mathcal{C}(S)$, $\frac{\ell_X(\alpha)}{\ell_Y(\alpha)} < 1$. This implies that

$$\log \sup_{\alpha \in \mathcal{C}(S)} \frac{\ell_X(\alpha)}{\ell_Y(\alpha)} \leq 0.$$

As a result, it's necessary to consider the union of closed curves and arcs in the definition of \bar{d} .

Definition 1.2. The *length spectrum metric* d_L on $\mathcal{T}(S)$ is defined by

$$d_L(X, Y) = \log \sup_{\alpha \in \mathcal{C}(S)} \left\{ \frac{\ell_X(\alpha)}{\ell_Y(\alpha)}, \frac{\ell_Y(\alpha)}{\ell_X(\alpha)} \right\}.$$

Definition 1.3. The *arc-length spectrum metric* δ_L on $\mathcal{T}(S)$ is defined by

$$\begin{aligned} \delta_L(X, Y) &= \max\{\bar{d}(X, Y), \bar{d}(Y, X)\} \\ &= \log \sup_{\alpha \in \mathcal{C}(S) \cup \mathcal{B}(S)} \left\{ \frac{\ell_X(\alpha)}{\ell_Y(\alpha)}, \frac{\ell_Y(\alpha)}{\ell_X(\alpha)} \right\}. \end{aligned}$$

The fact that d_L is a metric on $\mathcal{T}(S)$ was proved in [24, 13]. It is obvious that $d_L \leq \delta_L$. When $b = 0$, since $\mathcal{B}(S)$ is empty, $d_L = \delta_L$. For more works about the length spectrum metric, one refers to [6, 11, 12, 13, 14, 15, 16, 21, 23].

1.2. Main theorems. The aim of this paper is to compare the length spectrum metric with the arc-length spectrum on a large subset of $\mathcal{T}(S)$.

Definition 1.4. Given $\epsilon_0 > 0$, the ϵ_0 -*relative part* of $\mathcal{T}(S)$ is the subset of $\mathcal{T}(S)$ consisting of hyperbolic metrics with lengths of all boundary components bounded above by ϵ_0 .

In this paper we prove:

Theorem 1.5. *There is a constant C depending on ϵ_0 such that*

$$d_L(X, Y) \leq \delta_L(X, Y) \leq d_L(X, Y) + C$$

for any X, Y in the ϵ_0 -relative part of $\mathcal{T}(S)$.

The left-hand side inequality follows by definition. The right-hand side inequality is equivalent to the following result:

Theorem 1.6. *There exists a positive constant K depending on ϵ_0 such that*

$$\sup_{\beta \in \mathcal{C}(S) \cup \mathcal{B}(S)} \left\{ \frac{\ell_{X_1}(\beta)}{\ell_{X_2}(\beta)}, \frac{\ell_{X_2}(\beta)}{\ell_{X_1}(\beta)} \right\} \leq K \cdot \sup_{\alpha \in \mathcal{C}(S)} \left\{ \frac{\ell_{X_1}(\alpha)}{\ell_{X_2}(\alpha)}, \frac{\ell_{X_2}(\alpha)}{\ell_{X_1}(\alpha)} \right\}$$

for any X_1, X_2 in the ϵ_0 -relative part of $\mathcal{T}(S)$.

Remark 1.7. Recall that a map $f : M \rightarrow N$ between metric spaces is called a (λ, C) *quasi-isometry* (with given constants $C \geq 0$ and $\lambda \geq 1$) if

$$\frac{1}{\lambda} d_M(x, y) - C \leq d_N(f(x), f(y)) \leq \lambda d_M(x, y) + C$$

for all $x, y \in M$, and the C -neighborhood of $f(M)$ in N is all of N . An $(1, C)$ quasi-isometry is called an *almost-isometry*.

Theorem 1.5 implies that the length spectrum metric and the arc-length spectrum metric are almost-isometric on the ϵ_0 -relative part of $\mathcal{T}(S)$.

For $0 < \epsilon < \epsilon_0$, the ϵ -*thick part* of $\mathcal{T}(S)$ is the subset of $\mathcal{T}(S)$ consisting of hyperbolic metrics X with hyperbolic length $\ell_X(\alpha)$ not less than ϵ for all $\alpha \in \mathcal{C}(S)$. The intersection of the ϵ -thick part and the ϵ_0 -relative part of $\mathcal{T}(S)$ is called the ϵ_0 -*relative ϵ -thick part* of $\mathcal{T}(S)$. We can deduce from [16, Theorem 3.6] that the length spectrum metric and the arc-length spectrum metric are almost-isometric on the ϵ_0 -relative ϵ -thick part of $\mathcal{T}(S)$. In fact,

by [16, Proposition 3.5], there exists a positive constant K_0 depending on ϵ and ϵ_0 such that, for any X_1, X_2 in the ϵ -thick ϵ_0 -relative part of $\mathcal{T}(S)$,

$$(1) \quad \sup_{\beta \in \mathcal{C}(S) \cup \mathcal{B}(S)} \left\{ \frac{\ell_{X_2}(\beta)}{\ell_{X_1}(\beta)} \right\} \leq K_0 \cdot \sup_{\alpha \in \mathcal{C}(S)} \left\{ \frac{\ell_{X_2}(\alpha)}{\ell_{X_1}(\alpha)} \right\}.$$

However, the above inequality does not hold on the whole ϵ_0 -relative part of $\mathcal{T}(S)$. A counter example is constructed at the end of Section 4 (Example 4.8). As a result, Theorem 1.5 can be seen as an extension of [16, Theorem 3.6].

Remark 1.8. We should mention that, in the statement of [16, Proposition 3.5] the constant K_0 depends on ϵ , ϵ_0 and the topology of S . But during the proof of (1), the constant K_0 only depend on ϵ and ϵ_0 . Similarly, the constants C and K in Theorem 1.5 and Theorem 1.6 are independent of the topology of the surface S .

1.3. Outline of the paper. In Section 2 we will recall some elementary results in hyperbolic geometry that we need later. The proof of Theorem 1.6 will be given in Section 3 and Section 4. In Section 3, we deal with the case where the constant ϵ_0 is sufficiently small. In Section 4, we use the results in Section 3 to prove Theorem 1.6 in the general case.

To prove Theorem 1.6, we will use the technique of “replacing an arc by a loop” to show that the length ratio of an arc can be controlled by the length ratio of some appropriated simple closed curve. Such an idea was initiated by Minsky [20] and it has many applications (see, e.g., Rafi [6]).

We will discuss related results on moduli spaces and on surfaces of infinite type in Section 5.

1.4. Acknowledgements. The authors would like to thank the referee for many corrections and useful suggestions.

2. PRELIMINARIES

2.1. Formulae for right-angle pentagon and hexagon. For a right-angled pentagon on the hyperbolic plane with consecutive side lengths a, b, α, c and β , as in Figure 1, we have

$$(2) \quad \cosh c = \sinh a \sinh b.$$

We also need the following formula for a right-angled hexagon with consecutive side lengths a, γ, b, α, c and β , as in Figure 2 :

$$(3) \quad \cosh c + \cosh a \cosh b = \sinh a \sinh b \cosh \gamma.$$

The inverse hyperbolic sine function and the inverse hyperbolic cosine function are given by

$$(4) \quad \sinh^{-1} x = \ln(x + \sqrt{x^2 + 1})$$

and

$$(5) \quad \cosh^{-1} x = \ln(x + \sqrt{x^2 - 1}), \text{ for } x \geq 1.$$

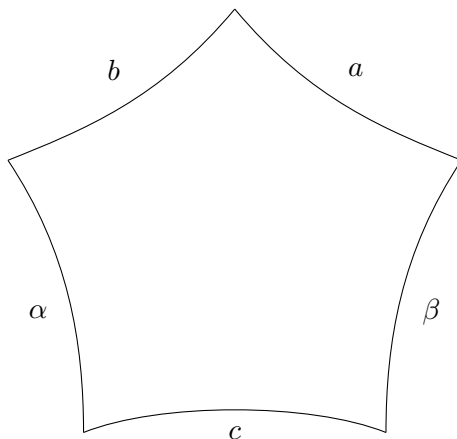

FIGURE 1. An example of pentagon.

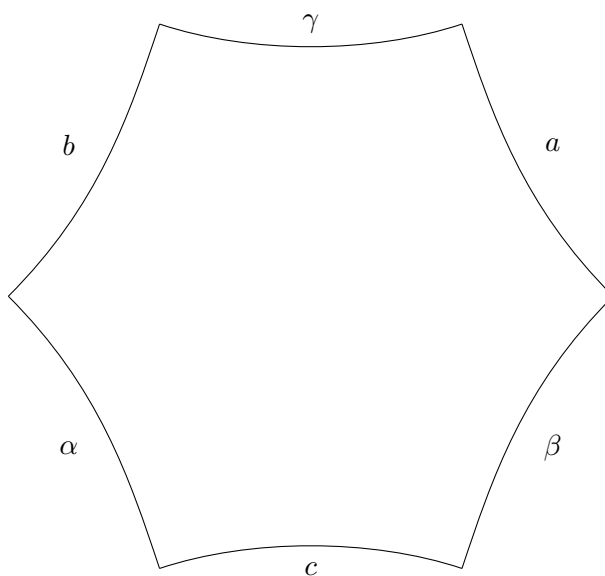

FIGURE 2. An example of hexagon.

Let f and g be any two functions defined on a set U . We call $f \asymp g$ if there exists a positive constant C such that

$$C^{-1} \cdot f(\tau) \leq g(\tau) \leq C \cdot f(\tau), \quad \forall \tau \in U.$$

Usually the constant C will depend on the choice of U .

Given $\epsilon_0 > 0$, we have $x \asymp \sinh x$ if $x \leq \epsilon_0$, and $\sinh x \asymp e^x$ if $x \geq \epsilon_0$. Here it is obvious that the multiplicative constants for \asymp depend on ϵ_0 .

2.2. Regular annulus. Let X be a hyperbolic structure on S and denote the distance between two distinct points p and q on X by $d_X(p, q)$. The distance between two subsets S_1 and S_2 of X is defined by

$$d_X(S_1, S_2) = \inf_{x_1 \in S_1, x_2 \in S_2} d_X(x_1, x_2).$$

Let A be an annulus embedded in S . Denote the two boundaries of A by γ and γ' . The annulus A is said to be *regular* if there is a constant $w > 0$ such that

$$d_X(p, \gamma') = d_X(p', \gamma) = w, \forall p \in \gamma, p' \in \gamma'.$$

For a positive number δ and a simple closed geodesic γ on X (either in the interior of X or be a boundary component of X), we denote the δ -neighborhood of γ by

$$A_\delta(\gamma) = \{x \in X \mid d_X(x, \gamma) < \delta\}.$$

By the Collar Lemma (ref. [5]), $A_\delta(\gamma)$ is a regular annulus if

$$\delta \leq \sinh^{-1}\left(\frac{1}{\sinh \frac{\ell_X(\gamma)}{2}}\right).$$

Suppose that $A_\delta(\gamma)$ is a regular annulus. If γ is in the interior of X , then the width of $A_\delta(\gamma)$ is equal to 2δ and γ lies in the middle of $A_\delta(\gamma)$. If γ is a boundary component of S , then the width of $A_\delta(\gamma)$ is equal to δ . In both cases, we will say that $A_\delta(\gamma)$ is a *regular annulus around γ* .

We define the auxiliary function $\eta(x)$ by

$$\eta(x) := \sinh^{-1}\left(\frac{1}{\sinh \frac{x}{2}}\right) = \frac{1}{2} \ln \frac{\cosh(x/2) + 1}{\cosh(x/2) - 1}.$$

By the Collar Lemma again, for any two distinct simple closed geodesics γ_1 and γ_2 on X , the regular annuli $A_{\eta(\ell_X(\gamma_1))}(\gamma_1)$ and $A_{\eta(\ell_X(\gamma_2))}(\gamma_2)$ are disjoint.

Throughout this paper, we only consider regular annuli as collar neighborhoods of boundary components of X . In this case, as we show in Figure 3, the geodesic γ is a boundary component of X . The regular annulus contains γ and γ' as boundary components. We call γ' the *inner boundary* of $A_\delta(\gamma)$ and denote the length of γ' on X by $\ell_X(\gamma')$ (even though γ' is not a geodesic, now and later, we will use the notation ℓ to denote the length of an inner boundary when there is no cause of confusion). The relation between $\ell_X(\gamma)$ and $\ell_X(\gamma')$ is given by (see [6, 19])

$$(6) \quad \ell_X(\gamma') = \ell_X(\gamma) \cdot \cosh d_X(\gamma, \gamma').$$

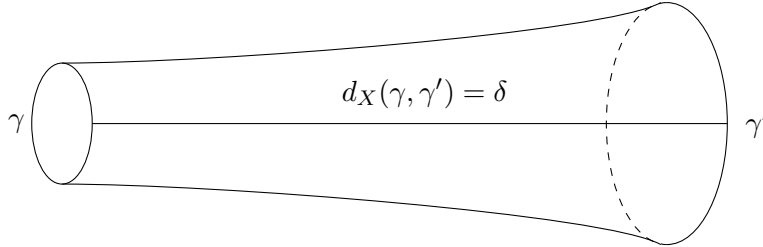

FIGURE 3. An example of regular annulus around γ on X , where γ is a boundary component of X .

3. PROOF OF THEOREM 1.6: THE CASE WHERE ϵ_0 IS SUFFICIENTLY SMALL

The proof of Theorem 1.6 is separated into two steps. Recall that ϵ_0 is an upper bound for the lengths of all boundary components of S . In this section we will prove Theorem 1.6 in the case where ϵ_0 is sufficiently small. We will consider the general case in next section.

We assume that $\epsilon_0 < e^{-1} \ln(1 + \sqrt{2})$. Here the constant $e^{-1} \ln(1 + \sqrt{2})$ is chosen such that the width of some regular annulus neighborhood around a boundary component of S has an explicit lower bound. Let $\epsilon'_0 = \ln(1 + \sqrt{2})$. Note that $\epsilon_0 < \epsilon'_0 < 2$. Let X_1 and X_2 be two hyperbolic metrics in the ϵ_0 -relative part of $\mathcal{T}(S)$. We fix an essential arc $\beta \in \mathcal{B}(S)$. Denote the boundary curves where the two endpoints of β lie by γ and γ' .

3.1. The case where $\gamma \neq \gamma'$.

In this subsection, we consider the case where γ and γ' are not the same boundary component of S .

There is a unique (isotopy class of) simple closed curve α which is homotopic to the boundary of a regular neighborhood of $\beta \cup \gamma \cup \gamma'$. To simplify notation, for a given hyperbolic metric on S , we will denote by α , β , γ and γ' the geodesic representations of the isotopy classes of α , β , γ and γ' , if no confusion arises.

Lemma 3.1. *For $i = 1, 2$, we can take a regular annulus A_i around γ and a regular annulus A'_i around γ' on X_i satisfying the following conditions:*

- (1) *Denote the inner boundary of A_i by C_i and the inner boundary of A'_i by C'_i , then $\ell_{X_i}(C_i) = \ell_{X_i}(C'_i) = \epsilon'_0$.*
- (2) *The inner boundaries C_i and C'_i are disjoint.*

Proof. Denote by $X = X_1$. As we showed in Section 2, by the Collar Lemma, there exist two disjoint regular annuli $A_{\eta(\ell_X(\gamma))}(\gamma)$ and $A_{\eta(\ell_X(\gamma'))}(\gamma')$. Let Δ_1 and Δ'_1 be the inner boundaries of $A_{\eta(\ell_X(\gamma))}(\gamma)$ and $A_{\eta(\ell_X(\gamma'))}(\gamma')$, respectively. By (6), the length of Δ_1 satisfies

$$\begin{aligned} \ell_X(\Delta_1) &= \ell_X(\gamma) \cosh(\eta(\ell_X(\gamma))) \\ &= \ell_X(\gamma) \frac{e^{\ell_X(\gamma)} + 1}{e^{\ell_X(\gamma)} - 1}. \end{aligned}$$

For $x > 0$, we consider the function

$$f_1(x) = x(e^x + 1)/(e^x - 1).$$

It's easy to see that $f'_1(x) > 0$ for all $x > 0$ and $\lim_{x \rightarrow 0} f_1(x) = 2$. It follows that $f_1(x) > 2$ for all $x > 0$. In particular, we have

$$\ell_X(\Delta_1) > 2 > \epsilon'_0.$$

As a result, we can choose a regular annulus $A_1 \subset A_{\eta(\ell_X(\gamma))}(\gamma)$ around γ with inner boundary C_1 such that $\ell_X(C_1) = \epsilon'_0$. By the same argument, we can choose C'_1 to be the inner boundary of a regular annulus that is contained in $A_{\eta(\ell_X(\gamma'))}(\gamma')$. Since $A_{\eta(\ell_X(\gamma))}(\gamma)$ and $A_{\eta(\ell_X(\gamma'))}(\gamma')$ are disjoint, C_1 and C'_1 are disjoint.

By the same argument, we can choose C_2 and C'_2 on X_2 that are contained in disjoint regular annuli. \square

It follows from Lemma 3.1 that C_1 and C'_1 separate β into three parts. Let $\beta_1^A = \beta \cap A_1$ and $\beta_1^{A'} = \beta \cap A'_1$ be the two terminal parts of β and $\beta_1^Q = \beta \setminus \{\beta_1^A \cup \beta_1^{A'}\}$ be the middle part of β . We use similar notations C_2 , C'_2 , β_2^A , $\beta_2^{A'}$ and β_2^Q for the hyperbolic structure X_2 . Figure 4 shows the above notations.

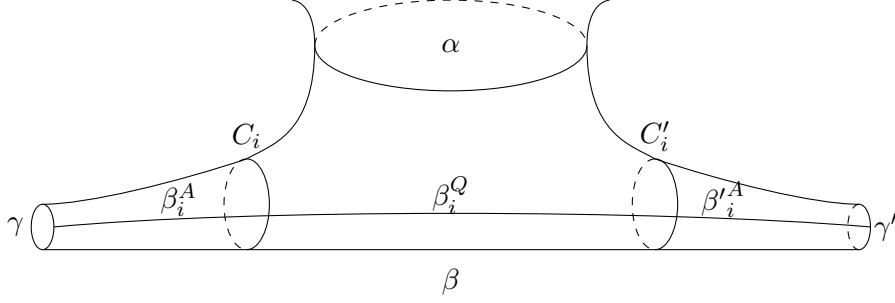

FIGURE 4. An illustration of a pair of pants on X_i where $\gamma \neq \gamma'$ and $\epsilon_0 < e^{-1} \ln(1 + \sqrt{2})$, for $i = 1, 2$.

The key point of our argument is to prove that there exists a positive constant K_1 depending on ϵ_0 such that

$$(7) \quad \frac{\ell_{X_1}(\beta)}{\ell_{X_2}(\beta)} \leq K_1 \cdot \max\left\{1, \frac{\ell_{X_1}(\alpha)}{\ell_{X_2}(\alpha)}, \frac{\ell_{X_2}(\gamma)}{\ell_{X_1}(\gamma)}, \frac{\ell_{X_2}(\gamma')}{\ell_{X_1}(\gamma')}\right\}.$$

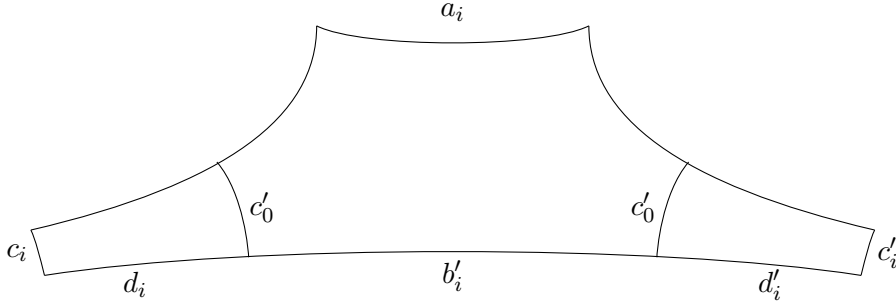

FIGURE 5. An example of the hexagon on X_i when $\gamma \neq \gamma'$ and $\epsilon_0 < e^{-1} \ln(1 + \sqrt{2})$, for $i = 1, 2$.

Let us explain more explicitly. As it is shown in Figure 5, by cutting the pair of pants along three geodesic arcs, each of which is perpendicular to a pair of boundary components, we have two right-angled hexagons. By symmetry, we only need to consider one of them.

For the sake of simplicity, we denote ℓ_{X_i} by ℓ_i , for $i = 1, 2$. Let $a_i = \ell_i(\alpha)/2$, $b_i = \ell_i(\beta)$, $c_i = \ell_i(\gamma)/2$, $c'_i = \ell_i(\gamma')/2$, $d_i = \ell_i(\beta_i^A)$, $d'_i = \ell_i(\beta_i^{A'})$, $b'_i = \ell_i(\beta_i^Q)$, for $i = 1, 2$. And let $c'_0 = c'_0/2$. Then $b_i = d_i + b'_i + d'_i$, for $i = 1, 2$.

With the above notations, we have

$$\frac{\ell_1(\beta)}{\ell_2(\beta)} = \frac{b_1}{b_2} = \frac{b'_1 + d_1 + d'_1}{b'_2 + d_2 + d'_2} \leq \max\left\{\frac{b'_1}{b'_2}, \frac{d_1}{d_2}, \frac{d'_1}{d'_2}\right\}.$$

To prove (7), it suffices to control b'_1/b'_2 , d_1/d_2 and d'_1/d'_2 by the ratios of the lengths of α, γ and γ' . This will be done in Lemma 3.3 and Lemma 3.6 below. As soon as Lemma 3.3 and Lemma 3.6 are proved, (7) is a direct corollary, see Proposition 3.8.

Example 3.2 (An exceptional case). If $S = S_{0,1,2}$, that is, the surface is homeomorphic to a pair of pants with one puncture and two boundary components, then $a_i = \ell_i(\alpha)/2 = 0$. In this case, the ratio $\frac{a_1}{a_2}$ in the following discussions would not make sense.

To avoid this difficulty, we can take two sequences of pairs of pants $(X_{1,n})_{n=1}^\infty, (X_{2,n})_{n=1}^\infty$ (we denote their boundary components by α, γ, γ' as above) such that

$$\ell_{X_{i,n}}(\gamma) = \ell_{X_i}(\gamma), \ell_{X_{i,n}}(\gamma') = \ell_{X_i}(\gamma'), \ell_{X_{i,n}}(\alpha) = \frac{1}{n}, \quad i = 1, 2.$$

Since the constants in the following lemmas are independent of n , by taking a limit as n goes to infinity, we will get the same results (all the following lemmas are true in such a special case if we set $\frac{0}{0} = 1$).

Note that the same argument applies to $S = S_{0,2,1}$, that is, the surface is homeomorphic to a pair of pants with two punctures and one boundary component, which we will consider in Section 3.2.

By Example 3.2, we can assume that $a_i > 0$, $i = 1, 2$. We first consider the ratio b'_1/b'_2 .

Lemma 3.3. *There exists a positive constant K'_1 depending on ϵ_0 such that*

$$(8) \quad \frac{b'_1}{b'_2} \leq K'_1 \cdot \max\left\{1, \frac{a_1}{a_2}\right\}.$$

Proof. The proof of this lemma will use Lemma 3.4 and Lemma 3.5 below.

Lemma 3.4. *There is a uniform positive lower bound for b'_i , $i = 1, 2$.*

Proof. Recall that the regular annulus $A_{\eta(\ell_1(\gamma))}(\gamma)$ contains C_1 and the length of the inner boundary of $A_{\eta(\ell_1(\gamma))}(\gamma)$ is greater than 2. We can take another regular annulus around γ which is isometrically embedded in $A_{\eta(\ell_1(\gamma))}(\gamma)$ and which has a inner boundary, denoted by \tilde{C}_1 , with length equal to 2. Denote by e_1 the distance between γ and \tilde{C}_1 . It can be seen from Figure 6 that $b'_1 \geq (e_1 - d_1) + (e'_1 - d'_1)$.

It suffices to give a lower bound for $e_1 - d_1$. By (6) and (5), we have

$$e_1 - d_1 = \ln \frac{1/c_1 + \sqrt{(1/c_1)^2 - 1}}{c'_0/c_1 + \sqrt{(c'_0/c_1)^2 - 1}},$$

where $c_1 < \frac{\ln(1+\sqrt{2})}{2e}$. Consider the function

$$f_2(y) = (y + \sqrt{y^2 - 1}) / (c'_0 y + \sqrt{c'^2_0 y^2 - 1}), \quad y > 2e / \ln(1 + \sqrt{2}).$$

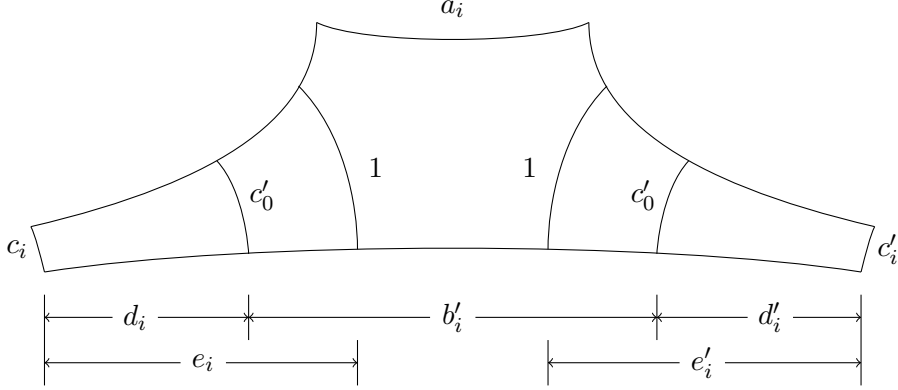
FIGURE 6. An example for e_i and e'_i , for $i = 1, 2$.

By the fact $f_2'(y) < 0$ and $y > 2e/\ln(1 + \sqrt{2})$, we have

$$e_1 - d_1 = f_2(1/c_1) \geq f_2(2e/\ln(1 + \sqrt{2})) = 4/\ln(1 + \sqrt{2}) > 0.$$

By the same argument we have $e'_1 - d'_1 \geq 4/\ln(1 + \sqrt{2})$. Let $M_0 = 8/\ln(1 + \sqrt{2})$, then we have (the same estimation for b'_2)

$$(9) \quad b'_i \geq M_0, \text{ for } i = 1, 2.$$

□

Next we will give an upper bound for the difference between a_i and b'_i , $i = 1, 2$.

Lemma 3.5. *There is a constant D_1 depending on ϵ_0 such that*

$$(10) \quad |a_i - b'_i| \leq D_1, \quad i = 1, 2.$$

Proof. The method used here is similar to that of [6].

Since $c_1 \leq \epsilon_0/2$ and $c'_1 \leq \epsilon_0/2$, there exists a constant k_1 depending on ϵ_0 such that

$$c_1 < \sinh c_1 < k_1 c_1 \text{ and } c'_1 < \sinh c'_1 < k_1 c'_1.$$

By (6), we have

$$c_1 \cosh d_1 = c'_1 \cosh d'_1 = c'_0 = \ln(1 + \sqrt{2})/2.$$

Then we have

$$\begin{aligned} & \sinh c_1 \cdot \sinh c'_1 \cdot \cosh(b'_1 + d_1 + d'_1) \\ & > c_1 \cdot c'_1 \cdot \frac{e^{b'_1 + d_1 + d'_1}}{2} = \frac{e^{b'_1}}{2} \cdot c_1 e^{d_1} \cdot c'_1 e^{d'_1} \\ & > \frac{e^{b'_1}}{2} \cdot c_1 \cosh d_1 \cdot c'_1 \cosh d'_1 = \frac{1}{2} c_0^2 e^{b'_1}, \end{aligned}$$

and

$$\begin{aligned} & \sinh c_1 \cdot \sinh c'_1 \cdot \cosh(b'_1 + d_1 + d'_1) \\ & < k_1 c_1 \cdot k_1 c'_1 \cdot e^{b'_1 + d_1 + d'_1} = 4 k_1^2 e^{b'_1} \cdot c_1 \frac{e^{d_1}}{2} \cdot c'_1 \frac{e^{d'_1}}{2} \\ & < 4 k_1^2 e^{b'_1} \cdot c_1 \cosh d_1 \cdot c'_1 \cosh d'_1 = 4 k_1^2 c_0^2 e^{b'_1}. \end{aligned}$$

Let $M_1 = \max\{2/c_0'^2, 4k_1^2 c_0'^2\}$. It follows that

$$M_1^{-1} e^{b_1'} \leq \sinh c_1 \cdot \sinh c_1' \cdot \cosh(b_1' + d_1 + d_1') \leq M_1 e^{b_1'}.$$

Combining the above inequality with (3), we have

$$\begin{aligned} e^{a_1} &\leq 2 \cosh a_1 < 2(\cosh a_1 + \cosh c_1 \cdot \cosh c_1') \\ &= 2 \cdot \sinh c_1 \cdot \sinh c_1' \cdot \cosh(b_1' + d_1 + d_1') \\ &\leq 2M_1 \cdot e^{b_1'}. \end{aligned}$$

On the other hand, we have

$$\begin{aligned} \cosh c_1 \cdot \cosh c_1' &< \cosh c_1 \cosh c_1' + \sinh c_1 \sinh c_1' \\ &= \cosh(c_1 + c_1') < \cosh\left(\frac{\epsilon_0}{2} + \frac{\epsilon_0}{2}\right) \\ &< \cosh \epsilon_0 \cdot \cosh a_1. \end{aligned}$$

Applying (3) again, we have

$$\begin{aligned} e^{a_1} &\geq \cosh a_1 = (1 + \cosh \epsilon_0)^{-1} (\cosh a_1 + \cosh \epsilon_0 \cosh a_1) \\ &> (1 + \cosh \epsilon_0)^{-1} (\cosh a_1 + \cosh c_1 \cdot \cosh c_1') \\ &= (1 + \cosh \epsilon_0)^{-1} \cdot \sinh c_1 \cdot \sinh c_1' \cdot \cosh(b_1' + d_1 + d_1') \\ &\geq (1 + \cosh \epsilon_0)^{-1} M_1^{-1} \cdot e^{b_1'}. \end{aligned}$$

In conclusion, we have

$$(1 + \cosh \epsilon_0)^{-1} M_1^{-1} \cdot e^{b_1'} \leq e^{a_1} \leq 2M_1 \cdot e^{b_1'}$$

or, equivalently,

$$(1 + \cosh \epsilon_0)^{-1} M_1^{-1} \leq e^{a_1 - b_1'} \leq 2M_1.$$

Setting $D_1 = \max\{|\ln(2M_1)|, |\ln(M_1 \cdot (1 + \cosh \epsilon_0))|\}$, then we have

$$|a_1 - b_1'| \leq D_1.$$

By the same proof we also have

$$|a_2 - b_2'| \leq D_1.$$

□

We continue with our proof of Lemma 3.3. Let $M > 2D_1$ be a sufficiently large positive number. The remaining discussion is separated into several different cases.

Case 1: $b_i' \geq M$, $i = 1, 2$.

In this case, using (10), we have (for $i = 1, 2$)

$$\frac{a_i}{b_i'} \leq \frac{b_i' + D_1}{b_i'} < 1 + \frac{D_1}{M} < \frac{3}{2}$$

and

$$\frac{a_i}{b_i'} \geq \frac{b_i' - D_1}{b_i'} > 1 - \frac{D_1}{M} > \frac{1}{2}$$

That is

$$\frac{1}{2} \leq \frac{a_i}{b'_i} \leq \frac{3}{2}.$$

It follows that

$$\frac{b'_1}{b'_2} \leq 3 \cdot \frac{a_1}{a_2}.$$

Case 2: $b'_i \leq M$ and $a_i > \epsilon_0, i = 1, 2$.

Combing with (9) and (10), we have $M_0 \leq b'_i \leq M$ and $\epsilon_0 \leq a_i \leq b'_i + D_1 \leq M + D_1$. It follows that

$$\frac{2M_0}{3M} < \frac{M_0}{M + D_1} \leq \frac{b'_i}{a_i} \leq \frac{M}{\epsilon_0}.$$

In this case

$$\frac{b'_1}{b'_2} \leq \frac{M}{\epsilon_0} \cdot \frac{3M}{2M_0} \cdot \frac{a_1}{a_2}.$$

Case 3: $b'_1 > M$ and $b'_2 \leq M, a_2 > \epsilon_0$.

It follows from the estimations in Case 1 and Case 2 that

$$\frac{b'_1}{b'_2} \leq \frac{3M}{M_0} \cdot \frac{a_1}{a_2}.$$

Case 4: $b'_2 > M$ and $b'_1 \leq M, a_1 > \epsilon_0$.

In this case, we have the same conclusion as in Case 3.

Case 5: $b'_1 > M$ and $b'_2 \leq M, a_2 \leq \epsilon_0$.

By (9), we have

$$\frac{b'_1}{b'_2} \leq \frac{b'_1}{M_0} \leq \frac{2 \cdot a_1}{M_0} = \frac{2 \cdot a_2}{M_0} \cdot \frac{a_1}{a_2} \leq \frac{2 \cdot \epsilon_0}{M_0} \cdot \frac{a_1}{a_2}.$$

Case 6: $b'_1 \leq M, a_1 > \epsilon_0$ and $b'_2 \leq M, a_2 \leq \epsilon_0$.

By (9), we have

$$\frac{b'_1}{b'_2} \leq \frac{b'_1}{M_0} \leq \frac{M \cdot a_1}{\epsilon_0 M_0} = \frac{M \cdot a_2}{\epsilon_0 M_0} \cdot \frac{a_1}{a_2} \leq \frac{M \cdot \epsilon_0}{\epsilon_0 M_0} \cdot \frac{a_1}{a_2} = \frac{a_1}{a_2}.$$

Case 7: $b'_1 \leq M, a_1 \leq \epsilon_0$ and $b'_2 \leq M, a_2 \leq \epsilon_0$.

By (9), we have

$$\frac{b'_1}{b'_2} \leq \frac{M}{M_0}.$$

In this case, it is obvious that

$$\frac{b'_1}{b'_2} \leq \frac{M}{M_0} \cdot \max\{1, \frac{a_1}{a_2}\}.$$

The other two remaining cases, that is, $b'_2 > M, b'_1 \leq M, a_1 \leq \epsilon_0$ and $b'_2 \leq M, a_2 > \epsilon_0, b'_1 \leq M, a_1 \leq \epsilon_0$, can be reduced to Case 5 and Case 6. By choosing $K'_1 = \max\{3, \frac{3M^2}{2M_0\epsilon_0}, \frac{3M}{M_0}, \frac{2\epsilon_0}{M_0}\}$, we complete the proof of Lemma 3.3. \square

Next we will consider the ratio d_1/d_2 .

Lemma 3.6. *The ratio d_1/d_2 has an upper bound given by*

$$(11) \quad \frac{d_1}{d_2} \leq 2 \cdot \max\{1, \frac{c_2}{c_1}\}.$$

Proof. As $c'_0 = (\ln(1 + \sqrt{2}))/2$ and $\epsilon_0 < e^{-1} \ln(1 + \sqrt{2})$, we have

$$c'_0/c_1 \geq \epsilon'_0/\epsilon_0 > e > 1.$$

By (6), we have

$$c_1 \cosh d_1 = c'_0.$$

By (5), we have

$$d_1 = \operatorname{arcosh}(c'_0/c_1) = \ln(c'_0/c_1 + \sqrt{(c'_0/c_1)^2 - 1}).$$

Note that for any $x > e$, $\ln(2x) \leq 2 \ln x$. Since $\sqrt{(c'_0/c_1)^2 - 1} \leq c'_0/c_1$ and $c'_0/c_1 > e$, we have

$$d_1 = \ln(c'_0/c_1 + \sqrt{(c'_0/c_1)^2 - 1}) \leq \ln(2c'_0/c_1) \leq 2 \cdot \ln(c'_0/c_1).$$

Since $d_1 = \ln(c'_0/c_1 + \sqrt{(c'_0/c_1)^2 - 1}) \geq \ln(c'_0/c_1)$, we have

$$\ln c'_0 - \ln c_1 \leq d_1 \leq 2 \cdot (\ln c'_0 - \ln c_1).$$

The same discussion implies

$$\ln c'_0 - \ln c_2 \leq d_2 \leq 2 \cdot (\ln c'_0 - \ln c_2).$$

As a result, we have

$$\frac{d_1}{d_2} \leq 2 \cdot \frac{\ln c'_0 - \ln c_1}{\ln c'_0 - \ln c_2}.$$

If $c_2 \leq c_1$, we have

$$\frac{\ln c'_0 - \ln c_1}{\ln c'_0 - \ln c_2} \leq 1.$$

Now suppose that $c_2 > c_1$. Let $f_3(x) = x^{-1} \ln x$. Then $f'_3(x) = (1 - \ln x)/x^2$. We know that $f'_3(x) \leq 0$ as $x \geq e$. Since $\frac{c'_0}{c_i} \geq e, i = 1, 2$, and $\frac{c'_0}{c_1} > \frac{c'_0}{c_2}$. It follows that $f_3(\frac{c'_0}{c_1}) < f_3(\frac{c'_0}{c_2})$. This implies

$$\frac{\ln c'_0 - \ln c_1}{\ln c'_0 - \ln c_2} \leq \frac{c_2}{c_1}.$$

The above discussions lead to the following inequality:

$$\frac{d_1}{d_2} \leq 2 \cdot \max\{1, \frac{c_2}{c_1}\}.$$

□

By the same discussion as above, we have

Lemma 3.7. *The ratio d'_1/d'_2 has an upper bound given by*

$$(12) \quad \frac{d'_1}{d'_2} \leq 2 \cdot \max\{1, \frac{c'_2}{c'_1}\}.$$

Proposition 3.8. *Let $\epsilon_0 < e^{-1} \ln(1 + \sqrt{2})$. For any essential arc $\beta \in \mathcal{B}(S)$ whose endpoints lie on different boundary components γ and γ' of S , let α be the associated simple closed curve homotopic to the boundary of a regular neighborhood of $\beta \cup \gamma \cup \gamma'$. Then there exists a positive number K_1 depending on ϵ_0 such that inequality (7) holds for any X_1, X_2 in the ϵ_0 -relative part of $\mathcal{T}(S)$.*

Proof. We apply the results of Lemma 3.3 and Lemma 3.6 and the notations in their proof. It follows that the ratio of $\ell_1(\beta)$ and $\ell_2(\beta)$ satisfies

$$\begin{aligned} \frac{\ell_1(\beta)}{\ell_2(\beta)} &\leq \max\{\frac{b'_1}{b'_2}, \frac{d_1}{d_2}, \frac{d'_1}{d'_2}\} \\ &\leq \max\{K'_1 \cdot \max\{1, \frac{a_1}{a_2}\}, 2 \cdot \max\{1, \frac{c_2}{c_1}\}, 2 \cdot \max\{1, \frac{c'_2}{c'_1}\}\} \\ &\leq K_1 \cdot \max\{1, \frac{a_1}{a_2}, \frac{c_2}{c_1}, \frac{c'_2}{c'_1}\} \\ &= K_1 \cdot \max\{1, \frac{\ell_1(\alpha)}{\ell_2(\alpha)}, \frac{\ell_2(\gamma)}{\ell_1(\gamma)}, \frac{\ell_2(\gamma')}{\ell_1(\gamma')}\}, \end{aligned}$$

where $K_1 = \max\{K'_1, 2\}$ only depend on ϵ_0 . □

3.2. The case where $\gamma = \gamma'$.

Now we consider the case where $\gamma = \gamma'$. In this case, we denote by γ the boundary component of S where the two endpoints of β lie.

Consider a regular neighborhood of $\beta \cup \gamma$. It is homotopic to a pair of pants whose boundary components consist of γ and two other simple closed curves, denoted by α and α' .

We will prove an analogue of inequality (7), that is, there exists a positive constant K_2 depending on ϵ_0 such that

$$(13) \quad \frac{\ell_{X_1}(\beta)}{\ell_{X_2}(\beta)} \leq K_2 \cdot \max\{1, \frac{\ell_{X_1}(\alpha)}{\ell_{X_2}(\alpha)}, \frac{\ell_{X_1}(\alpha')}{\ell_{X_2}(\alpha')}, \frac{\ell_{X_2}(\gamma)}{\ell_{X_1}(\gamma)}\}.$$

Remark 3.9. By Example 3.2, we can assume that one of the curves γ and γ' is not homotopic to a puncture. Without loss of generality, we may suppose that $\ell_{X_1}(\alpha) \geq \ell_{X_1}(\alpha')$. Note that α' maybe homotopic to a puncture. In this case, we shall identify a puncture with a simple closed geodesic with length zero and let $\frac{0}{0} = 1$.

For X_i , $i = 1, 2$, let C_i be the inner boundary of the regular annulus around γ with length $\ell_{X_i}(C_i) = \epsilon'_0$ (the existence of such a regular annulus is given by Lemma 3.1). Then C_i separates β into three parts β_i^A , β_i^Q and β_i^A , for $i = 1, 2$. See Figure 7.

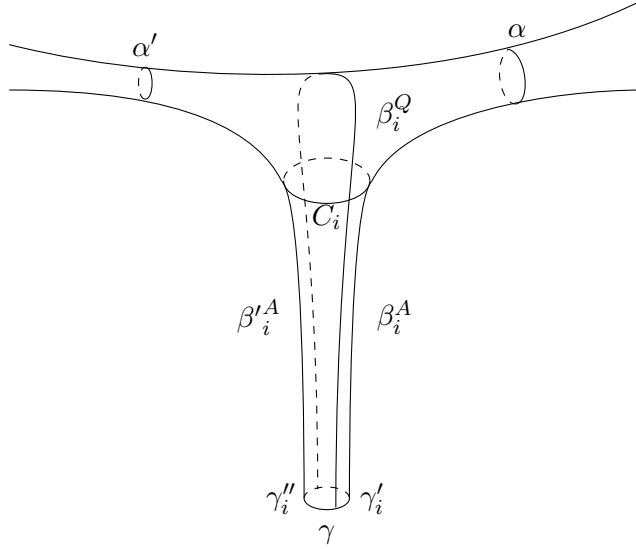

FIGURE 7. An example of the pair of pants when $\gamma = \gamma'$ and $\epsilon_0 < e^{-1} \ln(1 + \sqrt{2})$, for $i = 1, 2$.

One can see from Figure 7 that the endpoints of β separate the geodesic γ into two parts, denoted by γ'_i and γ''_i . Note that $\gamma'_i \cup \beta$ (resp. $\gamma''_i \cup \beta$) is isotopic to α (resp. α'), for $i = 1, 2$.

By cutting each pair of pants along the three perpendicular geodesic arcs connecting the boundary components, we have two symmetric right-angled hexagons on X_i , for $i = 1, 2$. We consider one of them for $i = 1, 2$, as we shown in Figure 8. To simplify notation, we denote ℓ_{X_i} by l_i and let $c'_0 = \epsilon'_0/2$, $b_i = l_i(\beta_i^Q)/2$, $d_i = l_i(\beta_i^A) = l_i(\beta_i^A)$, $a_i = l_i(\alpha)/2$, $a'_i = l_i(\alpha')/2$, $c'_i = l_i(\gamma'_i)/2$ and $c''_i = l_i(\gamma''_i)/2$, for $i = 1, 2$. See Figure 8. Since $l_i(\alpha) \geq l_i(\alpha')$, we have $a_i \geq a'_i$, for $i = 1, 2$.

It's easy to show that the ratio of $l_1(\beta)$ and $l_2(\beta)$ satisfies

$$(14) \quad \frac{l_1(\beta)}{l_2(\beta)} = \frac{2(b_1 + d_1)}{2(b_2 + d_2)} \leq \max\left\{\frac{b_1}{b_2}, \frac{d_1}{d_2}\right\}.$$

As in the case where $\gamma \neq \gamma'$, we will control b_1/b_2 and d_1/d_2 by the ratios of lengths of α and γ . We will prove these results in Lemma 3.10 and Lemma 3.11.

We first discuss the b_1/b_2 part.

Lemma 3.10. *There exists a positive constant K'_2 depending on ϵ_0 such that*

$$(15) \quad \frac{b_1}{b_2} \leq K'_2 \cdot \max\left\{1, \frac{l_1(\alpha)}{l_2(\alpha)}\right\}.$$

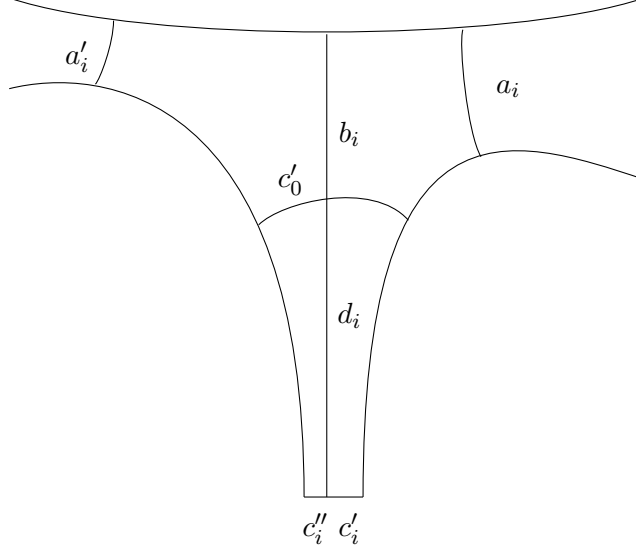

FIGURE 8. An example of the hexagon on X_i when $\gamma = \gamma'$ and $\epsilon_0 < e^{-1} \ln(1 + \sqrt{2})$, for $i = 1, 2$.

Proof. We follow the same outline as in the proof of Lemma 3.3. By our assumption (see Remark 3.9), $\ell_{X_1}(\alpha) \geq \ell_{X_1}(\alpha')$. Let us first consider the case where $\ell_{X_2}(\alpha) \geq \ell_{X_2}(\alpha')$.

As β_i^Q , $i = 1, 2$, can be viewed as the middle part of β , by the same proof as that of (9) in Lemma 3.4, we have

$$(16) \quad b_i \geq \frac{M_0}{2}, \text{ for } i = 1, 2.$$

Next we discuss the relation between c'_i and $\ell_i(\gamma)$, for $i = 1, 2$. It is obvious that $c'_1 < \ell_1(\gamma)/2$.

By (2), we have

$$\cosh a_1 / \sinh c'_1 = \sinh(b_1 + d_1) = \cosh a'_1 / \sinh c''_1.$$

Since (by assumption) $a_1 \geq a'_1$, we have

$$\sinh c'_1 / \sinh c''_1 = \cosh a_1 / \cosh a'_1 \geq 1.$$

Therefore $c'_1 \geq c''_1$. Since $2(c'_1 + c''_1) = \ell_1(\gamma)$, we have $c'_1 \geq \ell_1(\gamma)/4$. We have similar result for c'_2 .

It follows that

$$(17) \quad \frac{1}{4} \ell_i(\gamma) \leq c'_i < \frac{1}{2} \ell_i(\gamma), \text{ for } i = 1, 2.$$

Since c'_i , $i = 1, 2$ are bounded above by $\frac{\epsilon_0}{2}$, there is a positive constant k_2 depending on ϵ_0 such that

$$(18) \quad c'_i \leq \sinh c'_i \leq k_2 \cdot c'_i, \text{ for } i = 1, 2.$$

Since $b_i + d_i$, $i = 1, 2$ are bounded by M_0 from below, we can choose k_2 such that

$$(19) \quad k_2^{-1} \cdot e^{b_i+d_i} \leq \sinh(b_i + d_i) \leq \frac{1}{2} \cdot e^{b_i+d_i}, \text{ for } i = 1, 2.$$

Similar to the case where $\gamma \neq \gamma'$, we can estimate the difference between a_i and b_i , $i = 1, 2$.

By (2), (17), (18), (19) and the fact that $\ell_i(\gamma) \cdot \cosh d_i = \epsilon'_0$, $i = 1, 2$, we have (for $i = 1, 2$)

$$\begin{aligned} e^{a_i} &\geq \cosh a_i = \sinh(b_i + d_i) \cdot \sinh c'_i \\ &\geq k_2^{-1} \cdot e^{b_i + d_i} \cdot c'_i \geq k_2^{-1} e^{b_i} \cdot \cosh d_i \cdot \frac{1}{4} \ell_i(\gamma) \\ &= \frac{k_2^{-1} \epsilon'_0}{4} \cdot e^{b_i} \end{aligned}$$

and

$$\begin{aligned} e^{a_i} &\leq 2 \cosh a_i = 2 \sinh(b_i + d_i) \cdot \sinh c'_i \\ &\leq e^{b_i + d_i} \cdot k_2 \cdot c'_i < k_2 e^{b_i} \cdot 2 \cosh d_i \cdot \frac{1}{2} \ell_i(\gamma) \\ &= k_2 \epsilon'_0 \cdot e^{b_i}. \end{aligned}$$

Let $D_2 = \max\{|\ln(k_2^{-1} \epsilon'_0) - \ln 4|, |\ln(k_2 \epsilon'_0)|\}$. We have

$$(20) \quad |b_i - a_i| \leq D_2, \quad i = 1, 2.$$

Now we have inequalities (16) and (20), the analogy of (9) and (10) previously. By the same proof as in Lemma 3.3 (see the discussion after Lemma 3.5), we can show that there is a constant K'_2 depending on ϵ_0 such that

$$\frac{b_1}{b_2} \leq K'_2 \cdot \max\{1, \frac{a_1}{a_2}\}.$$

Since $\frac{a_1}{a_2} = \frac{\ell_1(\alpha)}{\ell_2(\alpha)}$, we finish the proof under the assumption that $\ell_{X_2}(\alpha) \geq \ell_{X_2}(\alpha')$.

If $\ell_{X_2}(\alpha) < \ell_{X_2}(\alpha')$, then we can modify the above argument to show that

$$\frac{b_1}{b_2} \leq K'_2 \cdot \max\{1, \frac{\ell_1(\alpha)}{\ell_2(\alpha')}\}.$$

Since $\frac{\ell_1(\alpha)}{\ell_2(\alpha')} \leq \frac{\ell_1(\alpha)}{\ell_2(\alpha)}$, the inequality (15) remains true. \square

Next we will discuss the d_1/d_2 part.

Lemma 3.11. *We have*

$$(21) \quad \frac{d_1}{d_2} \leq 2 \cdot \max\{1, \frac{\ell_2(\gamma)}{\ell_1(\gamma)}\}.$$

Proof. The proof is the same as that of Lemma 3.6. We have

$$\ln \epsilon'_0 - \ln \ell_i(\gamma) \leq d_i \leq 2(\ln \epsilon'_0 - \ln \ell_i(\gamma)), \quad i = 1, 2.$$

Then

$$\frac{d_1}{d_2} \leq 2 \cdot \frac{\ln \epsilon'_0 - \ln \ell_1(\gamma)}{\ln \epsilon'_0 - \ln \ell_2(\gamma)}.$$

As we did in the case where $\gamma \neq \gamma'$, we consider the two cases depending on whether $\ell_2(\gamma) \leq \ell_1(\gamma)$ or not.

If $\ell_2(\gamma) \leq \ell_1(\gamma)$, we have

$$(\ln \epsilon'_0 - \ln \ell_1(\gamma)) / (\ln \epsilon'_0 - \ln \ell_2(\gamma)) \leq 1.$$

If $\ell_2(\gamma) > \ell_1(\gamma)$, by the same proof as that of Lemma 3.6, we have

$$(\ln \epsilon'_0 - \ln \ell_1(\gamma)) / (\ln \epsilon'_0 - \ln \ell_2(\gamma)) \leq \ell_2(\gamma) / \ell_1(\gamma).$$

From the above discussions, we have

$$\frac{d_1}{d_2} \leq 2 \cdot \max\left\{1, \frac{\ell_2(\gamma)}{\ell_1(\gamma)}\right\}.$$

□

Proposition 3.12. *Let ϵ_0 be a positive number with $\epsilon_0 < e^{-1} \ln(1 + \sqrt{2})$ and let X_1, X_2 be any two hyperbolic metrics in the ϵ_0 -relative part of $\mathcal{T}(S)$. For any essential arc $\beta \in \mathcal{B}(S)$ with endpoints lying on the same boundary component γ of S , let α and α' be the associated simple closed curves homotopic the boundaries of a regular neighborhood of $\beta \cup \gamma$. Then there exists a positive constant K_2 depending on ϵ_0 such that the inequality (13) holds.*

Proof. By (14), (15) and (21), we have (with the assumption that $\ell_{X_1}(\alpha) \geq \ell_{X_1}(\alpha')$)

$$\begin{aligned} \frac{\ell_1(\beta)}{\ell_2(\beta)} &\leq \max\left\{\frac{b_1}{b_2}, \frac{d_1}{d_2}\right\} \\ &\leq \max\left\{K'_2 \cdot \max\left\{1, \frac{\ell_1(\alpha_1)}{\ell_2(\alpha)}\right\}, 2 \cdot \max\left\{1, \frac{\ell_2(\gamma)}{\ell_1(\gamma)}\right\}\right\} \\ &\leq K_2 \cdot \max\left\{1, \frac{\ell_1(\alpha)}{\ell_2(\alpha)}, \frac{\ell_2(\gamma)}{\ell_1(\gamma)}\right\}, \end{aligned}$$

where $K_2 = \max\{K'_2, 2\}$ is a positive constant depending on ϵ_0 . □

3.3. Corollary. By Proposition 3.8 and Proposition 3.12, we have the following corollary.

Corollary 3.13. *Let ϵ_0 be a positive number with $\epsilon_0 < e^{-1} \ln(1 + \sqrt{2})$. There exists a positive constant K depending on ϵ_0 such that*

$$\sup_{\beta \in \mathcal{B}(S)} \left\{ \frac{\ell_{X_1}(\beta)}{\ell_{X_2}(\beta)}, \frac{\ell_{X_2}(\beta)}{\ell_{X_1}(\beta)} \right\} \leq K \cdot \sup_{\alpha \in \mathcal{C}(S)} \left\{ \frac{\ell_{X_1}(\alpha)}{\ell_{X_2}(\alpha)}, \frac{\ell_{X_2}(\alpha)}{\ell_{X_1}(\alpha)} \right\},$$

for any X_1, X_2 on the ϵ_0 -relative part of $\mathcal{T}(S)$.

4. PROOF OF THEOREM 1.6: THE GENERAL CASE

We have shown in Section 3 that the supremum of the ratio of lengths of arcs is controlled by that of simple closed curves in the case where $\epsilon_0 < e^{-1} \ln(1 + \sqrt{2})$. In this section, we will prove the result in the general case. We assume that $\epsilon_0 \geq e^{-1} \ln(1 + \sqrt{2})$.

Here is the idea of the proof. Recall that in Section 3, we separated the arc β into several parts. In the case where $\epsilon_0 < e^{-1} \ln(1 + \sqrt{2})$, the length of β_i^Q is bounded below by a positive number and $\ell_{X_1}(\beta_1^Q) / \ell_{X_2}(\beta_2^Q)$ is controlled by the ratio of the lengths of some corresponding simple closed curves. But in the case where $\epsilon_0 \geq e^{-1} \ln(1 + \sqrt{2})$, in general, it's impossible to give a

lower bound for $\ell_{X_2}(\beta_2^Q)$. To deal with this, we will not separate the arc β into parts unless the width of collar neighborhood of γ or γ' is large enough.

Let $\epsilon'_0 = \ln(1 + \sqrt{2})$. Let X_1 and X_2 be in the ϵ_0 -relative part of $\mathcal{T}(S)$. We apply the same notations β, γ, γ' and α as in Section 3.

4.1. The case where $\gamma \neq \gamma'$. First we will consider the case where $\gamma \neq \gamma'$. We define C_i and $C'_i, i = 1, 2$, as follows.

If $\ell_{X_1}(\gamma) < e^{-1} \ln(1 + \sqrt{2})$, let C_1 be a closed curve isotopic to γ with $\ell_{X_1}(C_1) = \epsilon'_0$ such that C_1 and γ are the boundaries of a regular annulus around γ on X_1 . Otherwise, we let $C_1 = \gamma$. Similarly, we can define C'_1 . The corresponding notations on X_2 are obtained only by replacing subscript.

We have four cases according to whether $\ell_{X_i}(\gamma)$ or $\ell_{X_i}(\gamma'), i = 1, 2$, is less than $e^{-1} \ln(1 + \sqrt{2})$ or not. Figure 9 shows how to choose C_i and C'_i in each case, for $i = 1, 2$.

Again, to simplify notation, we denote $\ell_i = \ell_{X_i}$, for $i = 1, 2$. Let $a_i = \ell_i(\alpha)/2, b_i = \ell_i(\beta)/2, c_i = \ell_i(\gamma)/2, c'_i = \ell_i(\gamma')/2, d_i = \ell_i(\beta_i^A), d'_i = \ell_i(\beta_i^A), b'_i = \ell_i(\beta_i^Q), e_i = \ell_i(C_i)/2, e'_i = \ell_i(C'_i)/2$ and $c'_0 = \epsilon'_0/2$, for $i = 1, 2$. It should be noted that $d_i = 0$ and $e_i = c_i$ if $\ell_i(\gamma) \geq e^{-1} \ln(1 + \sqrt{2})$.

With the above notations, let us describe Figure 9 in more details:

Case (a): $\ell_i(\gamma) < e^{-1} \ln(1 + \sqrt{2})$ and $\ell_i(\gamma') < e^{-1} \ln(1 + \sqrt{2}), i = 1, 2$.

In this case, $e_i = e'_i = c'_0, i = 1, 2$. This implies that d_i and $d'_i, i = 1, 2$ are positive.

Case (b): $\ell_i(\gamma) \geq e^{-1} \ln(1 + \sqrt{2})$ and $\ell_i(\gamma') < e^{-1} \ln(1 + \sqrt{2}), i = 1, 2$.

In this case, $e_i = c_i$ and $e'_i = c'_0, i = 1, 2$. This implies that $d_i = 0$ and $d'_i > 0, i = 1, 2$.

Case (c): $\ell_i(\gamma) < e^{-1} \ln(1 + \sqrt{2})$ and $\ell_i(\gamma') \geq e^{-1} \ln(1 + \sqrt{2}), i = 1, 2$.

Similar to Case (b), $e_i = c'_0$ and $e'_i = c'_i, i = 1, 2$. This implies that $d_i > 0$ and $d'_i = 0, i = 1, 2$.

Case (d): $\ell_i(\gamma) \geq e^{-1} \ln(1 + \sqrt{2})$ and $\ell_i(\gamma') \geq e^{-1} \ln(1 + \sqrt{2}), i = 1, 2$.

In this case, we have $e_i = c_i, e'_i = c'_i$ and $d_i = d'_i = 0, i = 1, 2$.

These four cases are shown in Figure 9. The ratio of the lengths of β on X_1 and X_2 satisfies the following

$$\frac{\ell_1(\beta)}{\ell_2(\beta)} = \frac{b_1}{b_2} = \frac{b'_1 + d_1 + d'_1}{b'_2 + d_2 + d'_2} \leq 3 \cdot \max\left\{\frac{b'_1}{b'_2}, \frac{d_1}{b'_2 + d_2}, \frac{d'_1}{b'_2 + d'_2}\right\}.$$

We will study each part on the right hand side of the above inequality.

Lemma 4.1. *There exists a positive constant K'_3 depending on ϵ_0 such that*

$$(22) \quad \frac{b'_1}{b'_2} \leq K'_3 \cdot \max\left\{1, \frac{a_1}{a_2}\right\}.$$

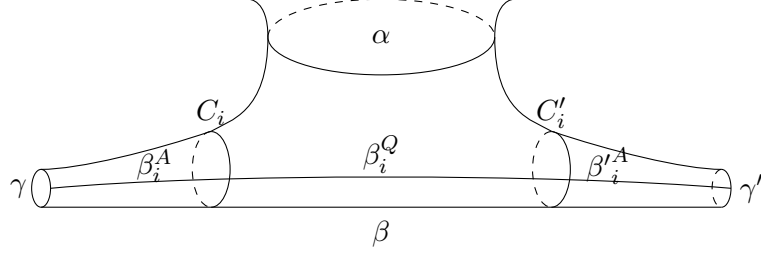
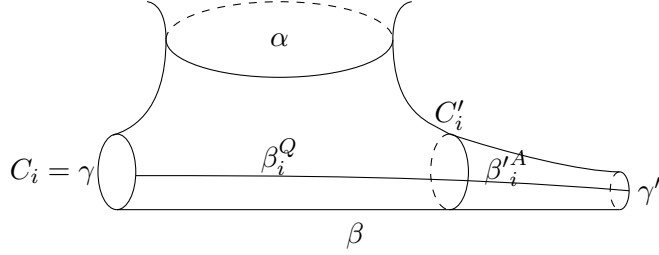
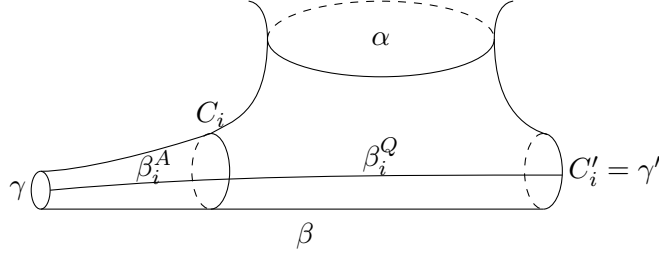
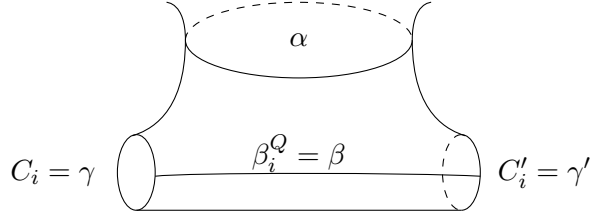
(a) Case $l_i(\gamma) < e^{-1} \ln(1 + \sqrt{2})$ and $l_i(\gamma') < e^{-1} \ln(1 + \sqrt{2})$ (b) Case $l_i(\gamma) \geq e^{-1} \ln(1 + \sqrt{2})$ and $l_i(\gamma') < e^{-1} \ln(1 + \sqrt{2})$ (c) Case $l_i(\gamma) < e^{-1} \ln(1 + \sqrt{2})$ and $l_i(\gamma') \geq e^{-1} \ln(1 + \sqrt{2})$ (d) Case $l_i(\gamma) \geq e^{-1} \ln(1 + \sqrt{2})$ and $l_i(\gamma') \geq e^{-1} \ln(1 + \sqrt{2})$ FIGURE 9. Examples of pair of pants on X_i when $\gamma \neq \gamma'$ and $\epsilon_0 \geq e^{-1} \ln(1 + \sqrt{2})$, for $i = 1, 2$.

Proof. We first show that there exists a positive lower bound (that may depend on ϵ_0) for b'_i , for $i = 1, 2$. Consider b'_1 . We have to consider all four cases as illustrated in Figure 9.

In Case (a), by (9), we have $b'_1 \geq 8/\ln(1 + \sqrt{2})$.

In Case (b) or Case (c), the proof of (9) shown that $b'_1 \geq 4/\ln(1 + \sqrt{2})$.

In Case (d), $C = \gamma$ and $C' = \gamma'$. By (3), we have

$$\cosh a_1 + \cosh c_1 \cosh c'_1 = \sinh c_1 \sinh c'_1 \cosh b'_1.$$

Since $c_1 \leq \epsilon_0/2$ and $c'_1 \leq \epsilon_0/2$, we have a lower bound for $\cosh b'_1$:

$$\begin{aligned} \cosh b'_1 &= \frac{\cosh a_1 + \cosh c_1 \cosh c'_1}{\sinh c_1 \sinh c'_1} \\ &= \frac{\cosh a_1}{\sinh c_1 \sinh c'_1} + \coth c_1 \coth c'_1 \geq (\sinh \frac{\epsilon_0}{2})^{-2} + 1. \end{aligned}$$

It follows that $b'_1 \geq \operatorname{arcosh}((\sinh(\epsilon_0/2))^{-2} + 1)$. Using the same argument we have that $b'_2 \geq \operatorname{arcosh}((\sinh(\epsilon_0/2))^{-2} + 1)$. Let

$$M' = \min\{4/\ln(1 + \sqrt{2}), \operatorname{arcosh}((\sinh(\epsilon_0/2))^{-2} + 1)\},$$

then we have

$$(23) \quad b'_i \geq M', \text{ for } i = 1, 2.$$

Now we claim that the difference between a_i and b'_i is bounded from above in all the above four cases, for $i = 1, 2$. We only give the discussion on X_1 . The discussion on X_2 is the same.

Case (a) is handled by inequality (10).

In Case (b) or Case (c), it is sufficient to consider Case (b). The discussion of Case (c) works in the same way. As $\ell_1(\gamma) \geq e^{-1} \ln(1 + \sqrt{2})$ and $d_1 = 0$, we have

$$\begin{aligned} \sinh c_1 \sinh c'_1 \cosh(b'_1 + d_1 + d'_1) &> \frac{1}{2} \cdot c_1 \cdot c'_1 \cosh d'_1 \cdot e^{b'_1} = \frac{1}{2} \cdot \frac{\ell_1(\gamma)}{2} \cdot c'_0 \cdot e^{b'_1} \\ &\geq \frac{(\ln(1 + \sqrt{2}))^2}{8e} \cdot e^{b'_1}. \end{aligned}$$

As $c_1 < \epsilon_0/2$, $c'_1 < \epsilon_0/2$, we have a positive constant k_1 (depending on ϵ_0) that satisfies $\sinh c_1 \leq k_1 \cdot c_1$ and $\sinh c'_1 \leq k_1 \cdot c'_1$. Then we have

$$\begin{aligned} \sinh c_1 \sinh c'_1 \cosh(b'_1 + d_1 + d'_1) &< k_1^2 \cdot c_1 \cdot c'_1 \cosh d'_1 \cdot e^{b'_1} \\ &\leq \frac{\epsilon_0 k_1^2 \ln(1 + \sqrt{2})}{4e} \cdot e^{b'_1}. \end{aligned}$$

Let $M_1 = \max\{8e/(\ln(1 + \sqrt{2}))^2, \epsilon_0 k_1^2 \ln(1 + \sqrt{2})/(4e)\}$. Then we have proved that

$$M_1^{-1} e^{b'_1} \leq \sinh c_1 \sinh c'_1 \cosh(b'_1 + d_1 + d'_1) \leq M_1 e^{b'_1}.$$

Similarly to the proof of inequality (10), we can show that there exists a positive constant D_2 depending on ϵ_0 such that $|a_1 - b'_1| \leq D_2$.

In Case (d), the assumption of this case implies that $d_1 = 0$ and $d'_1 = 0$. It follows that

$$\sinh c_1 \sinh c'_1 \cosh(b'_1 + d_1 + d'_1) > \frac{c_1 c'_1}{2} \cdot e^{b'_1} \geq \frac{(\ln(1 + \sqrt{2}))^2}{8e^2} \cdot e^{b'_1}$$

and

$$\sinh c_1 \sinh c'_1 \cosh(b'_1 + d_1 + d'_1) < K_1^2 c_1 c'_1 e^{b'_1} \leq \frac{K_1^2 \epsilon_0^2}{4} e^{b'_1}.$$

Let $M_1 = \max\{8e^2/(\ln(1 + \sqrt{2}))^2, K_1^2 \epsilon_0^2/4\}$. Again, similarly to the proof of inequality (10), we can prove that $|a_1 - b'_1| \leq D_3$, where the constant D_3 depends on ϵ_0 .

The same proof applies to $|a_2 - b'_2|$. Then we have a positive constant D depending on ϵ_0 such that

$$(24) \quad |a_i - b'_i| \leq D, i = 1, 2.$$

Comparing (23) and (24) with (9) and (10) in the proof of Lemma 3.3, we finish the proof. \square

Next we will consider the $d_1/(b'_2 + d_2)$ part.

Lemma 4.2. *There exists a positive constant K_3'' depending on ϵ_0 such that*

$$(25) \quad \frac{d_1}{b'_2 + d_2} \leq K_3'' \cdot \max\{1, \frac{c_2}{c_1}\}.$$

Proof. By (6), we have

$$\ell_i(\gamma) \cdot \cosh d_i = \ell_i(C_i), \quad i = 1, 2.$$

Similarly,

$$\ell_i(\gamma') \cdot \cosh d'_i = \ell_i(C'_i), \quad i = 1, 2.$$

We consider the two cases depending on whether $\ell_1(\gamma) < e^{-1} \ln(1 + \sqrt{2})$ or not.

Case 1: $\ell_1(\gamma) < e^{-1} \ln(1 + \sqrt{2})$.

By assumption, we have $\ell_1(C_1) = \ln(1 + \sqrt{2})$. As in the proof of Lemma 3.6, we have

$$(26) \quad \ln \ell_1(C_1) - \ln \ell_1(\gamma) \leq d_1 \leq 2(\ln \ell_1(C_1) - \ln \ell_1(\gamma)).$$

If $\ell_2(\gamma) < e^{-1} \ln(1 + \sqrt{2})$, the lemma follows from Lemma 3.6. If $\ell_2(\gamma) \geq e^{-1} \ln(1 + \sqrt{2})$, then $d_2 = 0$. By (26), we have

$$\begin{aligned} \frac{d_1}{b'_2 + d_2} &\leq \frac{d_1}{M'} \leq \frac{2}{M'} \cdot \ln \frac{\ell_1(C_1)}{\ell_1(\gamma)} \leq \frac{2}{M'} \cdot \frac{\ell_1(C_1)}{\ell_1(\gamma)} \\ &\leq \frac{2 \ln(1 + \sqrt{2})}{M' \ell_2(\gamma)} \cdot \frac{\ell_2(\gamma)}{\ell_1(\gamma)} \leq \frac{2e}{M'} \cdot \frac{\ell_2(\gamma)}{\ell_1(\gamma)}. \end{aligned}$$

Case 2: $\ell_1(\gamma) \geq e^{-1} \ln(1 + \sqrt{2})$.

Since $d_1 = 0$ and $b'_2 \geq M'$, we have $d_1/(b'_2 + d_2) = 0$.

Let $K_3'' = \max\{2, 2e/M'\}$. Since $\frac{c_2}{c_1} = \frac{\ell_2(\gamma)}{\ell_1(\gamma)}$, we have

$$\frac{d_1}{b'_2 + d_2} \leq K_3'' \cdot \max\{1, \frac{c_2}{c_1}\}.$$

This completes the proof. \square

We argue similarly for

Lemma 4.3. *There exists a positive constant K_3'' depending on ϵ_0 such that*

$$(27) \quad \frac{d_1'}{b_2' + d_2'} \leq K_3''' \cdot \max\{1, \frac{c_2'}{c_1'}\}.$$

Proposition 4.4. *For any essential arc $\beta \in \mathcal{B}(S)$ with endpoints lying on different boundary components γ and γ' of S , let α be the associated simple closed curve isotopic to the boundary of a regular neighborhood of $\beta \cup \gamma \cup \gamma'$. Then there exists a positive constant K_3 depending on ϵ_0 such that the following inequality holds for any X_1, X_2 in the ϵ_0 -relative part of $\mathcal{T}(S)$:*

$$(28) \quad \frac{\ell_{X_1}(\beta)}{\ell_{X_2}(\beta)} \leq K_3 \cdot \max\{1, \frac{\ell_{X_1}(\alpha)}{\ell_{X_2}(\alpha)}, \frac{\ell_{X_2}(\gamma)}{\ell_{X_1}(\gamma)}, \frac{\ell_{X_2}(\gamma')}{\ell_{X_1}(\gamma')}\}.$$

Proof. By Lemma 4.1, Lemma 4.2 and Lemma 4.3, the ratio $\ell_1(\beta)/\ell_2(\beta)$ satisfies

$$\begin{aligned} \frac{\ell_1(\beta)}{\ell_2(\beta)} &\leq 3 \cdot \max\left\{\frac{b_1'}{b_2'}, \frac{d_1}{b_2' + d_2}, \frac{d_1'}{b_2' + d_2'}\right\} \\ &\leq 3 \cdot \max\left\{K_3' \cdot \max\{1, \frac{a_1}{a_2}\}, K_3'' \cdot \max\{1, \frac{c_2}{c_1}\}, K_3''' \cdot \max\{1, \frac{c_2'}{c_1'}\}\right\} \\ &\leq K_3 \cdot \max\left\{1, \frac{a_1}{a_2}, \frac{c_2}{c_1}, \frac{c_2'}{c_1'}\right\} \\ &= K_3 \cdot \max\left\{1, \frac{\ell_1(\alpha)}{\ell_2(\alpha)}, \frac{\ell_2(\gamma)}{\ell_1(\gamma)}, \frac{\ell_2(\gamma')}{\ell_1(\gamma')}\right\}, \end{aligned}$$

where $K_3 = 3 \cdot \max\{K_3', K_3'', K_3'''\}$. □

4.2. The case where $\gamma = \gamma'$.

For hyperbolic structures X_i , $i = 1, 2$, on S , we choose α_i , α_i' , γ_i' and γ_i'' , $i = 1, 2$, as in the beginning of subsection 3.2. We repeat the constructions as follows. Let α and α' be the boundaries of the regular neighborhood of $\beta \cup \gamma$. We may assume that $\ell_i(\alpha) \geq \ell_i(\alpha')$, for $i = 1, 2$. As we show in Figure 10, the arc β separates γ into two sub-arcs γ_i' and γ_i'' , such that $\gamma_i' \cup \beta$ is isotopic to α , for $i = 1, 2$.

Similar to the criterion given in the above subsection, we choose closed curves C_i , $i = 1, 2$, which are isotopic to γ as follows. Denote ℓ_{X_i} by ℓ_i , $i = 1, 2$. If $\ell_i(\gamma) \geq e^{-1} \ln(1 + \sqrt{2})$, then we let $C_i = \gamma$, for $i = 1, 2$, as we shown in (b) of Figure 10. Otherwise, we let C_i be the inner boundary of a regular annulus around γ with $\ell_i(C_i) = \epsilon_0'$, for $i = 1, 2$, as we show in (a) of Figure 10.

Cutting along the three geodesic arcs which connect any two of the boundaries of the pair of pants, we obtain two symmetric right-angled hexagons. We only need consider one of them.

If $\ell_i(\gamma) < e^{-1} \ln(1 + \sqrt{2})$, the part of β in one of the hexagon is separated by C_i into two sub-arcs, for $i = 1, 2$. As we show in Figure 10 (b), let $b_i = \ell_i(\beta_i^Q)/2$ and $d_i = \ell_i(\beta_i^A) = \ell_i(\beta_i'^A)$, for $i = 1, 2$.

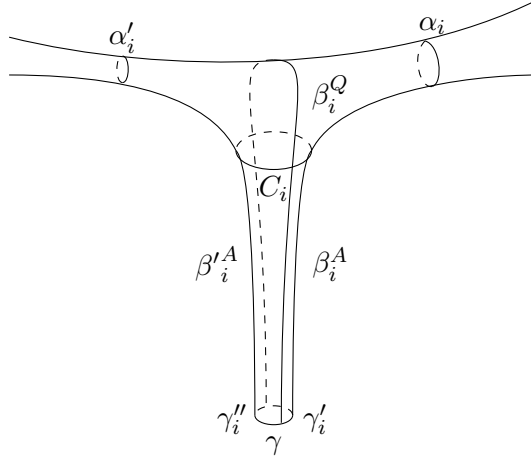
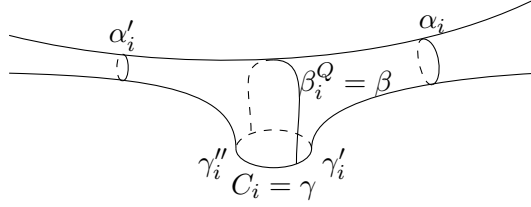
(a) Case $\ell_{X_i}(\gamma) < e^{-1} \ln(1 + \sqrt{2})$ (b) Case $\ell_{X_i}(\gamma) \geq e^{-1} \ln(1 + \sqrt{2})$ FIGURE 10. Examples of pair of pants on X_i when $\gamma = \gamma'$ and $\epsilon_0 \geq e^{-1} \ln(1 + \sqrt{2})$.

If $\ell_i(\gamma) \geq e^{-1} \ln(1 + \sqrt{2})$, since $C_i = \gamma$, we let $b_i = \ell_i(\beta)/2$ and $d_i = 0$, for $i = 1, 2$. For sake of simplicity, let $c'_i = \ell_i(\gamma'_i)$, $c''_i = \ell_i(\gamma''_i)$, $a_i = \ell_i(\alpha)/2$, $a'_i = \ell_i(\alpha')/2$ and $c'_0 = c''_0 = \ln(1 + \sqrt{2})/2$, for $i = 1, 2$.

In either case, $\ell_i(\beta) = b_i + d_i$, $i = 1, 2$. It's easy to show that

$$\frac{\ell_1(\beta)}{\ell_2(\beta)} = \frac{2 \cdot (b_1 + d_1)}{2 \cdot (b_2 + d_2)} \leq 2 \cdot \max\left\{\frac{b_1}{b_2}, \frac{d_1}{b_2 + d_2}\right\}.$$

We will study the b_1/b_2 part and the $d_2/(b_2 + d_2)$ part.

We first consider the b_1/b_2 part.

Lemma 4.5. *There exists a positive constant K'_4 depending on ϵ_0 such that*

$$(29) \quad \frac{b_1}{b_2} \leq K'_4 \cdot \max\left\{1, \frac{\ell_1(\alpha)}{\ell_2(\alpha)}\right\}.$$

Proof. As in the proof of (17), we have

$$\frac{\ell_i(\gamma)}{4} \leq c'_i \leq \frac{\ell_i(\gamma)}{2}, \quad i = 1, 2.$$

We will show that there exists a positive lower bound for b_i , $i = 1, 2$.

Consider b_1 first. If $\ell_1(\gamma) < e^{-1} \ln(1 + \sqrt{2})$, then $b_1 \geq 4/\ln(1 + \sqrt{2})$, see (16). Now we suppose that $\ell_1(\gamma) \geq e^{-1} \ln(1 + \sqrt{2})$. By (2) (we refer to

Figure 8), we have

$$\sinh b_1 \sinh c'_1 = \cosh a_1.$$

And the inequality $c'_1 \leq \ell_1(\gamma)/2 \leq \epsilon_0/2$ implies that

$$\sinh b_1 = \frac{\cosh a_1}{\sinh c'_1} \geq \frac{1}{\sinh(\epsilon_0/2)}.$$

Therefore $b_1 \geq \operatorname{arsinh}((\sinh(\epsilon_0/2))^{-1})$.

Let $M'_0 = \max\{4/\ln(1 + \sqrt{2}), \operatorname{arsinh}((\sinh(\epsilon_0/2))^{-1})\}$. Then we have $b_1 \geq M'_0$. The same argument implies $b_2 \geq M'_0$. Thus we have

$$(30) \quad b_i \geq M'_0, \quad i = 1, 2.$$

Since $b_i + d_i \geq M'_0$ and $c'_i < \epsilon_0/2$, $i = 1, 2$, we have $k_2 > 0$ (depending on ϵ_0) such that

$$k_2^{-1} \cdot e^{b_i+d_i} \leq \sinh(b_i + d_i) \leq \frac{1}{2} \cdot e^{b_i+d_i}, \quad i = 1, 2,$$

and

$$c'_i \leq \sinh c'_i \leq k_2 \cdot c'_i, \quad i = 1, 2.$$

Similarly to the proof of (20), we will show that the difference between b_i and a_i , $i = 1, 2$, is bounded from above. We first study the difference between b_1 and a_1 . There are two cases depending on whether $\ell_1(\gamma) < e^{-1} \ln(1 + \sqrt{2})$ or not.

Case (a): $\ell_1(\gamma) < e^{-1} \ln(1 + \sqrt{2})$.

For this case, by the same argument as in the proof of (20), we have $|b_1 - a_1| < D_2$.

Case (b): $\ell_1(\gamma) \geq e^{-1} \ln(1 + \sqrt{2})$.

In this case, since $d_1 = 0$, as in the proof of (20), we have

$$e^{a_1} \geq k_2^{-1} c'_1 e^{b_1} \geq \frac{k_2^{-1}}{4} \ell_1(\gamma) e^{b_1} \geq \frac{k_2^{-1} \ln(1 + \sqrt{2})}{4e} \cdot e^{b_1}$$

and

$$e^{a_1} \leq k_2 c'_1 e^{b_1} \leq \frac{k_2 \epsilon_0}{2} \cdot e^{b_1}.$$

Let $D'_2 = \max\{|\ln(k_2^{-1} \ln(1 + \sqrt{2})) - \ln(4e)|, |\ln(k_2 \epsilon_0) - \ln 2|\}$. We have $|b_1 - a_1| < D'_2$.

The same proof applies to $a_2 - b_2$. Thus we have a positive constant D'_2 depending on ϵ_0 such that

$$(31) \quad |b_i - a_i| < D'_2, \quad \text{for } i = 1, 2.$$

The rest of the proof of this lemma is identical to the proof of Lemma 3.10 after the inequality (20). We omit the details. \square

The next lemma is the discussion for the $d_1/(b_2 + d_2)$ part.

Lemma 4.6. *There exists a positive constant K''_4 depending on ϵ_0 such that*

$$(32) \quad \frac{d_1}{b_2 + d_2} \leq K''_4 \cdot \max\left\{1, \frac{\ell_2(\gamma)}{\ell_1(\gamma)}\right\}.$$

Proof. We need to consider the two cases depending on whether $\ell_1(\gamma) < e^{-1} \ln(1 + \sqrt{2})$ or not.

Case (a): $\ell_1(\gamma) < e^{-1} \ln(1 + \sqrt{2})$.

If, moreover, $\ell_2(\gamma) < e^{-1} \ln(1 + \sqrt{2})$, then by Lemma 3.11, we have

$$(33) \quad \frac{d_1}{b_2 + d_2} \leq \frac{d_1}{d_2} \leq 2 \max\left\{1, \frac{\ell_2(\gamma)}{\ell_1(\gamma)}\right\}.$$

Otherwise, $\ell_2(\gamma) \geq e^{-1} \ln(1 + \sqrt{2})$. As $d_2 = 0$, by (26), we have

$$\frac{d_1}{b_2 + d_2} = \frac{d_1}{b_2} \leq \frac{2}{M_0} \ln \frac{\ell_1(C)}{\ell_1(\gamma)}.$$

Since $\ell_1(C) \geq \ell_1(\gamma)$, we have

$$\ln \frac{\ell_1(C)}{\ell_1(\gamma)} \leq \frac{\ell_1(C)}{\ell_1(\gamma)}.$$

It follows that

$$\frac{d_1}{b_2 + d_2} \leq \frac{2}{M''} \frac{\ell_1(C)}{\ell_1(\gamma)} = \frac{2 \ln(1 + \sqrt{2})}{M'' \ell_2(\gamma)} \frac{\ell_2(\gamma)}{\ell_1(\gamma)} = \frac{2e}{M''} \cdot \frac{\ell_2(\gamma)}{\ell_1(\gamma)}.$$

Case (b): $\ell_1(\gamma) \geq e^{-1} \ln(1 + \sqrt{2})$.

By assumption, $d_1 = 0$. It follows that

$$d_1/(b_2 + d_2) = 0.$$

Let $K_4'' = \max\{2, 2e/M_0'\}$. We are done. \square

Proposition 4.7. *Let X_1, X_2 be any hyperbolic metrics in the ϵ_0 -relative part of $\mathcal{T}(S)$. For any essential arc $\beta \in \mathcal{B}(S)$ with endpoints lying on the same boundary component γ of S , let α and α' be the associated simple closed curves homotopic the boundaries of a regular neighborhood of $\beta \cup \gamma$. Then there exists a positive constant K_4 depending on ϵ_0 such that*

$$(34) \quad \frac{\ell_{X_1}(\beta)}{\ell_{X_2}(\beta)} \leq K_4 \cdot \max\left\{1, \frac{\ell_{X_1}(\alpha)}{\ell_{X_2}(\alpha)}, \frac{\ell_{X_1}(\alpha')}{\ell_{X_2}(\alpha')}, \frac{\ell_{X_2}(\gamma)}{\ell_{X_1}(\gamma)}\right\}.$$

Proof. This is a corollary of (29) and (32). \square

4.3. Conclusion. By Proposition 4.4 and Proposition 4.7, the same proof as that of Corollary 3.13 proves Theorem 1.6. Theorem 1.6 implies Theorem 1.5.

Recall that in the proof of Theorem 1.5, we just use elementary hyperbolic geometry. However, for example, the inequality (7) we have shown is not obvious. Note that we only assume that the hyperbolic surfaces belong to the ϵ_0 -relative part of $\mathcal{T}(S)$ (not the thick part), thus the geodesic arcs we consider may cross long narrow cylinders or twist a lot. Thus it is difficult to control the lengths of arcs by that of simple closed curves. What we have done is to show that the ratios can be controlled uniformly.

Example 4.8. We use the Nielsen extension of Riemann surfaces with boundary [4, 22] to show that inequality (1) fails on the whole ϵ_0 -relative part of $\mathcal{T}(S)$.

Let X_0 be any given hyperbolic metric on S . We can add each geodesic boundary component of X_0 with an infinite funnel such that X_0 becomes the convex core of a Riemann surface $R = \mathbb{H}^2/\Gamma$, where Γ is a Fuchsian group of the second kind. By taking the double of R , we obtain a Riemann surface R^d without boundary. There is a unique hyperbolic metric in the conformal class of R^d and its restriction on R defines a new hyperbolic metric X_1 on S with geodesic boundary. We call X_1 the *Nielsen extension* of X_0 .

We may view X_0 as a conformal embedded subsurface of X_1 . By the Schwarz Lemma, the Nielsen extension decreases the hyperbolic metric on X_0 . As a result, we have

$$\sup_{\alpha \in \mathcal{C}(S)} \left\{ \frac{\ell_{X_1}(\alpha)}{\ell_{X_0}(\alpha)} \right\} \leq 1.$$

A theorem of Halpern [10] shows that, if α is a boundary curve of X_0 with length l , then the length of the corresponding boundary curve of the Nielsen extension X_1 is less than $\frac{l}{2}$. In particular, if we define by X_{n+1} be the Nielsen extension of X_n , then $\ell_{X_n}(\alpha) \rightarrow 0$ for any boundary curve α . Combined with the Collar Lemma, we have

$$\sup_{\alpha \in \mathcal{C}(S) \cup \mathcal{B}(S)} \left\{ \frac{\ell_{X_n}(\alpha)}{\ell_{X_0}(\alpha)} \right\} \rightarrow \infty$$

while

$$\sup_{\alpha \in \mathcal{C}(S)} \left\{ \frac{\ell_{X_n}(\alpha)}{\ell_{X_0}(\alpha)} \right\} \leq 1.$$

Note that the sequence (X_n) we constructed lies in some ϵ_0 -relative part of $\mathcal{T}(S)$, but not in any ϵ -thick ϵ_0 -relative part.

On the other hand, the “ ϵ_0 -relative” upper boundedness assumption on lengths of the boundary curves is necessary for both inequality (1) and Theorem 1.6, see Example 3.8 in [16].

5. APPLICATIONS AND FURTHER STUDY

5.1. Moduli space. Let $\text{Mod}(S)$ be the modular group (or the mapping class group) of S . Recall that $\text{Mod}(S)$ is the group of homotopy classes of orientation-preserving homeomorphism of S . $\text{Mod}(S)$ acts on the Teichmüller space $\mathcal{T}(S)$ by switching the markings. Moreover, the action is properly discontinuous and by isometries (here we endow $\mathcal{T}(S)$ with the length spectrum metric or the arc-length spectrum metric). The moduli space of S , denoted by $\mathcal{M}(S)$, is the quotient space

$$\mathcal{M}(S) = \mathcal{T}(S)/\text{Mod}(S).$$

We have the natural projective map $\pi : \mathcal{T}(S) \rightarrow \mathcal{M}(S)$.

For any fixed positive number ϵ_0 , the subset of $\mathcal{M}(S)$ consisting of hyperbolic structures with lengths of boundary components bounded above by ϵ_0 is called the ϵ_0 -relative part of $\mathcal{M}(S)$.

The metric d on $\mathcal{T}(S)$ induces a metric d^M on $\mathcal{M}(S)$ by letting

$$d^M(\tau_1, \tau_2) = \inf_{X_i \in \pi^{-1}(\tau_i)} d(X_1, X_2).$$

Similarly, we have corresponding metrics \bar{d}^M , δ_L^M and d_L^M on $\mathcal{M}(S)$ which are induced by \bar{d} , δ_L and d_L on $\mathcal{T}(S)$, respectively.

The following result is a direct corollary of Theorem 1.5.

Corollary 5.1. *Given $\epsilon_0 > 0$. Let $d_L^{(M)}$ and $\delta_L^{(M)}$ be the length spectrum metric and the arc-length spectrum metric on $\mathcal{M}(S)$. For any τ_1, τ_2 in the ϵ_0 -relative part of $\mathcal{M}(S)$, we have*

$$(35) \quad d_L^M(\tau_1, \tau_2) \leq \delta_L^M(\tau_1, \tau_2) \leq d_L^M(\tau_1, \tau_2) + C,$$

where C is a positive constant depending on ϵ_0 .

In the case where S is a surface of finite type without boundary, the authors [15] proved that the length spectrum metric and the Teichmüller metric are almost isometric on the moduli space $\mathcal{M}(S)$. The result can not be generalized to surfaces of finite type with boundary [18]. However, we ask the following

Problem 5.2. Let S be a surface of finite type with boundary. Are the arc-length spectrum metric and the Teichmüller metric almost isometric on the moduli space $\mathcal{M}(S)$?

5.2. Metrics on Teichmüller spaces of surfaces of infinite type. A surface is said to be of *finite type* if its fundamental group is finitely generated. Otherwise it is said to be of *infinite type*. For more details on Teichmüller spaces of surfaces of infinite type (where the definition of Teichmüller space is not unique and more involved), we refer to [2].

A hyperbolic surface S (possibly with geodesic boundary) is said to be *convex* if for every pair of points $x, y \in S$ and for every arc γ with endpoints x and y , there exists a geodesic arc of S connecting x and y that is homotopic to γ relative to the endpoints.

A convex hyperbolic surface S with geodesic boundary is *Nielsen convex* if every point of S is contained in a geodesic arc with endpoints contained in some simple closed geodesics of S . For a hyperbolic surface of finite type to be Nielsen convex is equivalent to be convex with geodesic boundary and of finite area. However, for surfaces of infinite type the two notions maybe not equivalent [2].

In this following, we assume that S is a hyperbolic surfaces of infinite type and S is Nielsen convex. Moreover, we assume that all the boundary components of S are of length less than some positive constant.

Denote by $\mathcal{T}_L(S)$ the length spectrum Teichmüller space of S , which consists of (equivalence classes) of hyperbolic surfaces X that are homeomorphic with S and satisfy

$$d_L(S, X) = \log \sup_{\alpha \in \mathcal{C}(S)} \left\{ \frac{\ell_X(\alpha)}{\ell_S(\alpha)}, \frac{\ell_S(\alpha)}{\ell_X(\alpha)} \right\} < \infty.$$

We endow $\mathcal{T}_L(S)$ with the length spectrum metric

$$d_L(X, Y) = \log \sup_{\alpha \in \mathcal{C}(S)} \left\{ \frac{\ell_Y(\alpha)}{\ell_X(\alpha)}, \frac{\ell_X(\alpha)}{\ell_Y(\alpha)} \right\}.$$

We define the ϵ_0 -relative part of $\mathcal{T}_L(S)$ to be the subset consisting of hyperbolic surfaces with lengths of boundary components bounded above by ϵ_0 . By assumption on S , the ϵ_0 -relative part of $\mathcal{T}_L(S)$ is not an empty set if ϵ_0 is sufficiently large. We can also define the arc-length spectrum metric by

$$\delta_L(X, Y) = \log \sup_{\alpha \in \mathcal{C}(S) \cup \mathcal{B}(S)} \left\{ \frac{\ell_Y(\alpha)}{\ell_X(\alpha)}, \frac{\ell_X(\alpha)}{\ell_Y(\alpha)} \right\}.$$

As the discussions in the previous sections are not related to the topological type of surface, we have the following theorem.

Theorem 5.3. *Given $\epsilon_0 > 0$. Let d_L and δ_L be the length spectrum metric and the arc-length spectrum metric on $\mathcal{T}_L(S)$. For any X and Y in the ϵ_0 -relative part of $\mathcal{T}_L(S)$, we have*

$$d_L(X, Y) \leq \delta_L(X, Y) \leq d_L(X, Y) + C,$$

where C is a positive constant depending on ϵ_0 .

5.3. Further study.

Note that the constant $C = C(\epsilon_0)$ in Theorem 1.5 only depend on ϵ_0 .

Problem 5.4. Does the constant $C = C(\epsilon_0)$ in Theorem 1.5 tends to 0 as ϵ_0 tends to 0?

It was shown in [16] that for surfaces of finite type with boundary,

$$(36) \quad \log \sup_{\alpha \in \mathcal{B}(S) \cup \mathcal{C}(S)} \left\{ \frac{\ell_X(\alpha)}{\ell_Y(\alpha)} \right\} = \log \sup_{\alpha \in \mathcal{B}(S) \cup \partial S} \left\{ \frac{\ell_X(\alpha)}{\ell_Y(\alpha)} \right\}.$$

for any $X, Y \in \mathcal{T}(S)$. This gives new formulae for Thurston's metric and the arc-length spectrum metric. The above equality (36) was proved by using Thurston's theory of measured laminations.

Problem 5.5. Does the equality (36) hold on Teichmüller spaces of surfaces of infinite type?

REFERENCES

- [1] Abikoff W.: The real analytic theory of Teichmüller space. Lecture Notes in Mathematics 820. Springer-Verlag (1980).
- [2] Alessandrini D., L. Liu, A. Papadopoulos, W. Su, and Z. Sun: On Fenchel-Nielsen coordinates on Teichmüller spaces of surfaces of infinite type. Ann. Acad. Sci. Fenn. Math. 36, no.2, 2011, 621-659.
- [3] Alessandrini D., L. Liu, A. Papadopoulos, W. Su: The horofunction compactification of the arc metric on Teichmüller space. arXiv:1411.6208.
- [4] Bers L.: Nielsen extensions of Riemann surfaces. Ann. Acad. Sci. Fenn. 2, 1976, 29-34.
- [5] Buser P.: Geometry and spectra of compact Riemann surfaces. Reprint of the 1992 edition. Modern Birkhäuser Classics. Birkhäuser Boston, Inc., Boston, MA, 2010.

- [6] Choi Y. and K. Rafi: Comparison between Teichmüller and Lipschitz metrics. *J. Lond. Math. Soc. (2)* 76, no.3, 2007, 739-756.
- [7] Danciger J., F. Guéritaud and F. Kassel: Margulis spacetimes via the arc complex. arXiv:1407.5422.
- [8] Earle C. J.: Reduced Teichmüller spaces. *Transactions of the American Mathematical Society*, 1967, 54-63.
- [9] Earle C. J. and A. Schatz: Teichmüller theory for surfaces with boundary. *Journal of Differential Geometry*, 4(2), 1970, 169-185.
- [10] Halpern N.: Some remarks on Nielsen extensions of Riemann surfaces. *The Michigan Mathematical Journal*, 30(1), 1983, 65-68.
- [11] Li Z.: Teichmüller metric and length spectrums of Riemann surfaces. *Sci. Sinica Ser. A* 29, no. 3, 1986, 265-274.
- [12] Liu L., Z. Sun and H. Wei: Topological equivalence of metrics in Teichmüller space. *Ann. Acad. Sci. Fenn. Math.* 33, no. 1, 2008, 159-170.
- [13] Liu L.: On the length spectrums of non-compact Riemann surfaces. *Ann. Acad. Sci. Fenn. Math.* 24, 1999, 11-22.
- [14] Liu L.: On the metrics of length spectrum in Teichmüller space. *Chinese J. Cont. math.* 22 (1), 2001, 23-34.
- [15] Liu L. and W. Su: Almost-isometry between Teichmüller metric and length-spectrum metric on moduli space. *Bull. Lond. Math. Soc.* 43, no.6, 2011, 1181-1190.
- [16] Liu L., A. Papadopoulos, W. Su and G. Théret: On length spectrum metrics and weak metrics on Teichmüller spaces of surfaces with boundary. *Ann. Acad. Sci. Fenn. Math.* 35, no.1, 2010, 255-274.
- [17] Liu L., A. Papadopoulos, W. Su and G. Théret: Length spectra and the Teichmüller metric for surfaces with boundary. *Monatsh. Math.* 161, no.3, 2010, 295-311.
- [18] Liu L., H. Shiga, W. Su and Y. Zhong, in preparation.
- [19] Marden A.: *Outer circles: An introduction to hyperbolic 3-manifolds.* Cambridge University Press, 2007.
- [20] Minsky Y.: Extremal length estimates and product regions in Teichmüller space. *Duke Math.J.* 83, 1996, 249-286.
- [21] Papadopoulos T. and G. Théret: On the topology defined by Thurston's asymmetric metric. *Math. Proc. Camb. Phil. Soc.*, 142, 2007, 487-496.
- [22] Papadopoulos A. and G. Théret: Shortening all the simple closed geodesics on surfaces with boundary. *Proc. Amer. Math. Soc.* 138, no. 5, 2010, 1775-1784.
- [23] Shiga H.: On a distance defined by the length spectrum of Teichmüller space. *Ann. Acad. Sci. Fenn. Math.* 28, no. 2, 2003, 315-326.
- [24] Sorvali T.: The boundary mapping induced by an isomorphism of covering groups. *Ann. Acad. Sci. Fenn. Ser. A I* No. 526 (1972).
- [25] Sorvali T.: On Teichmüller spaces of tori. *Ann. Acad. Sci. Fenn. Ser. A I Math.* 1, 1975, 7-11.
- [26] Thurston W. P.: *The geometry and topology of Three-manifolds.* Mimeographed notes, Princeton University, 1976.
- [27] Thurston W. P.: Minimal stretch maps between hyperbolic surfaces. preprint, 1986, Arxiv:math.GT/9801039.
- [28] Wolpert S.: The length spectra as moduli for compact Riemann surfaces. *Ann. of Math.* 109, 1979, 323-351.

YOU LIANG ZHONG: DEPARTMENT OF MATHEMATICS, SUN YAT-SEN UNIVERSITY, 510275,
GUANGZHOU, P. R. CHINA

E-mail address: zhongy10430@gmail.com

LIXIN LIU: DEPARTMENT OF MATHEMATICS, SUN YAT-SEN UNIVERSITY, 510275,
GUANGZHOU, P. R. CHINA

E-mail address: mcsllx@mail.sysu.edu.cn

WEIXU SU: DEPARTMENT OF MATHEMATICS, FUDAN UNIVERSITY, 200433, SHANG-
HAI, P. R. CHINA

E-mail address: [suwx@fudan.edu.cn](mailto:suwxfudan.edu.cn)