

# $\beta$ -skeletons for a set of line segments in $\mathbb{R}^2$ \*

Mirosław Kowaluk and Gabriela Majewska

Institute of Informatics, University of Warsaw, Warsaw, Poland,  
kowaluk@mimuw.edu.pl gm248309@students.mimuw.edu.pl

**Abstract.**  $\beta$ -skeletons are well-known neighborhood graphs for a set of points. We extend this notion to sets of line segments in the Euclidean plane and present algorithms computing such skeletons for the entire range of  $\beta$  values. The main reason of such extension is the possibility to study  $\beta$ -skeletons for points moving along given line segments. We show that relations between  $\beta$ -skeletons for  $\beta > 1$ , 1-skeleton (Gabriel Graph), and the Delaunay triangulation for sets of points hold also for sets of segments. We present algorithms for computing circle-based and lune-based  $\beta$ -skeletons. We describe an algorithm that for  $\beta \geq 1$  computes the  $\beta$ -skeleton for a set  $S$  of  $n$  segments in the Euclidean plane in  $O(n^2\alpha(n) \log n)$  time in the circle-based case and in  $O(n^2\lambda_4(n))$  in the lune-based one, where the construction relies on the Delaunay triangulation for  $S$ ,  $\alpha$  is a functional inverse of Ackermann function and  $\lambda_4(n)$  denotes the maximum possible length of a  $(n, 4)$  Davenport-Schinzel sequence. When  $0 < \beta < 1$ , the  $\beta$ -skeleton can be constructed in a  $O(n^3\lambda_4(n))$  time. In the special case of  $\beta = 1$ , which is a generalization of Gabriel Graph, the construction can be carried out in a  $O(n \log n)$  time.

## 1 Introduction

$\beta$ -skeletons in  $\mathbb{R}^2$  belong to the family of proximity graphs, geometric graphs in which an edge between two vertices (points) exists if and only if they satisfy particular geometric requirements. In this paper we use the following definitions of the  $\beta$ -skeletons for sets of points in the Euclidean space ( $\beta$ -skeletons are also defined for  $\beta \in \{0, \infty\}$  but those cases have no significant influence on our considerations) :

**Definition 1.** For a given set of points  $V = \{v_1, v_2, \dots, v_n\}$  in  $\mathbb{R}^2$ , a distance function  $d$  and a parameter  $0 < \beta < \infty$  we define a graph

- $G_\beta(V)$  – called a lune-based  $\beta$ -skeleton [12] – as follows: two points  $v', v'' \in V$  are connected with an edge if and only if no point from  $V \setminus \{v', v''\}$  belongs to the set  $N(v', v'', \beta)$  (neighborhood) where:
  1. for  $0 < \beta < 1$ ,  $N(v', v'', \beta)$  is the intersection of two discs, each with radius  $\frac{d(v', v'')}{2\beta}$  and having the segment  $v'v''$  as a chord,
  2. for  $1 \leq \beta < \infty$ ,  $N(v', v'', \beta)$  is the intersection of two discs, each with radius  $\frac{\beta d(v', v'')}{2}$ , whose centers are in points  $(\frac{\beta}{2})v' + (1 - \frac{\beta}{2})v''$  and in  $(1 - \frac{\beta}{2})v' + (\frac{\beta}{2})v''$ , respectively;
- $G_\beta^c(V)$  – called a circle-based  $\beta$ -skeleton [5] – as follows: two points  $v', v''$  are connected with an edge if and only if no point from  $V \setminus \{v', v''\}$  belongs to the set  $N^c(v', v'', \beta)$  (neighborhood) where:
  1. for  $0 < \beta < 1$  there is  $N^c(v', v'', \beta) = N(v', v'', \beta)$ ,
  2. for  $1 \leq \beta$  the set  $N^c(v', v'', \beta)$  is a union of two discs, each with radius  $\frac{\beta d(v', v'')}{2}$  and having the segment  $v'v''$  as a chord.

Points  $v', v'' \in V$  are called generators of the neighborhood  $N(v', v'', \beta)$  ( $N^c(v', v'', \beta)$ , respectively). The neighborhood  $N(v', v'', \beta)$  is called a lune. It follows from the definition that  $N(v', v'', 1) = N^c(v', v'', 1)$ .

\* This research is supported by the ESF EUROCORES program EUROGIGA, CRP VORONOI.

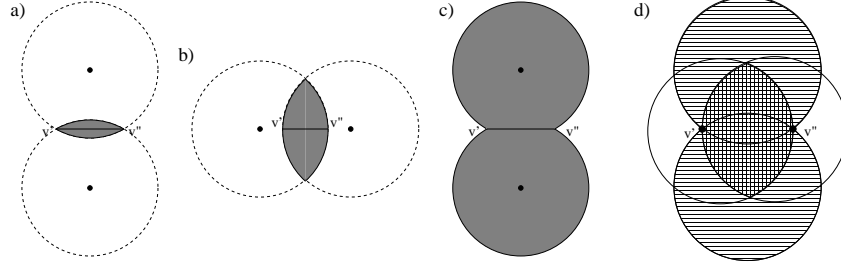

**Fig. 1.** Neighborhoods of the  $\beta$ -skeleton: (a) for  $0 < \beta \leq 1$ , (b) the lune-based skeleton, (c) the circle-based skeleton for  $1 < \beta < \infty$ . The relation between neighborhoods: (d)  $N(v', v'', \beta) \subseteq N^c(v', v'', \beta)$ .

$\beta$ -skeletons are both important and popular because of many practical applications which span a spectrum of areas from geographic information systems to wireless ad hoc networks and machine learning. For example, they allow us to reconstruct a shape of a two-dimensional object from a given set of sample points and they are also helpful in finding the minimum weight triangulation of a point set.

Hurtado, Liotta and Meijer [9] presented an  $O(n^2)$  algorithm for the  $\beta$ -skeleton when  $\beta < 1$ . Matula and Sokal [15] showed that the lune-based 1-skeleton (Gabriel Graph  $GG$ ) can be computed from the Delaunay triangulation in a linear time. Supowit [18] described how to construct the lune-based 2-skeleton (Relative Neighborhood Graph  $RNG$ ) of a set of  $n$  points in  $O(n \log n)$  time. Jaromczyk and Kowaluk [10] showed how to construct the  $RNG$  from the Delaunay triangulation  $DT$  for the  $L_p$  metric ( $1 < p < \infty$ ) in  $O(n\alpha(n))$  time. This result was further improved to  $O(n)$  time [14] for  $\beta$ -skeletons where  $1 \leq \beta \leq 2$ . For  $\beta > 1$ , the circle-based  $\beta$ -skeletons can be constructed in  $O(n \log n)$  time from the Delaunay triangulation  $DT$  with a simple test to filter edges of the  $DT$  [5]. On the other hand, so far the fastest algorithm for computing the lune-based  $\beta$ -skeletons for  $\beta > 2$  runs in  $O(n^{\frac{3}{2}} \log^{\frac{1}{2}} n)$  time [13].

Let us consider the case when we compute the  $\beta$ -skeleton for a set of  $n$  points  $V$  where every point  $v \in V$  is allowed to move along a straight-line segment  $s_v$ . Let  $S = \{s_v | v \in V\}$ . For each pair of segments  $s_{v_1}, s_{v_2}$  containing points  $v_1, v_2 \in V$ , respectively, we want to find such positions of points  $v_1$  and  $v_2$  that  $s_v \cap N(v_1, v_2, \beta) = \emptyset$  for any  $s_v \in S \setminus \{s_1, s_2\}$ . We will attempt to solve this problem by defining a  $\beta$ -skeleton for the set of line segments  $S$  as follows.

**Definition 2.**  $G_\beta(S)$  ( $G_\beta^c(S)$ , respectively) is a graph with  $n$  vertices such that there exists a bijection between the set of vertices and the set of segments  $S$ , and for  $s', s'' \in S$  an edge  $s' s''$  exists if there are points  $v' \in s'$  and  $v'' \in s''$  such that  $(\bigcup_{s \in S \setminus \{s', s''\}} s) \cap N(v', v'', \beta) = \emptyset$  ( $(\bigcup_{s \in S \setminus \{s', s''\}} s) \cap N^c(v', v'', \beta) = \emptyset$ , respectively).

Note that when segments degenerate to points, we have the standard  $\beta$ -skeleton for a point set.

Geometric structures concerning a set of line segments, e.g. the Voronoi diagram [3,16] or the straight skeleton [1] are well-studied in the literature.

Chew and Kedem [4] defined the Delaunay triangulation for line segments. Their definition was generalized by Bréviliers et al. [2].

However,  $\beta$ -skeletons for a set of line segments were completely unexplored. This paper makes an initial effort to fill this gap.

The paper is organized as follows. In the next section we present some basic facts and we prove that the definition of  $\beta$ -skeletons for a set of line segments preserves inclusions from the theorem of Kirkpatrick and Radke [12] formulated for a set of points. In Section 3 we show a general algorithm computing  $\beta$ -skeletons for a set of line segments in Euclidean plane when  $0 < \beta < 1$ . In Section 4

we present a similar algorithm for  $\beta \geq 1$  in both cases of lune-based and circle-based  $\beta$ -skeletons. In Section 5 we consider an algorithm for Gabriel Graph. The last section contains open problems and conclusions.

## 2 Preliminaries

Let us consider a two-dimensional plane  $\mathbb{R}^2$  with the Euclidean metric and a distance function  $d$ .

Let  $S$  be a finite set of disjoint closed line segments in the plane. Elements of  $S$  are called sites. A circle is tangent to a site  $s$  if  $s$  intersects the circle but not its interior. We assume that the sites of  $S$  are in general position, i.e., no three segment endpoints are collinear and no circle is tangent to four sites.

The Delaunay triangulation for the set of line segments  $S$  is defined as follows.

**Definition 3.** [2] *The segment triangulation  $P$  of  $S$  is a partition of the convex hull  $\text{conv}(S)$  of  $S$  in disjoint sites, edges and faces such that:*

- *Every face of  $P$  is an open triangle whose vertices belong to three distinct sites of  $S$  and whose open edges do not intersect  $S$ ,*
- *No face can be added without intersecting another one,*
- *The edges of  $P$  are the (possibly two-dimensional) connected components of  $\text{conv}(S) \setminus (F \cup S)$ , where  $F$  is the set of faces of  $P$ .*

*The segment triangulation  $P$  such that the interior of the circumcircle of each triangle does not intersect  $S$  is called the segment Delaunay triangulation.*

In this paper we will consider a planar graph (a planar multigraph, respectively)  $DT(S)$  corresponding to the segment Delaunay triangulation  $P$  and its relations with  $\beta$ -skeletons. This graph has a linear number of edges and is dual to the Voronoi Diagram graph for  $S$ . It is also possible to study properties of plane partitions generated by  $\beta$ -skeletons for line segments. We will discuss this problem in the last section of this paper.

We can consider open (closed, respectively) neighborhoods  $N(v', v'', \beta)$  that lead to *open (closed, respectively)  $\beta$ -skeletons*. For example, the *Gabriel Graph*  $GG$  [7] is the closed 1-skeleton and the *Relative Neighborhood Graph*  $RNG$  [19] is the open 2-skeleton.

Kirkpatrick and Radke [12] showed a following important inclusions connecting  $\beta$ -skeletons for a set of points  $V$  with the Delaunay triangulation  $DT(V)$  of  $V$  :  $G_{\beta'}(V) \subseteq G_{\beta}(V) \subseteq GG(V) \subseteq DT(V)$ , where  $\beta' > \beta > 1$ .

We show that definitions of the  $\beta$ -skeleton and the Delaunay triangulation for a set of line segments  $S$  preserve those inclusions. We define  $GG(S)$  as a 1-skeleton.

**Theorem 1.** *Let us assume that line segments in  $S$  are in general position and let  $G_{\beta}(S)$  ( $G_{\beta}^c(S)$ , respectively) denote the lune-based (circle-based, respectively)  $\beta$ -skeleton for the set  $S$ . For  $1 \leq \beta < \beta'$  following inclusions hold true:  $G_{\beta'}(S) \subseteq G_{\beta}(S) \subseteq GG(S) \subseteq DT(S)$  ( $G_{\beta'}^c(S) \subseteq G_{\beta}^c(S) \subseteq GG(S) \subseteq DT(S)$ , respectively).*

*Proof.* First we prove that  $GG(S) \subseteq DT(S)$ . Let  $v_1 \in s_1, v_2 \in s_2$  be such a pair of points that there exists a disc  $D$  with diameter  $v_1v_2$  containing no points belonging to segments from  $S \setminus \{s_1, s_2\}$  inside of it. We transform  $D$  under a homothety with respect to  $v_1$  so that its image  $D'$  is tangent to  $s_2$  in the point  $t$ . Then we transform  $D'$  under a homothety with respect to  $t$  so that its image  $D''$  is tangent to  $s_1$  (see Figure 2). The disc  $D''$  lies inside of  $D$ , i.e., it does not intersect segments

from  $S \setminus \{s_1, s_2\}$ , and it is tangent to  $s_1$  and  $s_2$ , so the center of  $D''$  lies on the Voronoi Diagram  $VD(S)$  edge. Hence, if the edge  $s_1s_2$  belongs to  $GG(S)$  then it also belongs to  $DT(S)$ .

The last inclusion is based on a fact that for  $1 \leq \beta < \beta'$  and for any two points  $v_1, v_2$  it is true that  $N(v_1, v_2, \beta) \subseteq N(v_1, v_2, \beta')$  (see [12]).

The sequence of inclusions for circle-based  $\beta$ -skeletons is a straightforward consequence of the fact that two different circles intersect in at most two points.

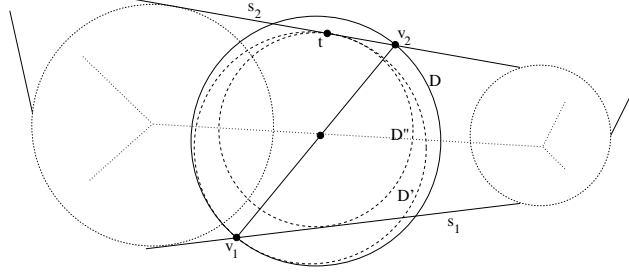

Fig. 2.  $GG(S) \subseteq DT(S)$ .

### 3 Algorithm for computing $\beta$ -skeletons for $0 < \beta < 1$

Let us consider a set  $S$  of  $n$  disjoint line segments in the Euclidean plane. First we show a few geometrical facts concerning  $\beta$ -skeletons  $G_\beta(S)$ .

The following remark is a straightforward consequence of the inscribed angle theorem.

*Remark 1.* For a given parameter  $0 < \beta \leq 1$  if  $v$  is a point on the boundary of  $N(v_1, v_2, \beta)$ , different from  $v_1$  and  $v_2$ , then an angle  $\angle v_1vv_2$  has a constant measure which depends only on  $\beta$ .

Let us consider a set of parametrized lines containing given segments. A line  $P(s_i)$  contains a segment  $s_i \in S$  and has a parametrization  $q_i(t_i) = (x_1^i, y_1^i) + t_i \cdot [x_2^i - x_1^i, y_2^i - y_1^i]$ , where  $(x_1^i, y_1^i)$  and  $(x_2^i, y_2^i)$  are ends of the segment  $s_i$  and  $t_i \in \mathbb{R}$ .

Let respective points from segments  $s_1$  and  $s_2$  be generators of a lune and let an inscribed angle determining a lune for a given value of  $\beta$  be equal to  $\delta$ . The main idea of the algorithm is as follows. For any point  $v_1 \in P(s_1)$  we compute points  $v_2 \in P(s_2)$  for which there exists a point  $v \in P(s)$ , where  $s \in S \setminus \{s_1, s_2\}$ , such that  $\delta \leq \angle v_1vv_2 \leq 2\pi - \delta$ , i.e.,  $v \in N(v_1, v_2, \beta)$  (see Figure 3). Then we analyze a union of pairs of neighborhoods generators for all  $s \in S \setminus \{s_1, s_2\}$ . If this union contains all pairs of points  $(v_1, v_2)$ , where  $v_1 \in s_1$  and  $v_2 \in s_2$ , then  $(s_1, s_2) \notin G_\beta(S)$ .

For a given  $t_1 \in \mathbb{R}$  and a segment  $s \in S \setminus \{s_1, s_2\}$  we shoot rays from a point  $v_1 = q_1(t_1) \in P(s_1)$  towards  $P(s)$ . Let us assume that a given ray intersects  $P(s)$  in a point  $v = q(t) = (x_1, y_1) + t \cdot [x_2 - x_1, y_2 - y_1]$  for some value of  $t \in \mathbb{R}$ . Let  $w(t) = \overrightarrow{v_1v}$  be the vector between points  $v_1$  and  $v$ . Then  $w(t) = [A_1t + B_1t_1 + C_1, A_2t + B_2t_1 + C_2]$  where coefficients  $A_i, B_i, C_i$  for  $i = 1, 2$  depend only on endpoints coordinates of segments  $s_1$  and  $s$ . The ray refracts in  $v$  from  $P(s_1)$  in such a way that the angle between directions of incidence and refraction of the ray is equal to  $\delta$ . The parametrized equation of the refracted ray is  $r(z, t) = v + z \cdot R_\delta w(t)$  for  $z \geq 0$  (or  $r(z, t) = v + z \cdot R'_\delta w(t)$  for  $z \geq 0$ , respectively) where  $R_\delta$  ( $R'_\delta$ , respectively) denotes a rotation matrix for a clockwise (counter-clockwise, respectively) angle  $\delta$ . If refracted ray  $r(z, t)$  intersects line  $P(s_2)$  in a point  $q_2(t_2) = r(z, t)$  (it is not always possible - see Figure 3) then we compare the  $x$ -coordinates of  $q_2(t_2)$  and  $r(z, t)$ . As a result we obtain a function containing only parameters

$t_1$  and  $t_2$ :  $z = \frac{J \cdot t_2 + K \cdot t_1 + L}{D \cdot t_1 + E \cdot t_2 + F}$ , where coefficients  $J = -(x_2 - x_1)$ ,  $K = x_2^2 - x_1^2$ ,  $L = x_1^2 - x_1$ ,  $D = A_1 \cos \delta + A_2 \sin \delta$ ,  $E = B_1 \cos \delta + B_2 \sin \delta$ ,  $F = C_1 \cos \delta + C_2 \sin \delta$  are fixed. Since  $y$ -coordinates of  $q_2(t_2)$  and  $r(z, t)$  are also equal we obtain  $t_2(t) = \frac{M \cdot t^2 + p_1(t_1) \cdot t + p_2(t_1)}{N \cdot t + p_3(t_1)}$ , where  $p_1, p_2$  and  $p_3$  are (at most quadratic) polynomials of variable  $t_1$  and  $M, N$  are fixed (the exact description of those polynomials and variables is much more complex than the description of the coefficients in the previous step and it is omitted here - see them in Appendix).

Let  $l_{t_1}^\delta(t)$  denote a value of the parameter  $t_2$  of the intersection point of the line  $P(s_2)$  and the line containing the ray that starts in  $q_1(t_1)$  and refracts in  $q(t)$  creating an angle  $\delta$ . Let  $k_{t_1}^\delta = l_{t_1}^\delta|_I$ , where  $I$  is a set of values of  $t$  such that the ray refracted in  $q(t)$  intersects  $P(s_2)$ . The function  $l_{t_1}^\delta$  is a hyperbola and the function  $k_{t_1}^\delta$  is a part of it (see Figure 3).

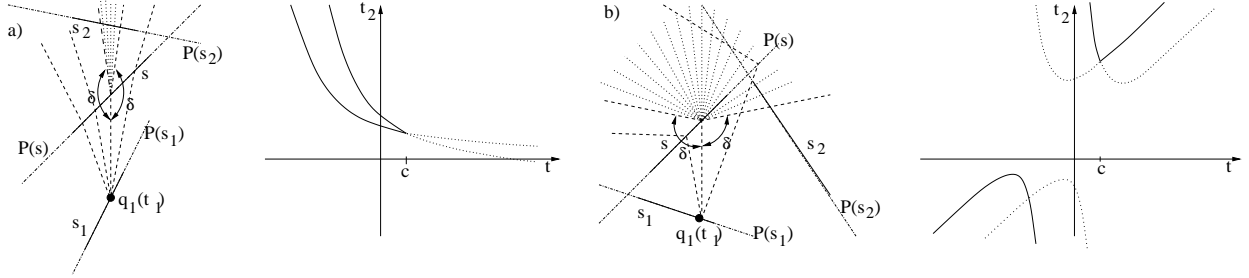

**Fig. 3.** Examples of correlation between parameters  $t$  and  $t_2$  (for a fixed  $t_1$ ) for a presented composition of segments and (a) a refraction angle near  $\pi$  (dotted lines show refracted rays that are analyzed) and (b) near  $\frac{\pi}{2}$ . The value  $c$  corresponds to the intersection point of lines  $P(s)$  and  $P(s_2)$ . Dotted curves show a case when a line containing a refracted ray intersects  $P(s_2)$  but the ray itself does not.

Note that for a given angle  $\delta$  ( $2\pi - \delta$ , respectively) extreme points of the function  $k_{t_1}^\delta$  ( $k_{t_1}^{2\pi-\delta}$ , respectively) do not have to belong to the set  $\{0, 1\}$ . We can find them by computing a derivative  $\frac{dt_2}{dt} = \frac{MN \cdot t^2 + 2Mp_3(t_1) \cdot t + p_1(t_1)p_3(t_1) - Np_2(t_1)}{(N \cdot t + p_3(t_1))^2}$ .

Then we can compute the corresponding values of the parameter  $t_2$ . This way we obtain the pair  $(t_1, t_2)$  such that the segment  $q_1(t_1)q_2(t_2)$  is a chord of a circle that is tangent to the analyzed segment  $s$  in  $q(t)$  and  $\angle q_1(t_1)q(t)q_2(t_2) = \delta$  ( $\angle q_1(t_1)q(t)q_2(t_2) = 2\pi - \delta$ , respectively).

Let  $T(t_1, s, s_2) = \bigcup_{\gamma \in [\delta, 2\pi-\delta], t \in [0, 1]} k_{t_1}^\gamma(t)$ , i.e., this is a set of all  $t_2$  such that points  $q_1(t_1)$  and  $q_2(t_2)$  generate a lune intersected by the analyzed segment  $s$ . Let  $F(s_1, s, s_2) = \bigcup_{t_1 \in R, x \in T(t_1, s, s_2)} (t_1, x)$  be a set of pairs of parameters  $(t_1, t_2)$  such that the segment  $s$  intersects a lune generated by points  $q_1(t_1)$  and  $q_2(t_2)$ . The set  $F(s_1, s, s_2)$  is an area limited by  $O(1)$  algebraic curves of degree at most 3. The curves match the values of the parameter  $t_2$  corresponding to extreme points of  $k_{t_1}^\delta$  ( $k_{t_1}^{2\pi-\delta}$ , respectively). In particular there are hyperbolas for angles  $\delta$  and  $2\pi - \delta$  correlated with the rays refracted in the ends of the segment  $s$  (for parameters  $t = 0$  and  $t = 1$ ) - see Figure 4.

**Lemma 1.** *The edge  $s_1, s_2$  belongs to the  $\beta$ -skeleton  $G_\beta(S)$  if and only if  $[0, 1] \times [0, 1] \setminus \bigcup_{s \in S \setminus \{s_1, s_2\}} F(s_1, s, s_2) \neq \emptyset$ .*

*Proof.* If  $[0, 1] \times [0, 1] \setminus \bigcup_{s \in S \setminus \{s_1, s_2\}} F(s_1, s, s_2) \neq \emptyset$  then there exists a pair of parameters  $(t_1, t_2) \in [0, 1] \times [0, 1]$  such that a lune generated by points  $q_1(t_1) \in s_1$  and  $q_2(t_2) \in s_2$  is not intersected by any segment  $s \in S \setminus \{s_1, s_2\}$ , i.e.,  $(s_1, s_2) \in G_\beta(S)$ . The opposite implication can be proved in the same way.

**Theorem 2.** *For  $0 < \beta < 1$  the  $\beta$ -skeleton  $G_\beta(S)$  can be found in  $O(n^3 \lambda_4(n))$  time.*

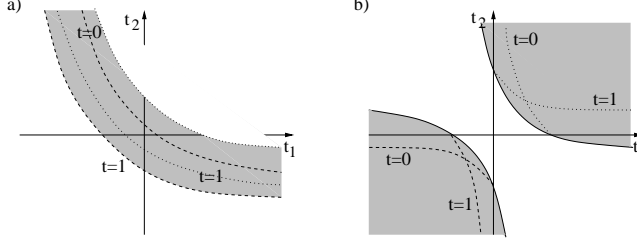

**Fig. 4.** Examples of sets  $F(s_1, s, s_2)$  for  $\beta$  near (a) 0 and (b) 1 (the shape of  $F(s_1, s, s_2)$  also depends on the position of the segment  $s$  with respect to  $s_1$  and  $s_2$ ). Dotted (dashed, respectively) curves limit the area corresponding to rays refracted through the segment  $s$  and creating the angle  $\delta$  ( $2\pi - \delta$ , respectively).

*Proof.* We analyze  $O(n^2)$  pairs of line segments. For each pair of segments  $s_1, s_2$  we compute  $\bigcup_{s \in S \setminus \{s_1, s_2\}} F(s_1, s, s_2)$ . For each  $s \in S \setminus \{s_1, s_2\}$  we find a set of pairs of parameters  $t_1, t_2$  such that  $N(q_1(t_1), q_2(t_2), \beta) \cap s \neq \emptyset$ . The arrangement of  $n - 2$  curves in total can be found in  $O(n\lambda_4(n))$  time [6]. Then the difference  $[0, 1] \times [0, 1] \setminus \bigcup_{s \in S \setminus \{s_1, s_2\}} F(s_1, s, s_2)$  can be found in  $O(n\lambda_4(n))$  time (see Figure 11 in Appendix). Therefore we can verify which edges belong to  $G_\beta(S)$  in  $O(n^3\lambda_4(n))$  time.

#### 4 Finding $\beta$ -skeletons for $1 \leq \beta$

Let us first consider the circle-based  $\beta$ -skeletons. According to Theorem 1 for  $1 \leq \beta$  there are only  $O(n)$  edges which can belong to the  $\beta$ -skeleton for a given set of line segments. We will use this property to compute  $\beta$ -skeletons faster than in the previous section.

**Lemma 2.** *For  $1 \leq \beta$  and the set  $S$  of  $n$  line segments the number of connected components of the set  $[0, 1] \times [0, 1] \setminus \bigcup_{s \in S \setminus \{s_1, s_2\}} F(s_1, s, s_2)$  is  $O(n)$  for any pair  $s_1, s_2 \in S$ .*

*Proof.* According to Theorem by Kirkpatrick and Radke [12] for  $1 \leq \beta < \beta'$  the following inclusion holds  $G_{\beta'}(v) \subseteq G_\beta(V)$ . Therefore any neighborhood for  $\beta'$  is included in some neighborhood for  $\beta$  with the same pair of generators. On the other hand, for a given parameter  $\beta$  and a given connected component of the set  $[0, 1] \times [0, 1] \setminus \bigcup_{s \in S \setminus \{s_1, s_2\}} F(s_1, s, s_2)$  there exists a sufficiently big  $\beta'$  such that for  $\beta'$  the component contains only one point (we increase an arbitrary neighborhood corresponding to the connected component for a given  $\beta$ ). Hence, the number of one point components (for all values of  $\beta$ ) estimates the number of connected components for a given  $\beta$ . But in this case at least one disc forming the neighborhood is tangent to two segments different than  $s_1$  and  $s_2$  or at least one generator of the neighborhood is at the end of  $s_1$  or  $s_2$ . In the first case the two segments tangent to the disc and segments  $s_1, s_2$  are the the closest ones to the center of the disc. Therefore the complexity of the set of such components does not exceed the complexity of the 4-order Voronoi diagram for  $S$ , i.e., it is  $O(n)$  [16]. In the second case there is a constant number of additional components.

**Lemma 3.** *For any  $t_1 \in \mathbb{R}$  and  $s_1, s_2 \in S$  there is at most one connected component of the set  $[0, 1] \times [0, 1] \setminus \bigcup_{s \in S \setminus \{s_1, s_2\}} F(s_1, s, s_2)$  that contains points with the same  $t_1$  coordinate.*

*Proof.* Let the inscribed angle corresponding to  $N^c(s_1, s_2, \beta)$  be equal to  $\delta$ . Let  $a = q_1(t_1)$  and  $b \in P(s_2)$  ( $b' \in P(s_2)$ , respectively) be points such that the angle between  $ab$  ( $ab'$ , respectively) and  $P(s_2)$  is equal to  $\delta$  (for  $\delta = \frac{\pi}{2}$  we have  $b = b'$ ), see Figure 5. Boundaries of all neighborhoods  $N^c(s_1, s_2, \beta)$  generated by  $a$  and a point in  $s_2$  contain either  $b$  or  $b'$ . There exists the leftmost

(rightmost, respectively) position (might be in infinity) of the second neighborhood generator with respect to the direction of  $t_2$ . Between those positions no neighborhood intersects segments from  $S \setminus \{s_1, s_2\}$ . Hence, points corresponding to positions of such generators belong to the same connected component of  $[0, 1] \times [0, 1] \setminus \bigcup_{s \in S \setminus \{s_1, s_2\}} F(s_1, s, s_2)$ .

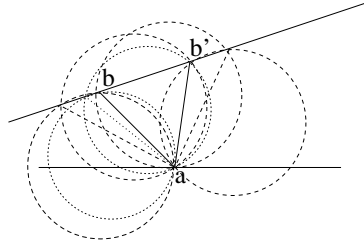
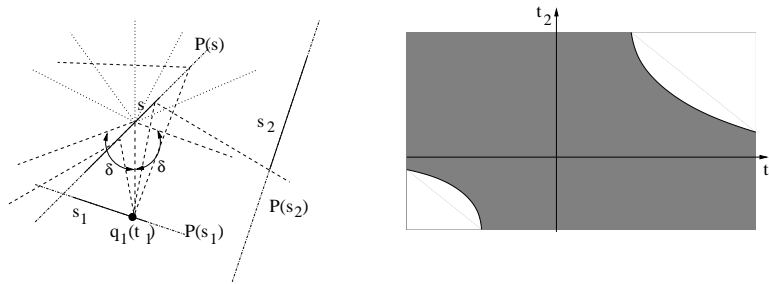

**Fig. 5.** Neighborhoods that have one common generator.

The algorithm for computing circle-based  $\beta$ -skeletons for  $\beta \geq 1$  is almost the same as the algorithm for  $\beta < 1$ .

**Theorem 3.** For  $\beta \geq 1$  the circle-based  $\beta$ -skeleton  $G_\beta^c(S)$  can be found in  $O(n^2\alpha(n) \log n)$  time.

*Proof.* Due to Theorem 1 we have to analyze  $O(n)$  edges of  $DT(S)$ . For  $\beta \geq 1$  and for the given segments  $s_1, s_2 \in S$  each set  $F(s_1, s, s_2)$  can be divided in two sets with respect to the variable  $t_1$ . For each  $t_1$  the first set contains part of  $F(s_1, s, s_2)$  that is unbound from above with respect to  $t_2$  and the second one contains part of  $F(s_1, s, s_2)$  unbound from below. The part that contains pairs  $(t_1, t_2)$  such that the set of values of  $t_2$  is  $\mathbb{R}$  can be divided arbitrarily. We use Hershberger's algorithm [8] to compute unions of sets for  $s \in S \setminus \{s_1, s_2\}$  in each group separately. Then, according to Lemma 3 we find an intersection of complements of computed unions. It needs  $O(n\alpha(n) \log n)$  time. Hence, the total time complexity of the algorithm is  $O(n^2\alpha(n) \log n)$ .



**Fig. 6.** An example of (a) refracted rays and (b) correlations between variables  $t_1$  and  $t_2$  for circle-based  $\beta$ -skeletons, where  $\beta \geq 1$ . (the shape of  $F(s_1, s, s_2)$  depends on the position of the segment  $s$  with respect to  $s_1$  and  $s_2$ )

Let us consider the lune-based  $\beta$ -skeletons now. Unfortunately, Lemma 3 does not hold in this case (see Figure 10 in Appendix).

According to Theorem 1, in this case we have to consider only  $O(n)$  pairs of line segments in  $S$  (the pairs corresponding to edges of  $DT(S)$ ). We will analyze pairs of points belonging to given segments  $s_1, s_2 \in S$  which generate discs such that each of them is intersected by any segment

$s \in S \setminus \{s_1, s_2\}$ . We will consider  $\beta$ -skeletons for  $\beta > 1$  (a 1-skeleton is the same in the circle-based and lune-based case). Let  $q_1(t_1) \in s_1$  and  $q_2(t_2) \in s_2$  be generators of a lune  $N(q_1(t_1), q_2(t_2), \beta)$  and let  $C_1(q_1(t_1), q_2(t_2), \beta)$  be a circle creating a part of its boundary containing point  $q_1(t_1)$ .

We will shoot a ray from a lune generator and we will compute a possible position of the second generator when the refraction point belongs to the lune. Let an angle between a shot ray and a refracted ray be equal to  $\frac{\pi}{2}$  and let  $q(t) \in s \cap C_1(q_1(t_1), q_2(t_2), \beta)$ . Unfortunately, the ray shot from  $q_1(t_1)$  and refracted in  $q(t)$  does not intersect the segment  $s_2$  in  $q_2(t_2)$ . However, we can define a segment  $s'$  such that the ray shot from  $q_1(t_1)$  refracts in  $q(t)$  if and only if the same ray refracted in a point of  $s'$  passes through  $q_2(t_2)$  (see Figure 7).

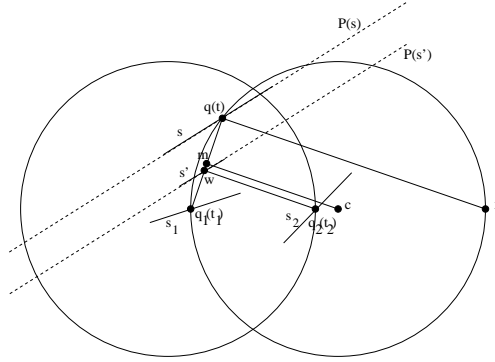

**Fig. 7.** The auxiliary segment  $s'$  and rays refracted in  $q(t)$  and  $w$ .

**Lemma 4.** Assume that  $\beta \geq 1$ ,  $q_1(t_1) \in P(s_1)$  and  $q_2(t_2) \in P(s_2)$ , where  $s_1, s_2 \in S$ . Let a point  $q(t) \in P(s)$ , where  $s \in S \setminus \{s_1, s_2\}$ , belong to  $C_1(q_1(t_1), q_2(t_2), \beta)$ . Let  $l$  be a line perpendicular to the segment  $(q_1(t_1), q(t))$ , passing through  $q_2(t_2)$  and crossing  $(q_1(t_1), q(t))$  in a point  $w$ . Then  $\frac{d(q_1(t_1), w)}{d(q_1(t_1), q(t))} = \frac{1}{\beta}$ .

*Proof.* Let  $x$  be an opposite to  $q_1(t_1)$  end of the diameter of  $C_1(q_1(t_1), q_2(t_2), \beta)$ . Then  $d(q_1(t_1), x) = 2d(q_1(t_1), c)$ , where  $c$  is the center of  $C_1(q_1(t_1), q_2(t_2), \beta)$ . From the definition of the  $\beta$ -skeleton follows that  $\frac{d(q_1(t_1), q_2(t_2))}{d(q_1(t_1), x)} = \frac{d(q_1(t_1), q_2(t_2))}{2d(q_1(t_1), c)} \cdot \frac{2d(q_1(t_1), q_2(t_2))}{2\beta d(q_1(t_1), q_2(t_2))} = \frac{1}{\beta}$ . According to Thales' theorem  $\frac{d(q_1(t_1), w)}{d(q_1(t_1), q(t))} = \frac{d(q_1(t_1), q_2(t_2))}{d(q_1(t_1), x)} = \frac{1}{\beta}$  (see Figure 7).

The algorithm computing a lune-based  $\beta$ -skeleton for  $\beta \geq 1$  is similar to the previous one. Let  $P(s') = h_{q_1(t_1)}^{\frac{1}{\beta}}(P(s))$ , where  $h_{q_1(t_1)}^{\frac{1}{\beta}}$  is a homothety with respect to a point  $q_1(t_1)$  and a ratio  $\frac{1}{\beta}$ . Like in the case of circle-based  $\beta$ -skeletons we compute pairs of parameters  $t_1, t_2$  such that the ray shot from  $q_1(t_1)$  refracts in a point of  $s'$  and intersects the segment  $s_2$  in  $q_2(t_2)$ , i.e., an analyzed segment  $s$  intersects a disc limited by the circle  $C_1(q_1(t_1), q_2(t_2), \beta)$ .

However, in the case of lune-based  $\beta$ -skeletons we analyze only one hyperbola (functions for clockwise and counterclockwise refractions are the same). Moreover, sets  $F(s_1, s, s_2)$  and  $F(s_2, s, s_1)$  are different. They contain pairs of parameters  $t_1, t_2$  corresponding to points generating discs such that each of them separately is intersected by the segment  $s$ . Therefore, we have to intersect those sets to obtain a set of pairs of parameters corresponding to points generating lunes intersected by  $s$  (see Figure 8).

**Theorem 4.** For  $\beta \geq 1$  the lune-based  $\beta$ -skeleton  $G_\beta(S)$  can be found in  $O(n^2 \lambda_4(n))$  time.



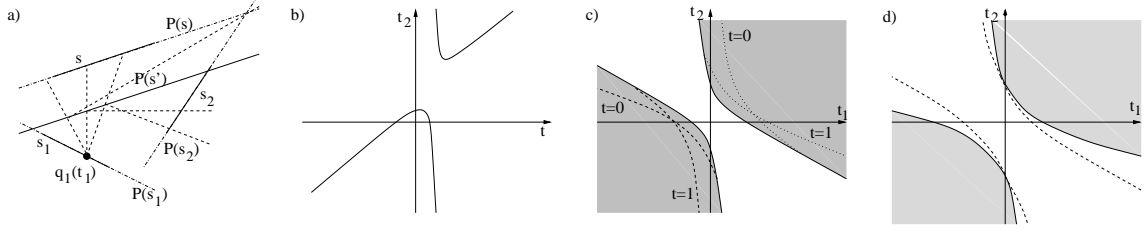

**Fig. 8.** An example of (a) a composition of three segments  $s_1, s_2, s$ , (b) correlations between variables  $t$  and  $t_2$  (parametrizing  $s$  and  $s_2$ , respectively), (c) the set  $F(s_1, s, s_2)$  and (d) the intersection  $F(s_1, s, s_2) \cap F(s_2, s, s_1)$ , where  $\beta > 1$ .

*Proof.*  $\beta$ -skeletons for  $\beta \geq 1$  satisfy the inclusions from Theorem 1. Hence, the number of tested edges is linear. For each such pair of segments  $s_1, s_2$  we compute the corresponding sets of pairs of points generating lunes that do not intersect segments from  $S \setminus \{s_1, s_2\}$ . Similarly as in Theorem 2 we can do it in  $O(n\lambda_4(n))$  time. Therefore, the total time complexity of the algorithm (after analysis of  $O(n)$  pairs of segments) is  $O(n^2\lambda_4(n))$ .

## 5 Computing Gabriel Graph for segments

In the previous sections we constructed sets of all pairs of points generating neighborhoods that do not intersect segments other than the segments containing generators. Now we want to find only  $O(n)$  pairs of generators (one pair for each edge of a  $\beta$ -skeleton) that define the graph. Let  $2 - VR(s_1, s_2)$  denote a region of the 2-order Voronoi diagram for the set  $S$  corresponding to  $s_1, s_2$  and  $3 - VR(s_1, s_2, s)$  denote a region of the 3-order Voronoi diagram for the set  $S$  corresponding to  $s_1, s_2, s$ . If an edge  $s_1s_2$ , where  $s_1, s_2 \in S$  belongs to the Gabriel Graph then there exists a disc  $D(p, r)$  centered in  $p$ , which does not contain points from  $S \setminus \{s_1, s_2\}$  and its diameter is  $v_1v_2$ , where  $v_1 \in s_1, v_2 \in s_2$  and  $2r = d(v_1, v_2)$ . The disc center  $p$  belongs to the set  $(2 - VR(s_1, s_2)) \cap (3 - VR(s_1, s_2, s))$  for some  $s \in S \setminus \{s_1, s_2\}$ .

First, for segments  $s_1, s_2 \in S$  we define a set of all middle points of segments with one endpoint on  $s_1$  and one on  $s_2$ . This set is a quadrilateral  $Q(s_1, s_2)$  (or a segment if  $s_1 \parallel s_2$ ) with vertices in points  $\frac{(x_i^1, y_i^1) + (x_j^2, y_j^2)}{2}$ , where  $(x_i^k, y_i^k)$  for  $i = 1, 2$  are endpoints of the segments  $s_k$  for  $k = 1, 2$  (boundaries of the set are determined by the images of  $s_1$  and  $s_2$  under four homotheties with respect to the ends of those segments and a ratio  $\frac{1}{2}$ ).

Let us analyze a position of a middle point of a segment  $l$  whose ends slide along the segments  $s_1, s_2 \in S$ . Let the length of  $l$  be  $2r$ . We rotate the plane so that segment  $s_1$  lies in the negative part of  $x$ -axis and the point of intersection of lines containing segments  $s_1$  and  $s_2$  (if there exists) is  $(0, 0)$ . Let the segment  $s_2$  lie on the line parametrized by  $u \cdot [x_1, y_1]$  for  $0 \geq x_1, 0 \leq y_1, 0 \leq u$ . Then the middle point of  $l$  is  $(x, y)$ , where  $x = -|\sqrt{r^2 - (\frac{uy_1}{2})^2}| + u \cdot x_1, y = \frac{uy_1}{2}$ .

Since  $(x - 2\frac{x_1}{y_1}y)^2 + (y)^2 = r^2 - (\frac{uy_1}{2})^2 + (\frac{uy_1}{2})^2 = r^2$ , then we have  $x^2 + y^2(1 + 4(\frac{x_1}{y_1})^2) - 4\frac{x_1}{y_1}xy = r^2$ , so all points  $(x, y)$  for a given  $r$  lie on an ellipse - see Figure 9.

We want to find a point  $p \in 3 - VR(s_1, s_2, s)$  which is a center of a segment  $v_1v_2$ , where  $v_1 \in s_1$  and  $v_2 \in s_2$ , and  $d(p, s) > \frac{d(v_1, v_2)}{2}$ . Then the disc with the center in  $p$  and the radius  $\frac{d(v_1, v_2)}{2}$  intersects only segments  $s_1, s_2$ , i.e., there exists an edge of  $GG(S)$  between  $s_1$  and  $s_2$ .

We need to examine two cases. First, we consider the situation when the closest to  $p$  point of a segment  $s$  belongs to the interior of  $s$ . Let  $P(s)$  be the line that contains segment  $s$ , which endpoints are  $(x_1^s, y_1^s)$  and  $(x_2^s, y_2^s)$ , and let  $q(t_s) = (x_1^s, y_1^s) + t_s \cdot [x_2^s - x_1^s, y_2^s - y_1^s]$  be the parametrization of  $P(s)$ .

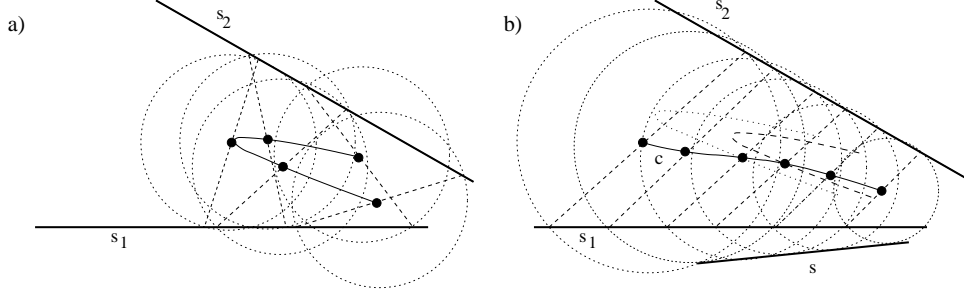

**Fig. 9.** (a) The set of middle points of segments  $v_1v_2$ , where  $v_1 \in s_1$  and  $v_2 \in s_2$  and (b) the curve  $c$  such that the distance between a point on the curve  $p$  and the segment  $s$  is equal to the length of the radius of a corresponding disc centered in  $p$ .

Let  $L(s, r)$  be a line parallel to  $P(s)$  with parametrization  $l(t_L) = (x_1^L, y_1^L) + t_L \cdot [x_2^s - x_1^s, y_2^s - y_1^s]$  such that the distance between  $P(s)$  and  $L(s, r)$  is equal to  $r$ . We compute the intersection of the ellipse  $x^2 + y^2(1 + 4(\frac{x_1}{y_1})^2) - 4\frac{x_1}{y_1}xy = r^2$  and the line  $L(s, r)$ . The result is  $[x_1^L + t_L(x_2^s - x_1^s)]^2 + [y_1^L + t_L(y_2^s - y_1^s)]^2 - 4\frac{x_1}{y_1}[x_1^L + t_L(x_2^s - x_1^s)][y_1^L + t_L(y_2^s - y_1^s)] = r^2$ , so  $t_L$  satisfies an equation  $At_L^2 + Bt_L + C = r^2$  where coefficients  $A, B, C$  are fixed and depend on  $x_1, y_1, x_i^s, x_i^L, y_i^s, y_i^L$  for  $i = 1, 2$ . This equation defines a curve  $c$  (see Figure 9) which intersects corresponding ellipses. A point  $p$  which belongs to a part of the ellipse that lies on the opposite side of the curve  $c$  than the segment  $s$  is a center of a disc which has a diameter  $v_1v_2$ , where  $v_1 \in S_1, v_2 \in S_2$ , and does not intersect segment  $s$ .

In the second case one of the endpoints of the segment  $s$  is the nearest point to  $p$  (among the points from  $s$ ). Let  $D_1(r)$  and  $D_2(r)$  be discs with diameter  $r$  and with centers in corresponding ends of the segment  $s$ . We compute the intersection of  $D_1(r) = \{(x, y) : (x_1^s - x)^2 + (y_1^s - y)^2 = r^2\}$  ( $D_2(r) = \{(x, y) : (x_2^s - x)^2 + (y_2^s - y)^2 = r^2\}$ , respectively) and ellipse  $x^2 + y^2(1 + 4(\frac{x_1}{y_1})^2) - 4\frac{x_1}{y_1}xy = r^2$ . We obtain  $x_1^s(x_1^s - 2x) + y_1^s(y_1^s - 2y) - y^2(\frac{x_1}{y_1})^2 + 4(\frac{x_1}{y_1})xy = 0$ , so  $x = \frac{N_1y^2 + N_2y + N_3}{N_4y + N_5}$  and  $y$  satisfies an equation  $M_1y^4 + M_2y^3 + M_3y^2 + M_4y + M_5 = 0$  where coefficients  $N_i$  and  $M_j$  for  $i, j = 1, \dots, 5$  depend on  $x_1^s, y_1^s, x_1, y_1, r$  (or on  $x_2^s, y_2^s, x_1, y_1, r$ , respectively). If there exists a point  $p \notin D_1(r) \cup D_2(r)$  that belongs to the part of the ellipse between the segments  $s_1, s_2$ , then there also exists a disc with center in  $p$  and a diameter  $d(v_1, v_2) = 2r$ , where  $v_1 \in s_1$  and  $v_2 \in s_2$ , which does not contain ends of the segment  $s$ .

In both cases we obtain a curve  $c(r)$  dependent on the parameter  $r$  - see Figure 9. We check if a set  $Q(s_1, s_2) \cap (2 - VR(s_1, s_2)) \cap (3 - VR(s_1, s_2, s))$  and the segment  $s$  are on the same side of the curve  $c$ . Otherwise, the segment  $s_1s_2$  belongs to the Gabriel Graph for the set  $S$  (i.e., there exists a point  $p$  which is the center of a segment  $v_1v_2$ , where  $v_1 \in s_1, v_2 \in s_2$ , and  $d(p, s) > \frac{d(v_1, v_2)}{2}$  for all  $s \in S \setminus \{s_1, s_2\}$ ).

**Theorem 5.** For a set of  $n$  segments  $S$  the Gabriel Graph  $GG(S)$  can be computed in  $O(n \log n)$  time.

*Proof.* The 2-order Voronoi diagram and the 3-order Voronoi diagram can be found in  $O(n \log n)$  time [16]. The number of triples of segments we need to test is linear. For each such triple we can check if there exists an empty 1-skeleton lune in time proportional to the complexity of the set  $Q(s_1, s_2) \cap (2 - VR(s_1, s_2)) \cap (3 - VR(s_1, s_2, s))$ . The total complexity of those sets is  $O(n)$ . Hence, the complexity of the algorithm is  $O(n) + O(n \log n) = O(n \log n)$ .

## 6 Conclusions

The running time of the presented algorithms for  $\beta$ -skeletons for sets of  $n$  line segment ranges between  $O(n \log n)$ ,  $O(n^2 \alpha(n) \log n)$  and  $O(n^3 \lambda_4(n))$  and depends on the value of  $\beta$ . For  $0 < \beta < 1$  the  $\beta$ -skeleton is not related to the Delaunay triangulation of the underlying set of segments. The existence of a relatively efficient algorithm for the Gabriel Graph suggests that it may be possible to find a faster way to compute  $\beta$ -skeletons for other values of  $\beta$ , especially for  $1 \leq \beta \leq 2$ .

The edges of the Delaunay triangulation for line segments can be represented in the form described in this paper as rectangles contained in  $[0, 1] \times [0, 1]$  square in the  $t_1, t_2$ -coordinate system. If for each pair of  $\beta$ -skeleton edges the intersection of the corresponding sets for the  $\beta$ -skeleton and the Delaunay triangulation is not empty then there exist a plane partition generated by some pairs of generators of  $\beta$ -skeleton neighborhoods. Unfortunately, it is not always possible (see Figure 12 in the Appendix).

The algorithms shown in this work for each pair of segments find such a position of generators that the corresponding lune does not intersect any other segment. We could consider a problem in which the number of used generators of neighborhoods is  $n$  (one generator per each edge). Then the method described in the paper can also be used. We analyze a  $n$ -dimensional space and test if  $[0, 1]^n \setminus \bigcup_{s_i, s_j \in S, s \in S \setminus \{s_i, s_j\}} F(s_i, s, s_j) \times R^{n-2} \neq \emptyset$ , where  $i$  and  $j$  also define corresponding coordinates in  $R^n$ . Unfortunately, such an algorithm is expensive. However, in this case a  $\beta$ -skeleton already generates a plane partition.

The total kinetic problem that can be solved in similar way is a construction  $\beta$ -skeletons for points moving rectilinear but without limitations concerning intersections of neighborhoods with lines defined by the moving points. In this case the form of sets  $F(s_i, s, s_j)$  changes and the solution is much more complicated.

Are there any more effective algorithms for those problems?

Additional interesting questions about  $\beta$ -skeletons are related to their connections with  $k$ -order Voronoi diagrams for line segments.

### Acknowledgments

The authors would like to thank Jerzy W. Jaromczyk for important comments.

## References

1. O. Aichholzer, F. Aurenhammer, *Straight Skeletons for General Polygonal Figures in the Plane*, *Proceedings of 2nd Computing and Combinatorics Conference (COCOON)*, 1996, 117-126
2. M. Brévilier, N. Chevallier, D. Schmitt, *Triangulations of line segment sets in the plane*, *Proceedings of the 27th international Conference on Foundations of Software Technology and Theoretical Computer Science*, 2007, 388-399
3. Ch. Burnikel, K. Mehlhorn, S. Schirra, *How to compute the Voronoi diagram of line segments: Theoretical and experimental results*, *Proceedings of 2nd Annual European Symposium On Algorithms (ESA)*, 1994, 227-239
4. L.P. Chew, K. Kedem, *Placing the largest similar copy of a convex polygon among polygonal obstacles* *Proceedings of the 5th Annual ACM Symposium on Computational Geometry*, 1989, 167-174
5. D. Eppstein,  *$\beta$ -skeletons have unbounded dilation*, *Computational Geometry*, vol. 23, 2002, 43-52
6. J. E. Goodman, J. O'Rourke, *Handbook of Discrete and Computational Geometry*, Chapman & Hall/CRC, 2004
7. K.R. Gabriel, R.R. Sokal, *A new statistical approach to geographic variation analysis*, *Systematic Zoology* 18, 1969, 259-278
8. J. Hershberger, *Finding the Upper Envelope of  $n$  Line Segments in  $O(n \log n)$  Time*, *Information Processing Letters*, 33(4), 1989, 169-174
9. F. Hurtado, G. Liotta, H. Meijer, *Optimal and suboptimal robust algorithms for proximity graphs*, *Computational Geometry: Theory and Applications* 25 (1-2), 2003, 35-49.
10. J.W. Jaromczyk, M. Kowaluk, *A note on relative neighborhood graphs*, *Proceedings of the 3rd Annual Symposium on Computational Geometry*, Canada, Waterloo, ACM Press, 1987, 233-241

11. J.W. Jaromczyk, G.T. Toussaint, *Relative neighborhood graphs and their relatives*, *Proceedings of the IEEE*, volume 80, issue 9, 1992, 1502-1517
12. D.G. Kirkpatrick, J.D. Radke, *A framework for computational morphology*, *Computational Geometry*, North Holland, Amsterdam, 1985, 217-248
13. M. Kowaluk, *Planar  $\beta$ -skeleton via point location in monotone subdivision of subset of lunes*, EuroCG 2012, Italy, Assisi, 2012, 225-227
14. A. Lingas. *A linear-time construction of the relative neighborhood graph from the Delaunay triangulation*, *Computational Geometry* 4, 1994, 199-208
15. D.W. Matula, R.R. Sokal, *Properties of Gabriel graphs relevant to geographical variation research and the clustering of points in plane*, *Geographical Analysis* 12, 1984, 205-222
16. E. Papadopoulou, M. Zavershynskiy, *A Sweepline Algorithm for Higher Order Voronoi Diagrams*, *Proceedings of 10th International Symposium on Voronoi Diagrams in Science and Engineering (ISVD)*, 2013, 16-22
17. M. Sharir, P.K. Agarwal, *Davenport-Schinzel Sequences and Their Geometric Applications*, Cambridge University Press, 1995
18. K.J. Supowit, *The relative neighborhood graph, with an application to minimum spanning trees*, *Journal of the ACM* volume 30, issue 3, 1983, 428-448
19. G.T. Toussaint, *The relative neighborhood graph of a finite planar set*, *Pattern Recognition* 12, 1980, 261-268

## 7 Appendix

### 7.1 Coefficients used in Section 3:

$$M = (y_2 - y_1)(A_1 \cos \delta + A_2 \sin \delta) - (x_2 - x_1)(-A_1 \sin \delta + A_2 \cos \delta), \quad N = (y_2^2 - y_1^2)(A_1 \cos \delta + A_2 \sin \delta).$$

### 7.2 Polynomials computed in Section 3:

$$p_1(t_1) = [(B_1 \cos \delta + B_2 \sin \delta)(y_2 - y_1) + (x_2^2 - x_1^2)(-A_1 \sin \delta + A_2 \cos \delta) - (x_2 - x_1)(-B_1 \sin \delta + B_2 \cos \delta)]t_1 + (A_1 \cos \delta + A_2 \sin \delta)(y_1 - y_1^2) - (x_2 - x_1)(-C_2 \cos \delta + C_2 \cos \delta) + (x_1^2 - x_1)(-A_1 \sin \delta + A_2 \cos \delta),$$

$$p_2(t_1) = (x_2^2 - x_1^2)(-B_1 \sin \delta + B_2 \cos \delta)t_1^2 + [(B_1 \cos \delta + B_2 \sin \delta)(y_1 - y_1^2) + (x_1^2 - x_1)(-B_1 \sin \delta + B_2 \cos \delta) + (x_2^2 - x_1^2)(-C_1 \sin \delta + C_2 \cos \delta)]t_1 + (C_1 \cos \delta + C_2 \sin \delta)(y_1 - y_1^2) + (x_1^2 - x_1)(C_1 \sin \delta + C_2 \cos \delta),$$

$$p_3(t_1) = (y_2^2 - y_1^2)(B_1 \cos \delta + B_2 \sin \delta)t_1 + (y_2^2 - y_1^2)(C_1 \cos \delta + C_2 \sin \delta).$$

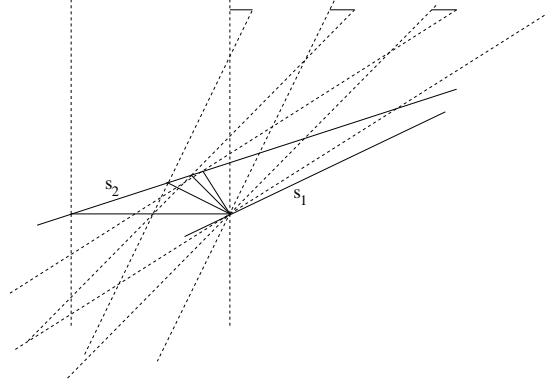

**Fig. 10.** An example of a set  $S$  (for  $\beta$  close to infinity) where the same point in  $s_1$  generates lunes which correspond to points in different connected components of  $[0, 1] \times [0, 1] \setminus \bigcup_{s \in S \setminus \{s_1, s_2\}} F(s_1, s, s_2)$ .

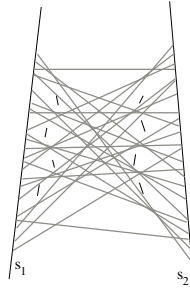

**Fig. 11.** An example of a set  $S$  where for segments  $s_1, s_2$  the difference  $[0, 1] \times [0, 1] \setminus \bigcup_{s \in S \setminus \{s_1, s_2\}} F(s_1, s, s_2)$  contains  $\Omega(n^2)$  connected components (for a very small  $\beta$ ).

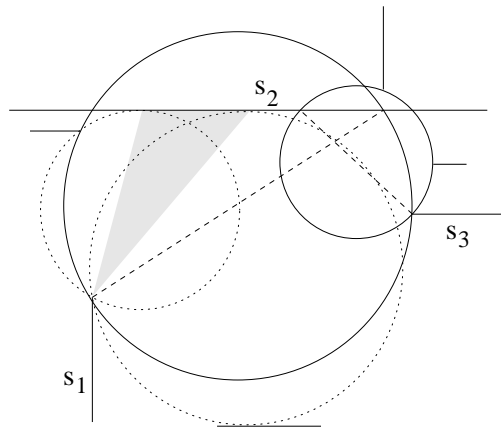

**Fig. 12.** An example of a set  $S$  where for segments  $s_1, s_2$  there is no such Gabriel Graph neighborhood that the diameter of the disc defining this neighborhood is contained in the Delaunay Triangulation edge  $s_1s_2$  (the light grey area) even though the edge  $s_1s_2$  belongs to the Gabriel Graph for  $S$ . Moreover, generators of the neighborhoods of the  $GG$ -edges  $s_1s_2$  and  $s_2s_3$  create intersecting diameters between corresponding line segments.