

INFINITELY MANY KNOTS ADMITTING THE SAME INTEGER SURGERY AND A 4-DIMENSIONAL EXTENSION

TETSUYA ABE, IN DAE JONG, JOHN LUECKE, AND JOHN OSOINACH

ABSTRACT. We prove that for any integer n there exist infinitely many different knots in S^3 such that n -surgery on those knots yields the same 3-manifold. In particular, when $|n| = 1$ homology spheres arise from these surgeries. This answers Problem 3.6(D) on the Kirby problem list. We construct two families of examples, the first by a method of twisting along an annulus and the second by a generalization of this procedure. The latter family also solves a stronger version of Problem 3.6(D), that for any integer n , there exist infinitely many mutually distinct knots such that 2-handle addition along each with framing n yields the same 4-manifold.

1. INTRODUCTION

Dehn surgery on knots is a long-standing technique for the construction of 3-manifolds. While well-known theorems of Lickorish [14] and Wallace [19] state that every orientable 3-manifold can be obtained by Dehn surgery on some link in S^3 , this representation is far from unique. In particular, in the Kirby problem list [12], Clark asks the following:

Problem 3.6(D). Fix an integer n . Is there a homology 3-sphere (or any 3-manifold) which can be obtained by n -surgery on an infinite number of distinct knots?

In [16], the parenthetical version of this question was answered affirmatively by constructing knots using the method of twisting along an annulus. This method was subsequently developed in [18] to construct infinitely many knots yielding a small Seifert-fibered manifold. In [16], the surgery slope is 0, and in [13],[18] and [5] the surgery slopes are multiples of 4.

In Section 2, we use the annular twist construction to create, for each integer n , an infinite family of distinct knots in S^3 such that n -surgery on each knot in the collection yields the same manifold (Theorem 2.2). When $|n| = 1$, the resulting manifold is a homology sphere thereby answering affirmatively Problem 3.6(D) above. The members of each infinite family are distinguished by their hyperbolic volume. Alternatively, at least when $n \neq 0$, the knots in a family are shown to be different by proving that the bridge numbers tend to infinity as the number of twists along the annulus increases.

In [1], a 4-dimensional extension of Problem 3.6(D) was proposed as follows:

Problem 1.1. *Let n be an integer. Find infinitely many mutually distinct knots K_1, K_2, \dots such that $X_{K_i}(n) \approx X_{K_j}(n)$ for each $i, j \in \mathbb{N}$.*

2010 *Mathematics Subject Classification.* 57M25, 57M27, 57R65.

Key words and phrases. annulus twist; Dehn surgery; Kirby calculus; knot; 2-handle addition, 3-manifolds, smooth 4-manifolds.

Here $X_K(n)$ denotes the smooth 4-manifold obtained from the 4-ball B^4 by attaching a 2-handle along K with framing n , and the symbol \approx stands for a diffeomorphism.

In Section 3, we generalize the annulus twist method in a somewhat surprising way to produce a different family of knots answering Problem 3.6(D). Furthermore, this family solves Problem 1.1 affirmatively as follows.

Theorem 1.2. *For every $n \in \mathbb{Z}$, there exist distinct knots J_0, J_1, J_2, \dots such that*

$$X_{J_0}(n) \approx X_{J_1}(n) \approx X_{J_2}(n) \approx \dots$$

The knots J_0 and J_1 in Theorem 1.2 (for $n > 0$) are depicted in Figure 1, where the rectangle labelled n stands for n right-handed full twists. Note that J_0 is the knot 8_{20} in Rolfsen's table [17]. The members of each infinite family are distinguished by their Alexander polynomials when $n \neq 0$. When $n = 0$, they are distinguished by hyperbolic volume (see [1]).

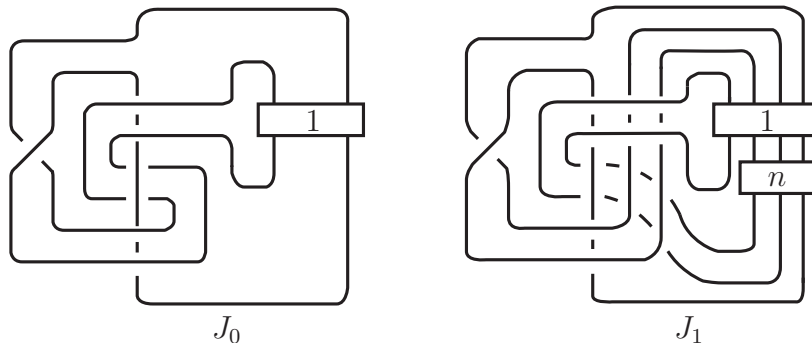

FIGURE 1. The knots J_0 and J_1 such that $X_{J_0}(n) \approx X_{J_1}(n)$.

Acknowledgments. The first and second authors would like to express their gratitude to Yuichi Yamada and other participants of the handle seminar organized by Motoo Tange. Section 3 would not have arisen without Yamada's interest in annulus twists. The third and fourth authors would like to thank Kyle Larson for very helpful conversations, and Neil Hoffman for his help with HIKMOT. The authors also thank the referees for careful reading of our draft and helpful suggestions. The first author was supported by JSPS KAKENHI Grant Number 13J05998.

2. FIRST FAMILY OF KNOTS

The Dehn surgeries on a knot, K , in the 3-sphere are parameterized by their surgery slopes. These surgery slopes are described by $p/q \in \mathbb{Q} \cup \{\infty\}$, meaning that the slope is a curve that runs p times meridionally and q times longitudinally (using the preferred longitude) along the boundary of the exterior of K . We write $M_K(p/q)$ for the p/q Dehn surgery on K . In this notation, an n -surgery on K refers to the integer surgery $M_K(n/1) = M_K(n)$.

Definition 2.1. Let $\mathcal{L} = k \cup l_1 \cup l_2 \cup l_3$ be the link pictured in Figure 2. Let $\mathcal{L}(\alpha, \beta, \delta, \gamma)$ be the corresponding Dehn surgery on \mathcal{L} . Here the surgery slopes $\alpha, \beta, \delta, \gamma$ will be either in $\mathbb{Q} \cup \{\infty\}$, using the meridian-longitude coordinates on the boundary of a knot in S^3 (with

a right-handed orientation on S^3), or an asterisk, meaning that no surgery is done on that component and the component is seen as a knot in the surgered manifold. (We use the notation $\mathcal{L}(\alpha, \beta, \delta, \gamma)$ rather than $M_{\mathcal{L}}(\alpha, \beta, \delta, \gamma)$, because, when there are asterisks among the arguments, this denotes a link in the surgered manifold.)

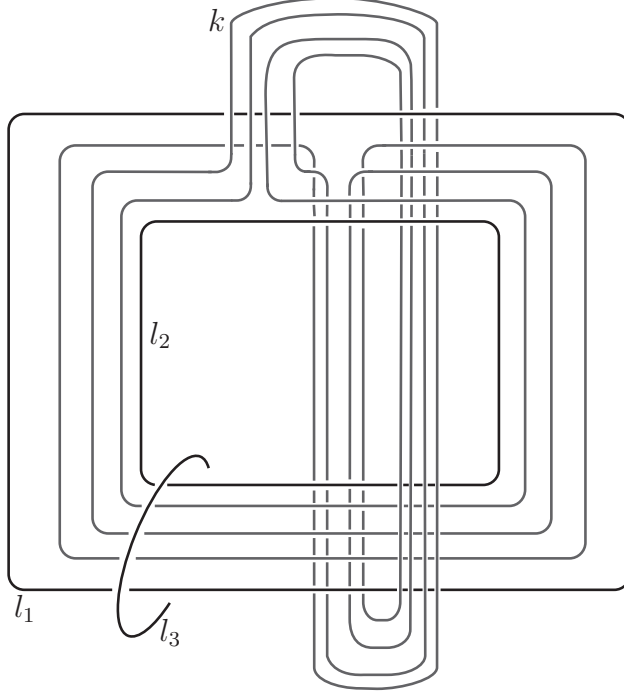

FIGURE 2. The link \mathcal{L}

The main result of this section, giving our first family of knots by surgery on the link \mathcal{L} , is the following theorem.

Theorem 2.2. *For integers m, n , $k_n^m = \mathcal{L}(*, -1/m, 1/m, -1/n)$ is a knot in S^3 . Furthermore $M_{k_n^{m_1}}(n)$ is homeomorphic to $M_{k_n^{m_2}}(n)$ for any integers m_1, m_2 .*

- (1) *For a fixed $n \neq 0$, the bridge number of k_n^m tends to infinity as m tends to infinity.*
- (2) *For any integer n , there is a $C_n > 0$ such that if $m_2 > m_1 > C_n$, then $k_n^{m_1}$ and $k_n^{m_2}$ are hyperbolic knots with the hyperbolic volume of $k_n^{m_2}$ larger than that of $k_n^{m_1}$.*

In particular, for each integer n there are infinitely many different knots in the family $\{k_n^m\}$.

Proof.

We first show that for any integer n , the n -surgery on each k_n^m yields the same manifold for each m . Figure 3 shows that the knot k is a non-separating, orientation-preserving curve on a twice-punctured Klein bottle, Q , cobounded by l_1 and l_2 and in the complement of l_3 .

Thus $Q - \text{Nbhd}(\mathcal{L})$ is a 4-punctured sphere, P , properly embedded in the exterior, $E_{\mathcal{L}}$, of \mathcal{L} in S^3 . The boundary of P has one component on each of $\partial \text{Nbhd}(l_1)$ and $\partial \text{Nbhd}(l_2)$ of slope 0/1 and two components on $\partial \text{Nbhd}(k)$ of slope 0/1. To check that the slope of P on $\partial \text{Nbhd}(k)$ is 0/1, one can verify that the linking number of such a boundary component is

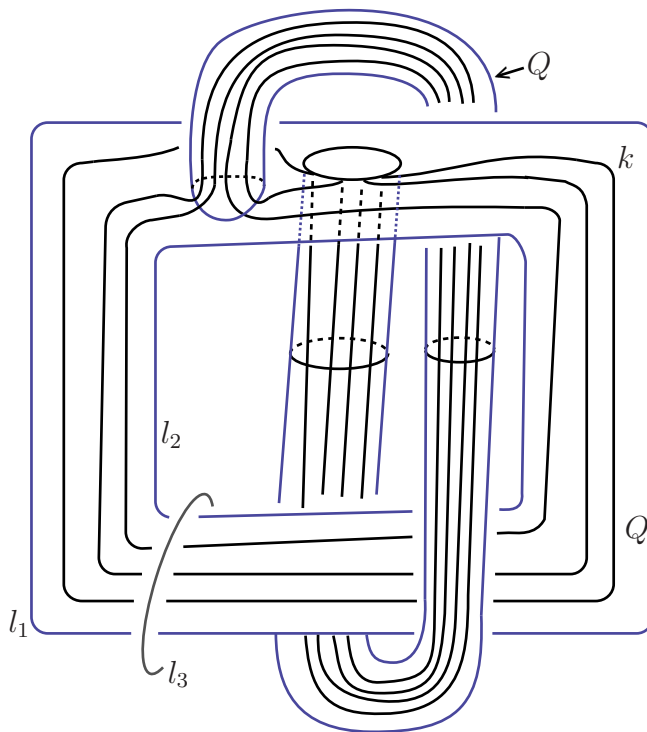

FIGURE 3. The 2-punctured Klein bottle Q containing k

zero with respect to k . To do this, it is convenient to use P as in the proof of Claim 2.4, below, when $m = n = 0$.

Let \widehat{P} be the properly embedded annulus in the exterior of $\mathcal{L}(0/1, *, *, *)$ obtained by capping off the two components of P along $\partial \text{Nbhd}(k)$. Dehn twisting this exterior along the annulus \widehat{P} m times (see Remark 2.3), induces a homeomorphism of the 3-manifolds $\mathcal{L}(0/1, -1/m, 1/m, -1/n)$ and $\mathcal{L}(0/1, -1/0, 1/0, -1/n)$ for each m, n .

Remark 2.3. Let A be an annulus embedded in a 3-manifold M with ∂A the link $L_1 \cup L_2$ in M . Let $A' = A \cap (M - \text{Nbhd}(L_1 \cup L_2))$. Fix an orientation on M . Pick an orientation on A . This induces an orientation on L_i and its meridian μ_i . Let $A \times [0, 1]$ be a product neighborhood of A in M so that the corresponding interval orientation on $A' \times [0, 1]$ corresponds to the meridian orientation of L_1 . Pick coordinates $A = e^{2\pi i \theta} \times [0, 1]$, with $\theta \in [0, 1]$, so that $e^{2\pi i \theta} \times \{0\}$, $\theta \in [0, 1]$, is the oriented L_1 . Define the homeomorphism $f_m: A \times [0, 1] \rightarrow A \times [0, 1]$ by $(e^{2\pi i \theta}, s, t) \mapsto (e^{2\pi i(\theta + mt)}, s, t)$. Note that f_m restricted to $A \times \{0, 1\}$ is the identity. Let A be as above and K be a knot in M which intersects $A \times [0, 1]$ in $[0, 1]$ fibers. Let K^m be the knot in M obtained by applying f_m to $K \cap (A \times [0, 1])$ (and the identity on K outside this region). We say that K^m is obtained from K by *twisting along A (m times)*, or that K^m is obtained from K by applying an *m -fold annulus twist along A* . In particular, we say that K^1 is the result of applying to K an *annulus twist along A* . Note that the sign of m above depends only on the orientation of M and on the labeling, L_1 and L_2 , of ∂A . The above agrees with the notion of an annulus twist along A in [2, Section 2], where $M = S^3$ with a right-handed orientation, A is a planar annulus, L_1 is the outside boundary of A ,

and L_2 is the inside boundary of A . The manifolds M with which we are working are S^3 or Dehn surgeries on S^3 . Our convention, is to take the right-handed orientation of S^3 and the induced orientation on these Dehn surgeries. Furthermore, note that f_m induces a homeomorphism $h_m: M - \text{Nbhd}(L_1 \cup L_2) \rightarrow M - \text{Nbhd}(L_1 \cup L_2)$ by applying f_m in $A' \times [0, 1]$ along with the identity outside this neighborhood. We refer to this homeomorphism h_m of $M - \text{Nbhd}(L_1 \cup L_2)$ as *Dehn-twisting along A' (m times)*. In this case, A' is properly embedded.

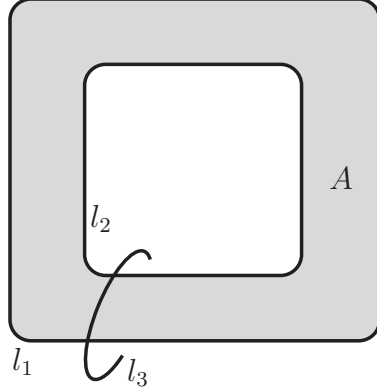

FIGURE 4. The annulus A bounded by $l_1 \cup l_2$

Figure 4 shows an annulus A cobounded by l_1 and l_2 in the complement of l_3 (which can be taken to intersect k algebraically zero and geometrically four times and which induces the framing $0/1$ on each of l_1 and l_2), which becomes an annulus A_n cobounded by l_1 and l_2 after $-1/n$ surgery on l_3 . Dehn-twisting the exterior of $l_1 \cup l_2$ in $\mathcal{L}(*, *, *, -1/n)$ along A_n ($-m$) times (really the restriction of A_n to this exterior, Remark 2.3) induces an orientation-preserving homeomorphism of the manifold $\mathcal{L}(1/0, -1/0, 1/0, -1/n) = S^3$ to the manifold $\mathcal{L}(1/0, -1/m, 1/m, -1/n)$. The inverse of this homeomorphism identifies k_n^m as a knot in S^3 obtained from k_n^0 by twisting along A_n m times (see Remark 2.3).

The following claim finishes the argument that the n -surgeries on k_n^m are the same manifold.

Claim 2.4. *For each m, n , $\mathcal{L}(0/1, -1/m, 1/m, -1/n) = M_{k_n^m}(n)$.*

Proof of Claim 2.4: $\mathcal{L}(0/1, -1/m, 1/m, -1/n)$ is clearly a surgery on k_n^m . Our goal is to identify the slope of this surgery, $\alpha(m, n)$, in terms of the coordinates on k_n^m as a knot in S^3 . Let P_n be the 4-punctured sphere P after $-1/n$ surgery on l_3 . Then $\alpha(0, n)$ is the slope of P_n on k_n^0 .

Twisting k_n^0 along A_n induces a homeomorphism of the exterior of $l_1 \cup l_2 \cup k_n^0$ in S^3 to the exterior of $l_1 \cup l_2 \cup k_n^m$ and consequently takes P_n to a 4-punctured sphere P_n^m in the exterior of $l_1 \cup l_2 \cup k_n^m$. The slope $\alpha(m, n)$ is the slope of P_n^m on k_n^m . We may use P_n^m to compute the linking number of the slope $\alpha(m, n)$ with k_n^m and consequently the coordinates of the slope. Orient k_n^m and take the orientation on P_n^m that induces an orientation on $\partial P_n^m \cap \text{Nbhd}(k_n^m)$

that agrees with that on k_n^m . Then twice the linking number of $\alpha(m, n)$ with the oriented k_n^m in S^3 is the negative of the linking number between the oriented k_n^m and $l_1 \cup l_2$, given the orientation induced by P_n^m on $l_1 \cup l_2$. By considering k_n^m as twisting k_n^0 along A_n away from $l_1 \cup l_2$, one sees that this latter linking number is $-2n$ (one may verify that in the $1/0$ surgery on l_3 , this linking number is zero, then observe how the linking number changes under $-1/n$ surgery). Thus $\alpha(m, n)$ is the slope $n/1$ as desired.

□ (Claim 2.4)

Claim 2.5. *Let E_n be the exterior of $\mathcal{L}(*, *, *, -1/n)$ and T_1, T_2 be the components of ∂E_n coming from $\text{Nbhd}(l_1), \text{Nbhd}(l_2)$, respectively. For each integer $n \neq -2$, the interior of E_n is hyperbolic. For every integer n (including -2), there is no essential annulus properly embedded in E_n with one boundary component on T_1 and the other on T_2 .*

Proof of Claim 2.5: SnapPy [7] shows that \mathcal{L} is hyperbolic. The program HIKMOT [11] certifies this calculation. The sequence of isotopies Figure 5(a)-(c) shows that l_1 in $\mathcal{L}(*, *, *, 1/2)$ is a $(2, -1)$ -cable on the knot l'_1 pictured in Figure 5(d) (the 3-manifold H in Figure 5 is a neighborhood of the punctured Klein bottle Q and l_1 is pushed off H). Because the linking number of l'_1 with k is one, the exterior of $k \cup l_1 \cup l_2$ in $\mathcal{L}(*, *, *, 1/2)$ is toroidal. It follows from [9] and [10] that the interior of E_n is hyperbolic as long as $|n + 2| > 3$.

For $n \in \{1, 0, -1, -3, -4, -5\}$, SnapPy shows that E_n is hyperbolic and HIKMOT certifies this calculation. Thus the interior of E_n is hyperbolic, and in particular E_n is anannular, as long as $n \neq -2$.

We must still show that E_{-2} is anannular. As mentioned above, Figure 5(d) shows that E_{-2} is the union, along a torus T , of the exterior of a $(2, -1)$ -cable of the core of a solid torus and the exterior, E'_{-2} , of $l'_1 \cup l_2 \cup k$ after $1/2$ surgery on l_3 . SnapPy shows E'_{-2} is hyperbolic and HIKMOT certifies this. Now assume that there were an essential annulus in E_{-2} between T_1 and T_2 , and consider its intersection with the incompressible torus T . We may surger away any closed curves of intersection which are trivial on T . Then an outermost component of intersection with E'_{-2} will give rise to an essential annulus or disk properly embedded in E'_{-2} , contradicting the hyperbolicity of E'_{-2} .

□ (Claim 2.5)

We first verify (1) of Theorem 2.2. As before, let A_n be the annulus from Figure 4 cobounded by l_1 and l_2 and after $-1/n$ surgery on l_3 . The knot k_n^m is obtained by twisting k along A_n (m times) in the copy of S^3 obtained by $-1/n$ surgery on l_3 . As the linking number of l_1 and l_2 in this copy of S^3 is n , $l_1 \cup l_2$ is not the trivial link. Then Claim 2.5 along with Corollary 1.4 of [5] shows that for $n \neq 0$ the (genus 0) bridge number of the knots k_n^m in S^3 goes to infinity as m goes to infinity (as the linking number of l_1 and l_2 is non-zero, Lemma 2.4 of [5] shows there is a catching surface for the pair (A_n, k)). Note that since A_0 lies on a Heegaard sphere for S^3 , the bridge numbers of $\{k_0^m\}$ will be bounded.

We now verify (2) of Theorem 2.2. By Claim 2.5, the interior of E_n is hyperbolic whenever $n \neq -2$. Thurston's Dehn Surgery Theorem and Theorem 1A of [15] shows that there is an $C_n > 0$ such that for $m > C_n$, k_n^m is hyperbolic and its volume increases monotonically with m . When $n = -2$, recall from the proof of Claim 2.5 that Figure 5(d) shows that E_{-2}

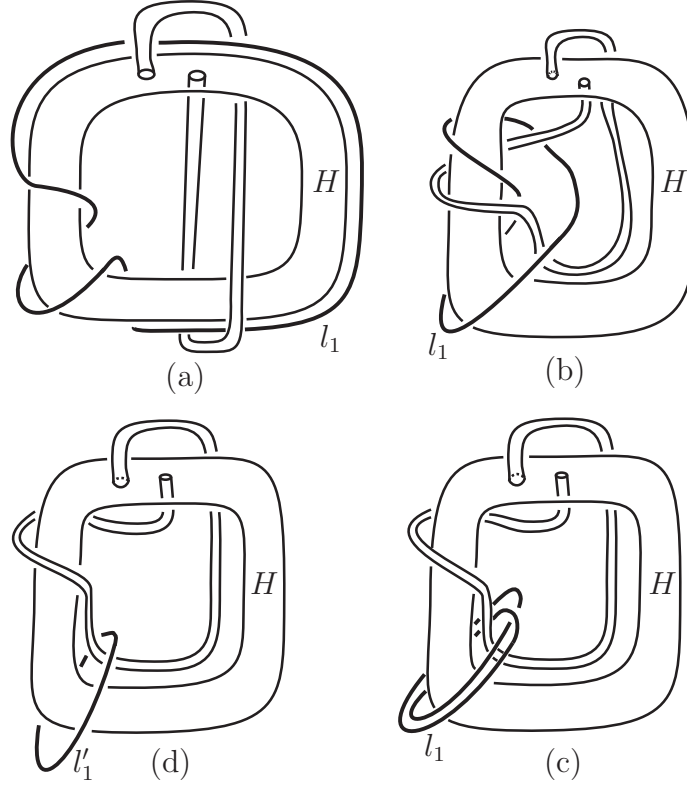

FIGURE 5. l_1 in $\mathcal{L}(*, *, *, 1/2)$ is a $(2, -1)$ -cable on l'_1

is the union, along a torus T , of the exterior of a $(2, -1)$ -cable of the core of a solid torus, and the exterior, E'_{-2} , of $l'_1 \cup l_2 \cup k$ after $1/2$ surgery on l_3 . That is, identify $\mathcal{L}(*, *, *, 1/2)$ as a link in S^3 by putting two full left-handed twists along the linking circle l_3 . Then $\mathcal{L}(*, -1/m, 1/m, 1/2)$ corresponds to $(-1 - 2m)/m$ surgery on l_1 and $(1 - 2m)/m$ surgery on l_2 . The Seifert fiber on l_1 as a $(2, -1)$ -cabling on l'_1 is $-2/1$. As the surgery slope intersects this Seifert fiber slope once, this surgery on l_1 corresponds to doing a $(-1 - 2m)/4m$ surgery on l'_1 (see Corollary 7.3 of [8]). As noted above, HIKMOT verifies $k \cup l'_1 \cup l_2$ to be hyperbolic. Thus, an application of Theorem 1A of [15] to the exterior E_{-2} of this link, shows there is a C_{-2} such that for $m > C_{-2}$, k_{-2}^m is hyperbolic and its volume increases monotonically with m .

Since hyperbolic volume and bridge number are knot invariants, either (1) (when $n \neq 0$) or (2) shows that for an integer n the family $\{k_n^m\}$ is infinite.

□ (Theorem 2.2)

Remark 2.6. SnapPy shows the homology spheres that arise in the above construction ($|n| = 1$) to be hyperbolic manifolds with $\text{volume}(M_{k_{\emptyset_1}^0}(-1)) = 3.400436870$ and $\text{volume}(M_{k_{\emptyset_1}^0}(1)) = 5.7167678901$. SnapPy shows the manifold corresponding to $n = -2$ to be hyperbolic with $\text{volume}(M_{k_{\emptyset_2}^0}(-2)) = 3.110698158$. These calculations are not verified by HIKMOT.

The next section shows, for each n , other infinite families of knots that admit the same n -surgery. We show that in fact the 4-manifolds obtained by attaching a 2-handle to the

4-ball along each of the knots in one of these families are diffeomorphic. We do not know if the same holds for the above family $\{k_n^m\}$.

Question *Let n be an integer. Are the 4-manifolds $X_{k_n^i}(n)$ and $X_{k_n^j}(n)$ diffeomorphic?*

3. SECOND FAMILY OF KNOTS

We generalize the annulus twist and provide a framework for creating knots yielding the same 4-manifold. Problem 1.1 is solved by applying the framework to the knot 8_{20} .

This section is organized as follows: In subsection 3.1, we recall the definition of an annulus presentation of a knot and introduce the notion of a “simple” annulus presentation. We define a new operation $(*n)$ on an annulus presentation, which is a generalization of an annulus twist. For a knot K with an annulus presentation and an integer n , we construct a knot K' (with an annulus presentation) such that $M_K(n) \approx M_{K'}(n)$ by using the operation $(*n)$ (Theorem 3.7). In subsection 3.2, for a knot K with a simple annulus presentation and any integer n , we construct a knot K' (with a simple annulus presentation) such that $X_K(n) \approx X_{K'}(n)$ by using the operation $(*n)$ (Theorem 3.10). Note that the two knots K and K' are possibly the same. In subsection 3.3, we introduce the notion of a “good” annulus presentation, and show that, for a given knot with a good annulus presentation, the infinitely many knots constructed by using the operation $(*n)$ have mutually distinct Alexander polynomials when $n \neq 0$ (Theorem 3.13). This yields Theorem 1.2 as an immediate corollary.

3.1. Construction of knots.

3.1.1. *Annulus presentation.* We recall the definition of an annulus presentation¹ of a knot from [1, 2]. Let $A \subset \mathbb{R}^2 \cup \{\infty\} \subset S^3$ be a trivially embedded annulus with an ε -framed unknot c in S^3 as shown in the left side of Figure 6, where $\varepsilon = \pm 1$. Take an embedding of a band $b: I \times I \rightarrow S^3$ such that

- $b(I \times I) \cap \partial A = b(\partial I \times I)$,
- $b(I \times I) \cap \text{int}A$ consists of ribbon singularities, and
- $b(I \times I) \cap c = \emptyset$,

where $I = [0, 1]$. Throughout this paper, we assume that $A \cup b(I \times I)$ is orientable. This assumption implies that the induced framing is zero (see [1]). Unless otherwise stated, we also assume for simplicity that $\varepsilon = -1$. If a knot K in S^3 is isotopic to the knot $(\partial A \setminus b(\partial I \times I)) \cup b(I \times \partial I)$ in $M_c(-1) \approx S^3$, then we say that K admits an *annulus presentation* (A, b, c) . It is easy to see that a knot admitting an annulus presentation is obtained from the Hopf link by a single band surgery (see [1]). A typical example of a knot admitting an annulus presentation is given in Figure 6.

For an annulus presentation (A, b, c) , $(\mathbb{R}^2 \cup \{\infty\}) \setminus \text{int}A$ consists of two disks D and D' , see Figure 7. Assume that $\infty \in D'$.

Definition 3.1. An annulus presentation (A, b, c) is called *simple* if $b(I \times I) \cap \text{int}D = \emptyset$.

¹In [1], it was called a *band presentation*.

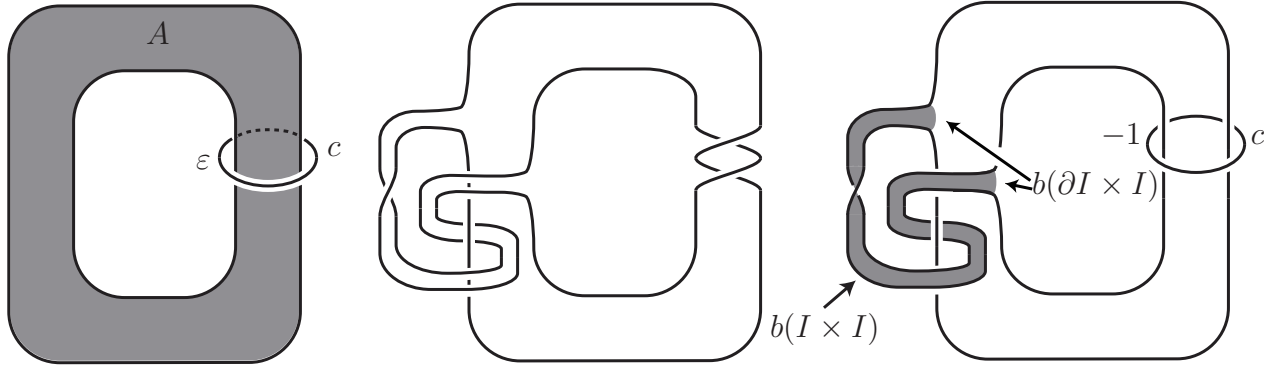

FIGURE 6. The knot depicted in the center admits an annulus presentation as in the right side.

For example, in Figure 7, the annulus presentation depicted in the center is simple, and the right one is not.

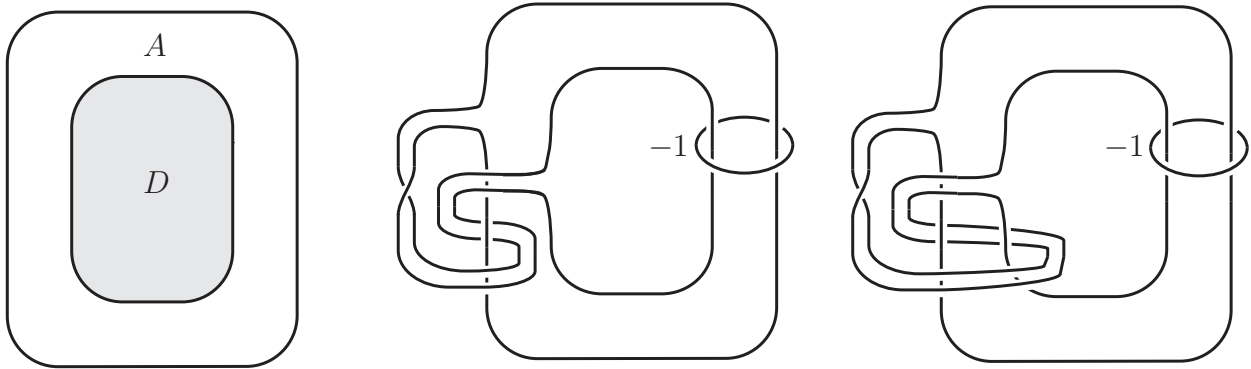

FIGURE 7. The position of D , a simple annulus presentation and a non-simple annulus presentation.

Let (A, b, c) be an annulus presentation of a knot. In a situation where it is inessential how the band $b(I \times I)$ is embedded, we often indicate (A, b, c) in an abbreviated form as in Figure 8.

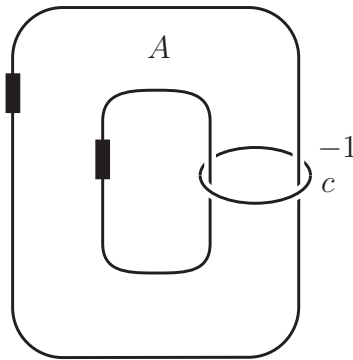

FIGURE 8. Thick arcs stand for $b(\partial I \times I)$.

3.1.2. *Operations.* To construct knots yielding the same 4-manifold by a 2-handle attaching, we define operations on an annulus presentation.

Definition 3.2. Let (A, b, c) be an annulus presentation, and n an integer.

- The operation (A) is to apply an annulus twist along the annulus A .
- The operation (T_n) is defined as follows:
 - (1) Adding the $(-1/n)$ -framed unknot as in Figure 9, and
 - (2) (after isotopy) blowing down along the $(-1/n)$ -framed unknot.
- The operation $(*n)$ is the composition of (A) and (T_n) .

In the operation (T_n) , the added $(-1/n)$ -framed unknot is lying on the neighborhood of c and ∂A , and does not intersect $b(I \times I)$. The intersection of A and the added unknot is just one point.

The operation $(*n)$ is a generalization of an annulus twist, in particular, $(*0) = (A)$.

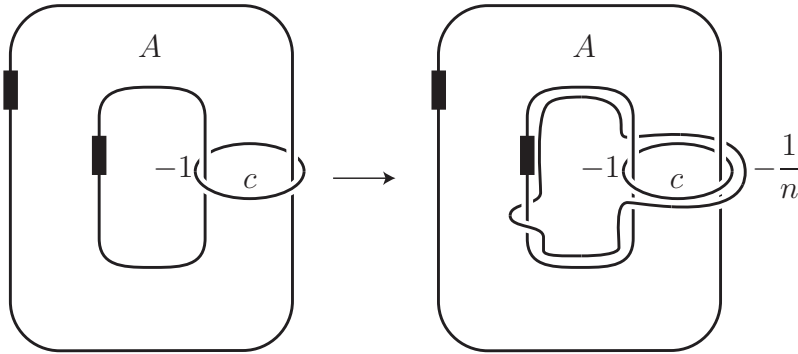

FIGURE 9. Add the $(-1/n)$ -framed unknot in the operation (T_n) .

3.1.3. *Construction.* For a given knot K with an annulus presentation, we can obtain a new knot K' with a new annulus presentation by applying the operation $(*n)$. By abuse of notation, we call K' the knot obtained from K by the operation $(*n)$. Here we give examples.

Example 3.3. Let J_0 be the knot with the simple annulus presentation of Figure 10. Let J_1 be the knot obtained from J_0 by the operation $(*n)$. Then J_1 is as in Figure 10.

Remark 3.4. Let K be a knot with an annulus presentation (A, b, c) , and K' the knot obtained from K by $(*n)$. If (A, b, c) is simple, then the resulting annulus presentation of K' is also simple.

Example 3.5. For the knot J_1 in Example 3.3 with $n = 1$, let J_2 be the knot obtained from J_1 by applying the operation $(*1)$. Then J_2 is as in Figure 11.

The following lemma is obvious, however, important in our argument.

Lemma 3.6. Let L be a 2-component framed link which consists of L_1 with framing $(-1/n)$ and L_2 with framing 0 as in the left side of Figure 12. Suppose that the linking number of L_1 and L_2 is ± 1 (with some orientation). Then the two Kirby diagrams in Figure 12 represent the same 3-manifold.

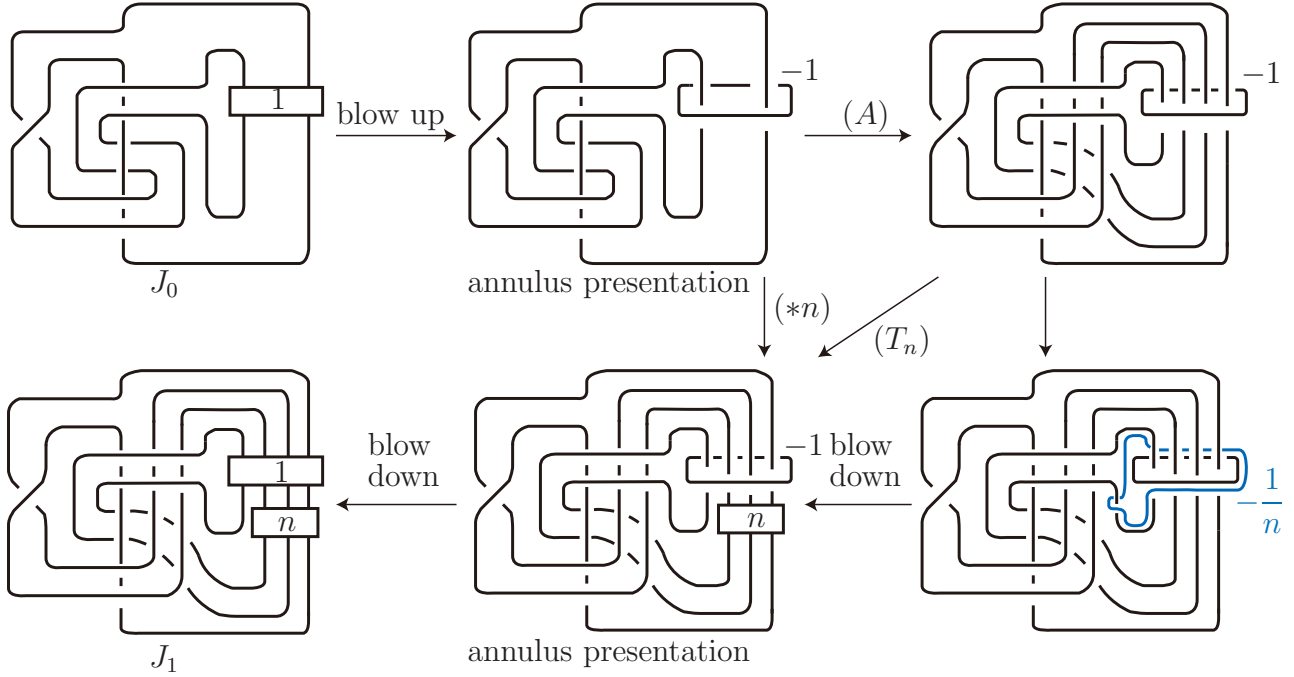

FIGURE 10. By the operation $(*n)$, the knot J_0 with the annulus presentation is deformed into the knot J_1 with the annulus presentation.

Theorem 3.7. *Let K be a knot with an annulus presentation and K' be the knot obtained from K by the operation $(*n)$. Then*

$$M_K(n) \approx M_{K'}(n).$$

Proof. First, we consider the case where $K = J_0 = 8_{20}$ with the usual annulus presentation as in Figure 10. Figure 13 shows that $M_K(n)$ is represented by the last diagram in Figure 13, and this is diffeomorphic to $M_{K'}(n)$ by Figure 14. The moves in Figure 14 correspond to the operation $(*n)$.

Next we consider the general case. Let (A, b, c) be an annulus presentation of K . As seen in Figure 15, $M_K(n)$ is represented by the last diagram in Figure 15. Now it is not difficult to see that this is diffeomorphic to $M_{K'}(n)$. \square

Remark 3.8. Let K be a knot with an annulus presentation (A, b, c) and K' be the knot obtained from K by the operation $(*n)$. In general, K' is much more complicated than K . If the annulus presentation (A, b, c) is simple, then K' is not too complicated. Indeed, let (A, b_A, c) be the annulus presentation obtained from (A, b, c) by applying the operation (A) as in the left side of Figure 16. Then the knot K' is indicated as in the right side of Figure 16.

3.2. Extension of a diffeomorphism between 3-manifolds. In his seminal work, Cerf [6] proved that any orientation preserving self diffeomorphism of S^3 extends to a self diffeomorphism of B^4 . As an application, Akbulut obtained the following lemma.

Lemma 3.9 ([3]). *Let K and K' be knots in $S^3 = \partial D^4$ with a diffeomorphism $g: \partial X_K(n) \rightarrow \partial X_{K'}(n)$, and let μ be a meridian of K . Suppose that*

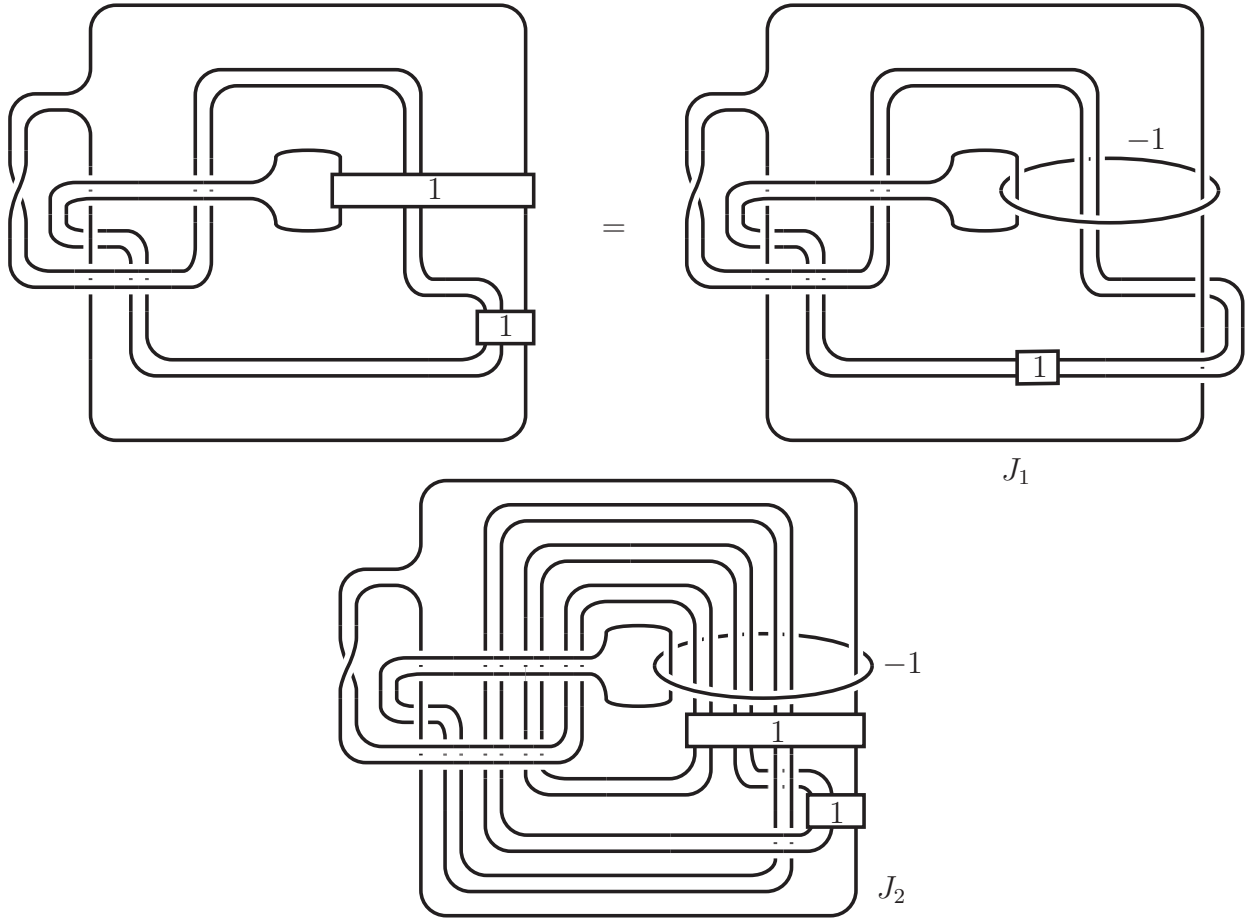

FIGURE 11. An annulus presentation of the knot J_2 (lower half) obtained from J_0 by applying $(*1)$ two times.

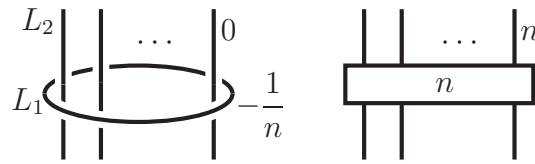

FIGURE 12. Two Kirby diagrams represent the same 3-manifold.

- (1) if μ is 0-framed, then $g(\mu)$ is the 0-framed unknot in the Kirby diagram representing $X_{K'}(n)$, and
- (2) the Kirby diagram $X_{K'}(n) \cup h^1$ represents D^4 , where h^1 is the 1-handle represented by $g(\mu)$.

Then g extends to a diffeomorphism $\tilde{g}: X_K(n) \rightarrow X_{K'}(n)$ such that $\tilde{g}|_{\partial X_K(n)} = g$.

This technique is called “carving” in [4]. For a proof, we refer the reader to [1, Lemma 2.9]. Applying Lemma 3.9, we show the following.

Theorem 3.10. *Let K be a knot with a simple annulus presentation and K' be the knot obtained from K by the operation $(*n)$. Then $X_K(n) \approx X_{K'}(n)$.*

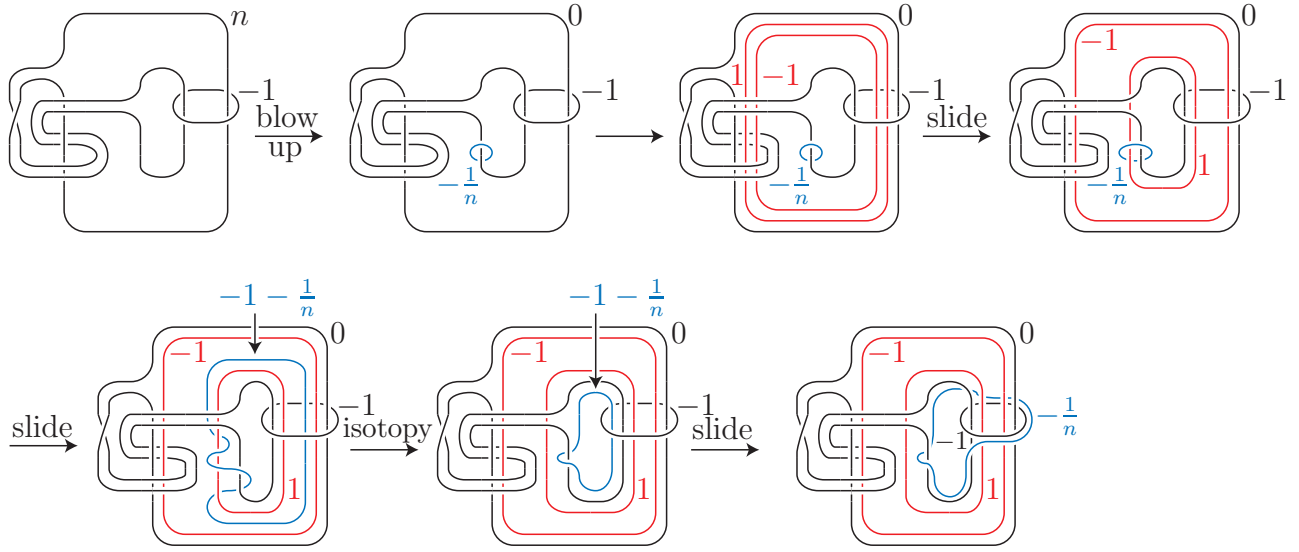
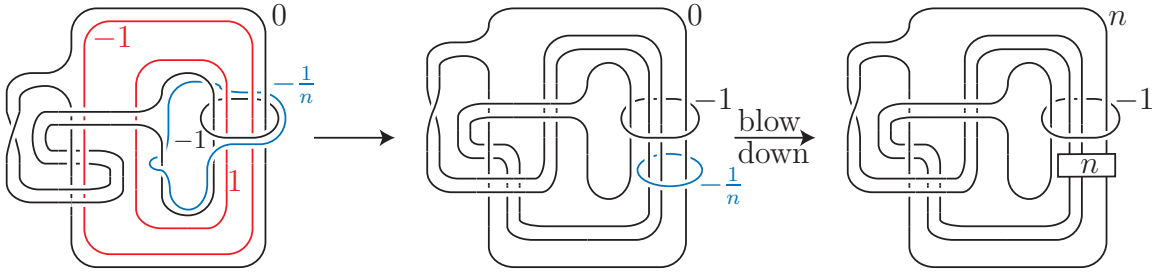
 FIGURE 13. A proof of $M_K(n) \approx M_{K'}(n)$ when $K = 8_{20}$.

 FIGURE 14. Moves which correspond to the operation $(*n)$.

Proof. First, we consider the case where $K = 8_{20}$ with the usual simple annulus presentation. Let $f: \partial X_K(n) \rightarrow \partial X_{K'}(n)$ be the diffeomorphism given in Figures 13 and 14. Let μ be the meridian of K . If we suppose that μ is 0-framed, then we can check that $f(\mu)$ is the 0-framed unknot in the Kirby diagram of $X_{K'}(0)$ as in Figure 17. Let W be the 4-manifold $D^4 \cup h^1 \cup h^2$, where h^1 is the dotted 1-handle represented by $f(\mu)$ and h^2 is the 2-handle represented by K' with framing n . Sliding h^2 over h^1 , we obtain a canceling pair (see Figure 18), implying that $W \approx B^4$. By Lemma 3.9, we have $\tilde{f}: X_K(0) \xrightarrow{\cong} X_{K'}(0)$.

Next, we consider the general case. Let $g: \partial X_K(n) \rightarrow \partial X_{K'}(n)$ be the diffeomorphism given in the proof of Theorem 3.7 in the general case (see Figure 19), and μ the meridian of $\partial X_K(n)$. In Figure 19, the annulus presentation in the right hand side represents K' , see Remark 3.8. If we suppose that μ is 0-framed, then we can check that $g(\mu)$ is the 0-framed unknot in the Kirby diagram of $X_{K'}(0)$ as in Figure 19. Let W be the 4-manifold $D^4 \cup h^1 \cup h^2$, where h^1 is the dotted 1-handle represented by $g(\mu)$ and h^2 is the 2-handle represented by K' with framing n . Sliding h^2 over h^1 , we obtain a canceling pair (see Figure 20), implying that $W \approx B^4$. By Lemma 3.9 again, we have $\tilde{g}: X_K(0) \xrightarrow{\cong} X_{K'}(0)$. \square

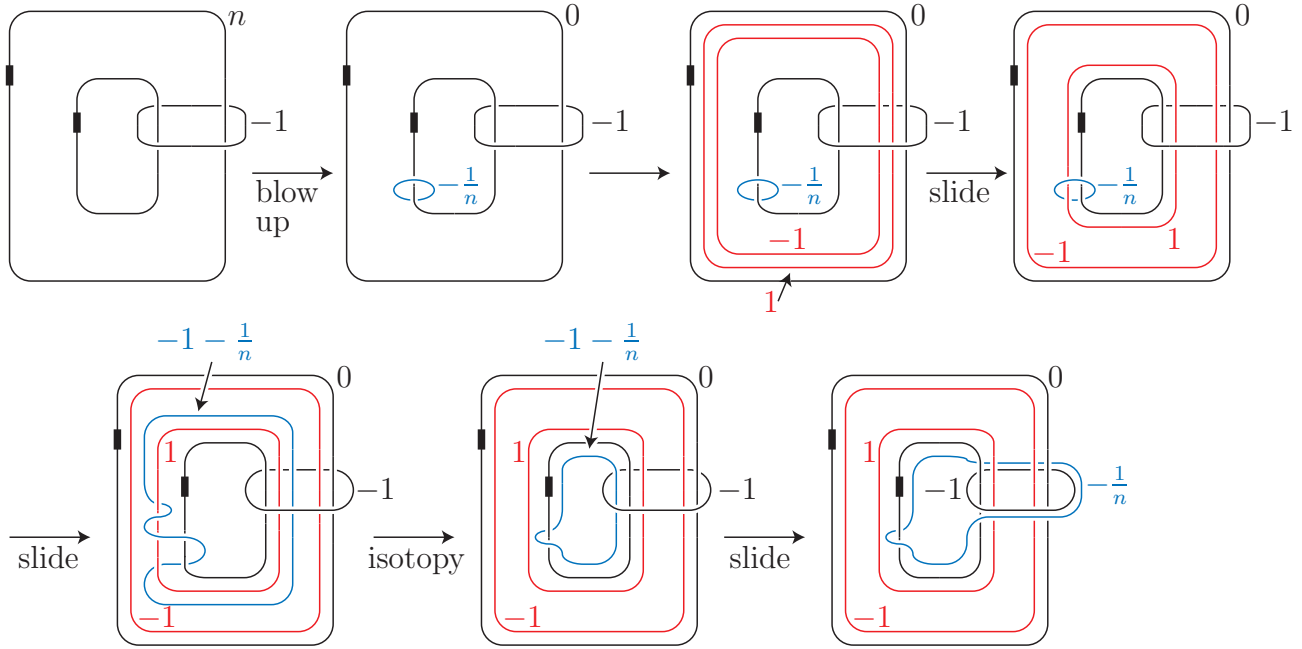

FIGURE 15. A proof of $M_K(n) \approx M_{K'}(n)$ for the general case.

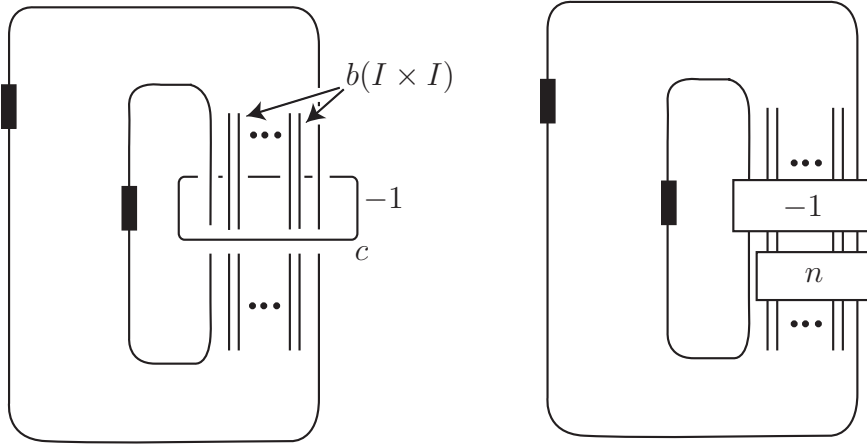

FIGURE 16. The annulus presentation (A, b_A, c) and the knot K' .

Remark 3.11. It would be interesting to characterize the knots which admit simple annulus presentations in terms of other topological properties. It is known that a knot with unknotting number one admits a simple annulus presentation (see [1, Lemma 2.2]).

3.3. Proof of Theorem 1.2. For a knot K , we denote by $\Delta_K(t)$ the Alexander polynomial of K . We assume that $\Delta_K(1) = 1$ and $\Delta_K(t)$ is of the symmetric form

$$\Delta_K(t) = a_0 + \sum_{i=1}^d a_i(t^i + t^{-i}).$$

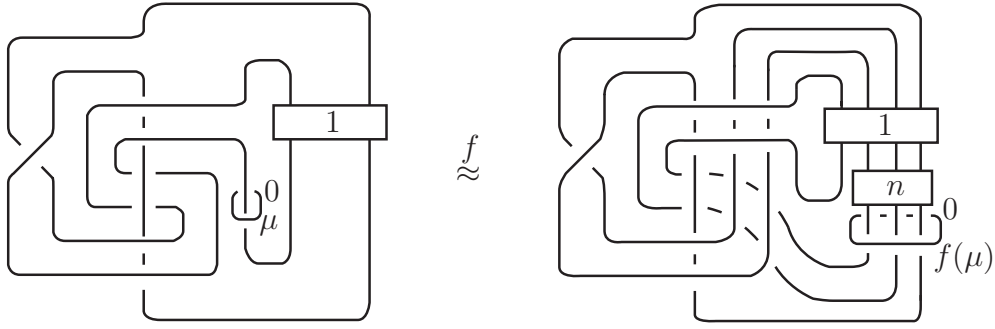

FIGURE 17. The image of μ under f .

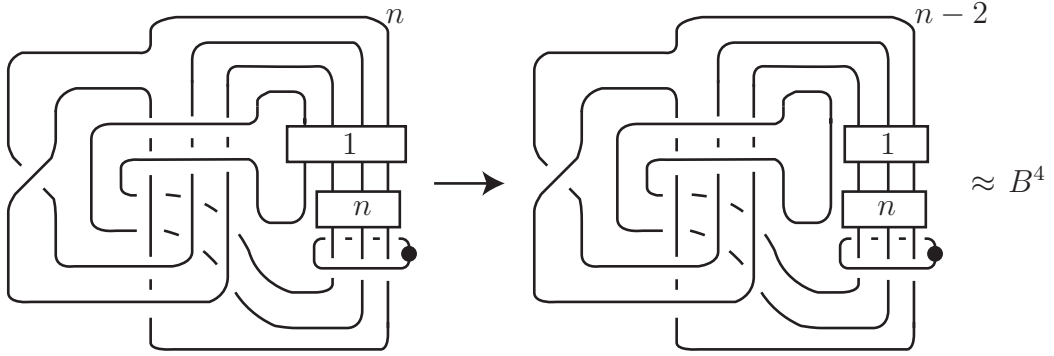

FIGURE 18. The 4-manifold W is diffeomorphic to B^4 .

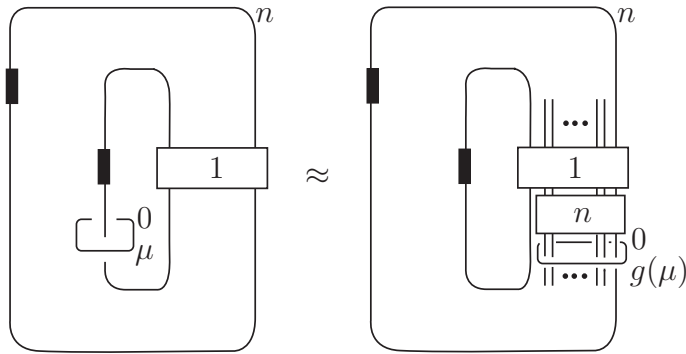

FIGURE 19. The image of μ under g .

We call the integer d the *degree*² of $\Delta_K(t)$, and denote it by $\deg \Delta_K(t)$. For example, $\deg(-1 + t + t^{-1}) = 1$.

In this subsection, we define a “good” annulus presentation. Theorem 1.2 will be shown as a typical case of the argument in this subsection. The following technical lemma plays an important role.

Lemma 3.12. *Let n be a positive integer. Let K be a knot with a good annulus presentation, and K' be the knot obtained from K by applying the operation $(*n)$. Then*

- (i) K' also admits a good annulus presentation, and

²Usually, the degree is defined as $2d$.

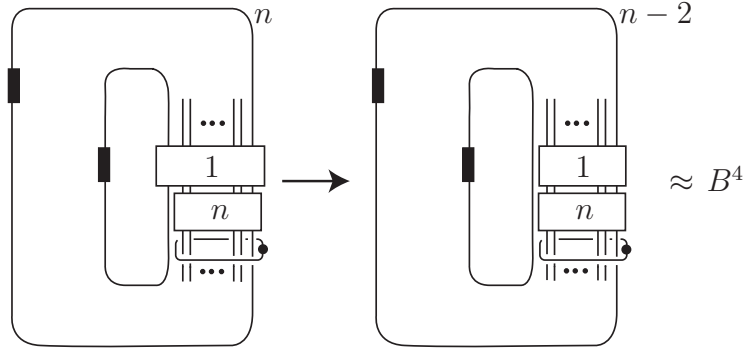

FIGURE 20. The 4-manifold W is diffeomorphic to B^4 .

(ii) $\deg \Delta_K(t) < \deg \Delta_{K'}(t)$.

We will prove Lemma 3.12 later. Using Lemma 3.12, we show the following which yields Theorem 1.2 as an immediate corollary.

Theorem 3.13. *Let n be a positive integer. Let K_0 be a knot with a good annulus presentation and K_i ($i \geq 1$) the knot obtained from K_{i-1} by applying the operation $(*n)$. Then*

- (1) $X_{K_0}(n) \approx X_{K_1}(n) \approx X_{K_2}(n) \approx \dots$, and
- (2) the knots K_0, K_1, K_2, \dots are mutually distinct.

Let \overline{K}_i be the mirror image of K_i . Then

- (3) $X_{\overline{K}_0}(-n) \approx X_{\overline{K}_1}(-n) \approx X_{\overline{K}_2}(-n) \approx \dots$, and
- (4) the knots $\overline{K}_0, \overline{K}_1, \overline{K}_2, \dots$ are mutually distinct.

Proof. By the definition (Definition 3.14), any good annulus presentation is simple. Thus, by Theorem 3.10, we have

$$X_{K_0}(n) \approx X_{K_1}(n) \approx X_{K_2}(n) \approx \dots$$

By Lemma 3.12 (i), each K_i ($i \geq 1$) also admits a good annulus presentation. Thus, by Lemma 3.12 (ii), we have

$$\deg \Delta_{K_0}(t) < \deg \Delta_{K_1}(t) < \deg \Delta_{K_2}(t) < \dots$$

This implies that the knots K_0, K_1, K_2, \dots are mutually distinct.

Since $X_{K_i}(n) \approx X_{\overline{K}_i}(-n)$ and $\deg \Delta_{K_i}(t) = \deg \Delta_{\overline{K}_i}(t)$, we have

$$X_{\overline{K}_0}(-n) \approx X_{\overline{K}_1}(-n) \approx X_{\overline{K}_2}(-n) \approx \dots, \text{ and}$$

$$\deg \Delta_{\overline{K}_0}(t) < \deg \Delta_{\overline{K}_1}(t) < \deg \Delta_{\overline{K}_2}(t) < \dots$$

This completes the proof of Theorem 3.13. \square

3.3.1. Good annulus presentation and the Alexander polynomial. Let K be a knot with a simple annulus presentation (A, b, c) . Note that the knot $(\partial A \setminus b(\partial I \times I)) \cup b(I \times \partial I)$ is trivial³ in S^3 if we ignore the (-1) -framed loop c . We denote by U this trivial knot. Since (A, b, c) is simple, $U \cup c$ can be isotoped so that U bounds a “flat” disk D (contained in

³ K is the knot $(\partial A \setminus b(\partial I \times I)) \cup b(I \times \partial I)$ in $M_c(-1)$.

$\mathbb{R}^2 \cup \{\infty\}$). This isotopy, denoted by φ_b , is realized by shrinking the band $b(I \times I)$. For simplicity, the isotopy φ_b is also denoted by φ . For example, see Figure 21. In the abbreviated form, φ is represented as in Figure 22. Here we note that the linking number of U and c is zero since we assumed that $A \cup b(I \times I)$ is orientable. Let Σ be the disk bounded by c as in Figure 22. We assume that Σ remains fixed through the isotopy φ .

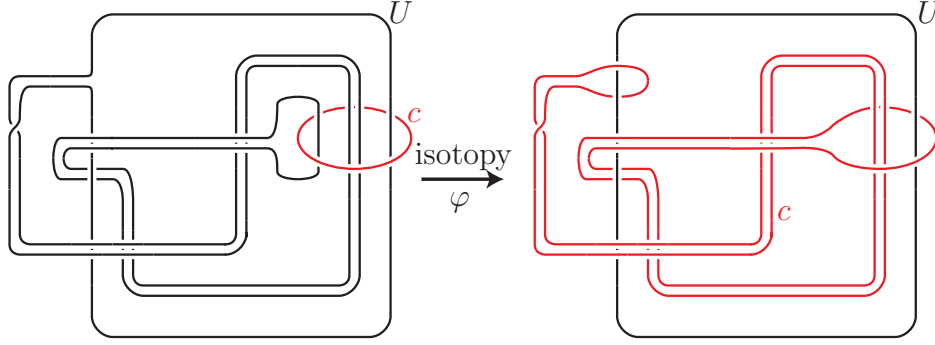

FIGURE 21. By the isotopy φ (shrinking the band $b(I \times I)$), $U \cup c$ (the left side) is changed to the right side.

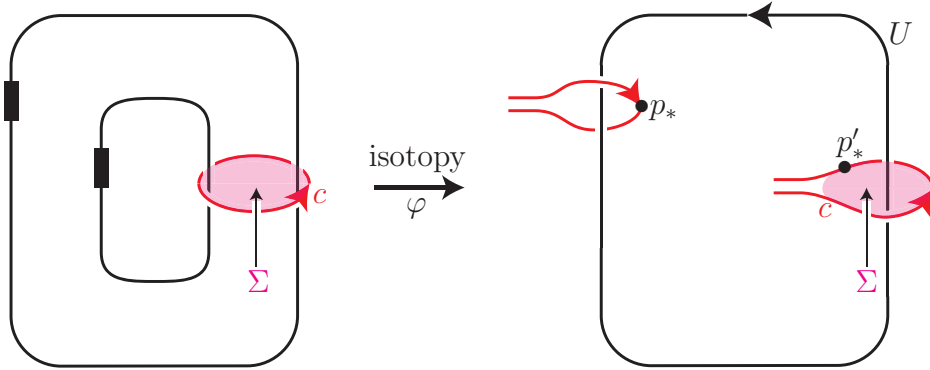

FIGURE 22. The isotopy φ in the abbreviated form of (A, b, c) .

After the isotopy φ , cutting along the disk D , the loop c is separated into arcs whose endpoints are in D . Furthermore, choosing orientations on c and U , these arcs are oriented. We choose the orientations on c and U as in Figure 22, and orientations on D and Σ consistent with those on c and U . These oriented arcs are classified into four types as follows: For $p \in c \cap D$, let $\text{sign}(p) = \pm$ according to the sign of the intersection between D and c at p . For an oriented arc α , let p_s (resp. p_t) be the starting point (resp. terminal point) of α . Then we say that α is of *type* $(\text{sign}(p_s) \text{sign}(p_t))$. That is, the oriented arc α is of type $(++)$, $(--)$, $(+-)$, or $(-+)$. For example, see Figure 23.

Let $E(U)$ be the exterior of U and $\tilde{E}(U)$ its infinite cyclic cover. Notice that $\tilde{E}(U)$ consists of infinitely many copies of a cylinder obtained from $E(U)$ by cutting along D . Thus $\tilde{E}(U)$ is diffeomorphic to $D \times \mathbb{R} \approx \cup_{i \in \mathbb{Z}} (D \times [i, i + 1])$. Each oriented arc is lifted in $\tilde{E}(U)$ as shown in Figure 24. Note that each arc can be knotted in Figure 24. Hereafter, for simplicity, we say an arc instead of an oriented arc.

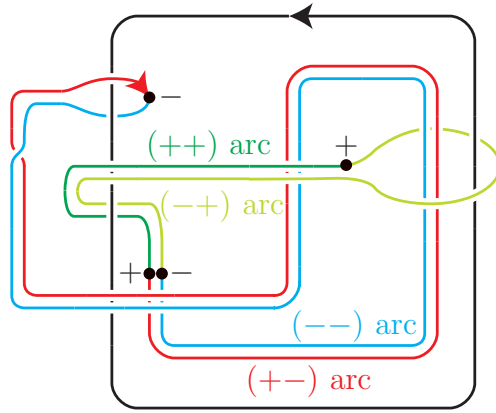

FIGURE 23. The four types of arcs.

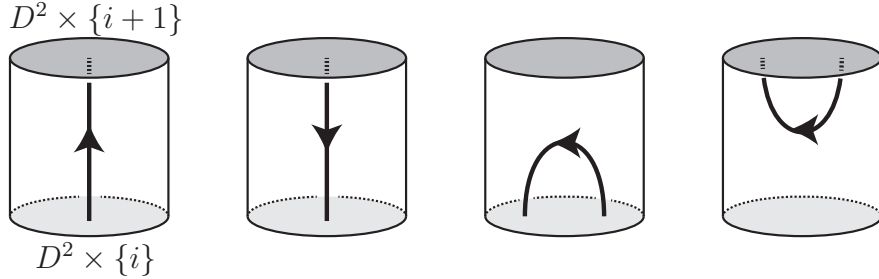

FIGURE 24. Lifts of oriented arcs of type $(++)$, $(--)$, $(+-)$, and $(-+)$ respectively.

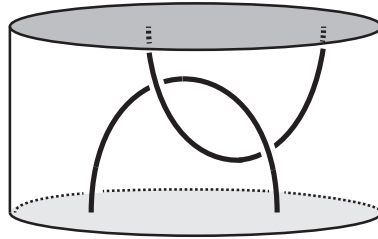

FIGURE 25. Lifts of the arcs of type $(+-)$ and $(-+)$ from a good annulus presentation.

Definition 3.14. We say that a simple annulus presentation (A, b, c) is *good* if $b(I \times \partial I) \cap \text{int}A \neq \emptyset$ and the set of arcs \mathcal{A} obtained as above satisfies the following up to isotopy.

- (1) \mathcal{A} contains just one $(+-)$ arc and one $(-+)$ arc, and they are lifted as in Figure 25, that is, the linking number of the arcs rel $D \times \{i, i + 1\}$ is ± 1 . Here each of the two arcs is possibly itself knotted.
- (2) For $\alpha \in \mathcal{A}$, if $\alpha \cap \text{int}\Sigma \neq \emptyset$, then α is of type $(++)$ (resp. $(--)$) and the sign of each intersection point in $\text{int}\Sigma \cap \alpha$ is $+$ (resp. $-$).

Remark 3.15. For a simple annulus presentation (A, b, c) , after the isotopy φ , the intersection $c \cap D$ corresponds to the intersection $b(I \times \partial I) \cap \text{int}A$ and further two points p_* and p'_* depicted in Figure 22. Notice that

$$b(I \times \partial I) \cap \text{int}A = \sqcup_i b(\{t_i\} \times \partial I)$$

for some $0 < t_1 < \dots < t_r < 1$. For each i , $b(\{t_i\} \times \partial I)$ consists of two points whose signs differ. Furthermore, with the orientation as in Figure 22, we have

$$\text{sign}(p_*) = - \quad \text{and} \quad \text{sign}(p'_*) = +.$$

Example 3.16. The annulus presentation (A, b, c) of the knot $J_0 = 8_{20}$ is good since it is changed by the isotopy $\varphi = \varphi_b$ as in Figure 26. Applying the operation (A) , we obtain the annulus presentation as in Figure 21. We denote this annulus presentation by (A, b_A, c) . Now we check that (A, b_A, c) is good. It is obvious that $b_A(I \times \partial I) \cap \text{int}A \neq \emptyset$. As in the left side of Figure 27, after the isotopy $\varphi = \varphi_{b_A}$, the set of arcs satisfies condition (1) of Definition 3.14. However the $(+-)$ arc intersects $\text{int}\Sigma$, that is, condition (2) of Definition 3.14 does not hold. In such a case, changing the position of an intersection as in Figure 27 by applying an isotopy to the $(+-)$ arc, we obtain the set of arcs satisfying condition (2). Note that after this isotopy we can assume that the $(+-)$ and $(-+)$ arcs are fixed by a subsequent application of the operation (A) .

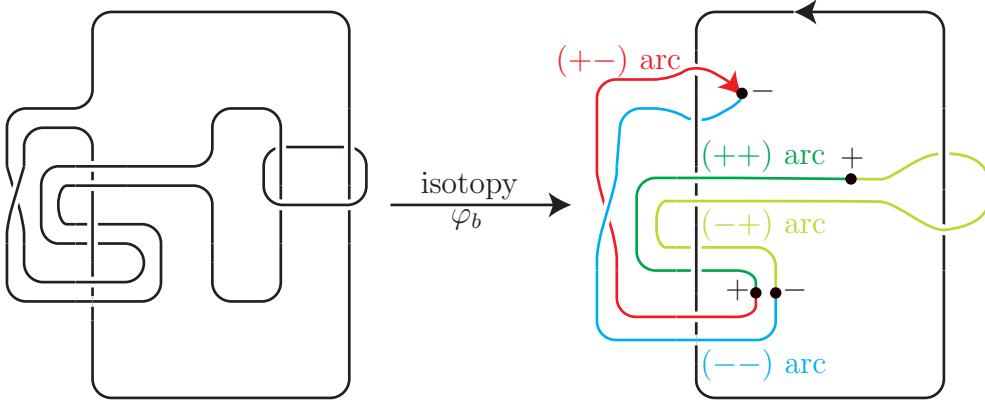

FIGURE 26. The annulus presentation (A, b, c) of $J_0 = 8_{20}$ is good.

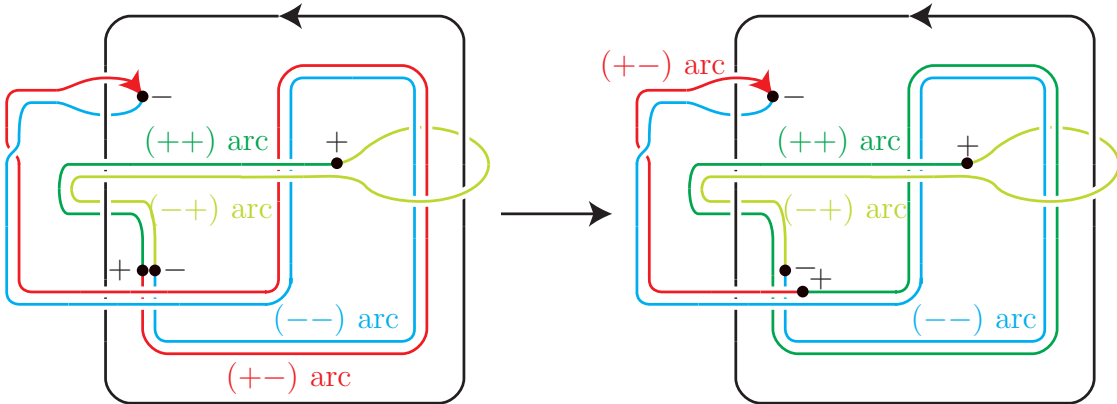

FIGURE 27. By an isotopy, we move the intersection point of $c \cap D$.

Let $E(K)$ be the exterior of a knot K . Considering a surgery description of the infinite cyclic covering, $\tilde{E}(K)$, of $E(K)$, we have the following.

Lemma 3.17. *If a knot K admits a good annulus presentation, then*

$$(3.1) \quad \deg \Delta_K(t) = \#\{\text{arcs of type } (++)\} + 1.$$

Proof. Let (A, b, c) be a good annulus presentation of K . Then K is represented by the unknot U (in $M_c(-1)$). After the isotopy φ_b , U bounds a “flat” disk D (contained in $\mathbb{R}^2 \cup \{\infty\}$) as in Figure 21.

Let V be a closed tubular neighborhood of c (which is diffeomorphic to a solid torus) and J a simple closed curve of slope -1 on ∂V . Since c and U have linking number zero, we can construct the infinite cyclic cover $\tilde{E}(K)$ from $\tilde{E}(U) \approx \cup_{i \in \mathbb{Z}} (D \times [i, i+1])$ as follows: Remove the interior of solid tori \tilde{V}_i ($i \in \mathbb{Z}$) which lie above V in $\tilde{E}(U)$, and sew solid tori W_i ($i \in \mathbb{Z}$) back so that each meridian, μ_i , of W_i is attached to the lift, \tilde{J}_i , of J .

Let $\Delta_K(t) = a_0 + \sum_{i=1}^{\infty} a_i(t^i + t^{-i})$. Then it is not difficult to see that a_i ($i = 1, 2, \dots$) is the linking number between \tilde{J}_0 and the core of \tilde{V}_i with suitable linking convention in $\tilde{E}(U)$. Note that $a_0 = 1 - 2 \sum_{i=1}^{\infty} a_i$ since $\Delta_K(1) = 1$. By condition (1) in Definition 3.14,

$$|a_i| = \begin{cases} 1 & \text{if } i = \#\{\text{arcs of type } (++)\} + 1, \\ 0 & \text{if } i > \#\{\text{arcs of type } (++)\} + 1. \end{cases}$$

This implies that $\deg \Delta_K(t) = \#\{\text{arcs of type } (++)\} + 1$.

For the details of a surgery description of $\tilde{E}(K)$ and the Alexander polynomial, we refer the reader to Rolfsen’s book [17, Chapter 7]. \square

Remark 3.18. To show Lemma 3.17, we do not need conditions (2) and (3) in Definition 3.14. These conditions are used to prove Lemma 3.12.

Remark 3.19. If a knot K admits a good annulus presentation, then we can see that $\Delta_K(t)$ is monic.

Now we are ready to prove the main result in this section.

Proof of Theorem 1.2. The case where $n = 0$ was proved in [1]. We can check that the simple annulus presentation of the knot 8_{20} as given in Figure 26 is good, see Example 3.16. Thus the proof for the case where $n \neq 0$ is obtained by Theorem 3.13 immediately. \square

3.3.2. Proof of Lemma 3.12. We start the proof of Lemma 3.12. Let (A, b, c) be a good annulus presentation of a knot K . Recall that the operation $(*n)$ is a composition of the two operations (A) and (T_n) for an annulus presentation. Let (A, b_A, c) be the annulus presentation obtained from (A, b, c) by applying the operation (A) , and (A, b', c) the annulus presentation obtained from (A, b_A, c) by applying the operation (T_n) . That is,

$$(A, b, c) \xrightarrow{(A)} (A, b_A, c) \xrightarrow{(T_n)} (A, b', c).$$

Note that K' admits the annulus presentation (A, b', c) .

First we show that (A, b_A, c) is good. It is obvious that $b_A(I \times \partial I) \cap \text{int}A \neq \emptyset$. The operation (A) preserves the number of arcs and type of each arc. We can suppose that the $(+-)$ arc and the $(-+)$ arc are fixed by the operation (A) up to isotopy as discussed in Example 3.16. Therefore the set of the arcs \mathcal{A} (obtained from (A, b_A, c)) satisfies condition

(1). Furthermore we can show that \mathcal{A} satisfies condition (2) since the orientations of c and U are consistent with the operation (A) . Therefore (A, b_A, c) is good.

Next we show that (A, b', c) is good. It is obvious that $b'(I \times \partial I) \cap \text{int}A \neq \emptyset$. The operation (T_n) may increase the number of arcs. Indeed a $(++)$ (resp. $(--)$) arc through Σ is changed to $n + 1$ $(++)$ (resp. $(--)$) arcs since (A, b_A, c) is good and $n > 0$, in particular, a $(++)$ arc (resp. $(--)$ arc) intersects Σ positively (resp. negatively). Note that the $(+-)$ arc and the $(-+)$ arc are fixed by the operation (T_n) since they are disjoint from Σ . Hence $(+-)$ arcs and $(-+)$ arcs are not produced by the operation (T_n) . Therefore the set of the arcs \mathcal{A}' (obtained from (A, b', c)) satisfies conditions (1) and (2). Hence (A, b', c) (of K') is good. This completes the proof of the claim (i) of Lemma 3.12.

Let $\delta = \#(A \cap b(I \times \partial I)) / 2$ and $\sigma = \#(\Sigma \cap b(I \times \partial I)) / 2$. Then we see that

$$\#(A \cap b_A(I \times \partial I)) / 2 = \delta, \quad \#(\Sigma \cap b_A(I \times \partial I)) / 2 = \sigma + \delta.$$

Then we have

$$\begin{aligned} \#(A \cap b'(I \times \partial I)) / 2 &= \#(A \cap b_A(I \times \partial I)) / 2 + n \cdot \#(\Sigma \cap b_A(I \times \partial I)) / 2 \\ &= (n + 1)\delta + n\sigma, \end{aligned}$$

and

$$\#(\Sigma \cap b'(I \times \partial I)) = \#(\Sigma \cap b_A(I \times \partial I)).$$

These are equivalent to

$$\begin{pmatrix} \delta' \\ \sigma' \end{pmatrix} = \begin{pmatrix} n + 1 & n \\ 1 & 1 \end{pmatrix} \begin{pmatrix} \delta \\ \sigma \end{pmatrix},$$

where $\delta' = \#(A \cap b'(I \times \partial I)) / 2$ and $\sigma' = \#(\Sigma \cap b'(I \times \partial I)) / 2$. Since $n \geq 1$ and $\delta \geq 1$, we have

$$(3.2) \quad \delta < \delta'.$$

By the condition that (A, b, c) and (A, b', c) is good, and by Remark 3.15, we see that

$$\delta = \# \{ (++) \text{ arcs of } (A, b, c) \}, \quad \delta' = \# \{ (++) \text{ arcs of } (A, b', c) \}.$$

Therefore, by Lemma 3.17, we have

$$(3.3) \quad \deg \Delta_K = \delta + 1, \quad \deg \Delta_{K'} = \delta' + 1.$$

By (3.2) and (3.3), we have $\deg \Delta_K(t) < \deg \Delta_{K'}(t)$. This completes the proof of the claim (ii) of Lemma 3.12, and thus, the proof of Lemma 3.12.

REFERENCES

- [1] T. Abe, I. D. Jong, Y. Omae, and M. Takeuchi, *Annulus twist and diffeomorphic 4-manifolds*, Math. Proc. Cambridge Philos. Soc. **155** (2013), no. 2, 219–235.
- [2] T. Abe and M. Tange, *A construction of slice knots via annulus twists*, arXiv:1305.7492 (2013).
- [3] S. Akbulut, *On 2-dimensional homology classes of 4-manifolds*, Math. Proc. Cambridge Philos. Soc. **82** (1977), no. 1, 99–106.
- [4] S. Akbulut, *4-manifolds*, draft of a book (2012), available at <http://www.math.msu.edu/~akbulut/papers/akbulut.1ec.eps>

- [5] K. L. Baker, C. McA. Gordon, and J. Luecke, *Bridge number and integral Dehn surgery*, arXiv:1303.7018 (2013).
- [6] J. Cerf, *Sur les difféomorphismes de la sphere de dimension trois* ($\Gamma_4 = 0$), Lecture Notes in Mathematics, No. 53, Springer-Verlag, Berlin-New York (1968) xii+133 pp.
- [7] M. Culler, N. Dunfield, and J. R. Weeks, *SnapPy, a computer program for studying the geometry and topology of 3-manifolds*, <http://snappy.computop.org>.
- [8] C. McA. Gordon, *Dehn surgery and satellite knots*, Trans. Amer. Math. Soc. **275** (1983), no. 2, 687–708.
- [9] C. McA. Gordon, *Boundary slopes of punctured tori in 3-manifolds*, Trans. Amer. Math. Soc. **350** (1998), no. 5, 1713–1790.
- [10] C. McA. Gordon and Y.-Q. Wu, *Toroidal Dehn fillings on hyperbolic 3-manifolds*, Memoirs AMS **194**, No. 909, (2008), 1–147.
- [11] N. Hoffman, K. Ichihara, M. Kashiwagi, H. Masai, S. Oishi, and A. Takayasu, *Verified computations for hyperbolic 3-manifolds*, arXiv:1310.3410 (2013), code available from: <http://www.oishi.info.waseda.ac.jp/~takayasu/hikmot/>
- [12] R. Kirby, *Problems in low-dimensional topology*, AMS/IP Stud. Adv. Math. **2**(2), Geometric topology (Athens, GA, 1993), 35–473 (Amer. Math. Soc. 1997).
- [13] R. Kouno, *3-manifolds with infinitely many knot surgery descriptions (in Japanese)*, Masters thesis, Nihon University (2002).
- [14] W. B. R. Lickorish, *A representation of orientable combinatorial 3-manifolds*, Ann. of Math **76** (1962), no. 3, 531–538.
- [15] W. Neumann and D. Zagier, *Volumes of hyperbolic three-manifolds*, Topology **24** (1985), no. 3, 307–332.
- [16] J. Osoinach, *Manifolds obtained by surgery on an infinite number of knots in S^3* , Topology **45** (2006), no. 4, 725–733.
- [17] D. Rolfsen, *Knots and Links*, Mathematics Lecture Series, No. 7. Publish or Perish, Inc., Berkeley, Calif., 1976.
- [18] M. Teragaito, *A Seifert fibered manifold with infinitely many knot-surgery descriptions*, Int. Math. Res. Not. **2007**, no. 9, Art. ID rnm028, 16 pp.
- [19] A. Wallace, *Modifications and cobounding manifolds*, Can. J. Math. **12** (1960), 503–528.

DEPARTMENT OF MATHEMATICS, TOKYO INSTITUTE OF TECHNOLOGY, 2-12-1 OOKAYAMA, MEGURO-KU, TOKYO 152-8551, JAPAN

E-mail address: abe.t.av@m.titech.ac.jp

DEPARTMENT OF MATHEMATICS, KINKI UNIVERSITY, 3-4-1 KOWAKAE, HIGASHIOSAKA CITY, OSAKA 577-0818, JAPAN

E-mail address: jong@math.kindai.ac.jp

UNIVERSITY OF TEXAS AT AUSTIN

E-mail address: luecke@math.utexas.edu

UNIVERSITY OF DALLAS

E-mail address: josoinach@udallas.edu