

THE L^2 -ALEXANDER INVARIANT DETECTS THE UNKNOT

FATHI BEN ARIBI

ABSTRACT. In this article, we present some of the properties of the L^2 -Alexander invariant of a knot defined in [6], some of which are similar to those of the classical Alexander polynomial. Notably we prove that the L^2 -Alexander invariant detects the trivial knot.

1. INTRODUCTION

In 1923, Alexander introduced the first polynomial invariant of knots. It was nothing short of a revolution, since this invariant was easy to compute and powerful enough to distinguish most of the tabulated prime knots. However, the Alexander polynomial is not a complete invariant, not even among prime knots. In particular it does not detect the unknot.

In 1976, Atiyah laid the foundations of the theory of L^2 -invariants. The idea is roughly the following: algebraic topology has many invariants that involve finite dimensional vector spaces and linear maps; by doing similar processes with infinite dimensional Hilbert spaces - like $\ell^2(G)$ where G is a group - and operators on these spaces, we obtain the so-called L^2 -invariants.

In the nineties, Carey-Mathai, Lott, Lück-Rothenberg, and Novikov-Shubin developed the theory of L^2 -torsions, an L^2 -analog of the Reidemeister torsion theory.

Finally, in 2006, Li and Zhang introduced the L^2 -Alexander invariant, an analog of the Alexander polynomial, and proved its relation with the L^2 -torsion of the knot exterior.

In this article, we prove that the L^2 -Alexander invariant for knots detects the unknot, in the following theorem.

Theorem 1.1. *[Main theorem] Let K be a knot in S^3 . The L^2 -Alexander invariant of K is trivial, i.e. $(t \mapsto \Delta_K^{(2)}(t)) = (t \mapsto 1)$, if and only if K is the trivial knot.*

This theorem is proven by using the well-known fact (cf [9]) that a knot exterior either has nonzero Gromov norm or is a graph manifold, and that in this second case the knot is obtained from the trivial knot by connected sums and cablings. In the first case, a theorem of Lück helps us conclude, and the second case is treated with help from the following connected sum and cabling formulas for the L^2 -Alexander invariant.

Theorem 1.2. (1) *The L^2 -Alexander invariant is multiplicative under the connected sum of knots.*

(2) *The L^2 -Alexander invariant satisfies the following cabling formula: if S is the (p, q) -cable knot of companion knot C , then*

$$\Delta_S^{(2)}(t) = \Delta_C^{(2)}(t^p) \max(1, t)^{(|p|-1)(|q|-1)}.$$

2010 *Mathematics Subject Classification.* 57M25; 57M27.

Key words and phrases. L^2 -torsion; knot invariants; Fox calculus; cable knots; Alexander invariant.

These results were previously announced in [1].

The article is organized as follows: Section 2 reviews some well-known facts about knots, groups, and L^2 -invariants, Sections 3 and 4 prove the first and second parts of Theorem 1.2, Section 5 proves Theorem 1.1. Section 6 deals with the proof of the technical Proposition 2.2. Finally in section 7 we mention some open questions and research directions about the invariant.

ACKNOWLEDGEMENTS

I would like to offer my special thanks to my advisor Jérôme Dubois, who taught me all about L^2 -invariants and always showed me the right mathematical direction to explore.

2. PRELIMINARIES

2.1. From knots to group presentations. We choose an orientation for S^3 . All knots will be assumed oriented, and considered up to (orientation-preserving) isotopy in S^3 . A link with $c \in \mathbb{N}$ components will be called a c -link.

Let K be an oriented knot in S^3 , and $V(K)$ an open tubular neighbourhood of K . The exterior of K is $M_K = S^3 \setminus V(K)$ and is a compact 3-manifold with toroidal boundary. We fix a base point pt in M_K . The orientation of M_K comes from the one of S^3 , and does not depend on the orientation of K .

Besides, since K is oriented, there are, up to isotopy, unique simple closed curves μ_K and λ_K on the 2-torus $\partial M_K = \partial V(K)$ such that μ_K bounds a disk in $V(K)$ and λ_K is homologous to K in $V(K)$. We choose an orientation for these two curves such that the linking number between μ_K and K and the intersection number between μ_K and λ_K are both $+1$. We call (μ_K, λ_K) a preferred meridian-longitude pair for K . (Here we have used the notations and definitions of [11]).

Let us now consider the knot group $G_K = \pi_1(M_K, pt)$. We will call *meridian loops* the elements of G_K that are the homotopy classes of meridian curves. The abelianization of G_K is the infinite cyclic group. There are therefore exactly two surjective group homomorphisms from G_K to \mathbb{Z} . We will write $\alpha_K: G_K \rightarrow \mathbb{Z}$ the one that sends meridian loops to 1. Note that this choice depends strongly on the orientation of K .

When considering a group presentation $P = \langle g_1, \dots, g_k | r_1, \dots, r_l \rangle$, it is usual to assimilate the combinatoric $(k + l)$ -tuple and the generated group. In this article, we will use the first convention, and we would denote $Gr(P)$ the quotient of the free group $\mathbb{F}[g_1, \dots, g_k]$ by its normal subgroup generated by the free words r_1, \dots, r_l . We will say that a group G admits the presentation $P = \langle g_1, \dots, g_k | r_1, \dots, r_l \rangle$ when G is isomorphic to $Gr(P)$, and we will assume that this isomorphism is implicit, or equivalently that we implicitly know which elements of G are associated to g_1, \dots, g_k .

For instance, the well-known Wirtinger process takes a regular diagram D of a knot K and gives a deficiency one group presentation P of the knot group G_K , and the generators of P all implicitly correspond to meridian loops in G_K ; therefore they are all sent to the same image 1 by the abelianization α_K .

Let p and q be relatively prime integers, and let V be a solid torus with a preferred meridian-longitude system (and thus an oriented core). The knot $T(p, q)$ on the boundary ∂V of V will denote the knot that wraps around V q times in the meridional direction and p times in the longitudinal direction; it will be called the (p, q) -torus knot. Note that this follows the conventions of [10] but not the ones of [2] and [4], where the roles of p and q are reversed.

2.2. Satellite knots. Since we will use satellite and cable knots somewhat intensively in Section 4 and Section 6, we recall some definitions and fix some notations. We use the notations of [4, Section 4].

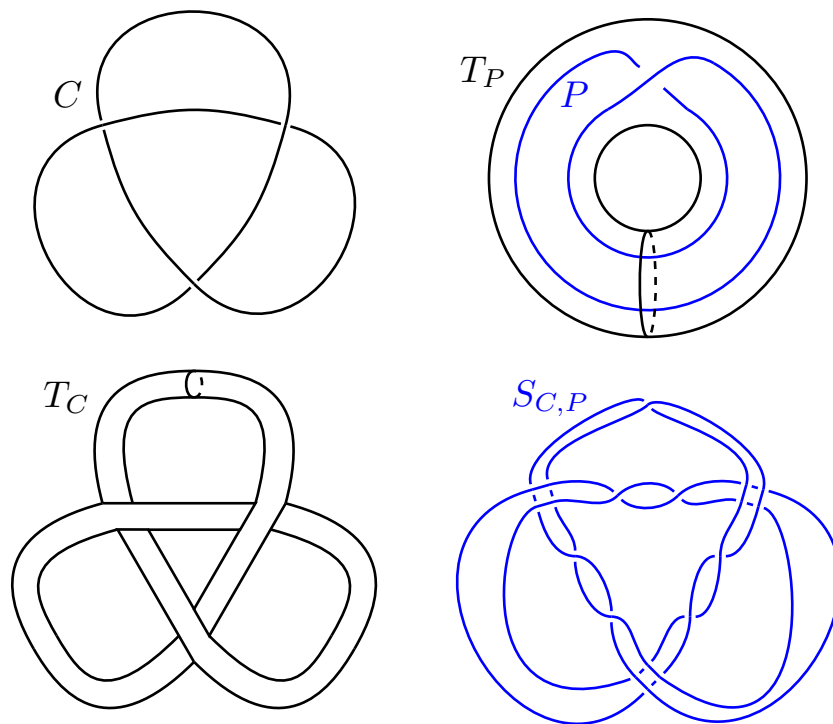

FIGURE 1. The $(2, -1)$ -cabling of the trefoil knot

Let C be a non-trivial knot in S^3 (it will be called the *companion knot*).

We consider P a knot inside an open solid torus T_P , T_P being also embedded in S^3 (P will be called the *pattern knot*). We choose an orientation for the core of T_P . We assume that P meets every meridional disk of T_P . We let $n_P \in \mathbb{Z}$ denote the linking number between P and a preferred meridian curve of ∂T_P (assumed to be positively oriented with the orientation of the core of T_P). Note that preferred longitude curves of T_P have zero linking number with the core of T_P and follow the same direction.

Let T_C be an open tubular neighborhood of C (its core having the same orientation as C). Notice that a preferred longitude curve of T_C has zero linking number with C . Thus the homotopy class in G_C of such a curve is sent to zero by the abelianization α_C .

Let $h_{PC}: T_P \rightarrow T_C$ be an orientation-preserving homeomorphism between the two solid tori. We also assume that h_{PC} sends a preferred meridian-longitude pair of T_P to a preferred meridian-longitude pair of T_C .

Then $S_{C,P} := h_{PC}(P)$ is a knot in S^3 and is called *the satellite knot of companion C and pattern P* .

Let us mention two particular cases of satellites: the cables and the Whitehead doubles.

If P is a torus knot $T(p, q)$ (naturally defined on the boundary of a solid sub-torus of T_P), then we call $S_{C,P}$ a *cable knot*, or *the (p, q) -cable of C* . In this case $n_P = p$.

Figure 1 gives an example of $S_{C,P}$ when C is the trefoil knot and P is the torus knot pattern $T(2, -1)$. The orientations are not marked but should be clear.

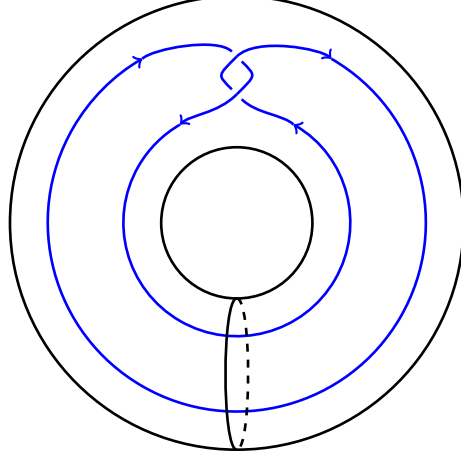

FIGURE 2. The Whitehead double pattern

If P is the pattern in Figure 2, called the *Whitehead double pattern*, then $n_P = 0$ and $S_{C,P}$ is called the *Whitehead double of C* .

2.3. Connected sum, cabling, and groups. Here we state some useful results about how the connected sum and cabling operations affect the knot groups.

Proposition 2.1. *Let K_1, K_2 be two knots and K their connected sum. We let G_1, G_2, G denote their respective knot groups. Then G_1 and G_2 have Wirtinger presentations $P_1 = \langle x_1, \dots, x_k | r_1, \dots, r_{k-1} \rangle$, $P_2 = \langle y_1, \dots, y_l | s_1, \dots, s_{l-1} \rangle$ such that*

$$P = \langle x_1, \dots, x_k, y_1, \dots, y_l | r_1, \dots, r_{k-1}, s_1, \dots, s_{l-1}, x_k y_l^{-1} \rangle$$

is a Wirtinger presentation of G .

This proposition is a consequence of the Seifert-van Kampen theorem. The associated partition (two open sets U_1 and U_2 , their union and their intersection) can be seen in Figure 3.

Proposition 2.2. *Let us consider the (p, q) -cable knot S of companion C .*

(1) *There exists $P_C = \langle a_1, \dots, a_k | r_1, \dots, r_{k-1} \rangle$ a Wirtinger presentation of G_C such that*

$$P_S = \langle a_1, \dots, a_k, x, \lambda | r_1, \dots, r_{k-1}, x^p a_k^{-q} \lambda^{-p}, \lambda^{-1} W(a_i) \rangle$$

is a presentation of G_S , with x and λ the homotopy classes of the core and a longitude of T_C , and $W(a_i)$ a word in the a_1, \dots, a_k .

(2) *Furthermore, $\alpha_S(x) = q$, $\alpha_S(\lambda) = 0$ and $\alpha_S(a_i) = p$, for $i = 1, \dots, k$.*

We give a detailed proof of this proposition in Section 6. Note that this result can be found in a different flavour in [2, Section 4.12].

Both following propositions are consequences of [8, Theorem 4.3], and will be useful for induction properties. Note that the proof of Proposition 2.4 also uses [2, Proposition 3.17].

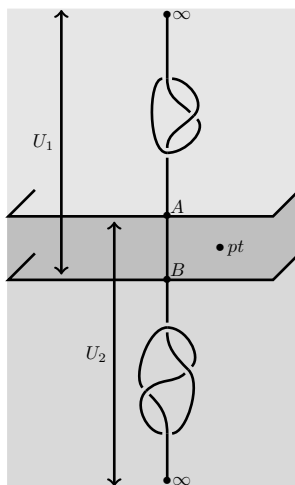

FIGURE 3. The Seifert-van Kampen partition, K_1 is the trefoil, K_2 the figure-eight

Proposition 2.3. *If K is the connected sum of the knots K_1 and K_2 , and G, G_1, G_2 are their respective groups, then there are injective group homomorphisms $G_1 \hookrightarrow G$ and $G_2 \hookrightarrow G$.*

Proposition 2.4. *If S is the satellite knot obtained from the companion C and the pattern P , then there is an injective group homomorphism $G_C \hookrightarrow G_S$.*

2.4. Fox calculus. Let $P = \langle g_1, \dots, g_k \mid r_1, \dots, r_l \rangle$ be a presentation of a finitely presented group G . If w is an element of the free group $\mathbb{F}[g_1, \dots, g_k]$ on the generators g_i , we note \bar{w} the element of G that is the image of w by the composition of the quotient homomorphism (quotient by the normal subgroup $\langle r_j \rangle$ generated by r_1, \dots, r_l) and the implicit group isomorphism between this quotient $Gr(P)$ and G . To simplify the notations in the sequel, we will often write an element of G a instead of \bar{a} when there is no ambiguity. We note the corresponding ring morphisms similarly: if $w \in \mathbb{C}[\mathbb{F}[g_1, \dots, g_k]]$ then its quotient image is noted $\bar{w} \in \mathbb{C}[G]$.

The Fox derivatives associated to the presentation P are the linear maps $\frac{\partial}{\partial g_i} : \mathbb{C}[\mathbb{F}[g_1, \dots, g_k]] \rightarrow \mathbb{C}[\mathbb{F}[g_1, \dots, g_k]]$ for $i = 1, \dots, k$, defined by induction in the following way:

$\frac{\partial}{\partial g_i}(1) = 0$, $\frac{\partial}{\partial g_i}(g_j) = \delta_{i,j}$, $\frac{\partial}{\partial g_i}(g_j^{-1}) = -\delta_{i,j}g_j^{-1}$ (where $\delta_{i,j}$ is 1 when $i = j$ and 0 when $i \neq j$) and for all $u, v \in \mathbb{F}[g_1, \dots, g_n]$, $\frac{\partial}{\partial g_i}(uv) = \frac{\partial}{\partial g_i}(u) + u \frac{\partial}{\partial g_i}(v)$.

Definition 2.5. We call $F_P = \left(\overline{\left(\frac{\partial r_j}{\partial g_i} \right)} \right)_{1 \leq i \leq k, 1 \leq j \leq l} \in M_{k,l}(\mathbb{C}[G])$ the Fox matrix

of the presentation P .

Let us assume $l = k - 1$, i.e. P has deficiency one. For $i = 1, \dots, k$, $F_{P,i} \in M_{k-1,k-1}(\mathbb{C}[G])$ is defined as the matrix obtained from F_P by deleting its i -th row.

We will sometimes use the following notation, to «remember the coordinates»:

$$F_P = \begin{matrix} x_1 \\ \vdots \\ x_k \end{matrix} \begin{pmatrix} r_1 & & & & & & r_l \\ & \left(\overline{\left(\frac{\partial r_j}{\partial g_i} \right)} \right)_{i,j} & & & & & \\ & & & & & & \end{pmatrix}$$

Example 2.6. $P = \langle a, b \mid abab^{-1}a^{-1}b^{-1} \rangle$ is a presentation of the group of the trefoil knot. Let us denote $r = abab^{-1}a^{-1}b^{-1}$. One has:

$$\frac{\partial r}{\partial a} = 1 + ab - abab^{-1}a^{-1} \text{ so } \overline{\left(\frac{\partial r}{\partial a} \right)} = 1 - \bar{b} + \bar{a}\bar{b}.$$

$$\frac{\partial r}{\partial b} = a - abab^{-1} - abab^{-1}a^{-1}b^{-1} \text{ so } \overline{\left(\frac{\partial r}{\partial b} \right)} = -1 + \bar{a} - \bar{b}\bar{a}.$$

Thus $F_P = \begin{pmatrix} 1 - b + ab \\ -1 + a - ba \end{pmatrix}$, $F_{P,1} = (1 - b + ab)$ and $F_{P,2} = (-1 + a - ba)$.

2.5. L^2 -invariants. Let G be a countable discrete group (a knot group, for example). In the following, every algebra will be a \mathbb{C} -algebra.

We denote $l^2(G) := \left\{ \sum_{g \in G} \lambda_g [g] \mid \lambda_g \in \mathbb{C}, \sum_{g \in G} |\lambda_g|^2 < \infty \right\}$ the Hilbert space of square-summable complex functions on the group G .

It is the completion of the vector space $\mathbb{C}[G] = \bigoplus_{g \in G} \mathbb{C}[g]$ (which is also an algebra) for the scalar product:

$$\left\langle \sum_{g \in G} \lambda_g [g], \sum_{g \in G} \mu_g [g] \right\rangle := \sum_{g \in G} \lambda_g \overline{\mu_g}.$$

We denote $\mathcal{B}(l^2(G))$ the algebra of operators on $l^2(G)$ that are continuous (or equivalently, bounded) for the operator norm.

To any $h \in G$ we associate a *left-multiplication* $L_h: l^2(G) \rightarrow l^2(G)$ defined by

$$L_h \left(\sum_{g \in G} \lambda_g [g] \right) = \sum_{g \in G} \lambda_g [hg] = \sum_{g \in G} \lambda_{h^{-1}g} [g]$$

and a *right-multiplication* $R_h: l^2(G) \rightarrow l^2(G)$ defined by

$$R_h \left(\sum_{g \in G} \lambda_g [g] \right) = \sum_{g \in G} \lambda_g [gh] = \sum_{g \in G} \lambda_{gh^{-1}} [g].$$

Both L_h and R_h are isometries, and therefore belong to $\mathcal{B}(l^2(G))$.

We will use the same notation for right-multiplications by elements of the complex group algebra $\mathbb{C}[G]$:

$$R_{\sum_{i=1}^k \lambda_i [g_i]} := \sum_{i=1}^k \lambda_i R_{g_i} \in \mathcal{B}(l^2(G)).$$

We will also use this notation to define a right-multiplication by a matrix A with coefficients in $\mathbb{C}[G]$, p rows and q columns, in the following way:

If $A = (a_{i,j})_{1 \leq i \leq p, 1 \leq j \leq q} \in M_{p,q}(\mathbb{C}[G])$, then

$$R_A := (R_{a_{i,j}})_{1 \leq i \leq p, 1 \leq j \leq q} \in \mathcal{B}(l^2(G)^{\oplus q}; l^2(G)^{\oplus p}).$$

We write $\mathcal{N}(G)$ the algebraic commutant of $\{L_g; g \in G\}$ in $\mathcal{B}(l^2(G))$. It will be called the *von Neumann algebra of the group G* .

Let us remark that $R_g \in \mathcal{N}(G)$ for all g in G .

The trace of an element ϕ of $\mathcal{N}(G)$ will be defined by

$$\mathrm{tr}_{\mathcal{N}(G)}(\phi) := \langle \phi([e]), [e] \rangle$$

where e is the neutral element of G . This induces a trace on the $M_{n,n}(\mathcal{N}(G))$ for $n \geq 1$ by summing up the traces of the diagonal elements. We will note this new trace $\mathrm{tr}_{\mathcal{N}(G)}$ as well.

We will call a *finite type $\mathcal{N}(G)$ -Hilbert module* (or simply $\mathcal{N}(G)$ -module in the following) any Hilbert space V on which there is a left G -action by isometries, and such that there exists a positive integer m and an embedding ϕ of V into $\bigoplus_{i=1}^m \ell^2(G)$ (an embedding meaning here a linear isometrical injective G -equivariant map, where the left G -action on $\bigoplus_{i=1}^m \ell^2(G)$ is by left-multiplication coordinate by coordinate).

The *von Neumann dimension* of such a $\mathcal{N}(G)$ -module V is defined as the trace of the projection:

$$\dim_{\mathcal{N}(G)}(V) = \mathrm{tr}_{\mathcal{N}(G)}(\mathrm{pr}_{\phi(V)}) \in \mathbb{R}_{\geq 0},$$

where

$$\mathrm{pr}_{\phi(V)}: \bigoplus_{i=1}^k \ell^2(G) \rightarrow \bigoplus_{i=1}^k \ell^2(G)$$

is the orthogonal projection onto $\phi(V)$. The von Neumann dimension does not depend on the embedding of V into the finite direct sum of copies of $\ell^2(G)$.

If U and V are $\mathcal{N}(G)$ -modules, we will call $f: U \rightarrow V$ a *map of $\mathcal{N}(G)$ -modules* if f is a linear G -equivariant map, bounded for the respective scalar products of U and V .

Let us now write a little about induction.

Let $i: H \hookrightarrow G$ be an injective group homomorphism. To simplify notations, we will also call i the inducted algebra homomorphism on $\mathbb{C}[H]$ and matrices over $\mathbb{C}[H]$, and the isometric injection on $\ell^2(H)$. Let M be a $\mathcal{N}(H)$ -module. Then, according to [7, Section 1.1.5], we can construct an induction covariant functor i_* from the category ($\mathcal{N}(H)$ -modules, maps of $\mathcal{N}(H)$ -modules) to ($\mathcal{N}(G)$ -modules, maps of $\mathcal{N}(G)$ -modules), such that $i_*(\ell^2(H)) = \ell^2(G)$.

Remark 2.7. Let us now recall a well-known property of the induction functor, summarized in part (1) of Proposition 2.8:

If $w \in \mathbb{C}[H]$, then R_w is H -equivariant because right-multiplications commute with left-multiplications. Thus it is a map of $\mathcal{N}(H)$ -modules.

Take (m_j) a square-summable family of $\ell^2(H)$, and let $x = \sum_{j \in G/i(H)} L_{g_j} i(m_j)$ be a typical element of $i_* \ell^2(H) = \ell^2(G)$.

Then, since left-multiplications commute with right-multiplications,

$$\begin{aligned} i_* R_w(x) &= \sum_{j \in G/i(H)} L_{g_j} i(R_w(m_j)) = \sum_{j \in G/i(H)} L_{g_j} R_{i(w)} i(m_j) \\ &= R_{i(w)} \sum_{j \in G/i(H)} L_{g_j} i(m_j) = R_{i(w)}(x). \end{aligned}$$

Thus $i_* R_w = R_{i(w)}$.

The following properties of this induction functor will be used in this paper:

Proposition 2.8. (1) Let $w \in \mathbb{C}[H]$ and $R_w: \ell^2(H) \rightarrow \ell^2(H)$ be the corresponding right multiplication. Then $i_* R_w = R_{i(w)}$.

A similar result stands for matrices over $\mathbb{C}[H]$.

(2) If the map of $\mathcal{N}(H)$ -modules $f: M \rightarrow N$ is injective (resp. surjective) then $i_* f: i_* M \rightarrow i_* N$ is also injective (resp. surjective).

(3) If M is a $\mathcal{N}(H)$ -module, then $\dim_{\mathcal{N}(G)}(i_* M) = \dim_{\mathcal{N}(H)}(M)$.

Remark 2.9. For any $\phi \in \mathcal{N}(H)$, $i_*\phi$ is in $\mathcal{N}(G)$, because commuting with the left multiplications is the same as being equivariant for the group action.

2.6. The Fuglede-Kadison determinant.

Definition 2.10. Let G be a finitely generated group and U, V be two $\mathcal{N}(G)$ -modules. Let $f: U \rightarrow V$ be a map of $\mathcal{N}(G)$ -modules. The *spectral density* of f is the map $\lambda \in \mathbb{R}_{\geq 0} \mapsto F(f)(\lambda)$ defined by:

$$F(f)(\lambda) := \sup\{\dim_{\mathcal{N}(G)}(L) \mid L \in \mathcal{L}(f, \lambda)\}$$

where $\mathcal{L}(f, \lambda)$ is the set of sub- $\mathcal{N}(G)$ -modules of U on which the restriction of f has a norm smaller than or equal to λ .

Let us remark that $F(f)(\lambda)$ is monotonous and right-continuous, and so defines a measure $dF(f)$ on the Borel set of $\mathbb{R}_{\geq 0}$ solely determined by the $dF(f)(]a, b]) = F(f)(b) - F(f)(a)$ for all $a < b$.

Remark 2.11. Note that $\mathcal{L}(f, 0)$ is the set of sub- $\mathcal{N}(G)$ -modules of $\text{Ker}(f)$, and $F(f)(0) = \dim_{\mathcal{N}(G)}(\text{Ker}(f))$.

For any $\lambda \geq \|f\|$, $\mathcal{L}(f, \lambda)$ is the set of sub- $\mathcal{N}(G)$ -modules of U , and $F(f)(\lambda) = \dim_{\mathcal{N}(G)}(U)$.

Remark 2.12. For all λ , $F(f)(\lambda) = F(f^*f)(\lambda^2) = F(|f|)(\lambda)$ where $f^*f: U \rightarrow U$ is a positive operator and $|f|$ is its square root.

We can thus think with positive operators and observe that $dF(f)$ measures the «density of eigenvalues». If λ is atomic then $dF(f)(\lambda)$ is the von Neumann dimension of the eigenspace associated to λ .

Definition 2.13. The *Fuglede-Kadison determinant* of f is defined by:

$$\det_{\mathcal{N}(G)}(f) := \exp\left(\int_{0^+}^{\infty} \ln(\lambda) dF(f)(\lambda)\right)$$

if $\int_{0^+}^{\infty} \ln(\lambda) dF(f)(\lambda) > -\infty$; if not, $\det_{\mathcal{N}(G)}(f) = 0$.

When $\int_{0^+}^{\infty} \ln(\lambda) dF(f)(\lambda) > -\infty$, we say that f is of *determinant class*.

Here are several properties of the determinant we will use in the rest of this paper. The proofs can be found in [7].

Proposition 2.14. (1) $\det_{\mathcal{N}(G)}(0: U \rightarrow V) = 1$.

(2) For every nonzero complex number λ , $\det_{\mathcal{N}(G)}(\lambda \text{Id}_U) = |\lambda|$.

(3) For all f, g maps of $\mathcal{N}(G)$ -modules,

$$\det_{\mathcal{N}(G)}\left(\begin{pmatrix} f & 0 \\ 0 & g \end{pmatrix}\right) = \det_{\mathcal{N}(G)}(f) \cdot \det_{\mathcal{N}(G)}(g).$$

(4) For $f: U \rightarrow V$ and $g: V \rightarrow W$ both injective maps of $\mathcal{N}(G)$ -modules,

$$\det_{\mathcal{N}(G)}(g \circ f) = \det_{\mathcal{N}(G)}(g) \cdot \det_{\mathcal{N}(G)}(f).$$

(5) Let $f_1: U_1 \rightarrow V_1$, $f_2: U_2 \rightarrow V_2$ and $f_3: U_2 \rightarrow V_1$ be maps of $\mathcal{N}(G)$ -modules, such that f_1 and f_2 are injective. Then

$$\det_{\mathcal{N}(G)}\left(\begin{pmatrix} f_1 & f_3 \\ 0 & f_2 \end{pmatrix}\right) = \det_{\mathcal{N}(G)}(f_1) \cdot \det_{\mathcal{N}(G)}(f_2).$$

(6) Let $i: H \hookrightarrow G$ be an injective group homomorphism. Let M and N be two $\mathcal{N}(H)$ -modules and $f: M \rightarrow N$ be a map of $\mathcal{N}(H)$ -modules. Then

$$\det_{\mathcal{N}(G)}(i_*(f)) = \det_{\mathcal{N}(H)}(f).$$

Proposition 2.15. *Let $g \in G$ be of infinite order, let $t \in \mathbb{C}$, then $Id - tR_g$ is injective and*

$$\det_{\mathcal{N}(G)}(Id - tR_g) = \max(1, |t|).$$

The proof of this proposition can be found in [6, Proposition 3.2, Remark 3.3]. We offer the following proof for completeness, since the case $|t| \neq 1$ was not studied in detail in [6].

Proof. Let us note $f = Id - tR_g: \ell^2(G) \rightarrow \ell^2(G)$.

The assertion is clearly true for $t = 0$.

We will now use the following known way of computing Fuglede-Kadison determinants, proved in [3]: if $f_u, u \in [0; 1]$, is a norm-continuous piecewise C^1 path in $GL(U)$ (the group of all invertible maps of $\mathcal{N}(G)$ -modules $f: U \rightarrow U$) then

$$\frac{\det_{\mathcal{N}(G)}(f_1)}{\det_{\mathcal{N}(G)}(f_0)} = \exp \left(\int_0^1 \operatorname{Re} \left(\operatorname{tr}_{\mathcal{N}(G)} \left(f_u^{-1} \circ \frac{\partial f_u}{\partial u} \right) \right) du \right).$$

Let us assume $0 < |t| < 1$. Then we set $f_u = Id - utR_g$ for $u \in [0; 1]$. We have $f_0 = Id, f_1 = f, \frac{\partial f_u}{\partial u} = -tR_g$, and since R_g is unitary and $|t| < 1$,

$$f_u^{-1} = Id + \sum_{i=1}^{\infty} (ut)^i R_{g^i}.$$

Thus the previous formula gives:

$$\det_{\mathcal{N}(G)}(f) = \exp \left(\int_0^1 \operatorname{Re} \left(\operatorname{tr}_{\mathcal{N}(G)} \left(-tR_g - t \sum_{i=1}^{\infty} (ut)^i R_{g^{i+1}} \right) \right) dt \right)$$

therefore $\det_{\mathcal{N}(G)}(f) = \exp \left(\int_0^1 \operatorname{Re}(0) dt \right) = 1$ since g is of infinite order. Hence the assertion is proven.

Now let us assume that $|t| > 1$. Then $f = (-tR_g) \circ h$ where $h = Id - t^{-1}R_{g^{-1}}$. According to the previous case, $\det_{\mathcal{N}(G)}(h) = 1$. Besides, $(-tR_g)$ and h are invertible and $\det_{\mathcal{N}(G)}(R_g) = \det_{\mathcal{N}(G)}(R_g^* R_g)^{\frac{1}{2}} = \det_{\mathcal{N}(G)}(Id)^{\frac{1}{2}} = 1$ (according to [7, Lemma 3.15 (4)]), thus by Proposition 2.14 (2) and (4), $\det_{\mathcal{N}(G)}(f) = |t|$.

Finally, if $|t| = 1$, let us show that f is injective. Let $a = \sum_{\gamma \in G} a_{\gamma}[\gamma] \in \ell^2(G)$ such that $f(a) = 0$. Then $\sum_{\gamma \in G} (a_{\gamma} - ta_{\gamma g^{-1}})[\gamma] = 0$, therefore for all γ in G , all the $t^i a_{\gamma g^{-i}}$ are equal. Hence if a was nonzero, there would be a nonzero coefficient a_{γ} , but that would imply that

$$\|a\|^2 > \sum_{i \in \mathbb{Z}} |a_{\gamma g^i}|^2 = \sum_{i \in \mathbb{Z}} |t^i a_{\gamma}|^2 = +\infty$$

since $|t| = 1$. Thus $a = 0$ and f is injective.

Now, by Lemma 3.15 (4)-(5) in [7], $\det_{\mathcal{N}(G)}(f) = \lim_{\epsilon \rightarrow 0_+} \det_{\mathcal{N}(G)}(f^* f + \epsilon Id)^{1/2}$

and, by taking $t_{\epsilon} = 1 + \frac{1}{2}\epsilon + \sqrt{\epsilon + \frac{1}{4}\epsilon^2}$,

$$\begin{aligned} f^* f + \epsilon Id &= (2 + \epsilon)Id - R_g - R_g^* = \frac{2 + \epsilon}{1 + t_{\epsilon}^2} ((1 + t_{\epsilon}^2)Id - t_{\epsilon}R_g - t_{\epsilon}R_g^*) \\ &= \frac{2 + \epsilon}{1 + t_{\epsilon}^2} (Id - t_{\epsilon}R_g)^*(Id - t_{\epsilon}R_g). \end{aligned}$$

Since $t_{\epsilon} > 1$, we thus have $\det_{\mathcal{N}(G)}(Id - t_{\epsilon}R_g) = \max(1, t_{\epsilon}) \xrightarrow{\epsilon \rightarrow 0_+} 1$, therefore $\det_{\mathcal{N}(G)}(f) = 1$, and this completes the proof. \square

2.7. The L^2 -Alexander invariant. Let $K \subset S^3$ be a knot, G_K its knot group, and $P = \langle g_1, \dots, g_k \mid r_1, \dots, r_{k-1} \rangle$ a Wirtinger presentation of G_K .

For $t \in \mathbb{C}^*$ we define the algebra homomorphism:

$$\psi_{K,t}: \left(\begin{array}{ccc} \mathbb{C}[G_K] & \longrightarrow & \mathbb{C}[G_K] \\ \sum_{g \in G_K} c_g \cdot [g] & \longmapsto & \sum_{g \in G_K} c_g \cdot t^{\alpha_K(g)} \cdot [g] \end{array} \right)$$

and we also note $\psi_{K,t}$ its induction to any matrix ring with coefficients in $\mathbb{C}[G_K]$. Think of it as a way of «tensoring by the abelianization representation».

We say that (P, t) has *Property \mathcal{I}* if $R_{\psi_{K,t}(F_{P,1})}: l^2(G_K)^{k-1} \rightarrow l^2(G_K)^{k-1}$ is injective.

Definition 2.16. Let K be a knot, let P be a Wirtinger presentation of its knot group G_K , and let $t \in \mathbb{C}^*$.

If (P, t) has Property \mathcal{I} then the L^2 -Alexander invariant of K for the presentation P at t is written $\Delta_{K,P}^{(2)}(t)$ and is defined by:

$$\Delta_{K,P}^{(2)}(t) := \det_{\mathcal{N}(G_K)} (R_{\psi_{K,t}(F_{P,1})}) \in [0, \infty[.$$

Proposition 2.17. Let P and Q be two Wirtinger presentations with deficiency one of the same knot group G_K , and let $X_P \subset \mathbb{C}^*$ (resp. X_Q) be the set of t such that (P, t) (resp. (Q, t)) has Property \mathcal{I} .

Then $X_P = X_Q$ and there is an integer m such that $\Delta_{K,Q}^{(2)}(t) = \Delta_{K,P}^{(2)}(t) \cdot |t|^m$ for all t in X_P .

The proof of this proposition is somewhat technical. It is based on a study of Tietze transformations between Wirtinger presentations and of how the respective associated operators are consequently modified by these transformations. Compare with [12, Section 5] and [6, Proposition 3.4]. We include the following detailed proof for the sake of completeness.

Proof. Let P and Q be two Wirtinger presentations with deficiency one of the same knot group G_K . This means that P and Q were constructed respectively from two diagrams D and D' of the same knot K . Therefore D' is obtained from D by a finite sequence of planar isotopies and Reidemeister moves. As explained in [12, Lemma 6], this means that Q can be obtained from P by a finite sequence of certain Tietze transformations (and their inverses), that are:

- I_a . To replace one of the relators r_i by its inverse r_i^{-1}
- I_b . To replace one of the relators r_i by its conjugate wr_iw^{-1} where w is a word in the generators.
- I_c . To replace one of the relators r_i by its product $r_i r_k$ with a different relator ($k \neq i$)
- II_W . To add a new generator x and a new relator $x = w$ where w is of the form $x_j x_i x_j^{-1}$ or $x_j^{-1} x_i x_j$ with x_i and x_j some previous generators.
- III . To apply a permutation on the generators.

Note that we specified a new transformation III to describe the ambiguity in ordering the generators during the Wirtinger process, and that we only use II_W and not the II of [12, Section 1] because it is sufficient to describe the modifications caused by Reidemeister moves and it helps us ensure the following fact: if a sequence of such Tietze moves transforms the Wirtinger presentation P into the Wirtinger presentation Q , then all intermediate presentations are not necessarily of the Wirtinger form but they all have the fundamental property that *their generators are all conjugates of one another*.

To establish the proposition, it suffices to prove that if Q is obtained from P by a single previous transformation, then $X_P = X_Q$ and there is an integer m such that $\Delta_{K,Q}^{(2)}(t) = \Delta_{K,P}^{(2)}(t) \cdot |t|^m$ for all t in X_P .

Firstly, if Q is obtained from P by a I_a move, for example the j -th relator r is changed to r^{-1} , then by construction the respective free groups in the generators and quotient maps are the same (notably $Gr(P) = Gr(Q)$). Remark that this will also be the case for moves of type I_b , I_c and III . Since

$$\overline{\frac{\partial}{\partial x}(r^{-1})} = \overline{\left(-r^{-1} \frac{\partial}{\partial x}(r)\right)} = -\overline{\frac{\partial}{\partial x}(r)},$$

we deduce that $\psi_{K,t}(F_{Q,1})$ is simply $\psi_{K,t}(F_{P,1})$ with the j -th column multiplied by -1 . Therefore the right-multiplication associated operators are both injective for the same values of t , i.e. $X_P = X_Q$, and furthermore $\Delta_{K,Q}^{(2)}(t) = \Delta_{K,P}^{(2)}(t)$, by Proposition 2.14 (2) and (4).

Secondly, if Q is obtained from P by a I_b move, for example the j -th relator r is changed to wrw^{-1} with w a word in the generators, then since

$$\begin{aligned} \overline{\frac{\partial}{\partial x}(wrw^{-1})} &= \overline{\frac{\partial}{\partial x}(w) + w \frac{\partial}{\partial x}(r) + wr \frac{\partial}{\partial x}(w^{-1})} \\ &= \overline{\frac{\partial}{\partial x}(w) + w \frac{\partial}{\partial x}(r) + wr \left(-w^{-1} \frac{\partial}{\partial x}(w)\right)} \\ &= \overline{\frac{\partial}{\partial x}(w) + w \frac{\partial}{\partial x}(r) - w \frac{\partial}{\partial x}(w)} \\ &= \overline{\frac{\partial}{\partial x}(r)}, \end{aligned}$$

we deduce that $\psi_{K,t}(F_{Q,1})$ is simply $\psi_{K,t}(F_{P,1})$ with the j -th column multiplied on the left by $\psi_{K,t}(\overline{w}) = t^m \overline{w}$ where m is an integer. Thus the associated right-multiplication operators are equal up to composition by the diagonal operator of j -th coefficient $R_{t^m w}$ and other coefficients Id ; this operator is invertible and of Fuglede-Kadison determinant $|t|^m$. Therefore $\psi_{K,t}(F_{Q,1})$ and $\psi_{K,t}(F_{P,1})$ are both injective for the same values of t , i.e. $X_P = X_Q$, and furthermore $\Delta_{K,Q}^{(2)}(t) = \Delta_{K,P}^{(2)}(t) \cdot |t|^m$, by Proposition 2.14 (2) and (4).

Thirdly, if Q is obtained from P by a I_c move, for example the j -th relator r is changed to rr' with r' the l -th relator, then since

$$\overline{\frac{\partial}{\partial x}(rr')} = \overline{\frac{\partial}{\partial x}(r) + r \frac{\partial}{\partial x}(r')} = \overline{\frac{\partial}{\partial x}(r)} + \overline{\frac{\partial}{\partial x}(r')},$$

we deduce that $\psi_{K,t}(F_{Q,1})$ is simply $\psi_{K,t}(F_{P,1})$ where the l -th column was added to the j -th one. Proposition 2.14 (2) and (4) let us conclude that $X_P = X_Q$ (composing by an invertible transvection operator does not change the injectivity) and that $\Delta_{K,Q}^{(2)}(t) = \Delta_{K,P}^{(2)}(t)$ (since a transvection operator has Fuglede-Kadison determinant 1).

Fourthly, suppose that Q is obtained from P by a II_W move, then write $P = \langle g_1, \dots, g_k \mid r_1, \dots, r_{k-1} \rangle$ and $Q = \langle g_1, \dots, g_k, h \mid r_1, \dots, r_{k-1}, wh^{-1} \rangle$ where w is a word in the g_i . Here $Gr(P)$ and $Gr(Q)$ are naturally isomorphic via

$$Gr(P) = \mathbb{F}[g_i] / \langle r_j \rangle \hookrightarrow \mathbb{F}[g_i, h] / \langle r_j \rangle \twoheadrightarrow \mathbb{F}[g_i, h] / \langle r_j, wh^{-1} \rangle = Gr(Q)$$

(where $\langle r_j \rangle$ is the normal generated subgroup), therefore we dare an abuse of notation by writing

$$F_Q = \begin{matrix} & r_1 & \dots & r_{k-1} & wh^{-1} \\ g_1 & \left(\begin{array}{ccc|c} & & & * \\ & F_P & & \vdots \\ & & & * \\ 0 & \dots & 0 & -1 \end{array} \right) \end{matrix}$$

where the $*$ are elements of $\mathbb{Z}[G_K]$. Thus $R_{\psi_{K,t}(F_{Q,1})}$ is injective if and only if $R_{\psi_{K,t}(F_{P,1})}$ is injective, i.e. $X_P = X_Q$. Hence, by Proposition 2.14 (2) and (5), $\Delta_{K,Q}^{(2)}(t) = \Delta_{K,P}^{(2)}(t)$ for all $t \in X_P$.

Finally, suppose that Q is obtained from P by a *III* move. A permutation is a finite product of transpositions, therefore we can assume that the *III* move is a transposition τ .

Let us assume that τ leaves the first generator fixed. In this case the Fox matrix $F_{Q,1}$ is $F_{P,1}$ with two of its rows swapped, i.e. $F_{Q,1}$ is equal to $F_{P,1}$ multiplied by a permutation matrix S . Since the associated operator $R_{\psi_{K,t}(S)} = R_S$ is unitary, it is invertible and has Fuglede-Kadison determinant 1. Thus $R_{\psi_{K,t}(F_{Q,1})}$ is injective if and only if $R_{\psi_{K,t}(F_{P,1})}$ is injective, i.e. $X_P = X_Q$. Hence, by Proposition 2.14 (5), $\Delta_{K,Q}^{(2)}(t) = \Delta_{K,P}^{(2)}(t)$ for all $t \in X_P$.

Now let us assume that τ swaps the first and second generators. We write $F_P = \begin{pmatrix} L_1 \\ L_2 \\ \vdots \\ L_k \end{pmatrix}$ and $F_Q = \begin{pmatrix} L_2 \\ L_1 \\ \vdots \\ L_k \end{pmatrix}$ where $L_i = \left(\overline{\frac{\partial r_j}{\partial g_i}} \right)_{1 \leq j \leq k}$ denotes the i -th row of

F_P . Let us remind the reader that the generators g_i are conjugates of one another, therefore they have the same image 1 by the abelianization α_K , which means that $\psi_{K,t}(g_i) = tg_i - 1$ for each i .

The fundamental formula of Fox calculus (see for instance [2, Proposition 9.8]) states that the following formula stands in $\mathbb{C}[G_K]$:

$$(*) \quad \sum_{i=1}^k L_i \cdot (\overline{g_i} - 1) = 0.$$

$$\text{Let } A = \begin{pmatrix} R_{tg_2-1} & & & 0 \\ & R_{tg_3-1} & & \\ & & \ddots & \\ 0 & & & R_{tg_k-1} \end{pmatrix}, B = \begin{pmatrix} R_{tg_1-1} & & & 0 \\ & R_{tg_3-1} & & \\ & & \ddots & \\ 0 & & & R_{tg_k-1} \end{pmatrix}$$

$$\text{and } C = \begin{pmatrix} -Id & -Id & \dots & -Id \\ & Id & & 0 \\ & & \ddots & \\ 0 & & & Id \end{pmatrix}. \text{ We recognize a transvection matrix in } C,$$

which is thus invertible and with determinant 1. Proposition 2.15 tells us that A and B are injective and that their Fuglede-Kadison determinant is $\max(1, |t|)^{k-1}$.

The formula (*) implies the following equality for operators:

$$\begin{aligned} C \circ A \circ R_{\psi_{K,t}(F_{P,1})} &= \begin{pmatrix} -R_{\psi_{K,t}(L_1(g_1-1))} - R_{\psi_{K,t}(L_3(g_3-1))} - \dots - R_{\psi_{K,t}(L_k(g_k-1))} \\ R_{\psi_{K,t}(L_3(g_3-1))} \\ \vdots \\ R_{\psi_{K,t}(L_k(g_k-1))} \end{pmatrix} \\ &= \begin{pmatrix} R_{\psi_{K,t}(L_2(g_2-1))} \\ R_{\psi_{K,t}(L_3(g_3-1))} \\ \vdots \\ R_{\psi_{K,t}(L_k(g_k-1))} \end{pmatrix} = B \circ R_{\psi_{K,t}(F_{Q,1})} \end{aligned}$$

Since C, A and B are injective, $R_{\psi_{K,t}(F_{P,1})}$ is injective if and only if $R_{\psi_{K,t}(F_{Q,1})}$ is injective, i.e. $X_P = X_Q$. Finally, by Proposition 2.14 (4) and the values of the determinants of A, B, C , we conclude that $\Delta_{K,Q}^{(2)}(t) = \Delta_{K,P}^{(2)}(t)$ for all $t \in X_P$.

Any permutation can be decomposed as a finite product of transpositions swapping the first and second elements and transpositions leaving the first element fixed. Therefore the case of the *III* move is treated, and the proposition is proven. \square

Definition 2.18. Let K be a knot. Let P be any Wirtinger presentation of its knot group G_K . Let X_K be the set of $t \in \mathbb{C}^*$ such that (P, t) has Property \mathcal{I} (according to the previous proposition, this does not depend on P). The L^2 -Alexander invariant of K at t is written $(t \mapsto \Delta_K^{(2)}(t))$ and is defined as the class of $(t \mapsto \Delta_{K,P}^{(2)}(t))$ up to multiplication by $(t \mapsto |t|^{\mathbb{Z}})$ on the maps from X_K to $\mathbb{R}_{\geq 0}$.

It is a knot invariant by the previous proposition.

Remark 2.19. Until now we know of no knots K such that $X_K \neq \mathbb{C}^*$. However we know that X_K always contains at least the entire unit circle, thanks to Theorem 2.23.

Remark 2.20. Let us remark that we can take $F_{P,i}$ for any $i \neq 1$ instead of $F_{P,1}$ in the definition of the invariant, since it simply corresponds to an other Wirtinger presentation where the generators are permuted.

Example 2.21. Let us compute the invariant for the trivial knot O .

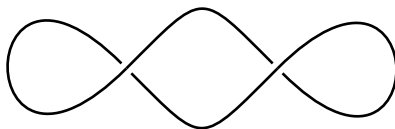

FIGURE 4. A diagram for the unknot

The «doubly twisted rubber band» knot diagram of Figure 4 gives the Wirtinger presentation $P = \langle g, h | gh^{-1} \rangle$ of the unknot group G_O (which is isomorphic to \mathbb{Z}), and the associated Fox matrix is $F_P = \begin{pmatrix} 1 \\ -1 \end{pmatrix}$.

Therefore for all t in \mathbb{C}^* , $R_{\psi_{O,t}(F_{P,1})} = -Id: l^2(G_O) \rightarrow l^2(G_O)$ has Property \mathcal{I} and $\Delta_{O,P}^{(2)}(t) = 1$. Thus, the invariant for the trivial knot is the constant map equal to 1.

The following result is proven for the unit circle in [6, Section 6] and can be easily extended to \mathbb{C}^* .

Proposition 2.22. (1) *Let K be a knot and P a Wirtinger presentation of G_K , and let $t \in \mathbb{C}^*$. Then (P, t) has Property \mathcal{I} if and only if $(P, |t|)$ has Property \mathcal{I} .*

(2) *Let K be a knot and $t \in \mathbb{C}^*$, such that there is a Wirtinger presentation P with (P, t) having Property \mathcal{I} . Then $\Delta_K^{(2)}(t) = \Delta_K^{(2)}(|t|)$.*

We will now always assume $t > 0$. The L^2 -Alexander invariant is thus a class of maps from $\mathbb{R}_{>0}$ to $\mathbb{R}_{\geq 0}$ (up to multiplication by $(t \mapsto t^m)$, $m \in \mathbb{Z}$).

The following theorem was proven by Lück for the L^2 -torsion, but, similarly to Milnor's proof that the Alexander polynomial can be seen as a Reidemeister torsion, we can express the L^2 -Alexander invariant of K as a simple function of a L^2 -torsion of M_K (see for example [6, Section 5]).

Theorem 2.23 ([7, Theorem 4.6]). *If K is a non-trivial knot then the 3-manifold M_K is irreducible and, according to the JSJ-decomposition, splits along disjoint incompressible tori into pieces that are Seifert manifolds or hyperbolic manifolds. The hyperbolic pieces M_1, \dots, M_h have all finite hyperbolic volume, and*

$$\Delta_K^{(2)}(1) = \exp\left(\frac{1}{6\pi} \sum_{i=1}^h \text{vol}(M_i)\right) = \exp\left(\frac{1}{6\pi} \|M_K\|\right)$$

where vol is the hyperbolic volume and $\|\cdot\|$ is the Gromov norm.

Hence we now have the value of the invariant on one point. It is 1 for torus knots, and for K a hyperbolic knot it is an exponential of its hyperbolic volume, which was already known to be a strong knot invariant. We hope that the values for $t \neq 1$ can give relevant additional information.

To conclude this section, let us mention that we do not need to use a Wirtinger presentation P to compute $\Delta_K^{(2)}(t)$.

Theorem 2.24 ([5, Theorem 3.5 and Proposition 6.2]).

(1) *Let K be a knot, G_K its knot group, and $P = \langle g_1, \dots, g_k \mid r_1, \dots, r_{k-1} \rangle$ any deficiency one presentation of G_K . If $t > 0$ is such that (P, t) has Property \mathcal{I} , then $\frac{\det_{\mathcal{N}(G_K)}(R_{\psi_{K,t}(F_{P,1})})}{\max(1, t)^{|\alpha_K(g_1)|-1}}$ does not depend on P , and is equal to $\Delta_{K,P}^{(2)}(t)$ when P is Wirtinger. Thus we will also call this quantity $\Delta_{K,P}^{(2)}(t)$.*

(2) *If K is the (p, q) -torus knot, then for any $t > 0$, $\Delta_K^{(2)}(t)$ is defined and equals $\max(1, t)^{(|p|-1)(|q|-1)}$.*

We will use this powerful result to prove the cabling formula in Section 4.

Remark 2.25. This theorem implies that the L^2 -Alexander invariant is not a complete knot invariant. For example $T(2, 7)$ and $T(3, 4)$ are distinct torus knots but they both have $t \mapsto \max(1, t)^6$ as their L^2 -Alexander invariant.

However the L^2 -Alexander invariant detects if a knot is the unknot, as we will see in Section 5.

We can also use this theorem to compute the invariant of the mirror image of a knot.

Proposition 2.26. *Let K be a knot in S^3 and K^* its mirror image. Let P be a Wirtinger presentation of G_K and let $t > 0$. Suppose (P, t) has Property \mathcal{I} .*

Then G_{K^} admits a group presentation P^* naturally obtained from P , (P^*, t^{-1}) has Property \mathcal{I} and $\Delta_{K^*}^{(2)}(t^{-1}) = \Delta_K^{(2)}(t)$.*

Proof. Take a diagram D of K and its image D' by a planar reflection by a line not intersecting D . Then D' is a diagram for K^* . Take a base point in \mathbb{R}^3 above the plane of the diagrams D and D' .

Each crossing of D corresponds to a crossing of D' as in Figure 5.

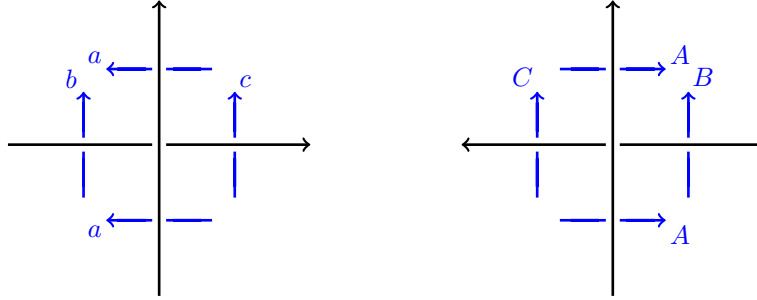

FIGURE 5. A crossing of D , its mirror image in D' , and the associated meridian loops

Let $P = \langle a_i | r_j \rangle$ be a Wirtinger presentation of $G_K = \pi_1(S^3 \setminus K)$ associated to D . Its relators are of the form $aba^{-1}c^{-1}$. As in Figure 5, for each generator a_i of P , define A_i a (negatively-oriented) meridian loop of D' , and for $r_j = aba^{-1}c^{-1}$, define $R_j = ABA^{-1}C^{-1}$. Then $P^* = \langle A_i | R_j \rangle$ is a presentation for $G_{K^*} = \pi_1(S^3 \setminus K^*)$. Note that $\alpha_{K^*}(A_i) = -1$ for all i .

Let $\phi : G_K \rightarrow G_{K^*}$ denote the natural group isomorphism sending a_i to A_i and its induction on the associated complex group algebras. Then

$$\begin{array}{ccc} \mathbb{C}[G_K] & \xrightarrow{\psi_{K,t}} & \mathbb{C}[G_K] \\ \downarrow \phi & & \downarrow \phi \\ \mathbb{C}[G_{K^*}] & \xrightarrow{\psi_{K^*,t^{-1}}} & \mathbb{C}[G_{K^*}] \end{array}$$

is a commutative diagram, since $\psi_{K^*,t^{-1}}(A_i) = tA_i$ for all i .

Suppose (P, t) has Property \mathcal{I} , thus $R_{\psi_{K,t}(F_{P,1})}$ is injective. Therefore, by Proposition 2.8 (1), Lemma 3.1 and Proposition 2.8 (2), in this order,

$$(\phi)_*(R_{\psi_{K,t}(F_{P,1})}) = R_{\phi(\psi_{K,t}(F_{P,1}))} = R_{\psi_{K^*,t^{-1}}(\phi(F_{P,1}))} = R_{\psi_{K^*,t^{-1}}(F_{P^*,1})}$$

is injective. Thus (P^*, t^{-1}) has Property \mathcal{I} .

By Theorem 2.24, since P^* has deficiency one,

$$\Delta_{K^*}^{(2)}(t^{-1}) = \frac{\det_{\mathcal{N}(G_{K^*})}(R_{\psi_{K^*,t^{-1}}(F_{P^*,1})})}{\max(1, t)^{|\alpha_{K^*}(A_1)|-1}} = \det_{\mathcal{N}(G_{K^*})}((\phi)_*(R_{\psi_{K,t}(F_{P,1})})),$$

and by Proposition 2.14 (6) we conclude that $\Delta_{K^*}^{(2)}(t^{-1}) = \Delta_K^{(2)}(t)$. \square

3. THE L^2 -ALEXANDER INVARIANT OF A COMPOSITE KNOT

Let K_1 and K_2 be knots in S^3 and K their connected sum. We prove that the L^2 -Alexander invariant of K can be calculated from those of its factors. This multiplicativity of the invariant can be compared to the classical property of the Alexander polynomial of a composite knot, cf for example [2, Proposition 8.14].

Lemma 3.1. *Let K be the connected sum of K_1 and K_2 , with G, G_1 and G_2 their respective groups.*

Then for $j = 1, 2$ and for all $t > 0$ we have the commutative diagram

$$\begin{array}{ccc} \mathbb{C}[G_j] & \xrightarrow{\psi_{K_j,t}} & \mathbb{C}[G_j] \\ \downarrow i_j & & \downarrow i_j \\ \mathbb{C}[G] & \xrightarrow{\psi_{K,t}} & \mathbb{C}[G] \end{array}$$

where $i_j: G_j \hookrightarrow G$ denotes both the group inclusion of Proposition 2.3 and its induction on the complex group algebras.

Proof. Let us take P_1, P_2 and P like in Proposition 2.1, and $t > 0$. We have

$$P_1 = \langle x_1, \dots, x_k | r_1, \dots, r_{k-1} \rangle,$$

$$P_2 = \langle y_1, \dots, y_l | s_1, \dots, s_{l-1} \rangle,$$

$$P = \langle x_1, \dots, x_k, y_1, \dots, y_l | r_1, \dots, r_{k-1}, s_1, \dots, s_{l-1}, x_k y_l^{-1} \rangle.$$

These three presentations are Wirtinger, therefore the x_i are sent to 1 by α_{K_1} as elements of G_1 and by α_K as elements of G , and the same can be said for the generators y_j .

Therefore the diagram is commutative for any $[g] \in \mathbb{C}[G_j]$ where g is a generator of P_1 or P_2 . The result follows from the fact that the $\psi_{\cdot,t}$ and i_j are algebra homomorphisms and that the previous $[g]$ generate the two group algebras. \square

Theorem 3.2. *Let K be the connected sum of K_1 and K_2 , with G, G_1 and G_2 their respective groups, and P, P_1, P_2 the presentations given by Proposition 2.1.*

Let t be any positive number. If we assume that (P_1, t) and (P_2, t) have Property \mathcal{I} , then (P, t) has Property \mathcal{I} and $\Delta_K^{(2)}(t) = \Delta_{K_1}^{(2)}(t) \Delta_{K_2}^{(2)}(t)$.

Proof. Let P_1, P_2 and P be like in Proposition 2.1, and $t > 0$. We have two injective group homomorphisms $i_1: G_1 \hookrightarrow G$ and $i_2: G_2 \hookrightarrow G$ by Proposition 2.3.

The values of P, P_1, P_2 imply that $R_{\psi_{K,t}(F_P)}$ is written:

$$\begin{array}{c} \begin{array}{c} x_1 \\ \vdots \\ x_{k-1} \\ x_k \\ y_1 \\ \vdots \\ y_{l-1} \\ y_l \end{array} \left(\begin{array}{ccc|ccc|c} r_1 & \dots & r_{k-1} & s_1 & \dots & s_{l-1} & x_k y_l^{-1} \\ \hline 0 & \dots & 0 & \vdots & \dots & \vdots & \vdots \\ \hline & R_{\psi_{K,t}(i_1(F_{P_1,k}))} & & 0 & \dots & 0 & 0 \\ \hline & * & & 0 & \dots & 0 & Id \\ \hline 0 & \dots & 0 & \vdots & \dots & \vdots & \vdots \\ \hline & & & R_{\psi_{K,t}(i_2(F_{P_2,l}))} & & & \\ \hline 0 & \dots & 0 & \vdots & \dots & \vdots & 0 \\ \hline 0 & \dots & 0 & * & & & -Id \end{array} \right) \end{array}$$

(P_1, t) has Property \mathcal{I} thus $R_{\psi_{K_1,t}(F_{P_1,k})}$ is injective (by Remark 2.20). Therefore, by Proposition 2.8 (1), Lemma 3.1 and Proposition 2.8 (2), in this order,

$$(i_1)_*(R_{\psi_{K_1,t}(F_{P_1,k})}) = R_{i_1(\psi_{K_1,t}(F_{P_1,k}))} = R_{\psi_{K,t}(i_1(F_{P_1,k}))}$$

is injective. Similarly, $R_{\psi_{K,t}(i_2(F_{P_2,l}))}$ is injective. Finally, $-Id_{\ell^2(G)}$ is clearly injective.

Therefore the block trigonal matrix $R_{\psi_{K,t}(F_P)}$ is injective, thus, by Remark 2.20, (P, t) has Property \mathcal{I} .

Hence by Proposition 2.14 (5) and (2),

$$\det_{\mathcal{N}(G)}(R_{\psi_{K,t}(F_P)}) = \det_{\mathcal{N}(G)}(R_{\psi_{K,t}(i_1(F_{P_1,k}))}) \cdot \det_{\mathcal{N}(G)}(R_{\psi_{K,t}(i_2(F_{P_2,l}))}).$$

Finally,

$$\det_{\mathcal{N}(G)} \left(R_{\psi_{K,t}(i_1(F_{P_1,k}))} \right) = \det_{\mathcal{N}(G)} \left((i_1)_* (R_{\psi_{K_1,t}(F_{P_1,k})}) \right) = \det_{\mathcal{N}(G_1)} \left(R_{\psi_{K_1,t}(F_{P_1,k})} \right)$$

by Lemma 3.1 and Proposition 2.14 (6). We use a similar argument for the second term, and thus

$$\Delta_K^{(2)}(t) = \Delta_{K_1}^{(2)}(t) \Delta_{K_2}^{(2)}(t).$$

□

4. THE L^2 -ALEXANDER INVARIANT OF A CABLE KNOT

Lemma 4.1. *Let S be the (p,q) -cable of C , and let G_S, G_C be their respective groups. Then for all $t > 0$ we have the commutative diagram*

$$\begin{array}{ccc} \mathbb{C}[G_C] & \xrightarrow{\psi_{C,t^p}} & \mathbb{C}[G_C] \\ \downarrow i_C & & \downarrow i_C \\ \mathbb{C}[G_S] & \xrightarrow{\psi_{S,t}} & \mathbb{C}[G_S] \end{array}$$

where $i_C: G_C \hookrightarrow G_S$ denotes both the group inclusion of Proposition 2.4 and its induction on the complex group algebras.

Proof. Let us take $P_C = \langle a_1, \dots, a_k | r_1, \dots, r_{k-1} \rangle$ and

$$P_S = \langle a_1, \dots, a_k, x, \lambda | r_1, \dots, r_{k-1}, x^p a_k^{-q} \lambda^{-p}, \lambda^{-1} W(a_i) \rangle$$

like in Proposition 2.2. Let $t > 0$.

Proposition 2.2 (2) tells us that every a_i is sent to 1 by α_C as an element of G_C and is sent to p by α_S as an element of G_S .

Therefore the diagram is commutative for any $[a_i] \in \mathbb{C}[G_C]$ where a_i is a generator of P_C . The lemma follows from the fact that ψ_{C,t^p} , $\psi_{S,t}$ and i_C are algebra homomorphisms and that the $[a_i]$ generate $\mathbb{C}[G_C]$. □

Lemma 4.2. *Let G be a discrete countable group, let $g \in G$ of infinite order, let p be a positive integer and let $t > 0$. Then $Id + tR_g + \dots + t^{(p-1)}R_{g^{p-1}}$ is injective and*

$$\det_{\mathcal{N}(G)} \left(Id + tR_g + \dots + t^{(p-1)}R_{g^{p-1}} \right) = \max(1, t)^{p-1}.$$

Proof. Let us note $R = Id + tR_g + \dots + t^{(p-1)}R_{g^{p-1}}$.

We have $(Id - tR_g) \circ R = Id - t^p R_{g^p}$. By Proposition 2.15, $Id - t^p R_{g^p}$ is injective, therefore R is injective.

Both $Id - tR_g$ and R are injective, therefore, by Proposition 2.14 (4),

$$\det_{\mathcal{N}(G)} (Id - t^p R_{g^p}) = \det_{\mathcal{N}(G)} (Id - tR_g) \cdot \det_{\mathcal{N}(G)} (R).$$

Thus, by Proposition 2.15, $\max(1, t^p) = \max(1, t) \cdot \det_{\mathcal{N}(G)} (R)$ and the lemma follows. □

Theorem 4.3. *Let S be the (p,q) -cable knot of companion knot C , G_S, G_C their respective groups, and t any positive real number.*

If there exists P_w a Wirtinger presentation of G_C such that (P_w, t^p) has Property \mathcal{I} , then there is a presentation P_S of G_S such that (P_S, t) has Property \mathcal{I} , and

$$\Delta_S^{(2)}(t) = \Delta_C^{(2)}(t^p) \cdot \max(1, t)^{(|p|-1)(|q|-1)} = \Delta_C^{(2)}(t^p) \Delta_{T(p,q)}^{(2)}(t).$$

Proof. Let $P_C = \langle a_1, \dots, a_k | r_1, \dots, r_{k-1} \rangle$ and

$$P_S = \langle a_1, \dots, a_k, x, \lambda | r_1, \dots, r_{k-1}, x^p a_k^{-q} \lambda^{-p}, \lambda^{-1} W(a_i) \rangle$$

be like in Proposition 2.2.

Remark that P_C is a Wirtinger presentation of G_C , as is P_w , therefore (P_C, t^p) also has Property \mathcal{I} , by Proposition 2.17.

Besides, P_S is a presentation of deficiency one, thus by Theorem 2.24, $\Delta_S^{(2)}(u)$ will be equal to $\Delta_{S, P_S}^{(2)}(u)$ for any $u > 0$ such that (P_S, u) has Property \mathcal{I} .

Recall from Proposition 2.2 (2) that $\alpha_S(a_i) = p$, $\alpha_S(x) = q$ and $\alpha_S(\lambda) = 0$.

The values of P_S and P_C imply that $R_{\psi_S, t(F_{P_S})}$ is written:

$$\begin{array}{c} a_1 \\ \vdots \\ a_{k-1} \\ a_k \\ x \\ \lambda \end{array} \left(\begin{array}{ccc|cc} r_1 & \dots & r_{k-1} & x^p a_k^{-q} \lambda^{-p} & \lambda W(a_i)^{-1} \\ & & & 0 & * \\ & & & \vdots & \vdots \\ & & & 0 & * \\ \hline * & \dots & * & * & * \\ \hline 0 & \dots & 0 & T & 0 \\ \hline 0 & \dots & 0 & * & Id \end{array} \right)$$

where $T = Id + t^q R_x + \dots + t^{q(p-1)} R_{x^{p-1}}$ if p is positive, and

$$T = -t^{-q} R_{x^{-1}} - \dots - t^{-q|p|} R_{x^p} = \left(-t^{-q|p|} R_{x^p} \right) \circ \left(Id + t^q R_x + \dots + t^{q(|p|-1)} R_{x^{|p|-1} } \right)$$

if p is negative. In both cases T is injective, by Lemma 4.2 and the fact that $(-t^{-q|p|} R_{x^p})$ is invertible.

We know (P_C, t^p) has Property \mathcal{I} , thus $R_{\psi_C, t^p(F_{P_C, k})}$ is injective, by Remark 2.20. We have the injective group homomorphism $i_C: G_C \hookrightarrow G_S$ by Proposition 2.4. Therefore, by Proposition 2.8 (1), Lemma 4.1 and Proposition 2.8 (2), in this order,

$$(i_C)_*(R_{\psi_C, t^p(F_{P_C, k})}) = R_{i_C(\psi_C, t^p(F_{P_C, k}))} = R_{\psi_S, t(i_C(F_{P_C, k}))}$$

is injective.

Finally $Id_{\ell^2(G)}$ is clearly injective.

Thus the block trigonal square matrix $R_{\psi_S, t(F_{P_S, k})}$ is injective, hence, by Remark 2.20, (P_S, t) has Property \mathcal{I} . Therefore, by Proposition 2.14 (5) and (2),

$$\det_{\mathcal{N}(G_S)} \left(R_{\psi_S, t(F_{P_S, k})} \right) = \det_{\mathcal{N}(G_S)} \left(R_{\psi_S, t(i_C(F_{P_C, k}))} \right) \cdot \det_{\mathcal{N}(G_S)} (T).$$

However we have

$$\det_{\mathcal{N}(G_S)} \left(R_{\psi_S, t(i_C(F_{P_C, k}))} \right) = \det_{\mathcal{N}(G_S)} \left((i_C)_*(R_{\psi_C, t^p(F_{P_C, k})}) \right) = \det_{\mathcal{N}(G_C)} \left(R_{\psi_C, t^p(F_{P_C, k})} \right)$$

by Lemma 4.1 and Proposition 2.14 (6).

Besides, from Lemma 4.2, we have

$$\det_{\mathcal{N}(G_S)} \left(Id + t^q R_x + \dots + t^{q(|p|-1)} R_{x^{|p|-1} } \right) = \max(1, t^q)^{|p|-1},$$

therefore, by the fact that $\det_{\mathcal{N}(G_S)} (-t^{-q|p|} R_{x^p}) \in t^{\mathbb{Z}}$ and Proposition 2.14 (4), $\det_{\mathcal{N}(G_S)}(T)$ is equal to $\max(1, t^q)^{|p|-1}$ up to $t^{\mathbb{Z}}$.

Note that for $t > 0$ and any integer k , $\max(1, t^k) = t^{\frac{k-|k|}{2}} \max(1, t)^{|k|}$, therefore $\max(1, t^q)^{|p|-1} = \max(1, t)^{|q|(|p|-1)}$ up to $t^{\mathbb{Z}}$.

Finally, Theorem 2.24 tells us that

$$\Delta_S^{(2)}(t) = \frac{\det_{\mathcal{N}(G_S)}(R_{\psi_S, t(F_{P_S, k})})}{\max(1, t)^{|\alpha_S(a_k)|-1}} = \frac{\det_{\mathcal{N}(G_C)} \left(R_{\psi_C, t^p(F_{P_C, k})} \right) \cdot \max(1, t)^{|q|(|p|-1)}}{\max(1, t)^{|p|-1}}.$$

Thus we have proven the formula

$$\Delta_S^{(2)}(t) = \Delta_C^{(2)}(t^p) \cdot \max(1, t)^{(|p|-1)(|q|-1)}.$$

□

Remark 4.4. A crucial part of this proof is the fact that the presentation of the group of the pattern knot inside its solid torus was easy to compute and manipulate (cf Section 6).

A general satellite formula mirroring the classical one for the Alexander polynomial (cf for instance [2, Proposition 8.23]) is plainly untrue if written as $\Delta_{S_{C,P}}^{(2)}(t) = \Delta_C^{(2)}(t^{n_P})\Delta_P^{(2)}(t)$.

Indeed, if P is a Whitehead double pattern inside the solid torus T_P , i.e. if $S_{C,P}$ is a Whitehead double of C , and if C is a non trivial knot of Gromov norm zero, then n_P is zero, P is trivial in S^3 and $\Delta_{S_{C,P}}^{(2)}$ would then be the constant map ($t \mapsto 1$) according to the previous formula; but we are going to show in Theorem 5.1 that it cannot be since $S_{C,P}$ is not the unknot.

Corollary 4.5. *Let K be a knot, $-K$ its inverse knot, and P and P_- Wirtinger presentations of their respective groups. Then for all positive real numbers t , (P, t) has Property \mathcal{I} if and only if (P_-, t^{-1}) has Property \mathcal{I} , and in this case*

$$\Delta_{-K}^{(2)}(t^{-1}) = \Delta_K^{(2)}(t).$$

Proof. Remark that $-K$ is a $(-1, m)$ -cable of K with m any integer, and apply Theorem 4.3. □

5. DETECTION OF THE UNKNOT

In [7], Lück (Theorem 4.7 (2)) proves that the pair composed of the L^2 -torsion and the Alexander polynomial detects the unknot. We prove a similar result for the L^2 -Alexander invariant:

Theorem 5.1. *Let K be a knot in S^3 . The L^2 -Alexander invariant of K is trivial, i.e. $(t \mapsto \Delta_K^{(2)}(t)) = (t \mapsto 1)$, if and only if K is the trivial knot.*

This seems to confirm that the L^2 -Alexander invariant can be seen as a generalization of both the L^2 -torsion (i.e. the Gromov norm) and the Alexander polynomial.

Proof. First, let K_0 be an arbitrary knot. If the exterior of K_0 has hyperbolic pieces in its JSJ decomposition, then $\Delta_{K_0}^{(2)}(1) \neq 1$, by Theorem 2.23. Therefore, let us assume \tilde{K} is a knot whose exterior does not have hyperbolic pieces and such that $\Delta_{\tilde{K}}^{(2)} = (t \mapsto 1)$. Let us prove that \tilde{K} is the unknot.

Besides, [9, Lemma 5.5] tells us that if we call \mathcal{K} the class of knots generated by the unknot, the connected sum operation, and all cabling operations (for all torus knot patterns), then $\tilde{K} \in \mathcal{K}$.

Let us prove that for all knots K in the class \mathcal{K} , $\Delta_K^{(2)} = (t \mapsto \max(1, t)^{n_K})$ where n_K is a nonnegative integer.

From Example 2.21, it is true for the unknot and $n_O = 0$. Secondly, if the property is true for K_1 and K_2 in \mathcal{K} , then, by Theorem 3.2, it is true for their connected sum $K_1 \sharp K_2$ and $n_{K_1 \sharp K_2} = n_{K_1} + n_{K_2}$. Finally, if the property is true for $C \in \mathcal{K}$ and S is the (p, q) -cable of C , then, it is true for S and $n_S = |p| \cdot n_C + (|p| - 1)(|q| - 1)$, by Theorem 4.3.

Observe that $n_{K_1 \sharp K_2} = 0$ if and only if $n_{K_1} = n_{K_2} = 0$, and $n_S = 0$ if and only if $n_C = 0$ and $p = \pm 1$ (i.e. the cabling operation is trivial or the knot inversion).

Therefore, the subclass \mathcal{K}' of knots K' in \mathcal{K} such that $n_{K'} = 0$ is exactly the class generated by O , the connected sum, the trivial cabling operation and the reversing of the orientation of the knot. But this class is reduced to O . Therefore, for $K \in \mathcal{K}$, $n_K = 0$ if and only if $K = O$.

Thus, if \tilde{K} is a knot whose exterior does not have hyperbolic pieces and such that $\Delta_{\tilde{K}}^{(2)} = (t \mapsto 1)$, then \tilde{K} is the unknot. The theorem follows. \square

6. PROOF OF PROPOSITION 2.2

The object of this section is to prove the proposition

Proposition 2.2. *Let us consider the (p, q) -cable knot S of companion C .*

(1) *There exists $P_C = \langle a_1, \dots, a_k | r_1, \dots, r_{k-1} \rangle$ a Wirtinger presentation of G_C such that*

$$P_S = \langle a_1, \dots, a_k, x, \lambda | r_1, \dots, r_{k-1}, x^p a_k^{-q} \lambda^{-p}, \lambda^{-1} W(a_i) \rangle$$

is a presentation of G_S , with x and λ the homotopy classes of the core and a longitude of T_C , and $W(a_i)$ a word in the a_1, \dots, a_k .

(2) *Furthermore, $\alpha_S(x) = q$, $\alpha_S(\lambda) = 0$ and $\alpha_S(a_i) = p$, for $i = 1, \dots, k$.*

6.1. Group of a torus knot pattern. Let T_{int} be an open solid torus and T_{ext} an open tubular neighborhood of T_{int} , thus a second solid torus. We will draw the torus knot $K = T(p, q)$ on the boundary of T_{int} . Let us take pt any point on $\partial T_{int} \setminus K$. It will be the base point for all the following fundamental groups. Figure 6 (where $p = 3$ and $q = 4$) should clarify the notations.

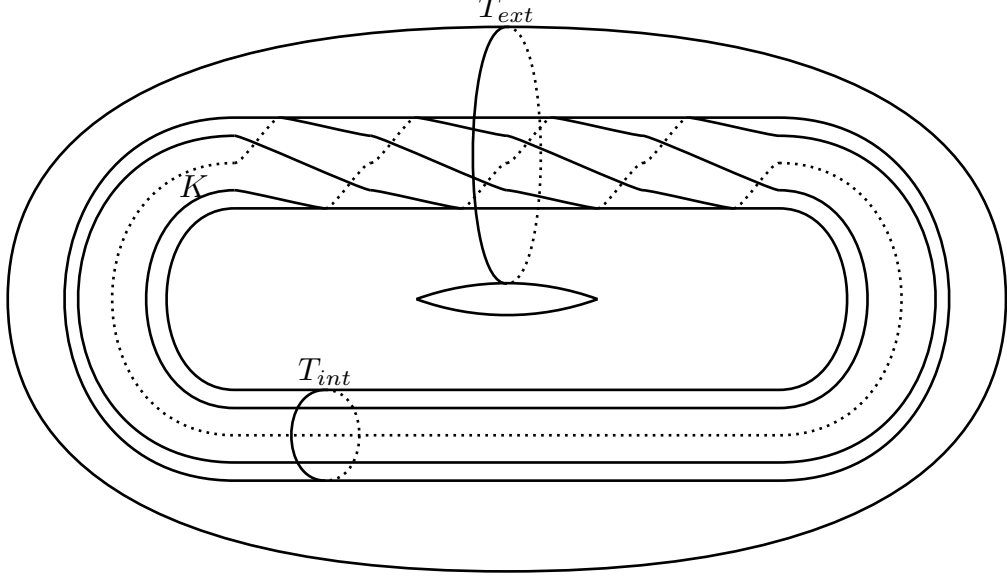

FIGURE 6. The inside and outside tori T_{int} and T_{ext} and the (p, q) -torus knot K

We want to prove the following result:

Lemma 6.1. $P_{p,q} = \langle x, y, \lambda | x^p = \lambda^p y^q, \lambda y = y \lambda \rangle$ is a presentation of $\tilde{G}_{p,q} = \pi_1(T_{ext} \setminus K)$. Furthermore, the elements of $\tilde{G}_{p,q}$ represented by λ and y are the homotopy classes of a longitude curve and a meridian curve of $T_{ext} \setminus \overline{T_{int}}$, and x is the homotopy class of the core of T_{int} .

The following proof has been inspired by the calculation of the classical presentation of torus knot groups, cf for example [10, Section 3.C].

Proof. We will use the Seifert-van Kampen theorem.

We note $U_1 = T_{ext} \setminus (T_{int} \sqcup K)$, $U_2 = \overline{T_{int}} \setminus K$, $W = T_{ext} \setminus K$, $V = \partial T_{int} \setminus K$ and G_1, G_2, G, G_0 their respective fundamental groups (for the same base point pt in V).

U_1 can be deformed to $T_{ext} \setminus T_{int}$ (by «filling up K »), and so it is homotopically equivalent to a 2-torus. Thus $\langle y, \lambda | y\lambda = \lambda y \rangle$ is a presentation of G_1 , where y and λ are the homotopy classes of a natural meridian-longitude system of $T_{ext} \setminus T_{int}$, see Figure 7.

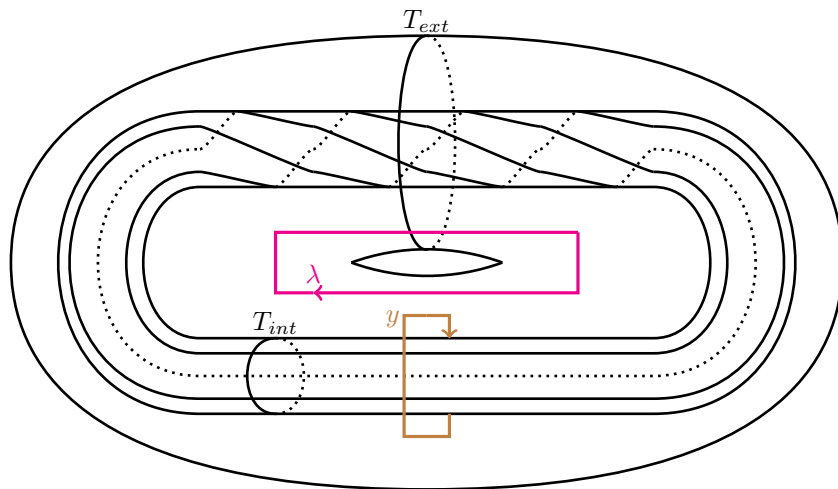

FIGURE 7. A natural meridian-longitude system

U_2 can be deformed to T_{int} by a similar process, therefore G_2 admits the presentation $\langle x | - \rangle$, where x is the homotopy class of the core of T_{int} , cf Figure 8.

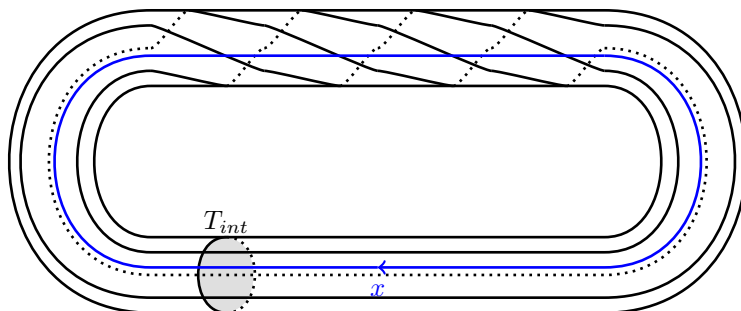

FIGURE 8. The generator x , core of T_{int}

V is homeomorphic to an annulus, thus G_0 admits the presentation $\langle z | - \rangle$ where the generator z is drawn on Figure 9. Note that z follows the direction of the strands, that is the same as the one of the core if $p > 0$ and the opposite if $p < 0$.

The inclusions $V \subset U_1$ and $V \subset U_2$ induce homotopy maps that send z to x^p and $y^q \lambda^p$ respectively. We hope the figures make this point clearer.

Thus, by the Seifert-van Kampen theorem, $G = G_{p,q}$ admits the presentation $P_{p,q} = \langle x, y, \lambda | x^p = \lambda^p y^q, \lambda y = y \lambda \rangle$.

□

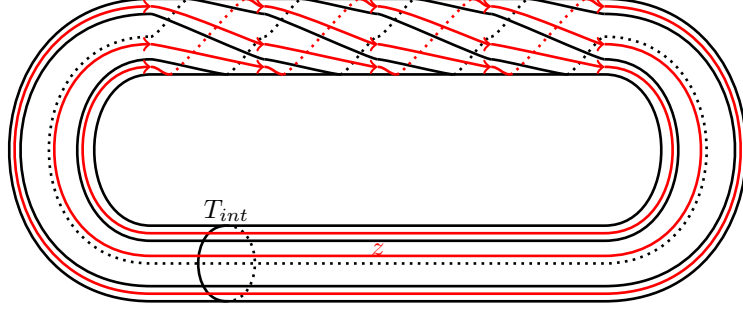
FIGURE 9. The generator z of G_0

6.2. A meridian-longitude system in the group presentation of the pattern. In this subsection we will explain how to obtain in general a group presentation for $G_{PCT_P} = \pi_1(T_P \setminus P)$ containing the homotopy classes of a preferred meridian-longitude pair of T_P as generators. This will not help us to prove Proposition 2.2, but this illustrates that the hypotheses of Lemma 6.3 are not as restrictive as we could have thought.

The method will use Wirtinger presentations, and thus is not the same as the one used in Lemma 6.1, but it will work for any pattern P .

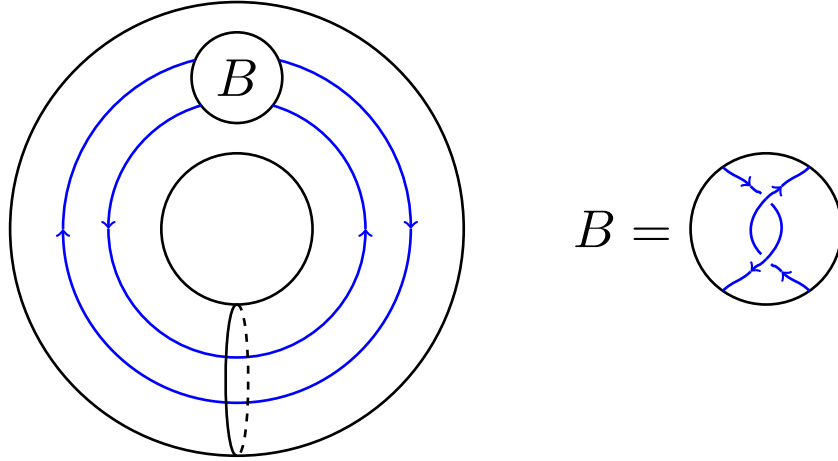
FIGURE 10. The pattern seen as one (m, m) -tangle B and m parallel strands

First, notice that we can draw P as m parallel strands (not necessarily going in the same direction) and a (m, m) -tangle B . See Figure 10, where we took $m = 2$ and P the Whitehead double pattern.

To compute a presentation of $G_{PCT_P} = \pi_1(T_P \setminus P)$, we remark that this group is naturally isomorphic to $G_{P \sqcup M_P} = \pi_1(S^3 \setminus (P \sqcup M_P))$ where M_P is a meridian curve of T_P , see Figure 11.

Now we can compute a Wirtinger presentation of $G_{P \sqcup M_P}$ by the well-known process of the same name (see for example [2, Section 3.B]).

The Wirtinger generators are:

- λ the generator for the arc of M_P that passes over the m strands, which corresponds naturally to a longitude loop of T_P .
- $\lambda_1, \dots, \lambda_{m-1}$ the other generators of M_P , listed from the outside to the inside.

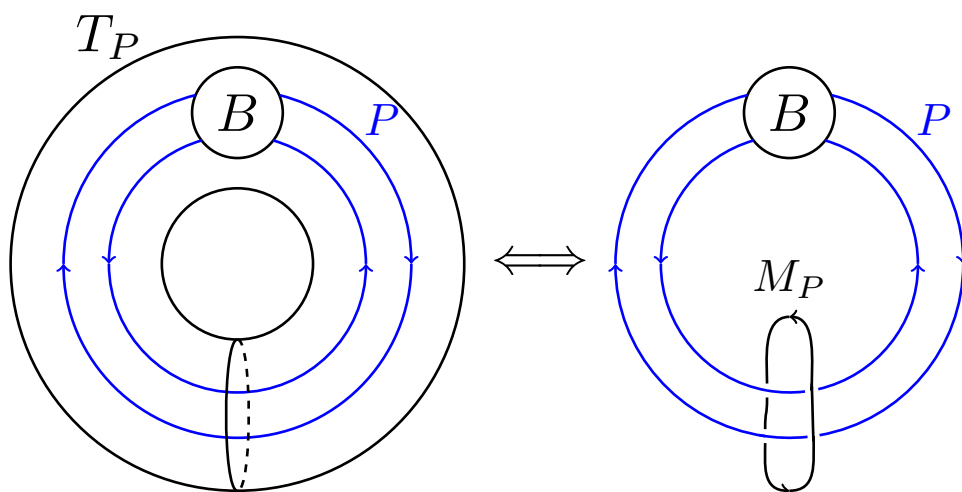

FIGURE 11. The knot P inside T_P is the same as the 2-link $P \sqcup M_P$ inside S^3

- a_1, \dots, a_m and a'_1, \dots, a'_m the generators for the m strands of P , listed from the outside to the inside, such that $a'_i = \lambda a_i \lambda^{-1}$.
- b_1, \dots, b_k the generators for the arcs strictly inside the tangle B .

Figure 12 pictures them partially (as always, the base point is assumed to be above the diagram).

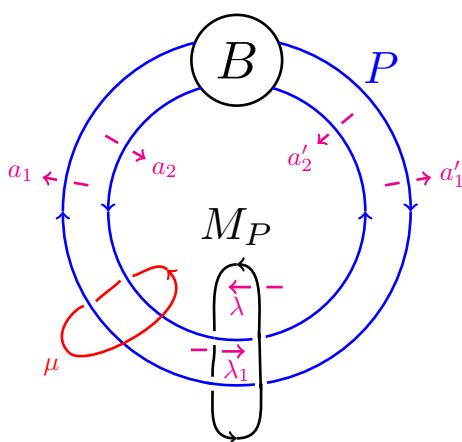

FIGURE 12. The Wirtinger generators

Note that we can assume that the a_i and the a'_i are all distinct, since we can add a first Reidemeister move twist at each of the $2m$ points of entrance of P into B .

The relators are:

- r_1, \dots, r_{m+k-1} , some words in the a_i , a'_i and b_j , corresponding to the crossings inside B .
- $a'_i = \lambda a_i \lambda^{-1}$ for the crossings where M_P passes over P .
- $\lambda_1 = a_1^{e_1} \lambda a_1^{-e_1}$, $\lambda_2 = a_2^{e_2} \lambda a_2^{-e_2}$, \dots , $\lambda = a_m^{e_m} \lambda a_m^{-e_m}$ for the crossings where M_P passes under P (here $e_i = \pm 1$ depends on the orientation of the i -th strand).

Thus $G_{P \sqcup M_P}$ admits the Wirtinger presentation

$$Q = \langle a_i, a'_i, b_j, \lambda_\alpha, \lambda | r_l, a'_i = \lambda a_i \lambda^{-1}, \lambda_1 = a_1^{e_1} \lambda a_1^{-e_1}, \dots, \lambda = a_m^{e_m} \lambda a_m^{-e_m} \rangle,$$

where $i = 1, \dots, m$, $j = 1, \dots, k$, $\alpha = 1, \dots, m-1$ and $l = 1, \dots, m+k-1$.

A preferred longitude of T_P is among the generators of Q , as λ . We also want a meridian loop μ . As shown in Figure 12, μ is equal to $a_m^{e_m} \dots a_1^{e_1}$. We can thus write

$$Q_1 = \langle a_i, a'_i, b_j, \lambda_\alpha, \lambda, \mu | r_l, a'_i = \lambda a_i \lambda^{-1}, \lambda_1 = a_1^{e_1} \lambda a_1^{-e_1}, \dots, \lambda = a_m^{e_m} \lambda_{m-1} a_m^{-e_m}, \mu = a_m^{e_m} \dots a_1^{e_1} \rangle$$

an other presentation of $G_{P \sqcup M_P}$, that has the form we wanted.

Now we can simplify this presentation and get rid of the generators λ_α .

By substituting λ_α with $a_\alpha^{e_\alpha} \lambda_{\alpha-1} a_\alpha^{-e_\alpha}$ from $\alpha = 1$ to $m-1$ (with the convention $\lambda_0 = \lambda$), we obtain the simplified presentation

$$Q_2 = \langle a_i, a'_i, b_j, \lambda, \mu | r_l, a'_i = \lambda a_i \lambda^{-1}, \lambda = (a_m^{e_m} \dots a_1^{e_1}) \lambda (a_1^{-e_1} \dots a_m^{-e_m}), \mu = a_m^{e_m} \dots a_1^{e_1} \rangle$$

that is equivalent to

$$Q_3 = \langle a_i, a'_i, b_j, \lambda, \mu | r_l, a'_i = \lambda a_i \lambda^{-1}, \lambda \mu = \mu \lambda, \mu = a_m^{e_m} \dots a_1^{e_1} \rangle.$$

In conclusion, the group of the pattern knot P inside its solid torus T_P admits a group presentation of the form of Q_3 . This presentation is simple in the sense that the generators a_i, a'_i, b_j and the relators r_l can all be read of the diagram of P . Moreover, Q_3 contains a preferred meridian-longitude pair of T_P in its generators.

Remark 6.2. This method gives us the (simplified) presentation

$$\langle b, \lambda, \mu | \lambda \mu \lambda^{-1} \mu^{-1}, b \lambda b \lambda^{-1} b^{-1} \lambda \mu b^{-1} \lambda^{-1} \rangle$$

for the Whitehead link.

6.3. Group presentation of a satellite knot. The following lemma gives us a group presentation of the satellite knot when we know a presentation of the pattern group with a preferred meridian-longitude pair of the pattern torus among its generators and any presentation of the companion group.

Lemma 6.3. *Let T be a tubular neighborhood of T_C distinct from it. We will take pt any point in $T \setminus T_C$, it will be the basepoint for all the following fundamental groups. Notice that $G_{P \subset T_P} = \pi_1(T \setminus S_{C,P})$ is isomorphic to $\pi_1(T_P \setminus P, pt')$ where $pt' = h_{P_C}^{-1}(pt)$.*

Suppose there exists $P_{P \subset T_P} = \langle b_1, \dots, b_{l-1}, \lambda, \mu | s_1, \dots, s_l \rangle$ a presentation of $G_{P \subset T_P}$ where λ and μ are the homotopy classes of a longitude curve and a meridian curve of T_P .

Then there exists a presentation $P_C = \langle a_1, \dots, a_k | r_1, \dots, r_{k-1} \rangle$ of G_C and a presentation

$$P_S = \langle a_1, \dots, a_k, b_1, \dots, b_{l-1}, \lambda, \mu | r_1, \dots, r_{k-1}, s_1, \dots, s_{l-1}, \lambda^{-1} W(a_i), a_k^{-1} \mu \rangle$$

of $G_S = \pi_1(S^3 \setminus S_{C,P})$, with $W(a_i)$ a word in the $a_i, i = 1, \dots, k$.

Proof. We will use the Seifert-van Kampen theorem with the basepoint pt . We denote $W = S^3 \setminus S_{C,P}$, $U_C = S^3 \setminus \overline{T_C}$, $U_P = T \setminus S_{C,P}$, $V = T \setminus \overline{T_C}$, and $G_S, G_C, G_{P \subset T_P}, G_0$ their respective fundamental groups.

The drawings of Figure 13 are meant to represent an angular fraction of the C -shaped sets, a fraction that contains the «essence of the pattern P » and also the basepoint pt . They are here to make perfectly clear what W, U_C, U_P, V are.

We take a Wirtinger presentation $P_C = \langle a_1, \dots, a_k | r_1, \dots, r_{k-1} \rangle$ of $G_C = \pi_1(S^3 \setminus C) = \pi_1(S^3 \setminus \overline{T_C}) = \pi_1(U_C)$ associated to a planar regular diagram projection of C .

We then consider P inside T_P . The open set $U_P = T \setminus S_{C,P}$ is homotopy equivalent to $T_C \setminus S_{C,P}$, which is the image of $T_P \setminus P$ by the homeomorphism h_{P_C} . Thus $\pi_1(U_P) = G_{P \subset T_P}$. Let us denote λ a longitude of T_P and the corresponding element of $G_{P \subset T_P}$.

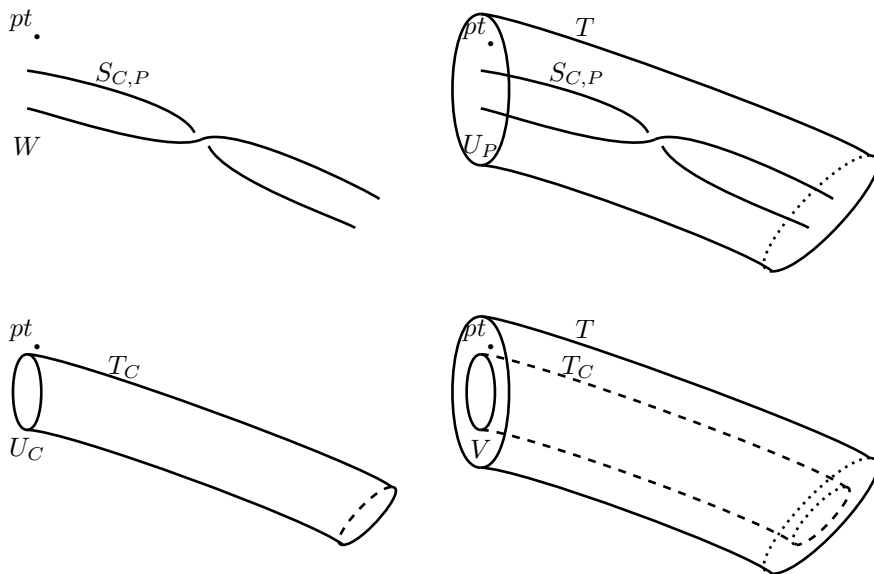

FIGURE 13. The four open sets for the Seifert-van Kampen theorem

V is homotopy equivalent to a 2-torus, thus $G_0 = \langle \lambda_0, \mu_0 | \lambda_0 \mu_0 \lambda_0^{-1} \mu_0^{-1} \rangle$, where (μ_0, λ_0) is the homotopy class of a preferred meridian-longitude pair.

$V \subset U_C$ maps μ_0 to any meridian loop of G_C , for instance a_k , and λ_0 to $W(a_i)$ a word in the a_i such that $W(a_i)$ is a longitude loop of the knot C .

$V \subset U_P$ maps μ_0 to μ (a meridian loop of ∂T_P that passes around the m strands), and λ_0 to λ .

Hence, by the Seifert-van Kampen theorem,

$$P = \langle a_1, \dots, a_k, b_1, \dots, b_{l-1}, \lambda, \mu | r_1, \dots, r_{k-1}, s_1, \dots, s_{l-1}, \lambda^{-1} W(a_i), a_k^{-1} \mu \rangle$$

is a presentation of $G_S = \pi_1(W) = \pi_1(S^3 \setminus S_{C,P})$. □

6.4. Details of the proof.

Let us prove (1) of the Proposition 2.2.

Let us consider the cable knot S of companion C and pattern $T(p, q)$. There exists $P_C = \langle a_1, \dots, a_k | r_1, \dots, r_{k-1} \rangle$ a Wirtinger presentation of $G_C = \pi_1(S^3 \setminus C)$.

Lemma 6.1 and Lemma 6.3 give us the following presentation of G_S :

$$P = \langle a_1, \dots, a_k, x, y, \lambda | r_1, \dots, r_{k-1}, x^p y^{-q} \lambda^{-p}, y \lambda y^{-1} \lambda^{-1}, \lambda^{-1} W(a_i), a_k^{-1} y \rangle$$

with b_1 being x and μ being y .

Then we can suppress the relation $y \lambda = \lambda y$ because it is equivalent to $a_k W(a_i) = W(a_i) a_k$ which is already true in G_C because a_k is a meridian loop of the knot C and $W(a_i)$ is a corresponding longitude loop. Furthermore, we can replace y by a_k in the relators and delete the generator y and the relator $a_k^{-1} y$.

Therefore

$$P_S = \langle a_1, \dots, a_k, x, \lambda | r_1, \dots, r_{k-1}, x^p a_k^{-q} \lambda^{-p}, \lambda^{-1} W(a_i) \rangle$$

is a presentation of $G_S = \pi_1(S^3 \setminus S)$, with $W(a_i)$ a word in the $a_i, i = 1, \dots, k$.

Furthermore, λ is a longitude loop of C and x is the homotopy class of the core of T_C , since it is the image of the core of T_P by h_{P_C} .

Now let us prove (2):

Since λ is a longitude loop of C , its linking number with C is zero, thus its linking number with S is zero (it is multiplied by p at each crossing during the cabling process), thus $\alpha_S(\lambda) = 0$.

All the a_i have the same abelianization as a_k , which is equal to y , which is a meridian loop of ∂T_C and therefore circles p strands. Thus $\alpha_S(y) = p$.

Finally, the relation $x^p y^{-q} \lambda^{-p}$ in G_S implies that $\alpha_S(x) = q$, which concludes the proof of Proposition 2.2.

7. OPEN QUESTIONS

(1) The L^2 -Alexander invariant $\Delta_K^{(2)}$ of a knot K is a class of maps from a subset X_K of $\mathbb{R}_{>0}$ to $\mathbb{R}_{\geq 0}$, up to multiplication by the $(t \mapsto t^m)$, $m \in \mathbb{Z}$.

We can ask many interesting questions about these maps.

(a) Are they continuous? We know some continuity properties of the Fuglede-Kadison determinant on invertible operators, but what about the operators we use here?

(b) Are they everywhere nonzero? Or equivalently, are the operators of determinant class for all $t \in X_K$? This question can be related to the Determinant Conjecture (cf [7, Chapter 13]).

(c) Are there knots K for which X_K is not the whole $\mathbb{R}_{>0}$? This question can be related to the strong Atiyah conjecture (cf [7, Chapter 10]).

(2) Theorem 4.3 gives us a cabling formula for the L^2 -Alexander invariant. Even if an intuitive L^2 -re-writing of the satellite formula for the Alexander polynomial stands false, cf Remark 4.4, maybe we can get a more general formula. Are there other L^2 satellite formulas for certain classes of pattern knots, ones that, like torus knot patterns, have group presentations that are easy to manipulate?

REFERENCES

- [1] F. Ben Aribi, *The L^2 -Alexander invariant detects the unknot*, Comptes Rendus Mathématique **351** (2013), Issue 5-6, 215–219.
- [2] G. Burde and H. Zieschang, “Knots”, de Gruyter Studies in Mathematics, 2003.
- [3] A. Carey, M. Farber, V. Mathai *Determinant lines, von Neumann algebras and L^2 -torsion*, J. Reine Angew. Math. **484**, 1997.
- [4] P. Cromwell, “Knots and links”, Cambridge University Press, 2004.
- [5] J. Dubois and C. Wegner, *Weighted L^2 -invariants and applications to knot theory*, to appear in Commun. Contemp. Math.
- [6] W. Li and W. Zhang, *An L^2 -Alexander invariant for knots*, Commun. Contemp. Math. **8** (2006), no. 2, 167–187.
- [7] W. Lück, “ L^2 -invariants: Theory and Applications to Geometry and K -theory”, Ergebnisse der Mathematik und ihrer Grenzgebiete. 3. Folge. A Series of Modern Surveys in Mathematics, 44. Springer-Verlag, Berlin, 2002.
- [8] W. Magnus, A. Karrass and D. Solitar, “Combinatorial Group Theory: Presentations of Groups in Terms of Generators and Relations”, Interscience Publishers, 1966.
- [9] H. Murakami and J. Murakami, *The colored Jones polynomials and the simplicial volume of a knot*, Acta Math. **186** (2001), 85–104.
- [10] D. Rolfsen, “Knots and links”, Publish or Perish, Houston, 1990.
- [11] C. M. Tsau, *Isomorphisms and Peripheral Structure of Knot Groups*, Math. Ann. **282** (1988), 343–348.
- [12] M. Wada, *Twisted Alexander polynomial for finitely presented groups*, Topology **33** (1994), no. 2, 241–256.

INSTITUT DE MATHÉMATIQUES DE JUSSIEU–PARIS RIVE GAUCHE, UNIVERSITÉ PARIS–DIDEROT (PARIS-7), UFR DE MATHÉMATIQUES, CASE 7012, BÂTIMENT SOPHIE-GERMAIN, 75205 PARIS CEDEX 13, FRANCE

E-mail address: benaribi@math.jussieu.fr