

Fair amenability for semigroups

Josh Deprez*

*School of Mathematics & Physics
University of Tasmania*

June 6, 2018

Abstract

A new flavour of amenability for discrete semigroups is proposed that generalises group amenability and follows from a Følner-type condition. Some examples are explored, to argue that this new notion better captures some essential ideas of amenability. A semigroup S is left fairly amenable if, and only if, it supports a mean $m \in \ell^\infty(S)^*$ satisfying $m(f) = m(s * f)$ whenever $s * f \in \ell^\infty(S)$, thus justifying the nomenclature “fairly amenable”.

1 Introduction

Amenability begins in essence alongside modern analysis, as it is a central property lacking in a group used to show, for example, the Banach-Tarski paradox (Wagon 1993). The first working definition for what is now called amenability was given by von Neumann (1929), in terms of finitely-additive measures. A group G is amenable if there is a finitely-additive measure μ such that $\mu(G) = 1$, and $\mu(gA) = \mu(A)$ for all $g \in G, A \subseteq G$ (μ is *left invariant*). This definition has the advantages of being easy to comprehend, hiding very little, and it is easy to show that the free group on two generators \mathbb{F}_2 does not support such a finitely-additive measure.

The first modern definition of amenability, in its form as extended to semigroups, was given by Day (1957), whose concept involved invariant means. A *mean* is a non-negative linear functional $m \in \ell^\infty(S)^*$ such that $m(\chi_S) = 1$. The means generalise the finitely-additive measures: to obtain a mean from a finitely-additive measure, use the Lebesgue integral construction. An element $s \in S$ acts on a function $f \in \ell^\infty(S)$ (on the left), by setting $(s \cdot f)(t) := f(st)$ for all $t \in S$. Briefly, then, a semigroup S is (classically) *left amenable* when there exists such an m satisfying $m(s \cdot f) = m(f)$ for all $f \in \ell^\infty(S)$. For groups this coincides exactly with the von Neumann condition. However, for semigroups it does not: in fact, a mean satisfies the above condition if, and only if, the associated finitely-additive measure μ satisfies¹ $\mu(s^{-1}A) = \mu(A)$ for all $s \in S$ (Paterson 1988). This might be called left *preimage* invariance of μ . A simple but surprising consequence of all this is that all semigroups with a zero element are both left and right amenable (Day 1957) yet they cannot have a (totally) invariant finitely-additive measure (van Douwen 1992, p231). On the other hand, all semigroups with more than one distinct left zero are not left amenable (Paterson 1988).

*Electronic address: josh.deprez@gmail.com.

¹Recall that for any $s \in S$ and $A \subseteq S$, the set $s^{-1}A := \{t \in S : st \in A\}$.

Numerous other alternative definitions for amenability from group theory disagree on semigroups in general. The Følner conditions, originally shown for groups by Følner (1955) and of which there are now several flavours, have varying degrees of relation to left amenability of a semigroup. The Følner conditions are useful for showing when a group has amenability, and effectively describe the essential reason all Abelian groups are amenable. Følner’s original conditions were first generalised to semigroups by Frey in 1960 and subsequently a simpler proof was given by Namioka (1964). Some of the Følner-type criteria that are sufficient for left amenability of a semigroup include the weak and strong Følner conditions (Argabright and Wilde 1967) and the weak and strong Følner-Namioka conditions (Yang 1987). A *necessary* Følner-type condition for amenable semigroups is the one described by Namioka (1964).

For some of these Følner conditions, and other related conditions, if the semigroup in question is *cancellative*, then there are improved results, since the inequality $2|A \setminus sA| \geq |sA \triangle A| \geq 2|sA \setminus A|$, true for any $s \in S$ and finite $A \subseteq S$, is then saturated. For example, Frey’s thesis showed that if S is a cancellative semigroup that contains no free subsemigroup on two generators, and is left amenable, then every subsemigroup of S is left amenable. An improvement was made recently by Donnelly (2012): if T is a subsemigroup of S , S is cancellative, T does not contain a free subsemigroup on two generators, and S is left amenable, then T is left amenable.

Another set of results concerns translating amenability between groups and algebras. A Banach algebra \mathfrak{A} is called *amenable* if $\mathcal{H}^1(\mathfrak{A}, E^*) = \{0\}$ for every Banach \mathfrak{A} -bimodule E (Runde 2002, p43)—this is equivalent to saying all derivations are inner derivations. It is the famous theorem of Johnson (1972) that shows that the group G is amenable if, and only if, $\ell^1(G)$ is amenable (as a convolution Banach algebra). However, for a semigroup S , the amenability of $\ell^1(S)$ does not relate well to the amenability of S .

1.1 Inverse semigroups

One might hope that the situation would be less complicated when restricted to the class of inverse semigroups. Sticking to classical amenability, it is so much less complicated as to be almost trivial: Duncan and Namioka (1978) showed that an inverse semigroup S is amenable if and only if its maximal group homomorphic image (denoted $G(S)$) is amenable. As an example, if the inverse semigroup S has a zero, then $G(S)$ is the trivial group, and therefore S is amenable.

On the other hand, the convolution Banach algebra $\ell^1(S)$ is amenable if, and only if, the semilattice of idempotents (denoted $E(S)$) is finite and every subgroup of S is amenable. This is regarded as too strong (Milan 2007), since it eliminates many commutative inverse semigroups.

Paterson (1998) suggested the following result points at one resolution: if the inverse semigroup S has all maximal subgroups amenable, then $VN(S)$ (the von Neumann algebra of S) is amenable.

Milan (2008) argued that the weak containment property—another generalisation of amenability for groups—is an appropriate notion of amenability for inverse semigroups, by showing the following. The free group on two generators with a zero adjoined, an example of a Clifford semigroup, does not have weak containment, but the commutative inverse semigroups all have weak containment. Therefore the weak containment property sits neatly between amenability of S and amenability of $\ell^1(S)$. Milan (2008) also showed that an E -unitary inverse semigroup has weak containment if, and only if, $G(S)$ is amenable, and that examples of inverse semigroups with weak containment include the graph inverse semigroups, which generalise and include the polycyclic monoids (see Jones and Lawson 2011).

Recall that for any given inverse semigroup S , the left regular representation π_2 of $s \in S$ on

the Hilbert space $\mathcal{H} = \ell^2(S)$ is defined by

$$\pi_2(s)f := \sum_{tt^* \leq s^*s} f(t)st \quad \text{for all } f \in \ell^2(S)$$

(Paterson 1998). This representation is central to the weak containment property. Due to the reliance the natural partial order to keep the above summation well-defined (consider $\pi_2(0)f$: the only idempotent bounded above by 0 is 0), this may not be adequately generalisable to arbitrary semigroups.

* * *

In the remainder of this paper I describe a condition, similar to amenability, and given in terms of finitely-additive measures, which was inspired by the results relating to cancellative semigroups and the regular representations of an inverse semigroup, that takes advantage of zeroes and other non-cancellative elements in a natural way. An extension of this condition to the context of means will be given in a forthcoming paper. The Axiom of Choice shall be assumed throughout, though it will be mentioned where used.

2 Definitions

The following is required to introduce the condition. Let S be a semigroup, and define the maps

$$\lambda_s(x) := sx; \quad \rho_s(x) := xs \quad \text{for all } s, x \in S.$$

λ and ρ are known as the *left regular* and *right regular* representations, respectively. (Note that these should not be confused with the regular representations on a Hilbert space described above.) For all $s \in S$, λ_s and ρ_s are elements of \mathcal{T}_S , the transformation semigroup of the set S .

Definition 2.1 (Acting injectively) If $\lambda_s|_A : A \rightarrow sA$ is an injection, then s is said to *act injectively on the left of A* . If $\rho_s|_A : A \rightarrow As$ is an injection, then s acts injectively on the *right* of A .

By definition, every $s \in S$ acts injectively on the left of S if, and only if, S is left cancellative. Finding the sets acted on injectively permits analysing any semigroup, rather than unsubtly requiring the semigroup to be cancellative.

Lemma 2.2 For any $s \in S$ and $A \subseteq S$, the following are equivalent:

- (i) s acts injectively on the left of A ;
- (ii) For all two-element set $F \subseteq A$, $|sF| = |F|$;
- (iii) For any finite set $F \subseteq S$, $|s(F \cap A)| = |F \cap A|$.

Definition 2.3 (Subinvariant) Let S be a semigroup, and μ a finitely-additive measure on S with finite total measure. If

$$\mu(sA) \leq \mu(A) \quad [\mu(As) \leq \mu(A)] \quad \text{for all } s \in S \text{ and } A \subseteq S,$$

then we say μ is *left [right] sub-invariant*.

Suppose $sA = A$ (for instance s is an identity); it is then clear that the inequality above cannot be strict in general.

Suppose for some element s and set A there is some s' such that $s'sA = A$. Then both s and s' are behaving as injective acts, and when restricted to A , $s's$ acts as a permutation of A . If μ is left sub-invariant,

$$\mu(A) = \mu(s'sA) \leq \mu(sA) \leq \mu(A),$$

and thus $\mu(sA) = \mu(A)$. This suggests the next definition, which is the most important here.

Definition 2.4 (Fairly invariant, fairly amenable) Let S be any semigroup, let μ a finitely-additive measure on S with $\mu(S) = 1$, and let $s \in S$ and $A \subseteq S$.

If whenever s acts injectively on the left [right] of A ,

$$\mu(sA) = \mu(A) \quad [\mu(As) = \mu(A)]$$

then μ is *fairly left [right] invariant*. If such a μ exists for a given semigroup S , then S is *fairly left [right] amenable*.

In other words, invariance of μ is only required in the places where an element s acts injectively on the set. As we shall see, this weakening of total invariance handles the issue discussed in (van Douwen 1992, p231).

Lemma 2.5 For any semigroup S and finitely-additive probability measure μ , left [right] fair invariance of μ implies left [right] sub-invariance of μ .

Proof For a pictorial overview see Figure 1.

1. For any $A \subseteq S$ and $s \in S$ there exists a $B \subseteq A$ such that $sA = sB$ and s is injective on B .

PROOF: Use the Axiom of Choice to choose one $b \in s^{-1}\{x\} \cap A$ for each $x \in sA$. B is simply the set of those choices.

2. If $B \subseteq A \subseteq S$, and $sA = sB$, and s acts injectively on B (but not necessarily on A), then $\mu(A) \geq \mu(sA)$.

PROOF:

$$\begin{aligned} \mu(A) &\geq \mu(B) && \because B \subseteq A \\ &= \mu(sB) && \because \text{fair invariance of } \mu \\ &= \mu(sA) && \because sB = sA. \end{aligned}$$

as required. □

Remark 2.6 What about selecting $\mu(sA) \geq \mu(A)$ as a condition (“super-invariance”)? If sA is a subset of A then $\mu(sA) = \mu(A)$, and so disjoint subsets sA, tA may lead to a contradiction.

By definition, if s acts injectively on the left of A , then $sa = sb \Rightarrow a = b$ for any $a, b \in A$ and s is *left cancellative on A*; similarly on the right. Hence another way of defining fair invariance is in terms of cancellation. Groups are totally cancellative both ways, but there are non-group examples of left- and right-cancellative semigroups.

3 Consequences

Fair amenability is a generalisation of amenability for groups, as follows.

Corollary 3.1 A group is amenable if, and only if, it is fairly amenable.

Proof This is trivial since every element g in a group G acts bijectively on G , and so a finitely-additive measure on G is invariant if, and only if, it is fairly invariant. □

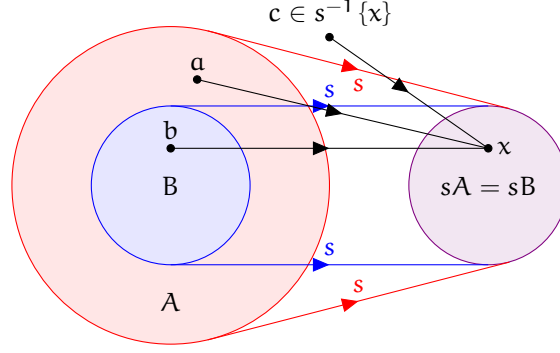

Figure 1: For every set A and element s there is some subset B such that $sA = sB$ and s acts injectively on B .

Similar to classical amenability, fair amenability is also a consequence of a Følner-type condition, as follows.

Theorem 3.2 Let S is a countable semigroup. If for each $s \in S$ there exists a sequence of non-empty finite sets $\{F_n\}_{n \in \mathbb{N}}$ eventually covering S such that for all $A \subseteq S$,

$$\lim_{n \rightarrow \infty} \frac{|s(A \cap F_n) \Delta (sS \cap F_n)|}{|F_n|} = 0,$$

then S is left fairly amenable. (Similarly for $F_n s$ /on the right.)

Proof Fix a free ultrafilter \mathcal{U} over \mathbb{N} and define μ through the ultralimit

$$\mu(A) := \lim_{\mathcal{U}} \frac{|A \cap F_n|}{|F_n|} \quad \text{for all } A \subseteq S.$$

1. For any set A , the ultralimit above exists, and μ is a finitely-additive measure with $\mu(S) = 1$.
 PROOF: The sequence is bounded so by the Bolzano-Weierstraß Theorem there is always a convergent subsequence, so the ultralimit always exists. $\mu(S) = 1$ since $|S \cap F_n| = |F_n|$ for all n , in which case the sequence is constantly 1. μ is finitely-additive as a simple consequence of Łos's Theorem, in particular, $\lim_{\mathcal{U}} (x_n + y_n) = \lim_{\mathcal{U}} x_n + \lim_{\mathcal{U}} y_n$ for any sequences $\{x_n\}_{n \in \mathbb{N}}, \{y_n\}_{n \in \mathbb{N}}$ where the ultralimits exist.
2. μ is left fairly invariant.

PROOF: Suppose s acts injectively on the left of A , and thus every subset of A , in particular $A \cap F_n$. Then $|A \cap F_n| = |s(A \cap F_n)|$. See Figure 2. Then,

$$\begin{aligned} \left| \frac{|A \cap F_n|}{|F_n|} - \frac{|sA \cap F_n|}{|F_n|} \right| &= \frac{||A \cap F_n| - |sA \cap F_n||}{|F_n|} \\ &= \frac{||s(A \cap F_n)| - |sA \cap F_n||}{|F_n|} \\ &\leq \frac{|s(A \cap F_n) \Delta (sS \cap F_n)|}{|F_n|} \rightarrow 0 \text{ as } n \rightarrow \infty \end{aligned}$$

by hypothesis, and hence $\mu(A) = \mu(sA)$, as required. \square

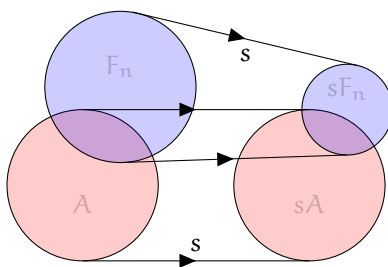

Figure 2: If s acts injectively on A , then it also acts injectively on the subset $A \cap F_n$ of A , and so $|A \cap F_n| = |s(A \cap F_n)|$. Note that $s(A \cap F_n) \subseteq sA \cap sF_n$ might not be saturated—consider disjoint A and F_n .

Remark 3.3 While there are semigroups lacking strong Følner sequences that are also fairly amenable, this appears to be mitigated in this condition as the top line is contained in the right ideal sS . Consider, for example, an infinite amenable group G with zero adjoined (G^0), which is fairly amenable (see Corollary 3.14 below) and the zero element has no associated Følner sequence, however $0S = \{0\}$ and therefore any Følner sequence will do in Theorem 3.2.

Corollary 3.4 All finite semigroups S are fairly amenable (both ways).

Proof s is injective on the left of $A \subseteq S$ if, and only if, $|sA| = |A|$; similarly on the right. Therefore the counting measure suffices. Alternatively, use the constant Følner sequence $\{S\}_{n \in \mathbb{N}}$: for any $A \subseteq S$,

$$\frac{|s(A \cap S) \Delta (sA \cap S)|}{|S|} = \frac{|sA \Delta sA|}{|S|} = \frac{0}{|S|} = 0$$

as required by Theorem 3.2. □

Remark 3.5 Suppose that, given some set A , $\mu(sA) = \mu(A)$ [$\mu(As) = \mu(A)$] for any s . We may describe A as being a left [right] μ -invariant set. In a fairly left [right] amenable semigroup S , every singleton set $\{x\}$ for $x \in S$ is guaranteed to be a left [right] invariant set.

Lemma 3.6 Let S be an infinite left [right] fairly amenable semigroup with measure μ , having a left [right] zero $z \in S$. If F is a finite subset of S , then $\mu(F) = 0$.

Proof

1. Every singleton set has the same measure k .

PROOF: We can go via $\{z\}$: for any $s, t \in S$,

$$\mu(\{s\}) = \mu(z\{s\}) = \mu(\{z\}) = \mu(z\{t\}) = \mu(\{t\}).$$

2. $k = 0$, therefore $\mu(F) = 0$.

PROOF: If $k > 0$ there exists some finite N such that $Nk > 1$, i.e. the disjoint union of N singletons would have greater than 1 measure. Hence $k = 0$. Then

$$\mu(F) = \sum_{f \in F} \mu(\{f\}) = \sum_{f \in F} k = 0.$$

The right case holds similarly. □

Corollary 3.7 Let S be a non-trivial semigroup with zero. The finitely-additive measure δ_0 given by

$$\delta_0(A) = \delta_0(0^{-1}A) = \delta_0(A0^{-1}) = \begin{cases} 1 & \text{if } 0 \in A \\ 0 & \text{if } 0 \notin A \end{cases}$$

(i.e. the measure obtained from the invariant mean $m \in \ell^\infty(S)^*$ given by $m(f) = f(0)$ for all $f \in \ell^\infty(S)$) cannot be fairly invariant.

Proof Let $a \in S$ where $a \neq 0$ and assume δ_0 is fairly invariant. Then

$$\begin{aligned} 1 &= \delta_0(\{0\}) \quad \text{by definition} \\ &= \delta_0(0\{a\}) \\ &= \delta_0(\{a\}) \\ &= 0 \quad \text{since } 0 \notin \{a\}, \end{aligned}$$

contradiction. □

Question 3.8 Is there a left or right fairly amenable infinite semigroup with a finite subset having positive mass?

* * *

Recall the *Green's relations* $\mathcal{L}, \mathcal{R}, \mathcal{D}, \mathcal{H}, \mathcal{J}$ on a semigroup. There are two easy lemmas.

Lemma 3.9 If S is left [right] fairly amenable with measure μ , any finite subset F of an infinite \mathcal{L} -class [\mathcal{R} -class] has $\mu(F) = 0$. It follows that in either case any finite subset F of a \mathcal{H} -class has $\mu(F) = 0$, and if S is fairly amenable on both sides than any finite subset F of a \mathcal{D} -class has $\mu(F) = 0$.

Proof

1. Every singleton subset of an \mathcal{L} -class has the same measure k .

PROOF: By definition, for all $a, b \in S$ such that $a \mathcal{L} b$, there exists $s, s' \in S^1$ such that $sa = b, s'b = a$, and we only need one of these to establish that if μ is the left fairly invariant finitely-additive measure,

$$\mu(\{a\}) = \mu(s\{a\}) = \mu(\{sa\}) = \mu(\{b\}) \quad \text{for all } a, b \in S.$$

2. Every finite subset has measure 0.

PROOF: As for the final step of Lemma 3.6. □

Green's Lemma (Howie 1976, p43) states that for any $a, b \in S$ such that $a \mathcal{R} b$, the restricted right regular representations to \mathcal{L} -classes, $\rho_s|_{L_a}$ and $\rho_{s'}|_{L_b}$, are mutually inverse \mathcal{R} -class preserving bijections between the \mathcal{L} -classes L_a and L_b . Put another way, there exists an $s \in S$ that acts injectively on the right of L_a and an $s' \in S$ that acts injectively on the right of L_b .

Lemma 3.10 Let S be a semigroup. If S is right fairly amenable with measure μ then within each \mathcal{D} -class all \mathcal{L} classes have the same measure. Similarly, if S is left fairly amenable with μ then within each \mathcal{D} -class all \mathcal{R} classes have equal measure. It follows that if S is fairly amenable (both ways) then all \mathcal{D} -related \mathcal{H} -classes have equal measure.

Proof Suppose L_a, L_b are \mathcal{L} -classes contained within the same \mathcal{D} -class.

1. There exist $s, s' \in S^1$ such that $L_a = L_b s'$ and $L_b = L_a s$ are both examples of injective right acts.

PROOF: Use Green's Lemma.

2. $\mu(L_a) = \mu(L_a s) = \mu(L_b)$. □

What can we say about the value of a fairly invariant finitely-additive measure μ between distinct \mathcal{D} -classes? Probably not a lot (see Example 3.15 below).

* * *

A result for groups states that the direct product of finitely many amenable groups is also amenable. This is easily shown by noting that if $G = G_1 \times G_2$ then the subgroup $H = \{(g_1, 1_{G_2}) : g_1 \in G_1\} \cong G_1$, and $G/H \cong G_2$, so therefore the amenability of G_1 and G_2 imply the amenability of H and G/H , and hence G . The fair amenability analogue of this result is as follows, but shown in a more involved manner.

Theorem 3.11 Let S, T be semigroups that are each left [right] fairly amenable. $S \times T$ is as well.

Proof Let μ_S and μ_T witness the left fair amenability of S and T respectively. Let π_S, π_T denote the projections from $\mathcal{P}(S \times T)$ onto $\mathcal{P}(S)$ and $\mathcal{P}(T)$, respectively.

1. Define μ , on $S \times T$, for each rectangle $R = A \times B$ where $A \subseteq S$ and $B \subseteq T$:

$$\mu(R) := \mu_S(\pi_S(R)) \mu_T(\pi_T(R)) = \mu_S(A) \mu_T(B),$$

which, while not yet defined for all subsets of $S \times T$, is clearly left fairly invariant and finitely-additive, and with $\mu(S \times T) = \mu_S(S) \mu_T(T) = 1$.

2. It follows that

$$\mu\left(\bigcup_{i \in I} R_i\right) = \sum_{i \in I} \mu(R_i),$$

for each finite collection of disjoint rectangles² $\{R_i\}_{i \in I}$, and this is also left fairly invariant.

PROOF: If (s, t) acts injectively on $\bigcup_{i \in I} R_i$, then s acts on $\pi_S(R_i)$ injectively for each $i \in I$, likewise for $t \in T$ on $\pi_T(R_i)$. Furthermore, (s, t) preserves the disjointness of $\{R_i\}_{i \in I}$.

3. Let C be an arbitrary subset of $S \times T$. C is not necessarily a rectangle, so extend μ using

$$\mu(C) := \sup \mu\left(\bigcup_{i \in I} R_i\right),$$

where the supremum is taken over all finite collections of subrectangles of C .

4. μ is then defined for all subsets C of $S \times T$, and is left fairly invariant.

PROOF: If $(s, t) \in S \times T$ acts injectively on C then it acts injectively on any finite collection of disjoint subrectangles of C . Each finite collection of disjoint subrectangles of $(s, t)C$ has the form $\{(s, t)R_i\}_{i \in I}$ for a finite collection of disjoint subrectangles $\{R_i\}_{i \in I}$ of C . Hence

$$\begin{aligned} \mu((s, t)C) &= \sup \mu\left(\bigcup_{i \in I} (s, t)R_i\right) \\ &= \sup \sum_{i \in I} \mu((s, t)R_i) \\ &= \sup \sum_{i \in I} \mu(R_i) \\ &= \sup \mu\left(\bigcup_{i \in I} R_i\right) \\ &= \mu(C), \end{aligned}$$

as required. □

* * *

Another result for groups states that every left amenable group is also right amenable, and furthermore, a left invariant measure and right invariant measure can be combined to provide

²Take care to avoid confusing *finite collections of rectangles* with *collections of finite rectangles*.

a bi-invariant measure (Wagon 1993, p148). This result doesn't hold for all semigroups (either classically or fairly), but a similar proof technique can be applied to the fair amenability of semigroups with involution.

Lemma 3.12 Let S be a semigroup with involution $*$. If S is left fairly amenable, then it is right fairly amenable (and vice-versa).

Proof $A^* := \{a^* : a \in A\}$, and so $(As)^* = s^*A^*$. Suppose that μ on S is left fairly invariant and define ν by setting $\nu(A) = \mu(A^*)$ for all A .

1. ν has total measure 1.

PROOF:

$$\begin{aligned}\nu(S) &= \nu(S^*) \\ &= \mu(S) = 1.\end{aligned}$$

2. ν is finitely additive.

PROOF: For all disjoint $A, B \subseteq S$,

$$\begin{aligned}\nu(A \cup B) &= \mu((A \cup B)^*) \\ &= \mu(A^* \cup B^*) \\ &= \mu(A^*) + \mu(B^*) \\ &= \nu(A) + \nu(B).\end{aligned}$$

3. ν is right fairly invariant.

PROOF: If s acts injectively on the *right* of A , then for $a, b \in A$,

$$\begin{aligned}s^*a^* = s^*b^* &\Leftrightarrow (as)^* = (bs)^* \\ &\Leftrightarrow as = bs \\ &\Rightarrow a = b \\ &\Leftrightarrow a^* = b^*\end{aligned}$$

and so s^* acts injectively on the *left* of A^* . Then

$$\nu(As) = \mu(s^*A^*) = \mu(A^*) = \nu(A)$$

wherever s acts injectively on the right of A . □

Thus groups, inverse semigroups, semigroups of binary relations, and all other $*$ -semigroups join the commutative semigroups as classes of semigroups where each example is either *fairly amenable (both ways)*, or not at all.

In the next section I give an example of a semigroup that is fairly amenable on one side but not the other.

Every subgroup of an amenable group is amenable, including those subgroups having measure zero. A quick summary of this proof goes as follows: let G be an amenable group with measure μ , H a subgroup. Choose a set M of representatives from each left coset of H , then define a measure ν on H by setting $\nu(A) := \mu(MA)$ for all $A \subseteq H$ (Wagon 1993, p149). It would be nice to emulate this in the semigroup case, but it seems there is no adequate analogue for semigroups of the coset structure of a group. Perhaps the obvious should be stated:

Lemma 3.13 Let S be a left [right] fairly amenable semigroup with measure μ , and let T be a subsemigroup of S having $\mu(T) > 0$. T is then left [right] fairly amenable.

Proof We may use ν as given by $\nu(A) = \mu(A) / \mu(T)$ for all $A \subseteq T$. □

This mirrors the classical case (Day 1957, p.518). In particular, any subgroup G of a left or right fairly amenable semigroup is amenable *provided that* $\mu(G) > 0$.

Corollary 3.14 Let S be a semigroup without zero. S^0 is left [right] fairly amenable if and only if S is. In particular, if G is a group, G^0 is fairly amenable if and only if G is amenable.

Proof Since the finite case is trivial, assume that S is infinite. If S^0 is left fairly amenable with μ' , since S^0 contains a zero, by Lemma 3.6 $\mu'(\{0\}) = 0$, which by finite additivity implies $\mu'(S) = 1$. By Lemma 3.13 S is fairly amenable and, in the case of a group, amenable by Corollary 3.1.

Conversely, if S is left fairly amenable with some μ then assigning $\mu'(A) = \mu(A \cap S)$ yields a fairly invariant measure μ' on S^0 . The case on the right holds similarly. \square

0-groups are examples of Clifford semigroups, which in turn are characterised as being strong semilattices of groups (Howie 1976, p94), and in turn are examples of inverse semigroups. One wonders, therefore, what we can say about Clifford semigroups in general. The following example furnishes us with both a fairly amenable Clifford semigroup that is not a 0-group, having a non-amenable subgroup in a non-trivial manner.

Example 3.15 Let S be the union of two groups as follows: set $G \cong \mathbb{F}_2$ (not amenable) and $H \cong \mathbb{F}_1$ (amenable), and let $\phi : G \rightarrow H$ be the homomorphism mapping $x \mapsto 1_H$ for all $x \in G$. Define the operation on S as a strong semilattice $Y = (\{1, 0\}, \wedge)$ of the groups G, H , i.e. if one of x or y is in H we map the other via ϕ into H to compute xy . Despite the presence of \mathbb{F}_2 , S is fairly amenable.

Proof Let μ_H witness the amenability of H . Define for S the measure μ given by

$$\mu(A) := \mu_H(\phi(A \cap G) \cup (A \cap H)) \quad \text{for all } A \subseteq S,$$

which is invariant under action of H . Since H is an infinite \mathcal{H} -class, $\mu_H(\{1_H\}) = 0$ by Lemma 3.9, and therefore $\mu(G) = 0$; it follows that $\mu(A) = \mu_H(A \cap H)$ for any $A \subseteq S$. If $A \subseteq H$ then $gA = A = Ag$ for all $g \in G$, so μ is trivially invariant under G , and thus μ suffices. \square

The following example shows a fairly amenable Clifford semigroup that has no amenable subgroup as part of the semilattice.

Example 3.16 Consider the semilattice on the integers $Y = (\mathbb{Z}, \wedge)$ where $a \wedge b = \min\{a, b\}$ for all $a, b \in Y$, together with a measure μ derived from the Følner sequence given by $F_n = [-n, n] \cap Y$ for each n .

Now $\mu(k \wedge Y) = \mu((-\infty, k] \cap Y) = \frac{1}{2}$ for all $k \in Y$, all finite sets have measure 0, and the semilattice is fairly amenable.

Suppose we take S to be a strong semilattice of infinitely many non-amenable groups, as follows:

- Let the semilattice Y be isomorphic to (\mathbb{Z}, \wedge) , as previously;
- For each $k \in \mathbb{Z}$ let G_k be a non-amenable group;
- For each $k \in \mathbb{Z}$ let ν_k be any finitely-additive measure on G_k with $\nu_k(G_k) = 1$ (which is necessarily not invariant).

We can extend the μ given on Y to a fairly-invariant μ_S on S by setting, for a fixed free ultrafilter \mathcal{U} over \mathbb{N} ,

$$\mu_S(A) = \lim_{\mathcal{U}} \frac{1}{2n+1} \sum_{k=-n}^n \nu_k(G_k \cap A).$$

While every G_k is not amenable, μ_S witnesses the fair amenability of S . \square

Corollary 3.17 If the Clifford semigroup S is a strong *finite* semilattice Y of groups and S is fairly amenable, at least one of the groups is amenable.

Proof Suppose all the groups in $\{G_y : y \in Y\}$ are non-amenable, and the finitely-additive measure μ witnesses the fair amenability of S .

1. $\mu(G_y) = 0$ for all $y \in Y$.

PROOF: Use Lemma 3.13.

2. $1 = \mu(S) = 0$, contradiction.

PROOF: $S = \bigcup_{y \in Y} G_y$, which is a disjoint union, and then as there are only finitely many groups in the semilattice, $\mu(S) = 0$. □

* * *

One final theorem on groups that translates well to fairly amenable semigroups is that a directed union of amenable groups is also amenable.

Theorem 3.18 If S is the directed union of left [right] fairly amenable semigroups, then S is left [right] fairly amenable.

Proof This proof uses essentially the same topological argument as in (Wagon 1993, p150). Let $\{S_i : i \in I\}$ be the directed system of left fairly amenable semigroups whose union is S : i.e. for each $a, b \in I$ there exists a $c \in I$ such that S_a and S_b are subsemigroups of S_c , and, $S = \bigcup_{i \in I} S_i$. For each $i \in I$:

- let μ_i be the left fairly invariant finitely-additive measure corresponding to S_i ;
- let M_i be the set of finitely-additive measures $m : \mathcal{P}(S) \rightarrow [0, 1]$ such that $m(S) = 1$ and whenever $s \in S_i$ acts injectively on $A \subseteq S$, $m(sA) = m(A)$.

1. M_i is non-empty for all $i \in I$.

PROOF: Define $m_i(A) := \mu_i(A \cap S_i)$ for all $A \subseteq S$. Clearly $m_i \in M_i$.

2. Each M_i is a closed subset of $[0, 1]^{\mathcal{P}(S)}$.

PROOF: Suppose $f \notin M_i$; either f fails to be finitely additive, fails to be left fairly invariant for some $s \in S_i$, or $f(S) \neq 1$. It is possible to vary the “amount” by which each of the three conditions is violated (e.g. $1 - f(S) = \epsilon$), thus forming an open neighborhood of f consisting of points behaving similarly. This argument is similar to (Wagon 1993, p126).

3. The collection $\{M_i : i \in I\}$ has the finite intersection property.

PROOF: If $S_a, S_b \subseteq S_c$ then $M_a \cap M_b \supseteq M_c$, since each member must be left fairly invariant for increasingly many elements.

4. There exists some $\mu \in \bigcap_{i \in I} M_i$ which is the required left fairly-invariant measure.

PROOF: From Tychonoff’s Theorem, the space $[0, 1]^{\mathcal{P}(S)}$ is compact; equivalently, any collection of closed subsets with the finite intersection property is nonempty, and $\{M_i : i \in I\}$ is an example of such a collection.

The right case is handled analogously. □

4 Examples

Proposition 4.1 Any finitely-generated free Abelian semigroup, such as $(\mathbb{N}, +)$, is fairly amenable.

Proof The free Abelian semigroup on k generators is isomorphic to $(\mathbb{N} \cup \{0\})^k$ minus the origin, and again every action is injective. The Følner sequence given by $F_n = \{(a_1, a_2, \dots, a_k) : a_1, a_2, \dots, a_k < n\}$ suffices. □

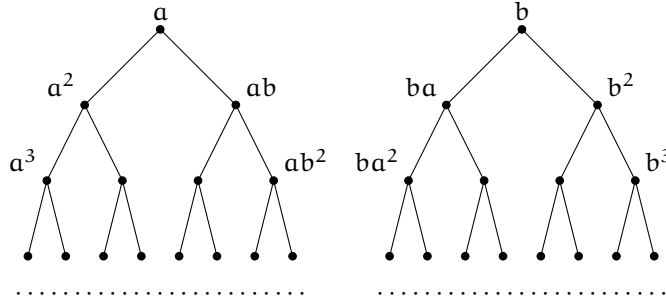

Figure 3: The right Cayley graph for the free semigroup on two generators $\{a, b\}^+$.

Proposition 4.2 (\mathbb{N}, \cdot) (the natural numbers with multiplication) is also a cancellative Abelian semigroup. However, it is infinitely generated (by the primes). It is also fairly amenable.

Proof As usual a totally invariant finitely-additive measure is required. There exists a Følner sequence $\{F_n\}_{n \in \mathbb{N}}$ where F_n consists of the products of powers of the first n primes, and each power lies in $[0, n]$, i.e.

$$F_n := \left\{ p_1^{i_1} p_2^{i_2} \cdots p_n^{i_n} : 0 \leq i_j \leq n, j = 1, \dots, n \right\},$$

as required. Bergelson (2005) demonstrated a family of Følner sequences of this kind. \square

Example 4.3 The free semigroup on two generators $FS_2 = \{a, b\}^+$ is neither left nor right fairly amenable.

Proof Suppose $S = \{a, b\}^+$ is left fairly amenable and μ is the required measure. Note that a and b both act injectively on S and so we require $\mu(aS) = \mu(S) = \mu(bS)$. But since $S = \{a, b\} \cup aS \cup bS$,

$$1 = \mu(S) = \mu(\{a, b\}) + \mu(aS) + \mu(bS) = \mu(\{a, b\}) + 1 + 1 \geq 2,$$

contradiction. By a similar argument, FS_2 is not right fairly amenable. (Alternatively, endow the semigroup with an involution $*$ where $a^* := b$ and vice-versa, and apply Lemma 3.12.) \square

Remark 4.4 Note that the previous argument can be adapted to any finite number of generators $n \geq 2$. Note also that FS_2^0 (the free semigroup on two generators with a zero adjoined) is now not fairly amenable either, in contrast to the classical case.

Remark 4.5 Another theorem on groups states that if a group G is amenable and $N \triangleleft G$, then G/N is also amenable; since every congruence on a group arises as the cosets of a normal subgroup this means that every quotient of an amenable group is amenable. Given μ on an amenable G we may set ν on G/N using

$$\nu(A) = \mu\left(\bigcup A\right). \tag{1}$$

The corresponding situation in fairly amenable semigroups encounters problems. Let σ be a congruence on a fairly left amenable semigroup S with measure μ . Clearly ν has total measure 1 and is finitely-additive. However it is not always going to be left fairly invariant.

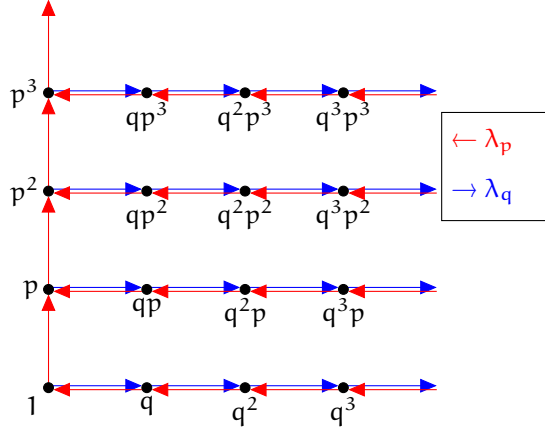

Figure 4: Part of the left Cayley graph of the bicyclic monoid B .

Example 4.6 As described in Proposition 4.1, the free Abelian semigroup on two generators S is fairly amenable with the measure μ . Let σ be the congruence on S with $(b, b^2), (b, ab) \in \sigma$, i.e.

$$S/\sigma \cong \text{sgp} \langle a, b \mid ab = ba = b^2 = b \rangle.$$

S/σ is fairly amenable (it is a free commutative semigroup on one generator with a zero), however ν as in Equation 1 is not fairly invariant since $\nu(A) = \nu((b\sigma)^{-1}A)$ (the Dirac delta measure), via Lemma 3.9. \square

Now we consider some bands. Recall that, in the classical theory, a right zero semigroup is left amenable but not right amenable.

Example 4.7 Let S be a left (or right) zero semigroup. S is fairly amenable (both sides).

Proof The finite case is handled by Corollary 3.4, so assume S is an infinite left zero semigroup.

1. Any finitely-additive measure μ with $\mu(S) = 1$ is right fairly invariant.
PROOF: For any $A \subseteq S$ and $s \in S$, $As = A$, so $\mu(As) = \mu(A)$ trivially.
2. There are infinitely many finitely-additive measures μ with $\mu(S) = 1$ that are left fairly invariant.
PROOF: For any $A \subseteq S$ and $s \in S$, $sA = \{s\}$, and by Lemma 3.6 every $\mu(\{s\}) = 0$ if μ is fairly invariant, but since singletons are the only sets injectively acted on on the left, the following suffices. Fix any free ultrafilter \mathcal{U} , and define $\mu(A) = \chi_{\mathcal{U}}(A)$.

The argument holds on the right analogously. \square

Example 4.8 Every rectangular band is fairly amenable.

Proof We have just seen the specific examples of left and right zero semigroups (Example 4.7). Each rectangular band is isomorphic to the product of a left zero semigroup and a right zero semigroup, therefore by Theorem 3.11 all rectangular bands are fairly amenable. \square

Example 4.9 The bicyclic monoid B is fairly amenable.

Proof Recall that $B = \text{mon} \langle p, q \mid pq = 1 \rangle = \{q^m p^n : m, n \in \mathbb{N} \cup \{0\}\}$.

Consider the sequence given by $\square_n = \{q^j p^k : j, k \leq n\}$ for all $n \in \mathbb{N}$. It will suffice to show this sequence is Følner for any element on the left.

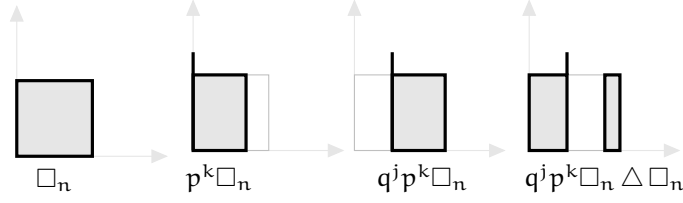

Figure 5: Deriving $|q^j p^k \square_n \triangle \square_n|$ in the bicyclic monoid.

The element q acts injectively on the left of all B , so $|q\square_n| = |\square_n|$ and $|q\square_n \triangle \square_n| = 2n$. p on the other hand does not act injectively on the left of \square_n , in which case $|p\square_n| \leq |\square_n|$. Since the minimal non-injective sets for each left multiplication by p are $\{p^k, qp^{k+1}\}$ for each k , we can see exactly that $|p\square_n| = (n-1)n + 1$, and $|p\square_n \triangle \square_n| = n + 1$. For any arbitrary $x = q^j p^k$, then,

$$|x\square_n \triangle \square_n| = k + n(2j - k) \quad \text{for all } n > j$$

(depicted in Figure 5) which is linear in n , and therefore the Følner sequence $\{\square_n\}_{n \in \mathbb{N}}$ suffices.

B is inverse, so Lemma 3.12 applies and hence B is fairly amenable on both sides. \square

Example 4.10 The polycyclic monoid on two generators, P_2 , is not fairly amenable. As described by Milan (2008), P_2 has the weak containment property, so it follows that fair amenability is not equivalent to weak containment.

Proof Recall that

$$P_2 = \text{mon}^0 \langle p, q, p^{-1}, q^{-1} \mid pp^{-1} = 1 = qq^{-1}, pq^{-1} = 0 = qp^{-1} \rangle,$$

and so every element other than 0 or 1 can be written canonically in the form $x^{-1}y$, where x, y are (possibly empty) strings over the alphabet $\{p, q\}$ (Lawson 2004). It follows that (at least) the free monoids $\{p^{-1}, q^{-1}\}^*$ and $\{p, q\}^*$ are embedded within P_2 .

1. Assume P_2 is left fairly amenable with measure μ , and for each $x \in P_2$ let $H_x \subseteq P_2$ consist of elements with their canonical form starting with the string x . P_2 can be decomposed like so:

$$P_2 = H_{p^{-1}} \cup H_{q^{-1}} \cup H_p \cup H_q \cup \{0, 1\}.$$

2. Consider the injective left actions $\lambda_{p^{-1}}, \lambda_{q^{-1}}$

$$p^{-1}P_2 = H_{p^{-1}} \cup \{0\}, \quad q^{-1}P_2 = H_{q^{-1}} \cup \{0\}.$$

3. Apply μ to see that it is not left fairly invariant.

PROOF:

$$\begin{aligned} 1 &= \mu(P_2) \\ &= \mu(H_{p^{-1}} \cup H_{q^{-1}} \cup H_p \cup H_q \cup \{0, 1\}) \quad \because \text{step 1} \\ &= \mu(H_{p^{-1}}) + \mu(H_{q^{-1}}) + \mu(H_p) + \mu(H_q) + \mu(\{0, 1\}) \\ &= \mu(H_{p^{-1}}) + \mu(H_{q^{-1}}) + \mu(H_p) + \mu(H_q) \quad \because \text{Lemma 3.6} \\ &= \mu(p^{-1}P_2) + \mu(q^{-1}P_2) + \mu(H_p) + \mu(H_q) \quad \because \text{step 2} \\ &= 1 + 1 + \mu(H_p) + \mu(H_q) \quad \because \text{fair invariance} \\ &\geq 2, \end{aligned}$$

contradiction.

P_2 is also inverse, so by Lemma 3.12 it is not right fairly amenable either. \square

Remark 4.11 As with FS_2 and greater, the previous argument can be adapted to any finite number of generators $n \geq 2$. P_2 is also an example of an inverse semigroup that is not fairly amenable, but is classically amenable because the maximal group homomorphic image (the trivial group) is amenable.

Example 4.12 For a Levi-Baer semigroup $LB(p, q)$,

- (i) $LB(p, q)$ is not left fairly amenable if $p = q$;
- (ii) $LB(p, q)$ is not right fairly amenable for all p, q .

Proof Recall that Levi-Baer semigroups are left cancellative, left simple, and have no idempotents.³ For succinctness let S be shorthand for $LB(p, q)$.

On the left:

1. Let $a, b \in S$ be such that the right ideals $a \circ S$ and $b \circ S$ are disjoint. (There are two disjoint right ideals if, and only if, $p = q$.) For example, if S is the Baer-Levi semigroup on \mathbb{N} , we may pick $a : n \mapsto 2n$ and $b : n \mapsto 2n + 1$. Let $R = S \setminus ((a \circ S) \cup (b \circ S))$.
2. Since S is left cancellative, every left action is injective.
3. Assume S is left fairly amenable with measure μ , and derive a contradiction.

PROOF:

$$\begin{aligned}
1 &= \mu(S) \\
&= \mu((a \circ S) \cup (b \circ S) \cup R) \quad \text{by definition} \\
&= \mu(a \circ S) + \mu(b \circ S) + \mu(R) \\
&= \mu(S) + \mu(S) + \mu(R) \quad \because \text{left fairly invariant} \\
&\geq 2,
\end{aligned}$$

a clear contradiction.

On the right:

1. For each $s \in S$ let the equivalence relation θ_s be given by $a \theta_s b \Leftrightarrow a \circ s = b \circ s$ for all $a, b \in S$. Since S consists of maps on the set X , θ_s depends only on $s(X)$, so $a \theta_s b \Leftrightarrow a|_{s(X)} = b|_{s(X)}$.

PROOF: For any $a, b, s \in S$,

$$\begin{aligned}
a \theta_s b &\Leftrightarrow a \circ s = b \circ s \\
&\Leftrightarrow a(s(x)) = b(s(x)) \quad \text{for all } x \in X \\
&\Leftrightarrow a(y) = b(y) \quad \text{for all } y \in s(X) \\
&\Leftrightarrow a|_{s(X)} = b|_{s(X)}.
\end{aligned}$$

2. For every $s \in S$, every θ_s -equivalence class is nonempty and infinite.

PROOF: By definition $|X \setminus s(X)|$ is some infinite cardinal, therefore a Baer-Levi semigroup on $X \setminus s(X)$ can be used to generate elements of each θ_s -class.

3. For each $s \in S$ define two disjoint sets M_1, M_2 by choosing two distinct elements from each θ_s -class. $S \circ s = M_1 \circ s = M_2 \circ s$ and while the action $S \circ s$ is not injective, the actions on M_1 and M_2 are injective.

PROOF: By definition, θ_s partitions S into sets that map to the same element under the right action of s , so $S \circ s = M_1 \circ s = M_2 \circ s$. For any $a, b \in M_1$, $a \circ s = b \circ s \Rightarrow a \theta_s b \Rightarrow a = b$, similarly for M_2 .

³A Baer-Levi semigroup $BL(p, q)$ is defined as being the set of injective maps f on some infinite set X having cardinality p , such that $|X \setminus f(X)|$ is some fixed infinite cardinal $q \leq |X| = p$ (Clifford and Preston 1967). Conventionally, products in Baer-Levi semigroups are written in “algebraist” order—the composition of f and g is written fg —and hence the Baer-Levi semigroups are normally referred to as right cancellative and right simple. However, to remain consistent, I shall use \circ and consider the equivalent “Levi-Baer” semigroup, which is left cancellative and left simple.

4. Assume that S is right fairly amenable with measure ν . This results in a contradiction.

PROOF: Let $R = S \setminus (M_1 \cup M_2)$, then

$$\begin{aligned}
1 &= \nu(S) \\
&= \nu(M_1 \cup M_2 \cup R) \quad \because \text{definition} \\
&= \nu(M_1) + \nu(M_2) + \nu(R) \\
&= \nu(M_1 \circ s) + \nu(M_2 \circ s) + \nu(R) \quad \because \text{right fairly invariant} \\
&= \nu(S \circ s) + \nu(S \circ s) + \nu(R) \quad \because \text{step 3} \\
&= \nu(S) + \nu(S) + \nu(R) \quad \because S \text{ is left simple} \\
&= 1 + 1 + \nu(R) \\
&\geq 2,
\end{aligned}$$

a clear contradiction. \square

Example 4.13 Left groups are left simple, right cancellative semigroups that are characterised as being direct products of groups and left zero semigroups. Let Z be the left zero semigroup with elements from \mathbb{N} , and let S be the left group $\mathbb{F}_{\{a,b\}} \times Z$. S is left fairly amenable but is not right fairly amenable.

Proof On the left: let ξ be any finitely-additive measure on $\mathbb{F}_{\{a,b\}}$ with $\xi(\mathbb{F}_{\{a,b\}}) = 1$. ξ is necessarily not invariant. Fix an ultrafilter \mathcal{U} over \mathbb{N} and define the finitely-additive measure μ by setting

$$\mu(A) := \lim_{\mathcal{U}} \frac{1}{n} \sum_{k=1}^n \xi(A \cap (\mathbb{F}_{\{a,b\}} \times \{k\})) \quad \text{for all } A \subseteq S.$$

1. μ exists, is finitely additive, and $\mu(S) = 1$, as usual.
2. μ is left fairly invariant.

PROOF: Suppose $(g, m) \in S$ acts injectively on the left of $A \subseteq S$: since Z is left zero, this implies that $(x, m_1), (x, m_2) \in A \Rightarrow m_1 = m_2$ for all $x \in \mathbb{F}_2$ and $m_1, m_2 \in Z$, and thus $\mu(A) = 0$. Then,

$$\begin{aligned}
\mu((g, n) \cdot A) &= \lim_{\mathcal{U}} \frac{1}{n} \sum_{k=1}^n \xi((g, n)A \cap (\mathbb{F}_{\{a,b\}} \times \{k\})) \\
&\leq \lim_{\mathcal{U}} \frac{1}{n} \xi(\mathbb{F}_{\{a,b\}}) \\
&= 0.
\end{aligned}$$

On the right: assume S is right fairly invariant with measure ν .

1. A contradiction occurs in a similar manner to the usual proof that \mathbb{F}_2 is not amenable.

PROOF: Consider one set of words $F(a) \subset \mathbb{F}_{\{a,b\}}$, which end with the letter a . Then

$$\begin{aligned}
(F(a) \times Z) \cdot (a^{-1}, 1) &= (F(a)a^{-1} \times Z) \\
&= S \setminus (F(a^{-1}) \times Z),
\end{aligned}$$

and similarly for $F(b)$; hence

$$\begin{aligned}
1 &= \nu(S) \\
&= \nu((F(a) \cup F(a^{-1}) \cup F(b) \cup F(b^{-1}) \cup \{1\}) \times Z) \\
&\geq \nu(F(a) \times Z) + \nu(F(a^{-1}) \times Z) + \nu(F(b) \times Z) + \nu(F(b^{-1}) \times Z) \\
&= \nu(F(a)a^{-1} \times Z) + \nu(F(a^{-1}) \times Z) + \nu(F(b)b^{-1} \times Z) + \nu(F(b^{-1}) \times Z) \\
&= \nu(S) + \nu(S) \\
&= 2,
\end{aligned}$$

contradiction. □

Example 4.14 The free inverse semigroup on one generator FIS_1 is fairly amenable both ways.

Proof From Munn’s Theorem on the structure of free inverse semigroups (Lawson 1998), elements of FIS_1 can be thought of as triples of integers

$$\text{FIS}_1 \cong \{(p, q, r) \in \mathbb{Z}^3 : p \geq 0, p + q \geq 0, q + r \geq 0, r \geq 0, p + q + r \geq 0\}$$

with the product defined by

$$(p, q, r)(p', q', r') := (\max\{p, p' - q\}, q + q', \max\{r', r - q'\})$$

for all $(p, q, r), (p', q', r') \in \text{FIS}_1$ (Lawson 1998, p193). Consider the increasing sequence given by

$$F_n = \{(x, y, z) \in \text{FIS}_1 : x, y, z \leq n\}.$$

1. The sequence $\{|F_n|\}_{n \in \mathbb{N}}$ is the sequence of “house numbers” (On-Line Encyclopedia of Integer Sequences 2013), given by

$$|F_n| = (n + 1)^3 + \frac{1}{6}n(n + 1)(2n + 1)$$

and thus $(n \mapsto |F_n|) \in O(n^3)$.

2. Let $(p, q, r) \in \text{FIS}_1$. By definition,

$$(p, q, r)F_n = \{(\max\{p, x - q\}, q + y, \max\{z, r - y\}) : (x, y, z) \in F_n\}.$$

3. For large n ,

$$|(p, q, r)F_n| \approx |\{(x - q, q + y, z) : (x, y, z) \in F_n\}|$$

i.e. the left action of (p, q, r) on F_n is an almost-translation in \mathbb{Z}^3 , and in particular

$$\begin{aligned} |F_n \triangle (p, q, r)F_n| &\approx |F_n \triangle \{(x - q, q + y, z) : (x, y, z) \in F_n\}| \\ &\approx 2qn^2. \end{aligned}$$

Thus $(n \mapsto |F_n \triangle (p, q, r)F_n|) \in O(n^2)$, and therefore the sequence $\{F_n\}_{n \in \mathbb{N}}$ is Følner. The right case holds similarly. □

Some of the examples and results from above are summarised in Table 1. The variety of interesting examples demonstrate that the “fair” modification of invariant finitely-additive measures interacts well with the structure of semigroups. Some important results from group amenability theory are preserved, and examples of fairly amenable semigroups, especially with zeroes, are more gratifying. The given examples of non-fairly amenable semigroups have a certain self-similarity which might be used to create Banach-Tarski-style paradoxes.

5 The convolution partial action

For real- or complex-valued functions $f : S \mapsto \mathbb{K}$ let the support of f be denoted $\text{supp}(f)$, i.e.

$$\text{supp}(f) := \{x \in S : f(x) \neq 0\}.$$

When two functions f and g have disjoint support (i.e. $\text{supp}(f) \cap \text{supp}(g) = \emptyset$), we will simply say f and g are *disjoint*.

Recall that convolution of two functions $f, g \in \ell^1(S)$, denoted $f * g$, is defined by setting

$$\{f * g\}(x) := \sum_{st=x} f(s)g(t) \quad \text{for all } x \in S.$$

Kind of semigroup	Classically amenable	Fairly amenable
Finite	\Leftrightarrow Unique min. ideals	Yes (3.4)
With zero	Yes	Sometimes (3.14)
Monogenic	Yes	Yes (4.1)
Free (≥ 2 gen.)	No	No (4.3)
Abelian	Yes	?
Clifford	Sometimes	Sometimes (3.15)
Left/right zero sgp	Sided	Yes (4.7)
Left/right group	?	Sometimes (Sided; 4.13)
Baer-Levi	?	No (4.12)
Inverse	\Leftrightarrow Max grp hom. im. is	Sometimes
Bicyclic	Yes	Yes (4.9)
Polycyclic	Yes (\cdot : zero)	No (4.10)
Free monogenic inverse	Yes	Yes (4.14)

Table 1: Amenability versus fair amenability on different semigroups.

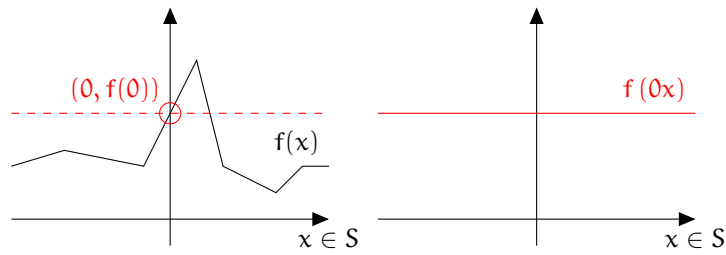

Figure 6: The result of the dual left action of 0 on some $f \in \ell^\infty(S)$.

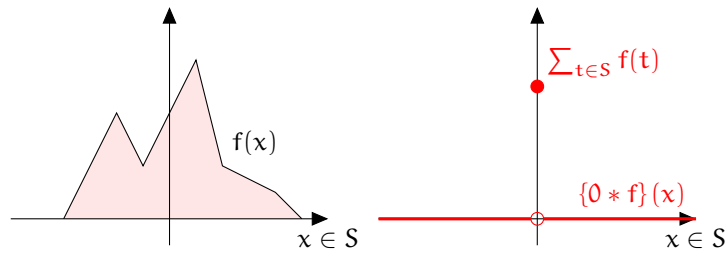

Figure 7: The result of the left $*$ -action of 0 on some $f \in \ell^1(S)$.

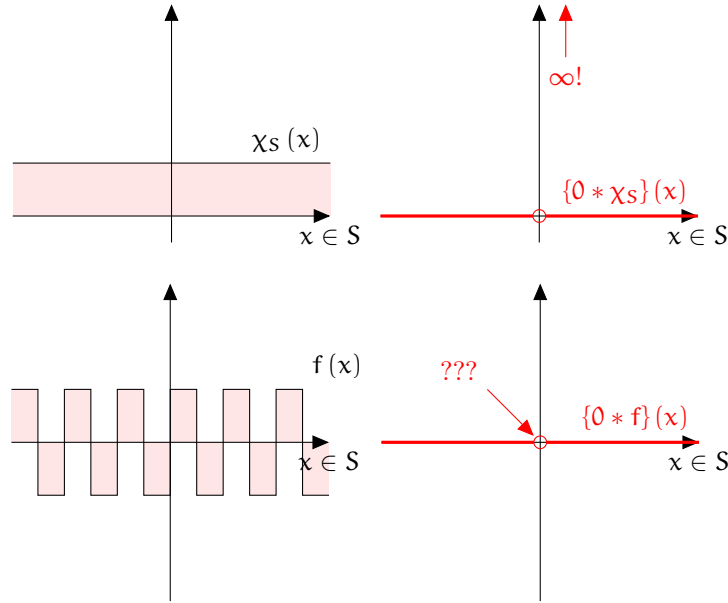

Figure 8: Some example cases where the convolution partial action of 0 is not well-defined on $\ell^\infty(S)$.

This extends to a left convolution “action” of $s \in S$ on $f \in \ell^\infty(S)$, denoted $s * f$, which may be defined by setting

$$\{s * f\}(x) := \sum_{st=x} f(t) \quad \text{for all } x \in S.$$

Alternatively,

$$\{s * f\}(x) = \sum_{t \in s^{-1}x} f(t) \quad \text{for all } x \in S.$$

For each $s \in S$, let the equivalence relation θ_s on S be given by setting $x \theta_s y$ if and only if $sx = sy$, for all $x, y \in S$. Note that each $s^{-1}x$ is precisely a θ_s -equivalence class.

Unsurprisingly, $*$ often fails to be an operation that is closed in $\ell^\infty(S)$, or even well-defined. In contrast to the dual action which “flattens” along sections of the domain (see Figure 6), the convolution “action” has the appearance of “bunching up” the values along the domain (Figure 7). For an extreme example, suppose S is an infinite semigroup with zero. Then

$$0 * \chi_S = \sum_{t \in S} \chi_{0\{t\}} = \sum_{t \in S} \chi_{\{0\}} = \delta_0,$$

which takes the “value” $|S| = \infty$ at 0. Less extreme cases can also fail to be defined along the entire domain S . Examples are depicted in Figure 8. There are a few ways this situation might be treated.

- (i) We could include, into the scope of discussion, unbounded functions and functions that possibly take the value ∞ . This makes the $*$ -“action” a mapping $S \times \ell^\infty(S) \rightarrow \mathbb{C}_\infty^S$. This approach is inclusive of degenerate cases such as δ_0 , but merely pushes problems relating to singularities into a more complicated place. Additionally this approach does not address those $s * f$ which fail to be well-defined, but could still be argued to be bounded.

- (ii) We could regard convolution as inducing a partial action—simply accept that there will be cases where it is ill-defined, and keep to regions where it is well-defined. Since we wish to apply it to means in $\ell^\infty(\mathbf{S})^*$, we must also keep to the cases that are bounded. It is conceivable that $s * f$ exists in $\mathbb{C}^{\mathbf{S}}$ but is unbounded, for instance, s collapses steadily increasing numbers of elements together, but never infinitely many. It is also conceivable that $s * f$ is not well-defined because of a failure to converge, but is arguably bounded.

Now, $s * f$ is well-defined and bounded exactly when $s * f \in \ell^\infty(\mathbf{S})$. Since \mathbf{S} is associative, with $\ell^\infty(\mathbf{S})$ as a set of objects, \mathbf{S} induces a set of arrows $\mathbf{A}_{\mathbf{S}}$, where for each $s \in \mathbf{S}$ there is an arrow from each f to $s * f$ wherever $s * f \in \ell^\infty(\mathbf{S})$, so $(\ell^\infty(\mathbf{S}), \mathbf{A}_{\mathbf{S}})$ defines a semi-category. If \mathbf{S} has an identity, then it is a category.

This last point seems interesting, not least because partial actions on \mathbf{C}^* -algebras are the subject of current research. For our purpose here, we must ask under what conditions is $s * f$ bounded, if not $f \in \ell^1(\mathbf{S})$?

Lemma 5.1 If s acts injectively on the left on $\text{supp}(f)$, then $s * f \in \ell^\infty(\mathbf{S})$.

Proof By hypothesis, $\{s * f\}(t)$ is equal to $f(x)$ for some $x \in \mathbf{S}$ ($sx = t$) or zero (no such x). This is true for any $t \in \text{supp}(f)$, and thus $s * f \in \ell^\infty(\mathbf{S})$. \square

In particular, $s * f$ exists and is bounded whenever \mathbf{S} is left cancellative (e.g. is a group). For a semigroup generally, however, the converse does not hold: there may be $f \in \ell^\infty(\mathbf{S})$ such that $s * f \in \ell^\infty(\mathbf{S})$ but s is not injective on the support. For example, $f \in \ell^1(\mathbb{N}^0)$ given by $f(n) = 2^{-n}$, then $0 * f = \chi_{\{0\}}$.

It is possible to be far more precise than Lemma 5.1 in characterising the elements for which $s * f$ is bounded, but it is in essence a restatement of the definition of $\|\cdot\|_\infty$. For each $s \in \mathbf{S}$, those functions f can be thought of as

- (i) behaving like elements of $\ell^1(\mathbf{S})$ on the subsets of \mathbf{S} on which s does not act injectively, and
- (ii) behaving like elements of $\ell^\infty(\mathbf{S})$ on the subsets of \mathbf{S} on which s does act injectively.

Since these subsets of \mathbf{S} only change with respect to s , this suggests, for each $s \in \mathbf{S}$, a space⁴ $\ell^{s*}(\mathbf{S})$ given by

$$f \in \ell^{s*}(\mathbf{S}) \Leftrightarrow s * f \in \ell^\infty(\mathbf{S}).$$

Clearly, $\ell^1(\mathbf{S}) \subseteq \ell^{s*}(\mathbf{S}) \subseteq \ell^\infty(\mathbf{S})$. By definition, $s * f \in \ell^\infty(\mathbf{S})$ precisely when there is some fixed finite bound $B \geq |\{s * f\}(x)| = |\sum_{t \in s^{-1}x} f(t)|$ for all $x \in \mathbf{S}$.

Whether or not $s * f \in \ell^\infty(\mathbf{S})$, if $\{s * f\}(x)$ is not defined for some $x \in \mathbf{S}$, then certainly $x \notin \text{supp}(s * f)$, i.e. $\text{supp}(s * f)$ can be considered well-defined even if $s * f$ is not. Therefore for all s, f , $\text{supp}(s * f) = s \cdot \text{supp}(f) \subseteq s\mathbf{S}$. Therefore $s * \ell^{s*}(\mathbf{S})$ can be identified with a subset of $\ell^\infty(s\mathbf{S})$. Since every $f \in \ell^\infty(s\mathbf{S})$, is attainable as some $s * g$ for $g \in \ell^{s*}(\mathbf{S})$, it follows that

$$s * \ell^{s*}(\mathbf{S}) \equiv \ell^\infty(s\mathbf{S});$$

in particular, $s * f \in \ell^\infty(\mathbf{S})$ if, and only if, $(s * f)|_{s\mathbf{S}} \in \ell^\infty(s\mathbf{S})$.

Lemma 5.2 For all $s \in \mathbf{S}$ and $A \subseteq \mathbf{S}$, the following conditions are equivalent.

- (i) $s * \chi_A \in \ell^\infty(\mathbf{S})$.
- (ii) There exists a finite partition $\{A_i\}_{i \in I}$ of A such that s acts injectively on the left of each A_i .

⁴Not to be confused with either $\ell^p(\mathbf{S})$ or $\ell(\mathbf{S})^*$.

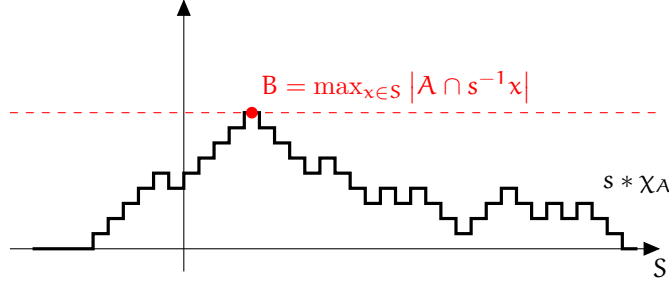

Figure 9: Diagram accompanying Lemma 5.2.

(iii) $s * \chi_A$ is simple.

Proof

(i) \Rightarrow (ii): Suppose $\|s * \chi_A\|_\infty = B < \infty$. B is a non-negative integer which $s * \chi_A$ attains, since the value at each point is a sum of values in $\{0, 1\}$. For all $x \in S$ we have

$$\begin{aligned} \{s * \chi_A\}(x) &= \sum_{t \in s^{-1}x} \chi_A(t) \\ &= |A \cap s^{-1}x| \\ &\leq B \quad \text{by hypothesis.} \end{aligned}$$

For $i = 1, \dots, B$ let A_i consist of one choice element from each $(A \cap s^{-1}x) \setminus \bigcup_{j < i} A_j$ for $x \in S$ (where it is not empty).⁵ Then B choices are made, each $A \cap s^{-1}x$ is exhausted, and $I = \{1, \dots, B\}$ is finite. The finite collection $\{A_i\}_{i \in I}$ is a partition of A , since the sets of the form $s^{-1}x$ for each $x \in S$ are either empty, or distinct θ_s -equivalence classes. s acts injectively on the left of each A_i , as $A_i \cap s^{-1}x$ is either empty or a singleton set.

(ii) \Rightarrow (iii): Suppose there is a finite partition $\{A_i\}_{i \in I}$ of A such that s acts injectively on the left of A_i . Then $\chi_A = \sum_{i \in I} \chi_{A_i}$ and $s * \chi_{A_i} = \chi_{sA_i}$ for each $i \in I$, and thus

$$s * \chi_A = s * \sum_{i \in I} \chi_{A_i} = \sum_{i \in I} s * \chi_{A_i} = \sum_{i \in I} \chi_{sA_i},$$

which is a linear combination of finitely-many indicator functions, i.e. is simple.

(iii) \Rightarrow (i): If $s * \chi_A$ is simple then by definition it consists of a linear combination of finitely-many indicator functions, and thus attains some finite bound. \square

Another impediment to deducing standard results includes the difficulty in working with even simple functions. Suppose $f \in \ell^\infty(S)$ is simple, and thus there exists a finite index set I , and collections of numbers $\{a_i \in \mathbb{C} : i \in I\}$ and sets $\{A_i \in \mathcal{P}(S) : i \in I\}$ such that $f = \sum_{i \in I} a_i \chi_{A_i}$. Where it exists, $*$ distributes over $+$, and clearly if $s * f$ is bounded then $s * \chi_{A_i}$ is also bounded for each $i \in I$. Therefore,

$$s * f = \sum_{i \in I} a_i \cdot (s * \chi_{A_i}).$$

⁵The Axiom of Choice is not required because the set is finite.

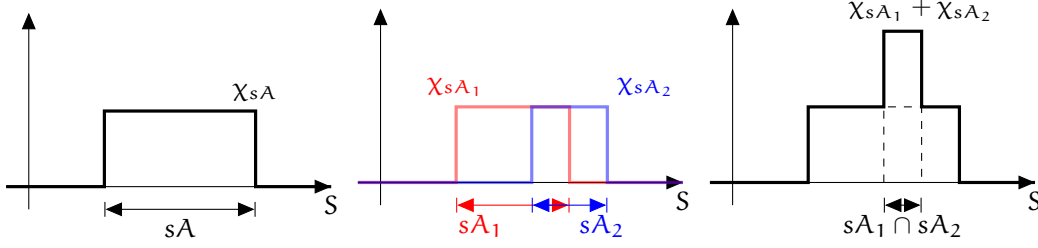

Figure 10: An example of $s * \chi_A \geq \chi_{sA}$. $\chi_{sA} \leq \chi_{sA_1} + \chi_{sA_2}$, where $A = A_1 \cup A_2$ and s acts injectively on A_1 and A_2 but not A as a whole.

However, if the action of s is *not* injective on each A_i , it isn't at all likely that

$$\sum_{i \in I} \alpha_i \cdot (s * \chi_{A_i}) \geq \sum_{i \in I} \alpha_i \chi_{sA_i}$$

is saturated, and in fact $\sum_{i \in I} \alpha_i \chi_{sA_i}$ could vary depending upon the selection of $\{A_i\}_{i \in I}$.

Fortunately, if $s * f$ is bounded then each $s * \chi_{A_i}$ is bounded and therefore by Lemma 5.2 is simple, and also, there exists a finite partition $\{B_{ij}\}_{j \in J_i}$ of each A_i such that s acts injectively on the left of each B_{ij} . Thus

$$s * f = \sum_{i \in I} \alpha_i \sum_{j \in J_i} \chi_{sB_{ij}},$$

and hence if f is simple then so is $s * f$ (where it exists and is bounded).

6 Integrating $s * f$

Definition 6.1 Let $m \in \ell^\infty(S)^*$. m is *left *-invariant* if

$$m(f) = m(s * f)$$

for all $s \in S$ and $f \in \ell^\infty(S)$ wherever $s * f \in \ell^\infty(S)$.

The purpose of this section will be to show that Definition 6.1 is equivalent to left fair amenability of S , i.e. the existence of a left *-invariant (where bounded) mean is equivalent to the existence of a left fairly-invariant probability measure.

Suppose S supports a left *-invariant mean m as described in Definition 6.1. It is easy to see why Definition 6.1 is at least as strong as left fair amenability: when s acts injectively on the left of A , $s * \chi_A = \chi_{sA}$, and so a *-invariant mean can be applied to the indicator functions. To show the converse, I shall integrate with respect to μ .

First, let us consider indicator functions.

Lemma 6.2 Let S be a left fairly amenable semigroup with measure μ , $s \in S$, and $A \subseteq S$. If $s * \chi_A \in \ell^\infty(S)$ then

$$\int (s * \chi_A) d\mu = \int \chi_A d\mu.$$

Proof If $s * \chi_A \in \ell^\infty(S)$, then there is the finite partition $\{A_i\}_{i \in I}$ of A provided by Lemma 5.2 such that s acts injectively on the left of each A_i . Then

$$\begin{aligned} \int (s * \chi_A) d\mu &= \int \left(\sum_{i \in I} \chi_{sA_i} \right) d\mu \\ &= \sum_{i \in I} \mu(sA_i) \quad \text{by definition} \\ &= \sum_{i \in I} \mu(A_i) \quad \because \text{fair invariance} \\ &= \mu(A) \quad \because \text{finitely additive} \\ &= \int \chi_A d\mu \quad \text{again by definition,} \end{aligned}$$

as required. □

Lemma 6.3 Let S be a left fairly amenable semigroup with measure μ , $s \in S$, and $f \in \ell_+^\infty(S)$ is a simple function. If $s * f \in \ell^\infty(S)$ then

$$\int (s * f) d\mu = \int f d\mu.$$

Proof There are the requisite finite index set I , sets $\{A_i\}_{i \in I}$ and values $\alpha_i \in \mathbb{R}^+$ for $i \in I$ such that $f = \sum_{i \in I} \alpha_i \chi_{A_i}$. If $s * f \in \ell^\infty(S)$ then $s * \chi_{A_i} \in \ell^\infty(S)$ for each $i \in I$, and therefore

$$\begin{aligned} \int (s * f) d\mu &= \int \left(s * \sum_{i \in I} \alpha_i \chi_{A_i} \right) d\mu \\ &= \int \left(\sum_{i \in I} \alpha_i \cdot (s * \chi_{A_i}) \right) d\mu \\ &= \sum_{i \in I} \alpha_i \int (s * \chi_{A_i}) d\mu \\ &= \sum_{i \in I} \alpha_i \int \chi_{A_i} d\mu \quad \because \text{Lemma 6.2} \\ &= \int \left(\sum_{i \in I} \alpha_i \chi_{A_i} \right) d\mu \\ &= \int f d\mu \end{aligned}$$

as required. □

Let $\ell_+^\infty(S)$ denote the subset of $\ell^\infty(S)$ consisting of bounded real-valued non-negative functions on S .

Not every simple function $h \leq s * f$ is of the form $s * g$ for a simple $g \in \ell_+^\infty(S)$, $g \leq f$. For example, let $f \in \ell^1(\mathbb{N}^0)$ with $f(n) = 1/2^n$ for each n . Then $\{0 * f\}(0) = 2$. $h = 0 * f$ itself is simple. However, there is no $g \leq f$ such that g is simple and $0 * g = h$ (that would require either g to be non-simple or $g > f$). It is nevertheless sufficient to range over all functions of the form $s * g$ for simple $g \leq f$, when integrating $s * f$, as $s * g$ approximates $s * f$ increasingly well as g gains detail.

Lemma 6.4 Let S be a left fairly amenable semigroup with measure μ , $s \in S$, and $f \in \ell_+^\infty(S)$. If $s * f \in \ell_+^\infty(S)$ then

$$\int (s * f) d\mu = \int f d\mu.$$

Proof If $s * f \in \ell_+^\infty(S)$ then $s * h \in \ell_+^\infty(S)$ for every simple function $h \leq f$. Thus

$$\begin{aligned} \int (s * f) d\mu &= \sup \left\{ \int h d\mu : h \leq (s * f), h \text{ is simple} \right\} \quad \text{by definition} \\ &= \sup \left\{ \int (s * g) d\mu : (s * g) \leq (s * f), g \text{ is simple} \right\} \\ &= \sup \left\{ \int g d\mu : g \leq f, g \text{ is simple} \right\} \quad \because \text{Lemma 6.3} \\ &= \int f d\mu \quad \text{by definition} \end{aligned}$$

as required. □

The next lemma is entirely routine.

Lemma 6.5 Let S be a left fairly amenable semigroup with measure μ , $s \in S$, and real-valued $f \in \ell^\infty(S)$. If $s * f \in \ell^\infty(S)$ then

$$\int (s * f) d\mu = \int f d\mu.$$

Proof There exist $f^+, f^- \in \ell_+^\infty(S)$ such that $f = f^+ - f^-$. If $s * f \in \ell^\infty(S)$ then so too $s * f^+$ and $s * f^-$, thus

$$\begin{aligned} \int (s * f) d\mu &= \int (s * (f^+ - f^-)) d\mu \\ &= \int ((s * f^+) - (s * f^-)) d\mu \\ &= \int (s * f^+) d\mu - \int (s * f^-) d\mu \\ &= \int f^+ d\mu - \int f^- d\mu \quad \because \text{Lemma 6.4} \\ &= \int (f^+ - f^-) d\mu \\ &= \int f d\mu \end{aligned}$$

as required. □

The complex-valued case is even more pedestrian, so it is omitted.

Theorem 6.6 (Main Theorem) A semigroup S is left fairly amenable if, and only if, there exists a left $*$ -invariant mean in $\ell^\infty(S)^*$.

Proof Suppose S is left fairly amenable with the finitely-additive measure μ . By Lemma 6.5, the integral with respect to μ is $*$ -invariant, therefore use the mean $m \in \ell^\infty(S)^*$ given by setting

$$m(f) := \int f d\mu \quad \text{for all } f \in \ell^\infty(S).$$

Conversely, if S supports a left $*$ -invariant mean m , define the measure $\mu \in [0, 1]^{\mathcal{P}(S)}$ by setting

$$\mu(A) := m(\chi_A) \quad \text{for all } A \in \mathcal{P}(S).$$

Then, if $s \in S$ acts injectively on the left of $A \in \mathcal{P}(S)$, $s * \chi_A = \chi_{sA}$, and then

$$\begin{aligned} \mu(sA) &= m(\chi_{sA}) \\ &= m(s * \chi_A) \\ &= m(\chi_A) = \mu(A), \end{aligned}$$

as required. □

6.1 Acknowledgements

I extend a heartfelt thank-you to my supervisor Dr Des FitzGerald for his continued patience and wisdom during the project.

References

- Argabright, L. N. and Wilde, C. O.: 1967, Semigroups satisfying a strong Følner condition, *Proceedings of the American Mathematical Society* **18**(4), 587–591.
- Bergelson, V.: 2005, Multiplicatively large sets and ergodic Ramsey theory, *Israel Journal of Mathematics* **148**(1), 23–40.
- Clifford, A. H. and Preston, G. B.: 1967, *The Algebraic Theory of Semigroups*, Vol. 2 of *American Mathematical Society Mathematical Surveys*, American Mathematical Society.
- Day, M. M.: 1957, Amenable semigroups, *Illinois Journal of Mathematics* .
- Donnelly, J.: 2012, Subsemigroups of Cancellative Amenable Semigroups, *Int. J. Contemp. Math. Sciences* **7**(23), 1131–1137.
- Duncan, J. and Namioka, I.: 1978, Amenability of inverse semigroups and their semigroup algebras, *Proceedings of the Royal Society of Edinburgh: Section A Mathematics* **80**, 309–321.
- Følner, E.: 1955, On groups with full Banach mean value, *Math. Scand* **3**, 243–254.
- Howie, J. M.: 1976, *An Introduction to Semigroup Theory*, L.M.S. Monographs, Academic Press.
- Johnson, B. E.: 1972, Approximate diagonals and cohomology of certain annihilator Banach algebras, *American Journal of Mathematics* **94**(3), 685–698.
- Jones, D. G. and Lawson, M. V.: 2011, Graph inverse semigroups: their characterization and completion, *arXiv.org* pp. 1–30.
- Lawson, M. V.: 1998, *Inverse Semigroups*, World Scientific Publishing Co. P/L.
- Lawson, M. V.: 2004, Representations of the Thompson group F via representations of the polycyclic monoid on two generators.
- Milan, D.: 2007, C^* -algebras of inverse semigroups: amenability and weak containment, *arXiv.org* **arXiv:math**.

- Milan, D.: 2008, *C*-algebras of inverse semigroups*, PhD thesis, University of Nebraska.
- Namioka, I.: 1964, Følner's Conditions For Amenable Semi-Groups, *Math. Scand* **15**, 18–28.
- On-Line Encyclopedia of Integer Sequences: 2013, A051662.
URL: <http://oeis.org/A051662>
- Paterson, A. L. T.: 1988, *Amenability*, American Mathematical Society.
- Paterson, A. L. T.: 1998, *Groupoids, Inverse Semigroups, and their Operator Algebras*, Birkhäuser, Boston.
- Runde, V.: 2002, *Lectures on Amenability*, Lecture Notes in Mathematics, Springer Verlag.
- van Douwen, E. K.: 1992, Finitely additive measures on \mathbb{N} , *Topology and its Applications* **47**(3), 223–268.
- von Neumann, J.: 1929, Zur allgemeinen Theorie des Masses, *Fundamenta Mathematica* **13**, 73–116.
- Wagon, S.: 1993, *The Banach-Tarski Paradox*, Cambridge University Press.
- Yang, Z.: 1987, Følner numbers and Følner type conditions for amenable semigroups, *Illinois Journal of Mathematics* **31**(3), 496–517.