

A 2-CATEGORY OF CHRONOLOGICAL COBORDISMS AND ODD KHOVANOV HOMOLOGY

KRZYSZTOF K. PUTYRA

ABSTRACT. We create a framework for odd Khovanov homology in the spirit of Bar-Natan's construction for the ordinary Khovanov homology. Namely, we express the cube of resolutions of a link diagram as a diagram in a certain 2-category of chronological cobordisms and show that it is 2-commutative: the composition of 2-morphisms along any 3-dimensional subcube is trivial. This allows us to create a chain complex, whose homotopy type modulo certain relations is a link invariant. Both the original and the odd Khovanov homology can be recovered from this construction by applying certain strict 2-functors. We describe other possible choices of functors, including the one that covers both homology theories and another generalizing dotted cobordisms to the odd setting. Our construction works as well for tangles and is conjectured to be functorial up to sign with respect to tangle cobordisms.

1. INTRODUCTION

The Khovanov homology [Kh99] opened to knot theorists a new and interesting world of powerful invariants, of which knot polynomials are only shadows. For instance, the Euler characteristic of the Khovanov homology is the Jones polynomial of a link. It did not take much time to prove usefulness of these invariants. For instance, the Lee deformation of the Khovanov's differential [Le05] leads to a spectral sequence, from which J. Rasmussen extracted a lower bound for the knot genus, giving a combinatorial proof of Milnor Conjecture [Ra04]. Moreover, the Khovanov homology detects the unknot [KM12] and unlinks [HN12], although the question whether the Jones polynomial is an unknot detector is still open. This raised a question, whether there were other link homology theories categorifying the Jones polynomial. In particular, D. Bar-Natan [BN05] described a very general construction that produces link homology for rank two Frobenius algebras satisfying some additional relations. Then M. Khovanov classified all theories that arise from Frobenius systems [Kh04], proving that the Bar-Natan's theory of dotted cobordisms is universal.

When it seemed that categorifications of the Jones polynomial were well understood, P. Ozsváth, J. Rasmussen and Z. Szabó published a paper with a distinct construction [ORS13] based on a *projective* TQFT. Their invariant also categorifies the Jones polynomial, but the algebra used in the construction is not cocommutative and even not coassociative. They call it *odd Khovanov homology*, because of similarity with the original construction, which we now refer to as *even*. Both theories agree modulo 2, but they are not equivalent over \mathbb{Z} . In particular, results of A. Shumakovitch [Sh11] provide examples of pairs of knots that can be distinguished by one theory but not by the other. Moreover, it was proved by J. Bloom that the odd Khovanov homology is mutation invariant [Blo10], generalizing the similar result by S. Wehrli for even Khovanov homology with \mathbb{Z}_2 coefficients [Wh10]. On

Key words and phrases. categorification, chronology, cobordism, covering homology, dotted cobordisms, Frobenius algebra, functoriality, Khovanov homology, knot, link, odd homology, planar algebra, tangle.

the other hand, the even Khovanov homology detects mutant links, but the problem is still open for knots.

Both theories are obtained from the cube of resolutions of a link diagram. Namely, given a link diagram D with n crossings we create 2^n pictures, by resolving each crossing horizontally (type 0 resolution) or vertically (type 1 resolution):

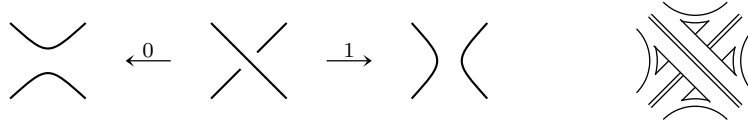

The picture of crossing highways is placed to the right to help to remember the naming convention: a resolution of a crossing can be seen as leaving one highway by turning right (assuming the traffic is on the right side). In type 0 we leave the lower highway, while in type 1 the upper one. We place all such pictures in vertices of an n -dimensional cube and decorate its edges with certain cobordisms. This cube commutes and by applying a TQFT functor we obtain a commuting cube of abelian groups and homomorphisms, which can be collapsed to a chain complex (after changing signs of some maps). On the other hand, a projective TQFT from [ORS13] produces a cube that commutes only up to signs, which has to be fixed before collapsing. It is a kind of mystery, why this is possible.

The last step is exactly why the odd theory does not fit into Bar-Natan's framework. The latter starts with a cube of resolutions and cobordisms, and invariance is proved at this level, before applying a TQFT functor. The author extended this framework [Pu08] using cobordisms with an additional structure, a *chronology*, which is a framed Morse function $\tau: W \rightarrow I$ that separates critical points [Ig87]. Isotopies of these functions equip the category of chronological cobordisms with a structure of a 2-category and we can express the projective functor from [ORS13] as a strict 2-functor. By translating Bar-Natan's construction into this new framework, we were able to show invariance of the complex built from chronological cobordisms. Applying different 2-functors recovers both the even and odd Khovanov homology. In particular, it follows from contractibility of certain loops in the space of framed functions that in the odd theory we can always distribute signs over edges of the cube to make it commute. In addition to that, we have found several theories with parameters, especially the *covering homology* $H^{cov}(L)$.

It is a sequence of graded modules over the ring of truncated polynomials $\mathbb{Z}[X, Y, Z^{\pm 1}]/(X^2 = Y^2 = 1)$, from which we can obtain both even and odd Khovanov homology as illustrated to the right. The specializations take place at the level of chains.

$$\begin{array}{ccc}
 & \mathcal{H}(L) & \\
 \swarrow^{X, Y, Z \mapsto 1} & & \searrow_{\substack{X, Z \mapsto 1 \\ Y \mapsto -1}} \\
 \mathcal{H}_{ev}(L) & & \mathcal{H}_{odd}(L)
 \end{array}$$

This construction was first described in [Pu08]. Another example is given by chronological cobordisms with dots that generalizes the universal Bar-Natan's theory to the odd setting. By an analogy to the even case it is proved to be universal, see Theorem 11.9. A motivation was to find an odd analog of Lee's deformation, the goal that has not been reached.

A connection with categorified quantum groups. The existence of covering homology theory fits nicely with recent discoveries regarding odd categorifications of quantum groups. It is known that the even Khovanov homology can be recovered from categorical representations of categorified $U_q(\mathfrak{sl}_2)$ [We10]. A recent discovery of odd nilHecke algebras [EKL12, KKT11], which categorifies the negative half of $U_q(\mathfrak{sl}_2)$, suggests the existence of the odd Khovanov homology may also possess a representation-theoretical explanation.

The odd nilHecke algebras appeared to be connected with the Lie superalgebra $U_q(\mathfrak{osp}_{1|2})$. Both $U_q(\mathfrak{sl}_2)$ and $U_q(\mathfrak{ops}_{1|2})$ are covered by a Kac-Moody algebra $U_{q,\pi}$ introduced by S. Clark, D. Hill and W. Wang [CHW13, HW12], where π is a formal parameter with $\pi^2 = 1$. The relationship is illustrated in the diagram to the right. Recently, A. Lauda and A. Ellis categorified the covering algebra $U_{q,\pi}$ using graded supermonoidal categories, in which the relation $(f \otimes \text{id}) \circ (\text{id} \otimes g) = (\text{id} \otimes g) \circ (f \otimes \text{id})$ holds up to a sign in a coherent way [EL13]. It is expected that this categorification leads to homologies covering both odd and even homology theories and the author believes that the covering Khovanov homology described in this paper is one of them.

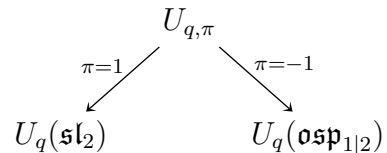

Outline. We start the paper with a picture visualizing the construction of the Khovanov complex for the trefoil knot, see Fig. 1. We hope it will serve as a motivation for the next two sections, in which we define chronological cobordisms and analyze changes of chronologies. Section 3 describes the 2-category of chronological cobordisms of any dimension and explains a symmetric monoidal structure induced by a disjoint union. The section ends with a detailed description of the two-dimensional case. A refined version of chronological cobordisms embedded in $\mathbb{D}^2 \times I$ is described in Section 4, together with a solution for *chronological relations*: permuting critical points corresponds to scaling a cobordism by an invertible scalar.

Details of the construction of the generalized Khovanov complex for a tangle diagram are given in Sections 5 and 6. The former deals with link diagrams only, whereas the latter describes how to extend the construction to tangles in the spirit of Bar-Natan, using planar algebras. Unfortunately, the functors forming a planar algebra of chronological cobordisms are not strict, so that we cannot combine complexes for tangles in the naive way. This issue is partially resolved in Section 7, where we prove invariance of the generalized complex under Reidemeister moves. Section 8 contains several straightforward properties of the complex.

The next few sections are devoted to computation of the homology of the complex. We recover both odd and even Khovanov homology from our construction in Section 9. The covering homology is defined in Section 10, in which we define a chronological version of a Frobenius system. Similarly to the ordinary case, a chronological Frobenius system induces a TQFT 2-functor from the category of chronological cobordisms to a 2-category of graded symmetric bimodules. They are analyzed in the next section. In particular, we describe dotted chronological cobordisms and their algebra, proving it is universal among all Frobenius systems fitting in our framework.

Section 12 contains several remarks and constructions related to this paper, but not fully explored. We discuss, following [BN05], functoriality up to ‘sign’ of our construction, where a ‘sign’ is understood as an invertible scalar in degree 0. Then we analyze a choice in defining chronological relations: there is one type of changes for which the associated coefficients are defined only up to a scalar XY , although the whole construction is independent of this choice. Finally, we analyze a possible connection of our construction to the one based on \mathfrak{sl}_2 foams [Ca09]. We suppose there is a parallel theory of chronological foams, closely connected to our construction.

The construction of chronological cobordisms utilizes the theory of framed functions, which is an interesting enrichment of Morse theory. It is described in Appendix A following [Ig87]. In particular, we describe all singularities of these functions up to codimension two.

The paper uses also several 2-categorical constructions, including semi-strict monoidal structure and braiding. These are explained in Appendix B.

Acknowledgement. This paper would have never been written without help of many people. The problem of creating a framework for odd Khovanov homology was suggested by Dror Bar-Natan while the author was at the University of Toronto. The dotted algebra was understood with the help of Anna Beliakova, when the author visited her in Zürich. Several ideas used to clarify the original construction came out after discussions with Aaron Lauda, Robert Lipshitz, Mikhail Khovanov, Józef Przytycki and Alexander Shumakovitch. The author is also thankful to Alexander Ellis, Maria Hempel, Vasily Manturov, Cotton Seed and Joshua Batson for interesting discussions and remarks. Further, the author would like to thank the referees for their insightful remarks on an earlier version of this paper.

2. THE PICTURE

We begin with describing elements of the big diagram in Fig. 1. In the next few sections we shall create a framework for this picture.

Knot. In the left top corner we can see a diagram D of the left-handed trefoil with enumerated crossings. Each crossing is equipped with an arrow oriented in such a way that it connects the two arcs in the type 0 resolution at this crossing (there are two choices of such

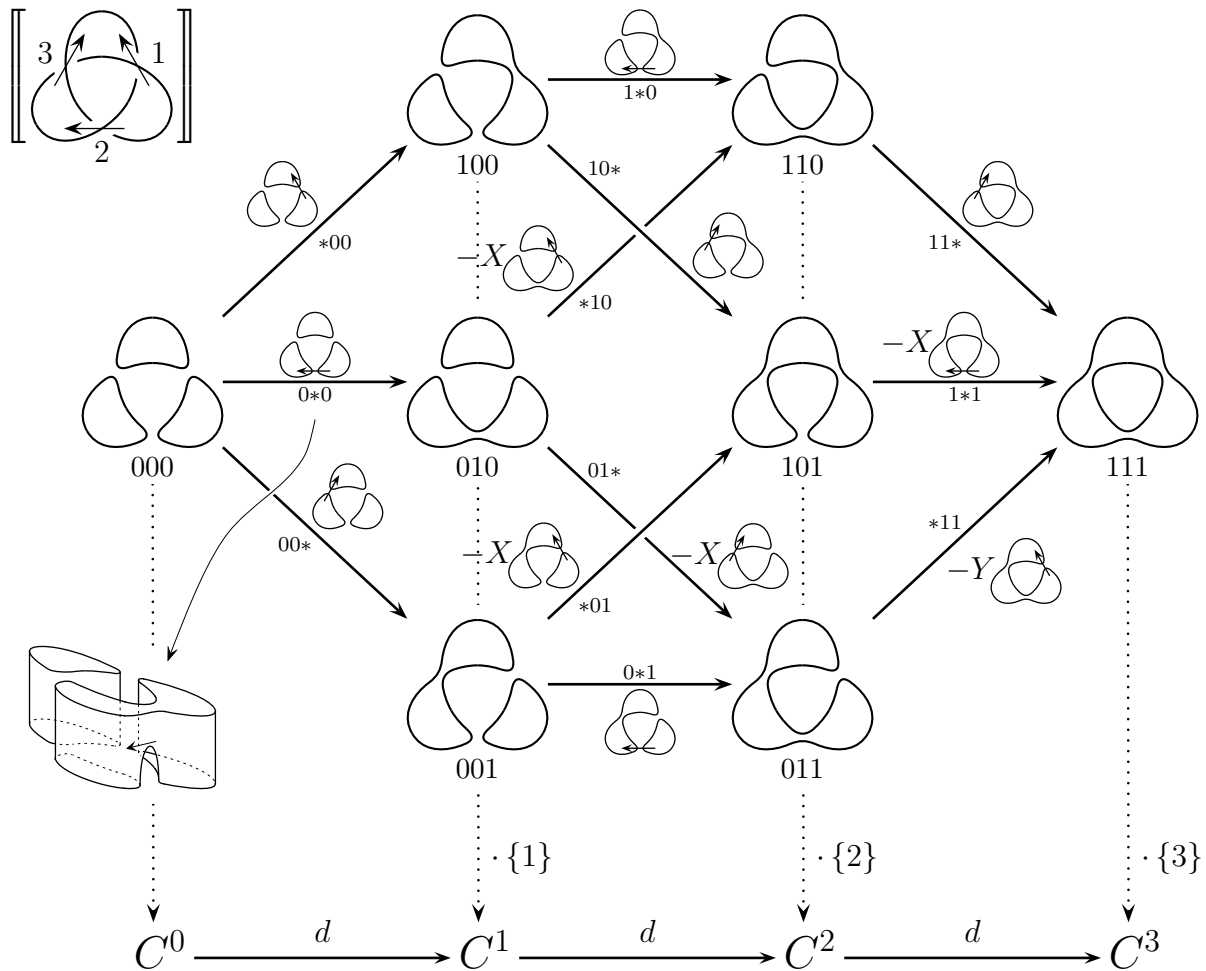



FIGURE 1. The Khovanov bracket for the trefoil.

an arrow). These arrows do not appear in the construction of the even Khovanov complex [Kh99, BN05], but it is crucial for the odd Khovanov complex [ORS13].

Vertices in the cube. Most of the picture is occupied by resolutions of the diagram D , placed in vertices of a unit three-dimensional cube. A vertex ξ of the cube is encoded by a sequence (ξ_1, ξ_2, ξ_3) with each $\xi_i = 0$ or 1 , and it is decorated with a diagram D_ξ obtained from D by replacing i -th crossing with the resolution of type ξ_i . The cube is drawn slant, to have all diagrams grouped in columns with respect to the weight of the vertex $\|\xi\| := \xi_1 + \xi_2 + \xi_3$.

Edges in the cube. Edges are encoded by sequences $\zeta = (\zeta_1, \zeta_2, \zeta_3)$ with exactly one ζ_i being a star $*$. The star indicates direction of the edge: replacing it with 0 or 1 results in the source or the target vertex respectively. Choose an edge $\zeta: \xi \rightarrow \xi'$ and let U be a small neighborhood of the i -th crossing, where $\zeta_i = *$. It is decorated with a unique cobordism $D_\zeta \subset \mathbb{R}^2 \times I$ that has only one critical point: a cylinder $(D - U) \times I$ with a saddle  inserted over U . We equip this cobordism with a height function $h: D_\zeta \rightarrow I$. The small arrow over the crossing determines the *framing*, hence the *orientation* of the saddle (see Appendix A). For simplicity we represent the cobordism by its input together with an arrow, which determines both the place and the orientation of the saddle. This is the same arrow that decorates the i -th crossing in the diagram of the knot. A 3D picture of the cobordism decorating the edge $0*0$ is given in the left-bottom corner.

An underlying diagram with holes. The two paragraphs above can be unified by a single construction, which also explains how to create the cube for any link diagram D . Take the diagram D and remove a small neighborhood of *each* crossing, obtaining a new diagram D_\bullet .¹ For instance, the trefoil diagram produces a diagram with three holes. Copy the numbers associated to crossings to the holes—this gives an ordering of them. The picture D_ξ at a vertex ξ is obtained from D_\bullet by filling the holes with resolutions, type ξ_i at the i -th hole. To obtain the cobordism D_ζ associated to an edge ζ , where $\zeta_i = *$, copy the arrow from i -th crossing to the i -th hole. For a 3D picture, take a product $D_\bullet \times I$ and insert into the i -th hole² either a pair of vertical rectangles, when $\zeta_i \neq *$, or a saddle for $\zeta_i = *$ with a framing induced by the small arrow over the crossing, see Fig. 2.

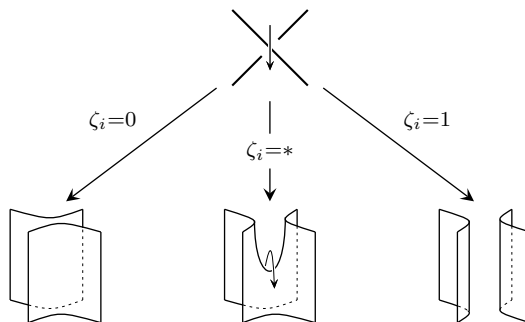
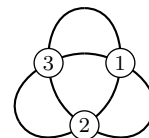

FIGURE 2. 3D resolutions of a crossing decorated by an arrow.

¹ This is an example of a planar arc diagram, see Section 6.

² Notice that holes in $D_\bullet \times I$ are three-dimensional.

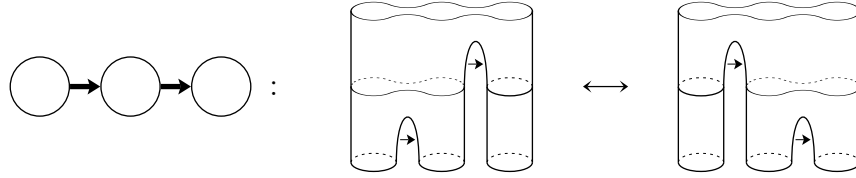

FIGURE 3. A two-arrow surgery diagram encodes a permutation of two saddle points.

Faces. Consider a two-dimensional face S of the cube of resolutions of a diagram D with n crossings. It is encoded by a sequence $\nu = (\nu_1, \dots, \nu_n)$ having 0 or 1 at all except two positions, i_0 and i_1 , where we put stars. Denote the vertices of S by S_{ab} , where a, b are the replacements for the two stars. We label S with the resolution of D decorating the vertex S_{00} with two arrows placed over smoothings of the i_0 -th and i_1 -th crossing. This is a surgery diagram of a cobordism with two saddles, and there are two height functions depending on which of the two saddle points is below the other. Instead of picking any of them, we interpret the diagram as a linear homotopy between the two height functions, see Fig. 3 for an example.

Commutativity cochain. Take the two-arrow description of a face and disregard all circles that are not touched by any of the two arrows. What remains is one of the pictures listed in Tab. 1. We gathered all such configurations into groups labeled with some monomials from a commutative ring $\mathbb{k} := \mathbb{Z}[X, Y, Z^{\pm 1}]/(X^2=Y^2=1)$ (they are explained in Section 4). They define a 2-cochain $\psi \in C^2(I^n; \mathbb{k}^*)$, where \mathbb{k}^* is the group of invertible elements in \mathbb{k} . Here one must be careful with the two configurations placed in Tab. 1 below the letter Z —the value of ψ is either Z or Z^{-1} , depending on the orientation of the face:

$$(1) \quad \psi \left(\begin{array}{ccc} & \bullet & \\ \text{merge} \nearrow & & \text{split} \searrow \\ \bullet & \text{ } & \bullet \\ \text{split} \searrow & \text{ } & \text{merge} \nearrow \\ & \bullet & \end{array} \right) = Z, \quad \text{but} \quad \psi \left(\begin{array}{ccc} & \bullet & \\ \text{split} \nearrow & & \text{merge} \searrow \\ \bullet & \text{ } & \bullet \\ \text{merge} \searrow & \text{ } & \text{split} \nearrow \\ & \bullet & \end{array} \right) = Z^{-1}.$$

We call ψ the *commutativity 2-cochain*.

Coefficients on edges. Edges in Fig. 1 are labeled with elements of \mathbb{k} , describing a 1-cochain $\epsilon \in C^1(I^3; \mathbb{k}^*)$ (take 1 if no coefficient is present). The product of these elements around each face S is equal to $-\psi(S)$, i.e. $\psi = -d\epsilon$. Such a cochain ϵ is called a *sign assignment*, following [ORS13]. It exists for any link diagram and, in some sense, it is unique (see Section 5).

Complex. The bottom line in Fig. 1 shows a sequence of objects and maps between them. This is the *Khovanov bracket* of the trefoil: think of the objects C^i as columns of the diagrams above and the maps d^i as bundles of arrows between the columns. We give more meaning to this in Section 5, showing that (C, d) is a chain complex.

A word about tangles. In the same manner we can create a cube of resolutions for a tangle diagram, using cobordisms with corners. However, it has to be explained what we mean by a 2-cochain ψ in this case, as faces are more complicated. This is done in Section 6.

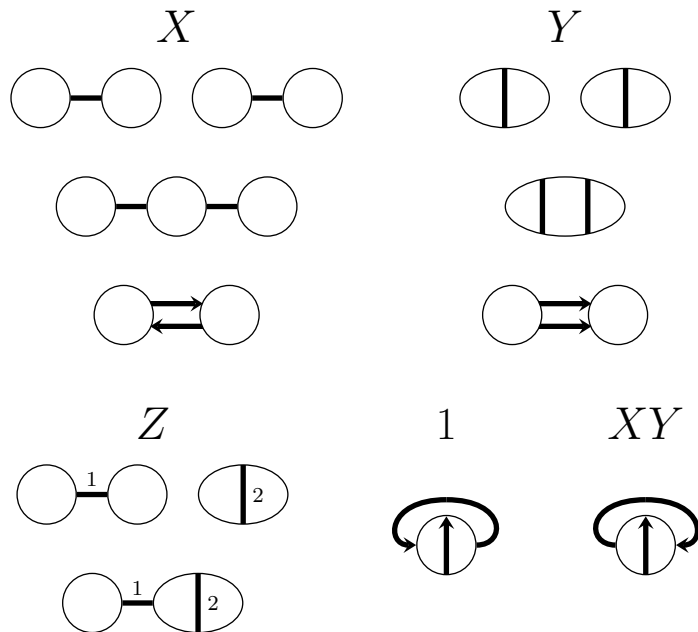

TABLE 1. Diagrams for faces that can appear in a cube of resolutions, grouped by values of the commutativity cochain ψ . All coefficients live in the commutative ring $\mathbb{k} := \mathbb{Z}[X, Y, Z^{\pm 1}]/(X^2=Y^2=1)$. Thin lines are the input circles and thick arrows visualize saddle points. Orientations of the arrows are omitted if ψ does not depend on them. The small numbers 1 and 2 in the two configurations placed under the letter Z indicate an initial order of critical points, see (1). For the opposite order take Z^{-1} .

3. COBORDISMS AND CHRONOLOGIES

We start creating the framework for Fig. 1 by describing a 2-category³ of chronological cobordisms.

An $(n + 1)$ -manifold W is a *cobordism* between two oriented n -manifolds Σ_0 and Σ_1 if its boundary is diffeomorphic to $\Sigma_0 \sqcup -\Sigma_1$ (the minus sign stands for the opposite orientation of Σ_1). We will often write W_{in} and W_{out} for the components of ∂W identified with Σ_0 and $-\Sigma_1$ respectively, and call them the *input* and the *output* of W .

Given cobordisms W from Σ_0 to Σ_1 and W' from Σ_1 to Σ_2 one can glue them together along the orientation reversing diffeomorphism $W_{out} \approx \Sigma_1 \approx W'_{in}$ to obtain a cobordism $W'W$. Unfortunately, this operation is defined only up to a diffeomorphism, the issue we can address by considering cobordisms with *collars*. Namely, think of an n -manifold Σ as an open cylinders $\Sigma \times (-\varepsilon, \varepsilon)$ for a fixed small $\varepsilon > 0$, and a cobordism from Σ_0 to Σ_1 as a manifold W with a pair of embeddings $\Sigma_0 \times [0, \varepsilon] \rightarrow W \leftarrow \Sigma_1 \times (-\varepsilon, 0]$. If W' is another cobordism from Σ_1 to Σ_2 , then the gluing $W'W := W' \cup (\Sigma_1 \times (-\varepsilon, \varepsilon)) \cup W$ has a well-defined smooth structure.

Definition 3.1. Let W be a cobordism and $\tau: W \rightarrow I$ an oriented Morse function separating critical points. The pair (W, τ) is called a *chronological cobordism* if $\tau^{-1}([0, \varepsilon])$ and $\tau^{-1}((1 - \varepsilon, 1])$ are the collars of W_{in} and W_{out} respectively, on which τ is the projection on

³ A brief introduction to the theory of 2-categories is included in Appendix B.

the second factor. A homotopy of τ in the space of oriented Igusa functions is called a *change of a chronology*.

We now explain some notions from the definition, referring for details to Appendix A. An Igusa function $f: W \rightarrow I$ is allowed to have two types of critical points:

- A_1 or *Morse singularities*, characterized by the property that the Hessian $Hess_p(f)$ of f is nondegenerate, and
- A_2 or *birth-death singularities*, for which the Hessian has a one dimensional kernel $N(p)$, on which the third derivative of f does not vanish.

Choose a Riemannian metric on W . For a critical point p we denote by $E^\pm(p)$ the positive or negative eigenspace of the Hessian $Hess_p(f): T_p W \rightarrow T_p W$. A choice of orientations for negative eigenspaces over all critical points is called an *orientation* of f . We denote the space of oriented Igusa functions on W by $\text{Fun}^{\text{or}}(W)$.

A generic function $f: W \rightarrow I$ has only Morse singularities, but we need birth-death singularities for generic homotopies. Higher singularities are unnecessary for higher homotopies if we equip these functions with *framing*, i.e. a choice of a basis for each $E^-(p)$, see Theorem A.3. The space of oriented functions can be seen as a quotient of this space, as explained at the end of Appendix A. This space may no longer be contractible, but it is simply connected.

We are interested only in the order of critical points of the function τ , so that we identify chronologies that differ by a change preserving the order.

Definition 3.2. Chronological cobordisms (W, τ) and (W, τ') are *equivalent* if there exists a path γ in $\text{Fun}^{\text{or}}(W)$ from τ to τ' such that each $\gamma_t: W \rightarrow I$ is a Morse function that separates critical points.⁴ In such case we write $(W, \tau) \sim (W, \tau')$ or $\tau \sim \tau'$.

Given cobordisms (W, τ) from Σ_0 to Σ_1 and (W, τ') from Σ_1 to Σ_2 we define a chronology τ'' on the gluing $W'W$ by concatenation:

$$(2) \quad \tau''(p) := \begin{cases} \frac{1}{2}\tau(p), & \text{for } p \in W, \\ \frac{1}{2}(\tau'(p) + 1), & \text{for } p \in W'. \end{cases}$$

The assumed behavior of a chronology on collars of a cobordism guarantees τ'' is smooth. Hence, we have an associative and unital operation on equivalence classes of cobordisms, where units are given by cylinders $\Sigma \times I$ with the simplest chronology—the projection on I .

Recall that given two paths $\gamma, \gamma': I \rightarrow X$ in a topological space X such that $\gamma(1) = \gamma'(0)$ we define their concatenation $\gamma' \star \gamma$ by the formula

$$(3) \quad (\gamma' \star \gamma)(t) := \begin{cases} \gamma(2t), & 0 \leq t \leq 1/2, \\ \gamma'(2t - 1), & 1/2 \leq t \leq 1. \end{cases}$$

Definition 3.3. Let $H, H': W \times I \rightarrow I$ be changes of chronologies such that (W, H_0) and (W, H'_0) are equivalent chronological cobordisms, i.e. there is a path γ in $\text{Fun}^{\text{or}}(W)$ between H_0 and H'_0 . We say H and H' are *equivalent* if there is a path γ' from H_1 to H'_1 such that the paths $\gamma'_t \star H_t$ and $H'_t \star \gamma_t$ are homotopic in $\text{Fun}^{\text{or}}(W)$, see the square to the right. In such case we write $H \sim H'$.

$$\begin{array}{ccc} (W, H_0) & \xrightarrow{H} & (W, H_1) \\ \gamma \downarrow & \swarrow \text{htpy} & \downarrow \gamma' \\ (W, H'_0) & \xrightarrow{H'} & (W, H'_1) \end{array}$$

⁴ We are allowed to deform not only the function τ , but also the chosen Riemannian structure on W . As shown in [Ig87] all Riemannian structures can be related by such deformations.

Remark 3.4. The connectivity of $\text{Fun}^{\text{or}}(W)$ implies the homotopy in the definition above always exists. Hence, any two changes $H, H': W \times I \rightarrow I$, for which $H_0 \sim H'_0$ and $H_1 \sim H'_1$, are equivalent.

We can *juxtapose* changes occurring on different regions of a cobordism. Formally, if H and H' are changes of chronologies on W and W' respectively, and cobordisms W and W' can be glued together, there is a change of a chronology on $W'W$ induced by the map

$$(4) \quad (H' \circ H)(p, t) := \begin{cases} H(p, t), & p \in W, \\ H'(p, t), & p \in W', \end{cases}$$

which may need to be smoothed. This operation is clearly associative and unital.

Concatenation of changes of chronologies is a bit cumbersome: we cannot combine homotopies $H, H': W \times I \rightarrow I$ if (W, H_1) and (W, H'_0) are only equivalent, as H_1 may not agree with H'_0 . Instead, we define

$$(5) \quad (H' \star H)(p, t) := \begin{cases} H(p, 3t), & 0 \leq t \leq 1/3, \\ \gamma(p, 2t - 1), & 1/3 \leq t \leq 2/3, \\ H'(p, 3t - 2), & 2/3 \leq t \leq 1, \end{cases}$$

where γ is a path in $\text{Fun}^{\text{or}}(W)$ from H_1 to H'_0 . Hence, $H' \star H$ is given as the following sequence of homotopies:

$$(6) \quad (W, H_0) \xrightarrow{H} (W, H_1) \xrightarrow{\gamma} (W, H'_0) \xrightarrow{H'} (W, H'_1).$$

This operation is well-defined up to equivalence due to Remark 3.4 (in particular, it does not depend on the path γ), and it is clearly associative and unital up to equivalence.

Lemma 3.5. *Choose pairs of equivalent changes of chronologies $H \sim \tilde{H}$ and $H' \sim \tilde{H}'$ on a cobordism W such that H' and H can be concatenated. Then we can concatenate \tilde{H}' with \tilde{H} , and $H' \star H \sim \tilde{H}' \star \tilde{H}$.*

Proof. The asserted equivalences guarantee $(W, H_i) \sim (W, \tilde{H}_i)$ and $(W, H'_i) \sim (W, \tilde{H}'_i)$ for $i = 0, 1$, and since H' can be concatenated with H , (W, H_1) and (W, H'_0) are equivalent as well. Hence, we have a sequence of equivalences $(W, \tilde{H}_1) \sim (W, H_1) \sim (W, H'_0) \sim (W, \tilde{H}'_0)$, which shows \tilde{H}' and \tilde{H} can be composed together. The thesis follows, since the rectangle below

$$(7) \quad \begin{array}{ccccccc} (W, H_0) & \xrightarrow{H_t} & (W, H_1) & \xrightarrow{\omega_t} & (W, H'_0) & \xrightarrow{H'_t} & (W, H'_1) \\ \Downarrow \gamma_t & & & & & & \Downarrow \gamma'_t \\ (W, \tilde{H}_0) & \xrightarrow{\tilde{H}_t} & (W, \tilde{H}_1) & \xrightarrow{\tilde{\omega}_t} & (W, \tilde{H}'_0) & \xrightarrow{\tilde{H}'_t} & (W, \tilde{H}'_1) \end{array}$$

commutes up to homotopy due to Remark 3.4, where γ , γ' , ω , and $\tilde{\omega}'$ are paths of Morse functions given by corresponding equivalences of chronological cobordisms. \square

All the above almost shows that chronological cobordisms form a 2-category—it remains to check the interchange law (137) holds; this follows immediately as concatenation and juxtaposition commute with each other. We state this as the following proposition.

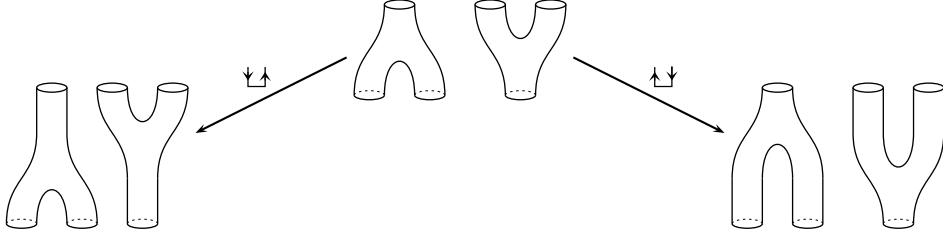

FIGURE 4. A disjoint union in a chronological setting requires a shift.

Proposition 3.6. *There is a strict 2-category of chronological cobordisms $n\mathbf{ChCob}$ with oriented manifolds of dimension $(n-1)$ as objects, equivalence classes of chronological cobordisms as morphisms, and homotopy classes of changes of chronologies as 2-morphisms. The composition of morphisms is induced by gluing, and the two compositions of 2-morphisms are given as juxtaposition (the horizontal one) and concatenation (the vertical one).*

Remark 3.7. For a chronological cobordism W the set of critical points $\mathit{crit}(W)$ is linearly ordered by the chronology: we write $x < y$ if $\tau(x) < \tau(y)$. This order is invariant under equivalence of cobordisms, but it is affected by changes of chronologies.

One of the important operations on cobordisms is the *disjoint union*. For chronological cobordisms it has to be defined carefully: with the naive definition one might get two critical points at the same level, which is prohibited. Instead, we have to shift critical points of the left or the right cobordism below critical points of the other one, obtaining a ‘left-then-right’ and a ‘right-then-left’ disjoint unions denoted respectively by \Downarrow and \Uparrow (see Fig. 4). Formally, we equip $(W, \tau) \Downarrow (W', \tau')$ with the chronology

$$(8) \quad \tau_r(p) := \begin{cases} \beta_{1/2}^1(\tau(p)), & p \in W, \\ \beta_0^{1/2}(\tau'(p)), & p \in W', \end{cases}$$

where $\beta_a^b: I \rightarrow I$ is a perturbed ‘bump function’: an increasing function which is very close to 0 on the interval $[0, a]$ and very close to 1 on $[b, 1]$. The chronology τ_ℓ on $(W, \tau) \Uparrow (W', \tau')$ is defined in a similar way. Finally, the formula (8) can be naturally extended to changes of chronologies—replace p with a pair (p, t) .

This is the first place where we can see that chronological cobordisms indeed require a richer structure than just a category: the disjoint unions defined above are functorial only up to a change of a chronology $\sigma_{W, W'}^\Downarrow: (W \Downarrow W', \tau_r) \Rightarrow (W \Uparrow W', \tau_\ell)$ that pulls W below W' . This can be done by a linear interpolation: $\sigma_{W, W'}^\Downarrow(p, t) := (1-t)\tau_\ell(p) + t\tau_r(p)$.

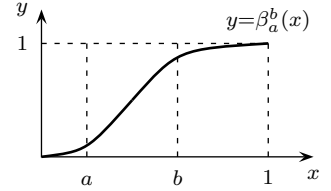

Theorem 3.8. *The 2-category $n\mathbf{ChCob}$ is Gray monoidal. The monoidal product is induced by the ‘right-then-left’ disjoint union \Uparrow and the unit is given by the empty manifold \emptyset .*

Proof. We have to check conditions from Definition B.7. First, \Uparrow is cubical. Indeed, the conditions from Definition B.5 are trivially satisfied, as $\sigma_{W, W'}^\Downarrow: W \Downarrow W' \Rightarrow W \Uparrow W'$ does nothing if either W or W' has no critical points. Next, it is coherent with 2-morphism, i.e. the square (138) commutes. Indeed, given changes of chronologies α on W and β' on W' we

construct a homotopy

$$(9) \quad h_s := \sigma_{W,W'}^{\sqcup}|_{[0,s]} \star ((1-s)\alpha \updownarrow \beta' + s\alpha \updownarrow \beta') \star \sigma_{W,W'}^{\sqcup}|_{[s,1]}$$

where $\sigma_{W,W'}^{\sqcup}|_{[a,b]}$ is a restriction of $\sigma_{W,W'}^{\sqcup}$ to $t \in [a, b]$. The homotopy h_s first shifts W and W' a bit towards their final position, then it applies the changes α and β' on appropriate levels, and after that it shifts W and W' further to their final positions. Finally, commutativity of (139) follows easily: the two changes $\sigma^{\sqcup} \star (\sigma^{\sqcup} \circ \text{id})$ and $\sigma^{\sqcup} \star (\text{id} \circ \sigma^{\sqcup})$ are homotopic by a linear interpolation.

The unitarity condition is clear, which leaves only associativity to check. This follows from the way \updownarrow is defined: the two chronologies on $W \updownarrow (W' \updownarrow W'')$ and $(W \updownarrow W') \updownarrow W''$ are homotopic by a reparametrization of the target interval I . \square

The ordinary category of cobordisms is not only monoidal, but it possesses a symmetry induced by a family of permutation diffeomorphisms $c: \Sigma_1 \sqcup \Sigma_0 \xrightarrow{\cong} \Sigma_0 \sqcup \Sigma_1$. Namely, take the cylinder $(\Sigma_0 \sqcup \Sigma_1) \times I$ with the standard inclusion as its input and the diffeomorphism c as its output (see the picture to the side). In case of chronological cobordisms, these permutation cylinders form natural transformations between unary functors $C \updownarrow (-)$ and $(-) \updownarrow C$, where C stands for any cylinder. This suggests the permutation cylinders equip $n\mathbf{ChCob}$ with a strict symmetry, see Definition B.9. Indeed, commutativity of the triangle (140) follows easily from this construction.

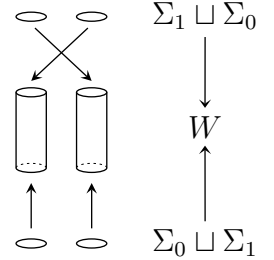

Corollary 3.9. *The Gray monoidal category $(n\mathbf{ChCob}, \updownarrow, \emptyset)$ has a strict symmetry induced by permutation diffeomorphisms $c: \Sigma_1 \sqcup \Sigma_0 \xrightarrow{\cong} \Sigma_0 \sqcup \Sigma_1$.*

There is another operation on chronological cobordisms similar to the disjoint unions—the connected sum. Given chronological cobordisms W and W' remove vertical cylinders from them (a cylinder C in (W, τ) is *vertical* if the restriction $\tau|_C$ is a regular function) and construct $W \# W'$ by identifying the cobordisms along the newly created boundary. Likewise for the disjoint unions, there are two connected sums of chronological cobordisms W and W' , the ‘left-then-right’ $W \#_l W'$ and the ‘right-then-left’ one $W \#_r W'$, related by a change of a chronology $\sigma_{W,W'}^{\#}: W \#_l W' \implies W \#_r W'$ that permutes the critical points.

Let $n\mathbf{ChCob}_\circ$ be the category of nonempty manifolds with two distinguished points, and cobordisms between them, decorated with two vertical lines connecting the basepoints of the boundary manifolds. Then the connected sums are well-defined (choose small neighborhoods of the distinguished lines), and we have the following analog of Theorem 3.8.

Corollary 3.10. *The 2-category $n\mathbf{ChCob}_\circ$ is Gray monoidal. The product is induced by the ‘right-then-left’ connected sum $\#_r$ and the unit is given by the $(n - 1)$ -dimensional ball.*

We end this section with a combinatorial description of $2\mathbf{ChCob}$.

Proposition 3.11. *$2\mathbf{ChCob}$ is a symmetric Gray monoidal category with objects freely generated by a circle S^1 and morphisms freely generated by the following five cobordisms:*

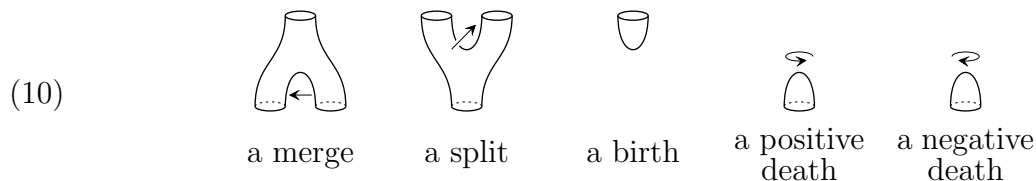

with a twist  acting as a strict symmetry.

One should read the pictures above from bottom to top: the bottom circles form the input of a cobordism, the top ones form the output and the height function determines a chronology. Orientations of critical points are visualized by arrows.

Proof. Every 1-dimensional manifold is a family of circles, so that objects of $2\mathbf{ChCob}$ are freely generated under the disjoint union by a single circle S^1 . Since all orientation preserving diffeomorphisms of S^1 are isotopic to the identity, chronological cobordisms with no critical points are generated by a permutation of two circles, the symmetry of the monoidal structure. Morse theory provides a description of cobordisms with a single critical point. Since the order of critical points is fixed, it remains to analyze orientations of the critical points.

We need only one merge and one split—an orientation of the saddle point can be reversed by attaching a twist. The tangent space to a point of index 0 (a birth) is stable, so that there is only one choice for orientation (the empty frame), but it is unstable at points of index 2 (deaths). Hence, a choice of an orientation of a death is equivalent to an orientation of the tangent space, which can be either coherent with the orientation of the cobordism or not. \square

We shall use Cerf theory (see Section A) to describe 2-morphisms in terms of generators and relations. Most of them are easy to draw directly, but for some it will be useful to use other presentations: *movies* and *surgery diagrams*.

A *movie presentation* of a chronological cobordism is a sequence of its regular levels, dense enough to capture all topological changes: such a sequence contains at least one regular level between any two critical ones. Two consecutive diagrams in the sequence differ in one of the following ways:

- they are isotopic, so that there is no critical level in between,
- one diagram is obtained from the other by a saddle move $\asymp \longrightarrow \succ \langle$; this corresponds to a merge or a split,
- a one circle component appear (for a birth) or disappear (for a death).

We can add additional information to encode orientations of the critical points: an oriented chord for a saddle move, or a/c for a death oriented anti- or clockwise. We provide below one example.

$$(11) \quad \begin{array}{c} \text{Cylinder with a saddle point} \\ \text{and a twist} \end{array} = \begin{array}{|c|c|c|c|} \hline \text{Circle} & \text{Saddle move with arrow} & \text{Circle with } a & \text{Circle} \\ \hline \end{array}$$

Movie presentations are a good way to visualize cobordisms. However, if a cobordism (W, τ) has only saddle points, a more compact description is given by its *surgery diagram*: a collection of circles with enumerated oriented chords between them. The circles illustrate the input of the cobordism W , whereas the chords represent 1-handles in the handle decomposition of W with respect to the chronology τ . Performing surgeries along the chords in the specified order results in a movie presentation of W . However, we can get more: a diagram with two chords encodes two chronological cobordisms, depending on the order of the chords, and a change that permutes the two points, see Fig. 3 on page 6.

Proposition 3.12. *Changes of chronologies are generated under composition and disjoint union by the following:*

(1) *creation and annihilation changes*

(12)

in which the orientations of deaths are determined by the monotonicity condition for $d^3\tau$ at an A_2 singularity (take the arrow at the saddle and rotate it towards the vertical cylinder),

(2) *the disjoint sum permutations*

(13)

(3) *the connected sum permutations*

(14)

(4) *the exceptional permutation changes, represented by the following movies*

(15)

to which we refer respectively as a \times -change and a \diamond -change, because of the shapes of cobordisms involved.

Proof. According to Cerf theory there are two types of changes:

- those generated by A_2 -singularities, i.e. creation and annihilation changes, and
- those induced by homotopies H_t , such that H_{t_0} has two critical points at one level for some t_0 .

In the latter case, we refer to the critical level of H_{t_0} as the *singular section* of H_t . Its components carrying the critical points is a four-valent graph Γ_H . Consider the connectivity of the graph:⁵ the homotopy H represents a disjoint union permutation if Γ_H has two components, a connected sum permutation if Γ_H is 2-connected, or one of the exceptional changes if Γ_H is 4-connected. \square

Remark 3.13. The surgery diagram of an \times -change consists of two circles connected by two arrows. However, the arrows can either point to the same or to different circles, and the two cases lead to surgery diagrams encoding non-equivalent changes. Hence, there are two versions of the \times -change.

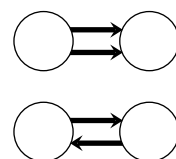

⁵ A graph Γ is n -connected if at least n edges must be removed to split it into two components.

On the other hand, reversing one chord in a surgery diagram of a \diamond -change results in the inverse change. Indeed, the only topological information we have is the order of chords induced by the arc connecting their heads (there is a natural orientation of the circle in the surgery diagram induced from the orientation of the underlying cobordism). This order may or may not coincide with the order of critical points, induced by the initial chronology, and the two cases lead to mutually inverse permutation changes.

We shall now proceed to a description of *relations* between the generators of the set of 2-morphisms. These are given by homotopies of paths in the space of Igusa functions listed in Section A. As before, not all of them can be easily drawn, especially the homotopies relating the two ways of switching levels of three critical points. We shall encode them with three-chord surgery diagrams—such a diagram represent six cobordisms, depending on the order of critical points, call them a, b, c , and six permutation changes between these cobordisms forming a hexagonal diagram

$$(16) \quad \begin{array}{ccccc} & & W(b < a < c) & \Longrightarrow & W(b < c < a) & & \\ & \nearrow & & & & \searrow & \\ W(a < b < c) & & & & & & W(c < b < a) \\ & \searrow & & & & \nearrow & \\ & & W(a < c < b) & \Longrightarrow & W(c < a < b) & & \end{array}$$

The notation $W(x < y < z)$ is used for the cobordism with the point x at the lowest critical level, y in the middle, and z at the highest one. The relation imposed by the homotopy makes this hexagon commute.

Proposition 3.14. *The following is the complete set of relations among the generating changes of chronologies listed in Proposition 3.12:*

(1) *the squares below commute for any cobordisms W, W', W'' , and a 2-morphism α :*

$$(17) \quad \begin{array}{ccc} W \Downarrow W' \xrightarrow{\text{id} \sqcup \alpha} W \Downarrow W'' & & W \# W' \xrightarrow{\text{id} \# \alpha} W \# W'' \\ \sigma_{W,W'}^{\sqcup} \Downarrow & & \sigma_{W,W'}^{\#} \Downarrow \\ W \Downarrow W' \xrightarrow{\text{id} \sqcup \alpha} W \Downarrow W'' & & W \# W' \xrightarrow{\text{id} \# \alpha} W \# W'' \\ & & \sigma_{W,W''}^{\#} \Downarrow \end{array}$$

(2) *hexagons encoded by the following surgery diagrams commute:*

$$(18) \quad \begin{array}{cccc} \begin{array}{c} \circ \\ \diagup \quad \diagdown \\ \circ \quad \circ \end{array} & \begin{array}{c} \text{---} \circ \\ \text{---} \circ \end{array} & \begin{array}{c} \text{---} \circ \\ \text{---} \circ \end{array} & \begin{array}{c} \text{---} \circ \\ \text{---} \circ \end{array} \end{array}$$

$$(19) \quad \begin{array}{cc} \begin{array}{c} \text{---} \circ \\ \text{---} \circ \end{array} & \begin{array}{c} \text{---} \circ \\ \text{---} \circ \end{array} \end{array}$$

where the crossings in the last two diagrams are the artifacts of projecting the diagrams to the plane (singular levels of the corresponding homotopies are not planar).

Proof. We shall analyze the three groups of homotopies from Section A on page 51.

Group I: two changes occur simultaneously at different levels (126). This is the exchange law for 2-morphisms, so that this group does not introduce new relations.

Group II: nontransverse changes (127). These imply a change followed by its inverse is equivalent to the trivial one. Again, no interesting relations.

Group III: several critical points at the same level (128). This group introduces interesting relations between generating 2-morphisms. A homotopy $H_{s,t}$ from this group admits a *singular level*: the critical level of some H_{s_0,t_0} containing all the critical points (either three Morse singularities, or one Morse and one birth-death point). Denote by Γ_H the components of the singular level carrying the critical points; it is a graph with two types of vertices: 4-valent ones for Morse singularities, and 2-valent to birth-death singularities.

If the graph Γ_H is disconnected, it must have a component with a single 4-valent vertex. In such a case the relation imposed by H is commutativity of the left square in (17), where the cobordism W contains the component of Γ_H with a single 4-vertex, and α is a change encoded by the other components (a creation or annihilation if the component contains one 2-valent vertex, or a permutation otherwise).

If Γ_H is 2-connected, break its two edges to obtain two components. The reverse operation is the connected sum—this shows a homotopy with such a graph impose commutativity of the right square in (17).

Finally, Γ_H can be 4-connected, which requires three 4-valent vertices. There is only one such graph, shown to the right. Take a look on a regular level of H_{s_0,t_0} just below the singular one—it is a collection of circles obtained from Γ_H by replacing a neighborhood of each vertex with two arcs (not necessarily in a planar way). Join the arcs with a chord to obtain a three-chord surgery diagram for H . All such diagrams are listed in lines (18) and (19). \square

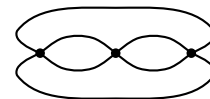

Example 3.15. The following sequence of homotopies

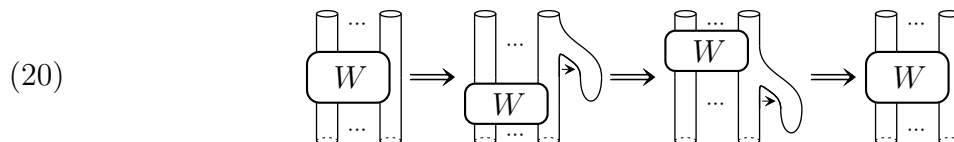

represents a trivial change for any cobordism W , not necessarily connected. Indeed, go around the right square in (17), where α is a creation change. Likewise a similar change involving a split and a death is trivial.

4. EMBEDDED COBORDISMS AND LINEARIZATION

In the view of the construction of odd Khovanov homology it is unfortunate to have only one \diamond -change up to inverse, see Tab. 1. One solution to this issue is to use cobordisms embedded in $\mathbb{D}^2 \times I$, in which case we can easily define chronological cobordisms with corners—they are necessary to construct the generalized Khovanov bracket for tangles. These cobordisms have a natural Riemannian structure induced from the ambient space.

Definition 4.1. Given a natural number k define the 2-category $\mathbf{ChCob}^e(k)$ as follows.

- (1) Objects are families of disjoint circles and k intervals properly embedded in a two-dimensional disk \mathbb{D}^2 .
- (2) A morphism is a properly embedded surface $W \subset \mathbb{D}^2 \times I$, such that the restriction $pr|_W$ of the projection $pr: \mathbb{D}^2 \times I \rightarrow I$ to W is a separative Morse function. We call it a *chronology* on W and, as before, we orient critical points of $pr|_W$. Moreover, we assume that ∂W consists of three parts: the input $W \cap (\mathbb{D}^2 \times \{0\})$ of W , the output $W \cap (\mathbb{D}^2 \times \{1\})$, and $2k$ vertical lines $W \cap (\partial\mathbb{D}^2 \times I)$.

- (3) Finally, a 2-morphism is an *admissible* diffeotopy $\varphi: (\mathbb{D}^2 \times I) \times I \longrightarrow \mathbb{D}^2 \times I$, i.e. the one that fixes boundary points and at every moment $t \in I$ the restriction $pr|_{\varphi_t(W)}$ is an Igusa function.

We call $\mathbf{ChCob}^e(k)$ the 2-category of *embedded chronological cobordisms*.

Remark 4.2. We shall refer to orientations of deaths as *clockwise* or *anticlockwise* by comparing them with the standard orientation of $\mathbb{D}^2 \times \{t\} \subset \mathbb{D}^2 \times I$.

We shall identify cobordisms related by diffeotopies φ_t for which $pr|_{\varphi_t(W)}$ is separative Morse at every moment $t \in I$. In particular, this holds for the following deformations:

- *level-preserving* diffeotopies: $pr \circ \varphi_t = pr$ for every $t \in I$,
- *vertical* diffeotopies: $\varphi_t(p, z) = (p, h_t(z))$ for some diffeotopy h_t of the interval I .

Another important family consists of locally vertical diffeotopies—they are vertical only over a collection of disks, while constant beyond them.

Definition 4.3. Choose a family of disjoint vertical cylinders C_1, \dots, C_r in $\mathbb{D}^2 \times I$ and an embedded chronological cobordism W that is vertical in the annular neighborhood of each ∂C_i . A diffeotopy φ_t is *locally vertical* if it is vertical on all C_i 's, but fixes all points outside them except small annular neighborhoods of ∂C_i 's, in which we interpolate the two behaviors.

The requirement that W intersects each ∂C_i in vertical lines implies that φ_t cannot create critical points. Hence, each interpolation $(1-s)\varphi_1 + s \text{id}$ induces a chronology on W , so that locally vertical diffeotopies can be ‘straightened up’ (compare this with Theorem A.3).

Proposition 4.4. *Let φ_t and φ'_t be diffeotopies locally vertical with respect to the same family of cylinders. If $\varphi_1 = \varphi'_1$, then they are homotopic in the space of admissible diffeotopies. In particular, a locally vertical diffeotopy φ_t satisfying $\varphi_1 = \text{id}$ is trivial.*

Proof. Take a linear homotopy $h_{t,s} := s\varphi_t + (1-s)\varphi'_t$. Because both φ_t and φ'_t are locally vertical, each $h_{t,s}$ is a diffeomorphism of $\mathbb{D}^2 \times I$ such that $pr|_{h_{t,s}(W)}$ is a Morse function. \square

The proposition above makes it possible to define disjoint unions in $\mathbf{ChCob}^e(0)$ (more general operations on all categories $\mathbf{ChCob}^e(k)$ are defined in Section 6). Given embedded cobordisms W and W' with no corners we define the ‘left-then-right’ and ‘right-then-left’ *disjoint unions* $W \updownarrow W'$ and $W \updownarrow W'$ by placing the cobordisms next to each other and pushing the critical points of W below or above those of W' respectively. The disjoint union permutation $\sigma_{W,W'}^{\downarrow \uparrow}: W \updownarrow W' \Longrightarrow W \updownarrow W'$ is realized as a locally vertical diffeotopy, so that it equips \updownarrow with a structure of a cubical functor.

Corollary 4.5. $\mathbf{ChCob}^e(0)$ is a Gray monoidal category, with a monoidal structure given by the ‘right-then-left’ disjoint union \updownarrow

Remark 4.6. This monoidal structure is strictly braided (see Definition B.9) with a braiding induced by twists . We shall not use this fact in our paper.

The connected sum $W \# W'$ of embedded cobordisms with no corners is formed from $W \updownarrow W'$ by performing a surgery along a vertical curtain in $\mathbb{D}^2 \times I$ with one edge on W and the other on W' . Again, there is some choice involved, and to make it a well defined operation one has to decorate objects and morphisms of $\mathbf{ChCob}^e(0)$ with additional data, such as embedded arcs originating at the circles and ending at the boundary of \mathbb{D}^2 .

The 2-category $\mathbf{ChCob}^e(0)$ is a finer version of abstract cobordisms. For instance, there are two kinds of merges, depending on whether the input circles are nested or not, and likewise for splits. We shall usually ignore this additional structure except one case: we split \diamond -changes into two groups using the intersection number of the two arrows in their surgery description (the two-arrow diagrams). In other words, rotate the diagram to make the inner arrow points upwards, and check the direction of the outer one—it points either to the left or to the right (as shown in the diagrams to the right), and the two changes encoded by the diagrams are not equivalent.

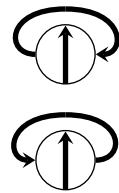

Linearization of cobordisms. The 2-category $\mathbf{ChCob}^e(0)$ is not good for homological constructions and we shall ‘linearize’ it. More precisely, choose a commutative ring R with a function $\iota: 2\text{Mor}(\mathbf{ChCob}^e(0)) \rightarrow R$ that is multiplicative with respect to both compositions of 2-morphisms, and define a category $R\mathbf{ChCob}_\iota^e(0)$ as follows:

- (1) the set of objects is not changed and it consists of families of circles in the plane \mathbb{D}^2 , and
- (2) morphisms are finite linear combinations of chronological cobordisms $r_1W_1 + \dots + r_kW_k$, with $r_i \in R$, modulo *chronological relations* $W' = \iota(\varphi)W$, one per every 2-morphism $\varphi: W \Rightarrow W'$.

We extend the composition of cobordisms to formal sums in a linear way. The function ι can be considered as a part of a 2-functor $\mathbf{ChCob}^e(0) \rightarrow R\mathbf{ChCob}_\iota^e(0)$, where 2-morphisms in the target category are scalings by elements of the ring R . We want this functor to be ‘faithful enough’ to support the construction of odd Khovanov homology. We start with a few observations.

Lemma 4.7. *For any function ι as above there is another one, $\hat{\iota}$, which assigns 1 to creations and annihilations, such that the linearizations $R\mathbf{ChCob}_\iota^e(0)$ and $R\mathbf{ChCob}_{\hat{\iota}}^e(0)$ are isomorphic.*

Proof. Each of the three creations (12) involve different generators. Hence, we can force the coefficients associated to them to be 1 by scaling births and deaths accordingly. \square

Lemma 4.8. *We have $\iota(\sigma_{W,W'}^\sqcup) = \iota(\sigma_{W,W'}^\#)$ whenever each of W and W' is a merge or a split.*

Proof. It follows from the right square in (17) for the cobordism W and the connected sum permutation $\alpha := \sigma^\#: M \# W' \Rightarrow M \# W$, where M is a merge. Indeed, commutativity of the square implies

$$(21) \quad \iota(\sigma_{W,M}^\#)\iota(\sigma_{W,W'}^\sqcup)\iota(\sigma_{M,W'}^\#) = \iota(\sigma_{M,W'}^\#)\iota(\sigma_{W,W'}^\#)\iota(\sigma_{W,M}^\#)$$

so that the middle terms must be equal. \square

As a result, we have to specify ι only for disconnected union permutations and exceptional changes. Instead of finding the most general formula, and keeping in mind we want to regard embedded cobordisms as close to the abstract ones as possible, we shall define $\iota(\sigma_{W,W'}^\sqcup)$ using the following *bidegree* $\text{chdeg } W \in \mathbb{Z} \times \mathbb{Z}$, which counts critical points of the cobordism W as follows:

$$(22) \quad \text{chdeg } W := (\#\text{births} - \#\text{merges}, \#\text{deaths} - \#\text{splits}).$$

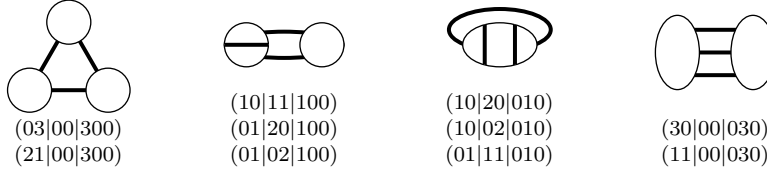

TABLE 2. Surgery diagrams of homotopies relating permutation changes. The numbers below each diagram count how many times various permutations occur: \times -changes with parallel or opposite arrows (the first group), \diamond -changes with outer arrows oriented to the left or to the right (the second group) and the other changes grouped by the value of ι (respectively X , Y and Z). Different sequences correspond to different orientations of chords.

The following result shows a connection between this bidegree with other topological properties of a cobordism.

Lemma 4.9. *Given a chronological cobordism W of degree $\text{chdeg } W = (a, b)$ with n inputs and m outputs, $a + b = \chi(W)$ and $a + n = b + m$.*

Proof. Straightforward, by checking for generating cobordisms (10). □

It follows the bidegree is preserved by changes of chronologies, so that $R\mathbf{ChCob}^e(0)$ is a graded category (morphisms between two objects form an R -module graded by $\mathbb{Z} \times \mathbb{Z}$, and the degree function is additive with respect to composition). The following is determined by the requirement that $\iota(\sigma_{W, W'}^{\sqcup})$ depends only on the degrees of W and W' .

Proposition 4.10. *Choose invertible elements $X, Y, Z \in R$ such that $X^2 = Y^2 = 1$ and define ι on generating changes of chronologies by the following rules:*

- (1) *creations and annihilations are sent to 1,*
- (2) *the coefficient associated to a disjoint union and connected sum permutation involving cobordisms of degrees (a, b) and (c, d) is given by $\lambda(a, b, c, d) = X^{ac}Y^{bd}Z^{ad-bc}$,*
- (3) *a \times -change is sent to Y if the arrows point to the same circle and to X otherwise, and*
- (4) *a \diamond -change with a diagram in which the inner arrow is oriented upwards is sent to 1 or XY depending on whether the outer arrow is oriented to the left or to the right respectively.*

Then $\iota: 2\text{Mor}(\mathbf{ChCob}^e(0)) \rightarrow R$ is a well-defined multiplicative function.

Proof. First, coherence of ι with the interchange law for 2-morphisms (137) follows from commutativity of R . Next, $\iota(\alpha)\iota(\alpha^{-1}) = 1$ for every elementary change α : this is trivial for creations and annihilations, and follows easily for disjoint union and connected sum permutations from the way λ is defined. If α is an exceptional permutations, $\iota(\alpha^{-1}) = \iota(\alpha)$ is a square root of 1.

The commutativity of squares (17), in particular the triviality of (20), is preserved due to the way λ is defined—it is a group homomorphism in each variable. Finally, it remains to check the relations given by the four planar diagrams in (18). For that see Tab. 2: the numbers below each diagram indicate how many times a particular elementary change occurs when we go around the hexagon (16). The product of values of ι is equal to 1 in each case. □

We shall often use the values of ι for disjoint union and connected sum permutations; they are gathered in the table to the right. For instance, we have

$$X \begin{array}{c} \text{cup} \\ \text{merge} \end{array} = \begin{array}{c} \text{merge} \\ \text{cup} \end{array}, \quad Z \begin{array}{c} \text{split} \\ \text{death} \end{array} = \begin{array}{c} \text{split} \\ \text{death} \end{array}.$$

$W \backslash W'$	birth	merge	split	death
birth	X	X	Z^{-1}	Z
merge	X	X	Z	Z^{-1}
split	Z	Z^{-1}	Y	Y
death	Z^{-1}	Z	Y	Y

Corollary 4.11. *The following rules for reversing orientations hold:*

$$(23) \quad \begin{array}{c} \text{merge} \\ \text{cup} \end{array} = X \begin{array}{c} \text{cup} \\ \text{merge} \end{array}, \quad \begin{array}{c} \text{split} \\ \text{death} \end{array} = Y \begin{array}{c} \text{death} \\ \text{split} \end{array}, \quad \begin{array}{c} \text{cup} \\ \text{cup} \end{array} = Y \begin{array}{c} \text{cup} \\ \text{cup} \end{array}.$$

Proof. The last rule follows from the following change

$$(24) \quad \begin{array}{c} \text{cup} \\ \text{cup} \end{array} \Rightarrow \begin{array}{c} \text{merge} \\ \text{cup} \end{array} \Rightarrow \begin{array}{c} \text{split} \\ \text{cup} \end{array} \Rightarrow \begin{array}{c} \text{cup} \\ \text{cup} \end{array}$$

and the first one from

$$(25) \quad \begin{array}{c} \text{cup} \\ \text{merge} \end{array} \Rightarrow \begin{array}{c} \text{merge} \\ \text{merge} \end{array} \Rightarrow \begin{array}{c} \text{split} \\ \text{merge} \end{array} \Rightarrow \begin{array}{c} \text{merge} \\ \text{cup} \end{array}$$

Reversing an orientation of a split is done in a similar way. □

Remark 4.12. We shall usually omit the subscript, writing $R\mathbf{ChCob}^e(0)$ for the linearized category. If the choice of ι is important, we shall write $R\mathbf{ChCob}_{abc}^e(0)$ for the quotient by chronological relations with parameters X, Y , and Z set to a, b , and c accordingly.

Remark 4.13. A choice of parameters $X, Y, Z \in R$ as above is equivalent to specifying a ring homomorphism $\mathbb{k} \rightarrow R$, where $\mathbb{k} := \mathbb{Z}[X, Y, Z^{\pm 1}]/(X^2=Y^2=1)$. Hence, there is a base change isomorphism $R\mathbf{ChCob}^e(0) \cong R \otimes \mathbb{k}\mathbf{ChCob}^e(0)$ implying $\mathbb{k}\mathbf{ChCob}^e(0)$ is the universal linearization of $\mathbf{ChCob}^e(0)$ with respect to the function ι defined as in the proposition above.

From now on we shall take \mathbb{k} as the ring of coefficients. Choose a change of a chronology $\varphi: W \Rightarrow W'$ that is not a \diamond -change. Despite φ being a diffeotopy of the ambient space, the value $\iota(\varphi)$ depends only the restriction of φ to the cobordism W , which is a change of a chronology in the abstract sense. Even more, given a diffeomorphic cobordism $\widetilde{W} \approx W$ and a corresponding change $\tilde{\varphi}$ on \widetilde{W} , $\iota(\tilde{\varphi}) = \iota(\varphi)$.

\diamond -changes do not introduce essential relations in $\mathbb{k}\mathbf{ChCob}^e(0)$ —they force a merge followed by a split to be annihilated by $(1 - XY)$, a relation that is a consequence of the others, see Corollary 4.11. Hence, we can safely forget the ambient space and identify diffeomorphic cobordisms obtaining another category, which we shall denote by $\mathbb{k}\mathbf{ChCob}(0)$. Formally,

morphisms of $\mathbb{k}\mathbf{ChCob}(0)$ are \mathbb{k} -linear combinations of diffeomorphism classes of chronological cobordisms modulo the relations induced by ι : we set $W' = \iota(\varphi)W$ for any embedding of W and W' into $\mathbb{D}^2 \times I$ and a diffeotopy $\varphi: W \Rightarrow W'$.

Remark 4.14. One should not confuse $\mathbb{k}\mathbf{ChCob}(0)$ with a linearization of $2\mathbf{ChCob}$ —in the latter one must have $X = Y$ not only because there is only one type, up to inverse, of a \diamond -change, but this equality is also imposed by the additional relations coming from the non-planar diagrams (19). This is a reason why it is so difficult to extend the definition of odd Khovanov homology to virtual links, even if we restrict to those on orientable surfaces: the non-planar diagrams (19) encode the cube of resolutions for the virtual Borromean rings, which are realized on a torus.

Because we identify in $\mathbb{k}\mathbf{ChCob}(0)$ diffeomorphic cobordisms, there exists a cobordism W such that $W = kW$ for some $k \in \mathbb{k}$. Indeed, it is enough to find a nontrivial change of a chronology between diffeomorphic cobordisms, such as a permutation of two spheres:

$$(26) \quad \begin{array}{ccccccccc} \textcircled{\text{---}} & \longrightarrow & \textcircled{\text{---}} & \longrightarrow & \textcircled{\text{---}} & \textcircled{\text{---}} & \longrightarrow & \textcircled{\text{---}} & \textcircled{\text{---}} & \longrightarrow & \textcircled{\text{---}} & \textcircled{\text{---}} \\ \textcircled{\text{---}} & & \textcircled{\text{---}} & & & & & & & & & \textcircled{\text{---}} \\ & & & & & & & & & & & \textcircled{\text{---}} \end{array}$$

Another example is a twice punctured torus—reverse orientations of both saddle points and then rotate the cobordism. The following result states that nothing more can happen.

Theorem 4.15. *Choose an embedded chronological cobordism W in $\mathbb{k}\mathbf{ChCob}(0)$, where $\mathbb{k} = \mathbb{Z}[X, Y, Z^{\pm 1}]/(X^2 = Y^2 = 1)$, and write $\text{Aut}(W) := \{k \in \mathbb{k} \mid kW = W\}$. Then*

$$(27) \quad \text{Aut}(W) = \begin{cases} \{1\}, & \text{if } W \text{ has genus 0 and at most one closed component,} \\ \{1, XY\}, & \text{otherwise.} \end{cases}$$

A proof of this theorem is postponed to Section 10. Notice that elements of $\text{Aut}(W)$ are invertible, since they are products of values of ι .

5. KHOVANOV COMPLEX

Now we go back to the construction of the generalized Khovanov complex. For this section fix a link diagram D with n crossings, among which there are n_+ positive and n_- negative ones. We need to make a few choices: enumerate the crossings, and choose for each of them an arrow connecting the two arcs in its horizontal resolution, i.e. \bowtie or \bowtie .

Fig. 1 visualizes the construction for the trefoil knot. We can first see it as a diagram $\mathcal{I}(D)$ in the 2-category $\mathbf{ChCob}^e(0)$: vertices are 1-manifolds (resolutions of the diagram D), edges are chronological cobordisms between these manifolds and faces are decorated with changes of chronologies. It should be obvious how to create such a diagram for a link diagram D (see the discussion about diagrams with holes in Section 2). This diagram commutes in the 2-categorical sense: a composition of 2-morphisms along any 3-dimensional subcube is trivial:

$$(28) \quad \begin{array}{ccccc} & & 100 & \longrightarrow & 110 \\ & \nearrow & \Downarrow & \nearrow & \\ 000 & \longrightarrow & 010 & & 111 \\ & \searrow & \Downarrow & \searrow & \\ & & 001 & \longrightarrow & 011 \end{array} = \begin{array}{ccccc} & & 100 & \longrightarrow & 110 \\ & \nearrow & \Downarrow & \nearrow & \\ 000 & \longrightarrow & & \longrightarrow & 111 \\ & \searrow & \Downarrow & \searrow & \\ & & 001 & \longrightarrow & 011 \end{array}$$

This follows from Proposition 4.4, as the two changes are locally vertical with respect to small cylinders over the crossings of D .

Apply the function $\iota: 2\text{Mor}(\mathbf{ChCob}^e(0)) \rightarrow \mathbb{k}$ from Section 4 to faces of the cube $\mathcal{I}(D)$, where $\mathbb{k} = \mathbb{Z}[X, Y, Z^{\pm 1}]/(X^2 = Y^2 = 1)$; the faces are now decorated with elements from \mathbb{k}^* , the group of invertible elements in \mathbb{k} , according to Tab. 1. They define a 2-cochain $\psi \in C^2(I^n; \mathbb{k}^*)$. A 1-cochain $\epsilon \in C^1(I^n; \mathbb{k}^*)$ is called a *sign assignment* if $d\epsilon = -\psi$. This means the corrected cube $\mathcal{I}^\epsilon(D)$ anticommutes, where $\mathcal{I}^\epsilon(D)$ has the same vertices as $\mathcal{I}(D)$, but for an edge ζ one has $\mathcal{I}^\epsilon(D)(\zeta) = \epsilon(\zeta) \cdot \mathcal{I}(D)(\zeta)$. Existence of such a cochain follows easily.

Proposition 5.1. *The cochain ψ is a cocycle for any link diagram D . Hence, $-\psi = d\epsilon$ for some sign assignment ϵ .*

Proof. The 2-commutativity of faces (28) of any 3-dimensional subcube in $\mathcal{I}(D)$ implies that $d(-\psi) = d\psi = 1$. The existence of ϵ follows from the contractibility of I^n . \square

Motivated by [BN05] we construct the generalized Khovanov bracket in the *additive closure* $\text{Mat}(\mathbb{k}\mathbf{ChCob}(0))$ of the category $\mathbb{k}\mathbf{ChCob}(0)$.

Definition 5.2. The *additive closure* $\text{Mat}(\mathbf{C})$ of an R -linear category \mathbf{C} , where R is a commutative ring, is defined as follows:

- objects are formal direct sums $\bigoplus_{i=1}^n C_i$ of objects from \mathbf{C} ,
- a morphism $F: \bigoplus_{i=1}^n A_i \rightarrow \bigoplus_{j=1}^m B_j$ is a matrix $(F_{ij}: A_j \rightarrow B_i)$ of morphisms from \mathbf{C} ,
- the composition of morphisms $F \circ G$ mimics the formula for a product of matrices

$$(29) \quad (F \circ G)_{ij} := \sum_k F_{ik} \circ G_{kj}.$$

This category is R -linear with a natural action of R and addition defined as addition of matrices: $(F + G)_{ij} := F_{ij} + G_{ij}$.

We can represent objects of $\text{Mat}(\mathbf{C})$ by finite sequences (vectors) of objects in \mathbf{C} and morphisms between such sequences by bundles⁶ (matrices) of morphisms in \mathbf{C} , see Fig. 5. It means each column in Fig. 1 forms a single object C^i , as indicated by the dotted arrows going downwards, and all edges between two columns form a single morphism $d: C^i \rightarrow C^{i+1}$. Because every square in $\mathcal{I}^\epsilon(D)$ anticommutes, $d^2 = 0$.

There is one more ingredient to Fig. 1: the numbers in curly brackets along the dotted arrows. As usual, this is a notation for degree shifts.

Definition 5.3. Choose an abelian group G . We say an R -linear category \mathbf{C} is G -graded, if

- (1) for any objects A, B the set $\text{Mor}(A, B)$ is a G -graded R -module such that id_A is homogeneous of degree 0 for any object A ,
- (2) the degree function is additive with respect to composition: $\deg(f \circ g) = \deg f + \deg g$, for homogeneous f and g , and

⁶ In the colloquial sense, not the mathematical one.

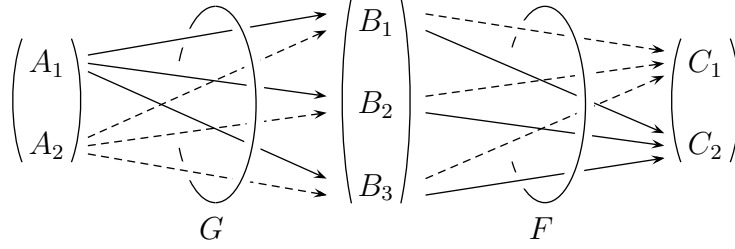

FIGURE 5. The composition of morphisms in the additive closure of a category. The component $(F \circ G)_{21}$ is indicated by solid lines.

- (3) there is a *degree shift* functor $\text{Ob}(\mathbf{C}) \times G \ni (A, m) \mapsto A\{m\} \in \text{Ob}(\mathbf{C})$ preserving morphisms, i.e. $\text{Mor}(A\{m\}, B\{n\}) = \text{Mor}(A, B)$, but degrees are changed: if a morphism $f \in \text{Mor}(A, B)$ has degree d , then $\deg f = d + n - m$ when regarded as an element of $\text{Mor}(A\{m\}, B\{n\})$.

We have already defined a $\mathbb{Z} \times \mathbb{Z}$ -valued degree function for chronological cobordisms (22). Here, we shall collapse it to an integral grading, by summing up both numbers, so that $\deg W = \chi(W)$ is the Euler characteristic of a cobordism W . Degree shifts are introduced artificially: add formal objects $\Sigma\{m\}$ for every 1-manifold Σ and $m \in \mathbb{Z}$, and extend the degree map as in the definition above:

$$(30) \quad \deg W := \chi(W) + n - m \quad \text{for} \quad W: \Sigma_0\{m\} \longrightarrow \Sigma_1\{n\}.$$

All cobordisms in the cube of resolutions have degree -1 . Hence, taking $C^i\{i\}$ at i -th place results in a complex with a degree 0 differential.

This is the last piece of the construction. Below we summarize everything, giving a full definition of the bracket.

Definition 5.4. Given a link diagram D with n crossings construct its cube of resolutions $\mathcal{I}(D)$ and choose a sign assignment ϵ . The *generalized Khovanov bracket* of D is a chain complex $[[D]]_\epsilon$ with:

$$(31) \quad [[D]]_\epsilon^i := \bigoplus_{\|\xi\|=i} D_\xi\{i\},$$

$$(32) \quad d_\epsilon|_{D_\xi} := \sum_{\zeta: \xi \longrightarrow \zeta'} \epsilon(\zeta) \cdot D_\zeta,$$

where $\|\xi\| := \xi_1 + \dots + \xi_n$ is the *weight* of a vertex ξ .

Corollary 5.5. *The sequence (C, d) at the bottom line of Fig. 1 is a chain complex.*

Proof. This follows from anticommutativity of the corrected cube $\mathcal{I}^\epsilon(D)$. \square

There are a few choices involved in the construction of $[[D]]_\epsilon$: an order of crossings, arrows at the crossings, and the sign assignment ϵ . We shall now show that different choices lead to isomorphic complexes. First, different orientation of the arrows over crossings can be compensated by an edge assignment.

Lemma 5.6. *Let D_1, D_2 be diagrams of a link L with n crossings, which differ only in directions of arrows over crossings. Then for any sign assignment ϵ_1 for $\mathcal{I}(D_1)$ there exists a sign assignment ϵ_2 for $\mathcal{I}(D_2)$ such that $\mathcal{I}^{\epsilon_1}(D_1) = \mathcal{I}^{\epsilon_2}(D_2)$.*

Proof. Without loss of generality we may assume D_1 and D_2 differ only in the direction of the arrow at the i -th crossing. Reversing the arrow changes orientation of critical points of cobordisms at edges ζ with $\zeta_i = *$. Let ψ_i be the commutativity cocycle of the cube $\mathcal{I}(D_i)$. Given a sign assignment ϵ_1 for $\mathcal{I}(D_1)$ we define

$$(33) \quad \epsilon_2(\zeta) := \begin{cases} \epsilon_1(\zeta), & \text{if } \zeta_i \neq *, \\ X\epsilon_1(\zeta), & \text{if } \zeta_i = * \text{ and } D_\zeta \text{ is a merge,} \\ Y\epsilon_1(\zeta), & \text{if } \zeta_i = * \text{ and } D_\zeta \text{ is a split.} \end{cases}$$

A direct computation shows $d\epsilon_2 = -\psi_2$, and ϵ_2 is the desired sign assignment for $\mathcal{I}(D_2)$. \square

A sign assignment for a given cube is unique up to an isomorphism, where an isomorphism of cubes $\eta: \mathcal{I} \rightarrow \mathcal{I}'$ is a collection of invertible morphisms $\eta_\xi: \mathcal{I}_\xi \rightarrow \mathcal{I}'_\xi$ such that the square commutes

$$(34) \quad \begin{array}{ccc} \mathcal{I}_\xi & \xrightarrow{\eta_\xi} & \mathcal{I}'_\xi \\ \mathcal{I}_\zeta \downarrow & & \downarrow \mathcal{I}'_\zeta \\ \mathcal{I}_{\xi'} & \xrightarrow{\eta_{\xi'}} & \mathcal{I}'_{\xi'} \end{array}$$

for every edge $\zeta: \xi \rightarrow \xi'$.

Lemma 5.7. *Let ϵ and ϵ' be two sign assignments for $\mathcal{I}(D)$. Then the cubes $\mathcal{I}^\epsilon(D)$ and $\mathcal{I}^{\epsilon'}(D)$ are isomorphic.*

Proof. The equality $d\epsilon = -\psi = d\epsilon'$ and contractibility of I^n implies that $\epsilon' = d\eta \cdot \epsilon$ for some 0-cochain $\eta \in C^0(I^n; \mathbb{k}^*)$. The family of morphisms $f_\xi := \eta(\xi) \cdot \text{id}$ form then a desired isomorphism $f: \mathcal{I}^\epsilon(D) \rightarrow \mathcal{I}^{\epsilon'}(D)$. \square

An isomorphism of cubes induces an isomorphism of complexes, resulting in the following statement.

Proposition 5.8. *The isomorphism class of the Khovanov bracket $\llbracket D \rrbracket_\epsilon$ depends only on the link diagram D .*

Proof. Changing the order of crossings results in a different parametrization of the cube $\mathcal{I}(D)$, but the chain objects $\llbracket D \rrbracket_\epsilon^i$ are preserved and likewise for the differential. Independence of the other choices follows from Lemmas 5.6 and 5.7, as an isomorphism of anticommutative cubes descends to an isomorphism of complexes. \square

The generalized bracket, even up to chain homotopies, is not a link invariant, but it is not very far from it. To construct an invariant we have to take an oriented diagram and shift degrees (both the internal grading and the homological one) according to the number of positive and negative crossings.

Definition 5.9. Let D be an oriented link diagram with n_+ positive and n_- negative crossings. The *generalized Khovanov complex* $Kh(D)$ of D is obtained from the bracket $\llbracket D \rrbracket$ by the degree shifts $Kh(D) := \llbracket D \rrbracket[-n_-]\{n_+ - 2n_-\}$, i.e. $Kh^i(D) = \llbracket D \rrbracket^{i-n_-}\{n_+ - 2n_-\}$.

We shall show invariance of the complex in Section 7, but before that we describe an extension of the construction to tangles.

6. TANGLES AND PLANAR ALGEBRAS

Tangles have a rich algebraic structure called a planar algebra [Jo99]: they can be combined together to produce larger tangles, by connecting some of their endpoints. We follow here the exposition from [BN05].

Definition 6.1. A *planar arc diagram* D with d inputs is a disk \mathbb{D}^2 missing d smaller disks \mathbb{D}_i^2 , together with a proper embedding of disjoint circles and closed intervals. Each boundary component carries a basepoint and meets an even number of intervals. We say that D is *oriented* if the embedded circles and intervals are oriented. Both oriented and non-oriented planar arc diagrams are considered up to planar isotopies.

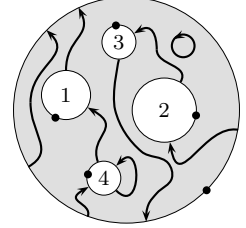

We can compose planar arc diagrams by placing one of them in a hole of another. This operation is associative: when composing more than two diagrams, the final result does not depend in which order they are composed.

Definition 6.2. A *planar algebra* \mathcal{P} is a collection of sets $\mathcal{P}(k)$ together with operators

$$(35) \quad D: \mathcal{P}(k_1) \times \cdots \times \mathcal{P}(k_s) \longrightarrow \mathcal{P}(k),$$

one for each planar arc diagram D , whose composition is associative and radial diagrams (i.e. those with a single input and radially embedded intervals) correspond to identity maps. An *oriented planar algebra* is defined similarly, using oriented planar arc diagrams.

Example 6.3. Given a planar arc diagram D we can insert into its holes some tangle diagrams, creating another tangle diagram. This results in a map

$$(36) \quad D: \mathcal{T}^0(k_1) \times \cdots \times \mathcal{T}^0(k_s) \longrightarrow \mathcal{T}^0(k),$$

where $\mathcal{T}^0(k)$ is the set of all tangle diagrams with $2k$ endpoints embedded in a disk \mathbb{D}^2 with a basepoint on its boundary (the basepoints make this operation well-defined). Because Reidemeister moves are local, we can replace $\mathcal{T}^0(k)$ with sets of tangles $\mathcal{T}(k)$ and the operation induced by D is still well-defined. In a similar way oriented diagrams allow us to combine oriented tangles. Here, we group tangles (or tangle diagrams) into sets $\mathcal{T}_+(\vec{s})$ (respectively $\mathcal{T}_+(\vec{s})$), labeled with finite sequences \vec{s} of $+$'s and $-$'s encoding orientation of the endpoints.

Definition 6.4. A *morphism* of planar algebras $\Phi: \mathcal{P}_1 \longrightarrow \mathcal{P}_2$ is a collection of morphisms $\Phi_k: \mathcal{P}_1(k) \longrightarrow \mathcal{P}_2(k)$ commuting with planar operators, i.e.

$$(37) \quad D \circ (\Phi_{k_1}, \dots, \Phi_{k_s}) = \Phi_k \circ D.$$

for every operator D . In a similar way one defines morphisms of oriented planar algebras.

Example 6.5. There is a natural morphism from the planar algebra of tangle diagrams to the planar algebra of tangles that maps a tangle diagram into the tangle it represents.

We shall now construct the Khovanov complex for a tangle diagram T with $2k$ endpoints. As mentioned in Section 2, we can construct the cube of resolutions $\mathcal{I}(T)$ using cobordisms with corners $\mathbf{ChCob}^e(k)$. These 2-categories also form a planar algebra, with a cubical functor

$$(38) \quad D: \mathbf{ChCob}^e(k_1) \times \cdots \times \mathbf{ChCob}^e(k_d) \longrightarrow \mathbf{ChCob}^e(k)$$

associated to every planar arc diagram D as follows.

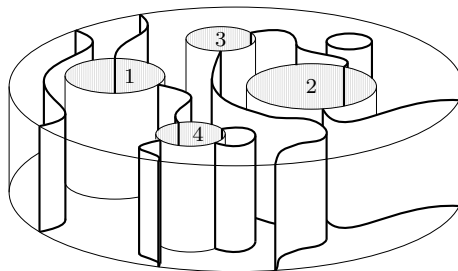
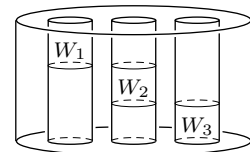

FIGURE 6. The planar operator on the set of cobordisms with corners associated to the planar diagram from Definition 6.1 consists of a cylinder with hollow tubes and curtains, i.e. properly embedded vertical rectangles.

- The object $D(\Sigma_1, \dots, \Sigma_d)$ is defined in the same way as a composition of tangle diagrams: simply insert the pictures Σ_i into holes of D .
- For cobordisms take a *curtain diagram* $D \times I$ (see Fig. 6 for an example) and fill its holes with the cobordisms. Here, one has to do the same trick as with the disjoint sum—to shift all critical points, placing the critical points of the first cobordism at the top, below the critical points of the second one and so on.
- Finally, for changes of chronologies $\alpha_i: W_i \Rightarrow W'_i$ there is an induced change



$$(39) \quad D(\alpha_1, \dots, \alpha_d): D(W_1, \dots, W_d) \Longrightarrow D(W'_1, \dots, W'_d)$$

defined as a composition $\bar{\alpha}_1 \circ \dots \circ \bar{\alpha}_d$, where $\bar{\alpha}_i = D(\text{id}_{W_1}, \dots, \alpha_i, \dots, \text{id}_{W'_d})$ is given by α_i in the i -th hole (reparametrized accordingly) and fixed beyond it. Simply speaking, all changes α_i are applied at the same time, but on different regions.⁷

It follows directly from Proposition 4.4 that the functors defined above are cubical. They extend naturally to cubes in $\mathbf{ChCob}^e(k)$.

Corollary 6.6. *The function $T \mapsto \mathcal{I}(T)$ is a morphism of planar algebras, i.e.*

$$(40) \quad \mathcal{I}(T) = D(\mathcal{I}(T_1), \dots, \mathcal{I}(T_d))$$

for a planar arc diagram D and tangle diagrams T_1, \dots, T_d with an appropriate number of endpoints.

Remark 6.7. We can extend the integral degree to cobordisms with corners by setting $\text{deg } W := \chi(W) - k$ for $W \in \mathbf{ChCob}^e(k)$, and this degree is preserved by planar algebra operators. However, cobordisms with corners do not admit a natural $\mathbb{Z} \times \mathbb{Z}$ -grading defined in Section 4.

The main problem when defining the Khovanov complex for tangles is to understand the commutativity cocycle ψ . For instance, a single saddle is a part of both a merge and a split:

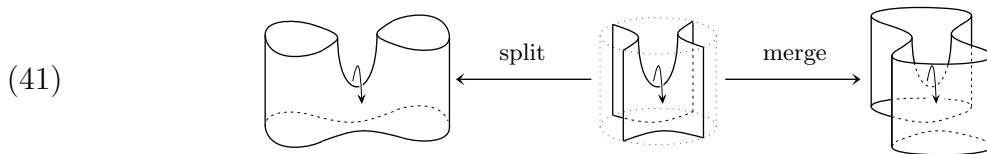

(41)

⁷ A change defined in this way might not be generic.

Closure diagram		
$\psi \left(\begin{array}{c} \text{Closure diagram 1} \\ \text{Closure diagram 2} \end{array} \right)$		
$\psi \left(\begin{array}{c} \text{Closure diagram 1} \\ \text{Closure diagram 2} \end{array} \right)$		

TABLE 3. Values of ψ for some diagrams with four endpoints.

and any of the diagrams in Tab. 1 is a closure of two saddles. Therefore, a coefficient associated to a change of a chronology cannot be a single element of the ring \mathbb{k} , but it must be a gadget that returns such an element after all corners and vertical boundaries are connected in pairs.

Definition 6.8. A *closure planar diagram* is a planar arc diagram with one input (hence, it is an annulus) and embedded intervals only with endpoints on the input boundary.

Denote by $\mathcal{CPO}(k)$ the set of all closure planar diagrams. If T is a tangle diagram with $2k$ endpoints and $D \in \mathcal{CPO}(k)$ is a closure operator, then $D(T)$ is a link. A diagram $D \in \mathcal{CPO}(k)$ induces a strict 2-functor⁸

$$(42) \quad \mathbf{ChCob}^e(k) \longrightarrow \mathbf{ChCob}^e(0) \longrightarrow \mathbb{k}\mathbf{ChCob}(0),$$

which suggests the commutativity cochain ψ takes values in $\mathbb{k}(k) := \{f: \mathcal{CPO}(k) \longrightarrow \mathbb{k}\}$, the ring of all functions from the set of closure planar operators to \mathbb{k} . To compute $\psi(S)(D)$ identify the picture $D(S)$ in Tab. 1 on page 7 (an example is given in Tab. 3). It follows immediately that ψ is a cocycle and that $[[T]]_\epsilon$, up to an isomorphism, does not depend on a sign assignment ϵ .

Remark 6.9. For simplicity, the linearization of $\mathbf{ChCob}^e(k)$ with coefficients in $\mathbb{k}(k)$ will be written as $\mathbb{k}\mathbf{ChCob}(k)$.

Remark 6.10. It can be shown that categories $\mathbb{k}\mathbf{ChCob}(k)$ form a planar algebra. However, there is no analogue of Corollary 6.6 for signed cubes: planar operators are only cubical functors and as such they do not preserve anticommutativity. In particular, we cannot use planar operators to combine generalized brackets together as it was done in [BN05].

7. PROOF OF INVARIANCE

The Khovanov complex $Kh(T)$ is not a tangle invariant. For example, it depends on the number of crossings in a chosen diagram. This dependence disappears after passing to the homotopy category of complexes and imposing modified versions of Bar-Natan's S , T , and $4Tu$ relations [BN05] explained below.

⁸ A cubical functor taking one argument is automatically strict.

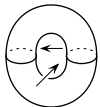
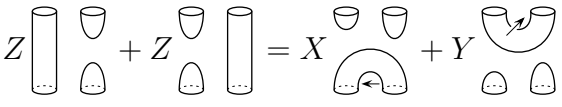
- (S) The S relation replaces with 0 all cobordisms that have a sphere as a connected component. The number and orientations of critical points do not matter.  = 0
- (T) The T relation allows us to remove a standard torus component at a cost of multiplying the cobordism with $Z(X + Y)$. Here, the standard torus is defined as a torus with four critical points and an arrow at the merge pointing to the circle originating on the left hand side of the split. The death is oriented clockwise.  = $Z(X + Y)$
- (4Tu) The four tube relation 4Tu involves four cobordisms from two circles to two circles. Each of them consists of a tube and two caps, but the position of the tube is different in each picture: for the first two cobordisms the tube is a vertical cylinder over one of the two circles, while in the remaining two cases it connects either the input or the output circles. Notice the choice of framing for saddle points and heights of caps (the left caps are smaller than the right ones). Again, all deaths are oriented clockwise. 

The relations above, especially T and 4Tu, are local. This means all other critical points can appear only above or below the pictures shown.⁹ All relations are homogeneous—the degree of the standard torus is zero, whereas each cobordism involved in 4Tu has degree $(-1, -1)$ —so that they are coherent with changes of chronologies. Let $\mathbb{k}\mathbf{ChCob}_{/\ell}(k)$ be the quotient of $\mathbb{k}\mathbf{ChCob}(k)$ by these relations.

Theorem 7.1. *Let T be a tangle with $2k$ endpoints. The homotopy type of the generalized Khovanov complex $Kh(T)$, regarded as an object of $\mathbf{Kom}(\mathbb{k}\mathbf{ChCob}_{/\ell}(k))$, is an invariant of T , i.e. complexes for two tangle diagrams related by any of the Reidemeister moves are chain homotopy equivalent.*

We shall first prove this theorem locally, for the tangles defining Reidemeister moves. Using the planar algebra of chronological cobordisms we shall then extend the homotopy equivalences to complexes for bigger tangles. Proofs will be done on pictures of cobordisms and for simplicity we omit some details, keeping in mind the following conventions:

- (1) basepoints should be chosen in the same place for all pictures involved in each proof,
- (2) all deaths are oriented clockwise, and
- (3) arrows orienting saddles are directed either to the right or to the front.

In particular, we can cancel at no cost a merge or a split with a birth or a death respectively on its right-hand side, while a left-hand cancellation costs a multiplication by X or Y .

Definition 7.2. We say that a chain complex D is a *strong deformation retract* of a chain complex C if there are chain maps $f: D \rightarrow C$ and $g: C \rightarrow D$ such that $gf = \text{id}$ and $fg - \text{id} = dh + hd$ for a homotopy h such that $hf = 0$.¹⁰ The chain map f is called an *inclusion into a deformation retract*.

Lemma 7.3. *The bracket $\llbracket \textcircled{\curvearrowright} \rrbracket \{1\}$ is a strong deformation retract of $\llbracket \textcircled{\curvearrowright} \rrbracket$. Hence, $Kh(\textcircled{\curvearrowright})$ and $Kh(\textcircled{\curvearrowright})$ are homotopy equivalent for any orientation of the tangle.*

⁹ This is exactly how the right disjoint union of chronological cobordisms behaves.

¹⁰ We will often omit the composition sign \circ .

Proof. The second statement follows from the first one, because no matter how the tangle is oriented, its crossing is positive. Consider now the diagram to the right. Rows together with morphisms pointing to the right represent the Khovanov brackets $[[\curvearrowright]]$ (the top row) and $[[\curvearrowleft]]$ (the bottom row), whereas the morphisms pointing to the left are chain homotopies in these complexes (zero at the top and a curtain with a birth at the bottom). The coefficient ϵ comes from a sign assignment—although we could take $\epsilon = 1$, this more general situation turns out to be useful when extending the proof to the global case.

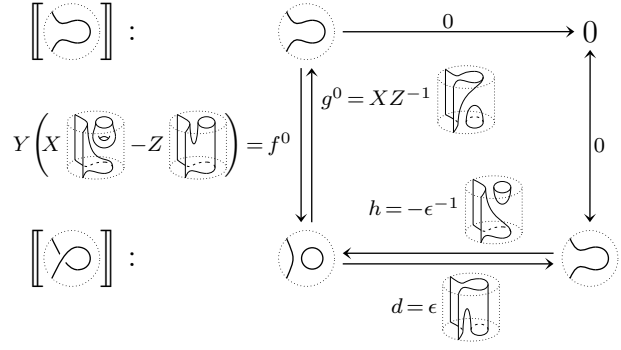

Vertical arrows define chain maps $f: [[\curvearrowright]] \rightarrow [[\curvearrowleft]]$ and $g: [[\curvearrowleft]] \rightarrow [[\curvearrowright]]$, which is obvious for g , but requires the following short computation for f :

$$(43) \quad \epsilon^{-1}df^0 = XY \text{ (cylinder with crossing)} - YZ \text{ (cylinder with crossing)} = YZ \text{ (cylinder with crossing)} - YZ \text{ (cylinder with crossing)} = 0.$$

When the degree shifts are applied, both f and g have degree 0. They are chain homotopy equivalences, as the relation T implies $gf = \text{id}$:

$$(44) \quad g^0f^0 = YZ^{-1} \text{ (cylinder with crossing)} - XY \text{ (cylinder with crossing)} = (Y(X + Y) - XY) \text{ (cylinder with crossing)} = \text{id},$$

whereas $4Tu$ makes $f^0g^0 - \text{id} = hd$:

$$\begin{aligned} 0 &= Z \text{ (cylinder with crossing)} + Z \text{ (cylinder with crossing)} - X \text{ (cylinder with crossing)} - Y \text{ (cylinder with crossing)} \\ &= YZ \text{ (cylinder with crossing)} + XZ \text{ (cylinder with crossing)} - XZ \text{ (cylinder with crossing)} - YZ \text{ (cylinder with crossing)} = -XZ(f^0g^0 - \text{id} - hd). \end{aligned}$$

After expanding f^0g^0 we can see that the last cobordism should appear with the coefficient $-XY$. The equality holds, because the cobordism has a handle, hence, it is annihilated by $(1 - XY)$. Together with $dh = -\text{id} = f^1g^1 - \text{id}$ (remove the birth), this shows that the maps f and g are mutually inverse homotopy equivalences. To finish the proof, notice that $hf = 0$ trivially. \square

Remark 7.4. Suppose \curvearrowright is a part of a bigger tangle diagram T and consider the corrected cube of resolutions $\mathcal{I}^\epsilon(T)$. If we replace edges d_ζ corresponding to the crossing in \curvearrowright with homotopies h_ζ defined as in Lemma 7.3 (this reverses directions of the edges), the new cube still

anticommutes. Indeed, as d_ζ is always a merge and h_ζ is a birth, checking anticommutativity reduces to comparing the following squares.

$$(45) \quad \begin{array}{ccc} \begin{array}{ccc} \bullet & & \bullet \\ \text{saddle} \nearrow & & \searrow \text{merge} \\ & \circlearrowleft & \\ \bullet & & \bullet \\ \text{merge} \nwarrow & & \nearrow \text{saddle} \end{array} & \longleftrightarrow & \begin{array}{ccc} \bullet & & \bullet \\ \text{saddle} \nearrow & & \searrow \text{birth} \\ & \circlearrowleft & \\ \bullet & & \bullet \\ \text{birth} \nwarrow & & \nearrow \text{saddle} \end{array} \end{array}$$

Whatever the saddle is, the relation between the top and the bottom cobordism in the left square is exactly the same as the relation between the left and the right cobordism in the right square. Because we corrected h_ζ with the inverse of the coefficient for d_ζ , coefficients along the circular arrows are the same and anticommutativity of one of the squares implies anticommutativity of the other.

Lemma 7.5. *The bracket $[[\text{merge}]] \{1\}$ is a strong deformation retract of $[[\text{birth}]] [1]$. Hence, $Kh(\text{merge})$ and $Kh(\text{birth})$ are homotopy equivalent for any orientation of the tangles involved.*

Proof. As before, the second claim follows from the first one, as the two crossings in birth have different signs for any orientation of the tangle. The first sentence follows from the diagram in Fig. 7. As before, ϵ 's come from some sign assignment (so that the lower square anticomutes). The nontrivial components of f and g are chosen as compositions $f^0 := h_{*1}d_{1*}$ and $g^0 := d_{*0}h_{0*}$. Again, both f and g have degree 0 after the degree shifts are applied.

The morphisms f and g are chain maps: the equalities $df = 0$ and $dg = 0$ are either trivial or they follow easily from the chronological relations. The relation S makes both $gf = \text{id}$ and $hf = 0$ and it remains to show that h is a chain homotopy between fg and the identity morphism. The only nontrivial case is in the middle, where we have to check the matrix equality

$$(46) \quad \begin{pmatrix} g^0 f^0 & f^0 \\ g^0 & I \end{pmatrix} - \begin{pmatrix} \text{id} & 0 \\ 0 & \text{id} \end{pmatrix} = \begin{pmatrix} h_{*1}d_{*1} + d_{0*}h_{0*} & h_{*1}d_{1*} \\ d_{*0}h_{0*} & 0 \end{pmatrix}.$$

It follows from definitions of f^0 and g^0 and the $4Tu$ relation:

$$\begin{aligned} 0 &= Z \begin{array}{c} \text{merge} \\ \text{merge} \end{array} + Z \begin{array}{c} \text{merge} \\ \text{merge} \end{array} - X \begin{array}{c} \text{merge} \\ \text{merge} \end{array} - Y \begin{array}{c} \text{merge} \\ \text{merge} \end{array} \\ &= XZ \begin{array}{c} \text{merge} \\ \text{merge} \end{array} + XYZ \begin{array}{c} \text{merge} \\ \text{merge} \end{array} - XZ \begin{array}{c} \text{merge} \\ \text{merge} \end{array} - XYZ \begin{array}{c} \text{merge} \\ \text{merge} \end{array} \\ &= XZ \begin{array}{c} \text{merge} \\ \text{merge} \end{array} - \gamma\varphi XZ \begin{array}{c} \text{merge} \\ \text{merge} \end{array} - XZ \begin{array}{c} \text{merge} \\ \text{merge} \end{array} - XYZ \begin{array}{c} \text{merge} \\ \text{merge} \end{array} \\ &= XZ(-f^0 g^0 + \text{id} + h_{*1}d_{*1} + d_{0*}h_{0*}). \end{aligned}$$

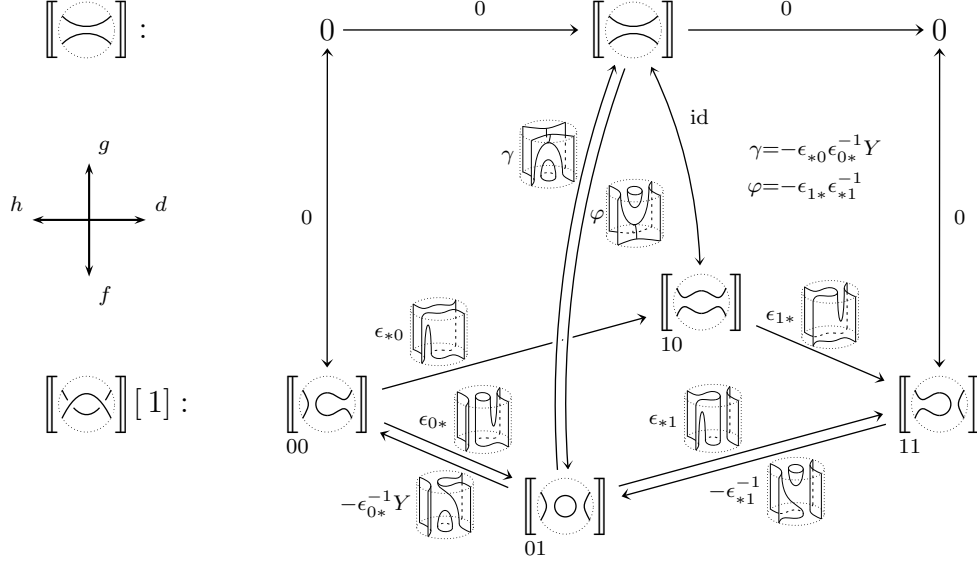
FIGURE 7. Invariance under the R_2 move.

The coefficient X at the first term appears, because the birth is canceled with a merge from the left side. The same happens in the last two terms, but in the third one we also have to reverse an orientation of the lower merge. Finally, to modify the second term, we first used chronological relations and then anticommutativity of the lower square in Fig. 7 (erase the caps to see compositions of differentials). \square

Remark 7.6. As before, if we take a cube for a bigger tangle diagram the homotopies h_{0*} and h_{*1} anticommute with edges corresponding to other crossings than the two involved in the second Reidemeister move. This can be shown similarly as in Remark 7.4: the two homotopies are paired with edges that are always a merge or a split, however we close the diagram.

The case of the third move is the simplest one, although it deals with the largest complex. This is because it can be derived from the invariance under the second move, as it is done in the case of the Kauffman bracket. For this, we need one property of mapping cone complexes.

Definition 7.7. The *mapping cone* of a chain map $\psi: C \rightarrow D$ is the chain complex $C(\psi)$ defined as

$$(47) \quad C(\psi)^i := C^{i+1} \oplus D^i, \quad d = \begin{pmatrix} -d_C & 0 \\ \psi & d_D \end{pmatrix}$$

Lemma 7.8. *The homotopy type of a mapping cone is preserved under compositions with inclusions into strong deformation retracts. More precisely, given a pair of strong deformation retracts*

$$(48) \quad C_a \xrightleftharpoons[f_a]{g_a} D_a \quad \text{and} \quad C_b \xrightleftharpoons[f_b]{g_b} D_b$$

and a chain map $\psi: C_a \rightarrow C_b$, the mapping cones $C(\psi f_a)$ and $C(f_b \psi)$ are strong deformation retracts of $C(\psi)$.

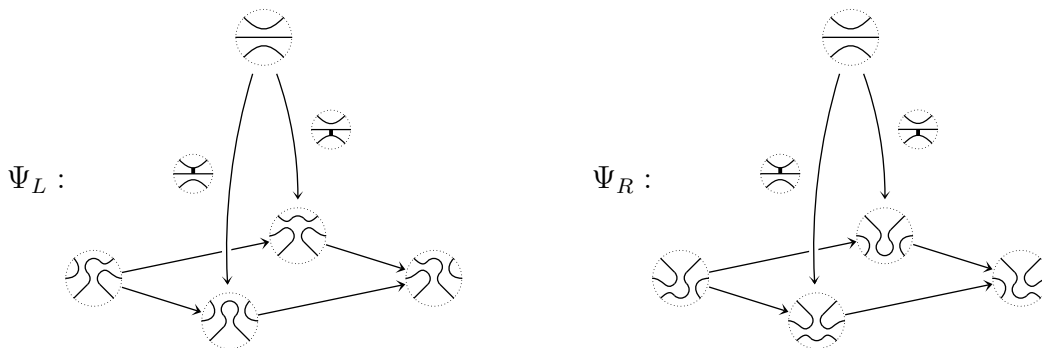

FIGURE 8. Morphisms describing complexes for the two tangles defining the R_3 move.

Proof. Let h be the homotopy associated to the retract D . Then there is a diagram with commuting squares

$$(49) \quad \begin{array}{ccccccc} C(\psi f_a) : & \dots & \longrightarrow & D_a^r \oplus C_b^{r-1} & \xrightarrow{d} & D_a^{r+1} \oplus C_b^r & \longrightarrow \dots \\ & & & \uparrow \tilde{g}_a^r \downarrow \tilde{f}_a^r & & \uparrow \tilde{g}_a^{r+1} \downarrow \tilde{f}_a^{r+1} & \\ C(\psi) : & \dots & \longrightarrow & C_a^r \oplus C_b^{r-1} & \xleftarrow[\tilde{h}]{d} & C_a^{r+1} \oplus C_b^r & \longrightarrow \dots \end{array}$$

with morphisms \tilde{f}_a , \tilde{g}_a , and \tilde{h} given by matrices

$$(50) \quad \tilde{f}_a^r = \begin{pmatrix} f_a & 0 \\ 0 & \text{id} \end{pmatrix}, \quad \tilde{g}_a^r = \begin{pmatrix} g_a & 0 \\ -\psi h & \text{id} \end{pmatrix}, \quad \tilde{h}^r = \begin{pmatrix} -h & 0 \\ 0 & 0 \end{pmatrix}.$$

A quick computation shows $\tilde{h}\tilde{f}_a = 0$, $\tilde{g}_a\tilde{f}_a = \text{id}$, and $\tilde{f}_a\tilde{g}_a - \text{id} = d\tilde{h} + \tilde{h}d$, which proves $C(\psi f_a)$ is a strong deformation retract of $C(\psi)$. The other case is shown in a similar way. \square

Lemma 7.9. *The complexes $[[\otimes]]$ and $[[\otimes]]$ are homotopy equivalent and so are $\text{Kh}(\otimes)$ and $\text{Kh}(\otimes)$ for any orientation of tangles.*

Proof. Again, the second part follows from the first one, because \otimes and \otimes have same crossings, regardless of orientation. The complex $[[\otimes]]$ is a mapping cone of the chain map $\Psi := [[\otimes]]: [[\otimes]] \rightarrow [[\otimes]]$ visualized by the four vertical morphisms to the right. Consider the chain map f from the proof of Lemma 7.5. It is an inclusion into a strong deformation retract and Lemma 7.8 implies $[[\otimes]]$ is homotopy equivalent to the mapping cone of $\Psi_L := \Psi \circ f$ given in Fig 8. For the same argument $[[\otimes]]$ is homotopy equivalent to Ψ_R . Since tangle diagrams \otimes and \otimes are isotopic, the mapping cone complexes $C(\Psi_L)$ and $C(\Psi_R)$ are isomorphic. \square

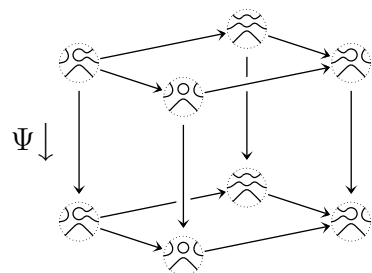

Proof of Theorem 7.1. It remains to show that the above local proofs extend to diagrams of bigger tangles. Each case follows the same pattern. Assume there is a chain map $\psi: \text{Kh}(T_1) \rightarrow \text{Kh}(T_2)$ defined for whichever sign assignments were chosen to construct the complexes. Choose a tangle T and a planar arc diagram D with two inputs, and construct a corrected cube $\mathcal{I}^{\epsilon_1}(D(T, T_1))$ using some sign assignment ϵ_1 . We can collapse it partially to obtain a cube of complexes as in Fig. 9. Namely, a resolution T_ξ of the tangle T

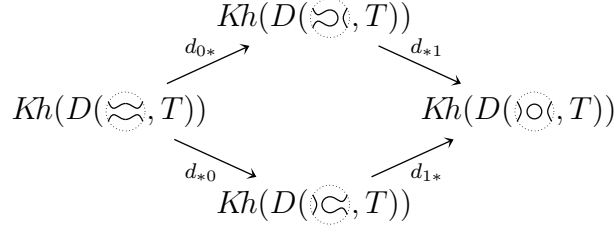

FIGURE 9. The cube of complexes for a tangle T induced by a planar diagram D and a tangle \otimes with 2 crossings. Each arrow is a degree 0 morphism that anticommutes with differentials.

picks a subcube $\mathcal{I}^{\epsilon_1|\epsilon}(D(T_\xi, T_1))$, which collapses to the complex $Kh(D(T_\xi, T_1))$. Put these complexes in vertices of an n -dimensional cube, where n is the number of crossings of T . Since the original cube $\mathcal{I}^{\epsilon_1}(D(T, T_1))$ anticommutes, the edge morphisms corresponding to changing resolutions of T induce ‘anti-chain’ maps

$$(51) \quad d_\zeta: Kh(D(T_\xi, T_1)) \longrightarrow Kh(D(T_{\xi'}, T_1)),$$

i.e. morphisms that anticommute with differentials.

We can do the same with the tangle T_2 , obtaining a cube of complexes $Kh(D(T_\xi, T_2))$. Because planar operators with one input are strict 2-functors, $Kh(D(T_\xi, T_1)) = D(T_\xi, Kh(T_1))$ and there are chain maps

$$(52) \quad D(T_\xi, \psi): Kh(D(T_\xi, T_1)) \longrightarrow Kh(D(T_\xi, T_2)),$$

one for each resolution T_ξ . Hence, we have two cubes of complexes and a morphism between them. Collapsing these cubes (while taking care about homological grading of complexes in vertices¹¹) results in the complexes $Kh(D(T, T_i))$. If the chain maps $D(T_\xi, \psi)$ commute with the edge morphisms d_ζ , they induce a chain map $\Psi: Kh(D(T, T_1)) \longrightarrow Kh(D(T, T_2))$. In particular, if all ψ are homotopy equivalences, so is Ψ .

There is nothing to do for the second Reidemeister move. If a tangle diagram T can be reduced to T' by this move, consider $\mathcal{I}(T')$ as a subcube of $\mathcal{I}(T)$. Remark 7.6 implies that both homotopies h_{0*} and h_{*1} from Lemma 7.5 anticommute with edge morphisms from $\mathcal{I}(T')$, so that the morphisms $f^0 := h_{*1}d_{1*}$ and $g^0 := d_{*0}h_{0*}$ commute with them.

Invariance under the third Reidemeister move follows from the same argument as the one used to prove Lemma 7.9: the chain map f from the previous paragraph is again an inclusion into a strong deformation retract.

The first Reidemeister move is the most challenging one. As before, choose a diagram T that can be reduced to T' by this move, and consider $\mathcal{I}(T')$ as a subcube of $\mathcal{I}(T)$. The morphisms f and g does not commute with the edge morphisms of $\mathcal{I}(T')$: for an edge $\zeta: \xi \longrightarrow \xi'$ decorated with a morphism d_ζ we have

$$(53) \quad d_\zeta g_\xi = \lambda(\text{chdeg } d_\zeta, \text{chdeg (a birth)}) g_{\xi'} d_\zeta$$

and similarly for f . To fix it, we define a 0-cochain $\eta \in C^0(I^{n-1}; \mathbb{k}^*)$ in the following way. Pick any oriented path in $\mathcal{I}(T')$ from the origin $(0, \dots, 0)$ to a vertex ξ . It represents some chronological cobordism W , whose degree $\text{chdeg } W$ depends only on ξ , but not on the path.

¹¹ This can be achieved for instance by shifting a homological degree of a complex $Kh(D(T_\xi, T_i))$ by $-\|\xi\|$ and then taking a direct sum of complexes over all vertices.

Define $\eta(\xi) := \lambda(\text{chdeg } W, \text{chdeg}(\text{a birth}))$. Then

$$(54) \quad \eta(\xi')g_{\xi'}d_{\zeta} = \eta(\xi)\lambda(\text{chdeg } d_{\zeta}, \text{chdeg}(\text{a birth}))g_{\xi'}d_{\zeta} = \eta(\xi)d_{\zeta}g_{\xi}.$$

Hence, ηg commutes with edge morphisms. In a similar way we show that $\eta^{-1}f$ induces a chain map. \square

8. BASIC PROPERTIES

Directly from its definition the generalized Khovanov bracket satisfies the following properties, similar to the rules of the Kauffman bracket:

- (KB1) $[\emptyset] = \emptyset$,
- (KB2) $[[T \sqcup T']] = [[T]] \sqcup T'$, if T' has no crossings¹², and
- (KB3) $[\times] = C([\times]: [\times] \rightarrow [\triangleright\triangleleft]\{1\}) [1]$.

In the last property, the symbols \times , \succ and $\triangleright\triangleleft$ represent three tangle diagrams that are identical except the indicated region and the morphism $[\times]$ is induced by edge maps in the cube $\mathcal{I}(\times)$ at which the resolution of the distinguished crossing is changed.

The property (KB3) implies a long exact sequence of generalized Khovanov complexes that mimics the Jones skein relation. Say that a sequence $\dots \rightarrow A_i \rightarrow A_{i+1} \rightarrow A_{i+2} \rightarrow \dots$ in $\text{Mat}(\mathbb{k}\mathbf{ChCob})$ is *exact* if its image under any additive functor $\mathcal{F}: \text{Mat}(\mathbb{k}\mathbf{ChCob}) \rightarrow \mathbf{A}$ is exact, where \mathbf{A} is any abelian category.

Proposition 8.1. *There is an exact sequence of complexes*

$$(55) \quad 0 \rightarrow Kh(\triangleright\triangleleft)[2]\{1\} \rightarrow Kh(\times)[2]\{2\} \rightarrow Kh(\times)\{-2\} \rightarrow Kh(\triangleright\triangleleft)\{-1\} \rightarrow 0.$$

Proof. The property (KB3) for diagrams \times and \times implies the following sequences are exact:

$$(56) \quad 0 \rightarrow [\triangleright\triangleleft][1]\{1\} \rightarrow [\times] \rightarrow [\succ] \rightarrow 0,$$

$$(57) \quad 0 \rightarrow [\succ][1]\{1\} \rightarrow [\times] \rightarrow [\triangleright\triangleleft] \rightarrow 0.$$

Gluing them together results in an exact sequence

$$(58) \quad 0 \rightarrow [\triangleright\triangleleft][2]\{1\} \rightarrow [\times][1] \rightarrow [\times]\{-1\} \rightarrow [\triangleright\triangleleft]\{-1\} \rightarrow 0,$$

which is the same as (55) up to grading shifts. \square

Next, the generalized Khovanov complex $Kh(T)$ depends on the orientation of T in a well understood way.

Proposition 8.2. *Choose an oriented tangle T . Denote by $-T$ the same tangle with reversed orientation of all its components and by T' the tangle when only the orientation of a single component T_0 is reversed. Then*

$$(59) \quad Kh(-T)^r \cong Kh(T)^r,$$

$$(60) \quad Kh(T')^r \cong Kh(T)^{r-2\ell}\{-6\ell\},$$

where $\ell = \text{lk}(T - T_0, T_0)$ is the linking number of T_0 with the remaining components of T .

Proof. For (59) it is enough to see that after reversing orientation of all components the signs of crossings are the same. If we reverse the orientation only of one component T_0 , then the crossings of T_0 with other components change signs, so that $n_+(T') = n_+(T) - 2\ell$ and $n_-(T') = n_-(T) + 2\ell$. \square

¹² Think of $(_)\sqcup T'$ as a functor on embedded cobordisms, which we extend naturally to complexes. It maps an object Σ to $\Sigma \sqcup T'$ and a cobordism W to $W \sqcup (T' \times I)$.

Given a tangle diagram T we form its mirror image T^\dagger by replacing every crossing with the other one—think about placing a mirror below the diagram. It follows the cube of resolutions of T^\dagger is a reflection of $\mathcal{I}(T)$: we start in the terminal state of T , which is the initial state of T^\dagger , and proceed backwards (see the picture to the right). Formally the symmetry comes from a duality functor $(_)^*: \mathbb{k}\mathbf{ChCob}(k) \rightarrow \mathbb{k}\mathbf{ChCob}(k)$ induced by the vertical flip of $\mathbb{D}^2 \times I$. We must be careful with defining orientations of critical points in W^* : if p is a critical point of W , its orientation determines an orientation of the stable part of $T_p W^*$. We choose for the unstable part the complementary orientation with respect to the outward orientation of the cobordism W . The only exception is a death, as there is only one orientation of births: if W is a negatively oriented death, we first rewrite it as a positively oriented death scaled by Y , and then we make the flip.

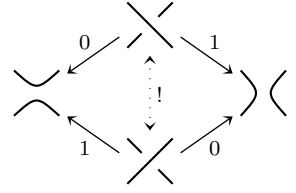

The convention for orientation of critical points can be described also diagrammatically in the following way. Color each region in the complement of W black or white, so that the unbounded region is white and regions with same colors do not meet. Then for a saddle point p rotate the framing arrow in W^* clockwise, if the region below $p \in W$ is white, and anticlockwise otherwise:

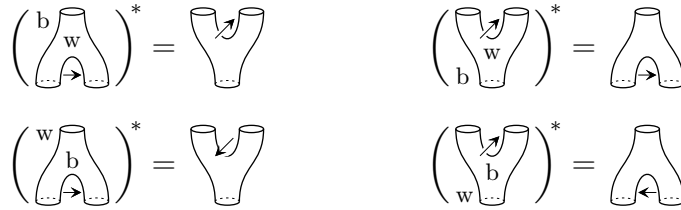

Since we want the duality functor to be coherent with annihilations and creations, there is no choice left for births and deaths:

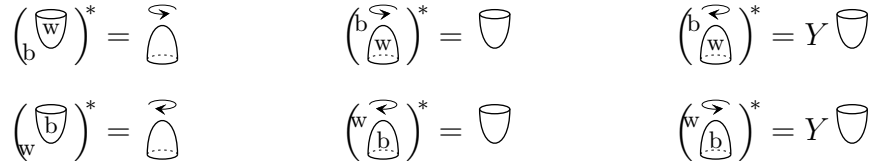

Flipping a cobordism permutes its degree components, $\text{chdeg } W^* = (b, a)$ if $\text{chdeg } W = (a, b)$, but it also intertwines the two disjoint unions, $(W \uplus W')^* = W^* \uplus W'^*$. Hence, in the linearized case, the roles of X and Y are exchanged, but the role of Z is preserved. Therefore, the flipping operation is a functor $(_)^*: \mathbb{k}\mathbf{ChCob}_{XYZ}(k) \rightarrow \mathbb{k}\mathbf{ChCob}_{YXZ}(k)$ between two different categories. It is coherent with all chronological relations, as well as with relations S , T , and $4Tu$. We extend it to categories of complexes, by reflecting the homological grading, i.e. we set $(C^*)^i := (C^{-i})^*$.

Proposition 8.3. *The generalized Khovanov complexes of a tangle T and its mirror image T^\dagger are dual to each other: $\text{Kh}_{XYZ}(T^\dagger) \cong \text{Kh}_{YXZ^{-1}}(T)^*$, where Kh_{abc} stands for a Khovanov complex constructed in the category $\mathbb{k}\mathbf{ChCob}_{/\ell}(k)$ with chronology change coefficients X , Y , and Z set to a , b , and c respectively.*

Proof. Choose a diagram of T with n enumerated crossings and arrows over them. To obtain a diagram for T^\dagger replace first each crossing \times with the opposite one \times , and rotate the arrows over crossings using the same convention as for $(_)^*$: color regions black and white and rotate an arrow anticlockwise, when it is placed over white regions, and clockwise otherwise.

With this choice of diagrams $\mathcal{I}(T^!) = \mathcal{I}(T)^*$, which follows directly from the construction of the cube of resolutions. Moreover, a sign assignment $\epsilon \in C^1(I^n; \mathbb{k}^*)$ for $\mathcal{I}(T)$ is automatically a sign assignment for $\mathcal{I}(T)^*$. Therefore, $([[T]]_\epsilon)^*[n] = [[T^!]]_\epsilon$ and the proposition follows. \square

9. HOMOLOGY

Although the complex $Kh(T)$ is an invariant of the tangle T , it is a difficult problem to determine whether two complexes in $\mathbb{k}\mathbf{ChCob}_{/\ell}$ are homotopy equivalent. One can obtain a partial answer, by applying a functor $\mathcal{F}: \mathbb{k}\mathbf{ChCob}_{/\ell} \rightarrow \mathbf{A}$ to some abelian category \mathbf{A} . Such a functor extends naturally to complexes $\mathcal{F}: \mathbf{Kom}(\mathbb{k}\mathbf{ChCob}_{/\ell}) \rightarrow \mathbf{Kom}(\mathbf{A})$ and the homology $H(\mathcal{F}Kh(T))$ is an invariant of the tangle T .

For simplicity, we will consider only functors $\mathcal{F}: \mathbb{k}\mathbf{ChCob}_{/\ell}(0) \rightarrow \mathbf{Mod}_{\mathbb{k}}$, producing invariants of links. If we restrict to $\mathbb{Z} \times \mathbb{Z}$ -graded \mathbb{k} -modules and \mathcal{F} preserves degrees of morphisms, then homology groups $H^i(\mathcal{F}Kh(T))$ are \mathbb{Z} -graded (recall, that in Kh we collapse the $\mathbb{Z} \times \mathbb{Z}$ -grading into the \mathbb{Z} -grading, by replacing (a, b) with $a + b$).

Even Khovanov homology. Denote by \mathbb{Z}_{ev} the ring of integers with the trivial action of \mathbb{k} , i.e. all X, Y , and Z act as 1. Then $\mathbb{Z}_{ev} \otimes \mathbb{k}\mathbf{ChCob}$ is the category of ordinary cobordisms, so that all invariants described in [BN05] can be computed from $Kh(L)$. In particular, we can take a functor \mathcal{F}_{ev} that sends a family of s circles in \mathbb{D}^2 into an s -folded tensor product¹³ $A^{\otimes s}$ of a rank 2 module $A = \mathbb{Z}_{ev}v_+ \oplus \mathbb{Z}_{ev}v_-$, graded with $\deg v_+ = (1, 0)$ and $\deg v_- = (0, -1)$. For cobordisms we define \mathcal{F}_{ev} as below

$$(61) \quad \mathcal{F}_{ev} \left(\begin{array}{c} \text{cup} \\ \dots \end{array} \right) : A \otimes A \rightarrow A, \quad \begin{cases} v_+ \otimes v_+ \mapsto v_+, & v_- \otimes v_+ \mapsto v_-, \\ v_+ \otimes v_- \mapsto v_-, & v_- \otimes v_- \mapsto 0, \end{cases}$$

$$(62) \quad \mathcal{F}_{ev} \left(\begin{array}{c} \text{cap} \\ \dots \end{array} \right) : A \rightarrow A \otimes A, \quad \begin{cases} v_+ \mapsto v_- \otimes v_+ + v_+ \otimes v_-, \\ v_- \mapsto v_- \otimes v_-, \end{cases}$$

$$(63) \quad \mathcal{F}_{ev} \left(\begin{array}{c} \text{cup} \\ \dots \end{array} \right) : \mathbb{Z}_{ev} \rightarrow A, \quad \begin{cases} 1 \mapsto v_+, \end{cases}$$

$$(64) \quad \mathcal{F}_{ev} \left(\begin{array}{c} \text{cap} \\ \dots \end{array} \right) : A \rightarrow \mathbb{Z}_{ev}, \quad \begin{cases} v_+ \mapsto 0, \\ v_- \mapsto 1. \end{cases}$$

The above turns A into a Frobenius algebra, so that \mathcal{F}_{ev} is well-defined. Compatibility with the three relations S , T , and $4Tu$ is easy to check [BN05]. The resulting homology $\mathcal{H}_{ev}(L) := H(\mathcal{F}_{ev}Kh(L))$ is the categorification of the Jones polynomial from [Kh99].

Odd Khovanov homology. Assume now that X and Z act on integers as 1, but Y as -1 , and denote this \mathbb{k} -algebra by \mathbb{Z}_{odd} . This choice provides a framework for the odd Khovanov homology [ORS13]. The functor $\mathcal{F}_{odd}: \mathbb{k}\mathbf{ChCob}_{/\ell}(0) \rightarrow \mathbf{Mod}_{\mathbb{k}}$ associates to a family of s circles in \mathbb{D}^2 the exterior algebra $\Lambda_s := \bigwedge^* \mathbb{Z}_{odd}\langle a_1, \dots, a_s \rangle$ with one generator a_i for each circle. A merge of circles labeled a_i and a_j is realized by the canonical projection

¹³ Strictly speaking, one should think of $A^{\otimes s}$ as an orderless tensor product, which makes sense in any symmetric monoidal category. Otherwise, \mathcal{F}_{ev} is defined on objects only up to an isomorphism, since it requires ordering of circles. However, there is a canonical isomorphism induced by the symmetric structure, and coherence result for symmetric monoidal categories implies it is unique. The same issue arises in other examples of functors described in this paper.

$\Lambda_s \longrightarrow \Lambda_s / (a_i - a_j) \cong \Lambda_{s-1}$ that identifies appropriate generators. Dually, splitting a circle into two, labeled a_i and a_j , is given as

$$(65) \quad \Lambda_{s-1} \cong \Lambda_s / (a_i - a_j) \ni [w] \longmapsto (a_i - a_j) \wedge w \in \Lambda_s,$$

assuming the i -th circle in the target configuration is to the left of the framing arrow and the j -th one is to the right. A birth is an inclusion of algebras and an anticlockwise death of an i -th circle is the Kronecker delta function $a_j \longmapsto \delta_{i,j}$ wedged with identity, i.e. it strips off a_i from the element w from the left hand side, if it is present, or sends w to 0 otherwise.

One can directly check that \mathcal{F}_{odd} defined in this way is a functor. It is shown in [ORS13] that $\mathcal{H}_{odd}(L) := H(\mathcal{F}_{odd}Kh(L))$ is an invariant of a link L . The group Λ_s is graded with an element $a_{i_1} \wedge \cdots \wedge a_{i_r}$ in degree $s - 2r$, which makes \mathcal{F}_{odd} a degree-preserving functor. Both a sphere and a torus evaluate to zero ($a_i - a_j$ becomes 0 after merging i -th and j -th circles). and $4Tu$ follows from the table below.

1	0	0	0	0	0
a_1	0	1	1	0	0
a_2	1	0	1	0	0
$a_1 \wedge a_2$	$-a_1$	a_2	0	$a_2 - a_1$	

Therefore, invariance of $\mathcal{F}_{odd}Kh(L)$ also follows from Theorem 7.1.

10. CHRONOLOGICAL FROBENIUS ALGEBRAS

We shall now construct a natural target for a chronological TQFT functor. Choose a commutative ring R and a category of symmetric R -bimodules graded by an abelian group G .

Definition 10.1. Choose a function $\lambda: G \times G \longrightarrow U(R)$ that is a group homomorphism in each variable, where $U(R)$ is the group of invertible elements in R . Define the *graded tensor product* for G -graded modules in the ordinary way, but for homogeneous homomorphisms f and g we define the product $f \otimes g$ by the formula

$$(66) \quad (f \otimes g)(m \otimes n) := \lambda(\deg g, \deg m)f(m) \otimes g(n).$$

There is a *braiding* $\sigma_{M,N}: M \otimes N \longrightarrow N \otimes M$, $m \otimes n \longmapsto \lambda(\deg m, \deg n)n \otimes m$, which is a *symmetry* if $\lambda(a, b)\lambda(b, a) = 1$ for all $a, b \in G$.

The graded tensor product generalizes the Koszul product ($G = \mathbb{Z}_2$ and $\lambda(a, b) = (-1)^{ab}$), and the anyonic braiding ($G = \mathbb{Z}$ and $\lambda(a, b) = \zeta^{ab}$ for some root of unity ζ).

Lemma 10.2. *The following hold*

$$(67) \quad (f' \otimes g') \circ (f \otimes g) = \lambda(\deg g', \deg f)(f' \circ f) \otimes (g' \circ g), \text{ and}$$

$$(68) \quad \sigma_{M',N'} \circ (f \otimes g) = \lambda(\deg f, \deg g)(g \otimes f) \circ \sigma_{M,N}$$

for any homogeneous homomorphisms $M \xrightarrow{f} M' \xrightarrow{f'} M''$ and $N \xrightarrow{g} N' \xrightarrow{g'} N''$.

Proof. Straightforward. □

Example 10.3. The category $\mathbf{Mod}_{\mathbb{k}}$ of $\mathbb{Z} \times \mathbb{Z}$ -graded modules over a commutative ring $\mathbb{k} = \mathbb{Z}[X, Y, Z^{\pm 1}]/(X^2=Y^2=1)$ is a graded tensor category in the above sense with λ defined as $\lambda(a, b, c, d) = X^{ac}Y^{bd}Z^{ad-bc}$.

There is a nice graphical interpretation of the formulas (67) and (66). We represent a homomorphism $f: M \rightarrow N$ by a box labeled f with two legs: one at the bottom, labeled with M , and one at the top, labeled with N . Composition of morphism is given by placing the boxes one over the other and a tensor product of homomorphisms by placing them side by side, the left on the higher level than the right one. Then we have the following relation for homogeneous morphisms f and g :

$$(69) \quad \begin{array}{c} | \\ | \\ \boxed{f} \\ | \end{array} \begin{array}{c} | \\ \boxed{g} \\ | \end{array} = \lambda(\deg g, \deg f) \begin{array}{c} | \\ \boxed{f} \\ | \end{array} \begin{array}{c} | \\ | \\ \boxed{g} \\ | \end{array} .$$

For example, (66) is coherent with the following simple calculation, where we represent an element $m \in M$ of a module M by a box with no input (think of it as a homomorphism $R \rightarrow M$ taking 1 to m):

$$(70) \quad \begin{array}{c} | \\ \boxed{f} \\ | \\ \boxed{m} \\ | \end{array} \begin{array}{c} | \\ | \\ \boxed{g} \\ | \\ \boxed{n} \end{array} \xrightarrow{\cdot \lambda} \begin{array}{c} | \\ \boxed{f} \\ | \\ \boxed{m} \\ | \end{array} \begin{array}{c} | \\ | \\ \boxed{g} \\ | \\ \boxed{n} \end{array} = \begin{array}{c} | \\ \boxed{f(m)} \\ | \end{array} \begin{array}{c} | \\ | \\ \boxed{g(n)} \\ | \end{array}$$

where the arrow $\xrightarrow{\cdot \lambda}$ indicates that the picture to the right must be scaled by $\lambda(\deg g, \deg m)$.

If $\lambda(a, b)\lambda(b, a) = 1$ for all $a, b \in G$, we represent the symmetry $\sigma_{M,N}: M \otimes N \rightarrow N \otimes M$ by a crossing:

$$(71) \quad \begin{array}{c} \diagup \\ \boxed{m} \end{array} \begin{array}{c} \diagdown \\ | \\ \boxed{n} \end{array} = \begin{array}{c} | \\ | \\ \boxed{n} \end{array} \begin{array}{c} | \\ | \\ \boxed{m} \end{array} = \lambda(\deg m, \deg n) \begin{array}{c} | \\ | \\ \boxed{n} \end{array} \begin{array}{c} | \\ | \\ \boxed{m} \end{array}$$

This does not work in the braided case. Indeed, one can first change the heights of boxes labeled m and n , which results in $\sigma(m \otimes n) = \lambda(\deg n, \deg m)^{-1}n \otimes m$. Comparing the two values we conclude it must be $\lambda(\deg n, \deg m)\lambda(\deg m, \deg n) = 1$. One solution to this issue is to add horizontal lines originating at all boxes and pointing leftwards, in which case the relation (69) appears in two versions

$$(72) \quad \begin{array}{c} | \\ | \\ \boxed{g} \\ | \\ \boxed{f} \\ | \end{array} = \begin{array}{c} | \\ | \\ \boxed{f} \\ | \\ \boxed{g} \\ | \end{array} , \quad \text{and}$$

$$(73) \quad \begin{array}{c} | \\ | \\ \boxed{g} \\ | \\ \boxed{f} \\ | \end{array} = \begin{array}{c} | \\ | \\ \boxed{f} \\ | \\ \boxed{g} \\ | \end{array} .$$

Decorating the horizontal lines with degrees of the boxes, we add untwisting relations

$$(74) \quad \begin{array}{c} \text{---}^b \\ \diagup \quad \diagdown \\ \text{---}_a \end{array} = \lambda(a, b) \begin{array}{c} \text{---}^b \\ \text{---} \\ \text{---}_a \end{array} \quad \text{and} \quad \begin{array}{c} \text{---}^b \\ \diagdown \quad \diagup \\ \text{---}_a \end{array} = \lambda(b, a)^{-1} \begin{array}{c} \text{---}^b \\ \text{---} \\ \text{---}_a \end{array}$$

This can be done only at the left edge of the diagram. The product $f \otimes g$ is then represented by the diagram in which the line originating from g passes over the input for f , and we can represent σ by the positive crossing \times . However, the composition of boxes becomes more complicated—one cannot simply join two boxes, unless their horizontal lines pass all other lines in the same way. We shall not go deeper into the braided case, as all graded tensor products considered in this paper are symmetric.

Definition 10.4. Choose a ring S that is a G -graded \mathbb{k} -algebra, and consider the category of G -graded modules over S . We say that

- (1) the ring S is *commutative* if $rs = \lambda(\deg r, \deg s)sr$ for homogeneous elements $r, s \in S$,
- (2) a G -graded bimodule M over S is *symmetric* if $sm = \lambda(\deg s, \deg m)ms$ for homogeneous elements $s \in S, m \in M$, and
- (3) a homogeneous function $f: M \rightarrow N$ between G -graded bimodules over S is *right linear* if $f(ms) = f(m)s$, but *left linear* if $f(sm) = \lambda(\deg f, \deg s)sf(m)$ for a homogeneous element $s \in S$.

If we think of linearity as a commutativity of a map f with the action of S , then the last definition follows easily from the graphical calculus (notice that the actions of S are degree 0 maps):

$$(75) \quad \begin{array}{c} \text{---} \\ | \\ \boxed{f} \\ | \\ \begin{array}{c} \diagup \quad \diagdown \\ \boxed{s} \quad \boxed{m} \end{array} \end{array} = \begin{array}{c} \begin{array}{c} \diagup \quad \diagdown \\ \boxed{s} \quad \boxed{f} \end{array} \\ | \\ \boxed{m} \end{array} \xrightarrow{\cdot \lambda} \begin{array}{c} \begin{array}{c} \diagup \quad \diagdown \\ \boxed{s} \quad \boxed{f} \end{array} \\ | \\ \boxed{m} \end{array} = \begin{array}{c} \begin{array}{c} \diagup \quad \diagdown \\ \boxed{s} \quad \boxed{f(m)} \end{array} \end{array}$$

With these conventions we can define a tensor product of G -graded bimodules $M \otimes_S N$ in the usual way, with actions of S given as $s(m \otimes n) := (sm) \otimes n$ and $(m \otimes n)s := m \otimes (ns)$. If both M and N are symmetric in the graded sense, so is $M \otimes_S N$.

By an analogy to ordinary cobordisms, a chronological TQFT $\mathcal{F}: \mathbf{kChCob}(0) \rightarrow \mathbf{Mod}_{\mathbb{k}}$ is determined by the pair $(\mathcal{F}(\emptyset), \mathcal{F}(\circ))$, a variant of a Frobenius system over \mathbb{k} .

Definition 10.5. Choose an abelian group G and a commutative ring R . A *chronological Frobenius system* in the category \mathbf{Mod}_R with a symmetric G -graded tensor product of type λ is a pair (S, A) of two R -modules such that S is a graded ring and A a symmetric S -bimodule, together with four homogeneous operations, a unit $\eta: S \rightarrow A$, a counit $\epsilon: A \rightarrow S$, a multiplication $\mu: A \otimes_S A \rightarrow A$, and a comultiplication $\Delta: A \rightarrow A \otimes_S A$, subject to the following conditions:

$$(76) \quad \mu \circ (\mu \otimes \text{id}) = \lambda(\deg \mu, \deg \mu)\mu \circ (\text{id} \otimes \mu),$$

$$(77) \quad (\Delta \otimes \text{id}) \circ \Delta = \lambda(\deg \Delta, \deg \Delta)(\text{id} \otimes \Delta) \circ \Delta,$$

$$(78) \quad \mu \circ (\eta \otimes \text{id}) = \text{id}, \quad (\epsilon \otimes \text{id}) \circ \Delta = \text{id},$$

$$(79) \quad \mu \circ \sigma = \lambda(\deg \mu, \deg \mu)\mu, \quad \sigma \circ \Delta = \lambda(\deg \Delta, \deg \Delta)\Delta,$$

$$(80) \quad (\mu \otimes \text{id}) \circ (\text{id} \otimes \Delta) = \lambda(\deg \mu, \deg \Delta)\Delta \circ \mu = (\text{id} \otimes \mu) \circ (\Delta \otimes \text{id}).$$

We call A a *chronological Frobenius algebra* over S .

The conditions for a chronological Frobenius algebra reflect the chronological relations: (76), (77) and (80) are like the connected sum permutations changes, (78) mimics the creation and the annihilation changes, whereas (79) is the orientation reversion. Therefore, this is not a surprise that they give chronological TQFT functors.

Proposition 10.6. *Choose a chronological Frobenius system (S, A) in the category of G -graded modules \mathbf{Mod}_R of type λ . Then there is a group homomorphism $\psi: \mathbb{Z} \times \mathbb{Z} \rightarrow G$, a \mathbb{k} -algebra structure on R , and a \mathbb{k} -linear functor $\mathcal{F}_A: \mathbf{kChCob} \rightarrow \mathbf{Mod}_R$ that sends a family of s circles to the tensor product $A^{\otimes s}$ and*

$$(81) \quad \mathcal{F}_A \left(\text{Diagram} \right) = \left(\mu: A \otimes A \rightarrow A \right), \quad \mathcal{F}_A \left(\text{Diagram} \right) = \left(\eta: S \rightarrow A \right),$$

$$(82) \quad \mathcal{F}_A \left(\text{Diagram} \right) = \left(\Delta: A \rightarrow A \otimes A \right), \quad \mathcal{F}_A \left(\text{Diagram} \right) = \left(\epsilon: A \rightarrow S \right).$$

This functor is graded in the sense that $\deg \mathcal{F}(W) = \psi(\deg W)$ for a cobordism W .

Proof. The condition $\deg \mathcal{F}(W) = \psi(\deg W)$ requires $\psi(1, 0) = \deg \eta$ and $\psi(0, 1) = \deg \epsilon$, while the ring homomorphism $\mathbb{k} \rightarrow R$ is determined by λ as below:

$$X \mapsto \lambda(\deg \mu, \deg \mu), \quad Y \mapsto \lambda(\deg \Delta, \deg \Delta), \quad Z \mapsto \lambda(\deg \mu, \deg \Delta).$$

It remains to check that \mathcal{F}_A preserves the chronological relations. Most cases follow from (66) and conditions (76)–(80), with the exception of \times - and \diamond -changes. The former follows from (79), as an \times -change adds a twist on one side of the cobordism. In the latter both cobordisms are equivalent, so it is enough to show that $1 - XY$ annihilates $\mu \circ \Delta$. This follows from (79): $\mu \circ \Delta = XY(\mu \circ \sigma) \circ (\sigma \circ \Delta) = XY\mu \circ \sigma^2 \circ \Delta = XY\mu \circ \Delta$. \square

Example 10.7 (Covering Khovanov homology). Let $S := \mathbb{k}$ and take $A := \mathbb{k}v_+ \oplus \mathbb{k}v_-$. As before, we grade A by setting $\deg v_+ = (1, 0)$ and $\deg v_- = (0, -1)$, and we equip it with the following operations



$$(83) \quad \mu: A \otimes A \rightarrow A, \quad \begin{cases} v_+ \otimes v_+ \mapsto v_+, & v_- \otimes v_+ \mapsto XZv_-, \\ v_+ \otimes v_- \mapsto v_-, & v_- \otimes v_- \mapsto 0, \end{cases}$$

$$(84) \quad \Delta: A \rightarrow A \otimes A, \quad \begin{cases} v_+ \mapsto v_- \otimes v_+ + YZv_+ \otimes v_-, \\ v_- \mapsto v_- \otimes v_-, \end{cases}$$

$$(85) \quad \eta: \mathbb{k} \rightarrow A, \quad \{ 1 \mapsto v_+, \}$$

$$(86) \quad \epsilon: A \rightarrow \mathbb{k}, \quad \begin{cases} v_+ \mapsto 0, \\ v_- \mapsto 1. \end{cases}$$

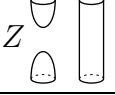
One can directly check that conditions (76)–(80) hold. The induced functor \mathcal{F}_{cov} clearly satisfies the sphere relation and a direct calculation shows that a standard torus evaluates to $Z(X + Y)$. Finally, the $4Tu$ relation follows from the table below.

				
$v_+ \otimes v_+$	0	0	0	0
$v_+ \otimes v_-$	$Xv_+ \otimes v_+$	0	$Xv_+ \otimes v_+$	0
$v_- \otimes v_+$	0	$Zv_+ \otimes v_+$	$Zv_+ \otimes v_+$	0
$v_- \otimes v_-$	$Yv_- \otimes v_+$	$Zv_+ \otimes v_-$	0	$Yv_- \otimes v_+ + Zv_+ \otimes v_-$

Therefore, this algebra defines a functor $\mathcal{F}: \mathbf{kChCob}/\ell \rightarrow \mathbf{Mod}_{\mathbf{k}}$. We call the invariant $\mathcal{H}_{cov}(L) := H(\mathcal{F}_{cov}Kh(L))$ the *covering Khovanov homology* of the link L .

Recall we defined two \mathbf{k} -module structure on \mathbb{Z} , depending on the actions of the generators $X, Y, Z \in \mathbf{k}$: all three act as 1 in \mathbb{Z}_{ev} , but Y acts as -1 in \mathbb{Z}_{odd} . The following proposition explains the name *covering homology*.

Proposition 10.8. *For any link L there are isomorphisms*

$$(87) \quad \mathcal{H}_{ev}(L) \cong \mathcal{H}_{cov}(L; \mathbb{Z}_{ev}) \quad \text{and} \quad \mathcal{H}_{odd}(L) \cong \mathcal{H}_{cov}(L; \mathbb{Z}_{odd}),$$

where $\mathcal{H}_{cov}(L; M) := H(\mathcal{F}_{cov}Kh(L) \otimes M)$ for any \mathbf{k} -module M .

Proof. The first isomorphism follows directly from the construction: replacing X, Y and Z with 1's in the definition of the algebra A results in the Khovanov algebra. For the second one it is enough to show that functors $\mathcal{F}_{cov}(-) \otimes \mathbb{Z}_{odd}$ and \mathcal{F}_{odd} are equivalent. This follows from applying an isomorphism $i: A^{\otimes s} \otimes \mathbb{Z}_{odd} \rightarrow \Lambda_s$ that sends any v_+ into 1 and v_- at the i -th position to a_i . Comparing the two definitions, one can easily see that $\mathcal{F}_{odd}(M) = i \circ (\mathcal{F}_{cov}(M) \otimes \mathbb{Z}_{odd}) \circ i^{-1}$ for any generating cobordism M . \square

The above proposition is an example of a more general operation called a *base change*: given a chronological Frobenius system (S, A) in \mathbf{Mod}_R and a symmetric R -module S' , which is also a ring, together with a degree zero homomorphism of R -algebras $S \rightarrow S'$, the pair (S', A') with $A' := A \otimes_S S'$ is another chronological Frobenius system, called a *base change* of (S, A) . Clearly, $H(\mathcal{F}_{A'}) \cong H(\mathcal{F}_A; S')$.

Example 10.9. One of the consequences of the $4Tu$ relation is the following equality

$$(88) \quad Z(X + Y) \left[\text{cylinder} \right] = \left[\text{cup} \right] + \left[\text{cap} \right],$$

called a neck-cutting relation. Again, we omitted the orienting arrows, but the convention is to orient all death clockwise, merges with arrow pointing leftwards, and splits with arrows pointing to the back. If we impose the relation $X + Y = 0$, we can use (88) to move handles freely between components of a cobordism (up to multiplication by XZ^a). A similar theory over the two-element field \mathbb{F}_2 was analyzed in [BN05], suggesting we have found its lift to \mathbb{Z} in the odd setting. Namely, we have an algebra $A_H := \text{Mor}(\bigcirc, \bigcirc)$ over the ring $R_H := \mathbb{Z}[H, X, Z^{\pm 1}]/(2H, X^2 - 1)$, where H has degree $(-1, -1)$ and represents a handle. Unfortunately, H is a torsion element, as it is annihilated by $1 - XY = 1 + X^2 = 2$. One can check that A_H is a free module generated by v_+ and v_- of degrees $(1, 0)$ and $(0, -1)$ respectively, with multiplication and comultiplication given by the formulas

$$(89) \quad \mu: A_H \otimes A_H \rightarrow A_H, \quad \begin{cases} v_+ \otimes v_+ \mapsto v_+, & v_- \otimes v_+ \mapsto XZv_-, \\ v_+ \otimes v_- \mapsto v_-, & v_- \otimes v_- \mapsto Hv_-, \end{cases}$$

$$(90) \quad \Delta: A_H \longrightarrow A_H \otimes A_H, \quad \begin{cases} v_+ \longmapsto v_- \otimes v_+ + XZv_+ \otimes v_- - HXZ^{-1}v_+ \otimes v_+, \\ v_- \longmapsto v_- \otimes v_-. \end{cases}$$

The generator v_+ is represented by a death followed by a birth and v_- by a vertical cylinder. In tensor products, each v_+ is represented by a birth and all other circles are boundaries of a single component built from splits only (or a single death, if there is no v_-). See [BN05] for details.

We shall end this section with a proof of the nondegeneracy result for chronological cobordisms. For that we define a universal rank 2 Frobenius system, with scalars in a $\mathbb{Z} \times \mathbb{Z}$ -graded commutative ring

$$(91) \quad R_U := \mathbb{k}[a, c, e, f, t, h] / \left(\begin{array}{l} (XY - 1)h, (XY - 1)t, af + ce, \\ ae + ce h + YZcft - 1 \end{array} \right)$$

where $\deg a = \deg e = (0, 0)$, $\deg c = \deg f = (1, 1)$, $\deg h = (-1, -1)$ and $\deg t = (-2, -2)$. The element $XY - 1$ annihilates not only polynomials in h and t , but also c^2 and f^2 due to the graded commutativity, see Definition 10.4. Consider a rank two chronological Frobenius algebra A_U over R_U with the following operations:

$$(92) \quad \begin{cases} \mu(v_+ \otimes v_+) = v_+, & \mu(v_- \otimes v_+) = XZv_-, \\ \mu(v_+ \otimes v_-) = v_-, & \mu(v_- \otimes v_-) = hv_- + tv_+, \end{cases}$$

$$(93) \quad \begin{cases} \Delta(v_+) = (ft - YZ^{-1}eh)v_+ \otimes v_+ + e(v_- \otimes v_+ + YZv_+ \otimes v_-) + Z^2fv_- \otimes v_-, \\ \Delta(v_-) = Z^{-2}etv_+ \otimes v_+ + ft(YZ^{-1}v_- \otimes v_+ + v_+ \otimes v_-) + (e + fh)v_- \otimes v_-, \end{cases}$$

$$(94) \quad \begin{cases} \eta(1) = v_+, \end{cases}$$

$$(95) \quad \begin{cases} \epsilon(v_+) = c, \\ \epsilon(v_-) = a. \end{cases}$$

It is a graded version of the system (R_4, A_4) in [Kh04] and it has the same universality property. The following proposition is proven in the same way as Proposition 4 in [Kh04].

Proposition 10.10. *Let (R', A') be a homogeneous chronological Frobenius system in $\mathbf{Mod}_{\mathbb{k}}$ of rank two. Then there is a unique graded ring homomorphism $R_U \longrightarrow R'$ such that $A' \cong A \otimes_{R_U} R'$.*

We are now ready to prove the nondegeneracy result for $\mathbb{k}\mathbf{ChCob}(0)$.

Proof of Theorem 4.15. Given a chronological cobordism W we want to compute the group $\text{Aut}(W) := \{k \in \mathbb{k} \mid kW = W\}$; its elements are products of values of ι , hence, they are invertible.

We shall first show that $\text{Aut}(W)$ is a subgroup of $\{1, XY\}$. For that take a graded ring $R_1 = R_U / (X - Y, a, e, h) = \mathbb{Z}[X, Z^{\pm 1}, c, f, t] / (X^2 = XZcft = 1)$, and consider a chronological Frobenius system (R_1, A_1) with $A_1 = A_U \otimes R_1$. It has the following operations:

$$(96) \quad \begin{cases} \mu(v_+ \otimes v_+) = v_+, & \mu(v_- \otimes v_+) = XZv_-, \\ \mu(v_+ \otimes v_-) = v_-, & \mu(v_- \otimes v_-) = tv_+, \end{cases} \quad \begin{cases} \eta(1) = v_+, \end{cases}$$

$$(97) \quad \begin{cases} \Delta(v_+) = ftv_+ \otimes v_+ + Z^2fv_- \otimes v_-, \\ \Delta(v_-) = ftv_+ \otimes v_- + XZ^{-1}ftv_- \otimes v_+, \end{cases} \quad \begin{cases} \epsilon(v_+) = c, \\ \epsilon(v_-) = 0. \end{cases}$$

In particular, $\mu(\Delta(v_+)) = (1 + Z^2)ftv_+$. Since c , f , and t are invertible and polynomials in Z are not zero divisors, it follows $\mathcal{F}_1(W)$ is not a zero divisor for any closed surface W . This implies $\text{Aut}(W)$ is a subgroup of $\{1, XY\}$. If $\partial W \neq \emptyset$, create a closed surface \widehat{W} by capping its boundary components with births and deaths. Then $\text{Aut}(W) \subset \text{Aut}(\widehat{W})$, as every 2-morphism $\varphi: W \Rightarrow W$ in $\mathbf{ChCob}^e(0)$ extends to \widehat{W} in a way that preserves the value of ι (juxtapose φ with the identity 2-morphisms on the caps).

Now assume W is a surface of genus 0 with at most one closed component. Choose the graded ring $R_2 := R_U/(c^2, a-1, e-1, h) \cong \mathbb{k}[c, t]/(c^2, (XY-1)t)$ and consider a chronological Frobenius system (R_2, A_2) with $A_2 = A_U \otimes R_2$. In particular, the unit and counit are given by formulas

$$(98) \quad \eta(1) = v_+, \quad \epsilon(v_+) = c, \quad \epsilon(v_-) = 1,$$

and a sphere is evaluated to c . Create \widehat{W} by capping some inputs and outputs of W so that, up to a change of a chronology, \widehat{W} is a disjoint union of caps and at most one spherical component. The homomorphism $\mathcal{F}_2(\widehat{W}): A^{\otimes k} \rightarrow A^{\otimes \ell}$ takes $(v_-)^{\otimes k}$ to $(v_+)^{\otimes \ell}$ or $c(v_+)^{\otimes \ell}$, perhaps multiplied by a monomial in X , Y and Z . Since none of $r \in \mathbb{k}$ annihilates c , $(1-r)W = 0$ implies $r = 1$, which shows the group $\text{Aut}(\widehat{W})$ is trivial. \square

11. DOTTED COBORDISMS

A very generic example of a chronological Frobenius algebra is given by the tautological functor $\text{Mor}(\Sigma, _)$, where Σ is any object of $\mathbb{k}\mathbf{ChCob}(0)$.

Proposition 11.1. *Given an object $\Sigma \in \mathbb{k}\mathbf{ChCob}(0)$, the group of morphisms $\text{Mor}(\Sigma, \emptyset)$ is a ring with multiplication induced by the ‘right-then-left’ disjoint sum and $\text{Mor}(\Sigma, \bigcirc)$ is a chronological Frobenius algebra over $\text{Mor}(\Sigma, \emptyset)$.*

The case $\Sigma = \bigcirc$ was analyzed in Example 10.9 under the assumption $X+Y=0$, in which case $\text{Mor}(\bigcirc, \bigcirc)$ was a free rank 2 module over $\text{Mor}(\bigcirc, \emptyset) \cong \mathbb{Z}[H, X, Z^{\pm 1}]/(2H, X^2-1)$. However, the rank of $\text{Mor}(\Sigma, \bigcirc)$ over $\text{Mor}(\Sigma, \emptyset)$ is in general infinite, but the neck-cutting relation (88) suggests a way how to reduce it to the finite case.

Definition 11.2. The category $\mathbb{k}\mathbf{ChCob}_\bullet(k)$ consists of chronological cobordisms (with $2k$ vertical boundary lines) and dots on regular levels. A single dot has a degree $(-1, -1)$ and two dots cannot lie on the same level. In addition to chronological relations, we allow dots to move past other dots and critical points at the cost specified by λ , and we impose the following three local relations:

$$(S) \quad \begin{array}{c} \text{---} \\ \circ \\ \text{---} \end{array} = 0, \quad (D) \quad \begin{array}{c} \bullet \\ \circ \\ \text{---} \end{array} = 1,$$

$$(N) \quad \begin{array}{c} \text{---} \\ | \\ \text{---} \end{array} = \begin{array}{c} \text{---} \\ \cup \\ \text{---} \end{array} + \begin{array}{c} \bullet \\ \text{---} \\ \cup \\ \text{---} \end{array} - \begin{array}{c} \bullet \\ \text{---} \\ \circ \\ \text{---} \\ \bullet \\ \text{---} \\ \cup \\ \text{---} \end{array}.$$

where all deaths are oriented clockwise.

Dots are a part of the chronological structure and one can think of them as ‘infinitesimal’ handles, which are ‘frozen’, so that a dot is not annihilated by $1 - XY$. But a cobordism

with two dots on one component is, because permuting two dots costs XY . All relations are homogeneous, thence coherent with changes of chronologies. Even more: the neck cutting relation N together with the cubical structure of the disjoint sum determines all coefficients for changes of chronologies, except the \diamond -change. For example,

where we moved dots in the middle pictures from the birth to the top by the cost of Z^2 . Dotted cobordisms satisfy also the other relations from $\mathbb{k}\mathbf{ChCob}_{/\ell}(k)$. Hence, we can think of $\mathbb{k}\mathbf{ChCob}_{\bullet}(k)$ as an abelian extension of $\mathbb{k}\mathbf{ChCob}_{/\ell}(k)$.

Lemma 11.3. *Relations T and $4Tu$ follow from S , D and N . Therefore, there are natural functors $\mathbb{k}\mathbf{ChCob}_{/\ell}(k) \rightarrow \mathbb{k}\mathbf{ChCob}_{\bullet}(k)$.*

Proof. For the T relation take a standard torus and cut its handle. In the resulting expression, one term has a sphere as its component and the other two can be reduced to dotted spheres by changing chronologies:

(99)

The $4Tu$ relation is proved in a similar way, by cutting the unique tube in each term. Again, by changing chronologies we can reduce each term to four caps, with left caps smaller than the right ones, possibly with a two-dotted sphere in the middle:

(100)

$$(101) \quad Z \begin{array}{c} \text{cup} \\ \text{cylinder} \\ \text{cap} \end{array} = Z \begin{array}{c} \text{cup} \\ \text{cup} \\ \text{cap} \end{array} + Z \begin{array}{c} \text{cup} \\ \text{cup} \\ \text{cap} \end{array} - Z \begin{array}{c} \text{cup} \\ \text{cup} \\ \text{cap} \end{array},$$

$$(102) \quad X \begin{array}{c} \text{cup} \\ \text{cup} \\ \text{cap} \end{array} = X \begin{array}{c} \text{cup} \\ \text{cup} \\ \text{cap} \end{array} + Z \begin{array}{c} \text{cup} \\ \text{cup} \\ \text{cap} \end{array} - XYZ \begin{array}{c} \text{cup} \\ \text{cup} \\ \text{cap} \end{array},$$

$$(103) \quad Y \begin{array}{c} \text{cup} \\ \text{cup} \\ \text{cap} \end{array} = Y \begin{array}{c} \text{cup} \\ \text{cup} \\ \text{cap} \end{array} + Z \begin{array}{c} \text{cup} \\ \text{cup} \\ \text{cap} \end{array} - XYZ \begin{array}{c} \text{cup} \\ \text{cup} \\ \text{cap} \end{array}.$$

Because a two-dotted sphere is annihilated by $(XY - 1)$, the sum of right hand sides of (100) and (101) is equal to the sum of right hand sides of (102) and (103). \square

The additive closure $\text{Mat}(\mathbb{k}\mathbf{ChCob}_\bullet(0))$ is equivalent to a category of finitely generated free graded symmetric bimodules over a certain ring. This follows from the proposition below.

Proposition 11.4 (Delooping). *The following two morphisms*

$$(104) \quad \begin{array}{ccc} & \begin{array}{c} \text{cup} \\ \text{cap} \end{array} & \emptyset\{-1\} \\ & \nearrow & \searrow \\ \circ & & \circ \\ & \ominus & \\ & \searrow & \nearrow \\ & \begin{array}{c} \text{cup} \\ \text{cap} \end{array} & \emptyset\{+1\} \end{array}$$

form a pair of inverse isomorphisms in the additive closure $\text{Mat}(\mathbb{k}\mathbf{ChCob}_\bullet)$.

Proof. Call the left map f and the right one g . The equality $g \circ f = \text{id}$ is exactly the neck-cutting relation N , whereas the other composition is the identity 2×2 matrix—this follows directly from relations D and S . \square

Corollary 11.5. *The tautological functor $\text{Mor}(\emptyset, _): \mathbb{k}\mathbf{ChCob}_\bullet(0) \rightarrow \mathbf{Mod}_{R'}$ is full and faithful, where $R' := \text{Mor}(\emptyset, \emptyset)$. Hence, we can identify $\mathbb{k}\mathbf{ChCob}_\bullet(0)$ with the category of finitely generated free graded symmetric $\text{Mor}(\emptyset, \emptyset)$ -bimodules.*

We shall now compute a presentation of the ring $\text{Mor}(\emptyset, \emptyset)$.

Proposition 11.6. *There is an isomorphism of graded commutative rings*

$$(105) \quad \text{Mor}(\emptyset, \emptyset) \cong R_\bullet := \mathbb{k}[h, t] / ((XY-1)t, (XY-1)h),$$

where $\deg h = (-1, -1)$ and $\deg t = (-2, -2)$, such that

$$(106) \quad \begin{array}{c} \text{cup} \\ \text{cap} \end{array} \mapsto h \quad \text{and} \quad \begin{array}{c} \text{cup} \\ \text{cup} \\ \text{cap} \end{array} \mapsto XZt + h^2.$$

Proof. It is enough to show that the above defines a homomorphism—it is clearly invertible if it exists. We begin with constructing a graded monoidal functor $\mathcal{F}_\bullet: \mathbb{k}\mathbf{ChCob}_\bullet \rightarrow \mathbf{Mod}_{R_\bullet}$.

For that take a free rank two symmetric bimodule $A_\bullet = R_\bullet v_+ \oplus R_\bullet v_-$ with $\deg v_+ = (1, 0)$ and $\deg v_- = (0, -1)$ as usual. This module is a chronological Frobenius algebra with operations

$$(107) \quad \mu: A_\bullet \otimes A_\bullet \longrightarrow A_\bullet, \quad \begin{cases} v_+ \otimes v_+ \mapsto v_+, & v_- \otimes v_+ \mapsto XZv_-, \\ v_+ \otimes v_- \mapsto v_-, & v_- \otimes v_- \mapsto tv_+ + hv_-, \end{cases}$$

$$(108) \quad \Delta: A_\bullet \longrightarrow A_\bullet \otimes A_\bullet, \quad \begin{cases} v_+ \mapsto v_- \otimes v_+ + YZv_+ \otimes v_- - YZ^{-1}hv_+ \otimes v_+, \\ v_- \mapsto v_- \otimes v_- + Z^{-2}tv_+ \otimes v_+, \end{cases}$$

$$(109) \quad \eta: R_\bullet \longrightarrow A_\bullet, \quad \{1 \mapsto v_+,$$

$$(110) \quad \epsilon: A_\bullet \longrightarrow R_\bullet, \quad \begin{cases} v_+ \mapsto 0, \\ v_- \mapsto 1 \end{cases}$$

These tell us how to define \mathcal{F}_\bullet on all generators except one, a cylinder decorated with a dot. Associate to it the following homomorphism:

$$(111) \quad \theta: A_\bullet \longrightarrow A_\bullet, \quad \begin{cases} v_+ \mapsto v_-, \\ v_- \mapsto XZ^{-1}(tv_+ + hv_-) = v_+tXZ + v_-h. \end{cases}$$

Clearly, $\epsilon \circ \eta = 0$ and $\epsilon \circ \theta \circ \eta = 1$, so that \mathcal{F}_\bullet preserves relations S and T . It remains to show that \mathcal{F}_\bullet is also coherent with the neck-cutting relation N . This follows from computing the terms on the right hand side of N :

$$(112) \quad \begin{array}{c} \text{cup} \\ \text{dot} \\ \text{dots} \end{array} : A_\bullet \longrightarrow A_\bullet, \quad \begin{cases} v_+ \mapsto v_+, \\ v_- \mapsto v_+ \cdot h, \end{cases}$$

$$(113) \quad \begin{array}{c} \text{cup} \\ \text{dot} \\ \text{dots} \end{array} : A_\bullet \longrightarrow A_\bullet, \quad \begin{cases} v_+ \mapsto 0, \\ v_- \mapsto v_-, \end{cases}$$

$$(114) \quad \begin{array}{c} \text{cup} \\ \text{dot} \\ \text{dot} \\ \text{dots} \end{array} : A_\bullet \longrightarrow A_\bullet, \quad \begin{cases} v_+ \mapsto 0, \\ v_- \mapsto v_+ \cdot h. \end{cases}$$

Summing the first two and subtracting the last homomorphism results in the identity on A_\bullet . The functor \mathcal{F}_\bullet induces a homomorphism $\varphi: \text{Mor}(\emptyset, \emptyset) \longrightarrow R_\bullet$ by associating an element from the ring to any closed surface with dots. In particular, we compute

$$(115) \quad \varphi \left(\begin{array}{c} \text{dot} \\ \text{dot} \end{array} \right) = h \quad \text{and} \quad \varphi \left(\begin{array}{c} \text{dot} \\ \text{dot} \\ \text{dot} \end{array} \right) = XZt + h^2,$$

which is the desired homomorphism. \square

Remark 11.7. Similarly to the even case, dotted cobordisms lead us to a deformation of odd theory, although both t and h are torsion elements: $2t = 2h = 0$ if $XY = -1$. In particular, we cannot set $t = 1$ to obtain Lee deformation, unless we work with \mathbb{Z}_2 coefficients.

The homology theory defined by the algebra A_\bullet is universal: it carries the most information among all chronological Frobenius algebras producing link homology. The proof follows the argument from [Kh04] and it is based on the following observation.

Given a chronological Frobenius algebra A and an invertible element $y \in A$ of degree $(1, 0)$, we can twist its coalgebra structure by y as follows:

$$(116) \quad \epsilon'(a) := \epsilon(ya), \quad \Delta'(a) := \Delta(y^{-1}a).$$

If Δ and ϵ are homogeneous, so are their twisted version Δ' and ϵ' . The degrees are not changed. Because $\deg y = -\deg \mu$, there is an equality $\Delta(y^{-1}a) = y^{-1}\Delta(a)$:

$$(117) \quad \begin{array}{c} \text{---} \\ | \\ \boxed{\Delta} \\ | \\ \boxed{\mu} \\ | \\ \boxed{y^{-1}} \\ | \end{array} = Z^{-1} \begin{array}{c} \text{---} \\ | \\ \boxed{\mu} \\ | \\ \boxed{y^{-1}} \\ | \end{array} \begin{array}{c} \text{---} \\ | \\ \boxed{\Delta} \\ | \end{array} = \begin{array}{c} \text{---} \\ | \\ \boxed{\mu} \\ | \\ \boxed{y^{-1}} \\ | \end{array} \begin{array}{c} \text{---} \\ | \\ \boxed{\Delta} \\ | \end{array}$$

Lemma 11.8 (cf. [Kh04]). *Assume that \mathcal{F} and \mathcal{F}' are two functors induced by an algebra A and its twisted version A' . Then the complexes $\mathcal{F}Kh(L)$ and $\mathcal{F}'Kh(L')$ are isomorphic.*

Proof. Consider cubes $\mathcal{F}\mathcal{I}^\epsilon(L)$ and $\mathcal{F}'\mathcal{I}^\epsilon(L)$, both corrected by a sign assignment ϵ . They have the same R -modules in vertices and the only difference is in edges labeled with comultiplications. The isomorphism is constructed inductively, starting with the identity homomorphism on the initial vertex $(0, \dots, 0)$ and applying the following rule at every face:

$$(118) \quad \begin{array}{ccc} \mathcal{F}\mathcal{I}_\xi & \xrightarrow{f} & \mathcal{F}'\mathcal{I}_{\xi'} \\ \downarrow \mu & & \downarrow \mu \\ \mathcal{F}\mathcal{I}_{\xi'} & \xrightarrow{f} & \mathcal{F}'\mathcal{I}_\xi \end{array} \quad \begin{array}{ccc} \mathcal{F}\mathcal{I}_\xi & \xrightarrow{f} & \mathcal{F}'\mathcal{I}_{\xi'} \\ \downarrow \Delta & & \downarrow \Delta \\ \mathcal{F}\mathcal{I}_{\xi'} & \xrightarrow{y^{-1} \cdot f} & \mathcal{F}'\mathcal{I}_\xi \end{array}$$

where in the case of a split we multiply by y^{-1} the element from the copy of A corresponding to the circle that appears to the left of the split. \square

Theorem 11.9. *Any homogeneous rank two chronological Frobenius system (R', A') in \mathbf{Mod}_R is obtained from (R_\bullet, A_\bullet) by a base change and a twist. In particular, $\mathcal{H}_\bullet(L) := H(\mathcal{F}_\bullet Kh(L))$ is the most general link homology theory in our framework.*

Proof. Recall the Frobenius system (R_U, A_U) is universal with respect to the base change operation. An element $y = ev_+ + YZfv_- \in A_U$ is invertible and of degree $(1, 0)$, with an inverse $y^{-1} = (a + ch)v_+ - YZcv_-$. The dotted algebra A_\bullet arises as the twisting of (R_U, A_U) by this element. \square

12. ODDS AND ENDS

Tangle cobordisms. Let $\mathbf{Cob}^4(k)$ be the category of tangles with $2k$ endpoints and tangle cobordisms between them, i.e. surfaces $W \subset \mathbb{D}^3 \times I$ with its boundary decomposing into the input and the output tangles $T_i \subset \mathbb{D}^3 \times \{i\}$, $i = 0, 1$, and vertical lines on $\partial\mathbb{D}^3 \times I$. In particular, cobordisms between empty links are 2-knots.

There is a presentation of $\mathbf{Cob}^4(k)$ due to Carter and Saito [CS98] using *movies*: sequences of sections of W cutting the cobordism into simple pieces, each with at most one singularity. There are nine singularities, corresponding to nine generators: the three Reidemeister moves (each represents two generators), a saddle move, a birth, and a death (see Fig. 10). They are subject to a number of relations, called *movie moves*, that represent isotopic cobordisms, see [CS98].

The even Khovanov homology $\mathcal{H}_{ev}(L)$ was proven to be functorial up to sign [Ja04, Kh02, BN05], and corrected later to a functor [CMW09, Bla10]. This means there is a chain map $Kh(W): Kh(L_0) \rightarrow Kh(L_1)$ for any surface $W \subset \mathbb{R}^3 \times I$ with L_0 and L_1 as its boundary, $L_i \subset \mathbb{R}^3 \times \{i\}$.

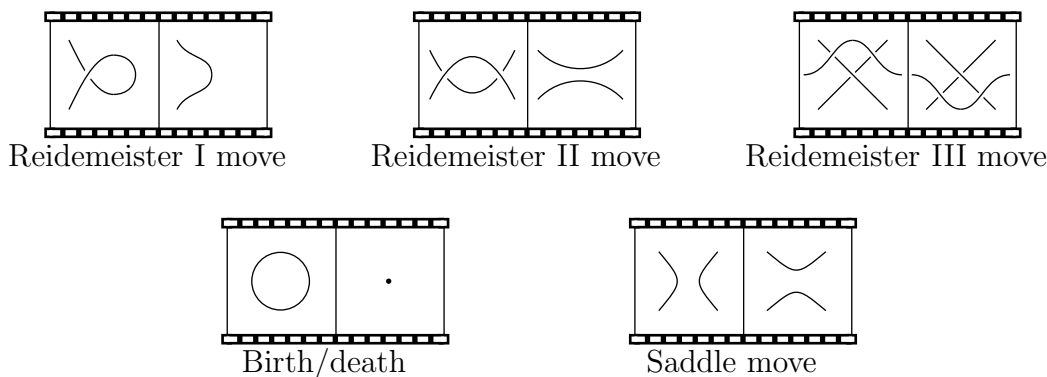

FIGURE 10. Movie diagrams for generator of $\mathbf{Cob}^4(k)$. Each diagram represents up to two generators, depending on the direction in which the movie is watched.

It is not obvious how functoriality should be understood for odd homology. For instance, consider a cobordism $W: \bigcirc\bigcirc \implies \emptyset$ from the two-component unlink to an empty diagram given by two deaths. Depending on how we decompose W into simple pieces (i.e. which link component vanishes first), we obtain two chain maps that differ by Y . One can try to show Kh is a weak 2-functor, where movie moves are 2-morphisms in $\mathbf{Cob}^4(k)$. However, this approach requires understanding of higher singularities of embedded cobordisms.

Functoriality up to ‘sign’ of the generalized Khovanov complex $Kh(_)$, where by a ‘sign’ we mean any degree 0 invertible element of \mathbb{k} , is more promising. One can try to modify the proof of the even case presented in [BN05], showing that for most tangles the automorphism groups of $Kh(T)$ are multiplies of the identity map. We can define the chain maps for generators as in the table below.

Movie	Chain map on $Kh(D)$
Reidemeister moves	Homotopy equivalences from Theorem 7.1
Saddle move	The chain map $[[\times]]: [[\sphericalangle]] \rightarrow [[\rangle\langle]]\{1\}$ obtained from the cube or resolutions of the tangle \times .
Birth/death move	The chain maps induced by births and clockwise deaths.

The last chain map requires some explanation. Consider a morphism $b: \mathcal{I}^\epsilon(T) \longrightarrow \mathcal{I}^\epsilon(T \sqcup \bigcirc)$ of anticommutative cubes with each component b_ξ given by a birth. They do not commute with edge morphisms of the cubes, but we can fix it by the same argument we used in the proof of Theorem 7.1: scale b_ξ by $\lambda((1, 0), \text{chdeg } W)$, where $W \subset \mathbb{D}^2 \times I$ is a cobordism given by any path from the initial vertex $(0, \dots, 0)$ to ξ . In a similar way we define the chain map for a death.

Unfortunately, the proof of functoriality in [BN05] does not translate immediately to our setting—the problem is with Lemma 8.8, which states that a tangle T is Kh -simple (i.e. the only automorphisms of $Kh(T)$ are $\pm \text{id}$) if TX is such (TX is the tangle obtained from T by adding one extra crossing along its boundary). Functoriality of planar operations is used in the original proof, the property that does not hold in our setting. However, we believe this can be fixed with some generalization of the argument used in the proof of Theorem 7.1.

Conjecture 12.1. *The above defines a ‘functor’ $Kh: \mathbf{Cob}^4(k) \rightarrow \mathbf{Kom}(\mathbb{k}\mathbf{ChCob}/\ell(k))$ that assigns to a tangle T the generalized Khovanov complex $Kh(T)$ and to a tangle cobordism W a chain map $Kh(W): Kh(T) \rightarrow Kh(T')$, defined up to a global invertible scalar.*

◇-change revisited. The choice we used to assign a coefficient for a ◇-change is not the only one. We might as well assign 1 to the diagram with the outer arrow pointing to the right and XY for the other case, and ι would still be coherent with all relations between elementary changes of chronologies. The new commutativity cocycle $\bar{\psi}$ has the same values as ψ , except that

$$(119) \quad \bar{\psi} \left(\begin{array}{c} \text{↻} \\ \uparrow \\ \text{↻} \end{array} \right) = XY \quad \text{and} \quad \bar{\psi} \left(\begin{array}{c} \text{↻} \\ \uparrow \\ \text{↻} \end{array} \right) = 1.$$

We shall now prove that the corrected cube of resolutions does not depend on which commutativity cocycle we choose. Unfortunately, there is a gap in the original proof from [ORS13], noticed by Cotton Seed: given a sign assignment ϵ with $d\epsilon = \psi$ the authors of [ORS13] constructed $\bar{\epsilon}$ with $d\bar{\epsilon} = \bar{\psi}$, but an isomorphism of cubes $\mathcal{I}^\epsilon(T) \cong \mathcal{I}^{\bar{\epsilon}}(T)$ is missing. We found such an isomorphism only when T is a link and the cube $\mathcal{I}^\epsilon(T)$ is regarded as a diagram in $\mathbb{k}\mathbf{ChCob}(0)$,¹⁴ which is enough for the odd theory, but leaves the case of nested theories open.

Proposition 12.2. *Given a link diagram D choose sign assignments ϵ and $\bar{\epsilon}$ for the cube $\mathcal{I}(D)$ with respect to the cocycles ψ and $\bar{\psi}$ respectively. Then there is an isomorphism of cubes $\mathcal{I}^\epsilon(D) \cong \mathcal{I}^{\bar{\epsilon}}(D)$, regarded as diagrams in $\mathbb{k}\mathbf{ChCob}(0)$.*

Proof. Instead of constructing $\bar{\epsilon}$ we shall alter the diagram D into D' , so that $\delta\epsilon = \bar{\psi}$ for D' . Color the diagram D black and white in a checkerboard fashion. Given a set of arrows orienting crossings, reverse every arrow between white regions:

$$(120) \quad \begin{array}{ccc} \begin{array}{c} \text{↗} \\ \text{↘} \\ \text{↗} \end{array} & \leftrightarrow & \begin{array}{c} \text{↘} \\ \text{↗} \\ \text{↘} \end{array} \end{array} \quad \begin{array}{ccc} \begin{array}{c} \text{↘} \\ \text{↗} \\ \text{↘} \end{array} & \leftrightarrow & \begin{array}{c} \text{↗} \\ \text{↘} \\ \text{↗} \end{array} \end{array}$$

to obtain a new decorated diagram D' . This operation preserves all the diagrams from Tab. 1, except the two shown in (119), which are exchanged. Hence, $\delta\epsilon := \bar{\psi}$ for D' . We construct an isomorphism $s: \mathcal{I}_{\text{gr}}^\epsilon(D) \cong \mathcal{I}_{\text{gr}}^{\bar{\epsilon}}(D')$ as follows. The coloring of D induces a coloring of its resolutions D_ξ such that every circle is a boundary of a unique black region. Take the boundary circles of a black region and apply a half-twist to them; the component $s_\xi: D_\xi \rightarrow D'_\xi$ is a composition of such half-twists for all black regions in D_ξ . It is an isomorphism of cubes, since what it does is exactly to reverse the arrows connecting white regions. \square

In fact, the only condition for ι to be coherent with relations between changes of chronologies is that the quotient of its values on the two ◇-changes is equal to XY . Hence, we can set

$$(121) \quad \iota \left(\begin{array}{c} \text{↻} \\ \uparrow \\ \text{↻} \end{array} \right) = \alpha X \quad \iota \left(\begin{array}{c} \text{↻} \\ \uparrow \\ \text{↻} \end{array} \right) = \alpha Y$$

¹⁴ This step requires us to enumerate circles in each resolution, since the disjoint union in $\mathbb{k}\mathbf{ChCob}(0)$ is not strictly symmetric. The cube, however, is independent of these choices: different orders of circles are related by canonical isomorphisms, which in turn induce an isomorphism of cubes.

where α is an additional generator. This new parameter is useless from the point of view of Frobenius algebras: it will give only an additional restriction, that $\alpha X - 1$ and $\alpha Y - 1$ annihilate $\mu \circ \Delta$. However, it may be used to produce odd versions of nested homology theories (the two cobordisms related by a \diamond -change are diffeomorphic, but not isotopic), see [SW10, BW10].

Rotating arrows and $\mathfrak{sl}(2)$ foams. In the original construction of odd Khovanov homology, the small arrow over a crossing frames not only the negative eigenspace $E^-(p)$ of a saddle point p , but also its positive eigenspace $E^+(p)$ and the latter is used to distinguish between the two output circles of a split. Because of the convention that every arrow rotates clockwise when going up, one framing arrow is enough.

If we allow an arrow to rotate in any direction, i.e. when we orient both $E^-(p)$ and $E^+(p)$ independently, we will create a richer category with two versions of each generating cobordism. It is not difficult to find out chronological relations: the coefficients assigned to changes do not depend on how the arrows rotate, except \times - and \diamond -changes, in which cases the coefficients are multiplied by Y , if the arrows rotate in different directions, see Tab. 4.

Remark 12.3. This is not the most general solution. For instance, one can assign different coefficients to changes permutating merges that are differently oriented. In the most general case one obtains a system of nine independent parameters.

A choice of how a single arrow rotates introduces another datum to the construction of the generalized Khovanov complex. The isomorphism class of the complex does not depend on this additional chain, which follows from the commutativity of the following square:

(122)

where the left vertical cobordism is an isomorphism in $\mathbb{k}\mathbf{ChCob}(0)$ and its inverse is given by the same picture, but with different orientations of critical points:

(123)

and similarly for the other composition. The vertical morphisms are homogeneous in degree 0, which implies they commute with all other edge morphisms in the cubes. Hence, (122) induces an isomorphism between complexes obtained from two diagrams of a tangle, that differ only in the way a single arrow rotates.

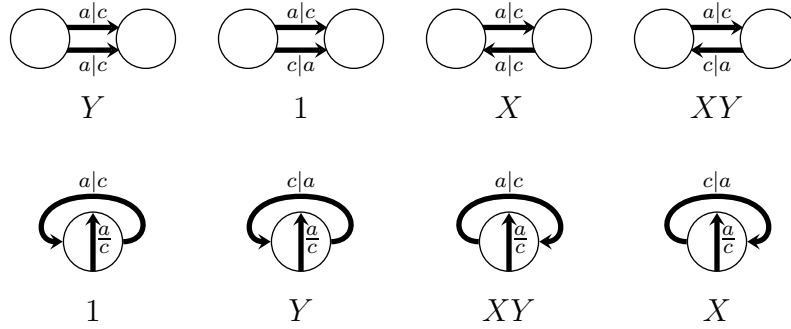

TABLE 4. Coefficients assigned to \times - and \diamond -permutation, when each arrow can rotate either clockwise or anticlockwise. The symbols $a|c$ and $\frac{a}{c}$ stand for two alternative ways of rotating an arrow and one has to make the same choice (left/top or right/bottom) for both arrows.

The author was encouraged to investigate rotations of arrows by M. Hempel, who computed several circular movies for the odd theory and noticed, that if arrows over crossings with opposite signs rotate differently, movies consisting of Reidemeister II moves induce identity chain maps. This suggests a connection with $\mathfrak{sl}(2)$ foams, i.e. singular cobordisms with two types of saddle points, one for positive and one for negative crossings.

APPENDIX A. FRAMED FUNCTIONS

Let W be a smooth compact manifold, possibly with boundary.

Definition A.1. An *Igusa function* is a smooth function $f: W \rightarrow \mathbb{R}$, such that at every point $p \in W$ one of the following conditions holds:

- IF1: p is *regular*, i.e. the derivative df_p does not vanish, or
- IF2: f has a *Morse singularity* (or A_1 singularity) at p , i.e. $df_p = 0$ but the Hessian $Hess_p(f)$ is nondegenerate, or
- IF3: f has a *birth-death singularity* (or A_2 singularity) at p , i.e. $df_p = 0$ and $Hess_p(f)$ has a 1-dimensional kernel $N(p) \subset T_p W$, but $d^3 f_p$ is nonzero on $N(p)$.

Morse and birth-death singularities of a function f have the following local models:

$$(124) \quad f(x_1, \dots, x_n) = f(p) - x_1^2 - \dots - x_k^2 + x_{k+1}^2 + \dots + x_n^2,$$

$$(125) \quad f(x_1, \dots, x_n) = f(p) - x_1^2 - \dots - x_k^2 + x_{k+1}^2 + \dots + x_{n-1}^2 + x_n^3.$$

In the latter case the nullspace $N(p)$ of $Hess_p(f)$ is spanned by $\frac{\partial}{\partial x_n}$. The number $k = \mu(p)$ is called the *index* of p .

Igusa functions arise naturally if one considers homotopies between smooth functions: a generic function on W is Morse (conditions IF1 and IF2) and *separative* (critical points lie on different levels), but a space of such functions is not even connected. However, a transversality argument implies a generic homotopy f_t is separative Morse except finitely many moments $0 < t_1 < \dots < t_k < 1$, at which either two critical points are permuted or a birth-death singularity occurs [Ce68]; we refer to them as *events*. We can visualize them by drawing the singular locus $S(f) := \{(t, f_t(x)) \mid x \in \text{crit}(f_t)\}$, see Fig. 11.

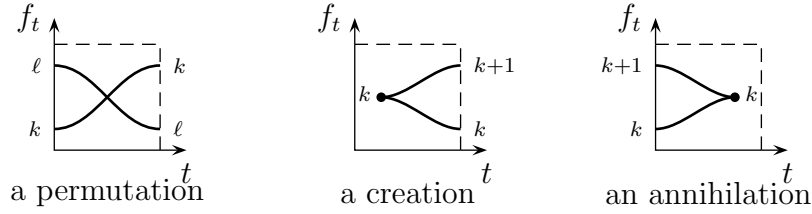

FIGURE 11. Singular loci for elementary homotopies of Igusa functions. Cusps represent A_2 -singularities, and labels are the indices of critical points.

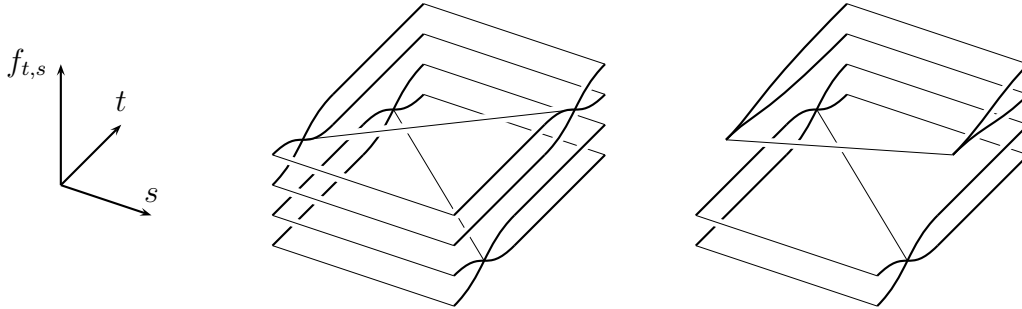
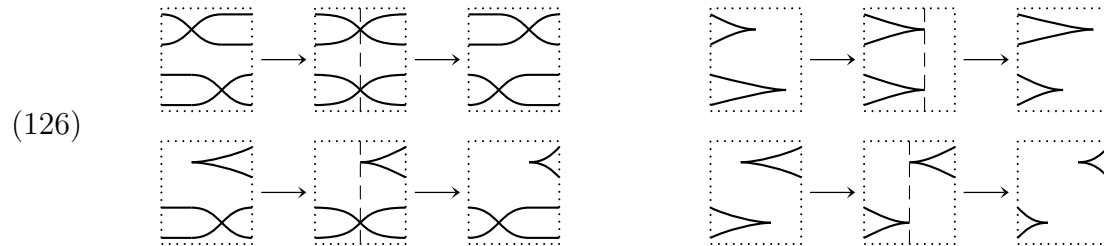

FIGURE 12. Examples of singular loci, when two events occurs at the same times.

Choose a generic two-parameter family $f_{t,s}: W \rightarrow \mathbb{R}$ of Igusa functions, $t, s \in I$. The path $t \mapsto f_{t,s}$ is a generic homotopy of Igusa functions for all except finitely many $s \in I$, at which one of the situations described below occurs, see [Ig84, EM11].

Case I Two events can occur at the same time t_i . For example, we have homotopies



where dashed lines indicate singular values of t . See also Fig. 12 for singular loci of the left two homotopies.

Case II A non-transverse event occurs, i.e. the singular set is not transverse to some level set $\{t = a\}$. Up to direction of the change, there are three such homotopies

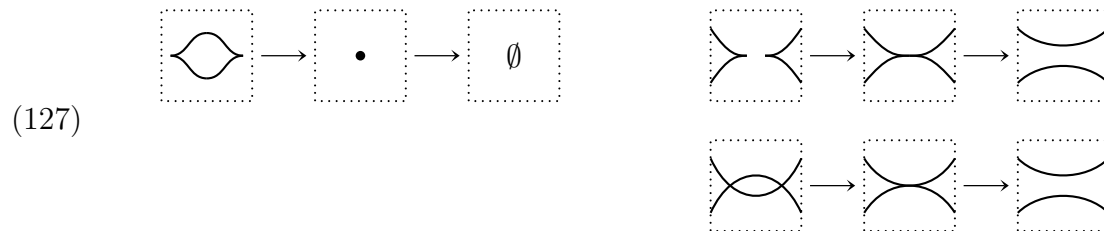

and their singular loci are shown in Fig. 13.

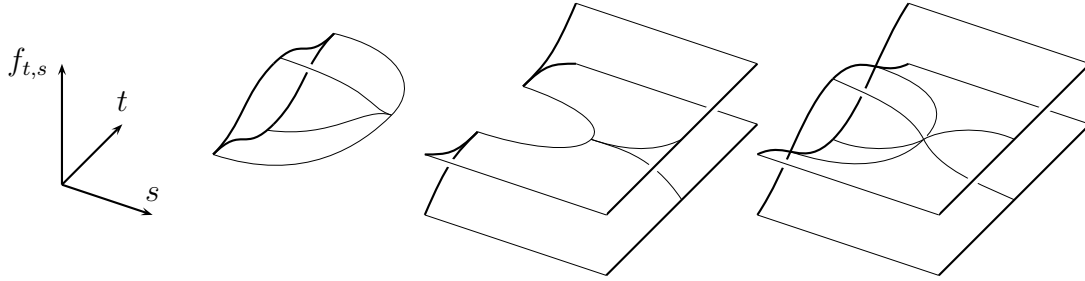

FIGURE 13. Singular loci of non-transverse events.

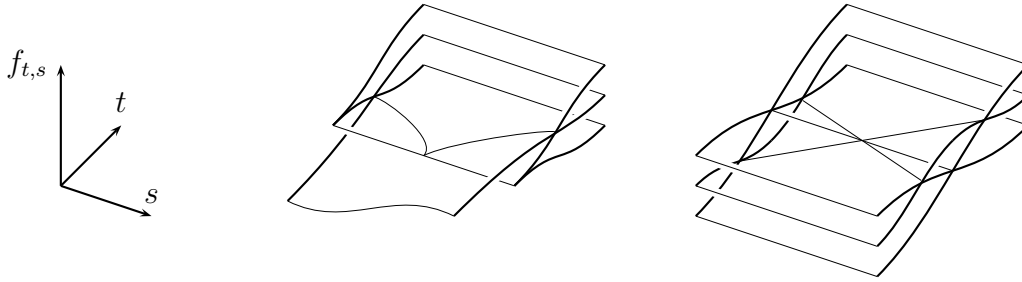
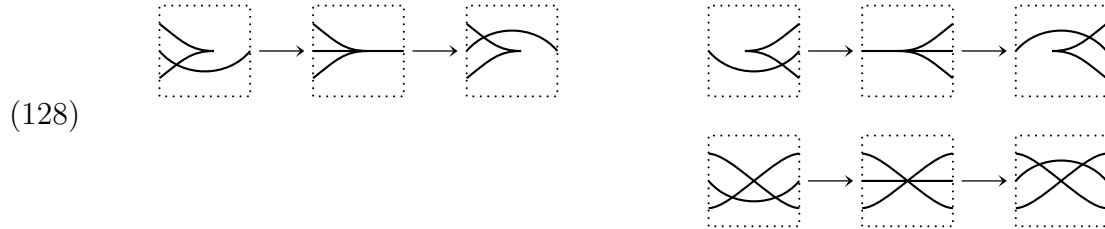

FIGURE 14. Singular loci of exceptional events from the third group.

Case III Either three Morse singularities or an A_2 -singularity and a Morse one meet at the same critical level. There are three types of such homotopies



with singular loci of two of them visualized in Fig. 14 (the case of an annihilation is symmetric to the one of a creation).

The space of Igusa functions is not simply connected, which is manifested by the lack of the dove tail singularity in the list above. Indeed, this singularity is modeled by a biquadratic polynomial and as such it cannot appear. We introduce framing to obtain a simply connected space.¹⁵ In fact, the space of framed functions is contractible [Ig87, Lu09, EM11], but we will not use this result in this paper. The following definition comes from [EM11].

Choose a Riemannian metric on W and a critical point $p \in W$ of an Igusa function $f: W \rightarrow \mathbb{R}$. We shall write $E^-(p)$ and $E^+(p)$ for the negative and positive eigenspaces of the Hessian of f at the point p , regarded as a linear map $Hess_p(f): T_pW \rightarrow T_pW$.

Definition A.2. Let $f: W \rightarrow \mathbb{R}$ be an Igusa function. A *framing* on f is a choice of a Riemannian metric on W and an orthonormal frame $v_1, \dots, v_{\mu(p)}$ of $E^-(p)$ at every critical

¹⁵ Framed functions were introduced to overcome the problem of lost information, when replacing a manifold with a Morse function: although a Morse function decomposes W into cells, one cannot build W back, unless a parametrization of each cell is given. This is the additional information a framing provides [Ig87].

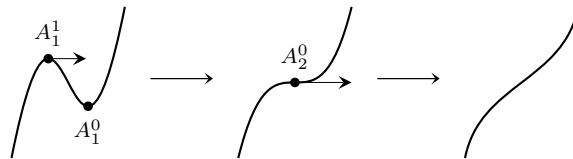
 FIGURE 15. A cancelation of framed A_1 points.

point p . If p is an A_2 -singularity, we add an extra vector $v_{\mu(p)+1} \in N(p)$ in the positive direction of $d^3\tau$.

The topology on the space of framed functions $\text{Fun}^{\text{fr}}(W)$ was described indirectly in [Ig87] by constructing a simplicial complex homotopy equivalent to this space. Here we only remind how homotopies look like, following [EM11].

Choose a smooth function $f: W \times I^m \rightarrow \mathbb{R}$ such that each *slice* $f_{\underline{t}}: W \rightarrow \mathbb{R}$ for $\underline{t} \in I^m$ is an Igusa function. Denote by $V \subset W \times I^m$ the set of critical points of all slice functions $f_{\underline{t}}$ and let Σ be the subset of all A_2 points. Generically, V is an m -dimensional submanifold of $W \times I^m$, Σ has codimension 1 in V , and V is transverse to each slice $W \times \{\underline{t}\}$ at the set $V - \Sigma$, see [EM11]. Let $V - \Sigma = V^0 \cup \dots \cup V^n$ and $\Sigma = \Sigma^0 \cup \dots \cup \Sigma^{n-1}$ be decompositions of $V - \Sigma$ and Σ with respect to the index. Then

- Σ^k is the intersection of the closures of V^k and V^{k+1} , and
- for $z = (p, \underline{t}) \in V^k$ one has $T_p W = E^-(z) \oplus E^+(z)$, and
- for $z = (p, \underline{t}) \in \Sigma^k$ one has $T_p W = E^-(z) \oplus N(z) \oplus E^+(z)$,

where $E^{\pm}(z)$ stands for the positive or negative eigenspace of $\text{Hess}_p(f_{\underline{t}})$ and $N(z)$ is its nullspace. It follows that for $z_0 \in \Sigma^k$ and $z \in V^k$

$$(129) \quad \lim_{z \rightarrow z_0} E^+(z) = N(z_0) \oplus E^+(z_0) \quad \text{and} \quad \lim_{z \rightarrow z_0} E^-(z) = E^-(z_0),$$

whereas for $z_0 \in \Sigma^k$ and $z \in V^{k+1}$

$$(130) \quad \lim_{z \rightarrow z_0} E^-(z) = E^-(z_0) \oplus N(z_0) \quad \text{and} \quad \lim_{z \rightarrow z_0} E^+(z) = E^+(z_0).$$

A framing on $f: W \times I^m \rightarrow I$ forms a collection of sections (v_1, \dots, v_n) , where each v_k is defined only over the union $\Sigma^{k-1} \cup V^k \cup \dots \cup \Sigma^{n-1} \cup V^n$, such that $v_k(z) \in N(z)$ for $z \in \Sigma^{k-1}$ and at $z \in V^k \cup \Sigma^k$ the vectors $v_1(z), \dots, v_k(z)$ form an orthonormal frame of $E^-(z)$. In particular, when we approach a birth-death singularity, framings of canceling points agree with the framing of the limiting point, see Fig. 15. For more details see [EM11].

Theorem A.3 (cf. [EM11, Lu09]). *The space of framed Igusa functions $\text{Fun}^{\text{fr}}(W)$ is contractible for any compact manifold W .*

There is a natural action of $SO(k)$ on the set of all framings of a critical point of index k . The quotient by this action, one per each critical point, results in a much smaller space of functions, which is still simply connected.

Definition A.4. An *orientation* of an Igusa function is a choice of an orientation of the negative eigenspace $E^-(p)$ at every critical point p . The space of oriented Igusa functions on W will be denoted by $\text{Fun}^{\text{or}}(W)$.

Theorem A.5. *$\text{Fun}^{\text{or}}(W)$ is simply connected for any compact manifold W .*

Proof. Consider the canonical projection $\pi: \text{Fun}^{\text{fr}}(W) \longrightarrow \text{Fun}^{\text{or}}(W)$. It is easy to see that it has connected fibers (a product of $SO(k)$'s). Hence, if we can show it has a path-lifting property, then any loop γ can be lifted to a loop up to reparametrization (lift γ as a path and connect its endpoints in a fiber). Then a contracting homotopy upstairs descends to a contracting homotopy of γ .

Pick a path $\gamma: [0, 1] \longrightarrow \text{Fun}^{\text{or}}(W)$. The compactness of $[0, 1]$ implies the existence of a sequence $0 = t_0 < t_1 < \dots < t_k = 1$ such that $\gamma|_{[t_{i-1}, t_i]}$ looks like one of the homotopies listed in Fig. 11. Since π has connected fibers, it is enough to lift each of the three homotopies.

- If γ has only Morse singularities, for each critical point of $\gamma(0)$ choose any framing with a given orientation and transport it along the path.
- If γ has a birth singularity of index k at p , pick any framing at this point agreeing with its orientation. Then transport it along the path of points with index k and for the path of index $k + 1$ add to the framing the additional vector coming from the nullspace $N(p)$.
- For a death singularity do the same but with the time reversed.

Hence, every path in $\text{Fun}^{\text{or}}(W)$ lifts to $\text{Fun}^{\text{fr}}(W)$. \square

Remark A.6. The group $SO(k)$ is not simply connected, and there is a choice for a path connecting the endpoints of the lift. In particular, $\pi_2(\text{Fun}^{\text{or}}(W))$ may be nontrivial. This is not a problem for us, as we never go beyond $\pi_1(\text{Fun}^{\text{or}}(W))$ in this paper.

APPENDIX B. 2-CATEGORIES

B.1. Basic definitions. This section provides basic definitions from the theory of 2-categories [Be67, Gr74] and monoidal structures on them [BaNe95, KV94]. The shortest way to define a 2-category is to say that it is a category enriched over **Cat**. This means the following:

- for every two objects A and B there is a category of morphisms $\text{Mor}(A, B)$; morphism of this category are called *2-morphisms*¹⁶ and composition is denoted by \star ,
- the composition is given by functors $\circ_{A,B,C}: \text{Mor}(B, C) \times \text{Mor}(A, B) \longrightarrow \text{Mor}(A, C)$,
- the identity morphisms are picked by functors $\mathbb{1}_A: * \longrightarrow \text{Mor}(A, A)$, where the category $*$ consists of a single object $*$ and a single morphism id_* ,
- the unitarity and associativity axioms are replaced with three invertible 2-morphisms $\rho_f: f \circ \text{id}_A \Longrightarrow f$, $\lambda_f: \text{id}_B \circ f \Longrightarrow f$, and $\alpha_{f,g,h}: f \circ (g \circ h) \Longrightarrow (f \circ g) \circ h$ for any $f \in \text{Mor}(A, B)$, $g \in \text{Mor}(B, C)$, and $h \in \text{Mor}(C, D)$, fitting into the commutative diagrams

$$(131) \quad \begin{array}{ccc} f \circ (g \circ (h \circ k)) & \xrightarrow{\text{id} \circ \alpha} & f \circ ((g \circ h) \circ k) \\ \alpha \swarrow & & \searrow \alpha \\ (f \circ g) \circ (h \circ k) & & (f \circ (g \circ h)) \circ k \\ & \searrow \alpha & \swarrow \alpha \circ \text{id} \\ & ((f \circ g) \circ h) \circ k & \end{array}$$

¹⁶ We use the double arrow notation for 2-morphisms, i.e. $\alpha: f \Longrightarrow g$, to distinguish them from the regular ones.

$$(132) \quad \begin{array}{ccc} f \circ (\text{id} \circ g) & \xrightarrow{\alpha} & (f \circ \text{id}) \circ g \\ \text{id} \circ \lambda \swarrow & & \searrow \rho \circ \text{id} \\ & f \circ g & \end{array}$$

They are called the MacLane’s coherence conditions [ML98].

A 2-category is *strict*, if all α , ρ and λ are identities. Otherwise, it is *weak*.

Example B.1. Given two small categories \mathbf{C} and \mathbf{D} there is a category $[\mathbf{C} \rightarrow \mathbf{D}]$ of functors from \mathbf{C} to \mathbf{D} , where the role of morphisms is played by natural transformations. Therefore, we have a 2-category of all small categories. This 2-category is strict, because composition of functors is associative.

Example B.2. Consider a category \mathbf{Mod}_R of modules over a fixed commutative ring R . We can extend it to a 2-category with 2-morphisms given by elements of R as follows. Choose module homomorphisms $f, g: M \rightarrow N$ and $r \in R$. We write $r: f \Rightarrow g$ if $g(m) = f(rm)$ for any $m \in M$. Both compositions of 2-morphisms are given as multiplication in R . The 2-category defined this way is again strict.

If we represent objects by points on a plane and 1-morphisms by oriented edges, then 2-morphisms decorate regions. With this interpretation, a picture of a typical 2-morphisms looks as follows:

$$(133) \quad \begin{array}{ccc} & f & \\ & \curvearrowright & \\ A & \Downarrow \alpha & B \\ & \curvearrowleft & \\ & g & \end{array}$$

There are two ways of composing 2-morphisms: a *vertical* composition, induced by the internal composition in morphism categories $\text{Mor}(A, B)$

$$(134) \quad \begin{array}{ccc} & f & \\ & \curvearrowright & \\ A & \xrightarrow{\quad} & B \\ & \curvearrowleft & \\ & g & \end{array} \quad = \quad \begin{array}{ccc} & f & \\ & \curvearrowright & \\ A & \Downarrow \beta \star \alpha & B \\ & \curvearrowleft & \\ & g & \end{array}$$

and a *horizontal* composition, given by the composition functors $\circ_{A,B,C}$

$$(135) \quad \begin{array}{ccc} & f & \\ & \curvearrowright & \\ A & \Downarrow \alpha & B \\ & \curvearrowleft & \\ & g & \end{array} \quad \begin{array}{ccc} & f' & \\ & \curvearrowright & \\ B & \Downarrow \alpha & C \\ & \curvearrowleft & \\ & g' & \end{array} \quad = \quad \begin{array}{ccc} & f' \circ f & \\ & \curvearrowright & \\ A & \Downarrow \beta \circ \alpha & B \\ & \curvearrowleft & \\ & g' \circ g & \end{array}$$

Moreover, the two ways of composing 2-morphisms are compatible, which means that the diagram

$$(136) \quad \begin{array}{ccccc} & & & & \\ & \curvearrowright & & \curvearrowright & \\ A & \xrightarrow{\quad} & B & \xrightarrow{\quad} & C \\ & \curvearrowleft & & \curvearrowleft & \\ & & & & \end{array}$$

produces the same 2-morphism no matter whether we first compose the 2-morphisms vertically or horizontally. In other words,

$$(137) \quad (\beta' \star \alpha') \circ (\beta \star \alpha) = (\beta' \circ \beta) \star (\alpha' \circ \alpha).$$

This property, called the *interchange law*, together with the obvious associativity and unitality axioms, is another way how to define a 2-category [Be67].

Example B.3. Chronological cobordisms form a strict 2-category:

- objects are smooth (collared) oriented manifolds,
- morphisms are (collared) cobordisms with chronologies,
- 2-morphisms are homotopy classes of changes of chronologies.

The vertical composition of 2-morphisms is given by concatenation of homotopies, whereas the horizontal one by juxtaposition. A routine check shows both operations are compatible, i.e. the interchange law holds.

The higher structure of 2-categories affects a notion of a functor: we no longer assume that it preserves identities nor compositions of morphisms. Instead, both properties should hold up to some 2-morphisms, which are part of the data, subject to some coherence relations.¹⁷

Definition B.4. A functor $F: \mathbf{C} \rightarrow \mathbf{D}$ between 2-categories consists of a function of objects $F_0: \text{Ob}\mathbf{C} \rightarrow \text{Ob}\mathbf{D}$, a collection of functors $F_{A,B}: \text{Mor}(A, B) \rightarrow \text{Mor}(FA, FB)$, and 2-morphisms $\iota_A: \text{id}_{FA} \Rightarrow F(\text{id}_A)$ and $\varphi_{f,g}: F(f) \circ F(g) \Rightarrow F(f \circ g)$ satisfying certain coherence relations. A functor F is *strict*, if both 2-morphisms are equalities.

A famous result states that every 2-category can be strictified: every 2-category is equivalent to some strict 2-category. Hence, we do not have to care about weak 2-categories. On the other hand, this does not apply to functors: there are functors between strict 2-categories that cannot be replaced by strict ones. However, most functors used in this paper will be strict, with the only exception being the cubical functors [GPS95].

Definition B.5. A functor $F: \mathbf{C}_1 \times \dots \times \mathbf{C}_r \rightarrow \mathbf{D}$ between strict 2-categories¹⁸ is *cubical* if the following conditions hold:

- (1) $F(\text{id}_{A_1}, \dots, \text{id}_{A_r}) = \text{id}_{F(A_1, \dots, A_r)}$, and
- (2) $F(f_1 \circ g_1, \dots, f_r \circ g_r) = F(f_1, \dots, f_r) \circ F(g_1, \dots, g_r)$ if there is k such that $f_i = \text{id}$ and $g_j = \text{id}$ for all $i > k > j$.

In other words, ι is the identity 2-morphism and so is φ , unless we have to ‘permute’ nontrivial morphisms f_i and g_j with $i > j$.

In the case of a cubical functor, the coherence relations mentioned in Definition B.4 reduce to two commuting diagrams of 2-morphisms

$$(138) \quad \begin{array}{ccc} F(\underline{f}) \circ F(\underline{g}) & \xrightarrow{F(\underline{\alpha}) \circ F(\underline{\beta})} & F(\underline{f}') \circ F(\underline{g}') \\ \Downarrow \varphi & & \Downarrow \varphi \\ F(\underline{f} \circ \underline{g}) & \xrightarrow{F(\underline{\alpha} \circ \underline{\beta})} & F(\underline{f}' \circ \underline{g}') \end{array}$$

¹⁷ See [Be67] for details. The most general definition does not even assume invertibility of ι and φ , but we will never need such functors.

¹⁸ There is also a more general notion of a cubical functor between weak 2-categories.

$$(139) \quad \begin{array}{ccc} F(\underline{f}) \circ F(\underline{g}) \circ F(\underline{h}) & \xrightarrow{\varphi^{\text{id}}} & F(\underline{f} \circ \underline{g}) \circ F(\underline{h}) \\ \text{id} \circ \varphi \downarrow & & \downarrow \varphi \\ F(\underline{f}) \circ F(\underline{g} \circ \underline{h}) & \xrightarrow{\varphi} & F(\underline{f} \circ \underline{g} \circ \underline{h}) \end{array}$$

where we used a shortcut notation $\underline{f} = (f_1, \dots, f_r)$ for morphisms in a product of 2-categories, and similarly for 2-morphisms. The latter condition has the following interpretation when $r = 2$: whenever we have three pairs of morphisms, passing from a composition of values of F on them to the value of F on their composition requires two ‘transpositions’ of ‘inner’ arguments and it can be done in two different ways. The condition (139) says, it does not matter which way we choose.

Example B.6. The ‘right-then-left’ disjoint sum \uplus is a cubical functor, whereas the ‘left-then-right’ one \Downarrow is cocubical (i.e. φ in Definition B.5 is identity if for some k we have $f_i = \text{id}$ and $g_j = \text{id}$ for $i < k < j$).

B.2. Gray products. A Gray monoidal structure on a 2-category is an analogue of a strict monoidal one for ordinary categories: there is a more general definition of a (weak) monoidal 2-category, but each such category is equivalent (in a monoidal sense) to a Gray-monoidal one [GPS95]. Because of that it is sometimes called a *semi-strict* monoidal 2-category [BaNe95, La05].

Definition B.7. A *Gray monoidal structure* in a strict 2-category \mathbf{C} consists of an associative cubical functor $\otimes: \mathbf{C} \times \mathbf{C} \rightarrow \mathbf{C}$ and a unit object $I \in \mathbf{C}$ such that both $I \otimes (-)$ and $(-) \otimes I$ are identity 2-functors.

Example B.8. Consider a (non-additive) subcategory $\mathbf{Mod}_R^h \subset \mathbf{Mod}_R$ of all G -graded R -modules and only homogeneous morphisms. The graded tensor product, when restricted to this subcategory, is a cubical functor: the 2-morphism $\varphi: (f' \otimes g') \circ (f \otimes g) \Rightarrow (f' \circ f) \otimes (g' \circ g)$ is given as multiplication by $\lambda(\deg g', \deg f)$. This example shows that graded monoidal categories are very close to Gray categories.

It is much harder to describe braiding in a monoidal 2-category: writing down all coherence conditions takes usually a few pages [BaNe95, KV94]. Since we will never use this notion in such generality, we provide here a very simplified version with all 2-morphisms being identities. That is why we call it a *strict braiding*.

Definition B.9. A *strict braiding* in a Gray monoidal category (\mathbf{C}, \otimes, I) is a collection of isomorphisms $\sigma_{A,B}: A \otimes B \rightarrow B \otimes A$ such that each $\sigma_{A,-}$ and $\sigma_{-,B}$ is a natural transformation and the triangle below commutes

$$(140) \quad \begin{array}{ccc} A \otimes B \otimes C & \xrightarrow{\text{id} \otimes \sigma_{B,C}} & A \otimes C \otimes B \\ \sigma_{A \otimes B, C} \searrow & & \swarrow \sigma_{A, C \otimes B} \\ & C \otimes A \otimes B & \end{array}$$

for any object C . If in addition $\sigma_{A,B} \circ \sigma_{B,A} = \text{id}$, we call σ a *strict symmetry*.

A natural transformation $\eta: F \rightarrow G$ in a 2-categorical setting must be coherent with 2-morphisms. This means the following compositions of 2-morphisms are equal

$$(141) \quad \begin{array}{ccc} \begin{array}{ccc} F(A) & \xrightarrow{F(f)} & F(B) \\ \eta_X \downarrow & \Downarrow_{F(\alpha)} & \downarrow \eta_Y \\ G(A) & \xrightarrow{G(f')} & G(B) \end{array} & = & \begin{array}{ccc} F(A) & \xrightarrow{F(f)} & F(B) \\ \eta_X \downarrow & \swarrow_{\text{id}} & \downarrow \eta_Y \\ G(A) & \xrightarrow{G(f)} & G(B) \end{array} \end{array}$$

for any 2-morphism $\alpha: f \Rightarrow f'$.

Example B.10. The category \mathbf{Mod}_R^h from Example B.8 is strictly braided, with the braiding isomorphism $\sigma_{A,B}(a \otimes b) := \lambda(\deg a, \deg b)b \otimes a$.

Example B.11. The 2-category \mathbf{ChCob} of chronological cobordisms is a strictly symmetric Gray monoidal category, with a product given by the ‘right-then-left’ disjoint sum \uplus , the empty manifold \emptyset as a unit object, and a permutation cylinder as a symmetry. On the other hand, the 2-category $\mathbf{ChCob}^e(0)$ of cobordisms embedded in $\mathbb{D}^2 \times I$ is only strictly braided.

REFERENCES

- [BaNe95] J.C. Baez, M. Neuchl, *Higher dimensional algebra I: braided monoidal 2-categories*, Advances in Mathematics 121:196–244, 1996. E-print: [arXiv:q-alg/9511013](https://arxiv.org/abs/q-alg/9511013).
- [BN05] D. Bar-Natan, *Khovanov homology for tangles and cobordisms*, Geom. Topol. 9:1443–1499, 2005. E-print: [arXiv:math/0410495](https://arxiv.org/abs/math/0410495).
- [BN07] D. Bar-Natan, *Fast Khovanov homology computations*, J. Knot Theory Ramifications 16:243–256, 2007. E-print: [arXiv:math/0606318](https://arxiv.org/abs/math/0606318).
- [BW10] A. Beliakova, E. Wagner, *On link homology theories from extended cobordisms*, Quantum topology 4(1):379–398, 2009. E-print: [arXiv:0910.5050](https://arxiv.org/abs/0910.5050).
- [Be67] J. Bénabou, *Introduction to bicategories*, Lecture Notes in Mathematics Vol. 47. Springer-Verlag, Berlin-New York, 1967.
- [Bla10] C. Blanchet, *An oriented model for Khovanov homology*, J. Khot Theory Ramifications 19:291–312, 2010.
- [Blo10] J. M. Bloom, *Odd Khovanov homology is mutation invariant*, Math. Res. Lett. 17(1):1–10, 2010. E-print: [arXiv:0903.3746](https://arxiv.org/abs/0903.3746).
- [Ca09] C. Caprau, *The universal $sl(2)$ cohomology via webs and foams*, Topology and its Applications 156:1684–1702, 2009. E-print: [arXiv:0802.2848](https://arxiv.org/abs/0802.2848).
- [CS98] J.S. Carter, M. Saito, *Knotted surfaces and their diagrams*, Mathematical Surveys and Monographs 55, American Mathematical Society, Providence, RI, 1998.
- [Ce68] J. Cerf, *Sur les difféomorphismes de la sphère de dimension trois ($\Gamma_4 = 0$)*, Lecture Notes in Mathematics, No. 53. Springer-Verlag, Berlin-New York, 1968.
- [Ce70] J. Cerf, *La stratification naturelle des espaces de fonctions différentiables réelles et le théorème de la pseudo-isotopie*, Inst. Hautes Études Sci. Publ. Math, 39:5–173, 1970.
- [CHW13] S. Clark, D. Hill, W. Wang, *Quantum supergroups I. foundations*, accepted in Transformation Groups. preprint: [arXiv:1301.1665](https://arxiv.org/abs/1301.1665)
- [CMW09] Clark, S. Morisson, K. Walker, *Fixing the functoriality of Khovanov homology*, Geom. Topol. 13(3):1499–1582, 2009. E-print: [arXiv:07071.5339](https://arxiv.org/abs/07071.5339).

- [EM11] Y.M. Eliashberg, N.M. Mishachev, *The space of framed functions is contractible*, Essays in Mathematics and its Applications, Springer-Verlag, Berlin-Heidelberg, 2012, pp. 81–109. E-print: [arXiv:1108.1000](https://arxiv.org/abs/1108.1000).
- [EKL12] A.P. Ellis, M. Khovanov, A. Lauda, *The odd nilHecke algebra and its diagrammatics*, Int Math Res Notices, Advance Access 2012. E-print: [arXiv:1111.1320](https://arxiv.org/abs/1111.1320).
- [EL13] A.P. Ellis, A. Lauda, *An odd categorification of quantum $sl(2)$* , 2013. Preprint: [arXiv:1307.7816](https://arxiv.org/abs/1307.7816).
- [GPS95] R. Gordon, A.J. Power, R. Street, *Coherence for tricategories*, Memoirs of the American Mathematical Society, 117 (558), 1995.
- [Gr74] J.W. Gray, *Formal category theory - adjointness for 2-categories*, Lecture Notes in Mathematics, Vol. 391. Springer-Verlag, Berlin-New York, 1974.
- [Ha87] A. Hatcher, *A proof of the Smale conjecture, $Diff(\mathbb{S}^3) \simeq O(4)$* , Annals of Mathematics, 117:553–607, 1983.
- [HN12] M. Hedden, Y. Ni, *Khovanov module and the detection of unlinks*, 2012. E-print: [arXiv:1204.0960](https://arxiv.org/abs/1204.0960).
- [HW12] D. Hill, W. Wang, *Categorification of quantum Kac-Moody superalgebras*, to appear in Trans. AMS. E-print: [arXiv:1202.2769](https://arxiv.org/abs/1202.2769).
- [Hi97] M.W. Hirsh, *Differential topology*, Graduate Texts in Mathematics, No. 33, Springer, 1997.
- [Ig84] K. Igusa, *Higher singularities of smooth functions are unnecessary*, Annals of Math. 119(1):1–58, 1984.
- [Ig84] K. Igusa, *On the homotopy type of the space of generalized Morse functions*, Topology 23(2):245–256, 1984.
- [Ig87] K. Igusa, *The space of framed functions*, Trans. of the Ameican Math. Soc. 301(2):431–477, 1987.
- [Ja04] M. Jacobsson, *An invariant of link cobordisms from Khovanov homology*, Alg. Geom. Top. 4:1211–1251, 2004. E-print: [arXiv:math/0206303](https://arxiv.org/abs/math/0206303).
- [Jo99] V.F.R. Jones, *Planar algebras I*, 1999. Preprint: [arXiv:math/9909027](https://arxiv.org/abs/math/9909027).
- [KKT11] S.-J. Kang, M. Kashiwara, S. Tsuchioka, *Quiver Hecke superalgebras*, 2011. Preprint: [arXiv:1107.1039](https://arxiv.org/abs/1107.1039).
- [KV94] M. Kapranov, V. Voevodsky, *Braided monoidal 2-categories and Manin-Schechtman higher braid groups*, Journal of Pure and Applied Algebra 92:241–267, 1994.
- [Kh99] M. Khovanov, *A categorification of the Jones polynomial*, Duke Math. J. 101(3):359–426, 2000. E-print: [arXiv:math/9908171](https://arxiv.org/abs/math/9908171).
- [Kh02] M. Khovanov, *An invariant of tangle cobordisms*, Trans. Amer. Math. Soc. 358:315–327, 2006. E-print: [arXiv:math/0207264](https://arxiv.org/abs/math/0207264).
- [Kh04] M. Khovanov, *Link homology and Frobenius extensions*, Fundamenta Mathematicae, 190:176–190, 2006. E-print: [arXiv:math/0411447](https://arxiv.org/abs/math/0411447).
- [KM12] P.B. Kronheimer, T.S. Mrowka, *Khovanov homology is an unknot-detector*, Publications mathématiques de l’IHÉS, 113(1):97–208, 2011. E-print: [arXiv:math/1005.4346](https://arxiv.org/abs/math/1005.4346).
- [La05] A. Lauda, *Frobenius algebras and planar open string topological field theories*, 2005. Preprint: [arXiv:math/0508349](https://arxiv.org/abs/math/0508349).
- [Le05] E.S. Lee, *An endomorphism of the Khovanov invariants*, Adv. Math. 197(2):554–586, 2005. E-print: [arXiv:math/0210213](https://arxiv.org/abs/math/0210213).
- [Lu09] J. Lurie, *On the classification of topological field theories*, AIM 2009-24. E-print: [arXiv:0905.0465](https://arxiv.org/abs/0905.0465).
- [ML98] S. MacLane, *Categories for the working mathematician* (second ed.), Graduate Texts in Mathematics, Vol. 5, Springer, 1998.
- [Na07] G. Naot, *The universal sl_2 link homology theory*, PhD Thesis, Toronto, 2007. E-print: [arXiv:0706.3680](https://arxiv.org/abs/0706.3680).
- [ORS13] P. Ozsvath, J. Rasmussen, Z. Szabo, *Odd Khovanov homology*, 2007 Alg. Geom. Top. 13:1465–1488, 2013. E-print: [arXiv:0710.4300](https://arxiv.org/abs/0710.4300).
- [Pu08] K.K. Putyra, *Cobordisms with chronologies and a generalized Khovanov complex*, Masters’ Thesis, Jagiellonian University, 2008. E-print: [arXiv:1004.0889](https://arxiv.org/abs/1004.0889).
- [Ra04] J. Rasmussen, *Khovanov homology and the slice genus*, Inventiones mathematicae, 182(2):419–447, 2010. E-print: [arXiv:math/0402131](https://arxiv.org/abs/math/0402131).
- [Sh11] A. Shumakovitch, *Patterns in odd Khovanov homology*, J. Knot Theory Ramifications, 20:203–222, 2011. E-print: [arXiv:1101.5607](https://arxiv.org/abs/1101.5607).

- [SW10] C. Stroppel, B. Webster, *2-block Springer fibers: convolution algebras and coherent sheaves*, Commentarii Mathematici Helvetici 2010. E-print: [arXiv:0802.1943](#).
- [We10] B. Webster, *Knot invariants and higher representation theory*, 2010. Preprint: [arXiv:1309.3796](#).
- [Wh10] S. M. Wehrli, *Mutation invariance of Khovanov homology over \mathbb{F}_2* , Quantum Topology, 1(2):111–128, 2010. E-print: [arXiv:0904.3401](#).

DEPARTMENT OF MATHEMATICS, COLUMBIA UNIVERSITY, NEW YORK, NY 10027
E-mail address: putyra@math.columbia.edu